

Revised NI 43-101 Technical Report Preliminary Economic Assessment Record Ridge Project British Columbia, Canada

Report Date: June 3, 2013
Effective Date: April 18, 2013

Report Prepared for

West High Yield [W.H.Y.] Resources Ltd.

P. O. Box 68121
Calgary, Alberta T3G 3N8
Canada

Report Prepared by



SRK Consulting (U.S.), Inc.
7175 West Jefferson Avenue, Suite 3000
Lakewood, CO 80235

SRK Project Number: 183200.020

Signed by Qualified Persons:

Bart Stryhas, PhD, CPG
Bret Swanson, BEng Mining, MAusIMM, MMSAQP
Corby Anderson, PhD, CEng, FIChemE, FIMMM, MMSAQP
Arlene Laudrum, PGeo

Summary (Item 1)

SRK Consulting (U.S.), Inc. (SRK) has been commissioned by West High Yield [W.H.Y] Resources Ltd. (WHY) to prepare a Canadian National Instrument 43-101 (NI 43-101) compliant Preliminary Economic Assessment (PEA) for the Record Ridge Project (Record Ridge or the Project), Rossland Mining District, British Columbia (B.C.), Canada. The Project is a magnesium exploration project that was mapped, surveyed, and drilled by WHY during 2007, 2008 and 2011. This document provides a PEA of the Project, prepared according to NI-43-101 guidelines.

Initially, this preliminary economic assessment was prepared based on metallurgical results provided by Met-Solve Laboratories in their report dated October 31, 2012, which is attached to this document in Appendix B. This report indicated an open cycle laboratory leach testing metallurgical recovery to solution of magnesium from the Record Ridge mineralization of approximately 60%. The Met-Solve report also indicated that these initial leaching recovery rates to solution could likely be improved with additional metallurgical work. Subsequent test-work detailed in Section 11 of this report was conducted after the great majority of the engineering and design work had been conducted in 2012 based on the 60% recovery assumption. Met-Solve Laboratories completed this recommended work and reported on April 18, 2013 with an estimated improvement of the open cycle laboratory leach testing Mg recovery to 80% to solution. This report is attached to this document, in Appendix C. Of course, this is not a clear indication or confirmation of the overall Mg recovery to a final fused magnesia product as this aspect of the process has yet to be tested in any manner.

In this preliminary economic assessment, the body of the report has not been altered to reflect the recent improvement in the leached Mg recovery. These improvements and the associated additional operational and capital costs have been incorporated into the technical economic model. The case presented herein is conservative, in that the assumptions used in the initial resource statement and subsequent engineering use the initial 60% metallurgical recovery assumption. The mineral resources have not been restated using a cut-off grade which would be based on a metallurgical recovery of 80% Mg. The effect of the higher Mg recovery is expected to lower the cut-off grade for the stated mineral resources, thereby increasing tonnes and extending the life of the mine. Given that the mine life based on the current stated resource and production scenario is projected at 42 years, any potential changes due to the improved recovery are positive and do not affect the project viability with regards to the preliminary economic assessment.

Due to the significant amount of time needed to update the conceptual mine design, tailings storage design, etc., it was deemed that the only material change to be incorporated in this preliminary economic assessment with respect to the updated metallurgical test work would be the adjustment to some design criteria and the technical economic model, the details of which are summarized in Section 19.

Property Description and Ownership

Record Ridge is an intermediate-advanced stage magnesium exploration project located in southern B.C., Canada. It is located 7.5 km west to southwest of the town of Rossland, B.C., Canada; 5 km north of the U.S.-Canada border; and approximately 400 km east of the Vancouver, B.C. The mineralization is centered about 49°02'33" N. latitude and 117°53'22" W longitude (UTM NAD 83 coordinates 5,432,500 N and 434,500 E). The property is located in the Canadian National

Topographical System Mapsheet 082F. Mineralization is related to the elevated magnesium content in serpentinized mafic rocks. WHY retains 100% of the mineral rights to the property, has agreements with the B.C. government for exploration access, and is in the process of evaluating options for procurement of surface rights for continued development.

Ownership

The WHY claim block consists of 20 contiguous mineral claims covering 6,515.12 hectares (ha), all under the 100% ownership of WHY (#145867). The known magnesium mineralization of the Project is located within two of the mineral claims. WHY does not currently have surface rights with the exception of access and disturbance agreements with the B.C. government related to magnesium exploration activities. Also considered are the nearby WHY land holdings consisting of eight Crown-granted claims and one private claim with surface and mineral rights (9 titles) totaling 85.93 ha.

Geology and Mineralization

The Record Ridge area is located within the Quesnel Terrain of the Intermontane Belt. It is comprised of a highly deformed Jurassic (180 Ma) age volcanic island arc-back arc basin complex intruded by Tertiary volcanic and plutonic rocks. The exploration area is underlain primarily by the Record Ridge Ultramafic Body of Paleozoic age. This unit is bound on the north by the volcanics of the Tertiary Marron Formation, on the east and southeast by the volcanic rocks of the Jurassic Elise Formation and on the west and southwest by the Tertiary age Coryell intrusive suite. Regional metamorphism has reached greenschist facies in the Project area.

Mineralization containing economically significant concentrations of magnesium is known to occur in the ultramafic rocks which have undergone serpentinization. This rock type makes up the predominant lithology described at the Project, and occurs widespread. Lower concentrations of magnesium within the serpentinite are present in dioritic intrusive rocks and lenses of andesite/diagabbro.

Exploration Status

During the 2007, 2008 and 2011 field seasons, WHY conducted surface mapping, surface sampling and diamond drilling on the Project. The surface mapping was conducted at a 1:2,500 scale focused on the ultramafic rocks. Samples were collected from outcrop and analyzed by Inductively Coupled Plasma-Atomic Emission Spectrometry (ICP-AES) for 24 elements. A total of 30 samples were collected and analyzed. The results of this work delineated a high magnesium anomaly located in the east flank of the Record Ridge, presumed to lie above the serpentinite unit. The Project resource estimation is based on information from 77 diamond core drillholes totaling 10,310 m, with 5,836 assays. These were carefully logged, sampled and tested with 24-or 32-element ICP-AES analysis.

Development and Operations

Record Ridge will be mined using conventional open pit methods using a default 365 day production cycle comprising of one 12 hour shift delivering approximately 3,000 tonnes per day (t/d) of material to the crusher. Waste material below the specified cut-off will be hauled from the pit and placed in a designated waste dump location. With further optimization of the tailings dam facility, it is foreseeable that waste will be used as bulk earthworks for the downstream construction of the dam

wall. Material will be mined from the pit and transported to the processing facility near the mine and placed in a stockpile and subsequently fed into the crusher bin by front-end-loader.

The mine production schedule and fleet estimation suggest that a 42 year mine life is possible given the economic assumptions for processing, mine cost, recovery and metal price. There is almost no variation in grade across the deposit so detailed grade control and selective mining methods will not be needed to ensure a consistent mill feed grade for the process plant.

Table 1: Mine Operating Cost Summary

Description	Unit Cost (US\$/t-moved)	Total Cost (US\$000's)
Drilling	0.23	17,976
Blasting	0.38	30,743
Loading	0.19	15,517
Hauling	0.78	62,308
Roads & Dumps	0.15	12,257
Labor Inc. G&A	0.53	42,055
Total Operating Costs	\$2.26	\$180,856

Mineral Resource Estimate

Dr. Bart Stryhas is the Qualified Person (QP) responsible for the resource estimation methodology and the resource statement.

The drillhole database used in the estimation is of high quality and has been independently verified by SRK. The drillholes were capped and composited to 3 m lengths within geologic domains defined during the logging. A three-dimensional geologic model was constructed based on the logged geology in the drilling database. The grade estimation was confined to a hard boundary of the ultramafic (serpentine) lithic domain, with the estimation using only the composited samples from the same domain. The magnesium grade estimation utilized an Ordinary Kriging (OK) algorithm supported by the 3.0 m bench composites. Search distances were determined from omni-directional variograms calculated using the capped and composited samples. A nested search ellipse estimation method consisting of three passes was used.

The mineral resources are confined within a designed open pit based on reasonable assumptions of recoveries, costs, and commodity prices established by the ongoing work detailed in this report. The Mineral Resources for Record Ridge are summarized in Table 2.

Table 2: Record Ridge Mineral Resource Statement – April 18, 2013

Resource Category	% Mg Cut-off	Total Mt	% Mg Grade	Contained Mg (Mt)
Measured		28.4	24.82	7.05
Indicated	21.9	14.6	24.21	3.54
M&I		43.0	24.61	10.59
Inferred		1.07	24.37	0.26

- Mineral Resources are not Mineral Reserves and do not have demonstrated economic viability. There is no certainty that all or any part of the Mineral Resources estimated will be converted into Mineral Reserves;
- Open pit resources stated as contained within a potentially economically minable pit shell, and a calculated internal Whittle™ cut-off grade (CoG) of 21.9% Mg was used based on the following parameters: US\$2.00/t mining cost, US\$244.75/t processing cost, 60% recovery, G&A cost of US\$1.00/t, no NSR and a US\$1,100/t value for Fused MgO at 98% lump;
- Note that the above cut-off grade is based on the early assumption of a 60% metallurgical recovery, and has not been updated to reflect the most recent metallurgical test work which suggests an 80% recovery. It can be expected that using this updated recovery would lower the cut-off grade for the Whittle™ internal cut-off, likely resulting in more tonnes and a longer life of mine (LoM); and
- Mineral resource tonnage and contained metal have been rounded to reflect the accuracy of the estimate, and numbers may not add due to rounding.

The mineral resources are reported in accordance with Canadian Securities Administrators (CSA) NI 43-101 and have been classified in accordance with standards as defined by the Canadian Institute of Mining, Metallurgy and Petroleum (CIM) Definition Standards – For Mineral Resources and Mineral Reserves.

Mineral Reserve Estimate

A prefeasibility study is required to demonstrate the economic merit of mineral resources in order for their conversion to reserve. At this time, no such study has been completed and therefore the Project currently has no reserves.

Economic Analysis

The financial results of this report are based upon work performed by SRK and have been prepared on an annual basis. All costs are constant U.S. dollars.

A financial model was prepared on an after-tax basis, the results of which are presented in this section. Financial assumptions used are summarized in Table 3.

Table 3: Model Parameters

Description	Value
Mine Life	42 years
Mill Feed Processed	44 Mt
Tonnes Mined	79.9 Mt
Payable Tonnes EFM	10.8 Mt
EFM Market Price (LoM Avg.)	US\$1,100/t Conc.
Payable Tonnes Sodium Sulfate	66.1 Mt
Sodium Sulfate Market Price (LoM Avg.)	US\$75/t Conc.

The economic analysis results, shown in Table 4, indicate a pre-tax net present value (NPV) 5% of US\$1,339 million and initial rate of return (IRR) of 21%, and a post-tax NPV 5% of US\$830 million and IRR of 17%. Capital identified in the economics is for project installation, sustaining operations, and plant and equipment rebuilds as required. The following provides the basis of the SRK Life of Mine (LoM) plan and economics:

- A mine life of 42 years;
- An overall average process recovery rate of 80% Mg over the remaining LoM;
- Sodium Sulfate market price of US\$75/t Free on Board (FOB) Record Ridge;
- A credit of US\$345/t-Electro Fused Magnesia (EFM) from the Sodium Sulfate co-product sale;
- A project cash cost of US\$668/t-EFM;
- EFM market price of US\$1,100/t FOB;
- Sodium Sulfate market price of US\$75/t FOB; and
- Initial capital costs of US\$608 million.

Table 4: Mine & Plant Economic Results

Description	Pre-Tax Results	Post-Tax Results	Units
Market Prices			
MgO EFM Market Price	\$1,100	\$1,100	US\$/t-EFM
Sodium Sulfate Market Price	\$75	\$75	US\$/t-SS
Estimate of Cash Flow			
Gross Income			
MgO EFM Sale	\$15,825,809	\$15,825,809	US\$000s
Sodium Sulfate Sale	\$4,957,906	\$4,957,906	US\$000s
Gross Income	\$20,783,715	\$20,783,715	US\$000s
MgO EFM Freight & Marketing	(\$402,839)	(\$402,839)	US\$000s
Sodium Sulfate Freight & Marketing	(\$1,850,951)	(\$1,850,951)	US\$000s
Gross Revenue	\$18,529,924	\$18,529,924	US\$000s
Royalty	\$0	\$0	US\$000s
Net Revenue	\$18,529,924	\$18,529,924	US\$000s
Operating Costs			
Mining	\$180,856	\$180,856	US\$000s
Sulfuric Acid	\$2,203,514	\$2,203,514	US\$000s
Soda Ash	\$6,169,838	\$6,169,838	US\$000s
Other Processing Costs	\$3,024,983	\$3,024,983	US\$000s
Sodium Sulfate Bagging & Storage	\$661,054	\$661,054	US\$000s
Tailings & Water Management	\$10,344	\$10,344	US\$000s
G&A	\$66,546	\$66,546	US\$000s
Total Operating	\$12,317,135	\$12,317,135	US\$000s
\$/t-mill feed	\$279.49	\$279.49	\$/t-RoM
Operating Costs			
Mining	\$12.57	\$12.57	\$/t-MgO EFM
Sulfuric Acid	\$153.16	\$153.16	\$/t-MgO EFM
Soda Ash	\$428.85	\$428.85	\$/t-MgO EFM
Other Processing Costs	\$210.26	\$210.26	\$/t-MgO EFM
Sodium Sulfate Bagging & Storage	\$45.95	\$45.95	\$/t-MgO EFM
Tailings & Water Management	\$0.72	\$0.72	\$/t-MgO EFM
G&A	\$4.63	\$4.63	\$/t-MgO EFM
Operating Cost	\$856.12	\$856.12	\$/t-MgO EFM
Freight & Marketing	\$156.65	\$156.65	\$/t-MgO EFM
Sodium Sulfate Credit	(\$344.61)	(\$344.61)	\$/t-MgO EFM
MgO Cash Cost	\$668.17	\$668.17	\$/t-MgO EFM
Operating Margin (EBITDA)	\$6,212,790	\$6,212,790	US\$000s
Capital	\$983,667	\$983,667	US\$000s
Federal + Provincial Income Tax	\$0	\$1,146,131	US\$000s
Provincial Mining Tax	\$0	\$694,820	US\$000s
Cash Flow Available for Debt Service	\$5,229,123	\$4,082,992	US\$000s
NPV 5%	\$1,338,764	\$830,083	US\$000s

The PEA is preliminary in nature, in that it includes inferred mineral resources that are considered too speculative geologically to have the economic considerations applied to them that would enable them to be categorized as mineral reserves, and there is no certainty that the PEA will be realized.

Taxes and other interests have been calculated for the Project, including:

- No royalties;
- Federal/Provincial Tax applied at a 27% rate;
- Provincial Mining Tax at 2% of Net Current Proceeds and 13% of Net Revenue (after recovery of investment); and
- Canadian Capital Cost Allowance.

Sensitivity analysis for key economic parameters is shown in Table 5. The Project is nominally most sensitive to market prices (revenues) followed by operating costs. The Project is the least sensitive to capital.

Table 5: Sensitivity Analysis of Pre-Tax NPV 5% (US\$ million)

NPV (US\$ million)	80%	90%	Base	110%	120%
Revenue	49	694	1,339	1,983	2,628
Operating Costs	2,108	1,724	1,339	954	569
Capital Costs	1,451	1,395	1,339	1,283	1,227

Conclusions and Recommendations

The following activities are recommended if WHY determines that a Feasibility Study is warranted:

- Obtain improved topographic survey accurate to within +/- 1 m, appropriate for detailed engineering design;
- Condemnation drillholes in areas for proposed waste, tailings, and plant facilities;
- Extensive metallurgical testwork designed to confirm, optimize and improve metallurgical recoveries, confirm reagent use and MgO calcination and fusion processing assumptions;
- Detailed mass and energy balances performed and optimized to verify the unconfirmed locked cycle assumptions;
- Research into the pricing and availability of reagents needed in the metallurgical process, with the objective of minimizing these costs where possible;
- Engineering optimization studies and investigations;
- Obtain tailings samples for consolidation testing to determine appropriate long-term density and other geotechnical properties required for engineering design;
- Conduct additional geochemical characterization of mill feed, tailings and waste rock to determine the potential environmental impacts and re-evaluate the need for a fully contained lined facility;
- Detailed marketing studies to determine ability of the fused magnesium oxide and the by-product sodium sulfate markets to absorb the projected production;
- Acquisition of surface rights to ensure ability to operate; and
- Studies and activities to support an Environmental Impact Statement and public consultation processes.

The total cost of these activities is estimated to be between about US\$10 million.

Significant Risks and Uncertainties

Surface Rights

The surface rights for the project area include a number of parcels that are designated as privately-held by the B.C. Government's Integrated Cadastral Fabric. WHY would need to secure lease agreements or ownership of these parcels in order to operate the project as it is currently designed. SRK sited facilities independent of the current surface ownership, and are subject to change based on WHY's ability to acquire the rights to this land for operational purposes.

Metallurgy and Processing

The proposed flowsheet and associated economics are based upon limited and un-optimized testing and several key assumptions will need to be actually confirmed with further investigation and optimized testing. This includes, but is not limited to, locked cycle leach and precipitation testing, effective industrial scale liquid solid separations, comprehensive heat and mass balances and the actual bulk availability and pricing of key reagents such as soda ash and sulfur.

- Key parameters such as crushing energy indices as well as all comminution abrasion indices need to be determined. As well, further work needs to be done to determine the optimal crush and grind size for effective leaching recovery.
- The Mg leaching recovery is estimated to be 80% overall assuming that with closed cycle plant operations coupled with effective heat input, the majority of the leached magnesium will eventually report as a final product and not be lost due to crystallization or ineffective liquid solid separations. This needs further optimization and verification at the laboratory and pilot scale in a closed operational system.
- It is assumed that waste and by product MgO containing materials will be available and may effectively be used for neutralization of excess acid and solubilized iron precipitation in conjunction with aeration of solutions after leaching in lieu of peroxide oxidation. Further test work needs to be done to confirm and optimize this.
- It is assumed with on-site sulfuric acid production and the subsequent excess exothermic energy production, the overall process is net positive in heat energy or at least balanced. This needs to be carefully analyzed, quantified, and confirmed.
- It is assumed that electrical energy is available at the rates disclosed herein for key energy consuming unit operations such as comminution and MgO fusion.
- It is assumed that a ready supply of bulk elemental sulfur and soda ash are available at the plant site. This needs to be further investigated.
- Further focused leach testing with optimization and closed cycle testing of representative samples needs to be done to confirm reagent consumptions and to achieve enhanced Mg recoveries to solution.
- No actual production of fused magnesia from WHY materials has been tested or confirmed. This needs to be carefully tested and confirmed with representative samples at a laboratory, pilot and industrial scale. In addition only very limited calcinations of magnesium carbonate have been done to produce an intermediate calcined magnesia product. This also needs to be carefully tested further confirmed with representative samples at a laboratory, pilot and industrial scale.

- It is assumed that a large volume of high quality by product sodium sulfate may be produced and sold. As no actual sodium sulfate product has been produced from WHY materials to date, this confirmatory testing needs to be carried out.
- An overall mass, heat and water balance needs to be carried out to hone in on actual recoveries, net energy use and the quantified need and nature of air, water and solid discharges.
- The flow sheet supporting the metallurgical processing is at an early stage of development and has never been tested in a commercial application. There are no comparable commercial operations that use Mg-silicates as a mill feed or use the flow sheet proposed in this report to create an EFM product.

Commodity and Reagent Price

There are three major commodity and reagent price assumptions that have been made in the PEA report. There are several different methods used to estimate commodity and reagent prices. The methods used by SRK, rely on trialing average prices or expert opinions on future prices. The prices cited here may not reflect actual future cost associated with delivery to the project.

Soda Ash

There are no negotiated terms for the purchase of soda ash or estimated transportation from Wyoming to the project site. What information could be found suggested US\$140 was a reasonable price given that the production of soda ash is available from Wyoming. For each tone of rock processed approximately one tonne of soda ash is required for processing and will make up approximately 50% of the total operating cost. Variation in soda ash price and additional transportation costs may be a benefit but also a significant risk to profitability if it were to increase.

EFM

Based on reports supplied by WHY, the quality of the end-product suggested by Met-Solve and historic information of EFM at a 98% quality, SRK has used a US\$1,100/t price. Because EFM is an industrial mineral there are no specific spot prices and contract terms govern the sale of the product in bulk quantities. The infusion of additional EFM from WHY on a massive scale onto the global market may negatively impact the price achieved. As the effective cash cost of the EFM is US\$668/t, any reduction below that price would require additional credit from sodium sulfate or reduction in soda ash prices to remain profitable. There is a possibility that the project could contribute enough EFM to influence the world supply and pricing structure.

Sodium Sulfate

Based on reports supplied by WHY and investigation to the use of sodium sulfate, SRK has used a price of US\$75/t. While the price information shows less volatility than EFM, the largest risk will likely be the surplus supply Record Ridge would make on the global market (estimated at 10%). When combined with other potential hydro metallurgical operations that may be commissioned, the market could easily be over supplied with low-priced sodium sulfate as the cost of disposing it is very high.

Due to the extended period of feasibility, permitting and construction envisioned for the project, the price projections will remain a significant risk until off-take and purchasing agreements can be formalized.

Sulfuric Acid

The cost of sulfuric acid is directly predicated on a low cost and available source of high quality sulfur. If sulfur costs rise or their availability is restricted, this will have a negative impact on the technical and economic viability of the project.

Infrastructure and Tailings

Risks associated with the infrastructure include:

- Capacity of local infrastructure to provide for truck transportation of the significant quantities of reagents and products that the Project will require/generate respectively. There may need to be additional infrastructure improvement and community involvement associated with the trucking of these quantities to and from Trail, BC.
- The actual power and water requirements of the project have been estimated at a scoping level of detail. These will need to be investigated to determine sufficient capacity or any additional costs that might be associated with the Project's requirements.

Permitting

The regulatory process to permit mine development in British Columbia requires active management by the proponent. The schedule and budget for this process varies. The accuracy and certainty of the Project Description and Environmental and Socio-Economic Impact Assessment directly affect the schedule. Stakeholder participation also affects the schedule and budget. Both the B.C.EAA and CEAA 2012 have regulated timelines that must be met by authorities reviewing applications. The regulated timelines do not include time required by the proponent to deal with the results of the consultation process and to amend the application to address concerns raised.

This project is currently at an early stage of environmental assessment and permitting.

Foreseeable Impacts of Risks

The foreseeable impacts of the aforementioned risks should not be understated. Certain risks such as the ability to permit the operation, availability of key reagents, and certain unknown parameters within the proposed process have the capacity to outright stall development of the project, reduce operating parameters, or drive costs to a point where the project becomes uneconomic.

If WHY were to achieve profitable operations, there is a risk that other companies in different parts of the world may use comparable Mg-Silicate deposits, construct a processing facility and produce magnesium products at a lower price that may adversely affect the profitability of the WHY operation.

At this time, SRK has no reason to assume that the risks disclosed above will not be able to be mitigated or eliminated through continued study. SRK has provided recommendations pursuant to addressing these risks, and suggests that a prefeasibility study be completed to gain further perspective.

Table of Contents

Summary (Item 1)	i
Property Description and Ownership	i
Ownership	ii
Geology and Mineralization.....	ii
Exploration Status	ii
Development and Operations	ii
Mineral Resource Estimate.....	iii
Mineral Reserve Estimate.....	iv
Economic Analysis	iv
Conclusions and Recommendations	vi
Significant Risks and Uncertainties.....	vii
1 Introduction (Item 2)	1
1.1 Terms of Reference and Purpose of the Report.....	1
1.2 Qualifications of Consultants (SRK).....	1
1.3 Details of Inspection.....	1
1.4 Reliance on Other Experts (Item 3)	2
1.4.1 Sources of Information and Extent of Reliance.....	3
1.5 Effective Date.....	3
1.6 Units of Measure	4
2 Property Description and Location (Item 4)	5
2.1 Property Description and Location.....	5
2.2 Mineral Titles.....	5
2.3 Royalties, Agreements and Encumbrances.....	6
2.4 Environmental Liabilities and Permitting.....	6
2.4.1 Required Permits and Status	7
2.5 Significant Factors and Risks to Perform Work	7
3 Accessibility, Climate, Local Resources, Infrastructure and Physiography (Item 5) 10	
3.1 Access to Property	10
3.2 Physiography	10
3.3 Climate and Length of Operating Season.....	10
3.4 Surface Rights.....	11
3.5 Local Resources and Infrastructure	11
3.6 Access Road and Transportation.....	12
3.7 Power Supply	12
3.8 Water Supply.....	12

3.9	Port.....	12
3.10	Buildings and Ancillary Facilities.....	12
3.11	Tailings Storage Facility Area.....	12
3.12	Waste Disposal Area.....	13
3.13	Manpower.....	13
4	History (Item 6).....	16
4.1	Prior Ownership and Ownership Changes.....	16
4.2	Previous Exploration and Development Results.....	16
4.3	Historic Mineral Resource and Reserve Estimates.....	16
4.4	Historic Production.....	16
5	Geological Setting and Mineralization (Item 7).....	17
5.1	Regional Geology.....	17
5.2	Local Geology.....	17
5.2.1	Stratigraphy.....	18
5.2.2	Alteration.....	18
5.2.3	Structure.....	19
5.3	Significant Mineralized Zones.....	20
6	Deposit Type (Item 8).....	24
6.1	Mineral Deposit.....	24
6.2	Geological Model Applied.....	24
7	Exploration (Item 9).....	27
7.1	Surveys and Investigations.....	27
7.2	Significant Results and Interpretation.....	27
8	Drilling (Item 10).....	28
8.1	Type and Extent.....	28
8.2	Procedures.....	28
8.3	Interpretation and Relevant Results.....	28
9	Sample Preparation, Analysis and Security (Item 11).....	31
9.1	On Site Sample Preparation and Security.....	31
9.2	Laboratory Sample Preparation and Analysis.....	32
9.2.1	2007 and 2008 Drilling.....	32
9.2.2	2011 Drilling.....	32
9.3	QA/QC Procedures.....	33
9.3.1	2007 and 2008 Drilling.....	33
9.3.2	2011 Drilling.....	34
9.4	QA/QC Failure Actions.....	35

9.5	Opinion on Adequacy.....	35
10	Data Verification (Item 12).....	44
10.1	Procedures.....	44
10.2	Limitations.....	44
10.3	Data Adequacy.....	44
11	Mineral Processing and Metallurgical Testing (Item 13).....	45
11.1	Procedures.....	45
11.2	Relevant Results.....	45
12	Mineral Resource Estimate (Item 14).....	53
12.1	Qualified Person of the Mineral Resource Estimate.....	53
12.2	Drillhole Database.....	53
12.3	Geology.....	53
12.4	Block Model.....	54
12.5	Capping & Compositing.....	55
12.6	Density.....	55
12.7	Variogram Analysis.....	55
12.8	Grade Estimation.....	56
12.9	Model Validation.....	57
12.10	Resource Classification.....	57
12.11	Mineral Resource Statement.....	58
12.11.1	Mineral Resource Sensitivity.....	58
12.11.2	Reserve Estimation.....	59
12.11.3	Material Effects on Mineral Resources.....	59
13	Mining Methods (Item 16).....	73
13.1	Geotechnical Parameters.....	73
13.2	Pit Optimization.....	74
13.2.1	Whittle™ Parameters.....	74
13.2.2	Whittle™ Results and Analysis.....	75
13.3	Mine Design.....	76
13.3.1	Pit Design Parameters.....	77
13.4	Mine Production Schedule.....	78
13.5	Open Pit Operations.....	78
14	Recovery Methods (Item 17).....	90
14.1	Major Design Criteria.....	90
14.2	Process Description.....	90
14.3	Key Process Assumptions, Potential Risks and Further Suggested Work.....	91
14.4	Operating and Capital Cost Estimates.....	92

15 Project Infrastructure (Item 18)	95
15.1.1 Access Road and Transportation.....	95
15.1.2 Power Supply	95
15.1.3 Water Supply.....	95
15.1.4 Sodium Sulfate – Bagging / Warehouse Facility.....	96
15.1.5 Tailings Storage Facility	96
15.1.6 Closure Costs.....	97
16 Market Studies and Contracts (Item 19)	99
16.1 Summary of Information.....	99
16.2 Nature of Material Terms	100
16.2.5 Sodium Sulfate	102
16.2.6 Uses of Sodium Sulfate.....	102
16.2.7 Production of Sodium Sulfate.....	103
16.2.8 Demand for Sodium Sulfate	103
16.3.1 EFM.....	104
16.3.2 Sodium Sulfate	105
16.4 Contracts and Status.....	106
17 Environmental Studies, Permitting and Social or Community Impact (Item 20)	109
17.1 Related Information.....	109
17.2 Environmental Studies	109
17.3 Exploration Permitting Requirements	110
17.4 Development Permitting Requirements	110
17.4.1 Environmental Assessment Process.....	111
17.4.2 Environmental Assessment Requirements of the Project.....	112
17.4.3 Environmental Licensing Process	113
17.5 Social and Community	114
17.5.1 Public Consultation.....	114
17.5.2 First Nations Engagement.....	114
17.6 Operating and Post Closure Requirements and Plans	114
17.6.1 Operating Plans.....	114
17.6.2 Conceptual Decommissioning and Reclamation Plan	114
17.7 Environmental Issues.....	115
18 Capital and Operating Costs (Item 21)	119
18.1 Capital Costs.....	119
18.1.1 Mine.....	119
18.1.2 Process Capital Costs.....	120
18.1.3 Other Capital Costs	122

18.1.4 Payback.....	123
18.2 Operating Costs	123
18.2.1 Mine Operating Costs.....	123
18.2.2 Process Operating Costs	124
19 Economic Analysis (Item 22)	127
19.1 Principal Assumptions.....	127
19.2 Cashflow Forecasts and Annual Production Forecasts	127
19.3 Taxes, Royalties and Other Interests.....	133
19.4 Sensitivity Analysis.....	133
19.4.1 Results.....	133
20 Adjacent Properties (Item 23)	134
21 Other Relevant Data and Information (Item 24)	135
22 Interpretation and Conclusions (Item 25)	136
22.1 Results and Conclusions	136
22.1.1 Exploration	138
22.1.2 Mineral Resource Estimate	138
22.1.3 Infrastructure and Tailings.....	138
22.1.4 Mine Operations	139
22.2 Significant Risks and Uncertainties.....	139
22.2.1 Surface Rights	139
22.2.2 Metallurgy and Processing	139
22.2.3 Commodity and Reagent Price	140
22.2.4 Infrastructure and Tailings.....	141
22.2.5 Permitting	141
22.2.6 Foreseeable Impacts of Risks.....	141
23 Recommendations (Item 26)	143
23.1 Recommended Work Programs.....	143
23.1.1 Costs	144
24 References (Item 27).....	145
25 Glossary.....	148
25.1 Mineral Resources	148
25.2 Mineral Reserves	148
25.3 Glossary	149
25.4 Abbreviations	150

List of Tables

Table 1: Mine Operating Cost Summary	iii
Table 2: Record Ridge Mineral Resource Statement – April 18, 2013	iv
Table 3: Model Parameters	iv
Table 4: Mine & Plant Economic Results	v
Table 5: Sensitivity Analysis of Pre-Tax NPV 5% (US\$ million).....	vi
Table 2.2.1: WHY Mineral Claims	6
Table 2.2.2: WHY Crown-granted Lands and Private Titles.....	6
Table 9.2.2.1: 2011 Sampling by Laboratory	32
Table 11.2.1: Resource Mineralogy.....	46
Table 11.2.2: Resource Elemental Composition	46
Table 11.2.3: Met-Solve ICP-AES Analysis of WHY Resources Tested Material.....	47
Table 11.2.4: Extraction of Magnesium from Initial Ambient-Temperature Leach Results	48
Table 11.2.5: Extraction of Magnesium from Intense Leach Conditions.....	49
Table 11.2.6: Extraction of Magnesium from Intense Leach Results.....	50
Table 12.2.1: Basic Drillhole Database Statistics.....	53
Table 12.3.1: Lithic Types and Groups, Raw Assay Data with Intervals Broken by Domain.....	54
Table 12.4.1: Block Model Limits.....	55
Table 12.6.1: Density Determinations	55
Table 12.7.1: Semivariogram Model Results.....	56
Table 12.8.1: Ellipsoid Orientations.....	56
Table 12.8.2: Estimation Parameters and General Statistics.....	57
Table 12.9.1: Model Validation Statistical Results	57
Table 12.11.1 - Record Ridge Mineral Resource Statement – April 18, 2013	58
Table 12.11.1.1: Record Ridge Measured and Indicated Mineral Resource Sensitivity	59
Table 13.2.1.1: Record Ridge Resource Block Model Parameters.....	74
Table 13.2.1.2: Record Ridge Pit Optimization Parameters.....	75
Table 13.2.2.1: Whittle™ Cashflow Values for Best and Worst Cases.....	75
Table 13.2.2.2: Comparison Between Whittle™ Economic Pit Shells 8 and 13	76
Table 13.3.1: Pushbacks Heights/Depths and Overall Dimensions.....	77
Table 13.3.1.1: Pit Design Parameters.....	77
Table 13.3.2.1: Waste Tonnage and Volumes per Pushback.....	78
Table 13.4.1: Phase Inventory Details.....	78
Table 13.5.1: Equipment List for Open-Pit Mining.....	79
Table 13.5.2: Mine Operating Cost.....	80
Table 13.5.3: Labor Schedule for First Five Years.....	80
Table 14.1.1: Design Criteria.....	90

Table 14.4.1: Scoping Level Operating Cost Estimate, Per Tonne of Material Treated +/-35%.....	93
Table 14.4.2: Scoping Level Capital Cost Estimate, +/- 35 %.....	93
Table 15.1.5.1: Estimated TSF Construction Costs	96
Table 15.1.6.1: Estimated Closure Costs	97
Table 16.1.1 Record Ridge Commodity Pricing	99
Table 16.2.1.1: Product Specifications for EFM	100
Table 16.2.1.2: Typical Specifications EFM	101
Table 16.2.7.1: Approximate Global Sodium sulfate capacity, by region in 2010.....	103
Table 16.2.8.1: Annual Sodium Sulfate Demand since 2003 (Mt)	104
Table 16.3.1.1: Raw Data Analysis	104
Table 16.3.2.1: World Sodium Sulfate Export Prices	105
Table 16.3.2.2: Prices for Sodium Sulfate in North America, 2006-2010, US\$/ton	105
Table 16.3.2.3: Global Sodium Sulfate Consumption Forecast up to 2017 (tonnes).....	105
Table 17.4.3.1: Potential List of Federal Authorizations, Licenses, Permits and Approvals	113
Table 18.1.1: LoM Capital Costs	119
Table 18.1.1.1: Mine Capital Costs	119
Table 18.1.1.2: Drilling Capital Costs	120
Table 18.1.1.3: Loading Capital Costs	120
Table 18.1.1.4: Hauling Capital Costs	120
Table 18.1.1.5: Roads & Dumps Capital Costs.....	120
Table 18.1.2.1: Processing Capital Costs	121
Table 18.1.2.2: Material Comminution Capital Costs	121
Table 18.1.2.3: Mg Leaching & Precipitation Capital Costs	122
Table 18.1.2.4: MgO Calcination Capital Costs	122
Table 18.1.2.5: Other Processing Capital Costs	122
Table 18.1.3.1: Other Capital Costs	122
Table 18.1.3.2: Closure Capital Costs.....	123
Table 18.2.1: Operating Cost Summary	123
Table 18.2.1.1: Mine Operating Cost Summary	124
Table 18.2.2.1: Processing Operating Costs.....	124
Table 18.2.2.2: Processing Cost Build Up.....	125
Table 18.2.2.3: Acid Cost Build Up.....	125
Table 19.1.1: Model Parameters	127
Table 19.2.1: Mine Production Summary	127
Table 19.2.2: Plant Production Summary.....	128
Table 19.2.3: Mine & Plant Economic Results	129
Table 19.2.4: Cash Costs Summary.....	130

Table 19.2.5: Annual Mine Production	131
Table 19.2.6: Annual Process Production and Cashflow	132
Table 19.4.1: Sensitivity Analysis of Pre-Tax NPV 5% (US\$ million).....	133
Table 22.1.1: Mine & Plant Economic Results	137
Table 22.1.2: Cash Costs Summary.....	138
Table 23.1.1.1: Estimated Costs for Recommended Work Programs	144
Table 25.3.1: Glossary.....	149
Table 25.4.1 Abbreviations	150

List of Figures

Figure 2-1: Location of Record Ridge Magnesium Project.....	8
Figure 2-2: Mineral Titles Controlled by WHY in the Vicinity of the Record Ridge Project	9
Figure 3-1: Land Status and General Ownership	14
Figure 3-2: Mineral Title Ownership and Status in the Project Area	15
Figure 5-1: General Geological Map of the Record Ridge Project Area	21
Figure 5-2: Local Geological Map of the Record Ridge Project Area	22
Figure 5-3: Local Geological Cross Section 1175W of the Record Ridge Project Area	23
Figure 6-1: Ultramafic Complex Types Found in British Columbia	26
Figure 8-1: Drill Collars at the Record Ridge Property	30
Figure 9-1: 2007 and 2008 Drilling Program ¼ Core Sample Duplicates	37
Figure 9-2: 2007 and 2008 Drilling Program Lab Pulp Duplicates	38
Figure 9-3: Duplicate Density Measurements from 2007 and 2008 Drilling.....	39
Figure 9-4: XY Scatter Plot of Mg in 2011 Lab Check Samples	40
Figure 9-5: XY Scatter Plot of Mg in 2011 Field Duplicate Samples.....	41
Figure 9-6: Plot Showing 2011 Quartzite Blanks.....	42
Figure 9-7: Scatter Plot of SGS vs. ALS Mg% Prior to Lab Changeover	43
Figure 11-1: Met-Solve Laboratory Testing Flowsheet	52
Figure 12-1: Histogram and General Statistics for Mg	60
Figure 12-2: Oblique of 3D Geological Model, Looking Northeast.....	61
Figure 12-3: Representative Cross Section of Modeled Lithologies (Ultramafics-green, Felsics-red and Mafics-blue)	62
Figure 12-4: Cumulative Probability Plot	63
Figure 12-5: Histogram and General Statistics of Capped 3m Bench Composites	64
Figure 12-6: 3D Omnidirectional Semivariogram Model	65
Figure 12-7: Structural Zones 1-3 Showing Second Pass Search Ellipsoid (100m grid).....	66
Figure 12-8: Representative Cross Section Showing Estimated Block Grades and 3m Composite Grades (Looking North)	67

Figure 12-9a: Swath Plots of Ordinary Kriging and Nearest Neighbor Grade Comparisons 68

Figure 12-9b: Swath Plots of Ordinary Kriging and Nearest Neighbor Grade Comparisons 69

Figure 12-9c: Swath Plots of Ordinary Kriging and Nearest Neighbor Grade Comparisons 70

Figure 12-10: Level Plan (1425m) Showing Resource Classification 71

Figure 12-11: Grade Tonnage Relations of the Measured and Indicated Resources..... 72

Figure 13-1: Project Layout 81

Figure 13-2: Slope Zones: North and South Zones..... 82

Figure 13-3: Whittle™ Pit By Pit Graph 83

Figure 13-4: Comparison of Best and Worst Mining Sequences 84

Figure 13-5: Whittle™ Pit Shell Profile (section view at approximately 5432400 Northing 85

Figure 13-6: Comparison of the Ultimate Pit Design and Base Case Shell 13 86

Figure 13-7: Life of Mine Production Schedule 87

Figure 13-8: Five-Year Pit Development 88

Figure 13-9: Dump Location 89

Figure 14-1: Process Flowsheet..... 94

Figure 15-1: Infrastructure Layout for Record Ridge..... 98

Figure 16-1: China: Average Monthly Quoted Prices for EFM, 2007-2012 (US\$/t) 107

Figure 16-2: Belgium, Netherlands and Poland: Average values of imports of EFM from Australia, 1997-2011 (US\$/t) 108

Figure 17-1: Record Ridge Project Environmental and Permitting Layout..... 116

Figure 17-2: Provincial Environmental Assessment Process Chart..... 117

Figure 17-3: Typical Schedule for a CEEA 2012 Standard EA 118

Figure 19.4.1: Project Sensitivities of NPV 5% (US\$ million)..... 133

Appendices

- Appendix A: MLA Characterization of an Ore Sample from the West High Yield (WHY) Resources Project, CAMP, February 13, 2012
- Appendix B: Metallurgical Test Work on the West High Yield Resource Samples, Met-Solve, October 31, 2012
- Appendix C: West High Yield Resources; Supplemental Process Development Test Work, Met-Solve, April 18, 2013
- Appendix D: Certificates of Qualified Persons

1 Introduction (Item 2)

1.1 Terms of Reference and Purpose of the Report

SRK Consulting (U.S.), Inc. (SRK) has been commissioned by West High Yield [W.H.Y] Resources Ltd. (WHY) to prepare a Canadian National Instrument 43-101 (NI 43-101) compliant Preliminary Economic Assessment (PEA) for the Record Ridge Project (Record Ridge or the Project), Rossland Mining District, British Columbia (B.C.), Canada located near the town of Rossland, B.C. The Project is an intermediate-advanced stage magnesium exploration project that was mapped, surveyed, and drilled by WHY during 2007, 2008 and 2011. This document provides a PEA of the Project, prepared according to NI-43-101 guidelines. Form NI 43-101 F1 was used as the format for this report. The intent of this Technical Report is to provide the reader with a comprehensive review of the recent exploration activities, metallurgical test work and economic analysis conducted at the Project. WHY may also use the PEA for any lawful purpose to which it is suited.

This report is prepared using the industry accepted Canadian Institute of Mining, Metallurgy and Petroleum (CIM) “Best Practices and Reporting Guidelines” for disclosing mineral exploration information, the Canadian Securities Administrators (CSA) revised regulations in NI 43-101 (Standards of Disclosure For Mineral Projects) and Companion Policy 43-101CP, and CIM Definition Standards for Mineral Resources and Mineral Reserves (December 27, 2010).

The PEA is preliminary in nature, in that it includes inferred mineral resources that are considered too speculative geologically to have the economic considerations applied to them that would enable them to be categorized as mineral reserves, and there is no certainty that the PEA will be realized.

1.2 Qualifications of Consultants (SRK)

The following individuals, by virtue of their education, experience and professional association, are considered Qualified Persons (QP) as defined in the NI 43-101 standard, for this report, and are members in good standing of appropriate professional institutions. The QP's are responsible for specific sections as follows:

- Bart Stryhas, PhD, CPG, is the QP responsible for Property Description and Ownership, Geology and Mineralization, and Exploration Status portions of the Executive Summary, Sections 1, 2.1, 2.2, 2.3, 3 through 10 and 12;
- Bret Swanson, BEng Mining, MAusIMM, MMSAQP is the QP responsible for the Development and Operations, Mineral Reserve Estimate, Economic Analysis and Conclusions and Recommendations portions of the Executive Summary, Sections 13, 15, 16, and 18 through 25;
- Corby Anderson, PhD CEng FIChemE FIMMM MMSAQP is the QP responsible for Mineral Processing and Metallurgical Testwork, and Recovery Methods Sections 11 and 14; and
- Arlene Laudrum, PGeo, is the QP responsible for Environmental Studies, Permitting and Social or Community Impact Sections 2.4, 2.5 and 17.

1.3 Details of Inspection

On November 18 and 19, 2008, Dr. Bart Stryhas conducted a site visit of the Project. The first day was a meeting with Sam Marasco, Project Manager; Hun Kim, Chief Geologist; and Cory Peck,

Senior Geologist, all of WHY. Approximately five hours were spent reviewing the project geology, exploration procedures, data collection procedures, Quality Assurance/Quality Control (QA/QC) studies and data base development.

The following day began with additional office discussions followed by a tour of the project area. Dr. Stryhas, Hun Kim and Cory Peck traveled to the site access road via SUV. The vehicle was parked at the public highway and the three walked up the access road approximately 1 km to the area of exploration drilling. The day was clear but cool, and there was 3 to 6 cm of snow on the ground. Mineralization is located beneath a moderately sloping hill facing east-southeast. The area is sparsely forested and Dr. Stryhas observed mineralized rock exposures in road cuts and natural outcroppings. The drill pads are clearly visible, with each completed drill collar marked by a heavy wooden stake painted, or flagged brightly with the drillhole identification labeled by black marker and on an aluminum tag. Dr. Stryhas traversed the Project area from the southeast to the northwest to the extent of the drilling and at least 20 existing drill pads were identified in the field.

After visiting the exploration area, the group drove to the core processing and storage facility where they were met by Sam Marasco, Dave and Irene McKinnon. The facility is located on private property owned by WHY about 5 km from the exploration area. This site is a historic gold mine located at the end of a dead end drive behind a locked gate. The facility consists of an office trailer, an open shed with a core saw and core racks, and ten locked cargo containers housing WHY's archived core. Mr. Kim and Mr. Peck demonstrated the procedures employed during the core logging. Dave and Irene McKinnon, who had done all core cutting and sampling, demonstrated these procedures. Several examples of the mineralized core were retrieved from a cargo container and inspected in sunlight. Approximately six hours were spent touring the exploration area and core processing facility.

On September 26 to 28, 2011, the SRK project team consisting of Matt Hastings, Brett Swanson and Rennie Kaunda of the Lakewood, Colorado office, and Arlene Laudrum of the Yellowknife, NWT, Canada office, conducted a site visit of the Record Ridge property. The visit was conducted in conjunction with Frank Marasco, Ian Kennedy, Ross Drysdale, Hun Kim, Cory Peck, and other WHY personnel working on site. Conditions were very good for this site visit and all areas of the Project were open for access. The site tour began by reviewing data, maps, and cross sections in the WHY offices in Rossland. The team then traveled by truck to the site, which dominantly is covered by dense forests and local open grassy areas. The area is hilly and access is dominantly by 4WD vehicle only. The SRK team visited and spoke with the drilling crew that was on site at the time, and was able to tour the core storage and logging facilities. The team walked and photographed a number of areas of geologic or mining interest. The SRK team was also able to access and observe potential locations for tailings disposal, waste dumps, and process plant. General discussions were ongoing throughout the day. Prior to dinner with the WHY personnel, the SRK team drove approximately 10 km to see the large smelting facility in nearby Trail, which is a possible source of consumables for the metallurgical process. The team stayed in Rossland the night of the September 27 and left the following day to return to their respective locations.

Dr. Corby Anderson visited the laboratories at Met-Solve in Vancouver, B.C., Canada on two separate occasions, in October of 2011 and April of 2012.

1.4 Reliance on Other Experts (Item 3)

The QP, Dr. Bart Stryhas, has examined the exploration data for the Project provided by WHY and has relied upon that basic data to support the statements and opinions presented in his respective

sections of this Technical Report. In the opinion of the QP, the data is presented in sufficient detail, is credible and verifiable in the field and it is an accurate representation of the magnesium mineralization at the Project. It is the opinion of the QP that there are no material gaps in the drilling and assay information for the project. Sufficient information is available to prepare this report, and any statements related to deficiency of information are directed at information, which, in the opinion of the author, is not material to the scope of the report.

The authors have relied upon the following work to describe the land tenure and land title in British Columbia, referring specifically to Sections 2.1 – Property Description and Location and Section 2.2 – Mineral Titles:

- Claim Map, WHY internal company map reference to data obtained from: Geological Survey of Canada, 2012;
- An Excel spreadsheet provided by WHY listing 20 mineral claim tenure numbers with map numbers, 2012; and
- Area size and expiration date; and the British Columbia Mineral Title Website <http://www.mtonline.gov.bc.ca/mtov/jsp/searchTenures.jsp> used to verify the claim status, 2012.

The authors have relied upon information provided by WHY to describe the Royalties, Agreements and Encumbrances in Section 2.3.

SRK has relied upon regional environmental information gathered from the B.C. Gas Utility Ltd. Southern Crossing Pipeline Project, the Teck Cominco Smelter Ecological Risk Assessment, the Waneta Hydroelectric Expansion Project and wildlife habitat mapping by the B.C. Ministry of Forests, Lands and Natural Resource Operations (MFLNR) and fish and fish habitat data collected by the B.C. Ministry of Environment (MOE) to support statements made in Section 17 of this report.

1.4.1 Sources of Information and Extent of Reliance

Standard professional review procedures were used in the preparation of this report. The QP's have reviewed data provided by WHY, conducted a site visit to confirm the drilling and mineralization; and inspected the Project's potential development sites. Nearly the entire Project's exploration data is modern, dating from 2007 through 2011. Three previous reports are referenced by SRK and include the 2006 NI 43-101 compliant "Technical Report Midnight, Ok, IXL and Adjacent Gold Properties"; the 2008 "Diamond Drilling Assessment Report on the Record Ridge South Property"; and the 2009 SRK Report "NI 43-101 Technical Report on Resources, West High Yield Resources Ltd., Record Ridge South, Rossland, British Columbia." The exploration drillhole database was provided to SRK by WHY as electronic copies of individual drill logs, original assay certificates, including duplicate check assays, and a drillhole location map generated by a legal surveyor. Metallurgical test work was provided to SRK by Met-Solve Laboratories Inc. Langley, B.C., Canada, in a report titled "Final Report on the Metallurgical Test Work on the West High Yield Resource Samples", dated October 31, 2012.

1.5 Effective Date

The effective date of this report is April 18, 2013.

1.6 Units of Measure

The metric system has been used throughout this report. Tonnes are metric of 1,000 kg, or 2,204.6 lb. All currency is in U.S. dollars (US\$) unless otherwise stated.

2 Property Description and Location (Item 4)

2.1 Property Description and Location

The Project is an intermediate-advanced stage magnesium exploration project covering 6,515 hectares. It's located 7.5 km air west to southwest of the town of Rossland, B.C., Canada; 5 km north of the U.S.-Canada border; and approximately 400 km east of the Vancouver, B.C. (Figure 2-1). The mineralization is centered about 49°02'33" N. latitude and 117°53'22" W longitude (UTM NAD 83 coordinates 5,432,500 N and 434,500 E). The property is located in the Canadian National Topographical System Mapsheet 082F.

2.2 Mineral Titles

The WHY claim block consists of 20 contiguous mineral claims covering 6,515.12 hectares (ha), all under the 100% ownership of WHY Resources (#145867). Also considered are the nearby WHY land holdings consisting of eight Crown-granted claims and one private claim with surface and mineral rights (9 titles) totaling 85.93 ha (Figure 2-2). The known magnesium mineralization of the Project is located within two mineral claims. The northern portion of the identified mineralization is located within claim # 514607 (Frank SR), which covers 317.6 ha. This claim was originally located by WHY on June 16, 2007, and is in good standing until February 28, 2023. The southern portion of the mineralization is located on claim #513794 (Hidden Valley 3) which covers 127 ha. This claim was originally located by WHY on June 2, 2005, and is in good standing until February 28, 2023. Table 2.2.1 lists the pertinent data for the 20 mineral tenures and Table 2.2.2 lists the same data for the 9 crown granted and private titles. These claims are also shown in Figure 2-2. In British Columbia, mineral claims are now located only by coordinate descriptions on paper registrations. There are no physical markers in the field to mark the claim locations of the WHY claims. WHY must pay an annual assessment fee ranging between CDN\$3.00 to CDN\$8.00/ha depending on the maturity of the claim and file an annual assessment report to maintain the mineral tenures in good standing. Exploration expenditures can be used for Portable Assessment Credit (PAC) credits in lieu of annual assessment to maintain the claims. WHY has currently applied CDN\$1.6 million of exploration expenditures toward the claim assessment fees and has effectively paid fees required to maintain the claims in good standing for at least ten years in advance.

The current preliminary project layout is located predominantly on mineral titles which WHY controls, with one notable exception. The conceptual design of the tailings storage facility is located partially on a mineral title which is not controlled by WHY. The location of the conceptual storage facility is contingent upon WHY's ability to obtain access to this mineral title for the purposes of tailings storage. Other options exist to the north of the Project which could, with more study, be viable for tailings storage and are located on land which WHY controls the mineral rights to.

Table 2.2.1: WHY Mineral Claims

Tenure Number	Claim Name	Issue Date	Expiry Date	Status	Area (ha)
513010	Ram3	2005/May/19	2022/Feb/28	Valid	528.872
513018	Frank Sr 2	2005/May/19	2022/Feb/28	Valid	529.112
513757	Hidden Valley	2005/Jun/01	2022/Feb/28	Valid	190.626
513788	Hidden Valley 2	2005/Jun/02	2022/Feb/28	Valid	211.789
513794	Hidden Valley 3	2005/Jun/02	2023/Feb/28	Valid	127.057
514607	Frank Sr	2005/Jun/16	2023/Feb/28	Valid	317.575
517620		2005/Jul/13	2022/Feb/28	Valid	211.698
517622	Frank Sr 3	2005/Jul/13	2022/Feb/28	Valid	232.764
518969		2005/Aug/12	2022/Feb/28	Valid	359.616
518970	Ram	2005/Aug/12	2022/Feb/28	Valid	63.488
518971	Ramfrac	2005/Aug/12	2022/Feb/28	Valid	105.782
529246		2006/Mar/02	2022/Feb/28	Valid	21.154
529441	White Buffalo	2006/Mar/05	2022/Feb/28	Valid	254.141
574472	Rossland 1	2008/Jan/25	2018/Feb/28	Valid	528.6452
574473	Rossland 2	2008/Jan/25	2018/Feb/28	Valid	528.5764
580083	West High Yield Resources	2008/Apr/01	2018/Feb/28	Valid	507.0339
580084	West High Yield Resources	2008/Apr/01	2018/Feb/28	Valid	528.435
580085	West High Yield Resources	2008/Apr/01	2018/Feb/28	Valid	528.2651
580087	West High Yield Resources	2008/Apr/01	2018/Feb/28	Valid	359.3067
847539	The Ridge	2011/Feb/26	2014/Feb/26	Valid	381.1826
20 Claims					6,515.12

Source: British Columbia Government, 2012

Table 2.2.2: WHY Crown-granted Lands and Private Titles

Name	Lot	Crown Grant #	Title ID	Area (ha)	WHY Equity (%)
Midnight	1186	87-70	1134921	17.66	100
June	1216	156-86	N.A.	17.40	100
Golden Butterfly	1217	200-90	N.A.	17.40	100
Golden Butterfly Fr.	1943	237-90	N.A.	4.57	100
Little Dalles	1215	278-87	KV110354	2.73	100
OK Fraction	2675	274-90	N.A.	0.49	100
OK	678	60-68	KV112056	12.85	51
IXL	679	68-68	KV112053	7.85	100
Sub Lot 82 (Midnight)	PlanS82	87-80	KV112055	4.98	51
9 Titles				85.93	

Source: WHY Resources, 2012

2.3 Royalties, Agreements and Encumbrances

The claims covering the Project are 100% owned by WHY resources. These claims are subject to the same governances as all mineral claims in B.C., Canada, but have no other outstanding royalties, agreements or encumbrances.

2.4 Environmental Liabilities and Permitting

Existing environmental liabilities at the Project site are related to the exploration activities that WHY Resources Ltd. has undertaken to date. The open pit area consists of undeveloped, bare land with no previous development, mining or milling history. No existing liabilities associated with the utility right of ways or the gravel highway in the Project area are the responsibility of WHY.

Baseline studies have not been initiated. Studies to assess terrestrial, aquatic, atmospheric and socio-economic conditions will be required. These studies require input from many sources, including stakeholders.

The Project will be subject to review under the B.C. *Environmental Assessment Act* and the *Canadian Environmental Assessment Act, 2012*. The Environmental Assessment process is initiated with the submission of a Project Description. More detailed mine planning is required in order to prepare the Project Description. Upon approval of Environmental Assessment additional permits, licenses, authorizations, and certificates will be required to proceed with construction and operation of the project.

WHY has initiated consultation with the local business community and Provincial ministries and agencies.

Mine closure costs for the PEA mine plan and infrastructure as envisaged in this Report are estimated at US\$19.3 million. This cost includes reclamation and closure of the tailings and waste rock storage facilities and the open pit, decontamination of the facilities as necessary, removal of constructed surface facilities, disposal of hazardous materials at approved facilities and post-closure monitoring and maintenance to ensure that end land use objectives are met.

Section 17 of this report provides additional detail of environmental liabilities and permitting.

2.4.1 Required Permits and Status

The exploration work conducted to date on the Project has been completed under a Mines Act Permit MX-5-460 issued by the Ministry of Energy, Mines and Petroleum Resources, Mining and Minerals Division. This permit applies to all requirements of the Mines Act and Health Safety and Reclamation Code for British Columbia.

2.5 Significant Factors and Risks to Perform Work

There are no known significant factors or risks which could have a material impact on the ability to affect access, titles or the right to perform exploration work on the property.

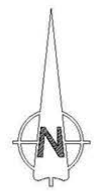
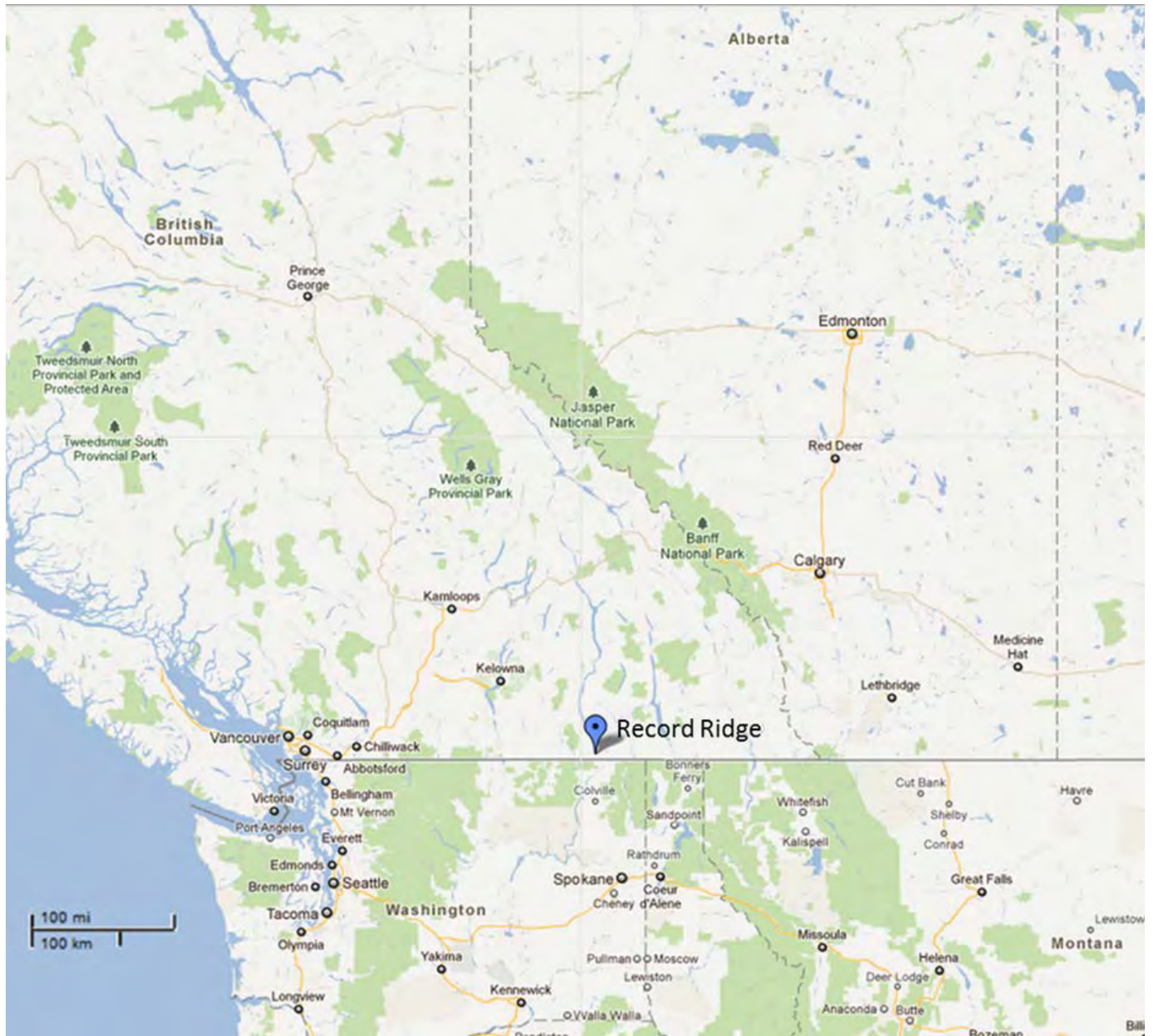

0 200 400 600 800 1000
Scale in Metres

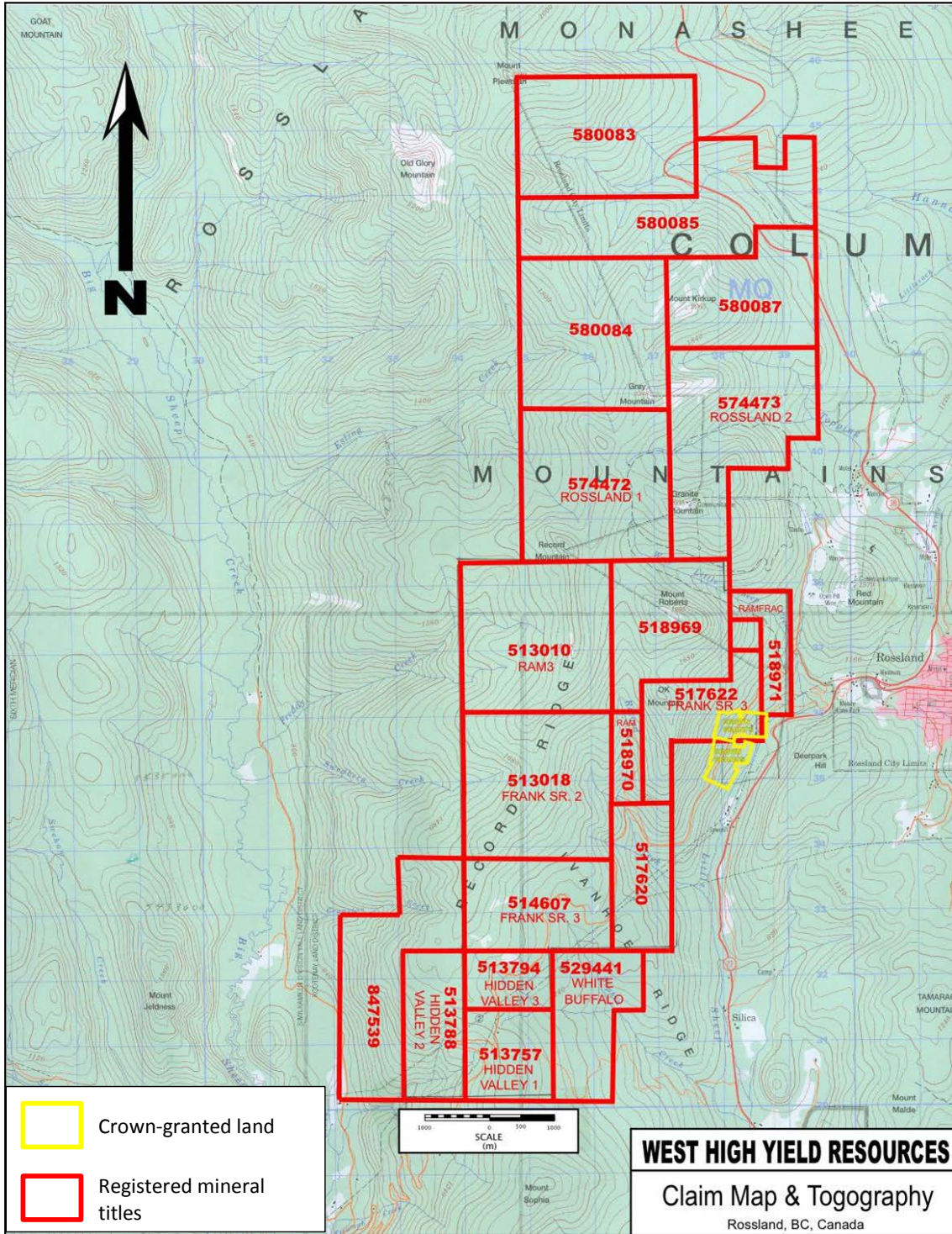

3 Accessibility, Climate, Local Resources, Infrastructure and Physiography (Item 5)

3.1 Access to Property

The Project is readily accessible by SUV or truck during the field season months. Access from Rossland, B.C., follows Provincial Highway 3B for 1.5 km west, and then proceeds along Highway 22 west for 0.4 km and turns right onto the Old Rossland-Cascade Highway. Follow this government maintained gravel road for 8.5 km to where the drill site access road takes off to the north. The drill road climbs a 10% grade for about 200 m where the drill sites begin. A network of four-wheel drive drill roads in good condition accesses the exploration area. The drive time from Rossland is approximately 20 minutes, to complete the 10.5 km route.

3.2 Physiography

The physiography of the Project is moderately steep and controlled by the structure of the underlying geology. The exploration area is located along the southeast face of the northeast trending Record Ridge. The ridge separates Big Sheep Creek to the west and Little Sheep Creek to the east by a maximum relief of 1,200 m. The average drillhole collar elevation is 1,470 m with a minimum of 1,400 m and a maximum of 1,550 m. The hill slope of the exploration area is 20% to the southeast.

The topography of the Project area is characterized by steep hills and broad valleys, with elevations ranging from 1,000 m in Rossland to 2,050 m at the mountain summits within the claim group. The hills and ridges are drained by gentle to deeply incised creeks and valleys. The ground surface of the elevated areas is covered by residual soil and bedrock outcrops are relatively plentiful. In the valley areas, glacial and alluvial gravel fill is relatively deep and the bedrock outcrop is limited to stream banks.

Vegetation is typical of the northern Rocky Mountains; locally varying between dense forest, and open grass covered areas. Fir, spruce and tamarack trees occur on north and east facing slopes; whereas ponderosa and lodge pole pine grow in more in the open south and west facing slopes. Various brush species and popular trees are common along streams and riverbanks.

The Project has sufficient sites suitable to accommodate mining roads and mining waste dumps, but not processing facilities. Private lands could be obtained in the nearby areas of Rossland or Trail to site a processing facility and tailings disposal area.

3.3 Climate and Length of Operating Season

The area has a northern continental climate strongly influenced by Pacific oceanic airflow from the west. Its longitudinal position provides a diverse four-season climate. Summer minimum temperatures average 10°C and maximum temperatures of 22°C occur during June through August. In the winter months of December through February, minimum temperatures average -8°C and maximum temperatures average -2°C. Annual precipitation averages 900 mm, approximately two thirds of the moisture occurs as snow during November through March. The operating exploration season begins in early May and continues through early November (source: Environment Canada).

3.4 Surface Rights

The Crown retains all surface ownership rights to the property, while permitting WHY to explore and develop the site for eventual mining. WHY must follow all environmental strictures pertaining to land degradation, remediation, and reclamation as specified in Canadian Federal and British Columbia Provincial laws.

The claims covering the mineralized areas are located on Crown land. A significant portion of the Project area is on private land where the timber rights are privately held. The Project also consists of proposed locations for a tailings facility that will be located on both private and Crown land in the vicinity of Corral creek. The mining/processing infrastructure and tailings facility will likely impact the following privately-held parcels, as identified by the B.C. government's Integrated Cadastral Fabric (ICF) data (Figure 3-1):

- DL 4359, Burlington MC;
- Sub L 235; and
- Sub L 235, Pix61.

As the data reviewed by SRK is very general in its scope, these parcels are subject to change as SRK noted that there were various discrepancies in the B.C. Government database between various datasets. Additionally, as the existing design is preliminary in nature, the degree of the impact to these parcels can be mitigated in the final design which would incorporate detailed legal surveys of all property boundaries. SRK is assuming that the (Unknown) land type used by the B.C. government is actually Crown land which has not been subdivided into individual parcels for private or public use, and that this land will require the same level of permitting and acquisition as the designated Crown lands on Figure 3-1. SRK is also aware that some of these parcels are for sale at the time of this writing, indicating that 100% ownership of the surface rights in the area may be a viable option.

The Project might also be located proximally to the following Rights of Way:

- Old Rossland-Cascade Highway Right of Way;
- B.C. Gas Pipeline Right of Ways; and
- B.C. Hydro Electrical Transmission Line Right of Ways.

It is expected that with appropriate studies and negotiations with land owners that land access and provision of land for infrastructure development will be achievable. There is sufficient suitable land area available within the mineral claims for mine waste disposal, a processing plant, and related mine infrastructure. Private property acquisitions may be required for future tailings disposal.

3.5 Local Resources and Infrastructure

The towns of Rossland (population 3,646) and nearby (8.9 km) Trail (population 7,575) have abundant local resources (Canada Census Data). Trail has an airstrip with commercial service provided by Pacific Coastal Airline to Vancouver, B.C. and also host charter, private and air ambulance service. Both towns have numerous hotels and restaurants. Rossland is partially a resort community servicing nearby Red Mountain Ski Area and has a blue-collar work force. Trail is mainly a blue-collar community located along the banks of the Columbia River and hosting the Teck-Metals Ltd smelter. The smelter produces lead and zinc from concentrates received from a wide range of sources.

3.6 Access Road and Transportation

The Project is located central to Vancouver, B.C.; Calgary, Alberta; and Spokane, WA, U.S. It is serviced by the Canadian national highway system and by U.S. highways to the south. Road access is excellent from any of these major cities. Trail is serviced by the Canadian Pacific (CP) Railway. This system routes directly to Calgary, Alberta or Vancouver, B.C. The CP railway also ties southward into the Burlington Northern Santa Fe Rail (BNSF) system near Cranbrook, B.C., approximately 150 km to the east. The BNSF rail services the north and northwestern U.S.

3.7 Power Supply

Abundant hydro electrical power is available in the area. The smelter at Trail is supplied by British Columbia Hydro and sourced from two locations. The Waneta Plant is located 7 km downstream on the Columbia River and the Brilliant hydroelectric plant is located 25 km upstream near Castlegar, B.C. The two mineral claims covering the magnesium mineralization are both traversed by electrical transmission lines leading from Rosslund westward. These lines would not however need to be moved if mining were to occur.

3.8 Water Supply

The area also has an abundant water supply. The region's high precipitation index feeds numerous surface and underground water sources. Water rights are governed by the "Water Act", which is administered by the Water Stewardship Division of the Ministry of Environment. Both surface and underground water rights are granted on an equal access, first come first serve basis. When a water license is issued, annual water rentals are assessed based on usage.

3.9 Port

The closest port is the Port Metro Vancouver, B.C. (PMV). PMV is the busiest port in Canada, trading US\$75 billion in goods annually. It comprises 600 km of waterfront with 28 major marine cargo terminals and three Class 1 railroads. The ports deep-sea terminals offer virtually no draft restrictions and support Super Post-Panamax capacity with extensive on-dock rail facilities.

3.10 Buildings and Ancillary Facilities

The exploration Project is currently supported by a small drill core processing and storage facility located on private land owned by WHY. This facility includes an office trailer, an open shed with a core saw, core racks and ten locked cargo containers holding the archived core. At this location, there are also two old mine support buildings, both in dilapidated condition. One appears to have been a compressor and storage building; the other was a small mill building.

3.11 Tailings Storage Facility Area

A tailings storage facility (TSF) area required to support milling of the magnesium resource of this report will need to be acquired outside of the current mineral claims held by WHY. The Sophia Creek valley located 2 km southeast of the mineralization appears to be ideally suited for this facility as it would be next to and immediately downgradient of the proposed Mill site and process area. There is a high power electric line and a gas line located in between the mineralization and this proposed TSF location.

However, WHY does not control a mineral title which covers the SE extent of the final tailings storage facility (Figure 3-2). While this mineral title does not prevent surface ownership or access rights at this time, there is an inherent risk associated with the TSF being located on uncontrolled mineral titles. WHY's ability to construct and operate the tailings facility as it is currently designed is subject to agreements with the owner of the mineral title to do so, or acquisition of the title itself. In addition, there are other opportunities to the north of the project on WHY-controlled mineral titles which might be suitable for TSF design given more study.

3.12 Waste Disposal Area

There are two potential valley fill mine waste disposal areas located within the vicinity of the magnesium mineralization on the Project. One potential site is located approximately 1 km to the southwest of the mineralization along the ridgeline straddling the drainages of Coral Creek to the west and Sophia Creek to the East. The other is a valley fill site located on the west side of Record Ridge approximately 1.5 km northwest of the mineralization within the upper Cransion Creek drainage basin.

However, it is also anticipated that pending detailed waste rock geochemical characterization, that the waste material would likely be suitable for construction of the tailings dam and would be 100% utilized for this purpose.

3.13 Manpower

The towns of Rossland and Trail both have a history of mining and could supply an adequate number of skilled and unskilled workers.

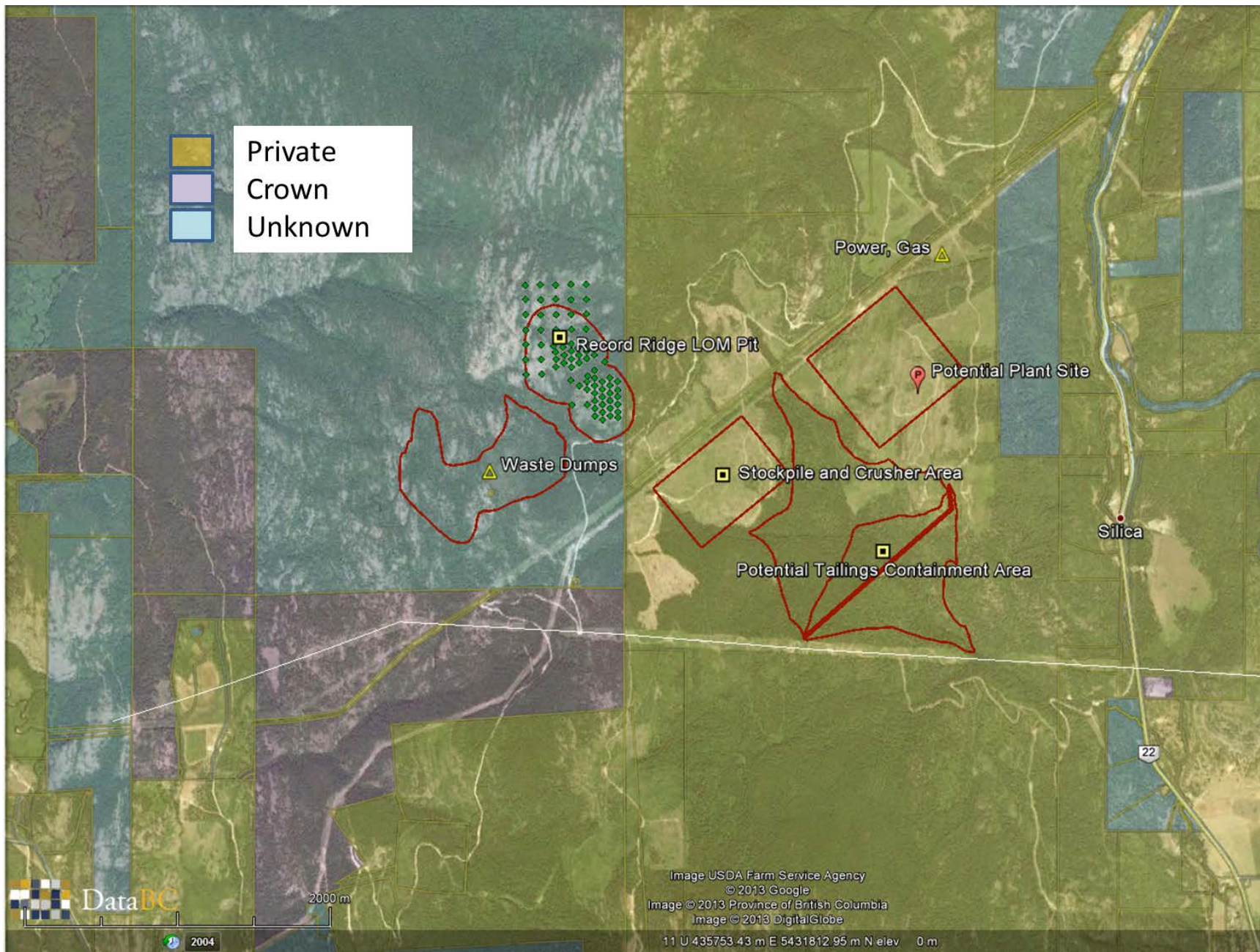

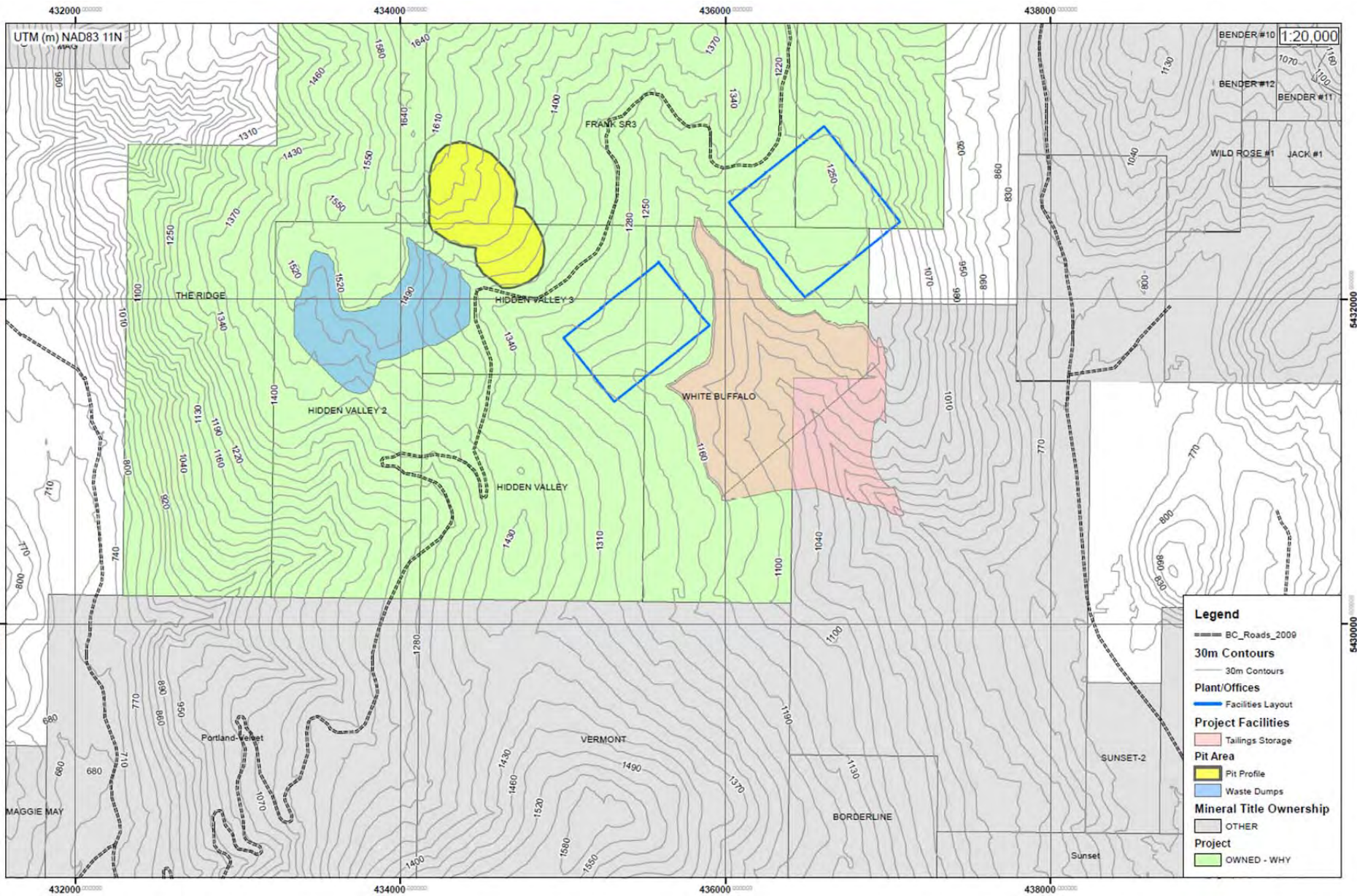

Record Ridge Project,
B.C. Canada

Source: Data BC, 2013

Figure 3-2

Mineral Title Ownership
and Status in the Project Area

4 History (Item 6)

4.1 Prior Ownership and Ownership Changes

The two mineral claims covering the magnesium resource of this report have no previous ownership prior to WHY. Other claims within the larger claim block have had previous ownership. These claims are not pertinent to this report and their history of ownership is purposely excluded here.

4.2 Previous Exploration and Development Results

The following information has been modified slightly from Kim and Peck report dated 2008.

The Project is part of a larger claim block historically explored by three previous owners. In 1973, Mineral Resources International Ltd. (MRI) of Calgary, AB, owned the “Job” claims, located on Ivanhoe Ridge, 2 km northwest of Record Ridge. In 1973, George G. Addie, P.Eng. P.Geo., was retained by MRI to conduct a magnetometer survey over the claims. The survey found anomalous magnetic zones within the claims that were linked to the occurrence of magnetite within the ultramafic body that lies within the Ivanhoe Ridge area.

The next work documented on the property occurred in 1978, when the claims MAR 1-4, LAND 1-6, SKIN 1-4, ROSS and CAL, became the “Morrison-White” property. This property was evaluated on behalf of United Canso Oil and Gas, Calgary, AB. A 460 ha area was first mapped at a scale of 1:10,000 on an enlarged aerial photo base and then a location grid was established and certain parts were geologically mapped at a scale of 1:2,500. The same area was also surveyed by soil sampling on a 50 m x 100 m grid. Magnetic profiling at 10 m station intervals was also completed. This work delineated eleven soil geochemical anomalies. Follow up field work concluded that eight of these were of sufficient interest to warrant further geophysical and/or geochemical evaluation.

The next documented exploratory work was in 1984 on the CAL and ROSS 2-3 claims, by Noranda Exploration Company. They performed trenching, soil sampling, a magnetometer survey over 16 km, as well as induced polarization and EM surveys over 1 km. A total of 177 samples were taken.

4.3 Historic Mineral Resource and Reserve Estimates

There are no known historic mineral resource or reserve estimates. SRK did complete a NI 43-101 compliant, mineral resource estimation in 2009 as cited in Section 1.4.

4.4 Historic Production

There has been no historical production of the magnesium resource at the Project.

5 Geological Setting and Mineralization (Item 7)

5.1 Regional Geology

The regional geologic history of eastern British Columbia has occurred over millions of years and is complex, involving both extensional and compressional plate tectonic forces. The oldest rocks were formed in the late Proterozoic (750 Ma) when the Rodina supercontinent was torn apart. This event created the western margin of the ancestral North American Craton along present-day Western Alberta. The passive margin existed until the mid-Devonian (390 Ma), resulting in a thick wedge of miogeosynclinal sediments eroded from the Canadian Shield to the east. During the late Devonian, an oceanic trench is believed to have formed along the axis of the sedimentary wedge due to the combined weight of sediments over the oceanic crust and a change to the convergence plate boundary. This newly formed convergent boundary created a magmatic island arc and associated back arc basin along the western edge of the North American Craton not far from its margin, throughout the Mississippian (355 Ma). Over the next 150 million years, numerous spreading centers and subduction related island arcs formed further westward off shore until the Jurassic Period (180 Ma). At this time, the breakup of Pangea caused the North American Craton to begin moving westward. As this occurred, the craton essentially plowed into the various island arc terrains along the way. This episode was accompanied by a significant amount of crustal shortening forming widespread fold and thrust belts. Numerous island arc terrains and bits of oceanic crust were accreted to the western edge of North America, which can today be delineated by unique geological characteristics. During the Cretaceous Period (115 Ma), the exotic Insular superterrains collided with North America deforming all the previously accreted terrains and forming a new series of Tertiary (50 Ma) igneous rocks. Considerable extensional tectonism then occurred. This event formed large grabens and detachment basins associated with the development of metamorphic core complexes. At the same time, large-scale Tertiary intrusive complexes were emplaced. Eventually, within southeastern British Columbia, movement changed to a strike-slip system with the oceanic plates moving northward relative to the North American Craton (Seigel, 2005).

Today, the regional geology of British Columbia is subdivided into five major tectonic belts characterized by a unique history and timing of deformation. Arranged from the current Alberta Plains westward, these are referred to as; Foreland, Omineca, Intermontane, Coast and Insular. The Foreland Belt is characterized by deformation during the late Jurassic and Cretaceous as the exotic terrains were accreted onto the North American Craton. The Omineca Belt is composed mainly of the thick sequence of miogeosynclinal sediments deposited on the western margin of North America during the Paleozoic. The Intermontane Belt is composed of the exotic island arc terrains formed during the Triassic and Jurassic and accreted during the late Jurassic-Cretaceous. The Coast Belt is a suture zone composed of plutonic and metamorphic rocks formed when the Insular superterrains collided with the North American Craton. The Insular Belt is composed of exotic island arcs formed in the Devonian and accreted to the North American Craton in the Cretaceous.

5.2 Local Geology

The Record Ridge area is located within the Quesnel Terrain of the Intermontane Belt. It is comprised of a highly deformed Jurassic (180 Ma) age volcanic island arc-back arc basin complex intruded by Tertiary volcanic and plutonic rocks. The exploration area is underlain primarily by the Record Ridge Ultramafic Body of Paleozoic Age (Figures 5-1, 5-2 and 5-3). This unit is bound on the

north by the volcanics of the Tertiary Marron Formation, on the east and southeast by the volcanic rocks of the Jurassic Elise Formation and on the west and southwest by the Tertiary age Coryell intrusive suite. Regional metamorphism has reached greenschist facies in the Project area.

5.2.1 Stratigraphy

The Record Ridge Ultramafic Body underlies an area of approximately 7.5 km². It extends from the southern tip of Record Ridge, south to the foot of Mount Sophia and east to Ivanhoe Ridge. The Record Ridge Ultramafic Body comprises variably serpentinized and locally carbonatized ultramafic cumulates. Rock types include dunite, pyroxene-bearing dunite, olivine-bearing wehrlite and wehrlite, each type varying simply as a function of the relative proportion of olivine to pyroxene. Disseminated chrome spinel is present in all the ultramafic rocks. On fresh surfaces the unit is very fine grained with a black color. It also contains abundant veinlets of light green to bluish serpentinite. The unit weathers to a brown color and stands out as open outcrops with a distinctive lack of vegetation in the nearby soils. Where observed, the contacts of the ultramafic body are sharp and display varied amounts of fault movement. The lobate nature of its western and southwestern margins, combined with the presence of small isolated ultramafic bodies that are possibly xenoliths or rafts within the Coryell batholith several kilometers to the south suggest an intrusive contact with the batholith. Along its eastern margin, the contact is not exposed, but the presence of fish-scaled serpentine with localized carbonate altered shear zones near the margin of this body indicates a faulted contact (Price, 2006).

The Elise Formation is Jurassic age; composed of metamorphosed volcanic conglomerates, flow breccias, crystal and lapilli tuffs with intercalated siltstone and mudstones. The formation is at least 5,000 m thick and is primarily andesitic in composition. The unit is interpreted to represent one of the exotic island arc, back arc basin terrains (McCloughry and Gaylord, 2005).

The Marron Formation consists of Tertiary age, porphyritic and amygdaloidal trachyte and andesite flows and tuffs. Phenocrysts are typically plagioclase, augite or biotite. The unit weathers to grey, dark grey to dark green blocky open outcrops. These rocks are believed and have formed within a terrestrial volcanic arc deposited into grabens formed during the intrusion of the Coryell intrusive. They are up to 2 km thick. A whole rock potassium argon date gave a 52 Ma age (Fyles, 1984; McCloughry and Gaylord, 2005).

The Coryell Batholith is a Tertiary age, medium to coarse-grained syenite, pink in color. The unit is commonly fractured and deeply weathered. The margins of the batholiths have narrow halos of thermal metamorphism indicating a shallow level of emplacement. The unit has a uranium age date of 52 Ma. The batholith is one of several with similar characteristics which occupy a north-south trending belt located slightly westward of a similar belt of Cretaceous intrusives (Logan, 2002). These are believed to have formed as a result of crustal thinning associated with Tertiary extensional tectonics.

5.2.2 Alteration

The principal alteration associated with the ultramafic rock of this study is serpentinization. This is a metasomatic process involving the hydration of magnesium or iron rich olivine. In the case of Mg rich olivine, the general reaction is:

- Forsterite + Aqueous Silica → Serpentine; and
- $3\text{Mg}_2\text{SiO}_4 + \text{SiO}_2 + 4\text{H}_2\text{O} \rightarrow 2\text{Mg}_3\text{Si}_2\text{O}_5(\text{OH})_4$.

Based on oxygen isotopic studies, Wenner and Taylor (1974) have deduced that serpentinization in Alaska-type ultramafic complexes has occurred from waters of meteoric-hydrothermal origin at relatively shallow levels in the crust. In this case, the serpentinization of the Record Ridge Ultramafic Body may be related to the emplacement of the Coryell Batholith and associated hydrothermal activity. The waters may have been meteoric and the silica would have been readily available in the nearby volcanics or the intrusive itself.

The process of serpentinization has two important characteristics that can affect its level of development. First, the reaction is exothermic, which will help to maintain and prolong the hydrothermal activity. Secondly, the process produces a volume increase of nearly 30% with a resultant decrease in density. This physical condition would require that the host ultramafic must expand by fracturing with minor fault movement. This increases porosity and permeability of the host allowing the alteration to affect a larger percentage of the ultramafic (Mathilde and Sergey, 2007).

Depending on the nature of the serpentinization reaction and the scale of the hydrothermal cell, the alteration process can result in a depletion of iron from the original material. In this case the following reaction can occur:

- Olivine + Fluid → Magnetite + Serpentine + Brucite; and
- $(\text{Mg Fe})\text{SiO}_4 + \text{H}_2\text{O} + \text{O}_2 \rightarrow \text{Fe}_3\text{O}_4 + \text{Mg}_3\text{Si}_2\text{O}_5(\text{OH})_4 + \text{Mg}(\text{OH})_2$.

Depending on oxygen fugacity, the magnetite can stay in solution and be transported out of the host ultramafic unit resulting in a relative increase in magnesium (Mg) content (Frost and Beard, 2007).

5.2.3 Structure

The structural history of the Project area was a result its long history of regional tectonics. The most significant feature has been termed the Rossland Break. This feature is defined by the thrust fault shown in Figure 5-1, located along the eastern boundary of the Record Ridge Ultramafic and extending northeast ward through the historic Rossland Mining Camp (Fyles, 1984; Hoy and Dunne, 1998). In this general area, the Rossland Break separates two regional, structural fabrics. On the south side of the break, the structural fabrics strike to the northeast. In contrast, on the north side of the break the structural fabrics strike due north. Deformation within the country rocks are reported to intensify in vicinity of the break.

In this study area, only the Elise Formation is located on the southern side of the break. This unit is relatively massive, with abundant primary structures and lacks a pervasive foliation. Bedding strike northeast and dips steeply to the northwest parallel the likely orientation of the nearby thrust fault. Small scale folding has been observed with asymmetrical Z folds plunging southwest. This asymmetry support a tops to the east thrust movement sense.

The units on the north side of the break include the Record Ridge Ultramafic, the Marron volcanics and the Coryell Batholith. The ultramafic has a widely anastomosing fabric defined by zones of serpentinization. The various contacts of this unit with those surrounding, are described as faults of varying degrees. These faults have likely formed as a result of movement along the Rossland Break because of competence contrasts with units of very different structural properties or alternatively, during volume increase associated with serpentinization of the ultramafics. The Marron volcanics are relatively massive, with abundant primary structures and lack a pervasive foliation. Marron volcanics generally strike to the north and dip moderately to the west. The Coryell batholith is massive with no distinctive ductile fabric, but it does have a highly fractured brittle fabric (Fyles, 1984).

The Rossland Break likely represents an original thrust fault formed during the accretion of the exotic terrains and has been reactivated as a normal fault during the extensional tectonics of the tertiary. This condition has been recognized in a number of places throughout the region. This break also forms a noted truncation to the occurrences of Tertiary intrusives and volcanics, as none are found to the east of it.

5.3 Significant Mineralized Zones

Mineralization containing economically significant concentrations of Mg is known to occur in the ultramafic rocks which have undergone serpentinization. This rock type makes up the predominant lithology described at the Project, and occurs widespread. Lower concentrations of Mg within the serpentinite are present in dioritic intrusive rocks and lenses of andesite/gabbro.

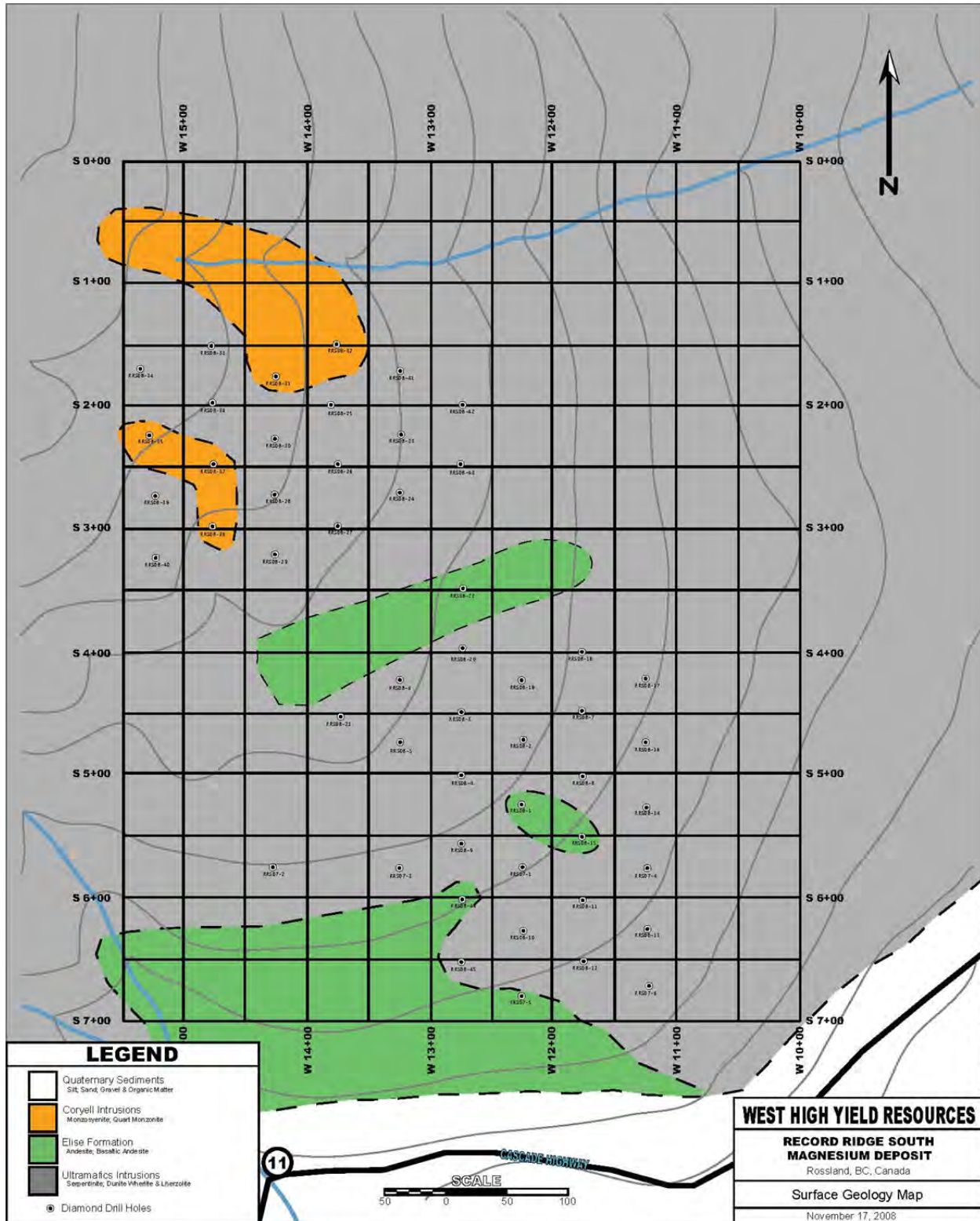

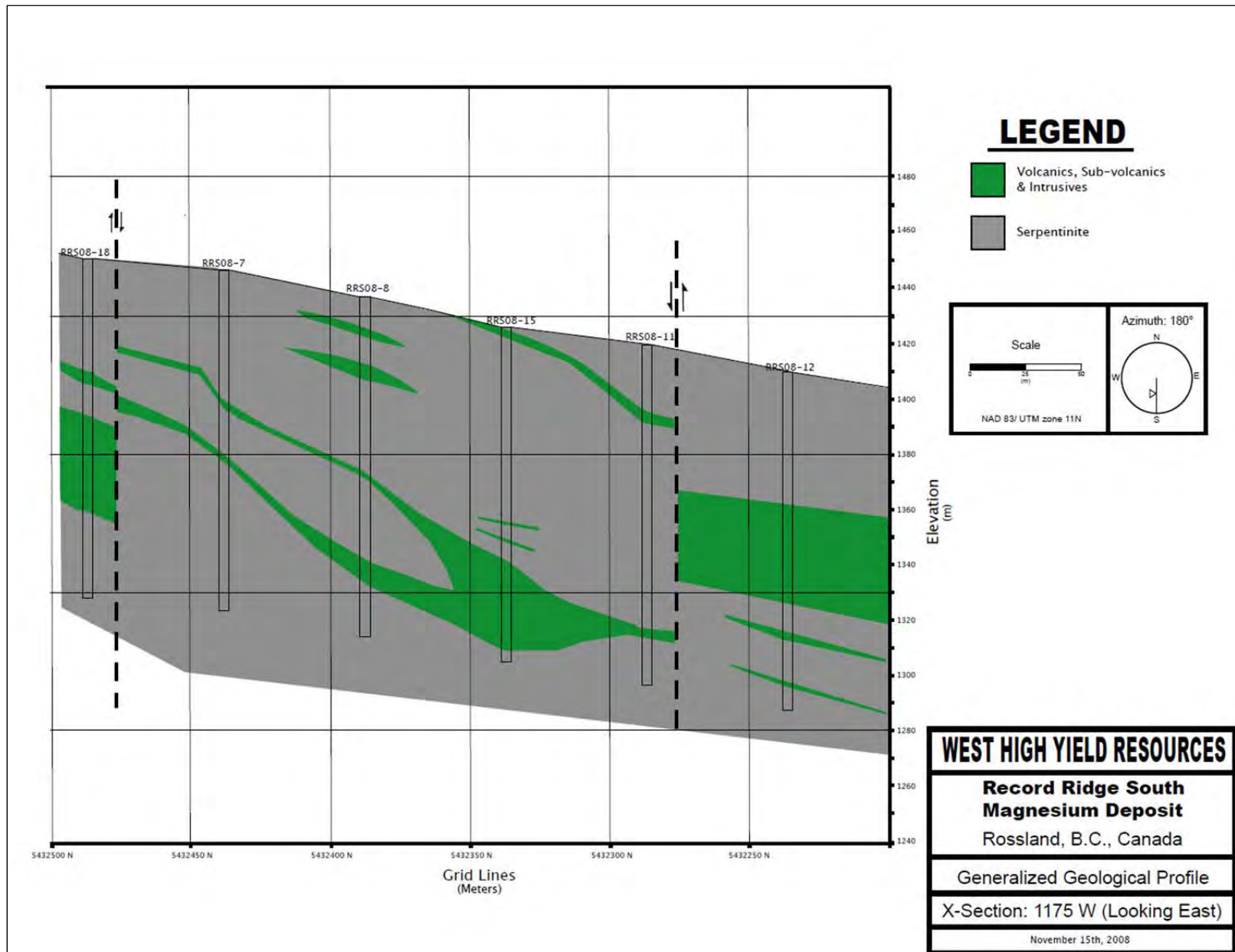

6 Deposit Type (Item 8)

6.1 Mineral Deposit

The principal commodity of this report is magnesium hosted within ultramafic rocks. There are three major categories used to classify ultramafic complexes. These include; Alpine, Alaska and Layered Intrusives (Voormeij and Simandl, 2004).

Alpine type ultramafic complexes are interpreted to represent obducted ophiolitic suites. These originated as oceanic crust at a spreading center and have distinctively layered characteristics. The basal portion consists of cumulate peridotites, overlain by cumulate gabbros, overlain by plagiogranites, overlain by mafic dike swarms and capped with pillow basalts. As a result of tectonic shortening, they have been emplaced over crystalline basement. The dense nature of the bodies allows relatively intact transport, although complete complexes are rarely found. Serpentinization frequently occurs during deformation and subsequent metamorphism. These bodies commonly have a lens or augen shape bound by ductile faults planes. Due to the compositional layering they also possess distinctive, large scale chemical zonation.

Alaska type ultramafic complexes are interpreted to represent mafic-ultramafic intrusives. These are characterized by a crude concentric compositional zonation. Their cores are composed of nearly pure dunite, surrounded by successive wehrlite, clinopyroxenite and hornblende amphibolites. These are believed to have formed as a result of oceanic crustal subduction, resultant melting and magmatic emplacement. Although these complexes are commonly found in highly deformed terrains, they have not necessarily been transported by tectonic processes. The bodies are generally pod shaped and may have been serpentinized to varying degrees during deformation.

Layered Intrusive mafic-ultramafic complexes are typically sill or funnel shaped. These complexes generally form at rift centers within cratons and can be associated with tholeiitic flood basalts. Magmatic crystallization and resultant differentiation forms a distinctive cyclic layering. The basal portion is composed of dunite overlain by harzburgite and topped by orthopyroxene. Generally, these are large bodies with only minor tectonic deformation.

In British Columbia, both Alpine- and Alaska-type ultramafic complexes are found. The generalized geologic setting is depicted in Figure 6-1. Well known examples of Alpine-type include the Nahlin, Cache Creek and Shulaps Complexes. Other well described occurrences of the Alpine-type within the United States include deposits in Vermont, Pennsylvania, Maryland, western North Carolina, and Puerto Rico. These deposits are all interpreted to have been enriched in Mg during prograde metamorphism of serpentinized peridotite originating from the basal portions of an ophiolite protolith (Goff, et al; 2000).

Well known Alaska-type include the Polaris, Tulameen and Turnagain Complexes. These are all located within Intermontane Belt and specifically within only two terrains, the Stikina and Quesnellia. All have reliable age dates ranging from mid Triassic to early Jurassic and are associated with volcanic island arc rocks of similar age (Nixon et al, 1997).

6.2 Geological Model Applied

The ultramafic body found at Project is interpreted to represent an Alaska-type ultramafic complex. This ultramafic body is based on the compositional characteristics, general geometry and contact

and age relations with surrounding rock types. The primary units of composition of dunite and wehrlite provide good evidence to support this interpretation. The closest, well-documented Alaska-type ultramafic is the Tulameen Complex located 200 km to the east. This has been dated as late Triassic-early Jurassic (Nixon et al, 1997). SRK is of the opinion that this model for the geology of this deposit is reasonable and will aid the company going forward.

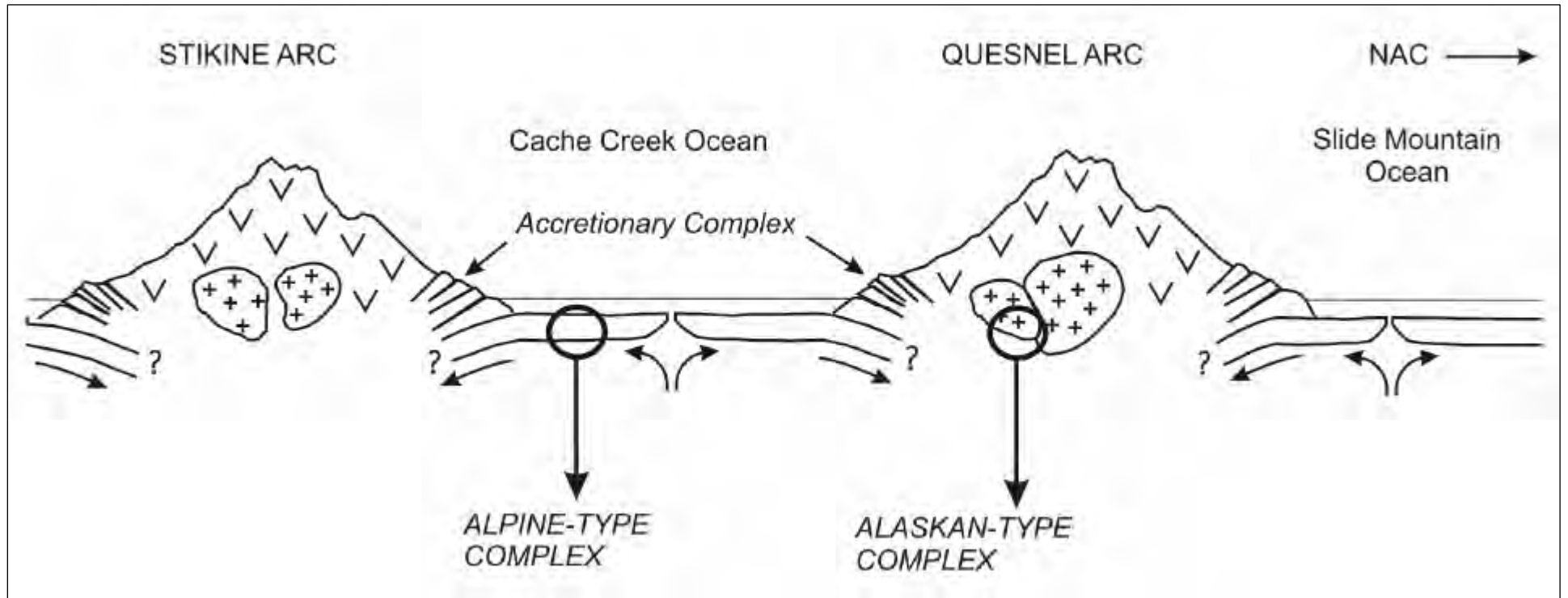

7 Exploration (Item 9)

7.1 Surveys and Investigations

During the 2007, 2008 and 2011 field seasons, WHY conducted surface mapping, surface sampling and diamond drilling on the Project. The surface mapping was conducted at a 1:2,500 scale focused on the ultramafic rocks. Samples were collected from outcrop and analyzed by Inductively Coupled Plasma-Atomic Emission Spectrometry (ICP-AES) for 24 elements. A total of 30 samples were collected and analyzed. The results of this work delineated a high Mg anomaly located in the east flank of the Record Ridge, presumed to lie above the serpentinite unit. The Project resource estimation is based on information from 77 diamond core drillholes totaling 10,310 m, with 5,836 assays. These were carefully logged, sampled and tested with 24-or 32-element ICP-AES analysis.

7.2 Significant Results and Interpretation

The exploration work conducted by WHY meets current industry standards. The exploration drilling program is of appropriate type, it was well planned and carried out in a prudent and careful manner. All drill core logging and sampling has been done by trained and professional personnel. WHY has made a concerted effort to ensure good sample quality and has maintained a careful chain of custody and ensured sample security from the drill rig to the assay laboratory.

8 Drilling (Item 10)

8.1 Type and Extent

Drilling at the Project was conducted in three phases. The first was in 2007, the second in 2008, and the third in 2011. To date, 77 diamond core holes have been completed for a total of 10,310 m (Figure 8-1). The drillholes from the 2007 and 2008 programs are arranged on a staggered grid pattern with 50 m spacing. Drilling from the 2011 program was laid out on roughly 100 m centers and was conducted predominantly to the northwest of the earlier drilling.

8.2 Procedures

A drilling grid was first laid out by Hango Land Surveyors of Castlegar, B.C. The northing, easting and elevation of each grid point are referenced to the particular site. Once the grid point is chosen for drill testing, it is referenced to back sites and a drill pad is constructed using a tracked excavator. After the pad is completed, the grid point is re-established from the back sites. If the point cannot be re-established at the original location, the amount of offset is recorded. Since all drillholes are oriented vertically, no line-up stakes are required. Drillhole collars are surveyed using high-resolution sub-meter accuracy GPS (Trimble GPS Pathfinder PROXRT Receiver) again after the drilling is complete, and these coordinates are logged into the database.

All drilling was conducted by West Kootenay Drilling a private drilling contractor using a Boyles Brothers Discovery II B20 wire line core drill. Typically, the overburden in the resource area is very thin and only a short section of casing is required. All holes are collared with an NQ diameter bit and generally, they are not reduced. The drilling rig operated 50 hrs/week with typical progress of 7 m/hour. Downhole survey readings are taken once the hole has been completed. A single reading is typically taken at the bottom of the drillhole using a REFLEX EZ-SHOT™ instrument. Due to the short nature of the drillholes a single deviation reading is considered adequate. Upon completion of each hole, WHY marks the collar with a wooden stake, 1.5 m tall and 5 cm in diameter. The stake is painted and the hole identification is labeled with a black marker as well as an aluminum tag stapled to the post. There is no hole-abandonment procedure required in British Columbia.

During the drilling operation, the core is retrieved from the core barrel and laid sequentially by the drilling contractor into wooden core boxes. The core is then washed and interval blocks are placed at all run breaks. Once the box contains approximately 5 m of core, the ends and sides are labeled with drillhole identification, from and to intervals and the sequential box number. The box is then covered with a wooden lid and stacked at the drill rig to ensure that the core is not exposed to any potential contamination or mix-ups. At the end of each drilling shift, the boxes of core are transported by the drilling contractor in a pickup truck to the WHY field office. At this point, the core is in the custody of WHY.

8.3 Interpretation and Relevant Results

The drilling has been conducted by a reputable contractor using industry standard techniques and procedures. This work has defined two zones of high magnesium within the ultramafic rocks. The two zones have been intersected by approximately 77 drillholes down to an average depth of 135 m below surface and remain open in all directions and at depth. The northwest zone has a north-south elongate tabular shape measuring about 700 m x 350 m with an average thickness of approximately

130 m thick. The southeast zone has a circular tabular shape 325 m in diameter with an average thickness of 120 m. For the most part, the shapes of the two zones are defined by the extents of the drilling. The drillholes are all oriented vertical and the regional fabric of the ultramafic is interpreted to be gently southeast dipping to horizontal based on the orientations of the volcanic lenses and intrusions. Therefore, SRK is of the opinion that the drill intercepts do represent an approximate true thickness of the mineralization.

SRK is of the opinion that the drilling operations were conducted by professionals, the core was handled, logged and sampled in an acceptable manner by professional geologists, and the results are suitable for support of a NI 43-101 compliant resource estimation.

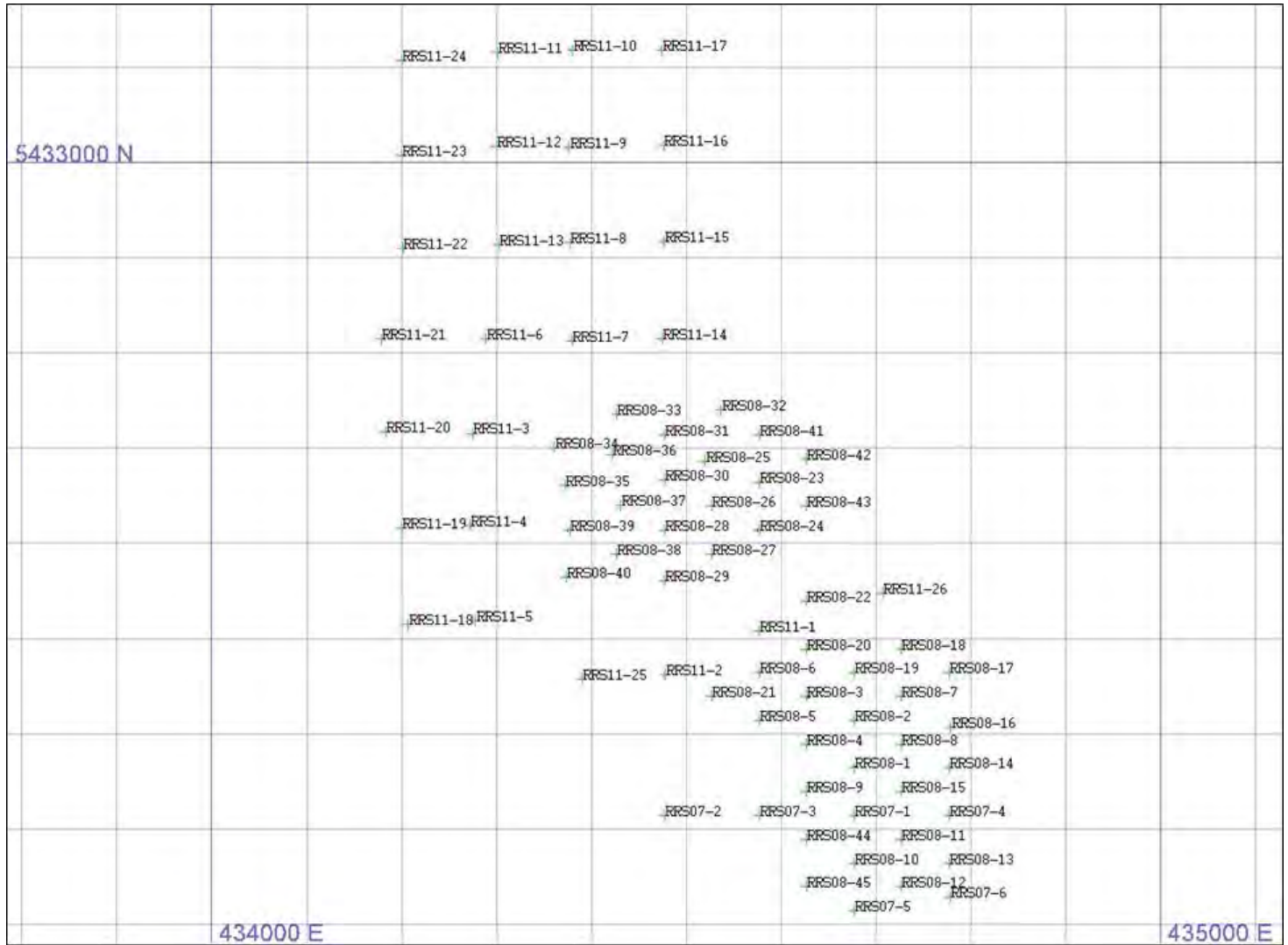

9 Sample Preparation, Analysis and Security (Item 11)

9.1 On Site Sample Preparation and Security

Upon receipt from the drilling contractor, WHY transports the core by pickup truck from their in-town office, to a processing facility located at Midnight Camp, approximately 3 km away. The facility is located at the end of dead end road behind a locked gate. Here the core is unloaded and arranged sequentially from top to bottom. It is first logged for lithology and then for geotechnical properties. Geologic and geotechnical logging is done in notebooks with primary emphasis on the lithology of the rocks. The specific gravity of the core samples was measured using a scale and graduated cylinder. Next the rock quality was determined using the Q-system ($Q=(RQD/ J_n) * (J_r/ J_a) * (J_w/SRF)$), where RQD= Rock quality designation; J_n = Joint set number; J_r = Roughness of the most unfavorable joint or discontinuity; J_a = Degree of alteration or filling along the weakest joint; J_w = Water inflow; SRF= Stress reduction factor. WHY personnel also record hardness and weathering to aid in geotechnical parameters for the future mine design.

Sample intervals are then determined by the geologist and marked on the core and the core boxes. The ultramafic and serpentinite lithologies are generally sampled at nominal 2.0 m intervals. In cases of unmineralized rock, sample lengths can be as much as 3.0 m. The sample intervals are recorded in three places; the logging notebook, the sample booklets and on aluminum tags stapled to each interval on the boxes. After the sample intervals are marked on the core boxes, the core is photographed in natural light, four boxes at a time.

The core is sawn in half by a diamond saw. No cut lines are marked on the core since drilling is generally at a high angle to contacts and lithology is relatively homogenous. Half of the 1.5 m cut core is then placed into a pre-labeled plastic bag. The bag also contains a sample identification tag with a blind sample number. Each bag is immediately stapled closed. A master list is maintained which records the drillhole identification and from-to intervals of all sample tags. The remaining half of the core is returned to the box for archive. The archive boxes of half core are then moved to secure, metal freight containers that are located at the facility (Figure 9-1). The core is sorted by drillhole and sequential box number and a master inventory list is maintained for each storage container.

The individual plastic sample bags containing the core samples are accumulated five at a time, into heavy-duty rice sacks. WHY places the rice bags onto a wooden pallet and then shrink wraps the sides and top of the pallet so that no tampering can occur. A sample transmittal list is compiled at this stage. The pallet and list are then transported by WHY to West Arm Truck Lines at 1077 Columbia Rd, Castlegar, B.C. Here the samples are secured in a locked garage until West Arm Trucking transports them to the commercial laboratory by standard transport truck.

WHY has rigorous security measures in place to prevent any tampering of the core or samples before and during the transport process. These measures include redundant sample identification, appropriate sample bag closures, shrink-wrapped core shipment, and locked core storage. SRK is of the opinion that these measures are consistent with or in excess of current industry best practices for projects at this scale of exploration.

9.2 Laboratory Sample Preparation and Analysis

9.2.1 2007 and 2008 Drilling

During the 2007 and 2008 programs, all of the half core samples were delivered to Assayers Canada (AC) for sample preparation and analysis. Upon arrival, the samples are unpacked and arranged in order; which are then logged into the system by sample identification number. Each sample bag is emptied into a clean metal sample tray and placed into a drying oven at 60°C for approximately four hours. The samples were then run through a primary jaw crusher and then a secondary cone crusher to produce a product with specifications of 60% less than 10 mesh in size. The sample was then blended and run through a Jones riffle splitter to produce a 250 g subsample. The reject material is returned to the original sample bag and archived. The 250 g subsample was next run through a ring pulverizer to produce a product with specification of 90% less than 150 mesh. The crushers, splitter and pulverizers are blown clean with an air hose after every sample and the sample preparation room is equipped with a dust collection system. The blind sample tag accompanies the sample at each stage of preparation.

The samples were analyzed by AC using ICP-AES for a suite of 24 elements. A 0.2 g portion of the pulp sample is first placed into a test tube and dissolved using a four acid compound containing nitric-perchloric-hydrofluoric-hydrochloric acids.

9.2.2 2011 Drilling

Two labs were utilized for sample preparation and analysis during the 2011 drilling. Initially, primary samples were shipped to SGS Laboratories (SGS), and the check assayer was ALS Chemex (ALS). During the second half of the program, these labs essentially reversed roles, with ALS taking over as the primary laboratory role and SGS becoming the check assayer. A third lab (ACME) was utilized for selected QA/QC checks during the latter half of the program. Both labs are located in Vancouver, B.C., Canada. The break-down of the samples shipped to each lab are shown in Table 9.2.2.1.

Table 9.2.2.1: 2011 Sampling by Laboratory

Primary Laboratory	Check Laboratory	Drillholes	Samples
SGS	ALS Minerals	RRS11-01 thru 10	800
ALS Chemex	SGS & ACME	RRS11-11 thru 26	1268

SGS Procedures

The SGS samples were prepared according to the PRP89 method, as stated in their analytical procedure. The sample is logged into the SGS system at the time of arrival. The samples are then dried at 100° C ±10°C for 24 hours, if received wet or client specified. The sample is then crushed to reduce the sample size to 2 mm (10 mesh Tyler). The sample is then split via a riffle splitter or Stand Alone Rotating Sample Divider (SRSD) in order to reduce to a 250 g sub-sample for analysis. The remaining sample is stored as a reject. Finally, the sample is pulverized using pots of hardened chrome steel or agate ceramic (mortar and pestle) placed into a vibratory mill. Samples are pulverized to 85% passing 75 micron 200 mesh or otherwise specified by the client (SGS, 2012).

Samples are fused using Sodium peroxide in zirconium crucibles and dissolved using dilute HNO₃. The sample solution is then analyzed by ICP-AES compared against known calibration materials to provide quantitative analysis of the original sample. The change in laboratories occurred after SGS

was considered by WHY to be underreporting Mg values in a number of samples. The difference was found to be approximately 2.5% under what ALS was reporting in the duplicate check samples.

ALS Procedures

The samples delivered to ALS were prepared according to the PREP-31 method described in their analytical procedure. The sample is logged in the tracking system, weighed, dried and finely crushed to better than 70% passing a 2 mm (Tyler 9 mesh, U.S. Std. No.10) screen. A split of up to 250 g is taken and pulverized to better than 85 % passing a 75 micron (Tyler 200 mesh, U.S. Std. No. 200) screen. This method is appropriate for rock chip or drill samples.

A prepared sample is digested with nitric, perchloric, hydrofluoric, and hydrochloric acids, and then evaporated to incipient dryness. Hydrochloric acid and de-ionized water is added for further digestion, and the sample is heated for an additional allotted time. The sample is cooled to room temperature and transferred to a volumetric flask (100 ml). The resulting solution is diluted to volume with de-ionized water, homogenized and the solution is analyzed by ICP-AES. Results are corrected for spectral interelement interferences (ALS Minerals, 2012).

A typical atomic absorption spectrometer consists of an appropriate light source (usually a hollow cathode lamp containing the element to be measured), an absorption path (usually a flame, but occasionally an absorption cell), a monochromator (to isolate the light of appropriate wavelength) and a detector. The most common form of atomic absorption spectroscopy is called flame atomic absorption. In this technique, a solution of the element of interest is drawn through a flame in order to generate the element in its atomic form. At the same time, light from a hollow cathode lamp is passed through the flame and atomic absorption occurs. The flame temperature can be varied by using different fuel and oxidant combinations; for example, a hotter flame is required for those elements which resist atomization by tending to form refractory oxides.

In the opinion of the authors, the analytical methods used to determine the magnesium content of the Project samples are appropriate to support the current resource estimation. However, SRK suggests that future analytical work be performed by one lab using the multi-acid total digestion and the ICP-AES methods.

9.3 QA/QC Procedures

9.3.1 2007 and 2008 Drilling

For the 2007 and 2008 sampling, the QA/QC program consisted of two types of duplicate samples, both sent to a referee laboratory for analysis. The first type consists of duplicates comprised of $\frac{1}{4}$ core cuts, which were bagged and sent to ALS for sample preparation and analysis by ICP-AES. WHY submitted 83 intervals of mineralized samples for this type of check analysis. The second type of QA/QC consists of lab duplicates from pulps prepared by Assayer Canada and sent to ALS for check analyses. WHY submitted 37 intervals of mineralized samples for this type of check analysis.

The results of the duplicate check samples showed reasonable correlation between the two laboratories. The $\frac{1}{4}$ core field duplicates produced an overall positive correlation between the two laboratories with AC reporting magnesium on average, 5.2% higher than ALS (Figure 9-1). The laboratory pulp duplicates produced similar results with a slightly better correlation between the two labs with AC reporting magnesium on average, 3.7% higher than ALS (Figure 9-2). Because WHY did not include any standard reference material with the samples sent to either laboratory it is

impossible to determine the precision of the assays. The deviations seen between the two laboratories are at or below the analytical tolerance of the testing equipment and therefore are not material to the resource estimation on this report.

An additional assay check was conducted on a single drillhole completed in 2007 by way of metallurgical test work completed by Met-Solve. In this case, a 5.1m sample was composited from coarse rejects produced by AC. The weight-averaged assay of the composite as reported by AC was 26.1% Mg. Met-Solve blended and milled the sample and then performed head assays on five sample splits for their metallurgical test work. The Met-Solve results ranged between 23.2 to 25.0% Mg with an arithmetic average of 24.2% Mg. These results are 7.5% lower than the weight average calculated from the AC data.

Specific gravity QA/QC was also conducted by duplicate checks of core samples. ALS conducted density measurements on 12 samples also tested by WHY. The scatter plot of results shown in Figure 9-3 demonstrates a general trend of agreement between the two determinations.

During 2007 and 2008, WHY did not insert any blank samples or standard reference material into the sample stream. Although this has negative impacts on the reliability of the analytical results, it is not considered material to the resource estimation.

9.3.2 2011 Drilling

For the 2011 drilling program, WHY applied different QA/QC measures than those used in 2007 and 2008. Three different control sample types were used during this program including; lab check samples, field duplicate samples and quartzite blanks. Again, no standard reference material was inserted into the sample stream to qualify the accuracy of the labs to a known value.

Lab check samples were inserted at a rate of 1 in 20 samples and were comprised of core samples that were split with one half going to the primary lab and the second half going to the check lab. The purpose of these control samples is to compare the prep and analytical methods of multiple labs using identical samples. The results of this comparison are shown in Figure 9-4. Of the 103 lab check samples, four samples are more or less than 20% from the expected correlation. This failure rate is considered acceptable by SRK, especially considering that two of the extreme outliers likely represent switched samples.

Field duplicate samples consist of two identical samples from the same interval that are designated for duplicate assay. These samples are core splits with the second half-core split inserted at the end of the hole in order to get a second assay of the same rock interval for comparison. Because it is unbeknownst to the assay labs, it is considered a good check for consistency and accuracy within a lab. The results of this comparison are shown in Figure 9-5. Of the 30 samples submitted for this type of QA/QC, two are more than 20% less than the expected correlation. This failure rate is considered acceptable by SRK, as WHY has suggested that these samples were likely incorrectly labeled or switched.

Quartzite blanks were inserted at a rate of 1 in 20 samples and consisted of barren crushed quartzite rock samples. These control samples were designed to check for contamination during lab procedures. Quartzite for these samples was purchased from *Kootenay Stone Center* in Salmo, B.C., and is thought to contain very few contaminants. However, the definition of a blank is a sample that contains none or negligible amounts of the primary element in question. For the 2011 drilling, WHY inserted 104 quartzite blanks into the sample stream. The results showed the blanks contain

an average of 0.29% Mg. Two high outliers were identified one with 7.41% Mg and another with 0.8% Mg. Generally, the criteria for assessing the performance of blanks include a comparison of the assay values against a benchmark of some multiple of the lower limit of detection, 0.01% in this case. Using criteria of 5x the lower limit of detection (0.05% Mg), only 7 samples (6.7%) pass this test. Using criteria of 10x the lower limit of detection (0.1% Mg), a total of 33 samples (31.7%) pass. Based on these results, SRK is of the opinion that there are two possible interpretations from the blank data. The first is that it is possible that the blank material used is, in fact, not barren and contains detectable Mg. The second is that there are some contamination effects either during the prep or analysis. Finally, the data also suggests that the SGS analytical method had a lower failure rate and consistently lower assays than the ALS technique. The results of this comparison are shown in Figure 9-6. SRK is of the opinion that the Mg detected in the quartzite blanks is not material to the resource estimation.

9.4 QA/QC Failure Actions

There were essentially no actions taken subsequent to QA/QC failures, as WHY has not established written criteria for failure in duplicates or blanks. SRK has superimposed a $\pm 20\%$ failure on the duplicate QA/QC samples submitted, and a limit of 5 times the lower limit of detection for the blanks. Generally, the procedure for failures begins with re-analysis of the batch in which the failure occurred. If the control samples still fail, other issues might be considered such as sample mix-ups, lab errors, and data entry/recording mistakes. SRK is of the opinion that the duplicate QA/QC samples submitted by WHY to the primary and check labs fall within an acceptable range of failures.

Duplicate check samples submitted to ALS during the initial phase of the 2011 were thought to be of slightly higher grade on average than those comparable samples submitted to SGS, resulting in a change in primary laboratory. An XY comparison of the lab duplicate QA/QC values prior to the lab changeover is shown in Figure 9-7. These samples show relatively good correlation compared to the precision of the analysis. SRK is of the opinion that the analyses performed by each lab are appropriate and adequate for direct comparison. The change in laboratory does not effectively imply that there is any significant change in the quality of the data with respect to which lab was considered the primary analytical lab over the course of the 2011 program.

9.5 Opinion on Adequacy

The sampling techniques and analytical procedures employed by WHY are adequate for the current level of study. Core drilling is an excellent method to obtain high quality geologic data and the high core recoveries realized here also produce an excellent sample for analysis. Half core sampling is a standard procedure and WHY has ensured that all samples were tracked by an accountable chain of custody. The ICP-AES analysis is a preferred method of analysis for magnesium producing a $\pm 5\%$ level of accuracy at the Mg concentrations present. Although Assayer Canada (AC) is not an ISO certified laboratory, the check samples run at ALS Minerals produced similar results within the $\pm 5\%$ level of accuracy expected. Subsequent analyses during the 2011 drilling program were performed by ISO certified laboratories.

The primary limitation of ICP-AES is that all measurements are made following chemical dissolution of the element of interest. Therefore, the measurement can only be as good as the quality of the sample digestion. A second limitation is that occasionally, interferences from other elements or chemical species can reduce atomization and depress absorbance, thereby reducing sensitivity. For

these reasons, most reputable laboratories recommend that ICP-AES not be used for reserve estimations or bankable feasibility studies. There is a contradiction here, however, with respect to magnesium. Most reputable laboratories also state that ICP-AES is the preferred and most accurate method of analysis for magnesium. At grades in the range of 20 to 25%, the accuracy of a magnesium analysis by ICP-AES is reported to be $\pm 5\%$. This accuracy can be improved slightly by a specialty analysis targeting only magnesium at a material grade concentration (ALS Minerals, 2012).

The QA/QC procedures employed by WHY are adequate for CIM guidelines to resource estimation however, there are certain areas of inadequacy. There remains a total absence of certified reference materials inserted into the sample stream. This QA/QC measure ensures the precision of the analytical laboratory and adds another level of confidence to the analyses supporting the resource and reserve estimates. This measure is arguably the most critical form of QA/QC and is standard industry procedure in even the earliest-stage exploration projects. SRK reiterates the earlier recommendation from 2009 that this become a part of the QA/QC at WHY. Additional QA/QC measures were employed by WHY during the 2011 drilling and have shown that while the failure rates are generally low for duplicates, there is room for improvement in the QA/QC. This particularly pertains to sample labeling and blank contamination, as described in the previous sections. Also, WHY has not utilized standard procedures of sample batch re-runs for the handling of QA/QC failures. These aspects of the exploration work need to be improved in the future. Regardless, it is unlikely that given the geologic homogeneity of the deposit and consistency of the deposit Mg grade will be influenced by a few erroneous samples or high-grade outliers. SRK is of the opinion that this reduces the need for the stringent QA/QC measures and actions that might be required in more erratic metal deposits.

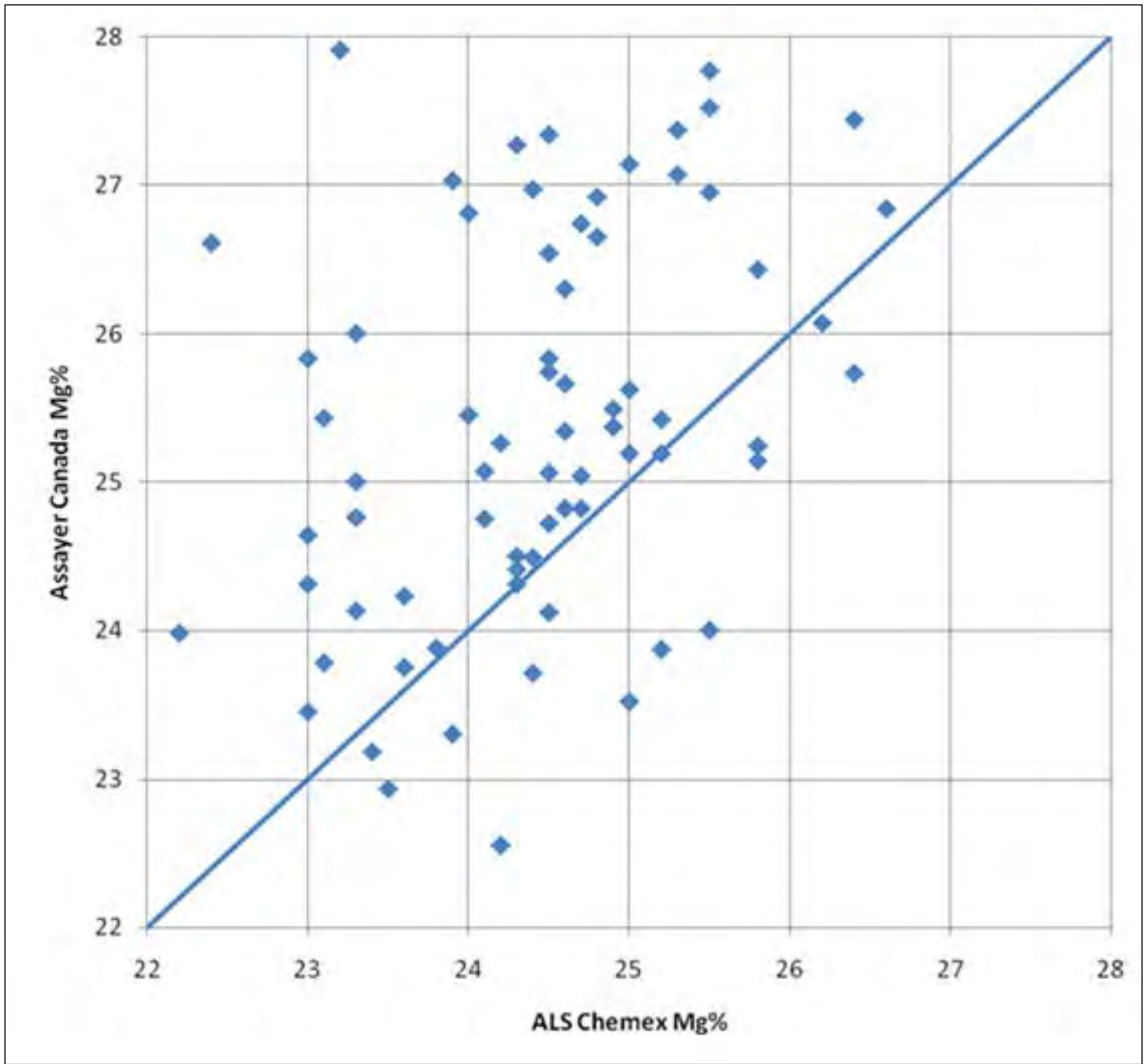

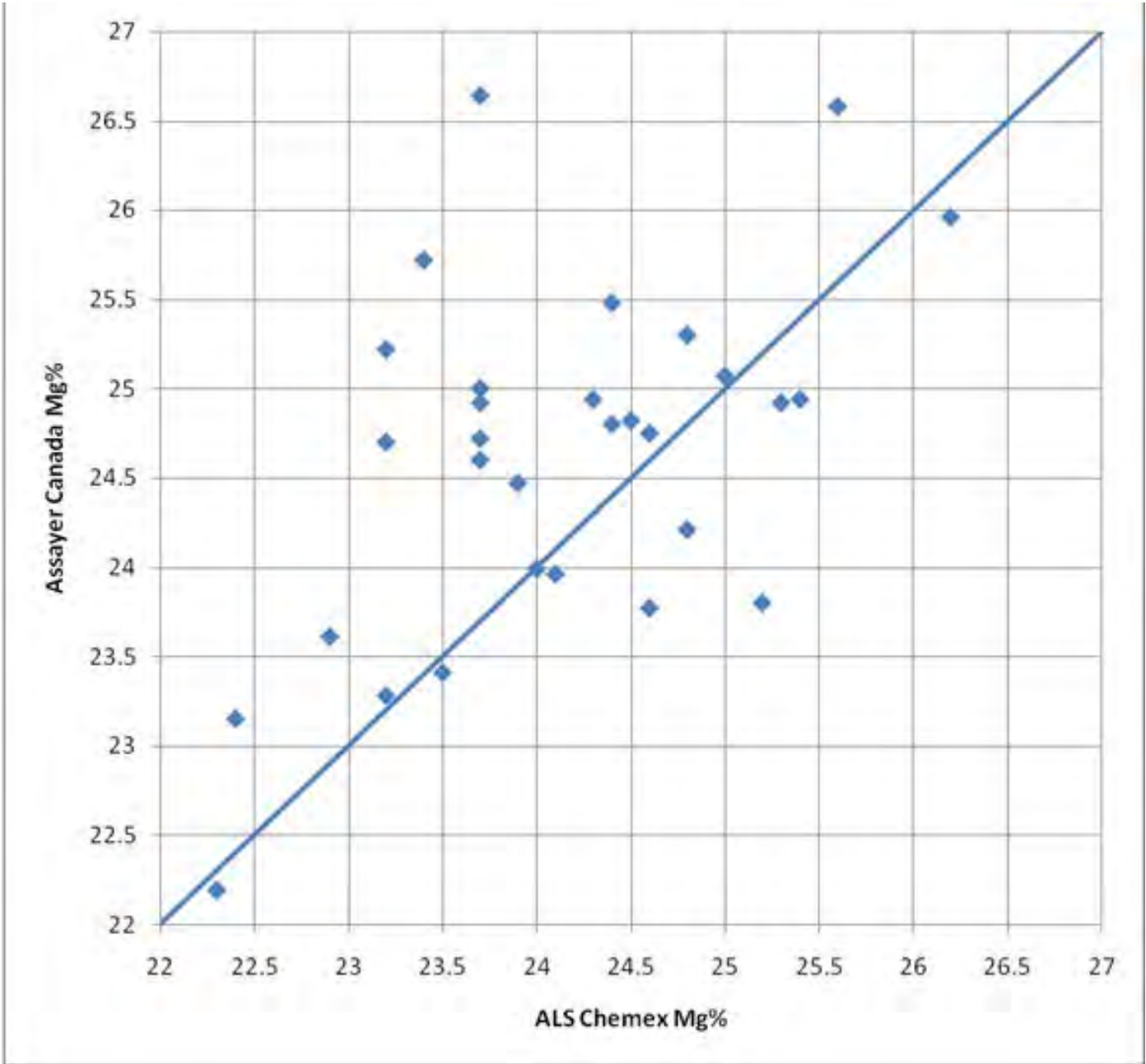

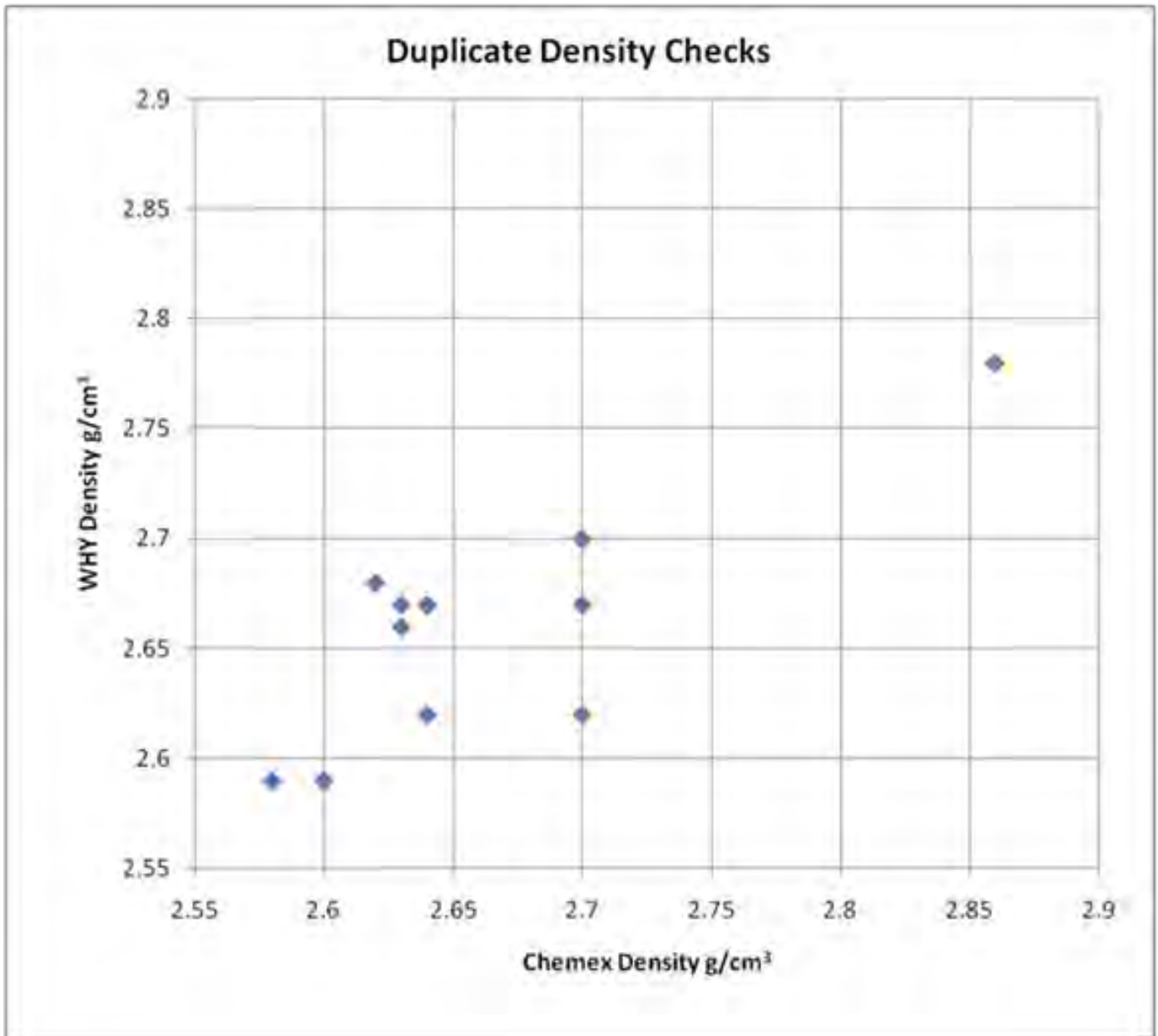

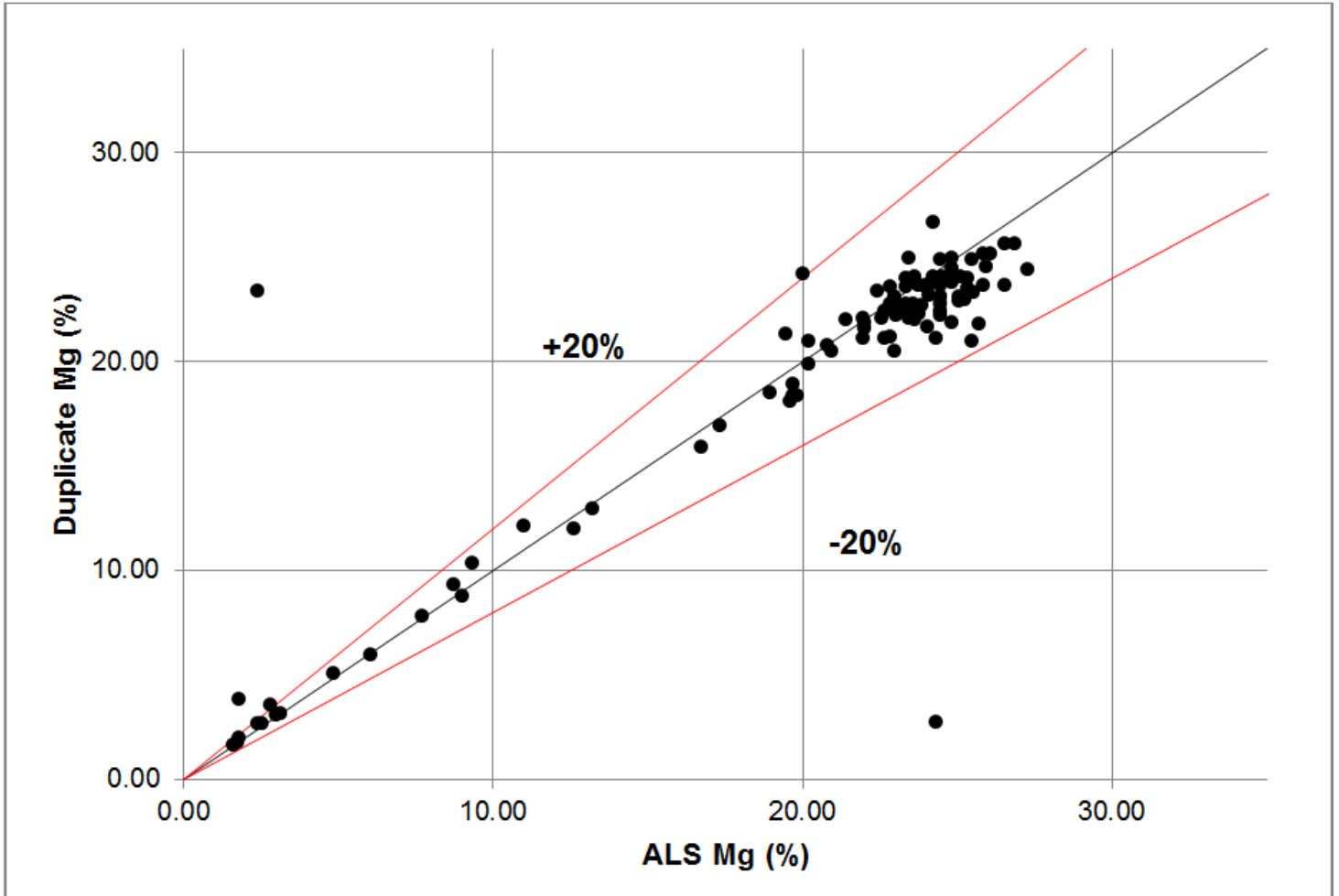

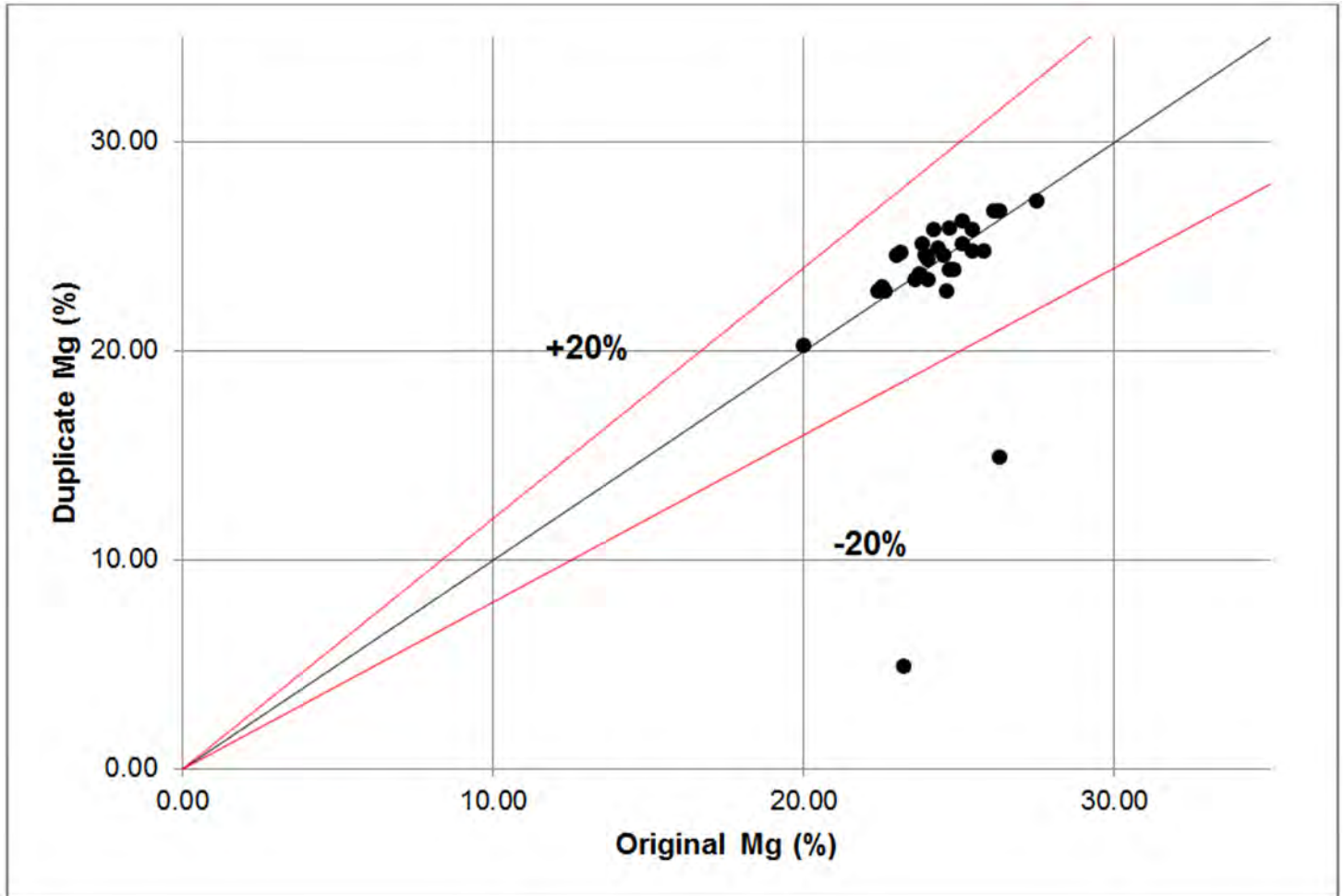

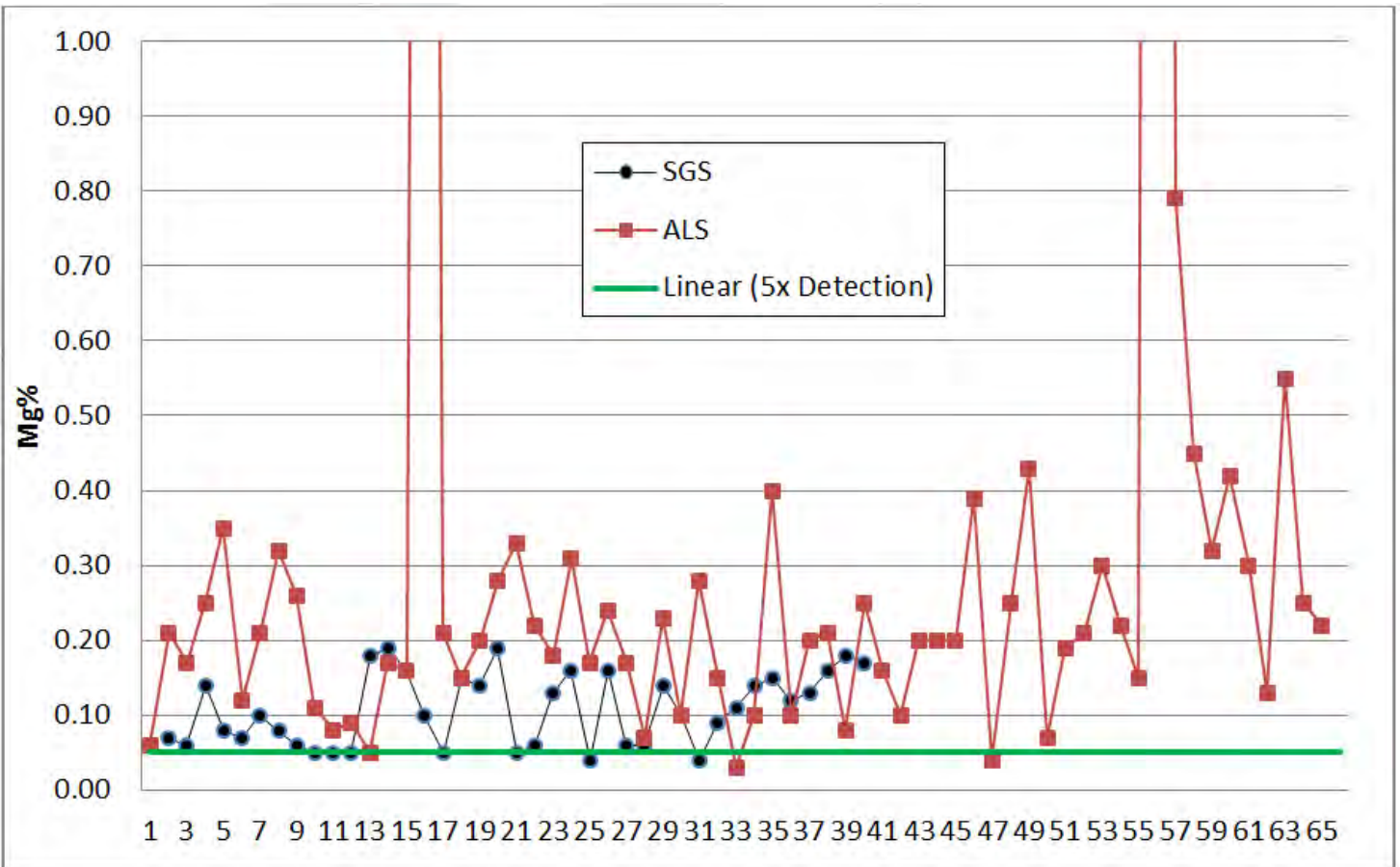

**SGS vs. ALS Mg %
Holes RRS11-01 thru RRS11-09**

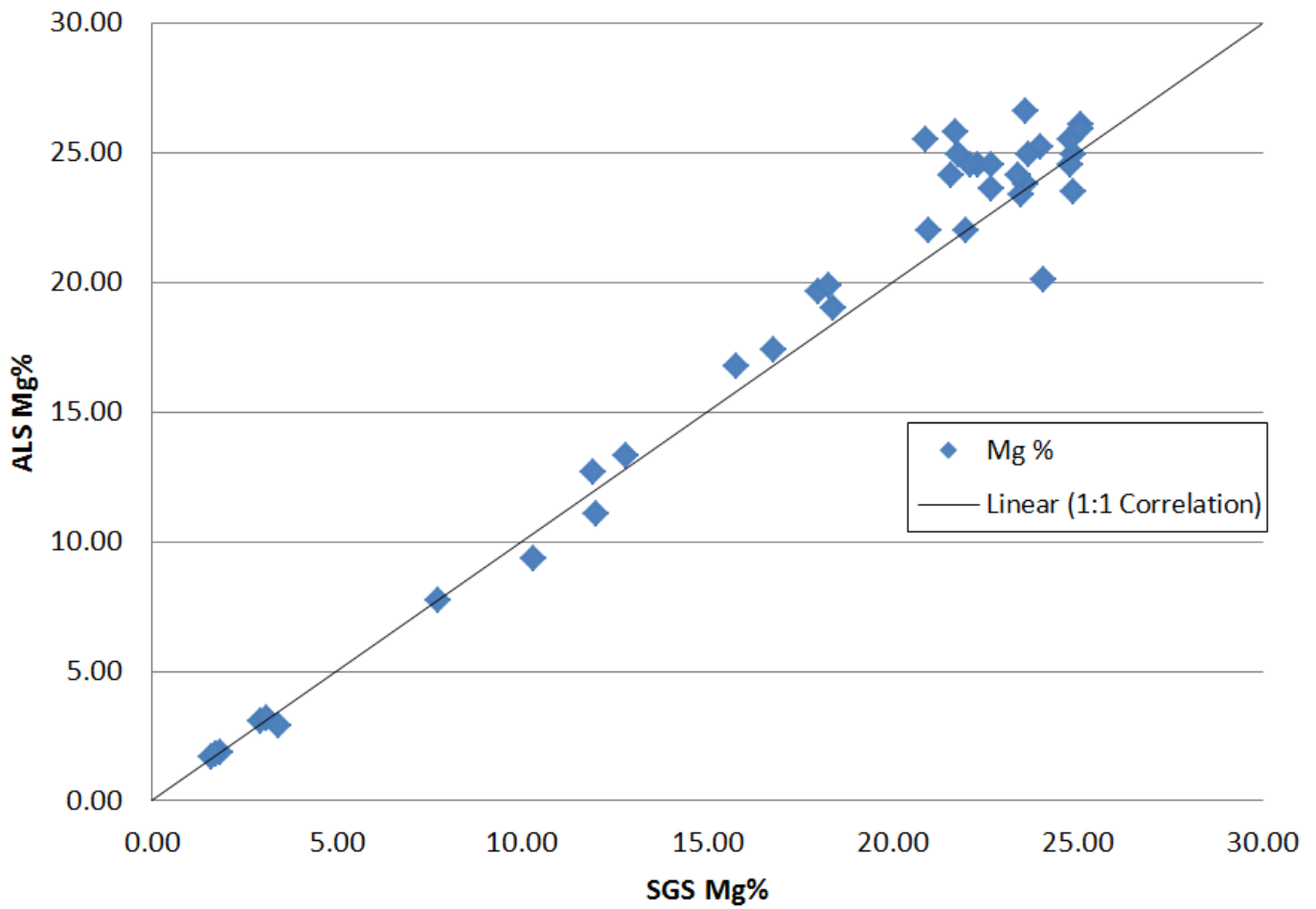

10 Data Verification (Item 12)

10.1 Procedures

SRK checked the coordinates of three drill holes via handheld GPS while on site. SRK notes that the drillholes are well-located with respect to each other, but that local differences with respect to the topography do exist. SRK suggests that this is due to a rather low-precision topographic survey being used at this stage, which is based on 30 m B.C. government topography, which is publicly available. SRK notes that this topography is sufficient for the current level of study, but has amended the 30 m government topography to include the surveyed drill collars as real data points. SRK recommends a more detailed topographic survey be conducted or purchased if available, prior to the next phase of study.

The database used for the resource estimate was constructed by SRK and is considered to be of good quality. The analytical database was constructed in a two-stage process. First, all of the blind sample numbers and their corresponding drillhole intervals were accumulated from MS Excel[®] files provided by WHY into an Access database table. This was checked for overlapping intervals and any errors were corrected. Next, all of the comma separated variable (CSV) analytical reports supplied by Canada Assayers were also accumulated into an Access data table. Next, a query function was used in Excel to merge each particular drillhole interval with the corresponding analytical results based on each unique sample identification number. This procedure allows for a comparison of original assay values to the database without the potential errors derived from data entry or mix-ups.

SRK evaluated 100% of the database and found six errors using this method. All of these errors were in relatively low-grade zones and appear to be related to data entry errors in the second decimal place. This represents a roughly 0.1% error rate compared to the 5,841 samples in the database.

The original signed, .pdf copies of the laboratory certificates were also spot verified to the final electronic assay database and no errors were found.

10.2 Limitations

SRK was not limited in its access to any of the supporting data used for the resource estimation or describing the geology and mineralization in this report.

The database verification is limited to the procedures described above. All mineral resource data relies on the industry professionalism and integrity of those who collected and handled the database.

10.3 Data Adequacy

SRK is of the opinion that appropriate scientific methods and best professional judgment were utilized in the collection and interpretation of the data used in this report. However, users of this report are cautioned that the evaluation methods employed herein are subject to inherent uncertainties.

11 Mineral Processing and Metallurgical Testing (Item 13)

11.1 Procedures

In support of this study, characterization of Record Ridge resource materials was undertaken by the Center for Advanced Mineral and Metallurgical Processing, a division of Montana Tech (CAMP). This report may be found in the appendices, as Appendix A. Met-Solve Laboratories also conducted scoping level testing for some comminution characteristics, as well as open cycle leaching, MgCO_3 precipitation and MgO calcination. No testing or production of fused magnesia was undertaken. This limited testing and several substantive assumptions are the basis for the presumed process. The Met-Solve Report may also be found in the appendices, as Appendix B. Further substantial detailed testing, optimization and analysis will be required to generate a more detailed flowsheet and to refine the actual technical and financial viability of the project.

11.2 Relevant Results

A metallurgical composite sample was generated from sampled drill core intervals within 51 drillholes, covering the lateral and vertical extents of the project mineralization. The sample was composited to cover not only the spatial representativeness of the projects, but also the average Mg grade of the deposit. The large bulk sample contained 180 intervals of drill core that averaged approximately 24% Mg, and two smaller composite samples were generated that featured both higher grade material (31.5%) and lower grade material (9.9%). The composite samples were shipped to Met-Solve labs for homogenization and were used in the mineralogical testing and metallurgical test work as described below. All testing refers to the large average grade metallurgical composite sample unless otherwise noted.

The Center for Advanced Mineral and Metallurgical Processing (CAMP) received one sample from the project on December 28, 2011. The sample was analyzed by MLA, XRD, lithium tetraborate fusion/ICP-AES analysis for bulk elemental analysis. The fusion/ICP-AES analysis was performed rather XRF for bulk elemental analysis. Serpentine was the main gangue mineral at 74.1% with lesser amounts of magnetite (FeO) at 9.08% and olivine at 7.92%. The high amount of serpentine/olivine, the presence of pentlandite, chromite, and the lack of quartz indicate that the sample came from a high temperature ultramafic source. Pentlandite was strongly associated with serpentine and occurred unliberated at the grind size studied. Grain sizes for pentlandite ranged from ~2 μm to nearly 70 μm with a P80 of approximately 55 μm . Chromite was relatively well liberated at the study grind size. When not liberated it was found associated mainly with the intermediate chromium-containing magnetite (FeO_{Cr}) phase and somewhat less associated with magnetite (FeO) and the gangue phase, serpentine. Chromite grains ranged from less than 10 μm up to over 100 μm with a P80 near 75 μm . XRD analysis correlated with MLA in determining that the major gangue phase was composed of hydrous magnesium silicates, serpentine and talc. Also, the presence of magnetite and olivine were supported. Bulk chemical analysis by fusion combined with ICP-AES was relatively consistent with the MLA-calculated values for the major elements magnesium, silicon, and iron. Chemical analysis of chromium was 0.38% and nickel 0.26%. MLA-calculated assay slightly overestimated the chromium; however, the nickel content was underestimated relative to the fusion results. The nickel disparity may have been the result of a low

MLA result for the nickel-bearing mineral pentlandite and/or the presence of nickel in chromite. Additionally, the nickel content of the pentlandite in the MLA-calculated may have been conservative. The MLA-calculated particle size analysis for the pulverized sample had a P80 of 100 µm with particles of <5 mm to nearly 250 µm.

Tables 11.2.1 and 11.2.2 illustrate the CAMP MLA mineralogical and elemental semi-quantitative analysis of the WHY materials that were analyzed.

Table 11.2.1: Resource Mineralogy

Mineral	Formula	Conc. (Wt%)
Serpentine	Mg ₃ Si ₂ O ₅ (OH) ₄	74.1
FeO	Fe ₃ O ₄	9.08
Olivine	(Mg,Fe) ₂ SiO ₄	7.92
Diopside	CaMgSi ₂ O ₆	1.54
Chlorite	(Mg ₃ ,Fe ₂)Al(AlSi ₃)O ₁₀ (OH) ₈	1.46
Chromite	FeCr ₂ O ₄	1.14
Mica	KAl ₂ (AlSi ₃ O ₁₀)(OH) ₂	1.01
Dolomite	CaMg(CO ₃) ₂	0.97
FeO_Cr	Fe ₃ O ₄ Cr _{0.5}	0.73
Magnesite	MgCO ₃	0.65
Plagioclase	(Na,Ca)(Al,Si) ₄ O ₈	0.32
Calcite	CaCO ₃	0.32
Corundum	Al ₂ O ₃	0.20
Pentlandite	(Fe,Ni) ₉ S ₈	0.16
Pyrrhotite	FeS	0.14
Biotite	K(Mg,Fe) ₃ (AlSi ₃ O ₁₀)(OH) ₂	0.13
Quartz	SiO ₂	0.034
K_Feldspar	KAlSi ₃ O ₈	0.028
Ilmenite	FeTiO ₃	0.027
Pyrite	FeS ₂	0.023
Sphene	CaTiSiO ₅	0.010
Rutile	TiO ₂	0.009
Chalcopyrite	CuFeS ₂	0.003
Apatite	Ca ₅ (PO ₄) ₃ F	0.002

Modal Semi Quantitative (CAMP)

Table 11.2.2: Resource Elemental Composition

Element	Concentration (Wt%)
Oxygen	47.7
Magnesium	21.3
Silicon	17.2
Iron	10.4
Hydrogen	1.10
Calcium	0.65
Chromium	0.60
Aluminum	0.51
Carbon	0.26
Sulfur	0.12
Potassium	0.12
Nickel	0.036
Titanium	0.016
Sodium	0.014
Copper	0.001
Phosphorus	P
Fluorine	P

Calculated Semi Quantitative (CAMP)

P- Present, but less than 0.001%

Met-Solve Laboratories Inc. was contracted by WHY Resources to conduct test work to evaluate the potential of using a hydrometallurgical process to extract the magnesium and convert it to a marketable product. The program was designed to evaluate the parameters which affect the amount of magnesium extracted via acid leaching, slurry neutralization and impurity removal. Metallurgical test work focused on optimization of the extraction process and improving the grade and purity of a magnesium oxide end product. A process flow sheet was developed to generate a high purity magnesium oxide product. The ICP-AES analysis of the materials testes is shown in Table 11.2.3.

Table 11.2.3: Met-Solve ICP-AES Analysis of WHY Resources Tested Material

Sample Description	ICP Au ppm	ICP Pd ppm	ICP Pt ppm	ICP Ag ppm	ICP Al %	ICP As ppm	ICP Ba ppm	ICP Bi ppm	ICP Ca %	ICP Cd ppm	ICP Co ppm	ICP Cr ppm	ICP Cu ppm	ICP Fe %	ICP Hg ppm	ICP K %
Head (P ₈₀ = 183 µm)				0.3	0.1	34	<10	3	0.46	<0.5	111	399	<1	3.72	<3	0.02
Head (P ₈₀ = 95 µm)				0.2	0.11	34	<10	<2	0.46	<0.5	113	480	8	4.08	<3	0.02
Head (P ₈₀ = 59 µm)	0.065	0.005	<0.005	0.2	0.11	30	<10	<2	0.46	<0.5	113	633	9	4.41	<3	0.02

Sample Description	ICP La ppm	ICP Mg %	ICP Mn ppm	ICP Mo ppm	ICP Na %	ICP Ni ppm	ICP P ppm	ICP Pb ppm	ICP Sb ppm	ICP Sc ppm	ICP Sr ppm	ICP Ti %	ICP Tl ppm	ICP V ppm	ICP W ppm	ICP Zn ppm	ICP Zr ppm
Head (P ₈₀ = 183 µm)	<2	24.0	762	2	<0.01	1747	23	<2	<2	5	37	<0.01	<10	6	<10	30	<2
Head (P ₈₀ = 95 µm)	<2	23.4	775	3	<0.01	1789	26	<2	<2	5	38	<0.01	<10	7	<10	32	<2
Head (P ₈₀ = 59 µm)	<2	23.7	787	4	<0.01	1809	47	3	<2	5	38	<0.01	<10	8	<10	29	<2

Prior test work at Met-Solve found that a large amount of acid was required to recover the magnesium and that leaching with sulfuric acid resulted in higher extraction compared to using hydrochloric acid. Hence, the test program focused on using sulfuric acid for the leaching test work.

For this test program, Met-Solve received 29 bags of average grade material, four bags of higher grade material and two bags of lower-grade material weighing approximately 15 to 20 kg per bag from: WHY Resources, 6 1995 Columbia Ave. Rossland, B.C., Canada. The bags contained drill core samples which were subjected to crushing, grinding and splitting. Only the average grade material was composited for the metallurgical testing. Grinding was carried out using a lab scale rod mill, with 24 stainless steel rods at a slurry pulp density of 40% to 50%. Four grind sizes of 228 µm, 183 µm, 95 µm and 59 µm were targeted for the test program.

The key areas of the Met-Solve test program are enumerated below.

- Head Assays
- Bond Work Index (BWI)
- Acid Leach Tests- Evaluate leach conditions by varying
 - Grind size
 - Acid addition / concentration
 - Leaching pulp density
- Acid Leach Tests Under Intensive Conditions
 - Investigate intensive leaching conditions to maximize extraction with variables such as:
 - Temperature
 - One-stage or two-stage leaches
- Acid Leach Tests Under Preferred Conditions

- Summarize data gathered from all the leach tests to determine preferred leach condition for the remaining test program
- Acid Consumption
 - Calculate amount of “free acid” left in solution
 - Ferrous Titration
 - Investigate the nature of iron impurities in solution (ferrous vs. ferric)
- Determine various methods for neutralizing slurry pH and removing impurities from pregnant leach solution by:
 - Adding de-slimed feed
 - Utilizing additional feed screened at 400 mesh (+37 µm) to pregnant leach solution to consume excess acid
 - Vary feed addition until target pH is achieved (to determine ideal pH for iron precipitation)
 - Using MgO to consume excess acid
 - Use of hydrogen peroxide for oxidation of ferrous to ferric
 - MgO added to raise pH (to determine ideal pH for iron precipitation)
- Crystallization
 - Evaporation of pregnant leach solution to various extents to form hydrated magnesium sulfate crystals
 - Investigation of whether crystal formation can reject impurities into remaining solution
 - Carbonate Precipitation
 - Production of high purity magnesium carbonate (MgCO₃) for calcinations using sodium carbonate (Na₂CO₃) addition
- Calcination
 - Calcination tests to better understand optimal decomposition temperature
- Assay Analysis of Final MgO product
- Process Flow Diagram
 - Overall representation of the test program

Based on the initial metallurgical test work, overall recovery of Mg from the samples under initial leach conditions using ambient temperatures was approximately 60% (Table 11.2.4).

Table 11.2.4: Extraction of Magnesium from Initial Ambient-Temperature Leach Results

Tests	YO401	YO402	YO606	YO607	YO608	Average
Mg Leached from Feed	63.9%	60.1%	68.0%	60.9%	60.2%	62.6%

Source: Met-Solve, 2012

In addition, initial test work was completed using more intense leaching conditions, which are summarized in Table 11.2.5. These tests did not include the carbonate precipitation or calcination stages, as the finer grind and heating aspects were determined to be more costly than the preferred conditions at the time.

Table 11.2.5: Extraction of Magnesium from Intense Leach Conditions.

Test Number	Description	Magnesium Extraction
YO313	1,000 kg H ₂ SO ₄ /t-feed Leach at Ambient Temperature Duration: 2 hours P ₈₀ = 59 µm Pulp Density = 25%	73.9%
YO314	2-Stage Leach 500 + 500 kg H ₂ SO ₄ /t-feed Duration: 30 min + 30 min Leach at 70°C P ₈₀ = 59 µm Pulp Density = 35%	74.6%

Source: Met-Solve, October 2012

As a result of the improved metallurgical recoveries observed using a 70°C temperature for leaching, additional test work was recommended that would further explore the potential for optimization and improvement of metallurgical recoveries using these leach conditions. This test work was carried out and a final metallurgical report summarizing the additional test work was issued by Met-Solve Labs on April 18, 2013. This report may be found in Appendix C. Table 11.2.6 summarizes the results of this recent effort.

The updated 2013 Met-Solve report details the subsequent test work under these more intense conditions and summarizes the ideal or preferred leaching conditions to obtain metallurgical recoveries. The description of each variable under these “preferred” conditions are listed as follows:

- Acid Addition: 1,000 kg/t-feed
 Even though high acid addition and high temperature were deemed to be the defining variables in improving recovery, a high acid addition was preferred due to it being a more simple process. A 1,000 kg/t-feed of acid addition was determined to be the theoretical requirement to completely leach all of the magnesium contained in the sample.
- Leach Temperature: 70°C
 Leaching at an elevated temperature of 70°C provided a significant improvement in recovery compared to 2012 test work at ambient (25°C) temperatures. It is important to note that the process is exothermic and the initial leach temperatures often reached 50°C to 60°C without any external source of heat.
- Pulp Density: 25%
 At pulp densities of 25% and 35%, crystals were seen to be forming in the residue during filtration, suggesting that the solution’s concentration was near saturation. It was then proposed that pulp density should be kept at 25% to minimize crystallization. This results in an increase in the acid concentration for more efficient leaching.
- Acid Concentration: 2.93 Molarity
 At a pulp density of 25%, the acid concentration of the leach was 2.93 Molarity.
- Particle Size: P₈₀ = 228 µm

Decreasing particle size did not show a significant increase in recovery. Therefore, a coarser 228 µm particle size was used, which was beneficial for decreasing filtration time and potentially reducing grinding costs.

- Leach Duration: 60 minutes
 Subsamples taken from the leach tests indicated that the kinetics of the leach were relatively fast and reached its extent within 60 minutes (Met-Solve, 2013).

Table 11.2.6: Extraction of Magnesium from Intense Leach Results

Test #	P ₈₀ (µm)	Mg Leach Recovery (%)	Assayed Feed Grade (%)	Calculated Feed Grade (%)	Leach Residue Grade (%)	Acid Consumption (%)
YO607/YO608 (Previous Test Work)	228	62.6	23.7	22.4	13.09	64.1
YO901a	53	86.0	23.7	24.5	6.6	N/A
YO901b	53	86.9	23.7	26.7	6.5	92.0
YO902a	228	80.5	23.7	24.3	8.1	N/A
YO902b	228	84.3	23.7	24.2	6.7	90.8
YO903a	53	81.2	23.7	23.5	7.0	N/A

Source: Met-Solve, 2013

Under these leach conditions, the key factors to the recovery estimate are summarized as:

- Achieved better than 80% Mg recovery by leaching using an elevated temperature and higher pulp density.
- The results demonstrated consistency and repeatability.
- Due to the exothermic reaction, temperatures only need to be maintained rather than raised from ambient conditions.
- Leaching does not necessitate a finer grind size, as recoveries are similar for the both the coarse and fine grind sizes.
- Reagent required for the neutralization of the acid was lowered as acid consumption was improved.
- Intermediate calcined MgO purity is in excess of 97% for the current test work. Purities in excess of 99% were demonstrated to be obtainable (Met-Solve, 2013). Expected purity and actual recovery to a final fused magnesia product cannot be confirmed in this study.

After review of the metallurgical test work conducted by Met-Solve, the QP is of the opinion that 80% recovery of magnesium is achievable subject to further confirmation at a larger scale in a locked cycle scenario. The estimated 80% recovery value is used in the SRK design criteria. The ideal situation would have locked cycle lab testing done to support this PEA. This will be done assuredly for the prefeasibility level study and it is noted clearly in the risks and future work sections of the PEA. The only hydrometallurgical lab tests done to date are open cycle. However, in the QP review

of the Met-Solve data and his 34 years of experience and education, in my opinion he made a reasonable assumption about the effect of locked cycle testing on the data. In general there is a positive effect on both recovery and reagent consumption which is why industrial plants engage in the practice routinely. However, as is a normal progression in the life of a Project, this still needs to be confirmed and quantified at some point with closed cycle testing.

The capital and operating costs associated with the increase of recovery estimation from 60% to 80% were all adjusted accordingly where appropriate. As for acid consumption, one must be careful not to take singular lab test statements out of context. Overall, there are three forms of acid consumption in the system. First, there is acid consumption from the leaching process. Second, there is acid consumption due to neutralization to remove iron and other ions using MgO. Finally, there is acid consumption due to the addition of soda ash to precipitate $MgCO_3$. So in estimating acid consumption at a PEA level in open cycle testing, one must be prudent and careful to estimate what will happen in a real plant solution recycle scenario from a holistic basis rather than one singular aspect of testing. However, in the QP review of the Met-Solve data and his 34 years of experience and education, in the opinion of the QP, reasonable assumption was made about the effect of locked cycle testing on the data. However, as is a normal progression in the life of a Project, this still needs to be confirmed and quantified at some point with closed cycle testing.

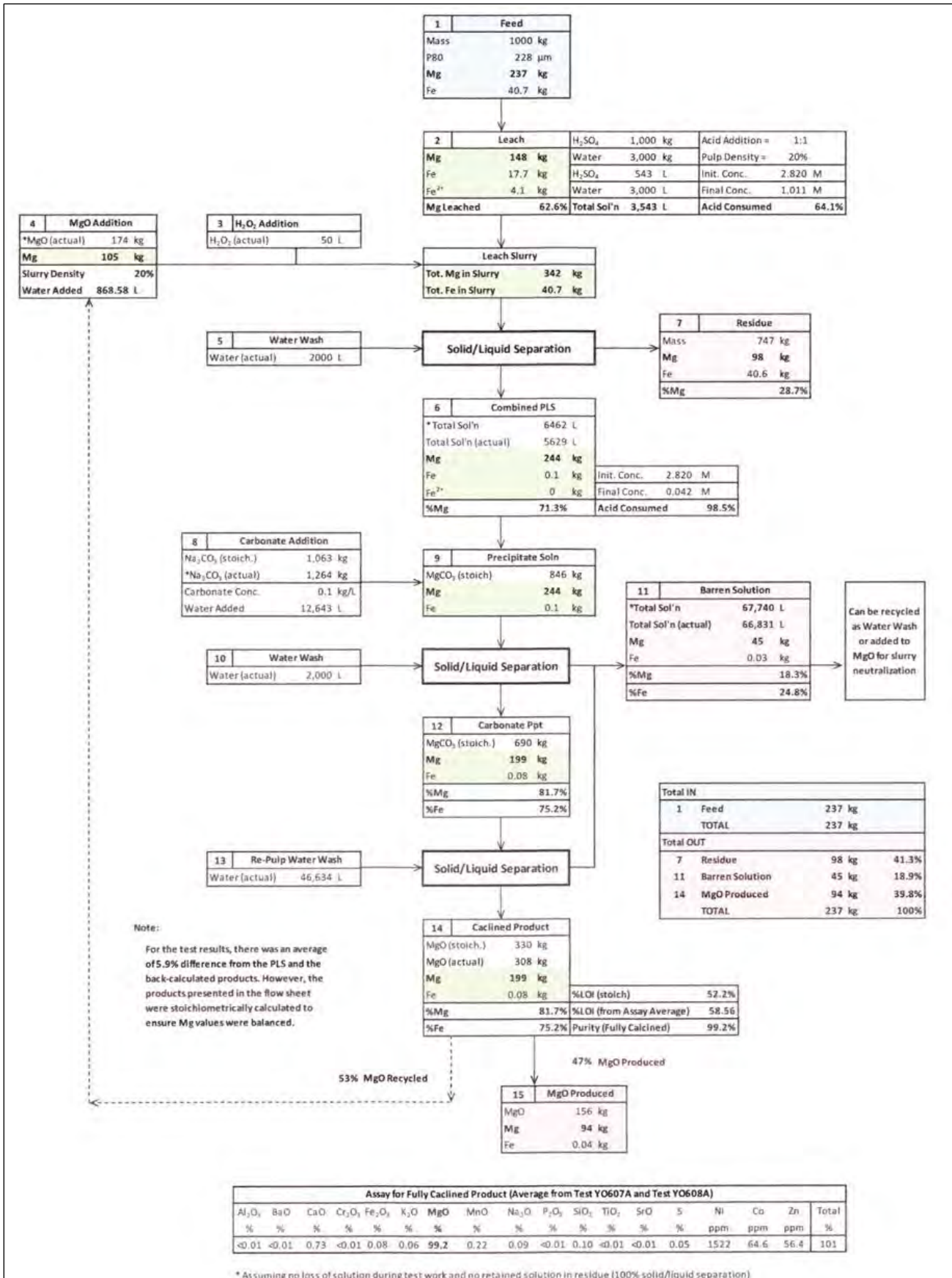

12 Mineral Resource Estimate (Item 14)

12.1 Qualified Person of the Mineral Resource Estimate

Dr. Bart Stryhas is the Qualified Person (QP) responsible for the resource estimation methodology and the resource statement. Matthew Hastings constructed the geologic and resource model discussed below under the close supervision and review of Dr. Bart Stryhas.

12.2 Drillhole Database

The drillhole database was constructed by SRK from data and information provided by WHY, and is determined to be of good quality. The database consists of four Microsoft Excel® spreadsheets containing collar locations surveyed in UTM NAD83 coordinates, downhole deviation surveys, assay intervals with elemental analyses, and geologic intervals with rock types. Appropriate codes for missing samples and no recovery were used during the modeling procedures.

The database contains information from 77 diamond-core drillholes totaling approximately 10,310 m of drilling. There are no obvious gaps in the naming sequence of drillholes. The maximum drillhole depth is 255 m and the average is 133 m. All holes are drilled vertically, approximately normal to the average strike and average dip of the mineralization. Down hole deviation surveys were not completed for every hole, but a representative sampling of those holes with surveys shows that deviation from the vertical orientation is negligible. Basic database statistics are presented in Table 12.2.1.

Table 12.2.1: Basic Drillhole Database Statistics

Year	Holes	Meters	Samples	Average Sample Length	Average Mg%
2007	6	988	614	1.61	20
2008	45	5,079	3,260	1.55	21.7
2011	26	3,863	1,967	1.96	19.6
All	77	9,930	5,841	1.70	20.8

The histogram of the drillhole sample Mg data shows two significant populations. One averages less than 5% Mg and the other between 20 and 30% Mg (Figure 12-1). A further breakdown of the average Mg grades by lithology showed that grade correlates to lithology, and that groupings of these lithologies into larger domains would partition the two Mg populations as well as aid in modeling the deposit more accurately.

12.3 Geology

The drill log lithology data contains eight distinguishable rock types based on the geologic observations of drill core. For the resource estimation, these eight lithologies were then combined into three basic rock types; including mafics, felsics, and ultramafics. The database was then analyzed for relative abundance and Mg based on the three basic rock types as shown in Table 12.3.1. These units effectively separate the bimodal Mg populations mentioned in the previous section.

Table 12.3.1: Lithic Types and Groups, Raw Assay Data with Intervals Broken by Domain

Domain	Lithology	Count	Average Mg%
Mafics	Andesite	334	4.6
	Diagabbro	440	5.8
Ultramafics	Serpentinite	4864	24.1
	Shear Zone	18	13.9
	Calcite	3	17.7
	Soapstone	45	15
	Serpentinized Andesite	98	12.9
Felsics	Monzosyenite	215	2.6

The predominant lithic domain is the Ultramafics, which contain minor lenses or intrusions of both the Felsics and Mafics. These minor units are interpreted to have a tabular geometry, and are between 1 and 40 m thick. Three structural zones were defined based on the variable dips of these units as observed in the field. In the northern zone, the units generally dip approximately 20° to 30° to the east. In the central zone, the units dip between 30° to 60° to the southeast. In the southern zone, the units are essentially flat-lying, and contain a substantially higher occurrence of the mafic units. The extents and thicknesses of these units are variable (Figure 12-3). They were generally modeled to extend halfway to the adjacent drillhole or approximately 50 m from unconfined drillhole intercepts.

3D wireframes of the Ultramafics, Mafics and Felsics were constructed in Vulcan™ 3D Mining Software based on the logged intervals in core. These are shown in Figure 12-2. In a few cases, intervals comprising less than three continuous meters were not modeled with wireframes, and are instead accounted for as internal dilution of lower-grade samples within the estimated blocks. The boundaries of the ultramafics were limited by topography, extent of drilling, and a grade shell constructed at a ≥10% Mg limit. The wireframe was constructed using a vertical surface created 50 m beyond the perimeter drillholes to form the lateral limits of grade estimation. This distance represents the average drillhole spacing and is about 30% of the variogram range. Next, a floor was created by generating a surface at the base of the ultramafic unit or the base of drilling, whichever occurred first. These two surfaces were then combined with topography to create a 3D solid of the ultramafic host unit. Material external to these boundaries is simply unclassified. The mafic and felsic lithologies were also modeled with 3-D wireframes and subsequently coded into the model blocks and composites. All model blocks coding was done using partial volumes with greater than 50% required for code assignment.

12.4 Block Model

The block model was constructed within the UTM NAD83 grid coordinate limits listed in Table 12.4.1. A 15 m x 15 m x 6 m (x, y, z) block size was chosen as an appropriate dimension based on the current drillhole spacing and a potential open pit smallest mining unit. The topographic surface was created from the elevation coordinates of the drill collars and from the digitized 30 m resolution contours of the Canadian Geologic Survey topographic map, both supplied by WHY. Soil thickness varies slightly over the deposit and the soil thickness is generally very thin or non-existent. The top of bedrock surface was considered the same as the topographic surface for this resource estimate.

Table 12.4.1: Block Model Limits

Orientation	Minimum (m)	Maximum (m)	Block Dimension (m)	Number of Blocks
Easting	433,800	435,210	15	94
Northing	5,431,800	5,433,555	15	117
Elevation	1,100	1,700	6	100

12.5 Capping & Compositing

The raw assay data was first plotted on histogram (Figure 12-1) and cumulative distribution plots (Figure 12-4) to understand its basic statistical distribution. The histogram shows two populations based on lithology. The higher grade Mg population has a normal distribution with a slight negative skewness. The mean Mg grade of all samples in the database is 20.8% and the coefficient of variance (CV) is 0.38. A capping analysis was performed to evaluate the potential for outliers to affect the grade interpolation. The cumulative distribution curve illustrates a continuous population set with a subtle break in slope around 99.8% cumulative probability correlating to 32.5% Mg. A small population of “high-grade” outliers lies above this level. The raw drillhole data was capped at 32.5% Mg prior to compositing. This capping affected nine samples, with an average grade of 33.55% Mg.

The original assay lengths range from 0.3 to 7.0 m with an average of 1.7 m. For the modeling, the capped assays were composited into 3.0 m bench lengths with breaks at the major geological domains described above. This length was chosen mainly so that two composites would comprise each 6 m block height. Logged geology was recorded as a majority of each composite length. A histogram of the capped and composited Mg grades with basic statistics is presented in Figure 12-5.

12.6 Density

WHY conducted density testing on the drill core to support the resource estimation. Approximately 670 samples were tested from the 2008 drilling program and over 1,700 samples from the 2011 program. The density data was subdivided by the three major lithologic groups used in the geologic model, and averages were calculated for each group. The results are presented in Table 12.6.1. Density was assigned in the block model based on each block’s lithology. Blocks outside of the resource estimation with unclassified lithology, were assigned a density of 2.67 g/cm³, the average value for all the measurements taken.

Table 12.6.1: Density Determinations

Lithic Domain	Number of Measurements	Density (g/cm ³)
Ultramafics	2025	2.66
Mafics	315	2.73
Felsics	117	2.69

12.7 Variogram Analysis

Variogram analysis was performed on the capped and composited data filtered to include only the ultramafic lithic domain. Directional semi-variograms were constructed at 30 azimuth intervals and 30 dip increments to generate a total of 48 plots. No preferred orientation was seen in the diagrams. The horizontal variograms all showed a similar range of about 175 to 200 m. As the plunge angle

increased the range was reduced to the average drillhole depth of about 125 m in the vertical. A final omni-directional semivariogram was constructed for use in the Kriging algorithm. Two spherical structures were modeled during the fit of the variogram. A lag of 25 m was used with a variable separation based on the extents of the data. The semivariogram parameters are presented in Table 12.7.1. The experimental semivariogram data is shown in Figure 12-6 fit with the model semivariogram parameters listed in Table 12.7.1.

Table 12.7.1: Semivariogram Model Results

Omni Directional Structure	Range (m)	Nugget	Sill Differential
C1	35	8.23	9.68
C2	176	8.23	9.95

12.8 Grade Estimation

The grade estimation was confined to a hard boundary of the ultramafic lithic domain using only the composites from the same domain. This boundary corresponds to the geologic model presented in Section 12.3. The block model was first coded so that all blocks within this solid were flagged as ultramafic and then the Mafics and Felsics solids were used to code the blocks of internal waste.

The Mg grade estimation utilized an Ordinary Kriging (OK) algorithm supported by the 3.0 m bench composites. A nested search method consisting of three passes was used. For the first two passes, the estimation required a minimum of five and a maximum of 15 composites to assign grade to each block. For the third pass, a minimum of one and a maximum of five composites were required to assign grade. A maximum of three composites from a single drillhole were allowed for the first two passes, thus at least two drillholes were used for all blocks. A maximum of five composites from a single drillhole was allowed for the third pass, ensuring that all blocks within the grade shell would be estimated. No blocks estimated in subsequent passes were allowed to overwrite the prior passes of estimation. No octant search restriction was applied due to the regular configuration of the drillhole spacing.

Due to observed variations in the dip of the un-mineralized mafic and felsic units within the Ultramafics, the modeling was sub-divided into three structural zones (1-3) from north to south (Figure 12-7). Each zone utilized unique search orientations to account for the variable dips. The search orientations and ellipsoids and are presented in Tables 12.8.1 and 12.8.2 respectively. The search ranges are based on the results of the variography as well as the average drillhole spacing. The number of composites and drillholes used to estimate each block were stored during the estimation as well as the average distance to the composites used. Each pass of estimation was also recorded to show which blocks were estimated in which pass. The results show that an average of eight composites, from three drillholes, was used with an average distance of 62 m. A detailed breakdown of the estimation parameters in each pass is shown in Table 12.8.2. A representative cross section of the interpolated block model grades is shown in the Figure 12-8.

Table 12.8.1: Ellipsoid Orientations

Zone	Bearing° (Z)	Plunge° (Y)	Dip° (X)
1	0	0	-30
2	0	20	-60
3	0	0	0

Table 12.8.2: Estimation Parameters and General Statistics

Parameter	Estimation Pass		
	1	2	3
Major Axis (X) (m)	50	100	150
Semi-Major Axis (Y) (m)	50	100	150
Minor Axis (Z) (m)	12.5	25	50
Minimum Samples	5	5	1
Maximum Samples	15	15	15
Max per drillhole	3	3	5
Blocks Estimated (% of Total)	15.2%	68.9%	15.8%
Average # of Composites	7	3	4
Average # of Drillholes	2	3	4
Average Distance (m)	31.9	62.5	90.8

12.9 Model Validation

Four techniques were used to evaluate the validity of the block model. All four tests provided excellent confidence in the resource estimation. First, the interpolated block grades were visually checked on sections and bench plans for comparison to the composite assay grades. Second, statistical comparisons were made between the interpolated block grades and composite data within the entire ultramafic unit. These results are presented in Table 12.9.1 and show block grades slightly less than composite grades as desired. Third, a nearest neighbor (NN) estimation was run using a single composite to estimate each block within the same parameters used for the OK model. The total contained magnesium at a zero cut-off was compared in the OK model at the same cut-off. The OK model contained 1.12% less Mg metal than the NN estimation, indicating that metal is not being manufactured during the modeling process. Fourth, swath plots were generated to compare OK and NN block grades at regular section and bench intervals. The results are presented in Figures 12-9a through 12-9c. These show an acceptable amount of grade smoothing with the majority of the OK block grades very close to the NN.

Table 12.9.1: Model Validation Statistical Results

Domain	Data	Mean Mg %	Variance	Max	Samples
Ultramafics	3 m Bench Composites	22.81	27.86	32.5	2,922
	Kriged Blocks	22.55	10.84	30.44	40,261

12.10 Resource Classification

The Mineral Resources are classified under the categories of Measured, Indicated and Inferred according to CIM guidelines. Classification of the resources reflects the relative confidence of the grade estimates. This classification is based on several factors including; sample spacing relative to geological and geo-statistical observations regarding the continuity of mineralization, data verification to original sources, specific gravity determinations, accuracy of drill collar locations, accuracy of topographic surface, quality of the assay data and many other factors, which influence the confidence of the mineral estimation. No single factor controls the resource classification rather each factor influences the result.

Generally, most of the factors influencing the resource classification in the Project are positive. The resources have been classified as Measured and Indicated based primarily on sample spacing as

indicated by drilling density. For the resource classification, a solid shape was constructed around the core of the deposit where most drillholes are spaced approximately 50 m apart. All blocks located within this area were classified as measured resource. All blocks estimated within the areas of 100 m spaced drilling were classified as Indicated resource (Figure 12-10). All blocks estimated outside of the perimeter of drillholes are classified as Inferred resource.

12.11 Mineral Resource Statement

The Record Ridge mineral resource statement is presented in Table 12.11.1. A 21.9% Mg cut-off grade (CoG) was chosen for resource reporting based on internal Whittle™ CoGs using a US\$2.00/t mining cost, US\$240/t processing cost, 60% recovery, G&A cost of US\$1.00/t, no NSR and a US\$1,100/t value for Fused Mg at 98% lump. The mineral resources are confined within a pit design based on the same parameters used for the CoG and a 45° pit slope. The designed pit has also been constructed on the basis of a Whittle™ pit resulting in a positive economic case as presented in Section 13. The results reported in the resource statement have been rounded to reflect the approximation of grade and quantity, which can be achieved at this level of resource estimation.

Table 12.11.1 - Record Ridge Mineral Resource Statement – April 18, 2013

Resource Category	% Mg Cut-off	Total Mt	% Mg Grade	Contained Mg (Mt)
Measured		28.4	24.82	7.05
Indicated	21.9	14.6	24.21	3.54
M&I		43.0	24.61	10.59
Inferred		1.07	24.37	0.26

- Mineral Resources are not Mineral Reserves and do not have demonstrated economic viability. There is no certainty that all or any part of the Mineral Resources estimated will be converted into Mineral Reserves;
- Open pit resources stated as contained within a potentially economically minable pit shell, and a calculated internal Whittle™ cut-off grade (CoG) of 21.9% Mg was used based on the following parameters: US\$2.00/t mining cost, US\$244.75/t processing cost, 60% recovery, G&A cost of US\$1.00/t, no NSR and a US\$1,100/t value for Fused MgO at 98% lump;
- Note that the above cut-off grade is based on the early assumption of a 60% metallurgical recovery, and has not been updated to reflect the most recent metallurgical test work which suggests an 80% recovery. It can be expected that using this updated recovery would lower the cut-off grade for the Whittle™ internal cut-off, likely resulting in more tonnes and a longer life of mine (LoM); and
- Mineral resource tonnage and contained metal have been rounded to reflect the accuracy of the estimate, and numbers may not add due to rounding.

The mineral resources are reported in accordance with Canadian Securities Administrators (CSA) NI 43-101 and have been classified in accordance with standards as defined by the Canadian Institute of Mining, Metallurgy and Petroleum (CIM) Definition Standards – For Mineral Resources and Mineral Reserves.

12.11.1 Mineral Resource Sensitivity

The grade tonnage distributions of the Measured and Indicated Mineral Resources at the Project are presented in Table 12.11.1.1 (Figure 12-11)

Table 12.11.1.1: Record Ridge Measured and Indicated Mineral Resource Sensitivity

Cut-off (Mg%)	Mg	Tonnage (Mt)	Mg (kt)
15	23.30	60	13,944
16	23.39	59	13,836
17	23.51	58	13,670
18	23.66	57	13,419
19	23.84	55	13,052
20	24.06	52	12,540
21	24.33	48	11,792
*21.9	24.61	44	10,841
22	24.63	44	10,760
23	25.03	37	9,212
24	25.59	27	6,884
25	26.26	17	4,350
26	27.05	8	2,249
27	27.98	3	923
28	28.85	1	359

* Base Case

12.11.2 Reserve Estimation

A prefeasibility study is required to demonstrate the economic merit of mineral resources in order for their conversion to reserves. At this time, no such study has been completed and therefore the Project currently has no reserves.

12.11.3 Material Effects on Mineral Resources

The mineral resources described in Section 12.11, constitute contained metal in the ground and have not been included in any formal plan of exploitation. There are no known material issues related to environmental, permitting, legal, title, taxation, socio-economic, marketing, political or other relevant issues which may affect the mineral resources.

Issues related to the extraction of Mg from silicate rocks have been addressed throughout an extensive metallurgical test work program. The costs associated with the extraction of Mg from the host rocks at Record Ridge have been estimated using reliable assumptions based on the metallurgical program, and reagent pricing inquiries to major providers. Thus, significant risks exist due to the high processing costs, and the economic recoverability of the resource is sensitive to the costs of reagents as well as the metallurgical recoveries. Conversely, significant opportunities exist were the costs and recoveries improved due to favorable bulk purchasing contracts for reagents and continued metallurgical test work to improve recoveries and minimize consumables.

Additionally, there are no other quantifiable material issues related to mining, infrastructure, permitting, or other relevant issues which may affect the mineral resources.

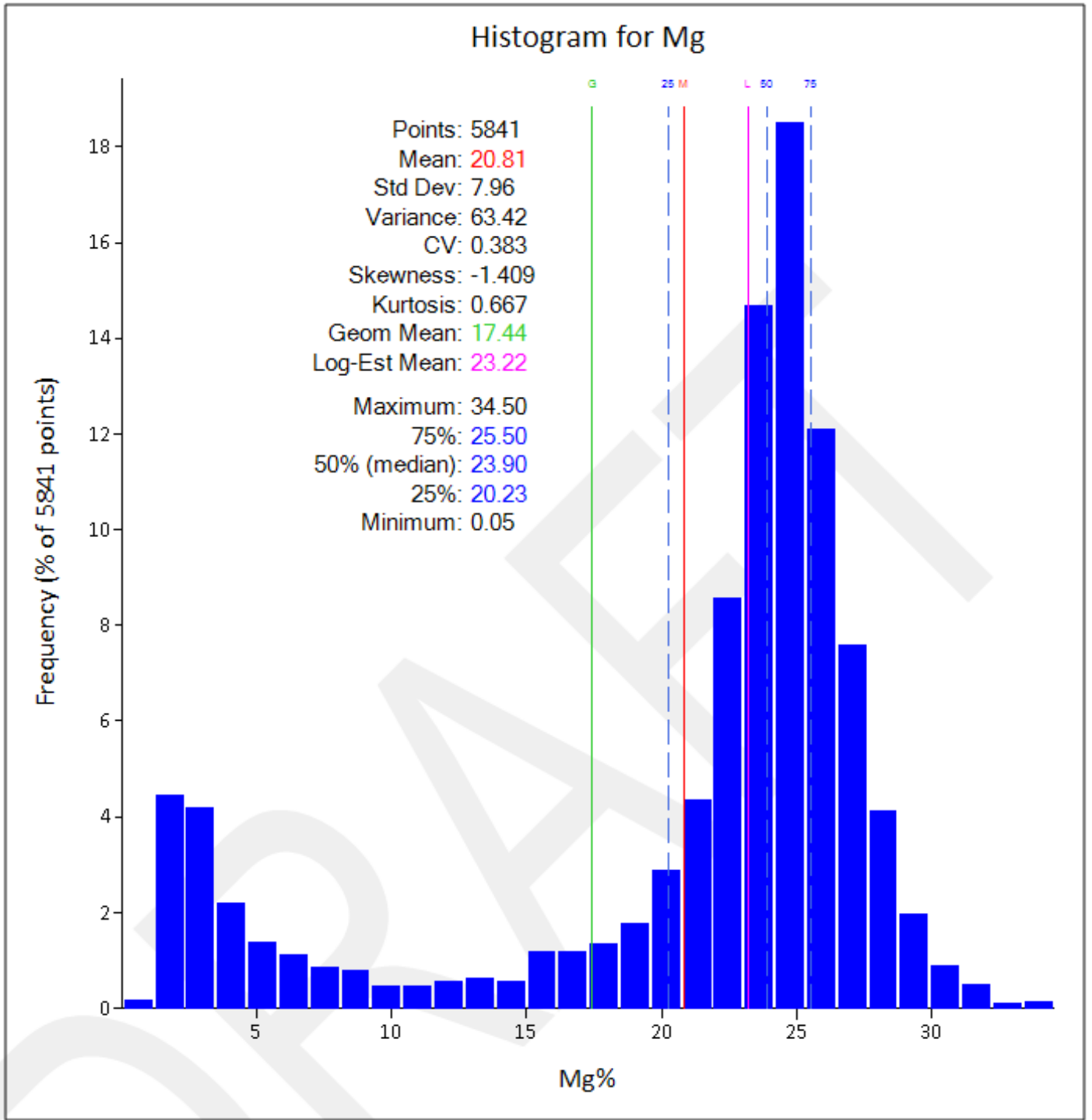

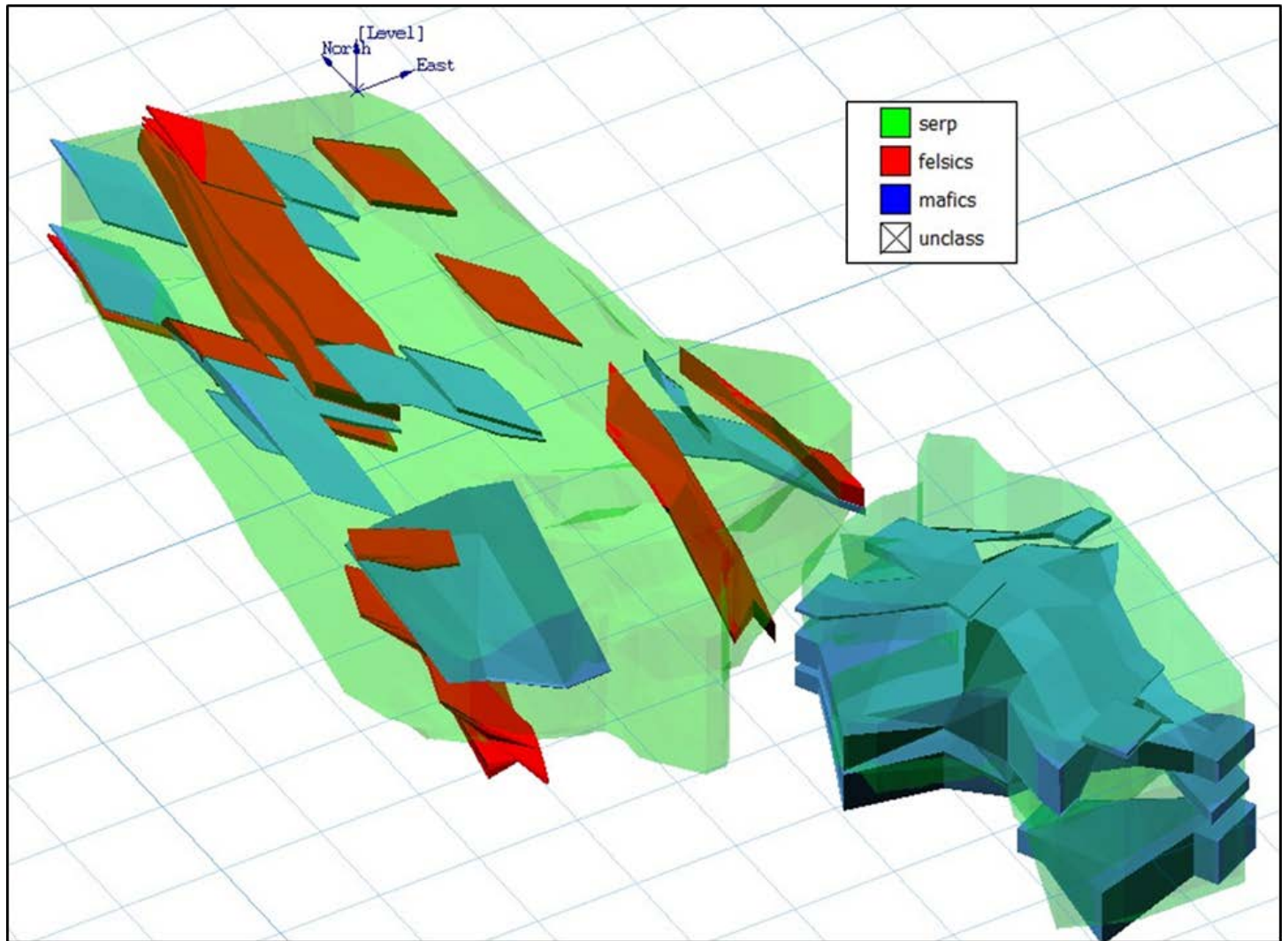

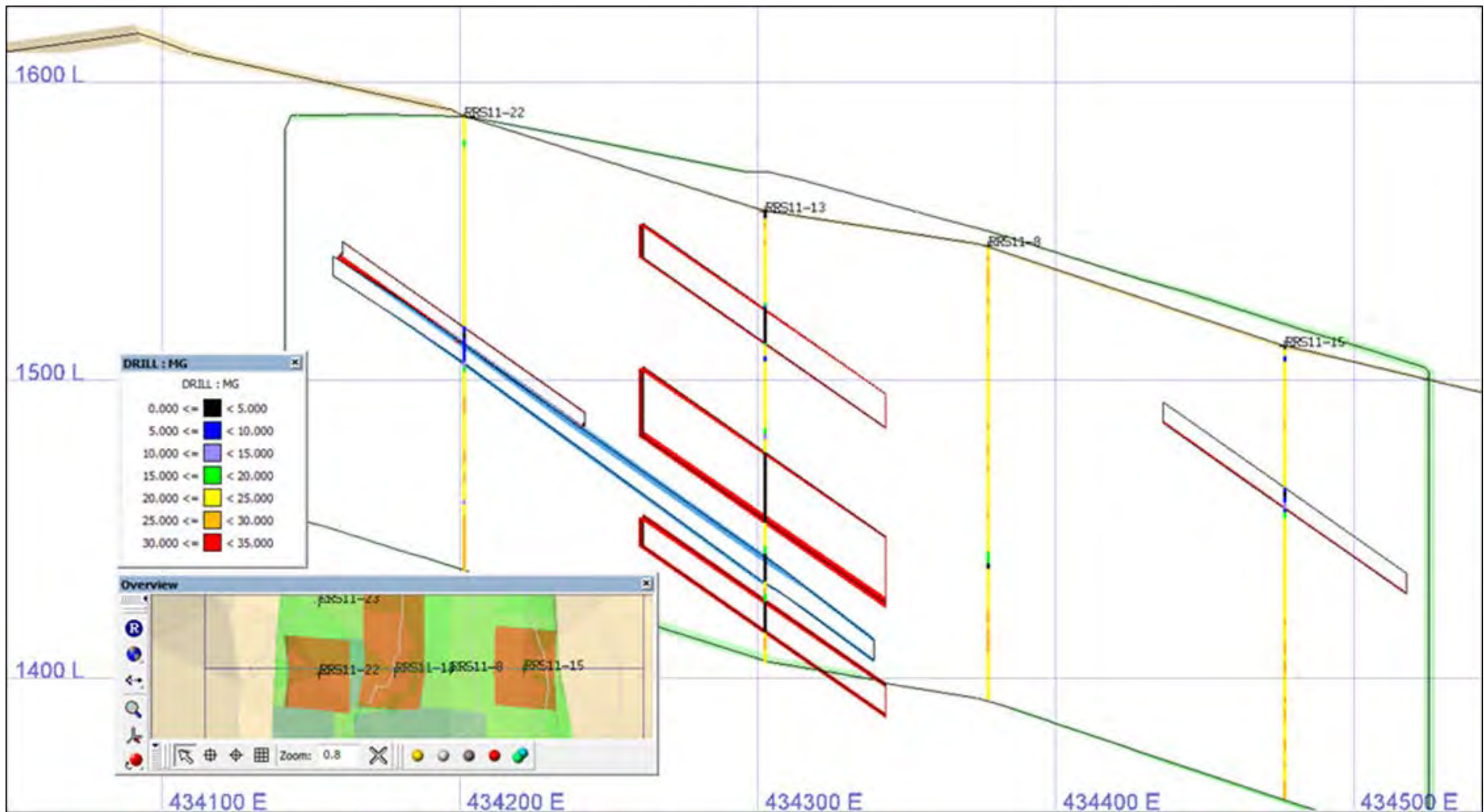

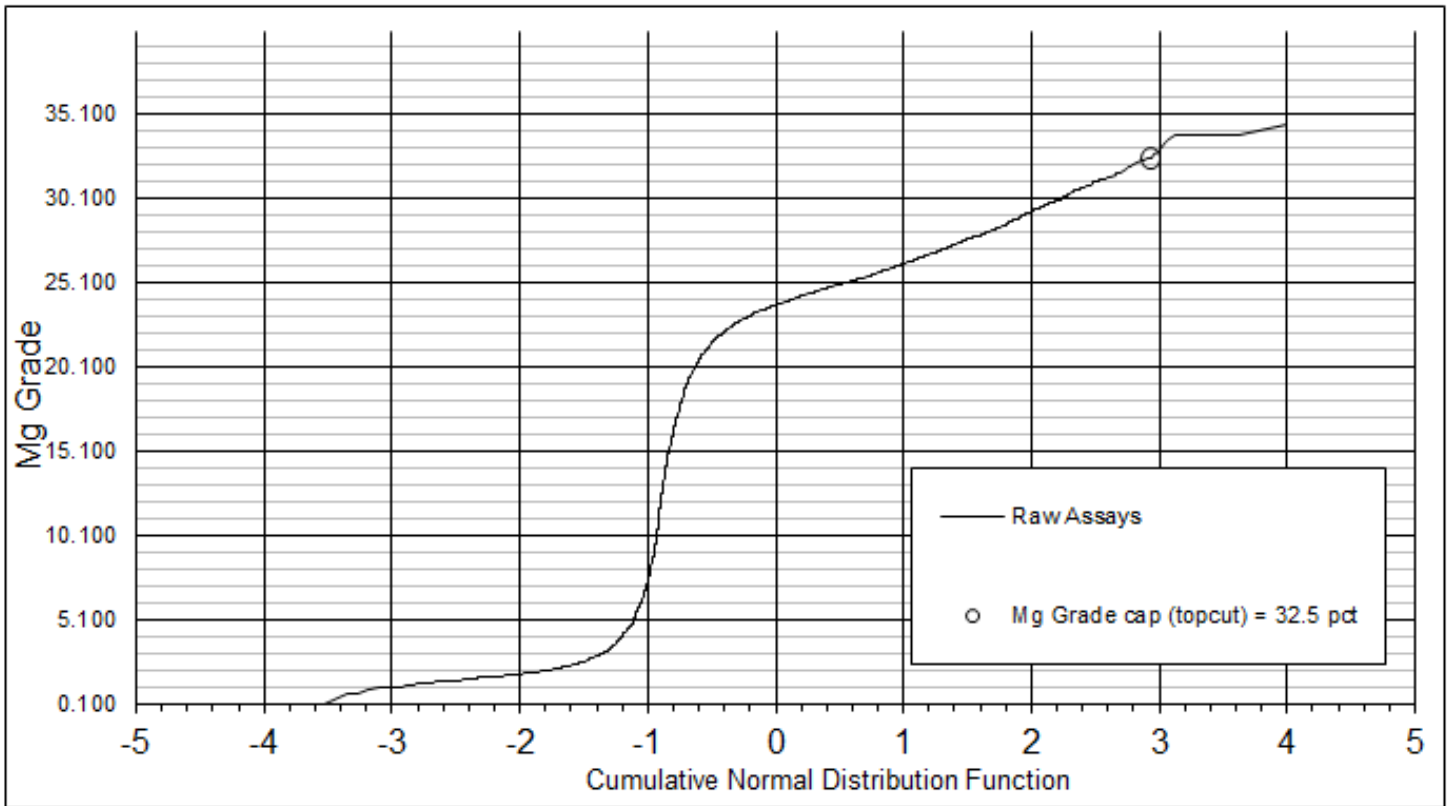

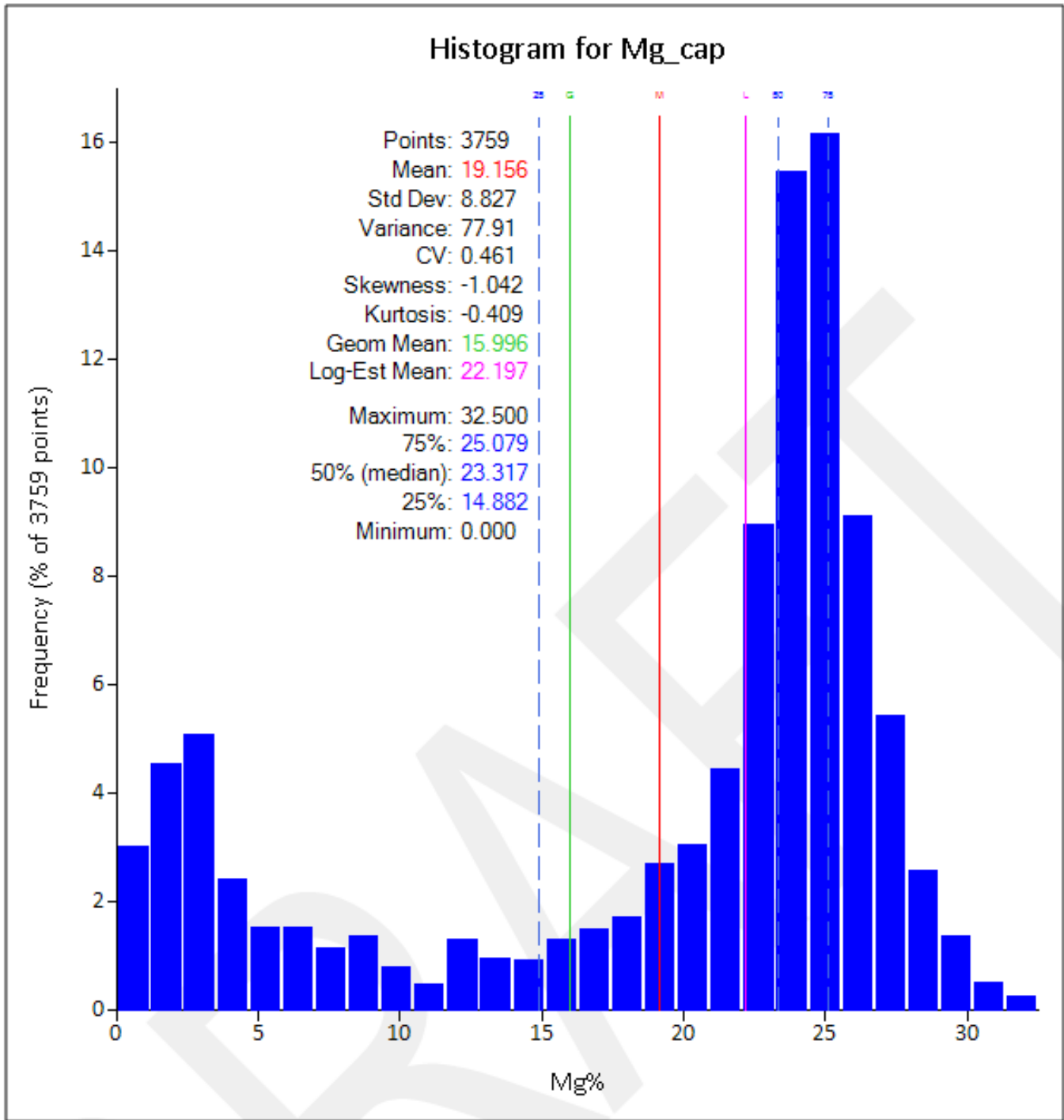

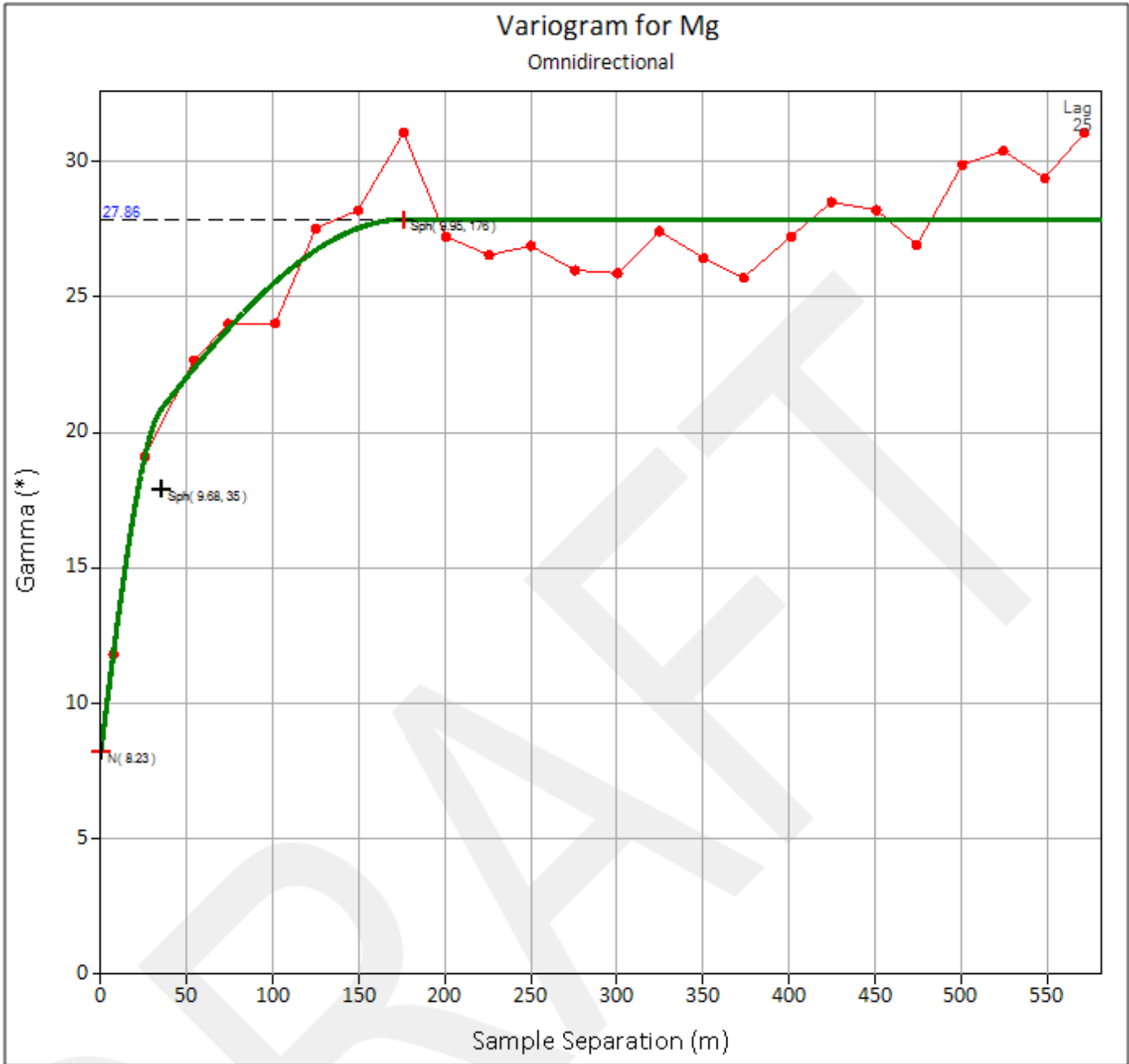

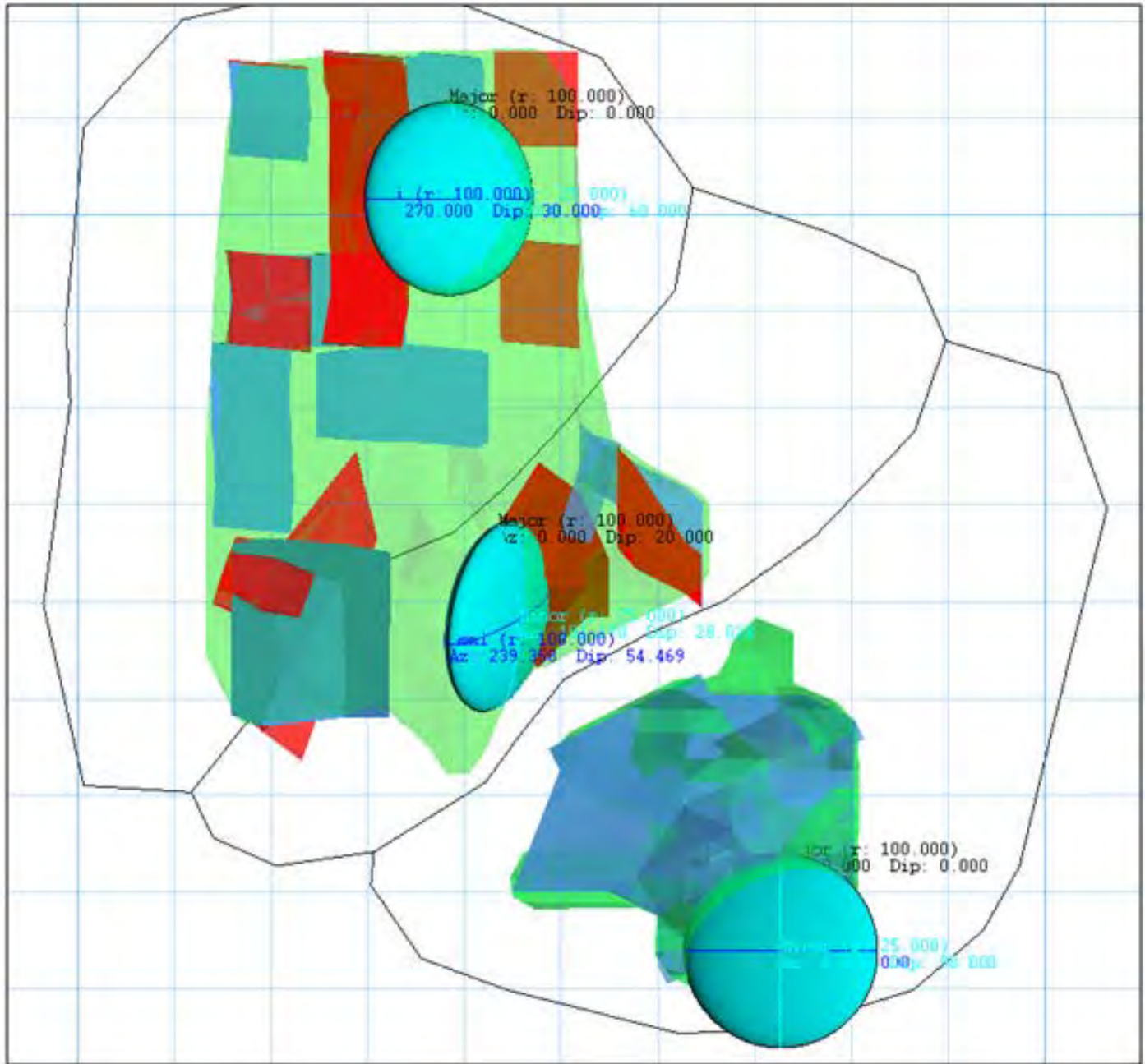

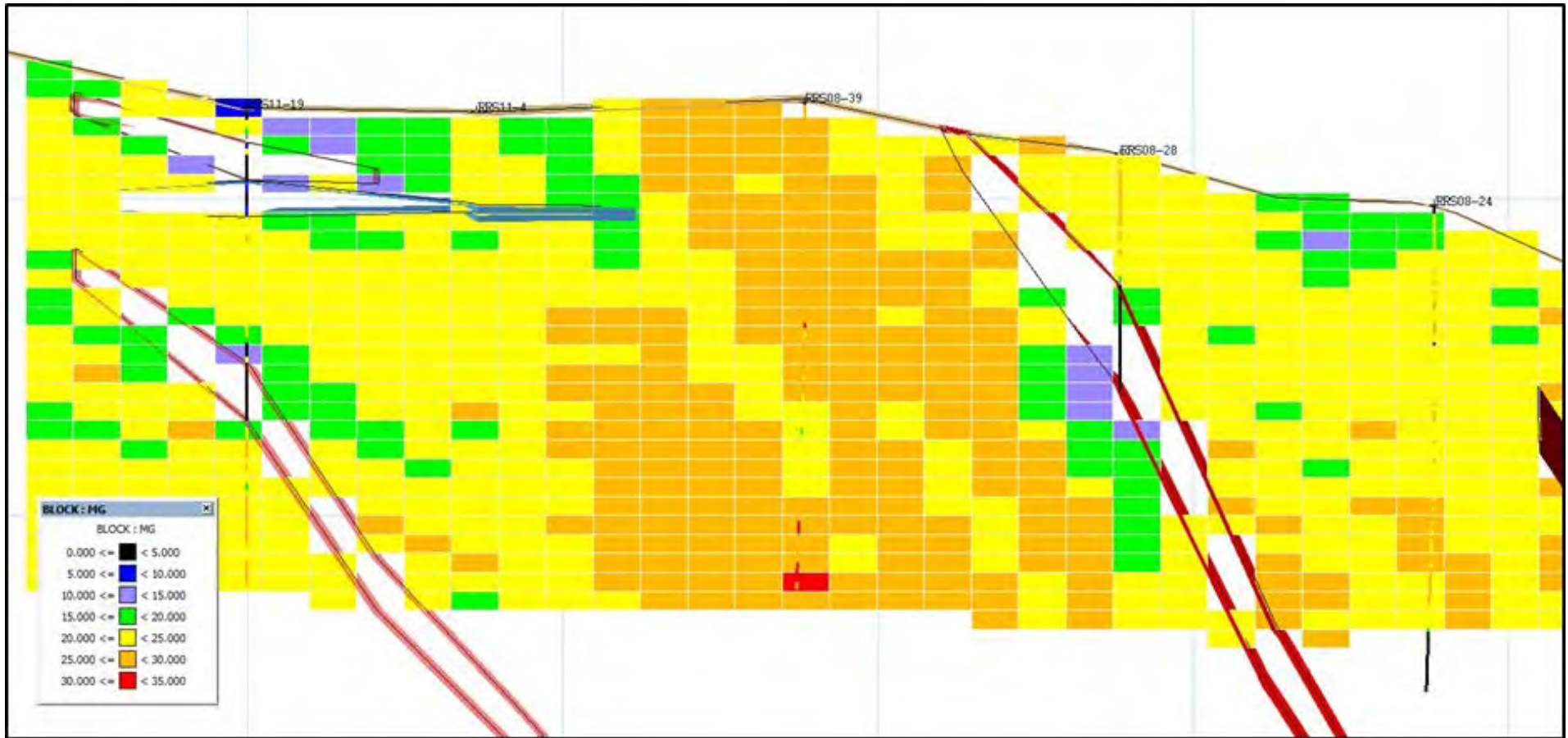

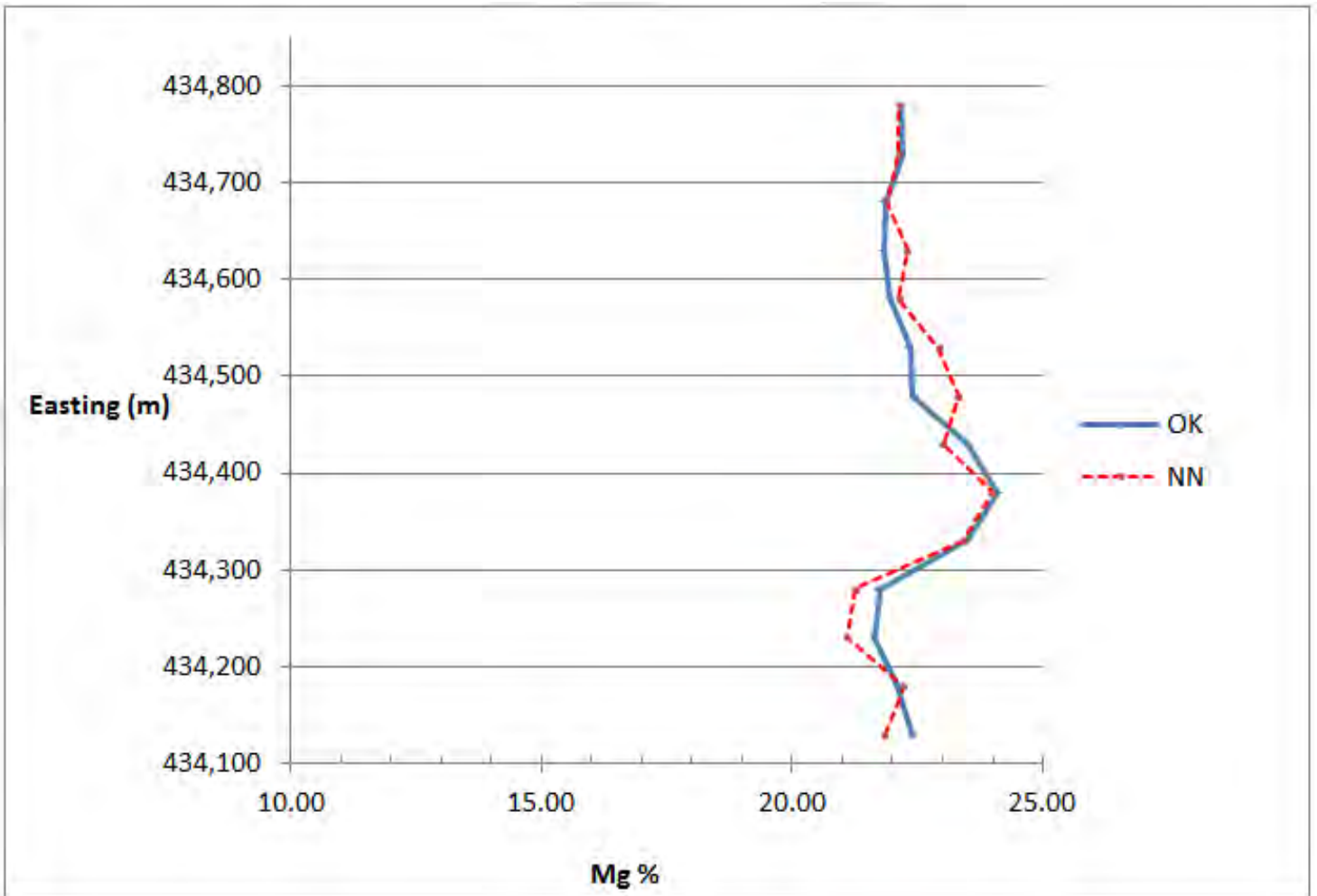

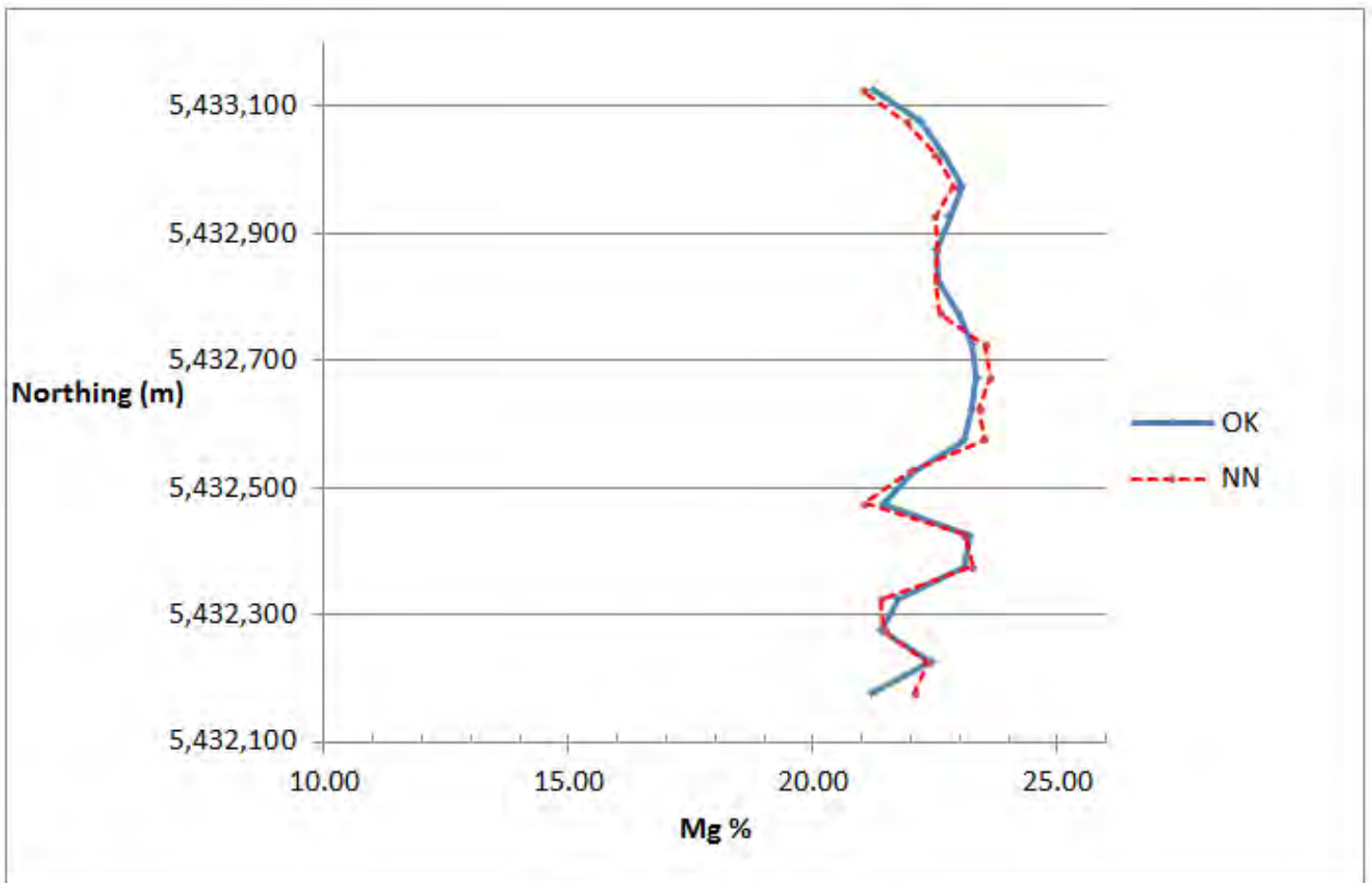

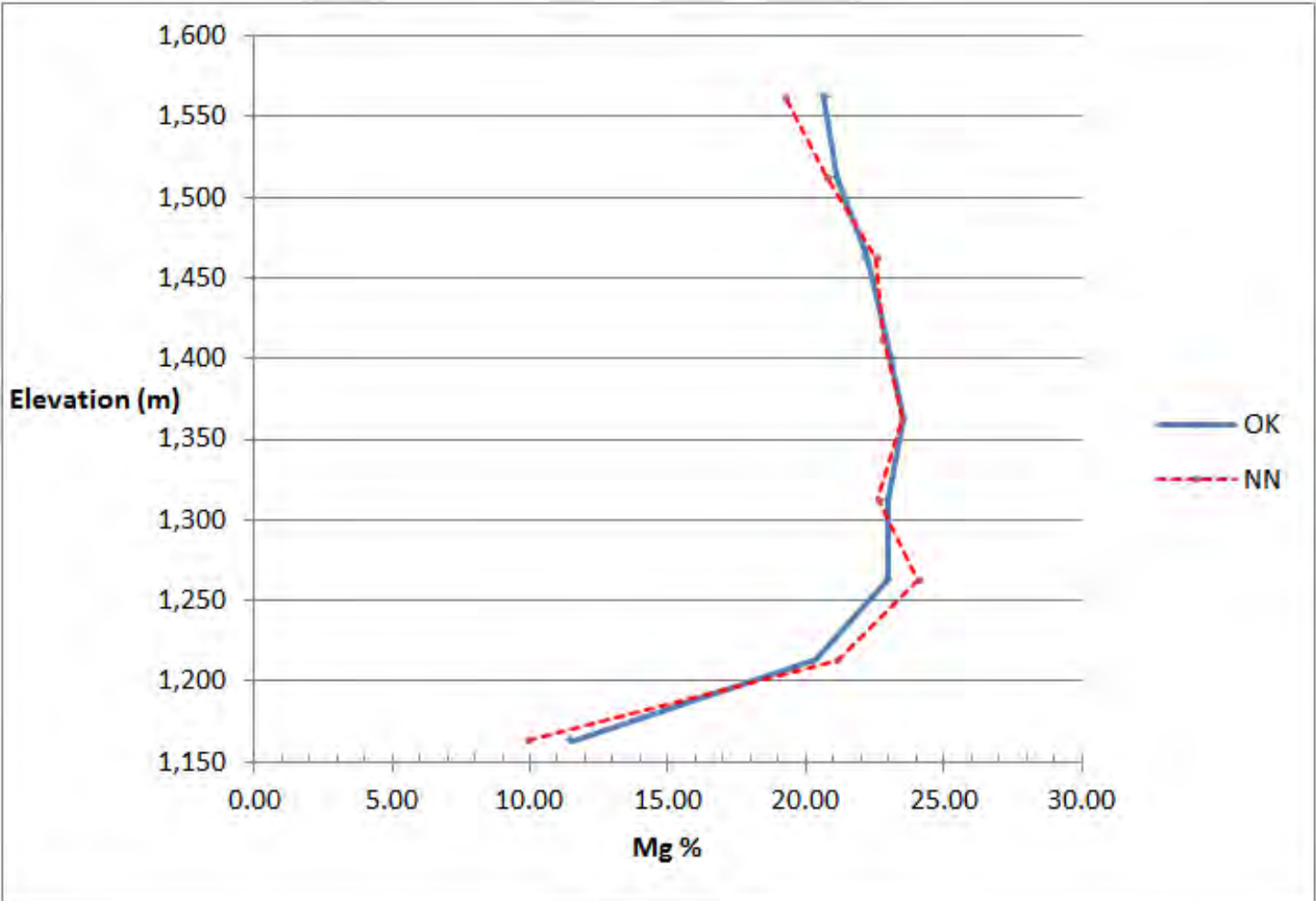

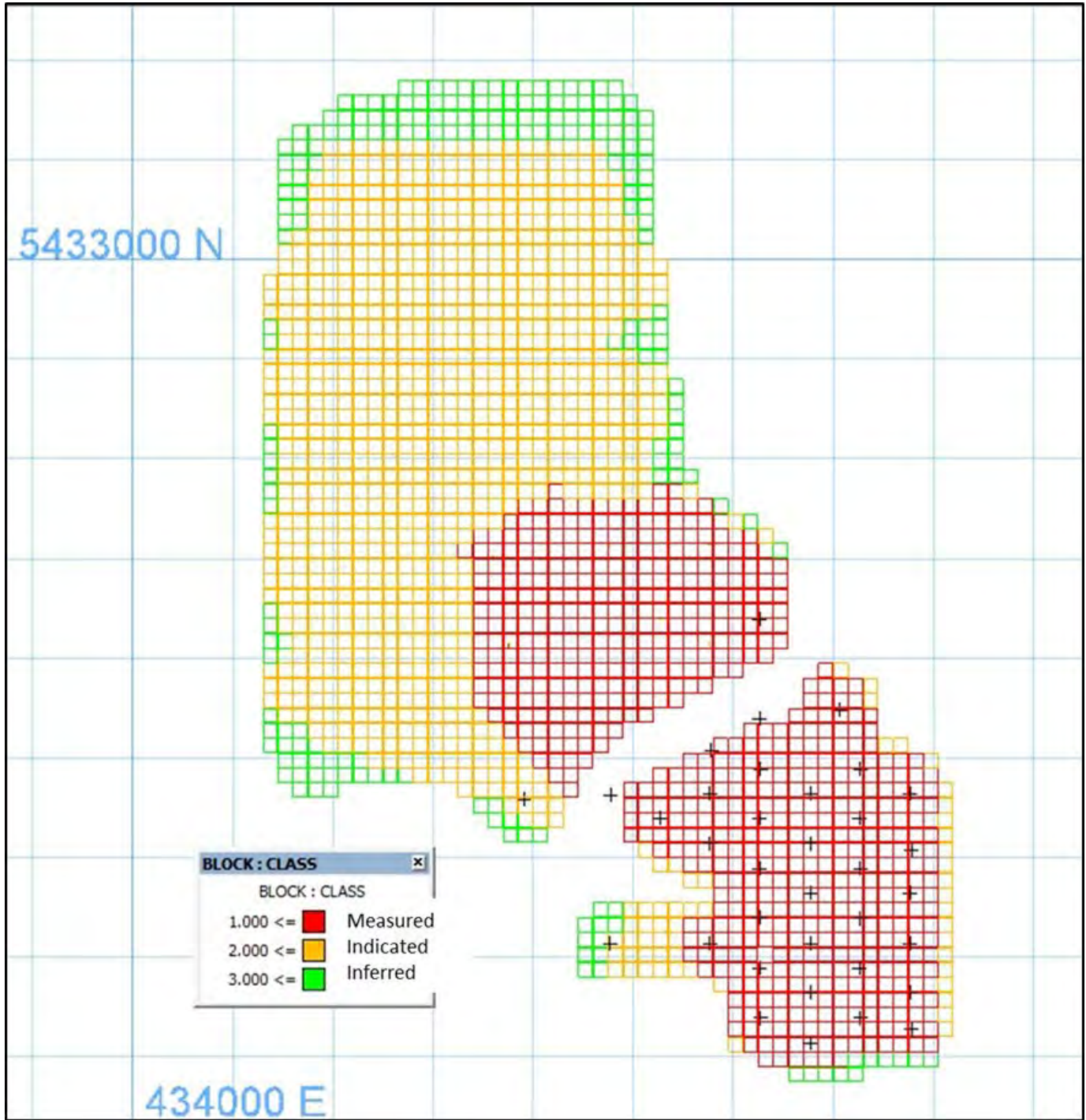

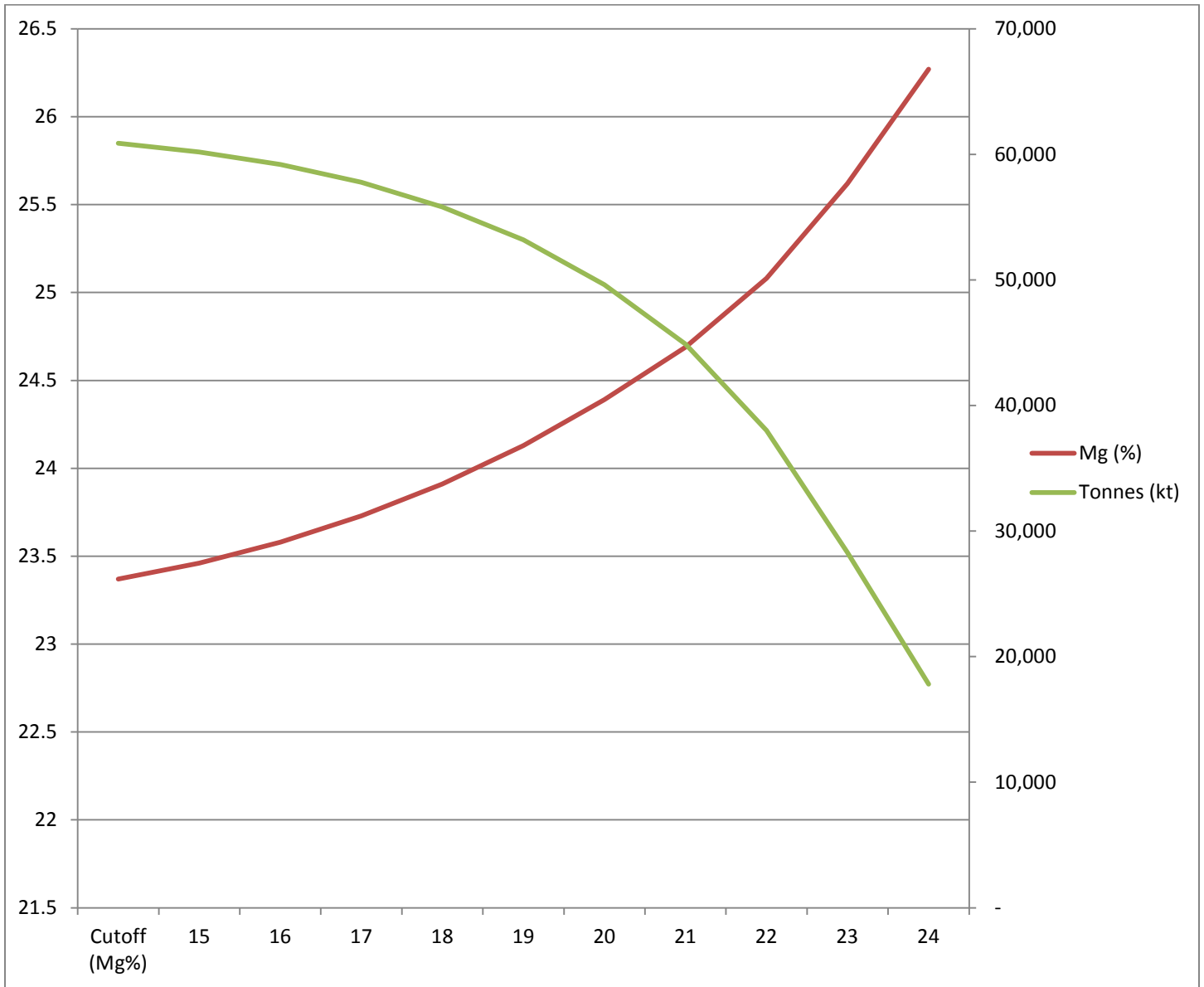

13 Mining Methods (Item 16)

The Record Ridge property is located near town of Rossland, B.C., 5 km north of the U.S.-Canada border. Overland travel time from the town of Rossland to the property is approximately 20 min. With reference to Figure 13-1, the north phase measures approximately 600 m in a N-S direction, 500 m in a W-E direction and the south phase measures approximately 450 m in a N-S direction and 400 m in a W-E direction. The north phase is approximately 160 m deep and south phase is approximately 140 m deep.

Record Ridge will be mined using conventional open pit methods using a default 365 day production cycle comprising of one 12 hour shift delivering approximately 3,000 t/d of material to the crusher. Waste material below specified cut-off will be hauled from the pit and placed in a designated waste dump location as referenced by Figure 13-1. After extraction of phase 1 through phase 3, it is expected that backfilling of the North pit will be possible to reduce cycle time and disturbance footprint of the operation. With further optimization of the tailings dam facility, it is foreseeable that waste will be used as bulk earthworks for the downstream construction of the dam wall. As such, both uses have been provisioned in Figure 13-1.

Mill material will be mined from the pit and transported to the processing facility near the mine and placed in a stockpile and subsequently fed into the crusher bin by front-end-loader.

The mine production schedule and fleet estimation suggest that a 42 year mine life is possible given the economic assumptions for processing, mine cost, recovery and metal price. There is almost no variation in grade across the deposit so detailed grade control and selective mining methods will not be needed to ensure a consistent mill feed grade for the process plant.

Although the mine fleet has been estimated from first principals, it is highly likely a contract miner will be employed to batch excavate the potential mill feed and place into a large stockpile near the process plant for continual operations through the winter. The cost benefit of this trade-off is beyond the scope of the PEA at this time.

13.1 Geotechnical Parameters

A limited set of geotechnical data was present for the current study. SRK visited the site in September of 2011 in order to assess the site conditions and geotechnical logging parameters. Based on those observations, which seem reasonable for this type of study, the southern end of the property was designated to have an overall slope angle of 45 degrees and the northern part of the property was assigned the overall slope angle of 50 degrees. These zones are shown in Figure 13-2 in different colors. Additional geotechnical characterization and analyses will be required to reach prefeasibility level and to more accurately evaluate slope behavior. Hence SRK recommends that additional geotechnical mapping should be conducted via existing surface outcrops and a new geotechnical drilling program. The geotechnical holes can usually be coordinated with the resource drilling program, siting the geotechnical drill holes in consideration of the geologic and structural model, and planned ultimate pit limits. The geotechnical surface mapping must focus on structure, discontinuity persistence, spacing and variations in orientations, and ground water conditions. The geotechnical drilling program must use triple tube or equivalent systems to minimize damage and over estimation of natural breaks in rock core. Detailed geotechnical logging, core sampling and core orientation should be conducted on inclined geotechnical holes for a prefeasibility level assessment.

In addition, geotechnical strength testing on representative core samples will be required. Basic geotechnical logging (RQD, strength index) should be included for all exploration holes. Engineering slope stability analysis will be required to support a prefeasibility level evaluation.

13.2 Pit Optimization

The estimated economical parameters, geological resource model, and the slope angles were used as the input to produce nested pit shells. Mg grade values in the geological resource model were converted to MgO grade by using a multiplier equal 1.66. The resulting MgO grade block model was exported from Maptek™ Vulcan™ general-purpose mine planning software (version 8.2.0) and imported into Whittle™ pit optimization software package (version 4.4.1). Whittle™ software uses Lerchs-Grossman algorithm to determine the approximate shape of a near-optimal pit shell, called “base case”. Base case pit shell is the 3D pit outline which, if mined out, would give the maximum economical return, while obeying the pit slope constraints.

Multiple incremental or nested pit shells were produced along the base case shell using a range of the price multipliers, called revenue factors. Revenue factors are used to scale the base case prices/costs up or down. Nested pit shells are necessary for realistic sequencing and scheduling the mine.

The parameters used for pit optimization might not exactly match the parameters quoted in the final economic model and/or pit design, but are considered to be within nominal ranges for this study level.

13.2.1 Whittle™ Parameters

The resource block model was exported from Vulcan™ and imported into Whittle™ for pit optimization analysis. The resource block model parameters are displayed in the Table 13.2.1.1.

All of the blocks from the geological resource model were used for the analysis, including inferred resources.

Table 13.2.1.1: Record Ridge Resource Block Model Parameters

Whittle™ Parameter	Type	Value
Base Units	Mg (Magnesium)	%
Measured, Indicated, Inferred		%
Block Model Dimensions	Block size (X Y Z)	15 15 6
	Number of blocks (X Y Z)	94 117 100
Overall Slope angle	in degrees	45

The economical parameters for calculating values of each block used in the Whittle™ pit analysis are displayed in Table 13.2.1.2. The parameters are based on preliminary metallurgical test work, market studies, published pricing information, etc. The initial capital cost and processing limit were used to identify the most optimal Whittle™ economical shells for the ultimate designed pit and for logical pit pushbacks that can be utilized for scheduling purposes.

The value of each block in the geological resource block model is calculated based on the selling price of MgO, a final product. A multiplier of 1.6579, based on molecular weights of Mg and O, is used for conversion of Mg grade to MgO grade. The ultimate pit has average Mg grade of 24.61%, which corresponds to average MgO grade of 40.8%. The total amount of the initial capital cost

equals US\$275 million, including US\$25 million of sustaining capital cost. Initial capital cost is applied at the time zero, a project start time. A discount rate of 8% per year is selected.

The Whittle™ analysis performed for this study did not include transportation, selling costs and replacement capital cost.

Table 13.2.1.2: Record Ridge Pit Optimization Parameters

Whittle™ Parameter	Units	Value
Mining cost	US\$/t mined	2
General and Administration cost	US\$/crushed-t	1
Processing		
Selection method	-	cut-off
Process name	-	fusion
EFM processing cost (enhanced fusion process)	US\$/crushed-t	24
Acid cost from own plant	US\$/crushed-t	75
Soda ash cost	US\$/crushed-t	140
Recovery of Mg	%	60
Revenue and Selling Cost		
MgO Price	US\$/t product	1,100
Optimization – Whittle™ revenue factors		0.3-2 86 factors
Initial capital cost	US\$	275,000,000
Limits – mining limits	mined t/yr	-
Limits – processing limits	processed t/y	1,050,000

The use of sodium sulfate was not included in the Whittle™ analysis.

13.2.2 Whittle™ Results and Analysis

Series of nested pit shells generated by Lerchs-Grossman analysis were compared using pit by pit graph functionality in Whittle™ (see Figure 13-3). The histogram chart of the pit by pit graph is often used to visualize the relationship between mass of the potentially mineable resource and mass of waste material (un-mineable resource). The lines chart of the pit by pit graph is used to display NPV values for different mining sequences of the nested pit shells. Typical pit by pit graph in Whittle™ visualizes three mining sequences – worst case sequence, specified case sequence and best case sequence. Worst case sequence is the simplest one to achieve, and is based on mining the ultimate pit shell top down with the single bench. Worst case sequence forces much of stripping cost to happen in early years, thus hurting NPV. Best case is based on mining each pushback sequentially before starting the next. This study does not have any specified case sequence set-up; therefore the line chart for specified case sequence coincides with the worst case and can be dismissed.

Figure 13-4 provides basic comparison between the worst case mining sequence with poor NPV and best case sequence with four pushbacks. The best case sequence is harder to achieve, but it will produce higher NPV value.

Table 13.2.2.1 provides best and worst NPV case for the range of nested pit used in Whittle™ analysis. Despite of the fact that base case shell 13 is calculated using revenue factor of 1, it does not produce the positive NPV value for the worst case. Based on the conservative approach the shell 8, the largest nested pit shell with positive worst and best NPV values was selected as the optimal outline for the ultimate pit.

Table 13.2.2.1: Whittle™ Cashflow Values for Best and Worst Cases

Final	Revenue	Open Pit	Open Pit	Tonnes	Waste	Mine	Mine	IRR	IRR
-------	---------	----------	----------	--------	-------	------	------	-----	-----

pit	Factor	Cashflow		Input	Tonnes	Life Years	Life Years	%	
		best, US\$ disc	worst, US\$ disc					best	worst
1	0.76	-273,901,550	-273,901,550	14,326	0	0.0	0.0	0.0	0.0
2	0.78	-266,475,519	-266,475,519	139,517	83,698	0.1	0.1	0.0	0.0
3	0.8	-259,967,005	-259,967,005	262,234	116,227	0.2	0.2	0.0	0.0
4	0.82	-222,421,030	-222,421,030	1,252,516	360,712	1.2	1.2	0.0	0.0
5	0.84	-45,600,954	-48,650,293	10,604,434	4,147,981	10.1	10.1	4.3	4.2
6	0.86	25,020,205	10,289,308	17,777,845	7,563,833	16.9	16.9	9.3	8.5
7	0.88	70,828,310	31,607,915	28,556,374	17,581,860	27.3	27.2	10.9	9.1
8	0.9	94,181,807	13,241,789	46,832,581	35,225,787	44.9	45.0	11.3	8.4
9	0.92	98,883,604	-79,288,013	71,867,452	65,780,271	71.1	70.9	11.3	6.1
10	0.94	99,230,520	-170,862,857	89,824,611	94,573,041	93.3	93.0	11.3	4.5
11	0.96	99,256,774	-182,077,926	93,912,686	103,614,574	98.6	97.9	11.3	4.3
12	0.98	99,261,828	-185,737,699	95,638,472	107,960,676	101.0	99.9	11.3	4.2
13	1	99,263,162	-188,596,417	97,071,200	112,528,110	103.4	101.5	11.3	4.2
14	1.02	99,262,390	-189,713,120	97,845,452	115,853,286	105.0	102.4	11.3	4.1

The PEA is preliminary in nature, that it includes inferred mineral resources that are considered too speculative geologically to have the economic considerations applied to them that would enable them to be categorized as mineral reserves, and there is no certainty that the PEA will be realized.

Table 13.2.2.2 illustrates the differences in tonnages and grades between pit shell 8 and pit shell 13 using internal CoG of 21.9336 % Mg, which is based on the revenue factor 1.

Table 13.2.2.2: Comparison Between Whittle™ Economic Pit Shells 8 and 13

Parameter	Units	Nested pit shell 8	Nested pit shell 13
Mill feed	t	46,515,845	95,984,764
Waste	t	35,403,055	113,451,758
Mg average grade	%	24.66	24.28
NPV worst case	US\$	13,241,789	-188,596,417
NPV best case	US\$	94,181,807	99,263,162
Life of mine at 1.05 Mt/y	year	44	103

The Figure 13-5 shows the cross section and the plan view of nested shell 8 (marine color) and 13 (brown color)

13.3 Mine Design

A mine design was performed in Vulcan™ software using toe and crest strings. The ultimate pit is built from two pits – North and South. Each of them has three pushbacks designed using Whittle™ nested shells as the reference. Table 13.3.1 illustrates pushback heights and depths.

Table 13.3.1 illustrates some of the pushback rounded dimensions.

Table 13.3.1: Pushbacks Heights/Depths and Overall Dimensions

Pit	Phase	Highest Elev, m	Lowest Elev, m	Dimensions West-East, m	Dimensions North-South, m
North	01	1550	1370	330	340
North	02	1560	1350	370	500
North	03	1580	1330	500	610
North ultimate pit		1580	1330	510	610
South	04	1435	1380	120	130
South	05	1450	1310	280	310
South	06	1455	1270	400	480
South ultimate pit		1455	1270	400	480

13.3.1 Pit Design Parameters

A bench height of 6 m was used for both pits. Mining will occur using a triple bench configuration where a berm or catch-bench is applied each in a descending sequence on 18 m bench heights, employing triple benching between berms (catch benches).of vertical off-set. Haul roads were incorporated into the pit design using 18 m width for two-lane roads and 11 m width for single width road. Haul road grades were maintained at 10 % or less for both of the pits.

Table 13.3.1.1 contains the parameters used in the design of the pushbacks.

Table 13.3.1.1: Pit Design Parameters

Parameter	Units	Value
Overall slope angle for North pit	Degrees	50
Overall slope angle for South pit	Degrees	45
Bench height	M	6
Triple bench height	M	18
Triple bench berm width for North pit	M	8.5
Triple bench berm width for South pit	M	11.5
Road width – 2 lanes	M	18
Road width – 1 lane	M	11
Ramp grade maximum	%	10

The parameters specified above are reasonable for this scoping level design. However, these parameters will need to be verified with the additional slope stability analyses for a prefeasibility design.

Total six pushbacks were designed using nested shell 8 as the guide. Figure 13-6 shows shell 13 and the ultimate pit design, which is a combination of three North and three South pushbacks

13.3.2 Waste storage

No topsoil was identified in the geological resource model. All material within the designed pushbacks is considered either mill feed or waste. It is recommended to analyze the area for the topsoil depth, which can be store in the stockpile and used later for reclamation purposes.

The waste tonnage and volumes can be seen in a Table 13.3.2.1. North pit pushbacks will be mined completely before South pit pushbacks.

Table 13.3.2.1 provides summary for waste tonnage and volume for all the pushbacks. All South pit pushbacks will produce approximately 7.9 Mm³ of the waste material. The mined-out volume for the

North ultimate pit is approximately 19.7 Mm³. The location of the dump can be seen on the Figure 13.9.

Table 13.3.2.1: Waste Tonnage and Volumes per Pushback

Pit	phase	dump waste, t	In Situ dump waste (m3)	Swelled dump waste (m3)
North	01	4,433,284	1,658,871	2,322,420
North	02	5,378,885	2,005,397	2,807,556
North	03	10,733,536	3,995,999	5,594,399
North pit subtotal		20,545,704	7,660,268	10,724,375
South	04	239,623	90,094	126,131
South	05	4,815,174	1,786,784	2,501,497
South	06	10,195,479	3,778,489	5,289,885
South pit subtotal		15,250,276	5,655,367	7,917,513
Total		35,795,980	13,315,634	18,641,888

13.4 Mine Production Schedule

The open pit mine production schedule requires enough material movement to supply the mill stockpile with at least 3,000 t/d of potentially mineable resource for processing. The mining material is defined above 21.93% Mg in-situ providing 42 years of open pit mining operations and improves the overall grade to 24.61% Mg. The open pit production numbers are based on a 15 m x 15 m x 6 m selective mining unit block and can thus be assumed to be diluted. Table 13.4.1 details the phase inventory used in creation of the production schedule.

Table 13.4.1: Phase Inventory Details

Phase	P01	P02	P03	P04	P05	P06	Total
1. Mill Tonnes	10,971,637	9,255,255	12,240,017	354,151	3,245,793	8,003,418	44,070,272
2. Waste Tonnes	4,433,284	5,378,885	10,733,536	239,623	4,815,174	10,195,479	35,795,980
3. Total Tonnes	15,404,921	14,634,140	22,973,553	593,774	8,060,967	18,198,897	79,866,252
4. Mg Grade (%)	25.02	24.63	24.27	25.31	24.45	24.57	24.61
5. SR (w:o)	0.40	0.58	0.88	0.68	1.48	1.27	0.81
6. Mine Life	10.4	8.8	11.7	0.3	3.1	7.6	42.0

The PEA is preliminary in nature, that it includes inferred mineral resources that are considered too speculative geologically to have the economic considerations applied to them that would enable them to be categorized as mineral reserves, and there is no certainty that the PEA will be realized.

Each bench within the phase inventory was scheduled using the Chronos mine production scheduling package. Benches were mined top down in sequential order with no conflict between phase and bench precedence relationships. Figure 13-7 illustrates the life of mine production schedule and anticipated variance in Mg grade delivered to the mill.

Due to the extended mine life of the project, the set of screen captures show in Figure 13-8 illustrates 5 year increments of pit development from the start of operations.

13.5 Open Pit Operations

Mining operations at Record Ridge will be relatively simple and more analogous to a small quarry operation. There are very small changes in grade distribution so mine dilution, mine recovery and excessive haul routes will not be critical factors to the delivery of potential resource to the mill for

processing. As part of the equipment selection, rugged trucks have been chosen to deal with the mine Operations are based on a single 12 hour shift working 365 days per year.

Blasting with a powder factor of 0.3 kg/t of material has been specified to ensure good fragmentation of the rock before delivery to the crusher circuit.

Waste hauls have been estimated at 10 minutes with an additional 2.5 minutes in delays, mill material has been estimated at 15 minutes with the same 2.5 minute addition to delays.

The required labor has been estimated fully for operators but the administration staff has been purposefully kept to a minimum given the ease of operations.

Mine operating and capital costs are based on first principal SRK spreadsheet that uses information provided by cost guides sourced in the U.S.

Mine Equipment and Capital Cost

The expected open pit operations at Record Ridge call for a very low production rate but will be influenced by steep natural topography and periods of heavy snowfall rainfall. The amount of “Pioneering” work relative to production benches will also be a factor accessing the mine. As such, SRK has suggested a mining fleet comprised of rigid body (50 t) class mine trucks (ADT) that are matched with a hydraulic excavator (Equivalent to CAT 374 D) with a 4.7 CuM bucket. Using this configuration and making allowance for support equipment, the required equipment list for open-pit mining is detailed in Table 13.5.1.

Table 13.5.1: Equipment List for Open-Pit Mining

Equipment	Type	US\$ 000's	Yr1- Yr5	Yr5- Yr10	Yr10- Yr15	Yr15- Yr20	Yr20- Yr25	Yr25- Yr30	Yr30- Yr35	Yr35- Yr42
Sandvik DI 550	Blast Hole Rig	1,280	1	1	1	1	1	1	1	1
CAT 773F	Rigid Body Haul Truck	3,510	4	4	4	5	5	5	5	6
Cat 374	Hydraulic Excavator	7,820	1	1	1	1	1	2	2	2
CAT D7	Dozer	408	1	1	1	1	1	1	1	1
CAT 140K	Grader	404	1	1	1	1	1	1	1	1
Water Truck		148	1	1	1	1	1	1	1	1
Cat 416E	Ancillary Digger	137	1	1	1	1	1	1	1	1
Initial Capital		6,098								
Rebuilds and Replacement		7,668	0	219	781	219	3912	0	997	1532
Total Capital		13,766								

Mine Equipment Operating Cost

Given the level of detail required for a PEA, generic owner mining operations have been costed from first principles. It is highly likely that given the small production rates, a small mining contract may be implemented instead of purchasing dedicated mining equipment.

Table 13.5.2: Mine Operating Cost

Classification	Units	Value
Drilling	US\$000s	17,976
Blasting	US\$000s	30,743
Loading	US\$000s	15,517
Hauling	US\$000s	62,308
Roads & Dumps	US\$000s	12,257
Labor	US\$000s	42,055
Total Operating Cost	\$000s	181,184
Drilling	US\$/t	0.23
Blasting	US\$/t	0.38
Loading	US\$/t	0.19
Hauling	US\$/t	0.78
Roads & Dumps	US\$/t	0.15
Labor	US\$/t	0.53
Total Unit Operating Cost	\$/t	2.26

The major items used in the operating cost estimate include:

- Fuel cost US\$0.94/L;
- An ANFO cost of US\$786/t;
- Scaled labor cost ranging from upper management of US\$120,000/yr, US\$50,000 to US\$75,000 for operators and mid-level management and US\$40,000/yr for unskilled staff;
- Labor contains a 30% burden;
- Combined operator efficiency, mechanical availability and utilization of approximately 65% for equipment;
- Skeletal maintenance work force.

The labor schedule for the first five years and total cost over the LoM is presented in Table 13.5.3.

Table 13.5.3: Labor Schedule for First Five Years

Item	Average LoM	Year 1 No.	Year 2 No.	Year 3 No.	Year 4 No.	Year 5 No.
Mine Operations	3	3	3	3	3	3
Blasting	3	3	3	3	3	3
Equipment Operators	20	19	18	18	18	19
Mine Maintenance	8	8	8	8	8	8
Engineering	2	2	2	2	2	2
Total Mine Labor	35	35	34	34	34	35
	Total LoM	(US\$000's)	(US\$000's)	(US\$000's)	(US\$000's)	(US\$000's)
Mine Operations	13,137	306	306	306	306	306
Blasting	7,267	169	169	169	169	169
Equipment Operators	53,170	1,235	1,235	1,170	1,170	1,170
Mine Maintenance	23,329	540	540	540	540	540
Engineering	5,590	130	130	130	130	130
Total Mine Labor Cost	102,492	2,379	2,379	2,314	2,314	2,314

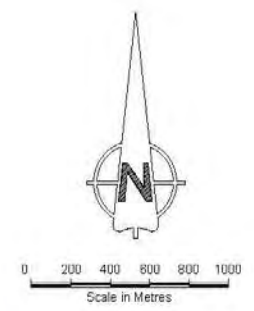
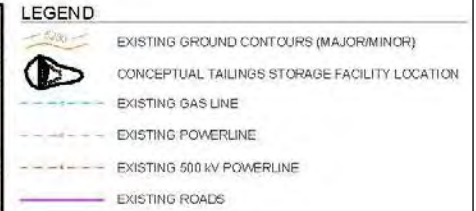
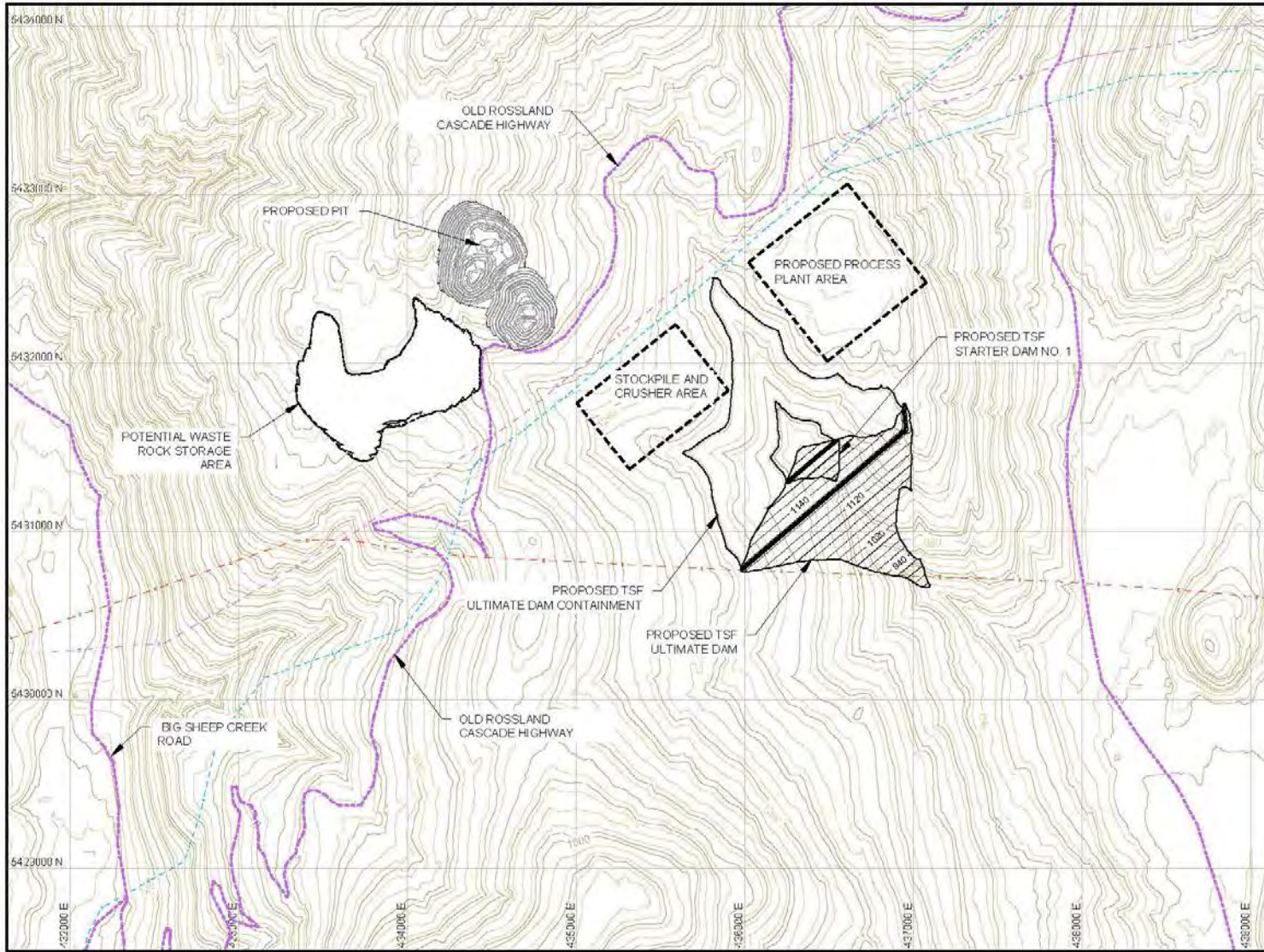

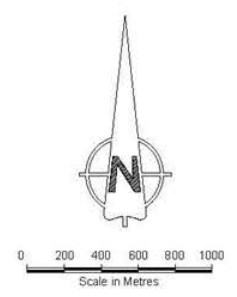
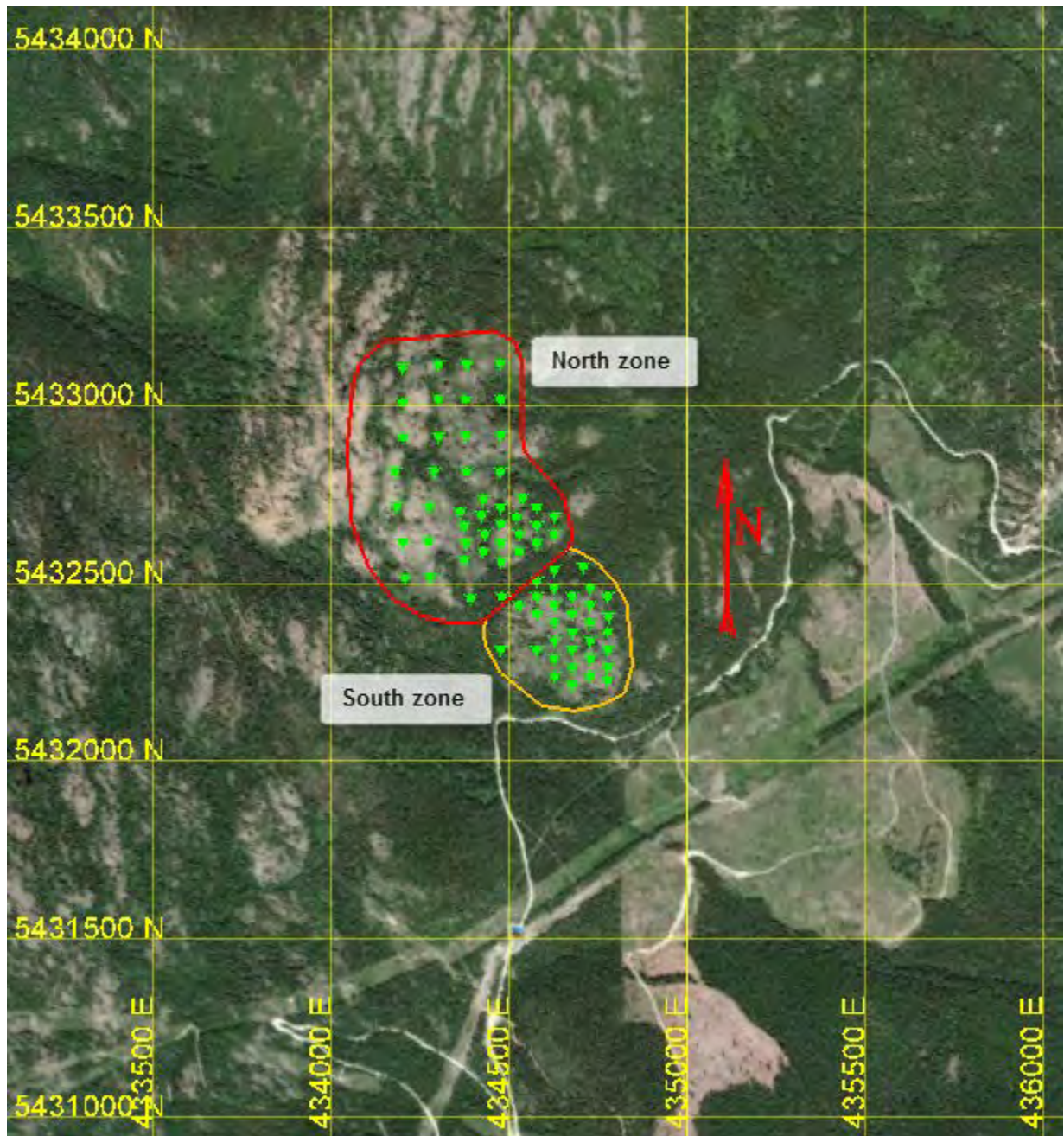

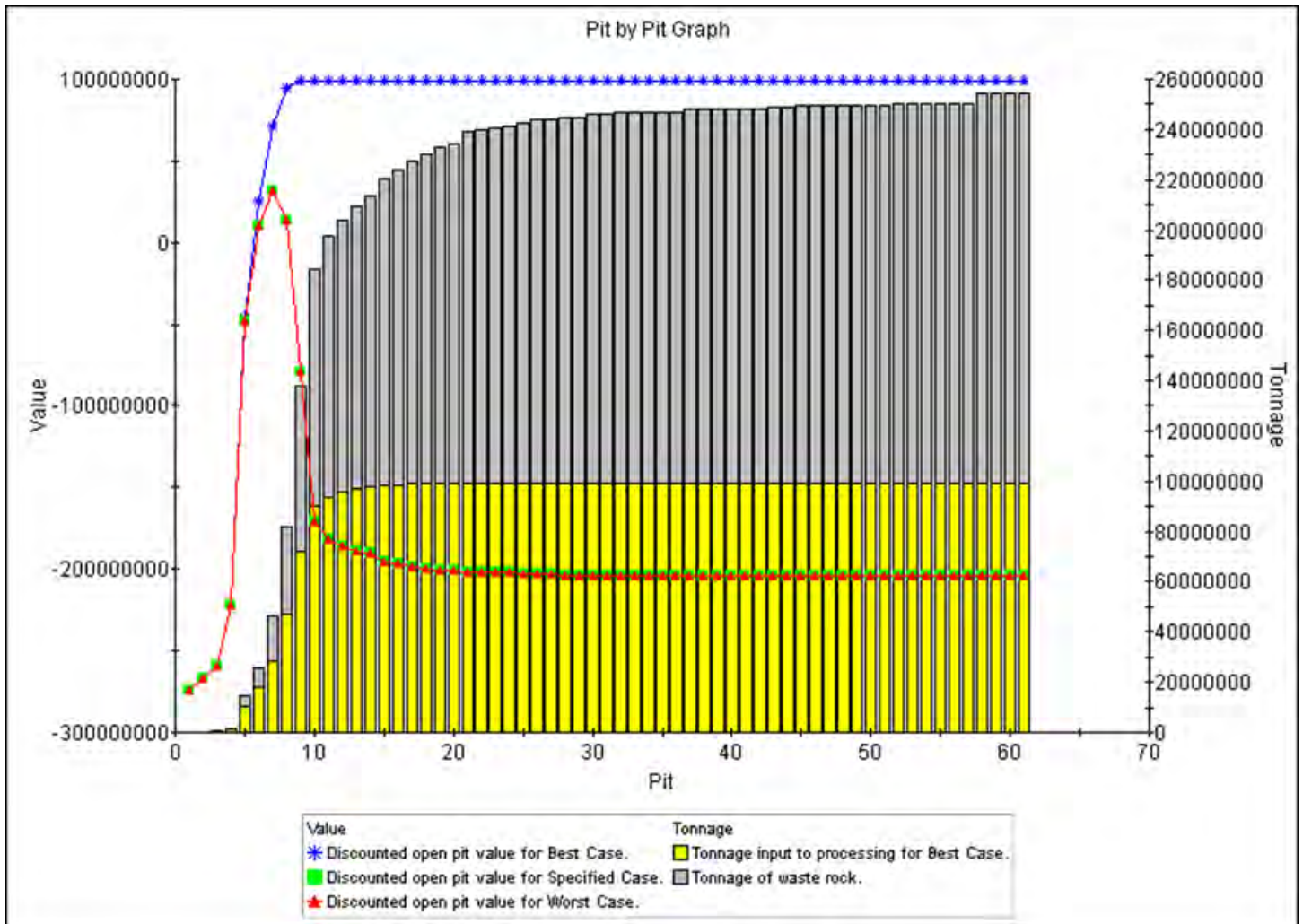

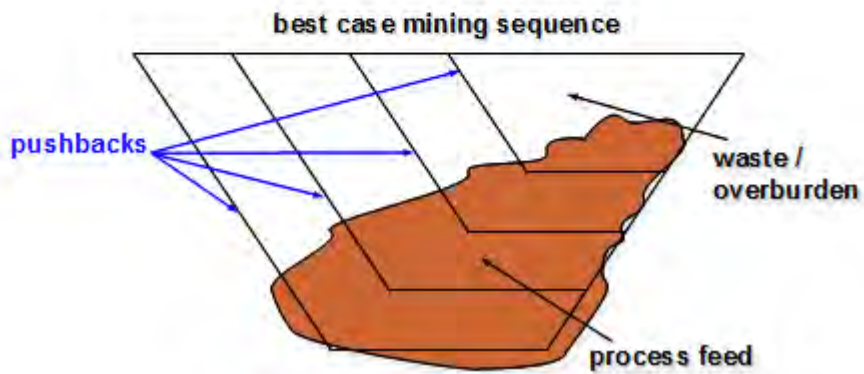
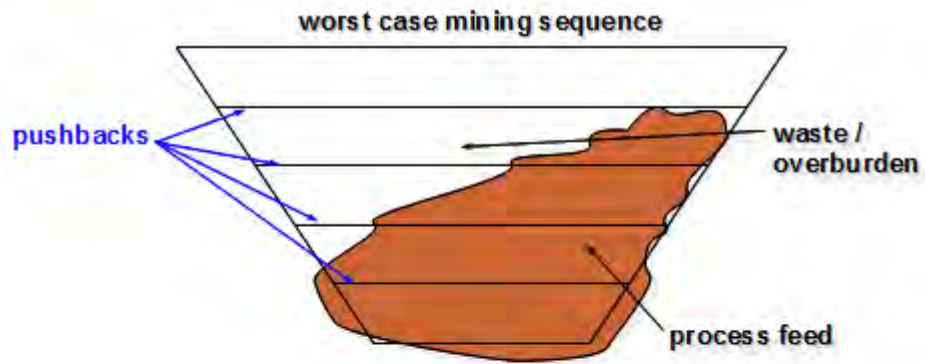

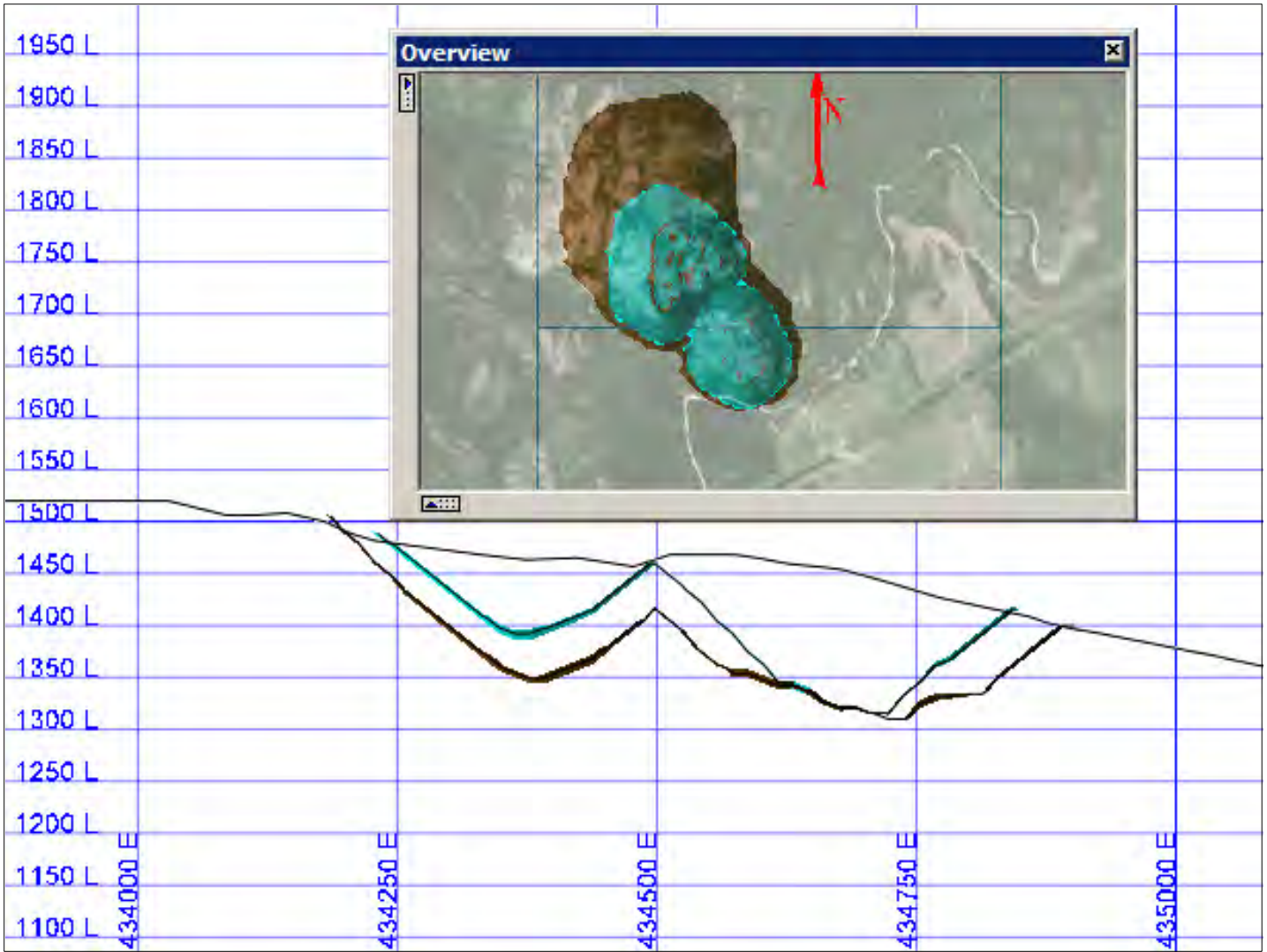

Comparison of the economic Whittle™ pit shell 8 (blue color, smaller) to 13 (brown color, larger) in the section view

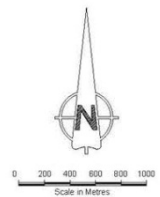
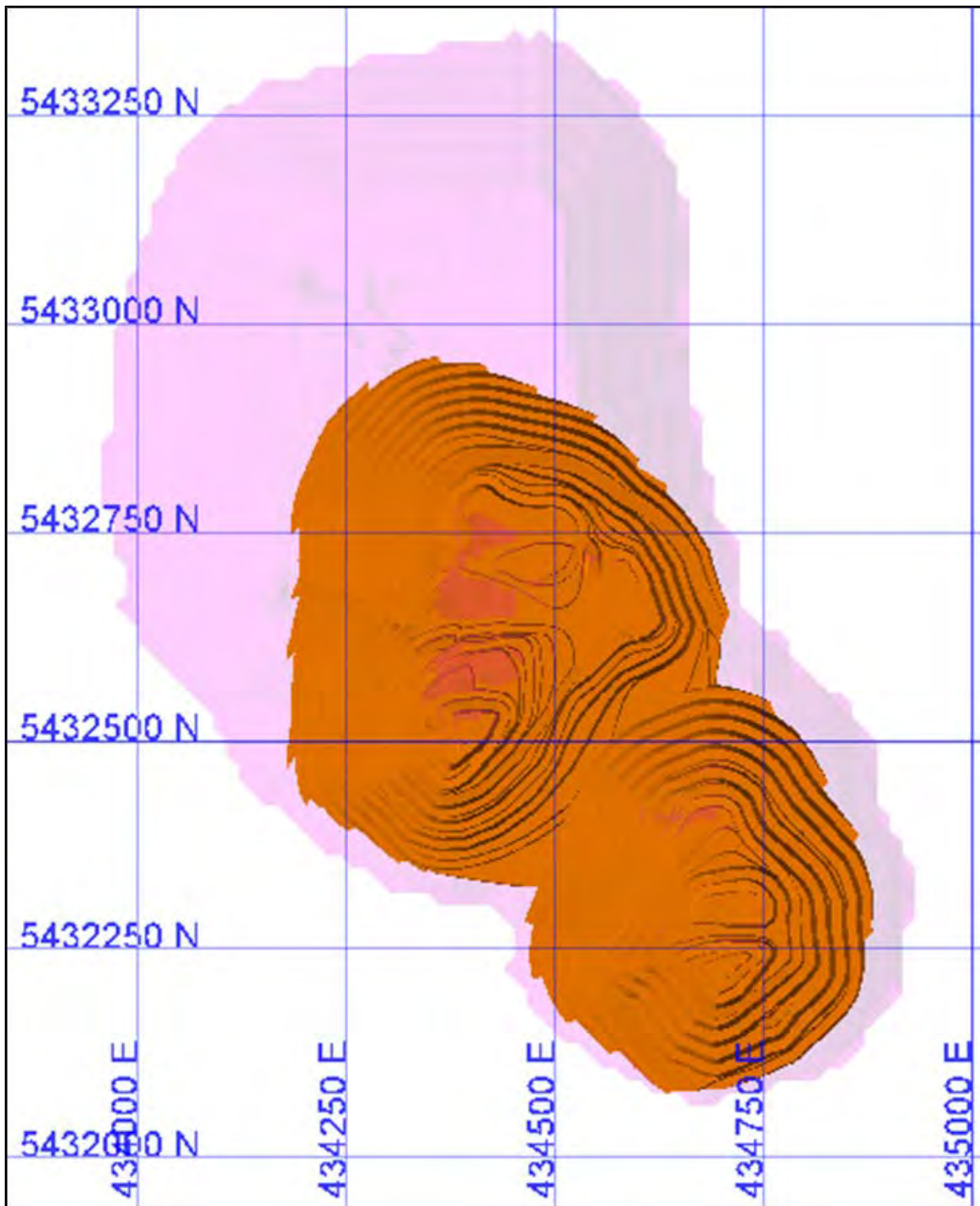

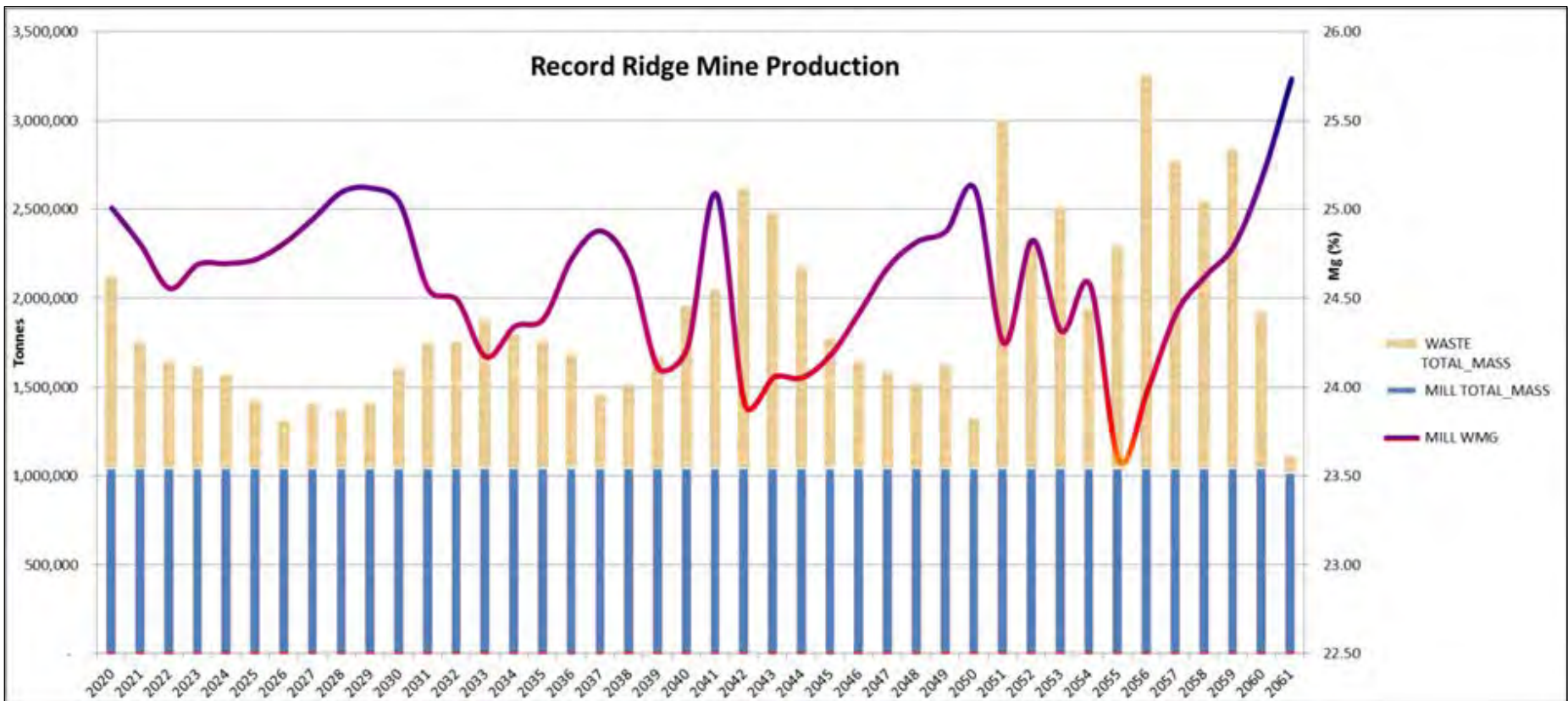

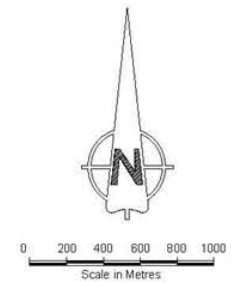
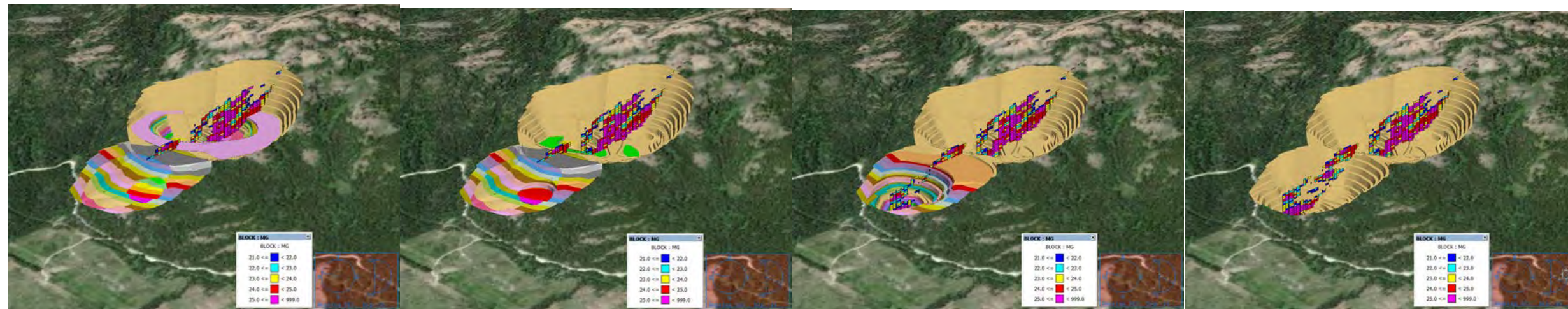
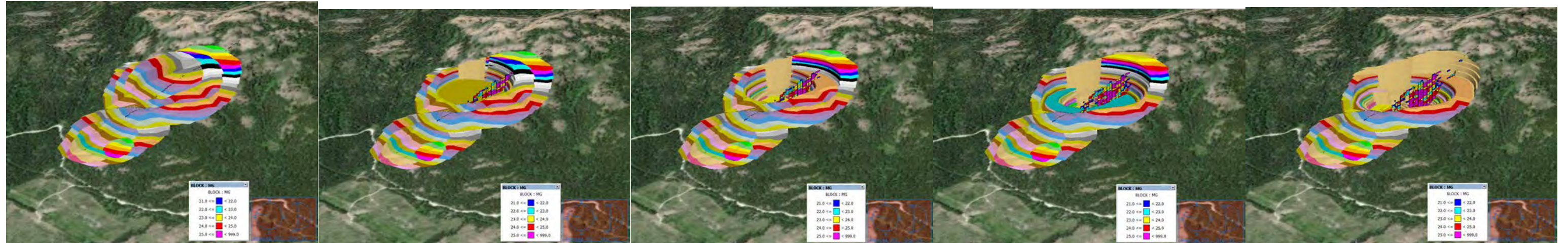

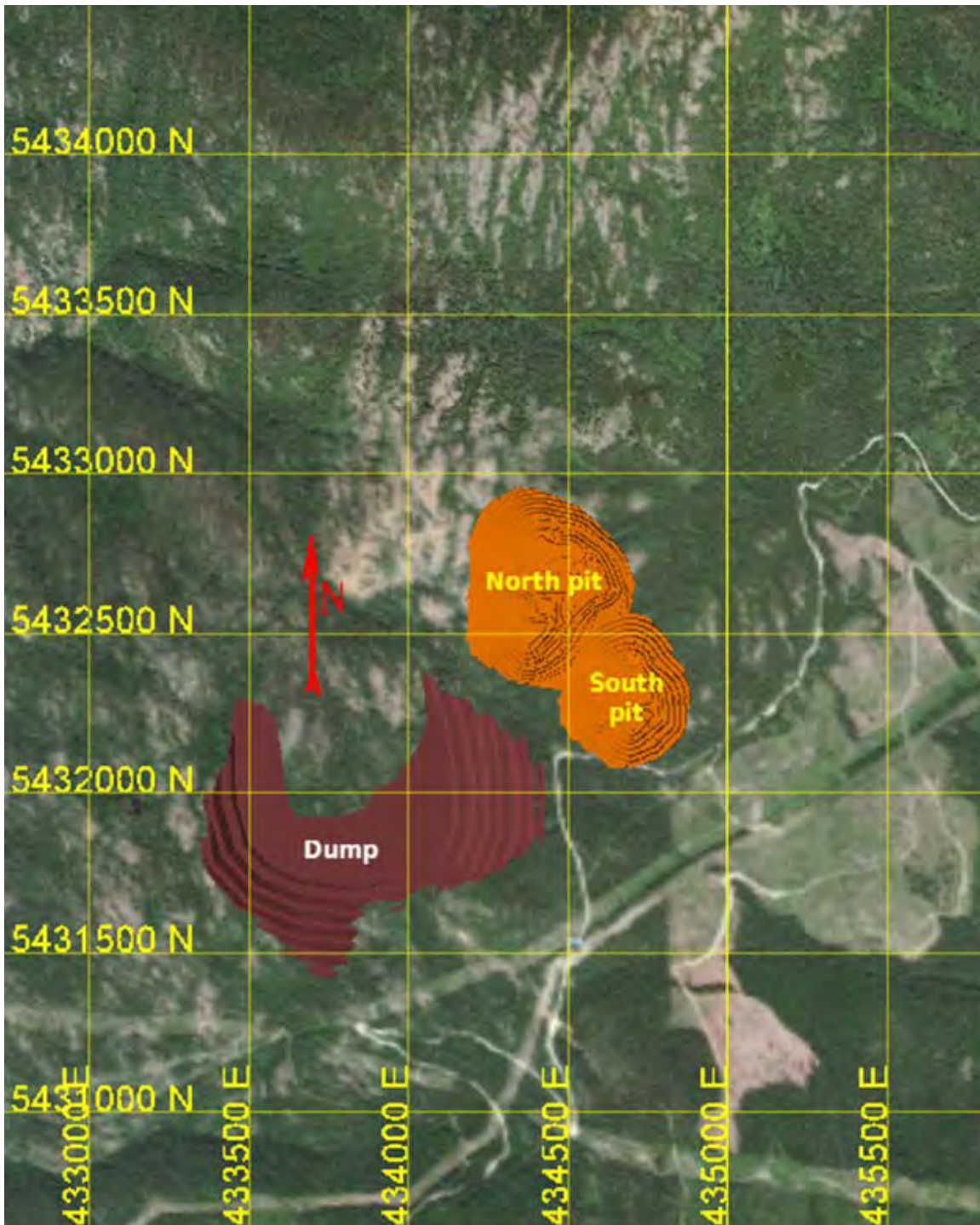

14 Recovery Methods (Item 17)

Based on the testing and analysis completed to date coupled with many key assumptions and suggestions for further work noted at the end of this chapter a process description, design criteria and a flowsheet were postulated and evaluated. The reader is referred to Section 11 of this report for a summary of metallurgical analysis and testing performed in support of this study. Pertinent scoping level +/- 35 % capital and operating estimations are also included.

14.1 Major Design Criteria

The following design criteria establish the design parameters that are to be followed in project design and execution. The criteria have been compiled from the various sources listed below. The source for a particular criterion is identified per the code in the following listing:

- CAMP – Center for Advanced Mineral and Metallurgical Processing;
- DER – Derived or Calculated Result EST – Estimated;
- IND – Industrial Practice MS – Met Solve SRK – SRK Consulting; and
- WHY – WHY Resources.

Table 14.1.1: Design Criteria

Criteria	Units	Value	Source	Comments
Resource Treatment Rate	t/d	3,000	WHY	
Annual Operating Days	Days	350	WHY	
Mg Content in Resource	%	24.61	SRK	
Crushing & Grinding	days per week	7	SRK	
Mg Leaching & Precipitation	days per week	7	SRK	
Mg Leach Recovery	%	80	MS	Est. closed cycle
Sulfuric Acid Consumption	t/t	1	MS	Est. closed cycle
Soda Ash Consumption	t/t	1	MS	
MgCO ₃ Drying & Calcination	days per week	7	SRK	
Sulfuric Acid Plant	t/d	3,000	SRK	
Fused Magnesia Plant Capacity	t/y	345,000	WHY	
Fused Magnesia Plant Energy	kWh/t	2,680	IND	
Sodium Sulfate Plant Capacity	Mt/y	1.5	SRK	

14.2 Process Description

The mined magnesium oxide bearing material will be delivered to the comminution circuit. It will undergo primary crushing with a jaw crusher. The crushed materials will then be accumulated in storage for eventual grinding. Close circuit grinding will be undertaken with a SAG and ball mill system with interstage hydrocyclone classification to control energy use and product size. The ground material will then undergo liquid solid separation via thickening with water reclaim back to the comminution circuit. The ground solids will then be treated hydrometallurgically by leaching magnesium with sulfuric acid. The sulfuric acid will be produced on site by burning elemental sulfur. The majority of the heat from the acid plant will be reclaimed in the form of steam for use in the plant and also potentially as co generated electrical power as needed in the process. The leaching will be conducted in a series of continuous stirred tank reactors heated by steam produced from the acid plant. The leach slurry will be treated with WHY magnesium oxide materials and forced aeration to neutralize excess sulfuric acid, precipitate impurities such as iron and leach more magnesium into solution. The leached and neutralized materials will then be subjected to a counter current

decantation circuit for effective liquid solid separation and liquid reclaim. The leached solids will be filtered and deposited in a managed waste repository on site. The recovery of magnesium will be via carbonate precipitation by the addition of soda ash. The precipitated magnesium carbonate will be filtered away from the solution. These clarified solutions will then undergo triple effect evaporation crystallization using heat from the acid plant for removal and recovery of by product sodium sulfate solids. The solution is then recycled back to the hydrometallurgical leaching process stage. If the plant solution balance requires it, a portion of the solution can be treated by filtration, ion exchange and reverse osmosis to produce a clean waste water product for discharge or reuse elsewhere in the mining operation. The magnesium carbonate produced is dried and calcined with heat from acid plant to a burned magnesium oxide product. Then the burned magnesium product is fused in an electric furnace to produce fused magnesia for sale. Any waste products from drying, calcining or fusion will be recycled back through the process to eliminate solid wastes and maximize require utilization.

A simplified flowsheet is presented in Figure 14-1. This flowsheet is not conceptual or theoretical when it comes to final production of fused magnesia. It is a commonly practiced process based on unit operations of alkaline precipitation, calcination, fusion and consolidation that is industrially practiced globally on a large scale.

14.3 Key Process Assumptions, Potential Risks and Further Suggested Work

- 1) Key parameters such as crushing energy indices as well all comminution abrasion indices need to be refined. As well, further work needs to be done to refine the optimal crush and grind size for optimal leaching recovery.
- 2) The Mg leaching recovery is estimated to be 80% overall assuming that with closed cycle plant operations coupled with effective heat input, the majority of the leached magnesium will eventually report as a final product. This needs further optimization and verification at the laboratory and pilot scale in a closed operational system.
- 3) It is assumed that waste and by-product MgO containing materials will be available and may effectively be used for neutralization of excess acid and solubilized iron precipitation in conjunction with aeration after leaching. Further test work needs to be done to confirm and optimize this.
- 4) It is assumed with on-site sulfuric acid production and the subsequent excess exothermic energy production, the overall process is net positive or at least balanced in heat energy required. This needs to be carefully analyzed, quantified and confirmed.
- 5) It is assumed that electrical energy is available at the rates disclosed herein for key energy consuming unit operations such as comminution and MgO fusion.
- 6) It is assumed that a sufficient supply of bulk elemental sulfur and soda ash can be available at the plant site. This needs to be further investigated.
- 7) Further focused leach testing with optimization and closed cycle testing of representative samples needs to be done to confirm reagent consumptions and to achieve enhanced Mg recoveries to solution.
- 8) No actual production of fused magnesia from WHY materials has been tested or confirmed. This needs to be carefully tested and confirmed with representative samples. In addition the competitive and economic impact of the proposed very large-scale production of fused magnesia by WHY on world market capacity must be addressed. The calcination of $MgCO_3$

to MgO and then the fusion of MgO are well established global technologies. The leaching with sulfuric acid is novel but precipitation of Mg from solution via pH adjustment as a carbonate or more commonly as a hydroxide is well known and practiced industrially. So, as in the course of any project endeavor, as one moves toward prefeasibility and then feasibility levels of engineering designs and studies, more research and testing is normally required.

- 9) It is assumed that a very large volume of high quality by product sodium sulfate will be produced and sold. As no actual sodium sulfate product has been produced from WHY materials to date; this needs to be confirmed and the impact on market and pricing evaluated.
- 10) An overall mass, heat and water balance needs to be carried out to refine actual recoveries, net energy use and to quantify air, water and solid discharges.

14.4 Operating and Capital Cost Estimates

Based on the open cycle metallurgical testing done to date, coupled with standard key assumptions, the following operating and capital costs estimates were formulated. In addition, the capital and operating costs were adjusted as deemed necessary for the estimated 80% overall recovery of MgO from the previous estimate of 60% overall recovery of MgO.

Table 14.4.1: Scoping Level Operating Cost Estimate, Per Tonne of Material Treated +/-35%

Item	Cost US\$
Management	1.50
Hourly Labor	6.00
Comminution Media	1.50
Comminution & Leach Energy	5.00
Fused MgO Energy	40.00
Repair and Maintenance	0.75
Supplies and Analytical	2.00
Hydrometallurgical Reagents	200.00
Corporate G&A	1.89
Total	\$258.64

Table 14.4.2: Scoping Level Capital Cost Estimate, +/- 35 %

AREA	#	Equipment	Equip #	Description	Number	Price FOB	Total	
Comminution	1	ROM Ore Bin	OC-1	With Grizzly	1	\$ 30,000.00	\$ 30,000.00	
\$13,287,000	2	Grizzly Feeder	OC-2	Storage Bin	1	\$ 35,000.00	\$ 35,000.00	
	3	Jaw Crusher	OC-3	Primary Crushing	1	\$ 250,000.00	\$ 250,000.00	
	4	Chutes	OC-4	Crusher Discharge	1	\$ 5,000.00	\$ 5,000.00	
	5	Rock Breaker	OC-5	Pivot Mounted	1	\$ 60,000.00	\$ 60,000.00	
	6	Conveyor	OC-6	Jaw Crusher Discharge	1	\$ 15,000.00	\$ 15,000.00	
	7	Conveyor	OC-7	Coarse Ore Pile	1	\$ 60,000.00	\$ 60,000.00	
	8	Weightometer	OC-8	0.05% Accuracy	1	\$ 5,000.00	\$ 5,000.00	
	9	Dust Control	OC-9	System	2	\$ 15,000.00	\$ 30,000.00	
	10	Tramp Magnet	OC-10	System	1	\$ 2,500.00	\$ 2,500.00	
	11	Metal Detector	OC-11	System	1	\$ 2,500.00	\$ 2,500.00	
	12	Conveyor	OC-12	Coarse Ore Bin	2	\$ 65,000.00	\$ 130,000.00	
	13	Coarse Ore Reclaim	OC-13	Chutes & Feeder	1	\$ 100,000.00	\$ 100,000.00	
	14	Ore Bin	OC-14	Coarse Ore	2	\$ 30,000.00	\$ 60,000.00	
	15	SAG Mill Conveyors	OC-15	Coarse Ore	2	\$ 15,000.00	\$ 30,000.00	
	16	SAG Mill Feed	OC-16	Spouts & Chutes	2	\$ 5,000.00	\$ 10,000.00	
	17	SAG Mill Discharge	OC-17	Weightometer	2	\$ 6,000.00	\$ 12,000.00	
	18	SAG Mills	OC-18	System	2	\$ 5,000,000.00	\$ 10,000,000.00	
	19	Ball Mills	OC-19	System	2	\$ 1,000,000.00	\$ 2,000,000.00	
	20	Ball Mill Sump	OC-20	System	2	\$ 60,000.00	\$ 120,000.00	
	21	Cyclones	OC-21	System	2	\$ 50,000.00	\$ 100,000.00	
	22	Reclaim Thickener	OC-22	System	1	\$ 150,000.00	\$ 150,000.00	
	23	Scat Screen & Conveyor	OC-23	System	2	\$ 40,000.00	\$ 80,000.00	
Mg Leaching & Precip	1	CSTR Leaching Train	MgL-1	System	2	\$ 1,250,000.00	\$ 2,500,000.00	
\$ 5,625,000.00	2	CCD Circuit	MgL-2	System	2	\$ 750,000.00	\$ 1,500,000.00	
	3	Conditioning & Reclaim Tank	MgL-3	System	2	\$ 100,000.00	\$ 200,000.00	
	4	Heat Exchangers	MgL-4	System	1	\$ 125,000.00	\$ 125,000.00	
	5	Pumps	MgL-5	System	2	\$ 100,000.00	\$ 200,000.00	
	6	Filtration	MgL-6	System	2	\$ 300,000.00	\$ 600,000.00	
	7	Leached Ore Thickener	MgL-7	System	1	\$ 200,000.00	\$ 200,000.00	
	8	MgO Precipitation	MgL-8	System	1	\$ 300,000.00	\$ 300,000.00	
MgO Calcination	1	Calcination Kiln & Handling	MgOC-1	System	1	\$ 2,500,000.00	\$ 2,500,000.00	
\$2,800,000	2	Gas Handling	MgOC-2	System	1	\$ 300,000.00	\$ 300,000.00	
							\$ 21,712,000.00	
AREA		Equipment	Installation	Piping & Instrumentation	Auxiliaries	Engineering	Sub Total	Contingency
			43%	45%	20%	15%		25%
Comminution		\$13,287,000	\$5,713,410	\$8,550,185	\$3,800,082	\$4,702,601	\$36,053,278	\$9,013,319
Mg Leaching & Precip		\$5,625,000	\$2,418,750	\$3,619,688	\$1,608,750	\$1,990,828	\$15,263,016	\$3,815,754
MgO Calcination		\$2,800,000	\$1,204,000	\$1,801,800	\$800,800	\$990,990	\$7,597,590	\$1,899,398
Metallurgical Facilities Buildings							\$6,296,480	\$1,574,120
Sodium Sulfate Plant & Building							\$10,000,000	\$2,500,000
Sulfuric Acid Plant & Building							\$150,000,000	\$37,500,000
Fused Magnesia Plant & Building							\$225,000,000	\$56,250,000
First Fills							\$2,500,000	\$625,000
Column Totals		\$21,712,000	\$9,336,160	\$13,971,672	\$6,209,632	\$7,684,420	\$452,710,364	\$113,177,591
5/2/2013 16:33							TOTAL CAPITAL COSTS:	\$565,887,955

WHY Resources Fused Magnesia Flowsheet

WHY Resources Magnesium Oxide Material

Comminution

H₂SO₄ Plant

MgO Leaching and Precipitation

Na₂SO₄ Plant

MgCO₃ Calcination to MgO

Fused MgO Production

15 Project Infrastructure (Item 18)

15.1.1 Access Road and Transportation

The Project is located central to Vancouver, B.C., Calgary, Alberta and Spokane, WA, U.S. It is serviced by the Canadian national highway system and by U.S. highways to the south. Road access is excellent from any of these major cities. Trail is serviced by the Canadian Pacific (CP) Railway. This system routes directly to Calgary, Alberta or Vancouver, B.C. The CP railway also ties southward into the Burlington Northern Santa Fe Rail (BNSF) system near Cranbrook, B.C. approximately 150km to the east. The BNSF rail services the north and northwestern United States.

The old highway from Rossland, B.C. (Rossland – Cascade Highway) that runs adjacent to the proposed plant site would be upgraded to allow for the increased traffic to the proposed site. Approximately 8km would be upgraded with an estimated cost of US\$550,000. The details of the access roads, transportation, power, water, etc. are shown in Figure 15-1.

15.1.2 Power Supply

Abundant hydro-electrical power is available in the area. The smelter at Trail is supplied by British Columbia Hydro and sourced from two locations. The Waneta Plant is located 7 km downstream on the Columbia River and the Brilliant hydroelectric plant is located 25 km upstream near Castlegar, B.C. The two mineral claims covering the magnesium mineralization are both traversed by electrical transmission lines leading from Rossland westward. These lines would not however need to be moved if mining were to occur.

The nearby 500 kV power line is expected to be used as the electrical power source for the mine and processing operations. After all required approvals from British Columbia Hydro a tap and substation would be constructed near the 500kv main power line. The processing facilities are expected to consume a large amount of electrical power and it is expected that a short 230 kV overhead line would be constructed from the main power line to the new plant substation. At this point the electrical power will be distributed to the buildings and facilities as required. Power lines, switchgear and transformers are estimated to cost US\$550,000.

A main natural gas pipeline is also adjacent to the proposed plant site. A tap and associated natural gas line distribution is estimated to cost US\$150,000. Natural gas will be used to heat the building as well as domestic hot water requirements.

15.1.3 Water Supply

The area also has an abundant water supply. The region's high precipitation index, feeds numerous surface and underground water sources. Water rights are governed by the "Water Act", which is administered by the Water Stewardship Division of the Ministry of Environment. Both surface and underground water rights are granted on an equal access, first come first serve basis. When a water license is issued, annual water rentals are assessed based on usage.

Domestic water will be required for the operations with an estimated cost of US\$150,000. Waste water treatment will also be required based on the expected water balance for the project. An estimated US\$150,000 has been allocated for this purpose.

15.1.4 Sodium Sulfate – Bagging / Warehouse Facility

The processing plant is expected to generate approximately 4,200 t of sodium sulfate per day. The salt product will be transferred to 2 t bags and stored in an enclosed warehouse on site. Over the road trucks will haul the bags to Trail, B.C. where they will be warehoused and subsequently transferred to rail cars for distribution. Based on nominal haul cycle times for the trucks and the estimated hours of operation, a fleet of 17 road trucks will be required to handle the forecast amount of production. Trail has an extensive rail infrastructure and the use of existing facilities is expected for the transfer of the bags to railcars.

The bagging / warehouse facility will require approximately 3,000 m² for the bagging equipment, storage of 2 days of salt production and dock area for the transfer of the bags to the over the road trucks. The estimated cost for this facility is US\$3,100,000 and is included in the cost estimate.

15.1.5 Tailings Storage Facility

Conventional tailings will be stored in a valley fill TSF located adjacent to and immediately downgradient of the proposed stockpile / crusher area and process plant area as shown in Figure 15-1. The TSF will be constructed in several phases using the downstream embankment construction method. The starter embankment was designed to contain a minimum 2 years' deposition, based on an annual production rate of 1.25 Mt/y and would be constructed from a quarry inside the upstream basin of the TSF in order to generate additional storage volume. Raises above the starter embankment would be constructed with waste rock from the mine and augmented with additional quarry as required from the upstream TSF storage basin.

This facility was assumed to be a fully contained lined facility due to unknown geochemistry of the tails and the mill site treatment process treatment using sulfuric acid. Thus, a low-permeability composite liner system consisting of an 80 mil HDPE geomembrane underlain by a geosynthetic clay liner (GCL) was assumed for the quantity and cost estimates. The TSF was laid out with 2.5 horizontal to 1 vertical upstream and downstream slopes with a 10 m crest width and was designed to contain 55.7 Mt of tailings at an assumed density of 1.3 tpm. A cost estimate was developed for the starter dam and the ultimate dam as shown in Table 15.1.5.1.

Table 15.1.5.1: Estimated TSF Construction Costs

Area	Estimated Cost (US\$)
Starter Dam	11,309,225
Ultimate Dam	96,882,825
Subtotal	108,192,050
Contingency (25%)	27,048,013
Total	135,240,063

No contingency was placed on waste rock haulage to construct the tailings dam. All other items had a 25% contingency applied.

Additional conclusions from SRK's evaluation of the TSF include the following:

- This facility location has adequate capacity for expansion should additional resources be deemed economically feasible;
- The TSF as laid out will not be visible from Rossland, B.C.;

- The TSF was laid out immediately downgradient of the stockpile and crusher area and the process plant, making for a very compact mining footprint. Additionally, should there be any tailings pipeline rupture or spill in the process area, then it would be contained in the TSF; and
- The TSF, as currently laid out, appears to impact a small portion of the Dewdney trail along the left or southwest abutment. There is ample room to adjust the embankment orientation to miss this trail should it be deemed unsatisfactory to relocate the trail.

15.1.6 Closure Costs

At the end of the mine life an approved closure plan will be implemented to remove the facilities, re-contour the disturbed areas, spread topsoil, reseed the area with native grasses and replant with native trees. A storm water diversion system of ditches will direct any excess storm water to the open pit area and the open pit area will be allowed to fill with water and an overflow spillway with natural looking velocity control structures will be installed to prevent erosion. Table 15.1.6.1 is a summary of the closure costs estimated to be US\$16,301,475.

Table 15.1.6.1: Estimated Closure Costs

Area	Estimated Cost (US\$)
Buildings - Demolition and Salvage	850,000
Plant site - Re-contour all areas, spread topsoil	255,000
Re-vegetation – Grasses and Trees	280,000
Pit and Storm water diversion structures	200,000
Tailings Closure	9,257,650
Mob and Demob	25,000
Total Direct	\$10,867,650
Supervision and Profit (20%)	2,173,530
Subtotal	\$13,041,180
Contingency (25 %)	3,260,295
Total	\$16,301,475

C:\Users\mhastings\Documents\ArcGIS\Projects\Record Ridge\fig_01_general_layout\fig_01_general_layout.mxd

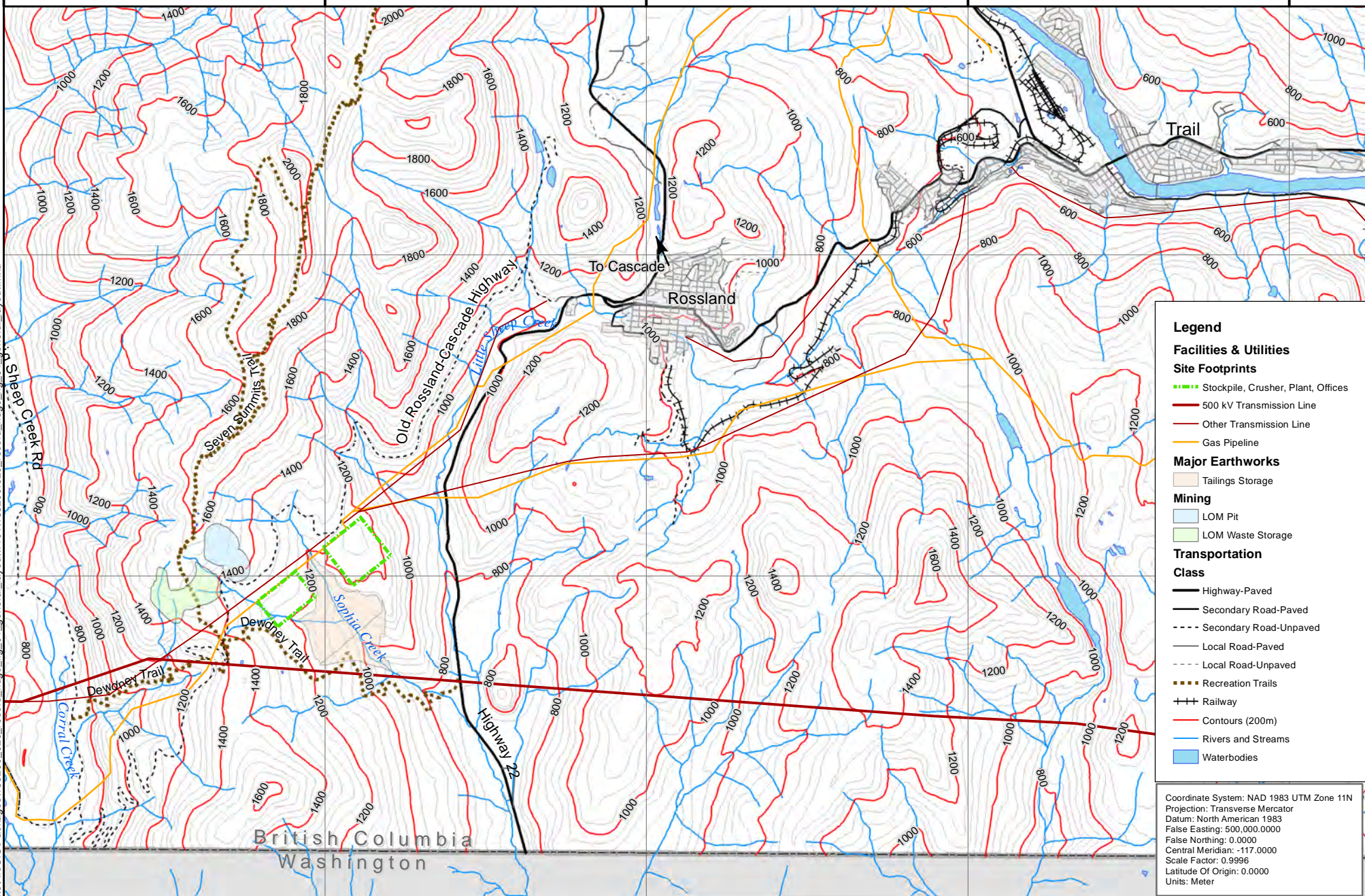

- Legend**
- Facilities & Utilities**
- Stockpile, Crusher, Plant, Offices
 - 500 kV Transmission Line
 - Other Transmission Line
 - Gas Pipeline
- Major Earthworks**
- Tailings Storage
- Mining**
- LOM Pit
 - LOM Waste Storage
- Transportation**
- Class**
- Highway-Paved
 - Secondary Road-Paved
 - Secondary Road-Unpaved
 - Local Road-Paved
 - Local Road-Unpaved
 - Recreation Trails
 - Railway
 - Contours (200m)
 - Rivers and Streams
 - Waterbodies

Coordinate System: NAD 1983 UTM Zone 11N
 Projection: Transverse Mercator
 Datum: North American 1983
 False Easting: 500,000.0000
 False Northing: 0.0000
 Central Meridian: -117.0000
 Scale Factor: 0.9996
 Latitude Of Origin: 0.0000
 Units: Meter

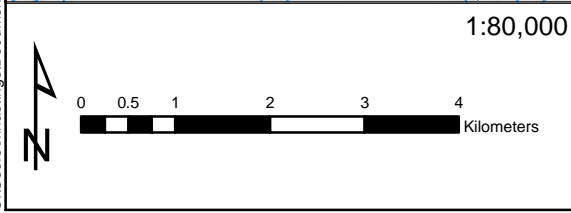

srk consulting

Job No: 183200.020
 Filename: 183200.020_record_ridge_fig_01_general_layout

Record Ridge Project

Record Ridge Project Infrastructure Layout	
Date: Jan 2013	Approved: AL
Figure: 15-1	

5437158
5432158
5427158

16 Market Studies and Contracts (Item 19)

16.1 Summary of Information

Record Ridge will potentially sell Electro-fused Magnesia and Sodium Sulfate (Na₂SO₄ - Commonly known as Glauber salt) both of which are industrial mineral products without a known spot price.

SRK has used two independent reports as the basis for determining product pricing.

SRK has analyzed information presented by Roskill Consulting Group Ltd, “*West High Yield Resources - Short report on High Grade Magnesia Pricing and Quality, 2nd November, 2012*” (Roskill, 2012) for the market studies and Electro Fused Magnesia (EFM) pricing information in this report. The Roskill Consulting Group is a privately owned, independent consulting company that uses its staff to determine global production, demand and price of industrial minerals, and in this case, Electro Fused Magnesia. SRK is of the opinion that the information provided in the Roskill Report provides a reasonable analysis of EFM pricing and does not see any evidence that the pricing information is misleading or erroneous. There are still significant risks involved in valuation of EFM that include, the effect of new production on world market, purity of EFM product, competition from new producers, end-use demand of EFM and no letters of intent or off-take agreements presented by WHY. SRK conducted a web based search to validate the price of EFM price reported by Roskill and generally found electro fused magnesia ranged from US\$300/t for low quality EFM (87% MgO) through to US\$3000/t for (+98% MgO) these ranges support the figures presented by Roskill and used by SRK as a base price.

SRK has analyzed information presented by Merchant Research and Consulting Ltd, “*Sodium Sulfate World Market Outlook and Forecast, 2011*” (Merchant 2012) for the market studies and sodium sulfate (Glauber Salt) pricing information presented in this report. Merchant Research & Consulting, Ltd is a specialist research consultancy and author of market research publications for the chemical and related industries. SRK is of the opinion that the information provided in the Merchant report provides a reasonable analysis of sodium sulfate pricing and does not see any evidence that the pricing information is misleading or erroneous. There are still significant risks involved in valuation of sodium sulfate that include, the effect of new production on world market, purity of sodium sulfate product, competition from new producers, end-use demand of sodium sulfate and no letters of intent or off-take agreements for sodium sulfate presented by WHY. SRK conducted a web based search to validate the price of sodium sulfate reported by Merchant and generally found sodium sulfate ranged from US\$80/t for product produced in China up to US\$300/t depending on quality. As such, SRK is of the opinion that the researched ranges support the figures presented by Merchant and used by SRK as a base case.

Based on SRK’s evaluation of the two source documents, the suggested pricing for EFM and Sodium Sulfate are detailed in Table 16.1.1 that assumed pricing to be FOB Record Ridge.

Table 16.1.1 Record Ridge Commodity Pricing

Product	Units	Price (FoB Record Ridge)
Electro-fused Magnesia	US\$/t	1,100.00
Sodium Sulfate	US\$/t	75.00

16.2 Nature of Material Terms

The price of Electro-fused Magnesia (EFM) and Na₂SO₄ (Glauber Salt) products sold to the market are material to the Project. As these markets are not traded similar to other metals such as copper, gold, silver etc., determining an actual price is reliant on public information concerning contract pricing between producers and consumers of the product.

As there are no contract or off take agreements signed by WHY resources, SRK has used 3rd party market studies to base its assumptions. SRK would also re-emphasize that a PEA is preliminary in nature, that it includes inferred mineral resources that are considered too speculative geologically to have the economic considerations applied to them that would enable them to be categorized as mineral reserves, and there is no certainty that the PEA will be realized.

With prices estimated using industry analysis and research, the effect of adding supply to the market of both products, in the quantities suggested in this report, are unquantifiable at this level of study. SRK is of the opinion that the increase in supply may reduce the price achieved for the products if the project were to proceed and is unable to estimate those changes at this time (2013). Conversely, new technological innovations requiring magnesium may increase the market price or absorb the higher supply were WHY to produce large quantities of EFM.

16.2.1 Electro-fused Magnesia

Electro-fused magnesia (EFM) will be the end product produced at Record Ridge if the processing plant is developed.

Fused magnesia (FM) is produced by electric arc furnace melting of magnesite (mid-product at Record Ridge), in a traditional Higgins furnace or in tilt-type furnace at >2,750°C.

EFM is divided into either refractory or electrical (also referred to as EFM or EGM) grades depending on the end use. Refractory EFM has a lower silica content, a higher calcia:silica ratio, and a higher density than EGM. The silica content of EGM is also low but essential since it enhances the material's electrical properties.

The laboratory results for the Record Ridge product specifications were analysed for two Met-Solve samples and the average of the results are shown in Table 16.2.1.1.

Table 16.2.1.1: Product Specifications for EFM

Al ₂ O ₃	BaO	CaO	Cr ₂ O ₃	Fe ₂ O ₃	K ₂ O	MgO	MnO	Na ₂ O	P ₂ O ₅	SiO ₂	TiO ₂	SrO	S	Ni	Co	Zn	Total
%	%	%	%	%	%	%	%	%	%	%	%	%	%	ppm	ppm	ppm	%
<0.01	<0.01	0.73	<0.01	0.08	0.06	99.2	0.22	0.09	<0.01	0.10	<0.01	<0.01	0.05	1522	64.6	56.4	101

If this product was achievable to the levels reported in a lab environment, the EFM product for re-sale would be considered high grade.

As a comparison, Table 16.2.1.2 details some typical specifications for EFM products.

Table 16.2.1.2: Typical Specifications EFM

Item	Country	MgO	CaO	SiO ₂	Fe ₂ O ₃	Al ₂ O ₃ (%)	B ₂ O ₃	CaO: SiO ₂	BD	PCS (ppm)
Baymag	Canada	97.2	1.7	0.4	0.5	0.17		4	3.5	1800m
QMag EFH1	Australia	97.6	1.8	0.35	0.1	0.05	<30	5	3.55	1000 typ
QMag EFH2	Australia	96	3	0.7	0.1	0.1	<30	4	3.48	600 typ
Magnelec 99	Mexico	98.8	0.8	0.2	0.1	0.1	<10	4	3.5	300-2000
Elfusa MCE	Brazil	98.1	0.55	0.11	0.23	0.82	250	5	3.48	1500
Tateho KMA-X	Israel	98.5	0.9	0.4	0.15	0.25	<40	2	3.35	750
Tateho TD-X	Israel	99.4	0.55	0.02	0.04	0.02	<10	27.5	3.55	--
Sam Hwa	S. Korea	99.04	0.54	0.1		0.25		5	3.42	1000
China 96	China	96.3	2.2	0.85	0.6	0.3		2.6	3.52	200-500
China 97	China	97.4	1	1	0.4	0.2		1	3.52	200-500
China 9810	China	98.0	1.6	1	0.4			1.6	3.45	200-500

16.2.2 Uses Of Electro-fused Magnesia

Historically EFM was regarded as a high purity fine tuning refractory used in specific high performance applications and commanding a premium price.

Some applications include but are not limited to:

- Electrical insulating materials for atomic energy usages;
- Raw materials for high purity magnesium oxide ceramics;
- Raw materials for high-level basic refractories (magnesia and carbon bricks, ramming mix, and continuous casting refractories);
- Electrical insulating materials;
- Raw material for Insulators; and
- Raw material for automotive brakes.

Refractory EFM is the preferred material for magnesia-carbon bricks and shapes for basic oxygen furnace (BOF) vessels, ladles and electric arc furnace (EAF) slag liners. The high price of EFM means it is more often blended for use in refractories.

Mag carbon bricks continue to be the most important market for EFM. Currently there is no commercial substitute for mag-carbon brick. EFM is still the optimum material in certain high value steel applications, for example in slag zones and charge pads. No current substitution is taking place in these areas.

16.2.3 Production Of Electro-fused Magnesia

Production of EFM very energy intensive process consuming an estimated 3,500 to 4,500 kWh/t of electricity. The ingot produced is allowed to cool slowly, developing periclase crystals >1,000 µm and a density of over 3.5 g/cm³. The core of the ingot contains the purest material. Following cooling, the ingot is crushed, sized and graded into different purities required to make products for specific applications.

There is segmentation in the refractories industry according to the specification of the refractory produced. As with many things, there are shades of grey and the situation is not always clear cut. In the case of shaped refractories, the main market for high grade DBM and EFM, the qualities of the various grades compete.

Global trade of EFM is mainly based on magnesite and is produced in China, and Australia. There is also notable production in Russia, which is largely consumed for internal use. Elsewhere some EFM is produced in Mexico, Brazil, South Africa, Turkey and South Korea, but again mainly for internal use by integrated refractory producers or domestic markets.

Expanded capacity of EFM will be 233,000 t/y between 2011 and 2016. Most of the increase will take place in Russia (Magnezit), and China (Huayin). In addition, further capacity expansions cannot be ruled out in China, but few projects are reported.

16.2.4 Demand and Production Costs Of Electro-fused Magnesia Pricing

China is the overriding factor influencing the EFM market in the next five years, both in terms of supply and demand. However, supply and pricing of high-value EFM are likely to be insulated from Chinese magnesia policy. China is not a major supplier of high-value EFM (And DBM), because of a lack of cryptocrystalline magnesite resources. In addition, energy costs in China are now comparable with, or higher than, other EFM producing countries, and it is suffering from electricity shortages which have affected EFM output over the last few years. A step-change in magnesia pricing has occurred allowing investment in non-Chinese supply to the benefit of producers.

Energy prices will continue to be a major influence on magnesia costs, and will be the main inflation driver affecting pricing. Energy costs are unlikely to fall and although continuing investment in improving plant efficiency will be undertaken by producers, this is unlikely to combat energy cost inflation fully. In addition, producers in Europe, North America and Australia might face increased costs from carbon taxes which will have to be passed on to consumers.

16.2.5 Sodium Sulfate

Sodium sulfate is the sodium salt of sulfuric acid. Anhydrous, it is a white crystalline solid of formula Na_2SO_4 but when combined with water it has been known as Glauber's salt. It is one of the world's major commodity chemicals and one of the most damaging salts in structure conservation due to swelling nature of the mineral.

About two-thirds of the world's production is from mirabilite and the remainder from by-products of chemical processes such as hydrochloric acid production.

Sodium sulfate has unusual solubility characteristics in water. Its solubility rises more than tenfold between 0 °C to 32.4 °C, where it reaches a maximum of 49.7 g Na_2SO_4 per 100 g water.

16.2.6 Uses of Sodium Sulfate

The primary use of sodium sulfate worldwide is in powdered detergents. Sodium sulfate is a low cost, inert, white filler in home laundry detergents. Although powdered home laundry detergents may contain as much as 50% sodium sulfate in their formulation, the market for liquid detergents, which do not contain any sodium sulfate, continued to increase. However, with the major downturn in the world economies beginning in 2008 and continuing into 2010, many consumers have reverted to using more powdered laundry detergents because they are less expensive than their liquid counterparts.

Other applications include:

- Paper: Use of the Kraft process for the manufacture of wood pulp;

- Glass: Refining and fluxing agent to aid homogenization and provide Na₂O. the “fining agent” properties remove small air bubbles from molten glass;
- Textiles: Sodium Sulfate helps in “leveling”, reducing negative charges on fibers so dye can penetrate evenly;
- Dyes: Standardizes dyes;
- Animal feed: Sulfur providing ingredient in supplements; and
- Passive Thermal Storage: Used in storage of low grade solar heat for later release in space heating applications.

16.2.7 Production of Sodium Sulfate

About two-thirds of the world's production is from mirabilite, the natural mineral form of the decahydrate, and the remainder from by-products of chemical processes such as hydrochloric acid production.

Sodium sulfate also can be obtained as a byproduct from the production of ascorbic acid, boric acid, cellulose, chromium chemicals, lithium carbonate, rayon, resorcinol, and silica pigments and from battery recycling. The quantity and availability of byproduct sodium sulfate are dependent on the production capabilities of the primary industries and the sulfate recovery rates.

About one third of the world's sodium sulfate is produced as by-product of other processes in chemical industry. Most of this production is chemically inherent to the primary process, and only marginally economical. By effort of the industry, therefore, sodium sulfate production as by-product is declining.

Table 16.2.7.1: Approximate Global Sodium sulfate capacity, by region in 2010

Region	Capacity, Mt/y	Shares (%)
Asia	5	50
Southern Europe	1.3	14
North America	0.9	9
Central and Eastern Europe	0.7	8
Middle East	0.6	6
Latin America	0.5	6
Western Europe	0.4	4
Other	0.07	0.7

16.2.8 Demand for Sodium Sulfate

Detergent market is mature in developed nations but is increasing in developing regions of Asia-Pacific, Latin America, and Middle East countries.

Since about 42% of sodium sulfate is used in detergents, the market for powdered detergents vs. liquid detergents has a large effect on the demand for sodium sulfate. As economies soften, consumers turn away from liquid detergents and start to purchase dry detergents due to the perceived value for money. Demand for sodium sulfate is expected to continue.

The world demand for Sodium sulfate totaled 7.4 Mt in 2010 with annual growth of 2.5% to 2.7% since 2003 (Table 16.2.8.1).

Table 16.2.8.1: Annual Sodium Sulfate Demand since 2003 (Mt)

2003	2004	2005	2006	2007	2008	2009	2010	2011
5.8	6.1	6.4	6.7	6.9	7.1	7.2	7.4	7.6

North American demand has remained constant with softer demand for textile applications but increases in laundry detergent.

In the United States, The largest overall decline has been in craft pulping for the pulp and paper industry, mainly as a result of the introduction of the hydrogen peroxide and sodium chlorate processes. Decreases in the U.S. market, especially in the textile sector, have also been a direct result of the industry’s shift to Mexico. Mexico has been a developing market for sodium sulfate lately mostly as a result of demand from the detergent sector.

The major end use for sodium sulfate in Canada was formerly craft pulping. This end use accounted for over 90% of total sodium sulfate consumption in Canada until 1972. Since then, consumption for craft pulping has declined drastically due primarily to antipollution regulations.

16.3 Product Pricing

16.3.1 EFM

Quoted prices for EFM 96-98% MgO increased in early 2010 but then remained flat through the first half of the year. Prices then increased to US\$700/t, US\$815/t and US\$960/t for 96, 97 and 98% MgO respectively and appeared to stabilise once again. However, in late 2010 prices escalated to between US\$825/t and US\$1,145/t and remain at those levels in 2012.

It is very difficult to confirm the price projection of fused magnesia for forward projections given the contract nature of the product. Given that the metallurgical results imply a high quality EFM is possible as a result of the process operation, SRK has used a steady forward price of US\$1,100/t of product FOB at Record Ridge. The main reasoning for this relates to the information displayed in Figure 16-1, in particular the China “98% MgO lump”. The raw data for this analysis is displayed in Table 16.3.1.1. Although higher spot prices illustrated in Figure 16-2 represent higher quality product, SRK has taken a slightly more conservative route to base the economics of the project.

Table 16.3.1.1: Raw Data Analysis

Year and Month With Price Change (China 98% MgO lump)	High	Low	Average
2010	850	800	825
Feb	850	800	825
Mar	850	800	825
Apr	850	800	825
May	850	800	825
Jun	880	830	855
Jul	1000	850	925
Aug	1000	860	930
Sep	1020	900	960
Oct	1020	900	960
Nov	1020	900	960
Dec	1220	1100	1160
2011	1210	1080	1145
2012	1210	1080	1145

16.3.2 Sodium Sulfate

Prices have remained fairly consistent over the last few years as primary producers are forced out of the market to make way for by-product chemical manufacturers similar to Record Ridge. The inherent cost of producing sodium sulfate and transportation costs will have a large influence on the base price.

SRK has previous experience in Sodium sulfate and would caution that if a large hydrometallurgical mine operation is constructed somewhere in the world, with a similar process but not limited to magnesium production, the potential for a rapid price drop is possible. The main reason for this is that Glauber salt is extremely difficult to dispose of given its swelling nature when in contact with water. It would be cheaper for a mine operation to sell the Glauber salt at cost (i.e., someone pays transportation) rather than provide the tailings encapsulation required for effective environmental deposition.

That being said, SRK proposes to use a conservative sodium sulfate price given the major product of Record Ridge will be Magnesium.

Table 16.3.2.1 Details the historical prices achieved for the export of Sodium Sulfate.

Table 16.3.2.1: World Sodium Sulfate Export Prices

Year	2006	2007	2008	2009	2010
Price, (US\$/t)	83	91	114	100	102

Table 16.3.2.2 details the export and import differential for sodium sulfate in North America. The differences in import prices are due to shipping from the manufacturer and possible quality issues.

Table 16.3.2.2: Prices for Sodium Sulfate in North America, 2006-2010, US\$/ton

Item	2006	2007	2008	2009	2010
Export prices (US\$/t)	114	124	135	127	125
Import prices (US\$/t)	119	130	159	135	144

Present global capacity is enough to meet demand meanwhile considering ongoing projects and demand growth rates situation will be different for the regions in the future.

Record Ridge may produce up to 1.5754 Mt of sodium sulfate per annum. If this were the case the potential project would produce over 10% of the projected supply of global demand as presented in Table 16.3.2.3.

Table 16.3.2.3: Global Sodium Sulfate Consumption Forecast up to 2017 (tonnes)

2012	2013	2014	2015	2016	2017
8 Mt	8.2 Mt	8.6 Mt	8.9Mt	9.2 Mt	9.5 Mt

Due to very large impact Record Ridge would have on Glauber Salt supply without any sale price escalation due to product quality, SRK proposes that US\$75/t be used for the PEA. While this is conservative, it will also cover any potential increase in soda ash effective prices, transport and handling. In addition, the conservative pricing will provide some security with respect to the market effect that a contribution of 10% more product on a balanced market would have. Conversely, new

technological innovations requiring sodium sulfate may increase the market price or absorb the higher supply were WHY to produce large quantities of Glauber salt.

16.4 Contracts and Status

Record Ridge does not have any material contracts relating to construction, operations or other liabilities in place. Nor does it have off-take or negotiated terms for product sales of magnesium or sodium sulfate. Due to the nature of a PEA and the extended permitting and construction times the project is likely to face, SRK cannot advise on what material contracts will be signed in the future.

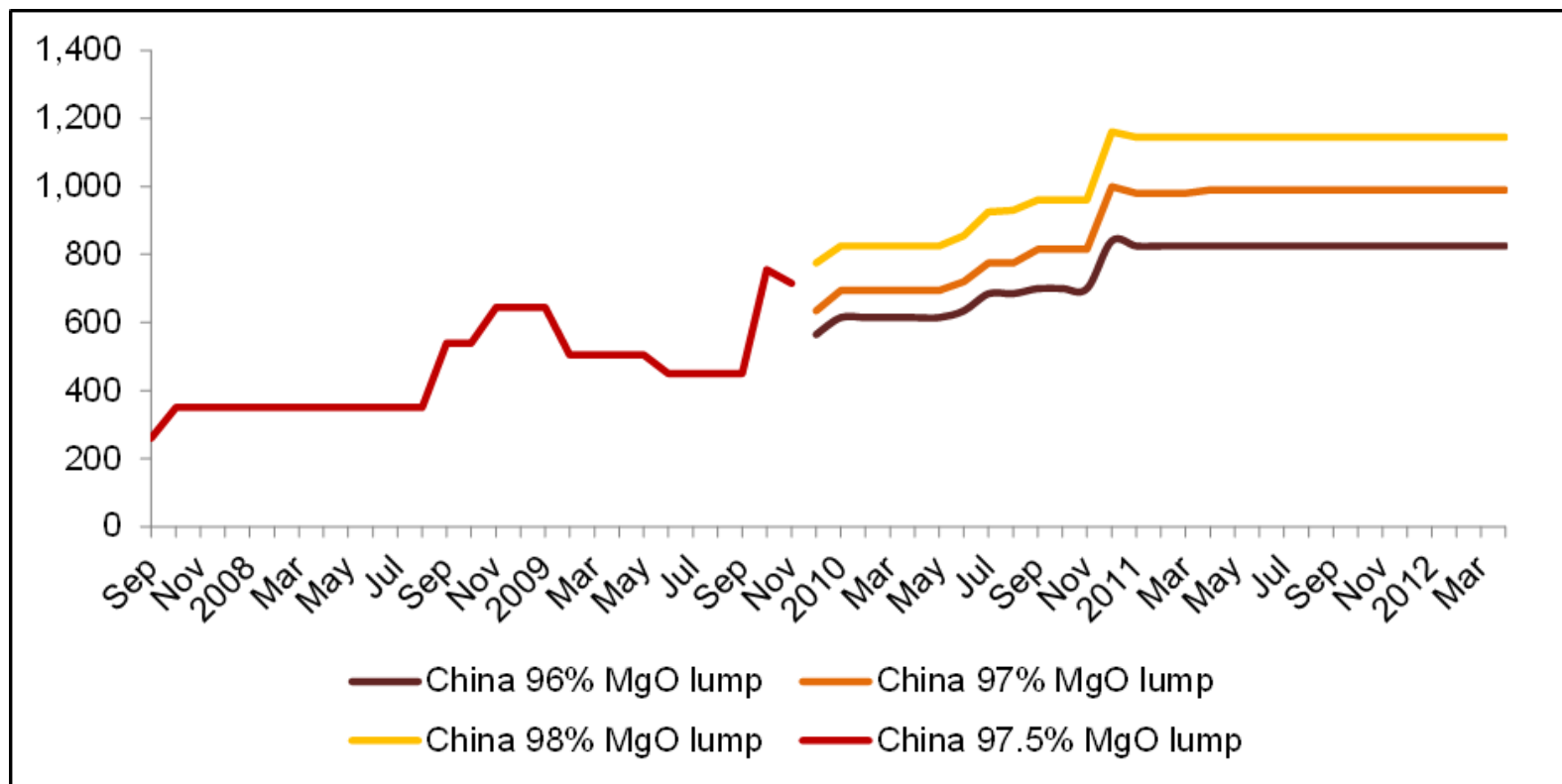

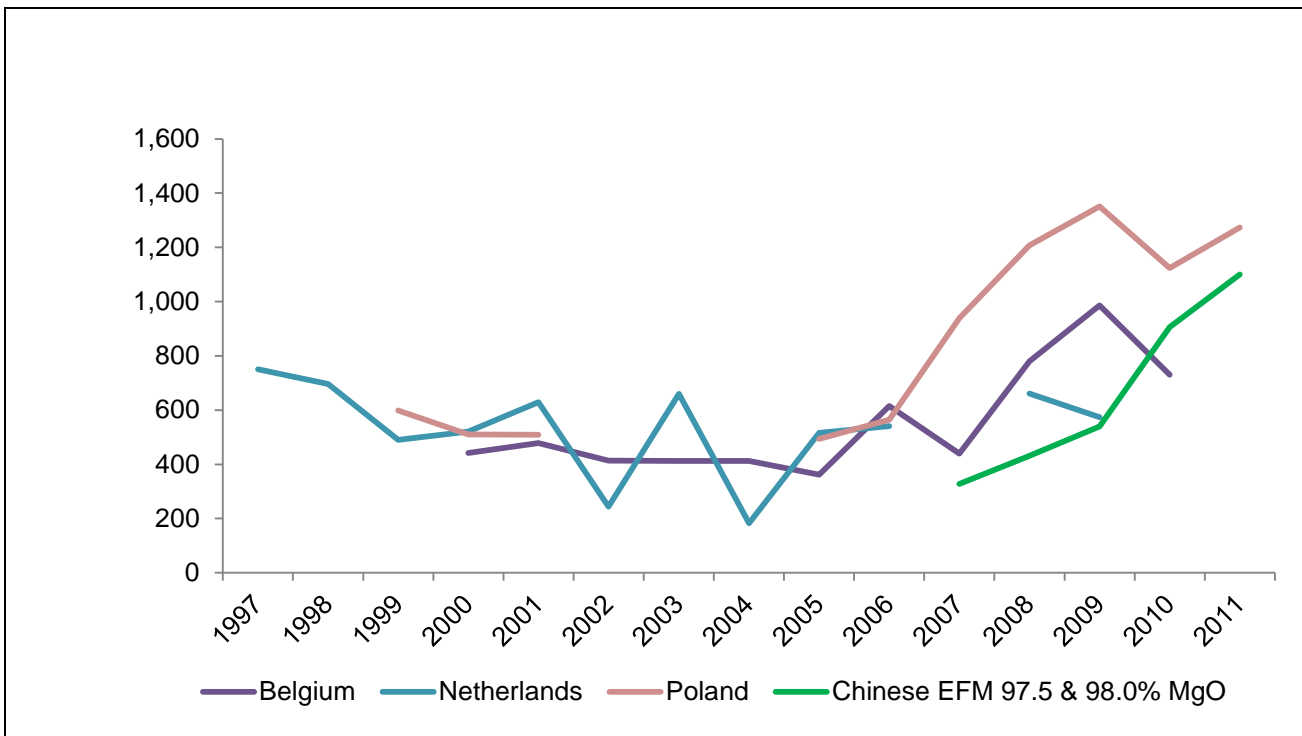

17 Environmental Studies, Permitting and Social or Community Impact (Item 20)

17.1 Related Information

The Record Ridge Project lies adjacent to the town of Rossland, which is situated in the West Kootenay region of south-eastern British Columbia. The International Boundary with the United States is within 5 km of the deposit.

The deposit is located in the Rossland Range of the Monashee Mountains, Kootenay Rockies region. The magnesium-bearing rocks of the Project are located in the headwaters of Sophia Creek and the West Fork of Sophia Creek along the southeast side of Record Ridge. The ridge forms a northeast to southwest trending divide between Big Sheep Creek to the west and Little Sheep Creek to the east. Both creeks flow south into the United States.

The B.C. Gas pipeline crosses Sophia Creek in the vicinity of the project area, as does the B.C. hydro electrical transmission line. The Old Rossland-Cascade Highway, also known as the “Santa Rosa Highway”, is a year-round government-maintained gravel highway. Two recreational trails cross cut the project area: the Seven Summits Trail, which is immediately adjacent to the west side of the orebody, and the Dewdney Trail as shown on Figure 17-1. The Dewdney Trail is designated a Heritage Site under the B.C. *Heritage Conservation Act* (B.C. MOF, 2005).

The Project lies within the Arrow Timber Supply Area. The deposit is located adjacent to land where the timber rights are privately held.

Two government-recognized First Nations: the Okanagan Nation and the Ktunaxa Nation, include the Record Ridge Project area in their traditional territories (Waneta, 2006). The Project site is not subject to any current Treaty negotiations according to the listing of Treaties and other Negotiations by the B.C. Ministry of Aboriginal Relations and Reconciliation (B.C. MARR, 2013).

17.2 Environmental Studies

The proponent has not yet initiated site specific environmental baseline studies. Regional information has been gathered from the B.C. Gas Utility Ltd. Southern Crossing Pipeline Project, the Teck Cominco Smelter Ecological Risk Assessment, the Waneta Hydroelectric Expansion Project and wildlife habitat mapping by the B.C. Ministry of Forests, Lands and Natural Resource Operations (MFLNR) and fish and fish habitat data collected by the B.C. Ministry of Environment (MOE).

The Southern Crossing Pipeline Project involved establishing a new alignment to the northeast of Sophia Creek. Environmental studies completed for the B.C. Gas Utility Ltd. Project included gathering detailed data along portions of the route that were altered (B.C. Gas, 1998). The studies also included a detailed assessment of archeological resources where the pipeline crosses the Dewdney trail to the south of the deposit. The Dewdney Trail is defined as a corridor 100 m to either side of the trail center line.

The Terrestrial Ecological Risk Assessment conducted for the Teck Cominco Smelter at Trail, B.C. provides regional information for predominately for lands east of the Project. The assessment was initiated in 2000 and involved wildlife, soil and vegetation studies (Intrinsik 2011).

Socio-economic background data gathered for the Waneta Hydroelectric Expansion Project's impact assessment included Rossland in its Project area. The assessment, however, is dated as it is based on Statistics Canada information gathered in 2001 and Rossland's development as a recreational destination since this date has potentially changed the baseline. It does note that traditionally the Kootenay Region has had a highly-skilled workforce particularly in the forestry, mining and construction sectors, which provide most of the regional employment (Waneta 2006).

The Waneta study also documents that in 2006 the proposed Project site was located within a region of the West Kootenay where more than one First Nation has claimed traditional territory and/or was currently asserting rights and title. The Okanagan Nation and the Ktunaxa Nation include the Record Ridge Project area in their traditional territories. The Sinixt people of the Colville Confederated Tribes in Washington State also potentially have an interest in the region. The Sinixt people were historically present in the vicinity of the Project, however they were declared to no longer exist in Canada by the federal government in 1956 (Waneta 2006).

In 2011, Forest Consultation and Revenue Sharing Agreements between the Province of British Columbia and the Lower Similkameen and Osoyoos Indian Bands of the Okanagan Nation were reached (B.C. MARR 2011b, 2011c). The Project site was included in the Traditional Territory of these Bands. The Project site is outside of the Ktunaxa Territory in the Forest Consultation and Revenue Sharing Agreement reached with the Ktunaxa Nation in 2011 (B.C. MARR 2011a). The agreements allow for First Nations communities see more direct economic benefits returning from harvest activities taking place in their traditional territory.

Deer and elk wintering grounds have been identified by the Government of British Columbia DataBC adjacent to Big Sheep Creek and Corral Creek, as shown on Figure 17.1.¹ The Government of British Columbia HabitatWizard² documents the presence of Brook Trout in Big Sheep Creek, Little Sheep Creek and Corral Creek. Big Sheep Creek and Little Sheep Creek also support Rainbow Trout. There are no fish observations recorded for Sophia Creek (B.C. MOE, 2013)

17.3 Exploration Permitting Requirements

Activities to date have focused on mineral exploration and have been conducted under B.C. Mines Act Permit MX-5-460. Existing environmental liabilities at the Project area are related to the exploration activities that WHY has undertaken to date. The B.C. Ministry of Energy, Mines and Natural Gas has attached conditions to the permit to be undertaken when exploration activities are completed. The objective of the reclamation conditions is to backfill with overburden and revegetate with self-sustaining ground cover the drill sites and new access routes. The plan proposes removing debris, re-establishing natural landscapes and deactivating access trails. These potential liabilities are within the existing reclamation bond amount. The current established security deposit is approximately US\$10,000.

17.4 Development Permitting Requirements

The environmental assessment and permitting framework for metal mining in Canada is well established. In each Canadian jurisdiction the process consists of a two tiered system, whereby the

¹ DataB.C. manages the Province's spatial data infrastructure.

² HabitatWizard is a map-based tool for spatially accessing detailed fish and fish habitat information.

proposed project undergoes an environmental screening process to determine if an environmental assessment (EA) is necessary. The EA process provides a mechanism for reviewing major projects to assess their potential impacts. Although exceptions do occur, the EA phase typically involves departments from both the federal and provincial governments. Following a successful EA the operation undergoes a construction and operating licensing/permitting phase. The project is then regulated through all phases (construction, operation, closure and post closure) by both federal and provincial departments and agencies.

17.4.1 Environmental Assessment Process

Provincial Environmental Assessment Process

In British Columbia the Environmental Assessment Office (EAO) manages the assessment of proposed major projects as required by the British Columbia *Environmental Assessment Act* (B.C. EAA). The assessment process examines the project for potentially adverse environmental, economic, social, heritage and health effects that may occur during the life cycle of the project.

Mineral mining projects become reviewable in three ways:

- 1) The *Reviewable Projects Regulation* provides for a mining project to be automatically reviewable if it meets the following thresholds:
 - a. Any new mine with 75,000 t of production per year;
 - b. Modifications to a mine that result in either 50% or more increase in area of mine disturbance, or 750 ha or more new disturbance.
- 2) Ministerial Designation by the Minister of Environment who has the authority to direct the review of a project which is not automatically reviewable under the *Reviewable Projects Regulation*.
- 3) Proponent "opt-in" whereby a proponent may request that the EAO consider designating its project (that otherwise would not be reviewable) as a reviewable project, and the EAO agrees with and orders such a designation.

Federal Environmental Assessment Process

In the spring of 2012 the *Canadian Environmental Assessment Act* (CEAA 2012) was amended. Two significant results of these amendments were the re-definition of what triggers a federal EA and the introduction of legislated time periods within a federal EA if it is required.

With respect to the Project, there are two main methods of triggering a federal EA under CEAA 2012:

1. A proposed project will require an EA if the project is described in the *Regulations Designating Physical Activities* (2012); and
2. A project may require an EA if in the opinion of the Minister of Environment carrying out the project may cause adverse environmental effects, or that public concerns related to those effects warrant further review.

With respect to number 1 above, the *Regulations Designating Physical Activities* (2012) state:

15. The construction, operation, decommissioning and abandonment of (a) a metal mine, other than a gold mine, with an ore production capacity of 3,000 t/d or more.

Once a federal assessment is triggered the Canadian Environmental Assessment Agency (CEAA) then determines what type of EA the project will require. There are two types of EAs conducted under CEAA 2012: an environmental assessment by responsible authority (Standard EA) and an environmental assessment by a review panel. Both types of assessments can be conducted by the federal government alone or in conjunction with another jurisdiction. The responsible authority in the case of base and precious metal mining is CEAA.

17.4.2 Environmental Assessment Requirements of the Project

In B.C. agreements are in place with the federal government that requires the EA to be a single cooperative process. In addition, the U.S. is afforded opportunities, under various international agreements including the Boundary Waters Treaty of 1909, to review and comment on projects proposed in transboundary watersheds that could potentially impact resources in the State of Washington. Various state and federal agencies actively participate in the Canadian EA and permitting processes for mines that are associated with transboundary rivers.

Provincial Requirements

The Project would automatically trigger an EA review because it triggers the Reviewable Resources Regulation as a new mine with 75,000 t of mineral material production per year.

There are three stages in an EA - Pre-application, Application review and the Decision stage. After the application review stage, the Minister may issue an environmental assessment certificate allowing the proposed project to proceed with obtaining permits, licenses, authorizations and approvals. The general steps required are illustrated in Figure 17-1. As outlined below the process to obtain a certificate may take 30 months to complete, but it may take more or less time depending on a variety of circumstances, including the technical complexity of the project and consultation requirements.

Pre-Application Stage: It is assumed it will take between 12 and 18 months to gather the required environmental baseline information needed at the pre-application stage and to prepare the EA application for the Project. The pre-application stage then takes an additional 12 to 18 months to complete.

Application Review Stage: The application review stage, which is governed by legislated timelines, may take up to one month for screening the application to ensure it contains the required information and six months for reviewing the application once it has been accepted by the EAO. Additional time is required for the proponent to address deficiencies in the application and to respond to comments and information requests from reviewers.

Decision Stage: The *Prescribed Time Limits Regulations* sets down a time limit of 45 days from the date of referral to Ministers for them to make a decision on whether or not to certify a project. If Ministers decide that more time is needed, an order may be issued to extend the time limit. The Ministers may also decide that further assessment is required.

Federal Requirements

The Project as it is currently defined will likely require a federal EA in accordance with CEAA 2012. It is anticipated that a Standard EA will be required, with the possibility of this EA being escalated to a Panel review.

Completion of a Standard EA following its initiation will require approximately 24 to 30 months. A generic timeline displaying the steps in the process is provided in Figure 17-2. Although many of the steps in this process now have regulated timelines, many are still a function of the level of detail in the data provided to the agency and the time required for the proponent to compile this data which accounts for the range of the process' schedule. A Panel EA's schedule and timeline is more difficult to predict, however the CEAA 2012 amendments are structured to facilitate the completion of a Panel review within a similar time frame of 24 to 36 months.

17.4.3 Environmental Licensing Process

Following a successful EA the project will be required to obtain a number of provincial and federal licenses/permits. This process can generally be initiated, in part, during the final stages of the EA and typically adds an additional month to the schedule following a Ministerial decision allowing the project to proceed. Following are lists of both federal and provincial licenses and permits the project will require.

Provincial Licenses

The main provincial permits that would be required for the construction and/or operation of the Project include a *Mines Act* Permit for the mine plan and reclamation program, environmental management permits for solid refuse disposal, liquid effluent discharge or air emissions and a Water License for the water management purposes such as diversions and dams. The following is a list of additional provincial authorizations, licenses, and permits that will need to be provided for the province.

- Road Use Permit (*Transportation Act*, Ministry of Transportation and Infrastructure);
- Road Use Permits (*Forest Act*, MFLNR);
- Special Use Permits (*Forest Practices Code of B.C. Act*, MFLNR); and
- License to Cut (*Forest Act*, MFLNR).

Should concurrent permitting be initiated at the submission of the EA Application then provincial permits have to be issued within 60 days of the EA certificate being issued.

Federal Licenses/Permits/Authorizations

Table 17.4.3.1 is a preliminary list of the federal authorizations, licenses, and permits that will potentially be required.

Table 17.4.3.1: Potential List of Federal Authorizations, Licenses, Permits and Approvals

Statute	Authorization	Agency	Purpose
Canada Transportation Act	License to operate an airstrip	Ministry of Transport	Authority to operate the Airport
Explosives Act	Magazine storage of explosives and detonators	Natural Resources Canada	Authority to manufacture and store explosives
Species at Risk Act	Authorization	Environment Canada	Protect species at risk or near risk
Fisheries Act	Authorization of work effecting fish habitat	Fisheries and Oceans	Any work that has the potential to impact waters defined as fish habitat
Radio Communication Act	Radio Licenses	Industry Canada	To provide for the operation of radio systems
Nuclear Safety Control Act	Radioisotope License	Canadian Nuclear Safety Commission	Authorization for Nuclear Density Gauges/ X-ray analyzer

17.5 Social and Community

The acknowledgement of stakeholders' concerns and the incorporation of these concerns into the project operations and design is a requirement of the Environmental Assessment process in Canada. Project approvals will have imposed on them conditions that are related to the regulatory conversation occurring at the time of the application and are related to regional concerns. The EA process is meant to determine whether or not a proposed project is "in the public interest".

17.5.1 Public Consultation

As part of the regulatory process, public consultation will be an important component. Rossland was established as a mining town in the 1890s. Today the Rossland is a residential community for people working in Trail, primarily at the Teck Metals Ltd. smelter and the Kootenay Boundary Regional Hospital. Rossland is also a tourist destination for outdoor enthusiasts. WHY has initiated dialogue with the business community. Further consultation with the broader community will be required.

17.5.2 First Nations Engagement

As part of the regulatory process, engagement of the First Nations claiming territorial rights to the area will be an important component. Dialogue has not yet been initiated by WHY.

17.6 Operating and Post Closure Requirements and Plans

17.6.1 Operating Plans

Given the proposed development plans outlined in this document, the following key operating plans will need to be developed:

- Water Management Plan;
- Dust Management Plan; and
- Tailings Management Plan.

17.6.2 Conceptual Decommissioning and Reclamation Plan

Conceptually the plan for the closure of the facility will consist of the following main components:

- Decontamination;
- Asset removal;
- Demolition and disposal;
- Reclamation of impacted areas; and
- Post-closure monitoring.

The facilities will be decontaminated as necessary. Surplus chemicals will be removed. Hazardous materials will be disposed of at approved facilities.

All salvageable or recyclable components will be stored in a designated lay down area to allow for secondary decontamination if required and eventual shipment off site.

With respect to demolition, most process equipment and non-supporting structures will be removed before the demolition. Typically infrastructure is demolished by pulling the structures over or by

cutting the steel supports. This may be done by an excavator equipped with shears or by careful manual preparations with a torch.

Concrete foundations will be left in place but leveled to grade and, if necessary to permit drainage, slabs will be perforated. The area will be capped with a cover consistent with the overall closure plan.

Appropriate covers will be placed on tailings and waste rock storage facilities. A storm water diversion system of ditches will direct any excess storm water to the open pit area. The pit is expected to fill with water to the low point of the pit where it would discharge towards Sophia Creek through a natural looking velocity control constructed spillway. Final contouring of the pit will conform to surround terrain.

Once the site is decommissioned disturbed areas will be re-contoured, topsoil added and the areas seeded with native grasses and native trees planted.

A post closure monitoring program will be established to monitor the facilities discharges until the closure objectives have been met and the property is eligible to be returned to the Crown.

17.7 Environmental Issues

Development of the Record Ridge Project will be subject to an assessment of environmental and socio-economic impacts, including cumulative impacts. The project will entail the development of a tailings storage facility, open pit, mill, and waste rock storage facility. The complexity of the EA and permitting of the facilities will be dependent on the siting of facilities, the waste characterization and the engagement of the regulators, local community and First Nations. A typical schedule for this type of EA is presented in Figure 17-3.

Parties to the EA will include organizations from the Province, the Canadian Federal government and foreign representatives from the U.S. Fish and Wildlife Service, the Washington Department of Ecology and the Department of Natural Resources.

Given the territorial claim of First Nations a directive to consult on project effects with the First Nations represented by the Ktunana Nation Council and the Okanagan Nation Alliance during the EA process is to be anticipated.

The Southern Crossing Pipeline EA established restrictions on mining activities in the vicinity of the pipeline right of way that limit the opportunity for development for reasons of human health and safety. Avoidance of the electrical transmission line will also be required.

The Dewdney Trail is a heritage trail running across southern British Columbia from Hope to Wild Horse River. The route was used by explorer Edgar Dewdney in 1865, piecing together existing routes used by aboriginal people. The portion of the trail south of the deposit has been identified for its hiking, horse-riding, mountain biking use. Archaeological assessments will need to be conducted to ensure that disturbance of these resources are avoided.

The Seven Summit trail along the crest of Record Ridge is also used for hiking and mountain biking use. Consultation with the public will be required to develop alternatives to the portion of the route that would be impacted by the projects. Funds for construction of the alteration would predominately be provided by the Proponent.

430298 431298 432298 433298 434298 435298 436298 437298 438298 439298 440298

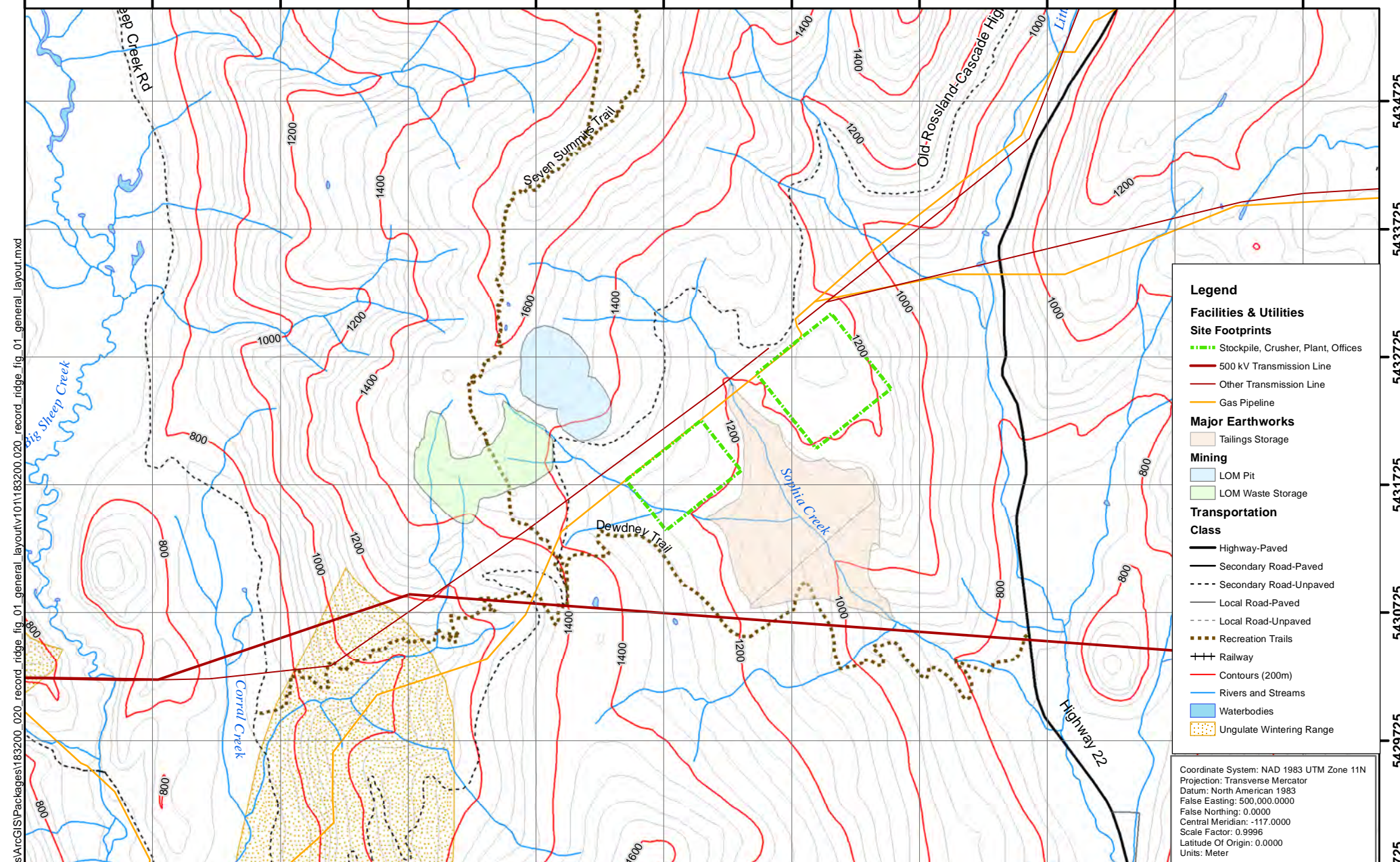

- Legend**
- Facilities & Utilities**
- Site Footprints
 - Stockpile, Crusher, Plant, Offices
 - 500 kV Transmission Line
 - Other Transmission Line
 - Gas Pipeline
 - Major Earthworks
 - Tailings Storage
 - Mining
 - LOM Pit
 - LOM Waste Storage
 - Transportation
 - Class
 - Highway-Paved
 - Secondary Road-Paved
 - Secondary Road-Unpaved
 - Local Road-Paved
 - Local Road-Unpaved
 - Recreation Trails
 - Railway
 - Contours (200m)
 - Rivers and Streams
 - Waterbodies
 - Ungulate Wintering Range

Coordinate System: NAD 1983 UTM Zone 11N
 Projection: Transverse Mercator
 Datum: North American 1983
 False Easting: 500,000.0000
 False Northing: 0.0000
 Central Meridian: -117.0000
 Scale Factor: 0.9996
 Latitude Of Origin: 0.0000
 Units: Meter

C:\Users\mhastings\Documents\ArcGIS\Projects\183200_020_record_ridge_fig_01_general_layout\fig_01_general_layout.mxd

5434725
5433725
5432725
5431725
5430725
5429725
5428725

1:40,000



Job No: 183200.020
 Filename: 183200.020_record_ridge_fig_01_general_layout

Record Ridge Project

Record Ridge Project
 Environmental and Permitting Layout

Date: Jan 2013	Approved: AL	Figure: 17-1
----------------	--------------	--------------

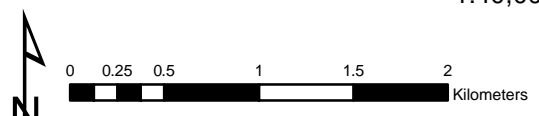

Environmental Assessment Process

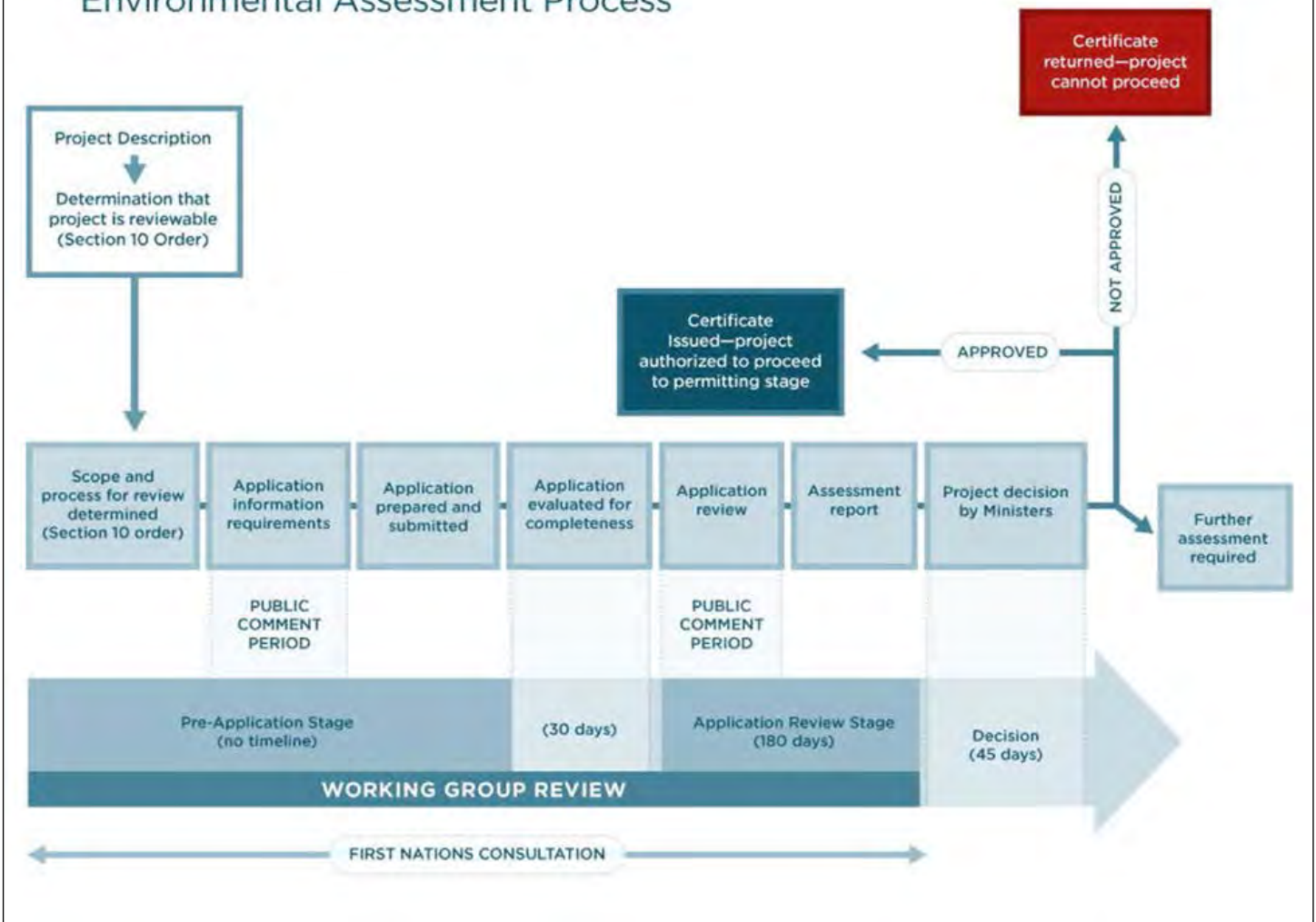

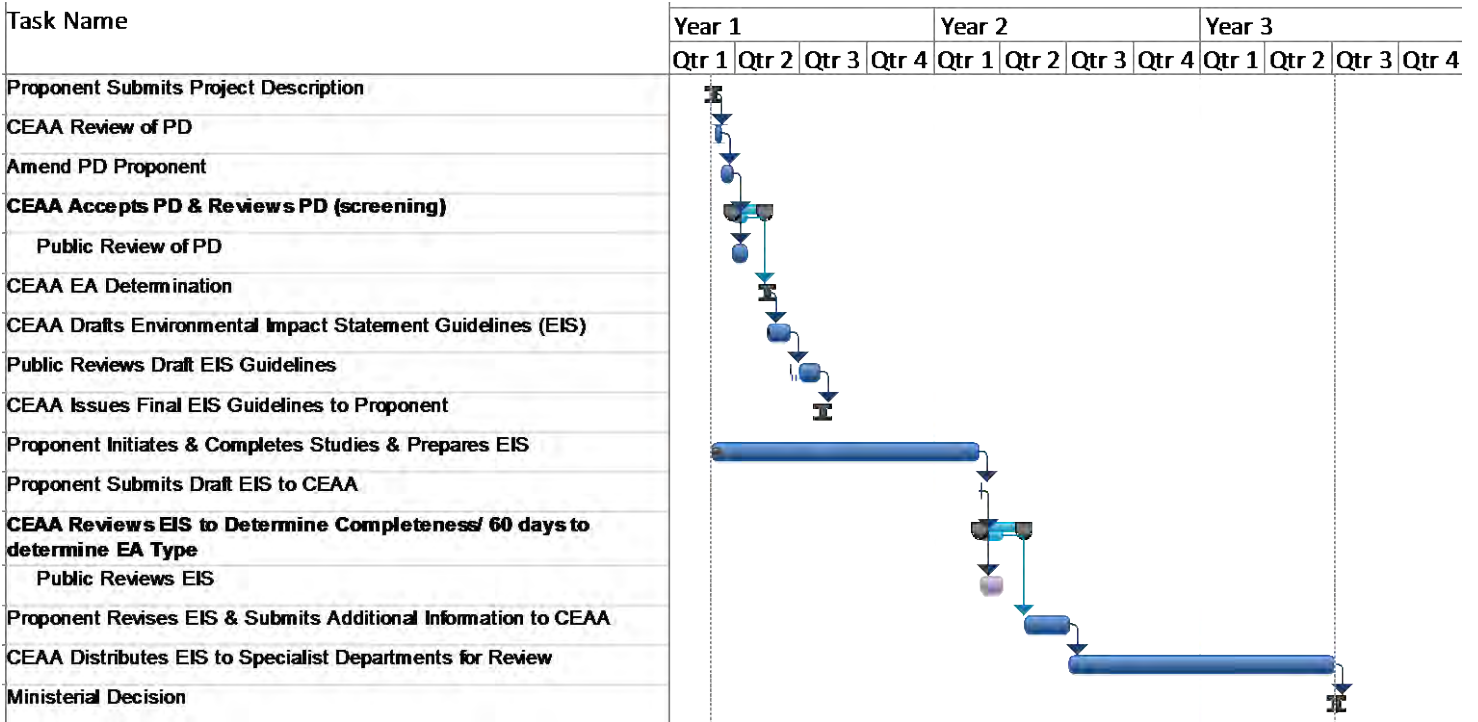

18 Capital and Operating Costs (Item 21)

18.1 Capital Costs

Life of mine capital costs totaling US\$979 million are summarized in Table 18.1.1. A flat 25% contingency has been applied to capital items to partially account for the long project development envisaged for the project and level of cost estimation. The initial capital is estimated to US\$605 million which is the estimated investment to construct the project producing 345,000 t/y of Electro-fused magnesia (EFM) and 1,575,000 t/y of Sodium Sulfate.

Capital is invested two years prior to the corresponding production. Cost estimates are in Q1 2013 U.S. constant dollar terms. Contingencies of 25% have been applied to the total capital cost estimate. Table 18.1.1 summarizes LoM capital costs.

Table 18.1.1: LoM Capital Costs

Description	Total Cost (US\$000's)	Initial (US\$000's)	Sustaining (US\$000's)
Recommended Work Programs	9,900	9,900	0
Mine	13,766	6,098	7,668
Processing	452,710	452,710	0
Tailings	108,192	11,309	96,883
Infrastructure	6,600	6,600	0
Sustaining Capital	178,724	0	178,724
Mine Closure	13,041	0	13,041
Sub-Total	\$782,933	\$486,618	\$296,316
Contingencies (25%)	195,733	121,654	74,079
Total Capital	\$978,667	\$608,272	\$370,395

18.1.1 Mine

The estimated cost of mine equipment is shown in Table 18.1.1.1. Mine capital equipment costs were obtained from recent cost models and handbooks.

Table 18.1.1.1: Mine Capital Costs

Description	Total Cost (US\$000's)	Initial (US\$000's)	Sustaining (US\$000's)
Drilling	1,280	711	569
Loading	3,510	1,097	2,413
Hauling	7,820	3,192	4,628
Roads & Dumps	1,155	1,098	57
Total Capital	\$13,766	\$6,098	\$7,668

The overall mine equipment cost is US\$13.8 million, which amounts to US\$17.2 million with 25% contingency. Mine sustaining capital was included for overhaul costs and fleet replacement. Mine equipment is overhauled depending on machine type at 25% of original purchase cost, and replaced after every three rebuilds.

Tables 18.1.1.2 to 18.1.1.5 present the breakdown of the mine capital estimate.

Table 18.1.1.2: Drilling Capital Costs

Description	Total Cost (US\$000's)	Initial (US\$000's)	Sustaining (US\$000's)
Sandvik DI 550			
Drill Rebuild Cost	569	0	569
New Purchase Cost	711	711	0
Total Capital	\$1,280	\$711	\$569

Table 18.1.1.3: Loading Capital Costs

Description	Total Cost (US\$000's)	Initial (US\$000's)	Sustaining (US\$000's)
Cat 374			
Rebuild Cost	1,316	0	1,316
New Purchase Cost	2,194	1,097	1,097
Total Capital	\$3,510	\$1,097	\$2,413

Table 18.1.1.4: Hauling Capital Costs

Description	Total Cost (US\$000's)	Initial (US\$000's)	Sustaining (US\$000's)
Truck			
Truck Rebuild Cost	2,234	0	2,234
New Purchase Cost	5,586	3,192	2,394
Total Capital	\$7,820	\$3,192	\$4,628

Table 18.1.1.5: Roads & Dumps Capital Costs

Description	Total Cost (US\$000's)	Initial (US\$000's)	Sustaining (US\$000's)
CAT D7L			
New Purchase Cost	408	408	0
CAT 140K			
New Purchase Cost	404	404	0
Water Truck 20kl			
Unit Rebuild Cost	30	0	30
New Purchase Cost	148	148	0
CAT 416 E			
Unit Rebuild Cost	27	0	27
New Purchase Cost	137	137	0
Total Capital	\$1,155	\$1,098	\$57

18.1.2 Process Capital Costs

SRK prepared capital cost estimates for a production rate of 345,000 t/y of EFM and 1,575,000 t/y of sodium sulfate. Table 18.1.2.1 present the estimate of capital costs for mineral processing without contingency. It was considered that the initial capital will be spent during the two years prior to the startup of the processing plant.

Table 18.1.2.1: Processing Capital Costs

Description	Total Cost (US\$000's)	Initial (US\$000's)	Sustaining (US\$000's)
Ore Comminution	36,053	36,053	0
Mg Leach and Precipitation	15,263	15,263	0
MgO Calcination	7,598	7,598	0
Metallurgical Facilities & Buildings	6,296	6,296	0
Fused Mg Plant	225,000	225,000	0
Acid Plant	150,000	150,000	0
Sodium Sulfate Plant	10,000	10,000	0
First Fills	2,500	2,500	0
Total Capital	\$452,710	\$452,710	\$0

The capital costs estimate for the processing plant includes investments related to the ancillary site infrastructure. Sustaining capital was added to the capital estimate, these were considered as 1% of initial investment of mineral processing and infrastructure spent on a yearly basis. This cost amounts to US\$182.7 million over the life of mine.

Tables 18.1.2.2 through 18.1.2.5 present further detail for the mineral processing capital estimate.

Table 18.1.2.2: Material Comminution Capital Costs

Description	Qty.	FOB Price (US\$000's)	Total (US\$000's)
RoM Ore Bin	1	30	30
Grizzly Feeder	1	35	35
Jaw Crusher	1	250	250
Chutes	1	5	5
Rock Breaker	1	60	60
Conveyor	1	15	15
Conveyor	1	60	60
Weightometer	1	5	5
Dust Control	2	15	30
Tramp Magnet	1	3	3
Metal Detector	1	3	3
Conveyor	2	65	130
Coarser Ore Reclaim	1	100	100
Ore Bin	2	30	60
SAG Mill Conveyors	2	15	30
SAG Mill Feed	2	5	10
SAG Mill Discharge	2	6	12
SAG Mills	2	5,000	10,000
Ball Mills	2	1,000	2,000
Ball Mills Sump	2	60	120
Cyclones	2	50	100
Reclaim Thickener	1	150	150
Scat Screen & Conveyor	2	40	80
Sub-Total Capital Installation (43%)			\$13,287
Piping and Instrumentation (45%)			\$5,713
Auxiliaries (20%)			\$8,550
Engineering (15%)			\$3,800
Total Capital			\$4,703
			\$36,053

Table 18.1.2.3: Mg Leaching & Precipitation Capital Costs

Description	Qty.	FOB Price (US\$000's)	Total (US\$000's)
CSTR Leaching Train	2	1,250	2,500
CCD Circuit	2	750	1,500
Conditioning & Reclaim Tank	2	100	200
Heat Exchangers	1	125	125
Pumps	2	100	200
Rotary Vacuum Filters	2	300	600
Leached Ore Thickener	1	200	200
MgO Precipitation	1	300	300
Sub-Total Capital			\$5,625
Installation (43%)			\$2,419
Piping and Instrumentation (45%)			\$3,620
Auxiliaries (20%)			\$1,609
Engineering (15%)			\$1,991
Total Capital			\$15,263

Table 18.1.2.4: MgO Calcination Capital Costs

Description	Qty.	FOB Price (US\$000's)	Total (US\$000's)
Calcination Kiln & Handling	1	2,500	2,500
Baghouse & ESP	1	300	300
Sub-Total Capital			\$2,800
Installation (43%)			\$1,204
Piping and Instrumentation (45%)			\$1,802
Auxiliaries (20%)			\$801
Engineering (15%)			\$991
Total Capital			\$7,598

Table 18.1.2.5: Other Processing Capital Costs

Description	Qty.	Total (US\$000's)
Sodium Sulfate Facility	1	10,000
Acid Plant	1	150,000
Fused Magnesia Plant	1	225,000
Total Capital		\$385,000

18.1.3 Other Capital Costs

Table 18.1.3.1 presents other capital cost investments with no contingency.

Table 18.1.3.1: Other Capital Costs

Description	Total Cost (US\$000's)	Initial (US\$000's)	Sustaining (US\$000's)
Feasibility & Permitting	9,900	9,900	0
Tailings	108,192	11,309	96,883
Infrastructure	6,600	6,600	0
Mine Closure	13,041	0	13,041
Total Capital	\$133,583	\$23,659	\$109,924

A total of US\$11 million covers costs of constructing an initial tailings storage facility. The remainder of the tailings capital costs is sustaining distributed over the life of mine.

A budget of US\$9.9 million was assigned for additional drilling, feasibility, engineering studies and recommended work programs, which should be performed prior to development of the project.

Infrastructure costs were estimated at US\$6.6 million, which will be spent during the two years of pre-production.

Mine closure cost is US\$16 million with contingency, which is spent on the year following the end of production, as presented in Table 18.1.3.2.

Table 18.1.3.2: Closure Capital Costs

Area	Estimated Cost (US\$)
Buildings - Demolition and Salvage	850,000
Plant site - Re-contour all areas, spread topsoil	255,000
Re-vegetation – Grasses and Trees	280,000
Pit and Storm water diversion structures	200,000
Tailings Closure	9,257,650
Mob and Demob	25,000
Total Direct	\$10,867,650
Supervision and Profit (20%)	2,173,530
Subtotal	\$13,041,180
Contingency (25 %)	3,260,295
Total	\$16,301,475

18.1.4 Payback

The prepared economic evaluation indicates that post tax payback will occur in the last quarter of year 5 of production.

18.2 Operating Costs

Operating costs for both mine and plant consider the following:

- 365 days of operation per year;
- 24 hours of operation per day; and

Table 18.2.1 presents LoM operating costs.

Table 18.2.1: Operating Cost Summary

Description	Unit Cost (US\$)	Total Cost (US\$000's)
Mining (US\$/t-mined)	2.26	180,856
Sulfuric Acid (US\$/t)	50.00	2,203,514
Soda Ash (US\$/t)	140.00	6,169,838
Other Processing Costs (US\$/t-RoM)	68.64	3,024,983
Sodium Sulfate Bagging & Storage (US\$/t-SS)	10.00	661,054
Tailings & Water Manag. (US\$/t-Tailings)	0.20	10,344
G&A (US\$/t-RoM)	1.51	66,546
Total Operating Costs		\$12,317,135

18.2.1 Mine Operating Costs

SRK estimated the mine operating costs on the prepared production schedule and selected mine equipment fleet. Table 18.2.1.1 present the summary of the mine operating costs.

Table 18.2.1.1: Mine Operating Cost Summary

Description	Unit Cost (US\$/t-mov)	Total Cost (US\$000's)
Drilling	0.23	17,976
Blasting	0.38	30,743
Loading	0.19	15,517
Hauling	0.78	62,308
Roads & Dumps	0.15	12,257
Labor (from labor sheet) Incls. G&A	0.53	42,055
Total Operating Costs	\$2.26	\$180,856

The cost of US\$2.26/t-moved is the result of an assessment of equipment operating hours, estimate of consumables of mine equipment and mine operations and quantities of labor to manage and execute these operations.

18.2.2 Process Operating Costs

Mineral processing operating costs were prepared by SRK; these costs were divided into the following major costs:

- Sulfuric Acid;
- Soda Ash;
- Other Processing Costs; and
- Sodium Sulfate Bagging & Storage.

Table 18.2.2.1 presents estimated consumption rates of the mineral processing plant.

Table 18.2.2.1: Processing Operating Costs

Description	Unit Cost	Total Cost LoM (US\$000's)
Sulfuric Acid (US\$/t)	50.00	2,203,514
Soda Ash (US\$/t)	140.00	6,169,838
Other Processing Costs (US\$/t-RoM)	68.64	3,024,983
Sodium Sulfate Bagging & Storage (US\$/t-SS)	10.00	661,054
Total Operating Costs		\$12,059,389

The costs for soda ash were derived after telephone discussion with Mr. Dennis S. Kostick (T 703 648 7715 E dkostick@usgs.gov) of the USGS Mineral Information Services. In his reports he lists both Price Quoted and Average Mine Sales value. The Price Quoted is a sticker or asking price one will commonly see on websites or company literature. The actual bulk transaction price is confidentially accumulated by Mr. Kostick and published as the Average Mine sales value. A five year average of Average Mine Sales translated to metric tonnes was then used to estimate soda ash price.

Sulfuric acid will be produced by an acid plant on site. It is estimated that the EFM process will consume 1 t of acid per 1 t of mill feed. The electrical cost rate applied was estimated to be US\$0.045/kWhr. This is primarily from Infomine Costmine data (page 5 & 6 EP Canada rate sheet) and their compilations of both British Columbia Hydro and Fortis B.C. published rate criteria. In addition, due to the production of 3,000 t/d of sulfuric acid and the associated waste heat from that process, about 500,000 pounds of steam per hour could be available to heat the plant unit operations or cogenerate about 55 MW of electrical power. When a complete mass, heat and energy balance is completed on the entire process, the split between steam for heating and steam for

cogeneration of power can be determined but undoubtedly some electrical power out of the 55 MW potential will be generated on site by WHY making the cost estimate reasonable.

The build-up of the processing costs is presented in the Table 18.2.2.2.

Table 18.2.2.2: Processing Cost Build Up

Description	Unit Cost (US\$)
Management	1.50
Hourly Labor	6.00
Comminution Media	1.50
Comminution & Leach Energy	5.00
Fused MgO Energy	40.00
Repair and Maintenance	0.75
Supplies and Analytical	2.00
Hydrometallurgical Reagents	200.00
Corporate G&A	1.89
Total Operating Costs	\$258.64

The designed processing facility will also consume 1 t of Soda Ash per tonne of mill feed. The cost of Soda Ash was considered as US\$140/t.

These consumption rates were estimated based on a yearly feed of 1,050,000 t of RoM, where the average Mg grade is 24.61%, metallurgical recovery of 80% and a production rate of 345,000 t of EFM per year.

For sulfur prices, the published USGS average prices by Lori E. Apodaca (T 703-648-7724 Email: lapodaca@usgs.gov) over a five year span were used. As bulk sulfur availability in B.C. via Alberta is greater than in the U.S., this is assumed to be a conservative estimate. As well, the estimate of sulfuric acid cost produced from a sulfur burning plant has been based upon criteria given in The Fertilizer Manual, ISBN 0-7923-5032-4 which is a definitive resource.

So, acid costs are based on averages between 2007 through 2012 published by USGS. Sulfuric acid cost is comprised of about 33% sulfur cost, plus about US\$7.50/t for catalyst replacement, Maintenance at proposed production rate will cost about US\$50.00/t.

Table 18.2.2.3 presents published Sulfur prices used in the acid cost estimate.

Table 18.2.2.3: Acid Cost Build Up

Year	Sulfur Price	Sulfur Price Metric
2011	200	220.00
2010	70.48	77.53
2009	1.73	1.90
2008	264.04	290.44
2007	36.49	40.14
Average	114.548	126.00
Acid price	128.59	49.93

The project will produce Sodium Sulfate as a co-product, therefore, the cost of storing and handling this co-product was added to the operating costs. The cost considered for baggage and storage of the co-product is US\$10.00/t-Sodium Sulfate.

Product logistics costs considered the following costs:

- Truck transportation to rail: US\$5.00/t-product;
- Rail transportation to port: US\$20.00/t-product; and
- Port loading and handling: US\$3.00/t-product.

SRK considers these costs sufficient for this operation.

19 Economic Analysis (Item 22)

The financial results of this report are based upon work performed by SRK and have been prepared on an annual basis. All costs are in U.S. constant dollars.

The PEA is preliminary in nature, in that it includes inferred mineral resources that are considered too speculative geologically to have the economic considerations applied to them that would enable them to be categorized as mineral reserves, and there is no certainty that the PEA will be realized.

19.1 Principal Assumptions

A financial model was prepared on an after-tax basis, the results of which are presented in this section. Key criteria used in the analysis are discussed in detail throughout this report. Financial assumptions used are shown summarized in Table 19.1.1.

Table 19.1.1: Model Parameters

Description	Value
Mine Life	42 years
Material Processed	44 Mt
Tonnes Mined	79.9 Mt
Payable Tonnes EFM	14.4 Mt
EFM Market Price (LoM Avg.)	US\$1,100/t Conc.
Payable Tonnes Sodium Sulfate	66.1 Mt
Sodium Sulfate Market Price (LoM Avg.)	US\$75/t Conc.

19.2 Cashflow Forecasts and Annual Production Forecasts

The following contain the production and cost information developed for the project. Table 19.2.1 is a summary of the estimated mine production over a 42-year mine life.

Table 19.2.1: Mine Production Summary

Description	Value	Units
Mine Production		
Waste	35,796	kt
RoM Material	44,070	kt
Total Material	79,866	kt
Mine RoM Daily Capacity	3,000	t/day
RoM Grade		
Mg Grade	24.61%	
Contained Metal		
Magnesium	10,846	kt

A summary of the estimated process plant production for the project is contained in Table 19.2.2 below.

Table 19.2.2: Plant Production Summary

Description	Value	Units
RoM Material Milled	44,070	kt
Daily Capacity	2,880	t/day
Plant Production		
Mg Recovery	80%	
Products		
EFM	14,387	kt
Sodium Sulfate	66,105	kt

The economic analysis results, shown in Table 19.2.3, indicate a pre-tax NPV 5% of US\$1,339 million and IRR of 21%, and a post-tax NPV 5% of US\$830 million and IRR of 17%. Capital identified in the economics is for project installation, sustaining operations, and plant and equipment rebuilds as required. The following provides the basis of the SRK LoM plan and economics:

- A mine life of 42 years;
- An overall average process recovery rate of 80% Mg over the remaining LoM;
- Sodium Sulfate market price of US\$75/t FOB;
- A credit of US\$345/t-EFM from the Sodium Sulfate co-product sale;
- A project cash cost of US\$668/t-EFM;
- EFM market price of US\$1,100/t FOB;
- Sodium Sulfate market price of US\$75/t FOB; and
- Initial capital costs of US\$608 million.

Project economic results and estimated cash costs are summarized in Table 19.2.3 and Table 19.2.4.

Table 19.2.3: Mine & Plant Economic Results

Description	Pre-Tax Results	Post-Tax Results	Units
Market Prices			
MgO EFM Market Price	\$1,100	\$1,100	US\$/t-EFM
Sodium Sulfate Market Price	\$75	\$75	US\$/t-SS
Estimate of Cash Flow			
Gross Income			
MgO EFM Sale	\$15,825,809	\$15,825,809	US\$000s
Sodium Sulfate Sale	\$4,957,906	\$4,957,906	US\$000s
Gross Income	\$20,783,715	\$20,783,715	US\$000s
MgO EFM Freight & Marketing	(\$402,839)	(\$402,839)	US\$000s
Sodium Sulfate Freight & Marketing	(\$1,850,951)	(\$1,850,951)	US\$000s
Gross Revenue	\$18,529,924	\$18,529,924	US\$000s
Royalty	\$0	\$0	US\$000s
Net Revenue	\$18,529,924	\$18,529,924	US\$000s
Operating Costs			
Mining	\$180,856	\$180,856	US\$000s
Sulfuric Acid	\$2,203,514	\$2,203,514	US\$000s
Soda Ash	\$6,169,838	\$6,169,838	US\$000s
Other Processing Costs	\$3,024,983	\$3,024,983	US\$000s
Sodium Sulfate Bagging & Storage	\$661,054	\$661,054	US\$000s
Tailings & Water Management	\$10,344	\$10,344	US\$000s
G&A	\$66,546	\$66,546	US\$000s
Total Operating	\$12,317,135	\$12,317,135	US\$000s
\$/t.mill feed	\$279.49	\$279.49	\$/t-RoM
Operating Costs			
Mining	\$12.57	\$12.57	\$/t-MgO EFM
Sulfuric Acid	\$153.16	\$153.16	\$/t-MgO EFM
Soda Ash	\$428.85	\$428.85	\$/t-MgO EFM
Other Processing Costs	\$210.26	\$210.26	\$/t-MgO EFM
Sodium Sulfate Bagging & Storage	\$45.95	\$45.95	\$/t-MgO EFM
Tailings & Water Management	\$0.72	\$0.72	\$/t-MgO EFM
G&A	\$4.63	\$4.63	\$/t-MgO EFM
Operating Cost	\$856.12	\$856.12	\$/t-MgO EFM
Freight & Marketing	\$156.65	\$156.65	\$/t-MgO EFM
Sodium Sulfate Credit	(\$344.61)	(\$344.61)	\$/t-MgO EFM
MgO Cash Cost	\$668.17	\$668.17	\$/t-MgO EFM
Operating Margin (EBITDA)	\$6,212,790	\$6,212,790	US\$000s
Capital	\$983,667	\$983,667	US\$000s
Federal + Provincial Income Tax	\$0	\$1,146,131	US\$000s
Provincial Mining Tax	\$0	\$694,820	US\$000s
Cash Flow Available for Debt Service	\$5,229,123	\$4,082,992	US\$000s
NPV 5%	\$1,338,764	\$830,083	US\$000s

The PEA is preliminary in nature, in that it includes inferred mineral resources that are considered too speculative geologically to have the economic considerations applied to them that would enable them to be categorized as mineral reserves, and there is no certainty that the PEA will be realized.

Table 19.2.4: Cash Costs Summary

Cash Costs	Mining/Plant	units
MgO EFM	\$1,100	\$/t
Sodium Sulfate (SS)	\$75	\$/t
Milled Material	44,070	kt
MgO EFM	14,387	kt
Sodium Sulfate (SS)	66,105	kt
Total Revenue		
MgO EFM Gross Income	\$15,825,809	(US\$ 000s)
Sodium Sulfate (SS) Gross Income	\$4,957,906	(US\$ 000s)
Total Revenue	\$20,783,715	(US\$ 000s)
Costs		
MgO EFM Freight & Marketing	\$402,839	(US\$ 000s)
Sodium Sulfate Freight & Marketing	\$1,850,951	(US\$ 000s)
Royalty	\$0	
MgO Operating Costs	\$11,656,081	(US\$ 000s)
SS Operating Costs	\$661,054	(US\$ 000s)
Total Costs	\$14,570,925	(US\$ 000s)
Project Cash Cost	\$1,012.78	(\$/t-MgO EFM)
Sodium Sulfate Credit	(\$344.61)	(\$/t-MgO EFM)
MgO Cash Cost	\$668.17	(\$/t-MgO EFM)
Operating Margin	\$6,212,790	(US\$ 000s)
Revenue	\$431.83	(\$/t-MgO EFM)

The PEA is preliminary in nature, in that it includes inferred mineral resources that are considered too speculative geologically to have the economic considerations applied to them that would enable them to be categorized as mineral reserves, and there is no certainty that the PEA will be realized.

Table 19.2.5 contains the annual estimates of mine production and Table 19.2.6 contains annual concentrate production with associated cashflows.

Table 19.2.5: Annual Mine Production

Year	Waste (000's)	RoM (000's)	Total (000's)	Milled Mg Grade (%)	Contained Mg (000's)
2013	0	0	0	0.00	0
2014	0	0	0	0.00	0
2015	0	0	0	0.00	0
2016	0	0	0	0.00	0
2017	0	0	0	0.00	0
2018	0	0	0	0.00	0
2019	0	0	0	0.00	0
2020	1,077	1,050	2,127	25.01	263
2021	706	1,050	1,756	24.81	260
2022	593	1,050	1,643	24.56	258
2023	572	1,050	1,622	24.69	259
2024	524	1,050	1,574	24.70	259
2025	377	1,050	1,427	24.72	260
2026	264	1,050	1,314	24.81	261
2027	356	1,050	1,406	24.95	262
2028	327	1,050	1,377	25.10	264
2029	361	1,050	1,411	25.12	264
2030	560	1,050	1,610	25.04	263
2031	703	1,050	1,753	24.55	258
2032	705	1,050	1,755	24.49	257
2033	831	1,050	1,881	24.17	254
2034	753	1,050	1,803	24.34	256
2035	710	1,050	1,760	24.39	256
2036	635	1,050	1,685	24.73	260
2037	414	1,050	1,464	24.88	261
2038	466	1,050	1,516	24.69	259
2039	624	1,050	1,674	24.11	253
2040	910	1,050	1,960	24.22	254
2041	1,002	1,050	2,052	25.09	263
2042	1,569	1,050	2,619	23.90	251
2043	1,435	1,050	2,485	24.06	253
2044	1,127	1,050	2,177	24.06	253
2045	723	1,050	1,773	24.19	254
2046	597	1,050	1,647	24.43	256
2047	534	1,050	1,584	24.68	259
2048	469	1,050	1,519	24.82	261
2049	575	1,050	1,625	24.88	261
2050	275	1,050	1,325	25.12	264
2051	1,953	1,050	3,003	24.25	255
2052	1,278	1,050	2,328	24.83	261
2053	1,462	1,050	2,512	24.32	255
2054	896	1,050	1,946	24.58	258
2055	1,244	1,050	2,294	23.59	248
2056	2,207	1,050	3,257	23.98	252
2057	1,730	1,050	2,780	24.42	256
2058	1,501	1,050	2,551	24.63	259
2059	1,791	1,050	2,841	24.80	260
2060	872	1,050	1,922	25.19	265
2061	92	1,020	1,112	25.74	263
2062	0	0	0	0.00	0
Total	35,796	44,070	79,866	24.61	10,846

Table 19.2.6: Annual Process Production and Cashflow

Year	EFM (000's)	Sodium Sulfate (000's)	Free Cashflow (US\$000's)	Discount Cashflow (US\$000's)
2013	0	0	(375)	(375)
2014	0	0	(1,250)	(1,190)
2015	0	0	(3,125)	(2,834)
2016	0	0	(6,250)	(5,399)
2017	0	0	(1,375)	(1,131)
2018	0	0	(172,718)	(135,329)
2019	0	0	(362,953)	(270,841)
2020	348	1,575	32,216	22,895
2021	346	1,575	145,644	98,578
2022	342	1,575	142,193	91,659
2023	344	1,575	138,414	84,974
2024	344	1,575	97,822	57,195
2025	344	1,575	92,115	51,293
2026	346	1,575	93,369	49,516
2027	348	1,575	94,333	47,645
2028	350	1,575	96,193	46,270
2029	350	1,575	96,427	44,174
2030	349	1,575	95,299	41,579
2031	342	1,575	89,931	37,368
2032	341	1,575	90,112	35,660
2033	337	1,575	86,918	32,758
2034	339	1,575	88,644	31,818
2035	340	1,575	88,860	30,377
2036	344	1,575	92,516	30,121
2037	347	1,575	94,197	29,207
2038	344	1,575	92,201	27,227
2039	336	1,575	86,359	24,288
2040	337	1,575	86,734	23,232
2041	349	1,575	95,363	24,327
2042	333	1,575	80,099	19,460
2043	335	1,575	84,442	19,538
2044	335	1,575	85,260	18,788
2045	337	1,575	86,917	18,241
2046	340	1,575	89,278	17,844
2047	344	1,575	91,761	17,467
2048	346	1,575	93,149	16,887
2049	347	1,575	93,471	16,138
2050	350	1,575	95,472	15,699
2051	338	1,575	85,783	13,434
2052	346	1,575	92,765	13,836
2053	339	1,575	87,311	12,402
2054	342	1,575	90,525	12,246
2055	329	1,575	79,901	10,294
2056	334	1,575	83,045	10,190
2057	340	1,575	87,084	10,177
2058	343	1,575	90,502	10,073
2059	345	1,575	91,695	9,719
2060	351	1,575	96,668	9,759
2061	348	1,530	101,302	9,739
2062	0	0	33,747	3,090
Total	14,387	66,105	\$3,387,995	\$830,083

The PEA is preliminary in nature, in that it includes inferred mineral resources that are considered too speculative geologically to have the economic considerations applied to them that would enable them to be categorized as mineral reserves, and there is no certainty that the PEA will be realized.

19.3 Taxes, Royalties and Other Interests

Taxes and other interests have been calculated for the project, including:

- No royalties;
- Federal/Provincial Tax applied at a 27% rate;
- Provincial Mining Tax at 2% of Net Current Proceeds and 13% of Net Revenue (after recovery of investment); and
- Canadian Capital Cost Allowance.

19.4 Sensitivity Analysis

Sensitivity analysis for key economic parameters is shown in Table 19.4.1. The Project is nominally most sensitive to market prices (revenues). The Project’s sensitivities to capital and operating costs are similar but slightly more susceptible to operating costs.

Table 19.4.1: Sensitivity Analysis of Pre-Tax NPV 5% (US\$ million)

NPV (US\$ million)	80%	90%	Base	110%	120%
Revenue	49	694	1,339	1,983	2,628
Operating Costs	2,108	1,724	1,339	954	569
Capital Costs	1,451	1,395	1,339	1,283	1,227

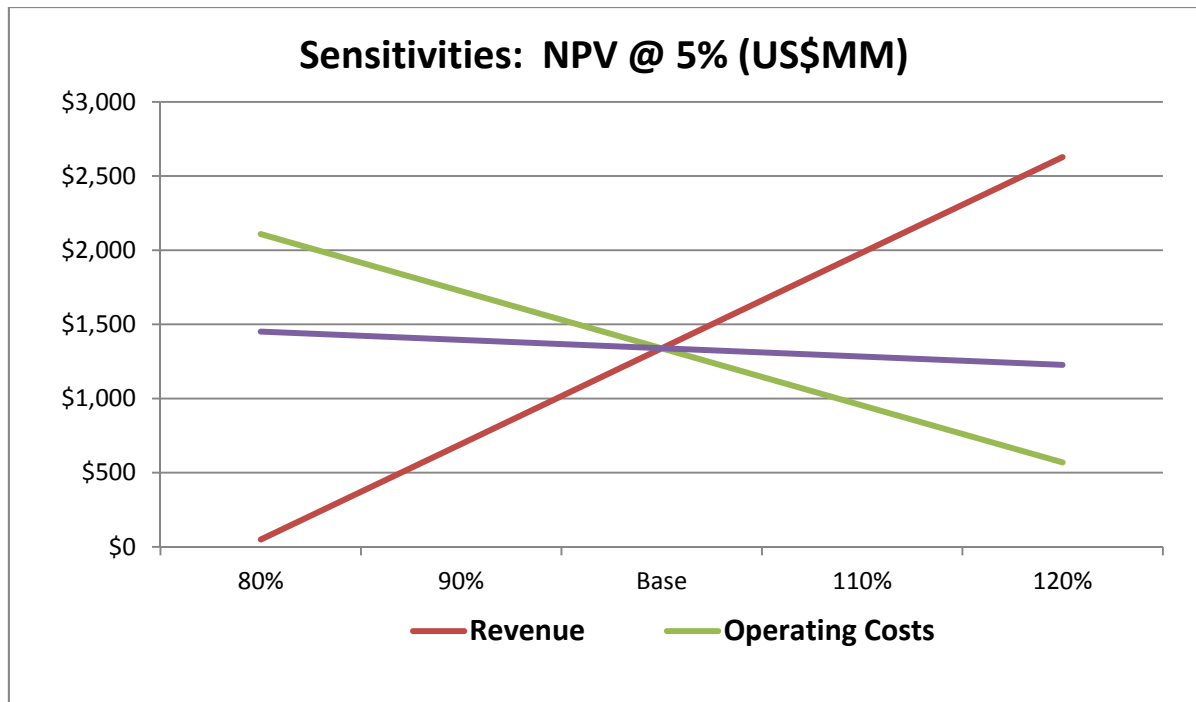

Figure 19.4.1: Project Sensitivities of NPV 5% (US\$ million)

19.4.1 Results

Based on the data that was supplied and the analysis performed for the project, the economics suggest further optimization of price forecasts, operating cost and capital cost estimation is warranted in future studies.

20 Adjacent Properties (Item 23)

SRK is not aware of any silicate-hosted Mg properties adjacent to the Record Ridge Project.

21 Other Relevant Data and Information (Item 24)

There is no additional relevant data or information that has not been presented in the context of this report.

22 Interpretation and Conclusions (Item 25)

22.1 Results and Conclusions

The economic analysis results, shown in Table 19.2.3, indicate a pre-tax NPV 5% of US\$1,339 million and IRR of 21%, and a post-tax NPV 5% of US\$830 million and IRR of 17%. Capital identified in the economics is for project installation, sustaining operations, and plant and equipment rebuilds as required. The following provides the basis of the SRK LoM plan and economics:

- A mine life of 42 years;
- An overall average process recovery rate of 80% Mg over the remaining LoM;
- Sodium Sulfate market price of US\$75/t FOB Record Ridge;
- A credit of US\$345/t-EFM from the Sodium Sulfate co-product sale;
- A project cash cost of US\$668/t-EFM;
- EFM market price of US\$1,100/t FOB;
- Sodium Sulfate market price of US\$75/t FOB; and
- Initial capital costs of US\$529 million.

Project economic results and estimated cash costs are summarized in Table 22.1.1 and Table 22.1.2.

Table 22.1.1: Mine & Plant Economic Results

	Pre-Tax Results	Post-Tax Results	Units
MgO EFM Market Price	\$1,100	\$1,100	US\$/t-EFM
Sodium Sulfate Market Price	\$75	\$75	US\$/t-SS
Gross Income			
MgO EFM Sale	\$15,825,809	\$15,825,809	US\$000s
Sodium Sulfate Sale	\$4,957,906	\$4,957,906	US\$000s
Gross Income	\$20,783,715	\$20,783,715	US\$000s
MgO EFM Freight & Marketing	(\$402,839)	(\$402,839)	US\$000s
Sodium Sulfate Freight & Marketing	(\$1,850,951)	(\$1,850,951)	US\$000s
Gross Revenue	\$18,529,924	\$18,529,924	US\$000s
Royalty	\$0	\$0	US\$000s
Net Revenue	\$18,529,924	\$18,529,924	US\$000s
Operating Costs			
Mining	\$180,856	\$180,856	US\$000s
Sulfuric Acid	\$2,203,514	\$2,203,514	US\$000s
Soda Ash	\$6,169,838	\$6,169,838	US\$000s
Other Processing Costs	\$3,024,983	\$3,024,983	US\$000s
Sodium Sulfate Bagging & Storage	\$661,054	\$661,054	US\$000s
Tailings & Water Management	\$10,344	\$10,344	US\$000s
G&A	\$66,546	\$66,546	US\$000s
Total Operating	\$12,317,135	\$12,317,135	US\$000s
\$/t.mill feed	\$279.49	\$279.49	\$/t-RoM
Operating Costs			
Mining	\$12.57	\$12.57	\$/t-MgO EFM
Sulfuric Acid	\$153.16	\$153.16	\$/t-MgO EFM
Soda Ash	\$428.85	\$428.85	\$/t-MgO EFM
Other Processing Costs	\$210.26	\$210.26	\$/t-MgO EFM
Sodium Sulfate Bagging & Storage	\$45.95	\$45.95	\$/t-MgO EFM
Tailings & Water Management	\$0.72	\$0.72	\$/t-MgO EFM
G&A	\$4.63	\$4.63	\$/t-MgO EFM
Operating Cost	\$856.12	\$856.12	\$/t-MgO EFM
Freight & Marketing	\$156.65	\$156.65	\$/t-MgO EFM
Sodium Sulfate Credit	(\$344.61)	(\$344.61)	\$/t-MgO EFM
MgO Cash Cost	\$668.17	\$668.17	\$/t-MgO EFM
Operating Margin (EBITDA)	\$6,212,790	\$6,212,790	US\$000s
Capital	\$983,667	\$983,667	US\$000s
Federal + Provincial Income Tax	\$0	\$1,146,131	US\$000s
Provincial Mining Tax	\$0	\$694,820	US\$000s
Cash Flow Available for Debt Service	\$5,229,123	\$4,082,992	US\$000s
NPV 5%	\$1,338,764	\$830,083	US\$000s

The PEA is preliminary in nature, in that it includes inferred mineral resources that are considered too speculative geologically to have the economic considerations applied to them that would enable them to be categorized as mineral reserves, and there is no certainty that the PEA will be realized.

Table 22.1.2: Cash Costs Summary

Cash Costs	Mining/Plant	Units
MgO EFM	\$1,100	\$/t
Sodium Sulfate (SS)	\$75	\$/t
Milled Material	44,070	kt
MgO EFM	14,387	kt
Sodium Sulfate (SS)	66,105	kt
Total Revenue		
MgO EFM Gross Income	\$15,825,809	(US\$ 000s)
Sodium Sulfate (SS) Gross Income	\$4,957,906	(US\$ 000s)
Total Revenue	\$20,783,715	(US\$ 000s)
Costs		
MgO EFM Freight & Marketing	\$402,839	(US\$ 000s)
Sodium Sulfate Freight & Marketing	\$1,850,951	(US\$ 000s)
Royalty	\$0	
MgO Operating Costs	\$11,656,081	(US\$ 000s)
SS Operating Costs	\$661,054	(US\$ 000s)
Total Costs	\$14,570,925	(US\$ 000s)
Project Cash Cost	\$1,012.78	(\$/t-MgO EFM)
Sodium Sulfate Credit	(\$344.61)	(\$/t-MgO EFM)
MgO Cash Cost	\$668.17	(\$/t-MgO EFM)
Operating Margin	\$6,212,790	(US\$ 000s)
Revenue	\$431.83	(\$/t-MgO EFM)

The PEA is preliminary in nature, in that it includes inferred mineral resources that are considered too speculative geologically to have the economic considerations applied to them that would enable them to be categorized as mineral reserves, and there is no certainty that the PEA will be realized.

22.1.1 Exploration

The exploration methods and procedures are consistent with industry best practices. Appropriate drilling methods have been employed, with reasonable spacing for this type of deposit. SRK recommends that the existing topographic survey be updated to include higher resolution data.

22.1.2 Mineral Resource Estimate

The sampling methods, QA/QC, and database management practices employed by WHY are all at or above industry standards and provide a solid basis for the resource estimation. The estimation of mineral resources has been conducted in a manner consistent with industry best practices. Based on the observed geological continuity and the consistency of grade over the extent of the deposit, the mineral resources are not currently limited by the quantity of mineralized material, but by the economics of the mining and extraction of the product.

Further drilling should be conducted in the areas proposed for waste storage, tailings storage, and facilities to condemn those areas to the possibility of additional mineralization located proximal or beneath those footprints.

22.1.3 Infrastructure and Tailings

Project access is generally good, and it is located close to a well-maintained road that, with some improvement, will be suitable for the Project’s needs year-round. Its proximity to the city of Trail is

also advantageous, as Trail serves as a significant rail hub and is familiar with the handling and transport of large quantities of minerals and concentrates. The availability of power and water is also favorable, as the project is located in a water-rich area and is proximal to multiple sources of electricity, including high-tension 500Kv lines and a major natural gas pipeline.

22.1.4 Mine Operations

Mine operations will be simple and analogous to a small quarry operation. Mine capital and operating cost have been estimated appropriately for a PEA level of study.

22.2 Significant Risks and Uncertainties

22.2.1 Surface Rights

The surface rights for the project area include a number of parcels that are designated as privately-held by the B.C. Government's Integrated Cadastral Fabric. WHY would need to secure lease agreements or ownership of these parcels in order to operate the project as it is currently designed. SRK sited facilities independent of the current surface ownership, and are subject to change based on WHY's ability to acquire the rights to this land for operational purposes.

22.2.2 Metallurgy and Processing

The proposed flowsheet and associated economics are based upon limited and un-optimized testing and several key assumptions will need to be actually confirmed with further investigation and optimized testing. This includes, but is not limited to, locked cycle leach and precipitation testing, effective industrial scale liquid solid separations, comprehensive heat and mass balances and the actual bulk availability and pricing of key reagents such as soda ash and sulfur.

- Key parameters such as crushing energy indices as well all comminution abrasion indices need to be determined. As well, further work needs to be done to determine the optimal crush and grind size for effective leaching recovery.
- The Mg leaching recovery is estimated to be 80% overall assuming that with closed cycle plant operations coupled with effective heat input, the majority of the leached magnesium will eventually report as a final product and not be lost due to crystallization or ineffective liquid solid separations. This needs further optimization and verification at the laboratory and pilot scale in a closed operational system.
- It is assumed that waste and by product MgO containing materials will be available and may effectively be used for neutralization of excess acid and solubilized iron precipitation in conjunction with aeration of solutions after leaching in lieu of peroxide oxidation. Further test work needs to be done to confirm and optimize this.
- It is assumed with on-site sulfuric acid production and the subsequent excess exothermic energy production, the overall process is net positive in heat energy or at least balanced. This needs to be carefully analyzed, quantified, and confirmed.
- It is assumed that electrical energy is available at the rates disclosed herein for key energy consuming unit operations such as comminution and MgO fusion.
- It is assumed that a ready supply of bulk elemental sulfur and soda ash are available at the plant site. This needs to be further investigated.

- Further focused leach testing with optimization and closed cycle testing of representative samples needs to be done to confirm reagent consumptions and to achieve enhanced Mg recoveries to solution.
- No actual production of fused magnesia from WHY materials has been tested or confirmed. This needs to be carefully tested and confirmed with representative samples at a laboratory, pilot and industrial scale. In addition only very limited calcinations of magnesium carbonate have been done to produce an intermediate calcined magnesia product. This also needs to be carefully tested further confirmed with representative samples at a laboratory, pilot and industrial scale.
- It is assumed that a large volume of high quality by product sodium sulfate may be produced and sold. As no actual sodium sulfate product has been produced from WHY materials to date, this confirmatory testing needs to be carried out.
- An overall mass, heat and water balance needs to be carried out to hone in on actual recoveries, net energy use and the quantified need and nature of air, water and solid discharges.
- The flow sheet supporting the metallurgical processing is at an early stage of development and has never been tested in a commercial application. There are no comparable commercial operations that use Mg-silicates as a mill feed or use the flow sheet proposed in this report to create an EFM product.

22.2.3 Commodity and Reagent Price

There are three major commodity and reagent price assumptions that have been made in the PEA report. There are several different methods used to estimate commodity and reagent prices. The methods used by SRK, rely on trialing average prices or expert opinions on future prices. The prices cited here may not reflect actual future cost associated with delivery to the project.

Soda Ash

There are no negotiated terms for the purchase of soda ash or estimated transportation from Wyoming to the project site. What information could be found suggested US\$140 was a reasonable price given that the production of soda ash is available from Wyoming. For each tone of rock processed approximately one tonne of soda ash is required for processing and will make up approximately 50% of the total operating cost. Variation in soda ash price and additional transportation costs may be a benefit but also a significant risk to profitability if it were to increase.

EFM

Based on reports supplied by WHY, the quality of the end-product suggested by met-solve and historic information of EFM at a 98% quality, SRK has used a US\$1,100/t price. Because EFM is an industrial mineral there are no specific spot prices and contract terms govern the sale of the product in bulk quantities. The infusion of additional EFM from WHY on a massive scale onto the global market may negatively impact the price achieved. As the effective cash cost of the EFM is US\$668/t, any reduction below that price would require additional credit from sodium sulfate or reduction in soda ash prices to remain profitable. There is a possibility that the project could contribute enough EFM to influence the world supply and pricing structure.

Sodium Sulfate

Based on reports supplied by WHY and investigation to the use of sodium sulfate, SRK has used a price of US\$75/t. While the price information shows less volatility than EFM, the largest risk will likely be the surplus supply Record Ridge would make on the global market (estimated at 10%). When combined with other potential hydro metallurgical operations that may be commissioned, the market could easily be over supplied with cheap sodium sulfate as the cost of disposing it is very high.

Due to the extended period of feasibility, permitting and construction envisioned for the project, the price projections will remain a significant risk until off-take and purchasing agreements can be formalized.

Sulfuric Acid

The cost of sulfuric acid is directly predicated on a cheap and available source of high quality sulfur. If sulfur costs rise or their availability is restricted, this will have a negative impact on the technical and economic viability of the project.

22.2.4 Infrastructure and Tailings

Risks associated with the infrastructure include:

- Capacity of local infrastructure to provide for truck transportation of the significant quantities of reagents and products that the Project will require/generate respectively. There may need to be additional infrastructure improvement and community involvement associated with the trucking of these quantities to and from Trail.
- The actual power and water requirements of the project have been estimated at a scoping level of detail. These will need to be investigated to determine sufficient capacity or any additional costs that might be associated with the Project's requirements.

22.2.5 Permitting

The regulatory process to permit mine development in British Columbia requires active management by the proponent. The schedule and budget for this process varies. The accuracy and certainty of the Project Description and Environmental and Socio-Economic Impact Assessment directly affect the schedule. Stakeholder participation also affects the schedule and budget. Both the B.C.EAA and CEAA 2012 have regulated timelines that must be met by authorities reviewing applications. The regulated timelines do not include time required by the proponent to deal with the results of the consultation process and to amend the application to address concerns raised.

This project is currently at an early stage of environmental assessment and permitting.

22.2.6 Foreseeable Impacts of Risks

The foreseeable impacts of the aforementioned risks should not be understated. Certain risks such as the ability to permit the operation, availability of key reagents, and certain unknown parameters within the proposed process have the capacity to outright stall development of the project, reduce operating parameters, or drive costs to a point where the project becomes uneconomic.

If WHY were to achieve profitable operations, there is a risk that other companies in different parts of the world may use comparable Mg-Silicate deposits, construct a processing facility and produce

magnesium products at a cheaper price that may adversely affect the profitability of the WHY operation.

At this time, SRK has no reason to assume that the risks disclosed above will not be able to be mitigated or eliminated through continued study. SRK has provided recommendations pursuant to addressing these risks, and suggests that a prefeasibility study be completed to gain further perspective.

23 Recommendations (Item 26)

23.1 Recommended Work Programs

SRK recommends the following additional work programs:

- Obtain improved resolution topography accurate to within +/- 1 m that is appropriate for detailed engineering design;
- Additional large-scale locked cycle and pilot scale metallurgical test work to improve Mg recoveries, conform the proposed process and minimize consumables;
- Additional market research to determine the impact of a significant production and contribution of both fused MgO and Glauber salt to the global market;
- Condemnation drilling in the footprints of the proposed tailings and waste storage, as well as the proposed facilities;
- Extensive metallurgical testwork designed to confirm, optimize and improve metallurgical recoveries and the proposed overall process to produce fused magnesia;
- Research into the pricing and availability of reagents needed in the metallurgical process, with the objective of minimizing these costs where possible;
- Engineering optimization studies and investigations;
- Acquisition of surface rights to ensure ability to operate; and
- Studies and activities to support an Environmental Impact Statement and public consultation processes.
- A prefeasibility study to confirm the feasibility of the potential mining, metallurgical, and engineering requirements established by this study;
- Obtain tailings samples for consolidation testing to determine appropriate long-term density and other geotechnical properties required for engineering design;
- Conduct additional geochemical characterization of mill feed, tailings and waste rock to determine the potential environmental impacts and re-evaluate the need for a fully contained lined facility; and Initiation of permitting and surface rights acquisitions that will be needed for construction and development.

In preparation for a review under the EAA and CEAA environmental, socio-economic impact assessments will be required. The impact assessments will be dependent on the baseline studies which will be guided by the plan for resource development, processing and final reclamation.

Baseline studies should be initiated based on the conceptual mine plan presented herein. These studies would include the terrestrial, aquatic and atmospheric environment, as well as archaeological, socio-economic and historical and traditional land-use investigations.

An analysis of potential waste rock and tailings disposal site options is recommended.

Contact with First Nations groups who have interests in the Project area should be made. Opportunities for their involvement in environmental monitoring or baseline studies should be considered by the Proponent.

Continued dialogue with the local business community should be maintained.

23.1.1 Costs

Costs estimated for the proposed work programs are as follows. These estimates are based on SRK’s experience in the following work programs and project-specific risks and opportunities that might exist based on the work presented in this study.

Table 23.1.1.1: Estimated Costs for Recommended Work Programs

Work Program	Cost (US\$)
Improved Topography	400,000
Metallurgical Test Work	800,000
Market Research	100,000
Condemnation Drilling	2,000,000
Prefeasibility Study	2,000,000
Permitting and Surface Rights	5,000,000
Total	\$9,900,000

24 References (Item 27)

- ALS Minerals (2012). Website Technical Information Located at: <http://www.alsglobal.com/Mineral/ALSContent.aspx?key=29#ICPAES>
- B.C. Gas Utility Ltd. (1998). The Southern Crossing Pipeline Project, Application for a Project Approval Certificate. January 1998.
- British Columbia Ministry of Aboriginal Relations and Reconciliation (B.C. MARR) (2011a) Osyoyoos Indian Band Forest and Range Consultation and Revenue Sharing Agreement between the Osyoyoos Indian Band and the Province. March 2011.
- British Columbia Ministry of Aboriginal Relations and Reconciliation (2011b). Lower Similkameen Indian Band Forest and Range Consultation and Revenue Sharing Agreement between the Lower Similkameen Indian Band and the Province. April 2011.
- British Columbia Ministry of Aboriginal Relations and Reconciliation (2011c). Ktunaxa Nation Forest Revenue Sharing Agreement between the Province and the Ktunaxa Nation Council Society. September 2011.
- British Columbia Ministry of Aboriginal Relations and Reconciliation (2013). Website, <http://www.gov.bc.ca/arr/treaty/default.html>. January 2, 2013.
- British Columbia Ministry of Aboriginal Relations and Reconciliation (2013). Website, http://www.newrelationship.gov.bc.ca/agreements_and_leg/forestry.html
- British Columbia Ministry of Environment (2013). Website, <http://www.env.gov.bc.ca/habwiz>
- British Columbia Ministry of Environment (2009). B.C. Environmental Assessment Office User Guide, published in 2009, updated in April 2010
- British Columbia Ministry of Forests (B.C. MOF), 2005. Arrow Timber Supply Area, Rationale for Allowable Annual Cut (AAC) Determination. Effective July 1, 2005. Jim Snetsinger, Chief Forester Government of British Columbia, Canada (2012). Mineral Titles Online Viewer, Website, <https://www.mtonline.gov.bc.ca/mtov/searchTenures.do?owner=145867>
- Data B.C.. (2013). Land Ownership and Status WMS, Integrated Cadastral Fabric (2013) website, <http://www.data.gov.bc.ca/dbc/geo/wms/index.page>,
- Frost, B.R. and Beard, J.S. (2007). On Silica Activity and Serpentinization, Journal of Petrology, May 28, 2007
- Fyles, James, T. (1984) Geologic Setting of the Rossland Mining Camp, Province of B.C. Ministry of Energy, Mines and Petroleum resource, Bulletin 74, 61p.
- Goff, F., Guthrie, G., Lipin, B., Fite, M., Chipera, S., Counce, D., Kluk, E., Ziock, H., (2000). Evaluation of Ultramafic Deposits in the Eastern United States and Puerto Rico as Sources of Magnesium for Carbon Dioxide Sequestration. LA-13694-MS, Los Alamos National Laboratory, April 2000, 46pp.
- Hoy, T and Dunne, K.P.E. (1998). Geological Compilation of the Trail Map Area Southeastern British Columbia, B.C. Ministry of Mines, Energy and Minerals Division, Geological Survey Branch, 1:100,000 Scale map.

- Kim, H and Peck, C. (2008). Diamond Drilling Assessment Report on the Record Ridge South Property, Internal Company Report Western High Yield Resource, February 15, 2008, 67p.
- Intrinsik Environmental Sciences Inc., Swanson Environmental Strategies Ltd, Delphinium Holdings Inc., and Teck Metals Ltd.. (2011). Terrestrial Ecological Risk Assessment for the Teck Metals Ltd. Smelter at Trail, B.C.. Main Report Revised May 2011.
- Logan, J. (2002). Intrusion Related Mineral Occurrences of the Cretaceous Bayonne Magmatic Belt, Southeast British Columbia, British Columbia Geological Survey Branch, Geoscience Map 2001-1, 1p.
- Mathilde, C. and Sergey, S., (2007). Reaction Sea Water mantle: Production of Serpentine, <http://www.ifremer.fr/serpentine/english/scientific-sheet-5.htm>
- McClaughry, J.D. and Gaylord, D.R. (2005). Middle Eocene sedimentary and volcanic infilling of an evolving supradetachment basin: White Lake Basin, south central British Columbia, Canadian Journal of Earth Science Vol 42, p 49-66.
- Merchant Research and Consulting Ltd. (2011). Sodium Sulfate World Market Outlook and Forecast.
- Merchant Research & Consulting Ltd. (2013). Company description retrieved February 2013 from <http://mcgroup.co.uk/about>.
- Met-Solve, (2012). Project MS1358 – WHY Resources – Final Report, October 31, 2012, 117 pp.
- Nixon, G.T., Hammack, J.L., Ash, C.H., Case, G., Connelly, J.N., Heaman, L.M., Laflamme, J.H.G., Nuttall, C., Paterson, W.P.E., and Wong, R.H. (1997). Geology and Platinum group Element Mineralization of Alaskan Type Ultramafic Complexes in British Columbia, B.C. Ministry of Employment and Investment, Energy and Minerals Division, Geological Survey Branch, 141p.
- Price, Barry, J. (2006) Technical Report Midnight, OK, IKL and Adjacent Gold Properties, Rossland Mining Camp, Rossland B.C., April 4, 2006, 95p.
- Roskill Consulting Group Ltd (2012). West High Yield Resources – Short report on High Grade Magnesite Pricing and Quality – 2 November 2012.”
- Roskill Consulting Group Ltd. (2013). Company description retrieved February 2013 from <http://www.roskill.com/>.
- Seigel, C. (2005). Tectonic Evolution of Northern British Columbia, http://www.emporia.edu/earthsci/student/seigel1/Tectonic_Evolution.htm.
- SGS (2012). Website Technical Information Located at: <http://www.sgs.com/en/Mining/Analytical-Services/Chemical-Testing.aspx>
- Stryhas, B., Collins, S., (2009). NI 43-101 Technical Report on Resources, West High Yield Resources Ltd., Record Ridge South, Rossland, British Columbia, February 11, 2009, 87p.
- Voormeij, D.A. and Simandl, G.J. (2004). Ultramafic Rocks in British Columbia: Delineating targets for Mineral Sequestration of CO₂, British Columbia Ministry of Energy and Mines, Resource Development and Geoscience Branch, Summary of Activities, p157-167.
- Waneta Expansion Power Corporation (2006). Waneta Hydroelectric Expansion Project Environmental Assessment Certificate Application – May 2006.

Wenner, D.B. and Taylor, H.P. (1974). D/H and O18/O16 Studies of Serpentinization of Untramafic Rocks, *Geochimica et Cosmochimica Acta*, vol 38, issue 8 p1255-1286.

West High Yield (2009). West High Yield Announces Completion of 2008 Exploration Program and Latest 2008 Drill Results, WHY Press Release February 5, 2009.

25 Glossary

25.1 Mineral Resources

The mineral resources and mineral reserves have been classified according to the “CIM Standards on Mineral Resources and Reserves: Definitions and Guidelines” (November 27, 2010). Accordingly, the Resources have been classified as Measured, Indicated or Inferred, the Reserves have been classified as Proven, and Probable based on the Measured and Indicated Resources as defined below.

A Mineral Resource is a concentration or occurrence of natural, solid, inorganic or fossilized organic material in or on the Earth’s crust in such form and quantity and of such a grade or quality that it has reasonable prospects for economic extraction. The location, quantity, grade, geological characteristics and continuity of a Mineral Resource are known, estimated or interpreted from specific geological evidence and knowledge.

An ‘Inferred Mineral Resource’ is that part of a Mineral Resource for which quantity and grade or quality can be estimated on the basis of geological evidence and limited sampling and reasonably assumed, but not verified, geological and grade continuity. The estimate is based on limited information and sampling gathered through appropriate techniques from locations such as outcrops, trenches, pits, workings and drillholes.

An ‘Indicated Mineral Resource’ is that part of a Mineral Resource for which quantity, grade or quality, densities, shape and physical characteristics can be estimated with a level of confidence sufficient to allow the appropriate application of technical and economic parameters, to support mine planning and evaluation of the economic viability of the deposit. The estimate is based on detailed and reliable exploration and testing information gathered through appropriate techniques from locations such as outcrops, trenches, pits, workings and drillholes that are spaced closely enough for geological and grade continuity to be reasonably assumed.

A ‘Measured Mineral Resource’ is that part of a Mineral Resource for which quantity, grade or quality, densities, shape, physical characteristics are so well established that they can be estimated with confidence sufficient to allow the appropriate application of technical and economic parameters, to support production planning and evaluation of the economic viability of the deposit. The estimate is based on detailed and reliable exploration, sampling and testing information gathered through appropriate techniques from locations such as outcrops, trenches, pits, workings and drillholes that are spaced closely enough to confirm both geological and grade continuity.

25.2 Mineral Reserves

A Mineral Reserve is the economically mineable part of a Measured or Indicated Mineral Resource demonstrated by at least a Preliminary Feasibility Study. This Study must include adequate information on mining, processing, metallurgical, economic and other relevant factors that demonstrate, at the time of reporting, that economic extraction can be justified. A Mineral Reserve includes diluting materials and allowances for losses that may occur when the material is mined.

A ‘Probable Mineral Reserve’ is the economically mineable part of an Indicated, and in some circumstances a Measured Mineral Resource demonstrated by at least a Preliminary Feasibility Study. This Study must include adequate information on mining, processing, metallurgical,

economic, and other relevant factors that demonstrate, at the time of reporting, that economic extraction can be justified.

A ‘Proven Mineral Reserve’ is the economically mineable part of a Measured Mineral Resource demonstrated by at least a Preliminary Feasibility Study. This Study must include adequate information on mining, processing, metallurgical, economic, and other relevant factors that demonstrate, at the time of reporting, that economic extraction is justified.

25.3 Glossary

The following general mining terms may be used in this report.

Table 25.3.1: Glossary

Term	Definition
Assay:	The chemical analysis of mineral samples to determine the metal content.
Capital Expenditure:	All other expenditures not classified as operating costs.
Composite:	Combining more than one sample result to give an average result over a larger distance.
Concentrate:	A metal-rich product resulting from a mineral enrichment process such as gravity concentration or flotation, in which most of the desired mineral has been separated from the waste material in the ore.
Crushing:	Initial process of reducing ore particle size to render it more amenable for further processing.
Cut-off Grade (CoG):	The grade of mineralized rock, which determines as to whether or not it is economic to recover its metal content by further concentration.
Dilution:	Waste, which is unavoidably mined with ore.
Dip:	Angle of inclination of a geological feature/rock from the horizontal.
Fault:	The surface of a fracture along which movement has occurred.
Footwall:	The underlying side of an orebody or stope.
Gangue:	Non-valuable components of the ore.
Grade:	The measure of concentration of metal within mineralized rock.
Hangingwall:	The overlying side of an orebody or slope.
Haulage:	A horizontal underground excavation which is used to transport mined ore.
Hydrocyclone:	A process whereby material is graded according to size by exploiting centrifugal forces of particulate materials.
Igneous:	Primary crystalline rock formed by the solidification of magma.
Kriging:	An interpolation method of assigning values from samples to blocks that minimizes the estimation error.
Level:	Horizontal tunnel the primary purpose is the transportation of personnel and materials.
Lithological:	Geological description pertaining to different rock types.
LoM Plans:	Life-of-Mine plans.
LRP:	Long Range Plan.
Material Properties:	Mine properties.
Milling:	A general term used to describe the process in which the ore is crushed and ground and subjected to physical or chemical treatment to extract the valuable metals to a concentrate or finished product.
Mineral/Mining Lease:	A lease area for which mineral rights are held.
Mining Assets:	The Material Properties and Significant Exploration Properties.
Ongoing Capital:	Capital estimates of a routine nature, which is necessary for sustaining operations.
Ore Reserve:	See Mineral Reserve.
Pillar:	Rock left behind to help support the excavations in an underground mine.
PSI	Pounds per square inch
RoM:	Run-of-Mine.
Sedimentary:	Pertaining to rocks formed by the accumulation of sediments, formed by the erosion of other rocks.
Shaft:	An opening cut downwards from the surface for transporting personnel, equipment, supplies, ore and waste.
Sill:	A thin, tabular, horizontal to sub-horizontal body of igneous rock formed by the

Term	Definition
	injection of magma into planar zones of weakness.
Smelting:	A high temperature pyrometallurgical operation conducted in a furnace, in which the valuable metal is collected to a molten matte or doré phase and separated from the gangue components that accumulate in a less dense molten slag phase.
Stope:	Underground void created by mining.
Stratigraphy:	The study of stratified rocks in terms of time and space.
Strike:	Direction of line formed by the intersection of strata surfaces with the horizontal plane, always perpendicular to the dip direction.
Sulfide:	A sulfur bearing mineral.
Tailings:	Finely ground waste rock from which valuable minerals or metals have been extracted.
Thickening:	The process of concentrating solid particles in suspension.
Total Expenditure:	All expenditures including those of an operating and capital nature.
Variogram:	A statistical representation of the characteristics (usually grade).

25.4 Abbreviations

The following abbreviations may be used in this report.

Table 25.4.1 Abbreviations

Abbreviation	Unit or Term
µm	micron or microns
°	degree (degrees)
A	ampere
AA	atomic absorption
A/m ²	amperes per square meter
ANFO	ammonium nitrate fuel oil
Ag	silver
Au	gold
AuEq	gold equivalent grade
°C	degrees Centigrade
CCD	counter-current decantation
CDN\$	Canadian Dollars
CSA	Canadian Securities Administrators
CIL	carbon-in-leach
CoG	cut-off grade
cm	centimeter
cm ²	square centimeter
cm ³	cubic centimeter
cfm	cubic feet per minute
ConfC	confidence code
Crec	core recovery
CSS	closed-side setting
CTW	calculated true width
dia.	Diameter
EIS	Environmental Impact Statement
EMP	Environmental Management Plan
FA	fire assay
ft	foot (feet)
ft ²	square foot (feet)
ft ³	cubic foot (feet)
g	gram
gal	gallon
g/L	gram per liter
g-mol	gram-mole
gpm	gallons per minute
g/t	grams per tonne

Abbreviation	Unit or Term
ha	hectares
HDPE	Height Density Polyethylene
hp	horsepower
HTW	horizontal true width
ICP-AES	Induced Couple Plasma - Atomic Emission Spectrometry
ICP	induced couple plasma
ID2	inverse-distance squared
ID3	inverse-distance cubed
IFC	International Finance Corporation
ILS	Intermediate Leach Solution
kA	kiloamperes
kg	kilograms
km	kilometer
km ²	square kilometer
koz	thousand troy ounce
kt	thousand tonnes
kt/d	thousand tonnes per day
kt/y	thousand tonnes per year
kV	kilovolt
kW	kilowatt
kWh	kilowatt-hour
kWh/t	kilowatt-hour per metric tonne
L	liter
L/sec	liters per second
L/sec/m	liters per second per meter
lb	pound
LHD	Long-Haul Dump truck
LLDDP	Linear Low Density Polyethylene Plastic
LOI	Loss On Ignition
LoM	Life-of-Mine
m	meter
m ²	square meter
m ³	cubic meter
masl	meters above sea level
M	Molarity
MARN	Ministry of the Environment and Natural Resources
MDA	Mine Development Associates
mg/L	milligrams/liter
ml	milliliters
mm	millimeter
mm ²	square millimeter
mm ³	cubic millimeter
MME	Mine & Mill Engineering
Moz	million troy ounces
Mt	million tonnes
MTW	measured true width
MW	million watts
m.y.	million years
NGO	non-governmental organization
NI 43-101	Canadian National Instrument 43-101
OK	ordinary kriging
OSC	Ontario Securities Commission
oz	troy ounce
%	percent
PLC	Programmable Logic Controller
PLS	Pregnant Leach Solution
PMF	probable maximum flood
ppb	parts per billion
ppm	parts per million
QA/QC	Quality Assurance/Quality Control

Abbreviation	Unit or Term
RC	rotary circulation drilling
RoM	Run-of-Mine
RQD	Rock Quality Description
SEC	U.S. Securities & Exchange Commission
sec	second
SG	specific gravity
SPT	standard penetration testing
st	short ton (2,000 pounds)
t	tonne (metric ton) (2,204.6 pounds)
t/h	tonnes per hour
t/d	tonnes per day
t/y	tonnes per year
TSF	tailings storage facility
TSP	total suspended particulates
US\$	United States Dollar
V	volts
VFD	variable frequency drive
W	watt
XRD	x-ray diffraction
y	year

Appendices

**Appendix A: MLA Characterization of an Ore Sample from the
West High Yield (WHY) Resources Project,
CAMP, February 13, 2012**

**MLA CHARACTERIZATION
Of an Ore Sample from the
West High Yield (WHY) Resources Project**

**Prepared for
WHY Resources**

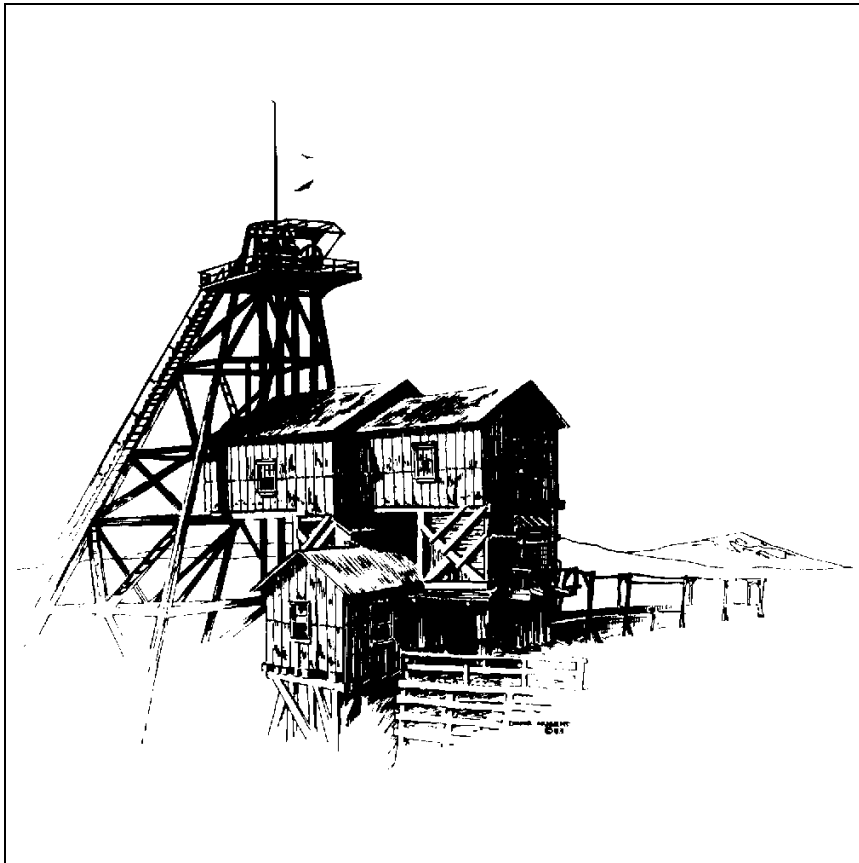

**THE CENTER FOR ADVANCED
MINERAL & METALLURGICAL PROCESSING
Montana Tech of the University of Montana
Butte, Montana**

February 13, 2012

**MLA CHARACTERIZATION
Of an Ore Sample from the
West High Yield (WHY) Resources Project**

Prepared for

WHY Resources

by

**Gary F. Wyss
Laboratory/Equipment Specialist**

Of

**The Center for Advanced Mineral & Metallurgical Processing (CAMP)
Montana Tech of the University of Montana
Room 124 ELC Building
1300 West Park Street
Butte, Montana 59701 USA
Telephone: (406) 496-4145
Fax: (406) 496-4512
Email: gwys@mttech.edu**

February 13, 2012

EXECUTIVE SUMMARY

The Center for Advanced Mineral and Metallurgical Processing (CAMP) received one (1) ore sample from the West High Yield (WHY) Resources project on December 28, 2011. The sample was analyzed by MLA, XRD, lithium tetraborate fusion/ICP-AES analysis for bulk elemental analysis. The fusion/ICP analysis was performed rather XRF for bulk elemental analysis.

The metallic minerals of economic interest found were chromite at 1.14% and pentlandite at 0.16% modal concentration. A chromium-bearing magnetite (FeO₂Cr) phase was defined for this study and was present at 0.73%.

The magnesium silicate mineral phases, serpentine, olivine, diopside, and chlorite, may be of economic interest in this study by virtue of the relatively high concentration of magnesium in the sample. The MLA-calculated magnesium content was 21.3% which correlated well with the fusion/ICP value of 25.7%, by weight.

Serpentine was the main gangue mineral at 74.1% with lesser amounts of magnetite (FeO) at 9.08% and olivine at 7.92%. The high amount of serpentine/olivine, the presence of pentlandite, chromite, and the lack of quartz indicate that the sample came from a high temperature ultramafic source.

Pentlandite was strongly associated with serpentine and occurred unliberated at the grind size studied. Grain sizes for pentlandite ranged from ~2 μm to nearly 70 μm with a P₈₀ of approximately 55 μm .

Chromite was relatively well liberated at the study grind size. When not liberated it was found associated mainly with the intermediate chromium-containing magnetite (FeO₂Cr) phase and somewhat less associated with magnetite (FeO) and the gangue phase, serpentine. Chromite grains ranged from less than 10 μm up to over 100 μm with a P₈₀ near 75 μm .

XRD analysis correlated with MLA in determining that the major gangue phase was composed of hydrous magnesium silicates, serpentine and talc. Also, the presence of magnetite and olivine were supported

Bulk chemical analysis by fusion combined with ICP-AES was relatively consistent with the MLA-calculated values for the major elements magnesium, silicon, and iron. Chemical analysis of chromium was 0.38% and nickel 0.26%. MLA-calculated assay slightly overestimated the chromium; however, the nickel content was underestimated relative to the fusion results. The nickel disparity may have been the result of a low MLA result for the nickel-bearing mineral pentlandite and/or the presence of nickel in chromite. Additionally, the nickel content of the pentlandite in the MLA-calculated may have been conservative.

The MLA-calculated particle size analysis for the pulverized sample had a P₈₀ of 100 µm with particles of <5 mm to nearly 250 µm.

Gary F. Wyss
Laboratory/Equipment Specialist
February 13, 2012

Jay McCloskey, QP
Director CAMP
February 13, 2012

Qualifying Statement

This confidential report was prepared for WHY Resources and is based on information available at the time of the report preparation. It is believed the information, estimates, conclusions and recommendations contained herein are reliable under the conditions and subject to the qualifications set forth. Furthermore, the information, estimates, conclusions and recommendations are based on the experience of CAMP and data supplied by others, but the actual result of the work is dependent, in part, on factors over which CAMP has no control. This report is intended to be used exclusively by WHY Resources and not distributed to other entities. Any other use of or reliance on this report is at the sole risk of the party that so relies.

Scope of Work

CAMP received one (1) sample for overall mineralogy by SEM-EDX using MLA, powder XRD, and bulk elemental analysis that was done by fusion/ICP-AES analysis.

Experimental Work and Results

The ore sample was prepared for MLA analysis from the medium grade material that was ground to a P_{80} of 59 μm according to client-supplied information. A representative sub-sample was mounted in epoxy resin. After curing, the epoxy resin block was ground, polished and carbon coated for SEM/EDX. The data was evaluated by MLA for overall mineralogy.

Particle Size

The particle size distribution for the pulverized (i.e. $P_{80}=59 \mu\text{m}$) WHY Resources sample is shown in Figure 1 below. Particles ranged in size from 1 μm to approximately 250 μm . The MLA-determined P_{80} for the WHY Resources sample was 100 μm and had a P_{50} of 70 μm .

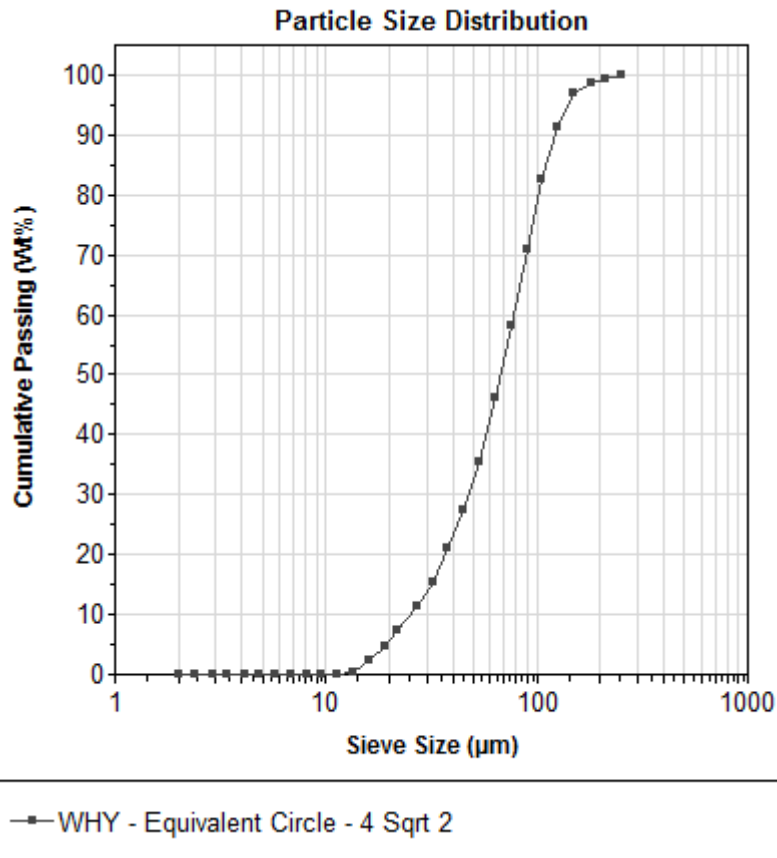

Figure 1. MLA-determined particle size distribution for the WHY Resources sample.

WHY Resources Sample Assay

MLA Modal Mineral Analysis

MLA assay results for the **WHY** sample showed that the major phase was a magnesium silicate phase that was defined as serpentine for this study. Modally, the serpentine phase was 74.1% of the sample. Several minor phases were identified with FeO (magnetite) at 9.08% and olivine at 7.92% being the most predominant. Other minor phases found between 1% and 2% were diopside, chlorite, chromite, mica and dolomite.

Chromium was present in the sample in the mineral phase chromite at 1.14% and FeO_Cr (chromium-bearing magnetite).

Minor to trace amounts of pentlandite were found at 0.16%.

Sulfides present were pyrrhotite at 0.14%, pyrite at 0.023% and chalcopyrite at 0.003%.

Several other minor and trace phases were identified with the complete list of minerals shown in Table 1 below.

Table 1. Modal mineral concentrations for the BP Composite sample.

Mineral	Formula	Conc. (Wt%)
Serpentine	$\text{Mg}_3\text{Si}_2\text{O}_5(\text{OH})_4$	74.1
FeO	Fe_3O_4	9.08
Olivine	$(\text{Mg},\text{Fe})_2\text{SiO}_4$	7.92
Diopside	$\text{CaMgSi}_2\text{O}_6$	1.54
Chlorite	$(\text{Mg}_3,\text{Fe}_2)\text{Al}(\text{AlSi}_3)\text{O}_{10}(\text{OH})_8$	1.46
Chromite	FeCr_2O_4	1.14
Mica	$\text{KAl}_2(\text{AlSi}_3\text{O}_{10})(\text{OH})_2$	1.01
Dolomite	$\text{CaMg}(\text{CO}_3)_2$	0.97
FeO_Cr	$\text{Fe}_3\text{O}_4\text{Cr}_{0.5}$	0.73
Magnesite	MgCO_3	0.65
Plagioclase	$(\text{Na},\text{Ca})(\text{Al},\text{Si})_4\text{O}_8$	0.32
Calcite	CaCO_3	0.32
Corundum	Al_2O_3	0.20
Pentlandite	$(\text{Fe},\text{Ni})_9\text{S}_8$	0.16
Pyrrhotite	FeS	0.14
Biotite	$\text{K}(\text{Mg},\text{Fe})_3(\text{AlSi}_3\text{O}_{10})(\text{OH})_2$	0.13
Quartz	SiO_2	0.034
K_Feldspar	KAlSi_3O_8	0.028
Ilmenite	FeTiO_3	0.027
Pyrite	FeS_2	0.023

Sphene	CaTiSiO ₅	0.010
Rutile	TiO ₂	0.009
Chalcopyrite	CuFeS ₂	0.003
Apatite	Ca ₅ (PO ₄) ₃ F	0.002

MLA-Caclulated Elemental Analysis

The MLA-calculated assay for the WHY Resources sample was 21.3% in magnesium. Magnesium at such a high concentration relative to silicon (17.2%) is characteristic of a high temperature ultramafic rock/deposit. Iron was found at 10.4%.

Elements of economic interest were chromium which was found at 0.60% and nickel at 0.036%.

The MLA-calculated bulk elemental concentrations are presented in Table 3.

Table 2. MLA-calculated bulk elemental concentrations for the WHY Resources sample.

Element	Concentration (Wt. %)
Oxygen	47.7
Magnesium	21.3
Silicon	17.2
Iron	10.4
Hydrogen	1.10
Calcium	0.65
Chromium	0.60
Aluminum	0.51
Carbon	0.26
Sulfur	0.12
Potassium	0.12
Nickel	0.036
Titanium	0.016
Sodium	0.014
Copper	0.001
Phosphorus	P
Fluorine	P

P – element present, but less than 0.001%

MLA Image Analysis

Figure 2 is a classified MLA image from a selected frame obtained during analysis. The mineral phase values shown are in percent by surface area. The highlighted particle is serpentine containing a pentlandite grain.

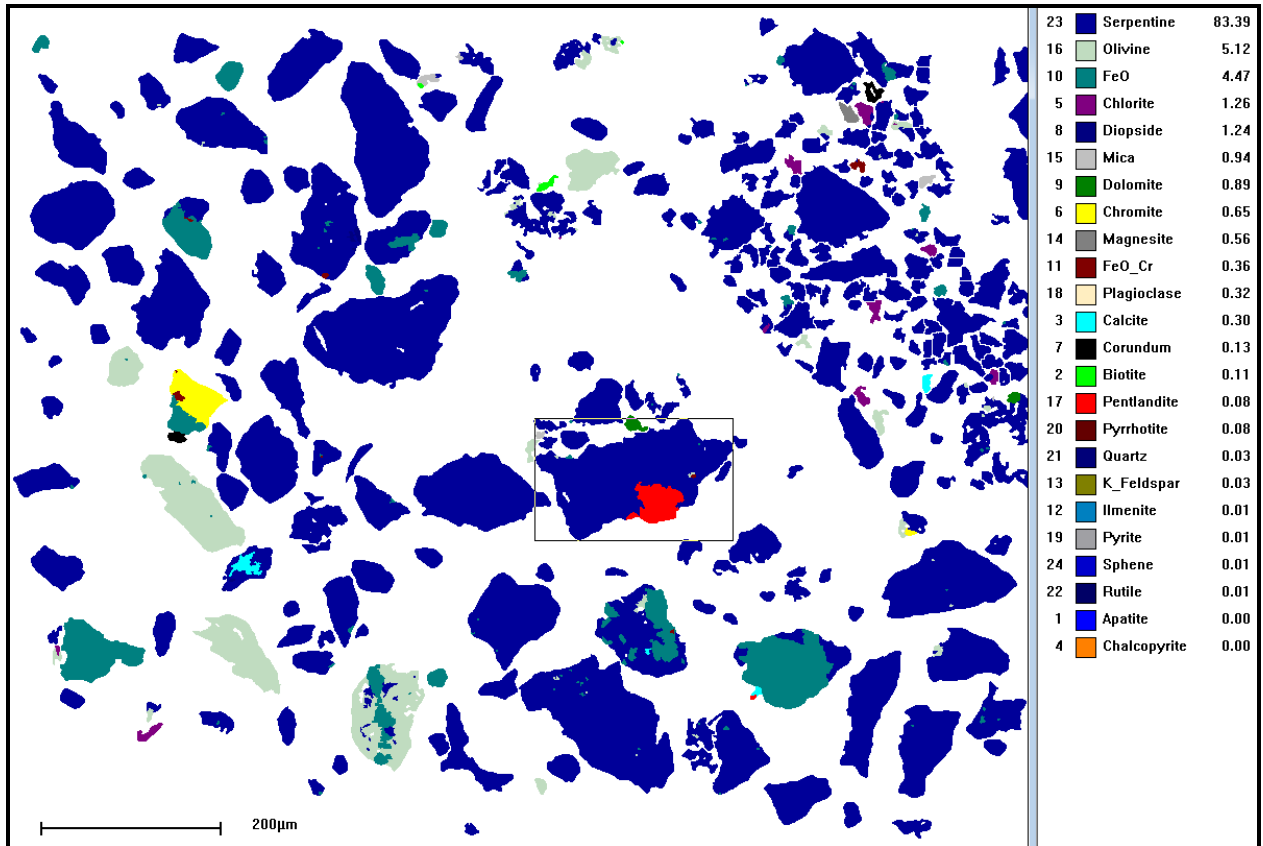

Figure 2. Classified MLA image from the WHY Resources sample. Inset shows overall mineral surface area percentages.

The backscatter electron (BSE) image of the MLA image shown in Figure 2 is presented below in Figure 3. The serpentine-pentlandite particle highlighted in the above figure is circled in the BSE image below. The “bright” phase is the pentlandite in the serpentine matrix.



Figure 3. BSE image from the WHY Resources sample.

The MLA particle lineup of pentlandite-containing particles is shown in Figure 4. The same grain is highlighted as was in the previous MLA and BSE images. By observation the pentlandite inclusions range from 10 µm to 60 µm and typically occurred in the serpentine matrix.

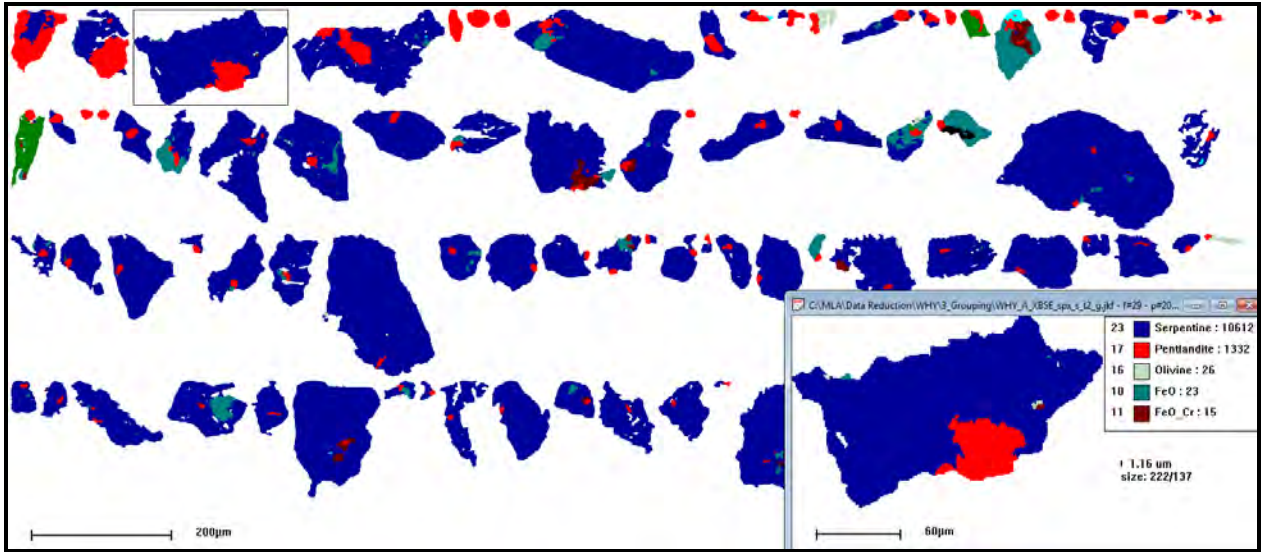

Figure 4. Selected pentlandite-containing particles from the WHY Resources sample.

The pentlandite mineral grain size distribution (Figure 5) shows that grains ranging from ~2 µm to 70 µm were found in the sample. The pentlandite grain size P₈₀ was ~ 55 µm.

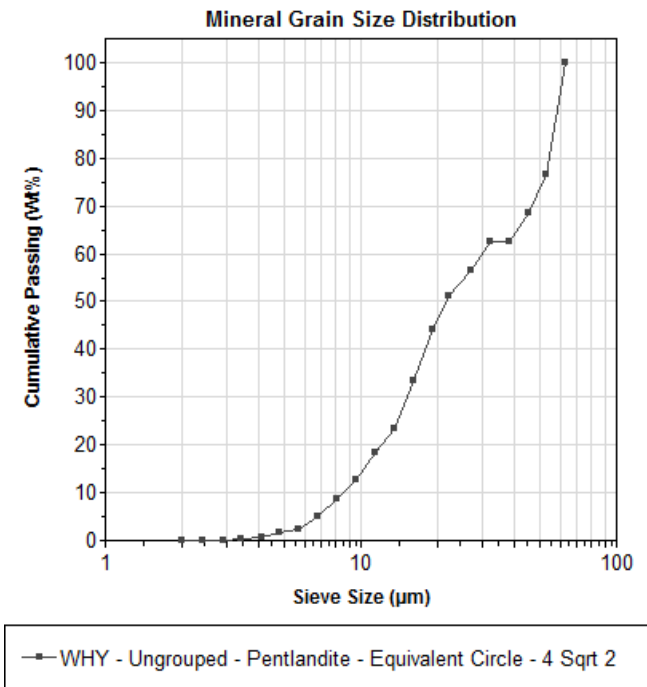

Figure 5. Pentlandite grain size distribution in the WHY Resources sample.

The mineral locking shows that at this grind size that pentlandite occurred as mainly binary particles (Figure 6), with serpentine as observed from the particle lineup.

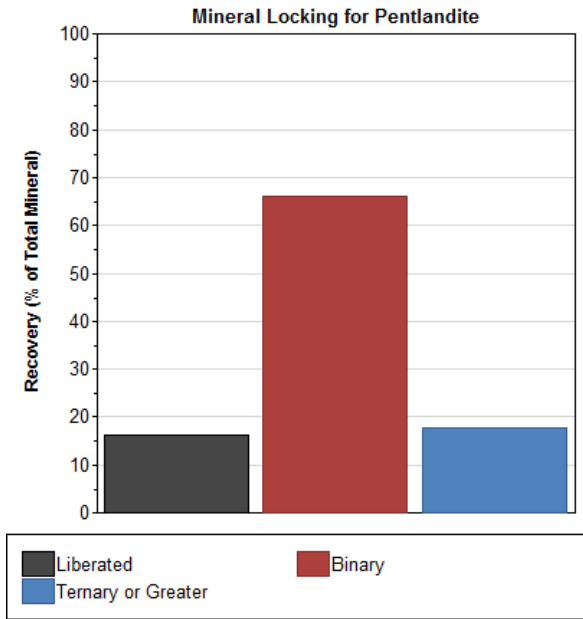

Figure 6. Mineral locking for pentlandite from the WHY Resources sample.

Figure 7 is a classified MLA image that contains the highlighted chromite containing particle. The particle shows the chromite phase associated with serpentine that grades into the chromium-bearing magnetite (FeO_Cr) into magnetite (FeO).

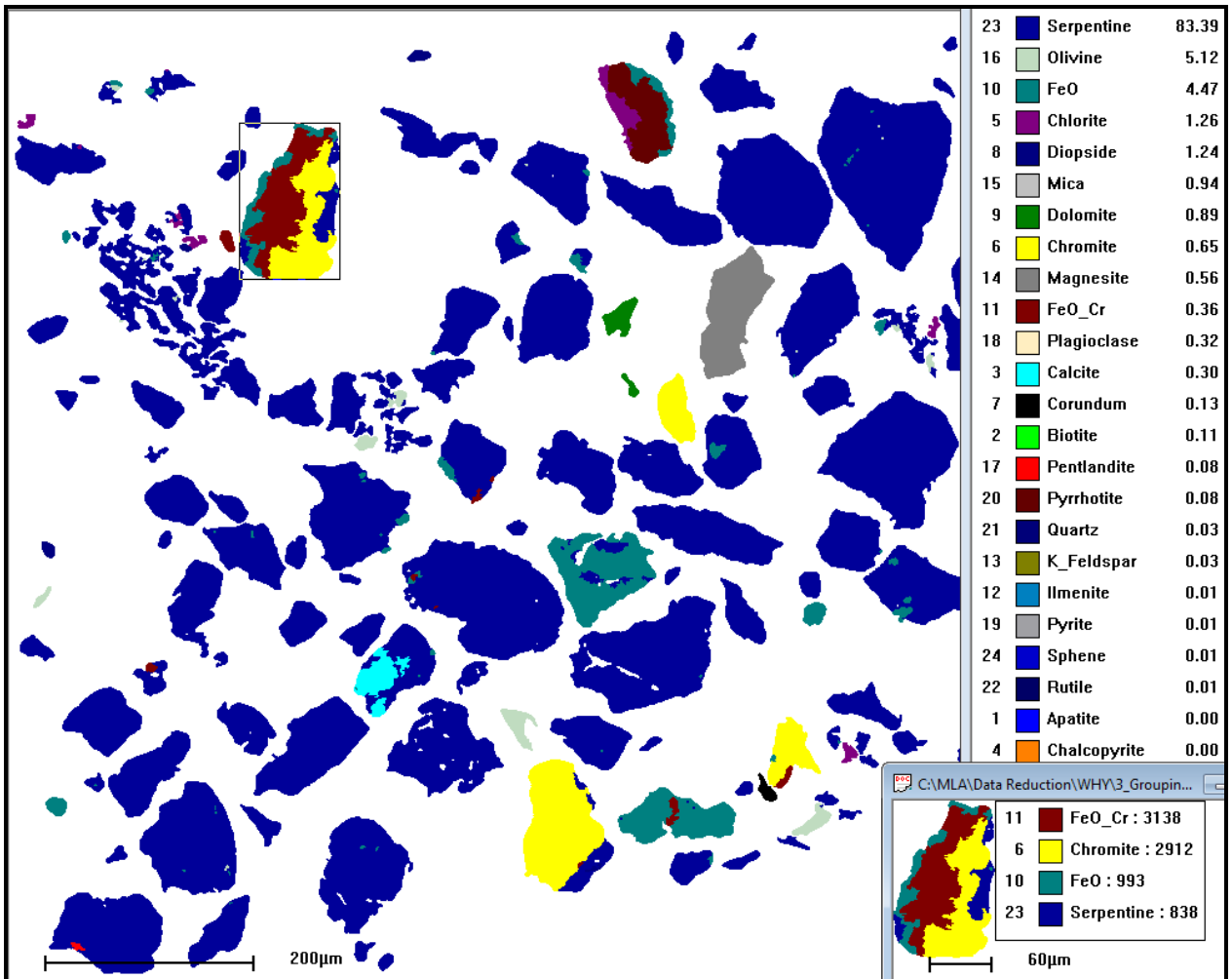

Figure 7. Classified MLA image from the WHY Resources sample with a highlighted chromite-containing particle. Inset shows overall mineral surface area percentages.

The particle containing the chromite is circled in the BSE image in Figure 8. The bright portion is chromite and chromium-containing magnetite (FeO_Cr) that is difficult to discriminate by grey levels. The dark fringes are residual serpentine.

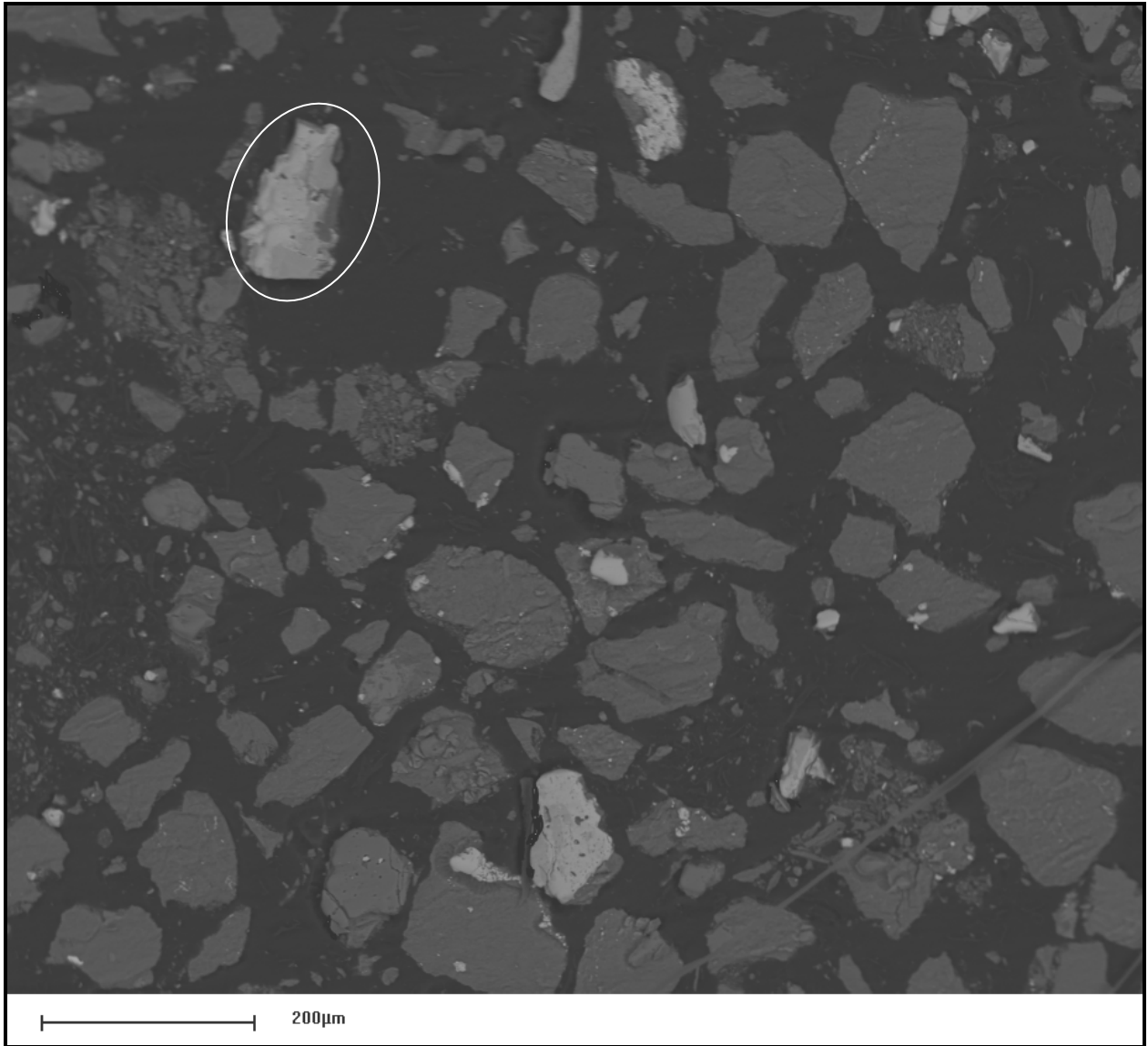

Figure 8. BSE image from the WHY Resources sample with chromite-Cr-FeO grain circled.

The MLA particle lineup of chromite-containing particles is shown in Figure 9. Chromite grains up to 100 µm are shown liberated. Several are shown with fragments of the gangue mineral serpentine and many are associated with the intermediate chromium-magnetite (FeO_Cr) phase and magnetite (FeO).

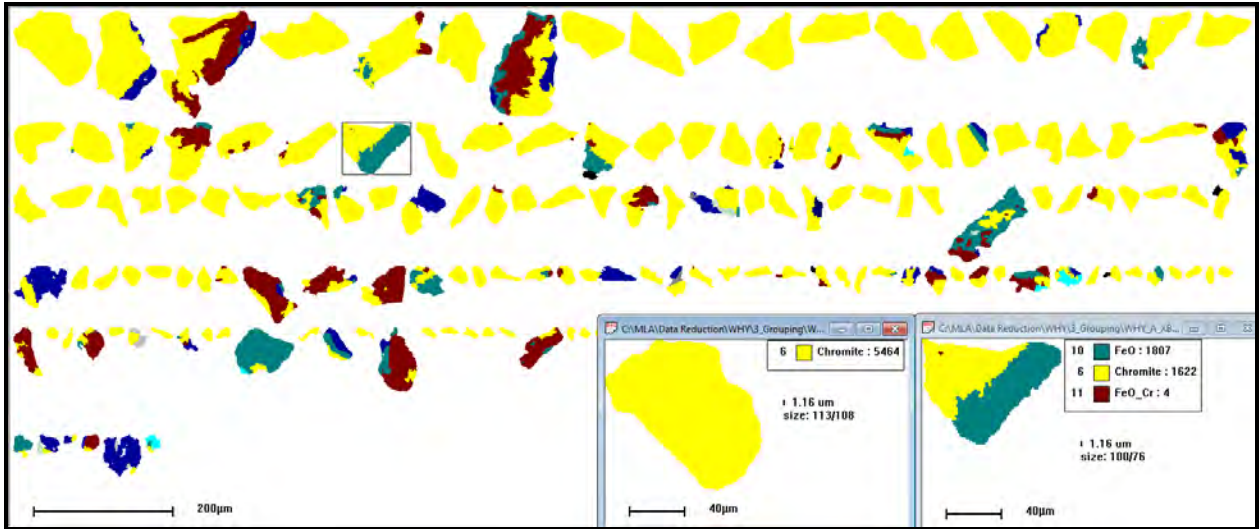

Figure 9. Selected chromite-containing particles from the WHY Resources sample.

The chromite grain size P_{80} was approximately $75 \mu\text{m}$ according to the grain size distribution shown in Figure 10. Chromite grains ranged from less than $10 \mu\text{m}$ up to over $100 \mu\text{m}$ in the sample.

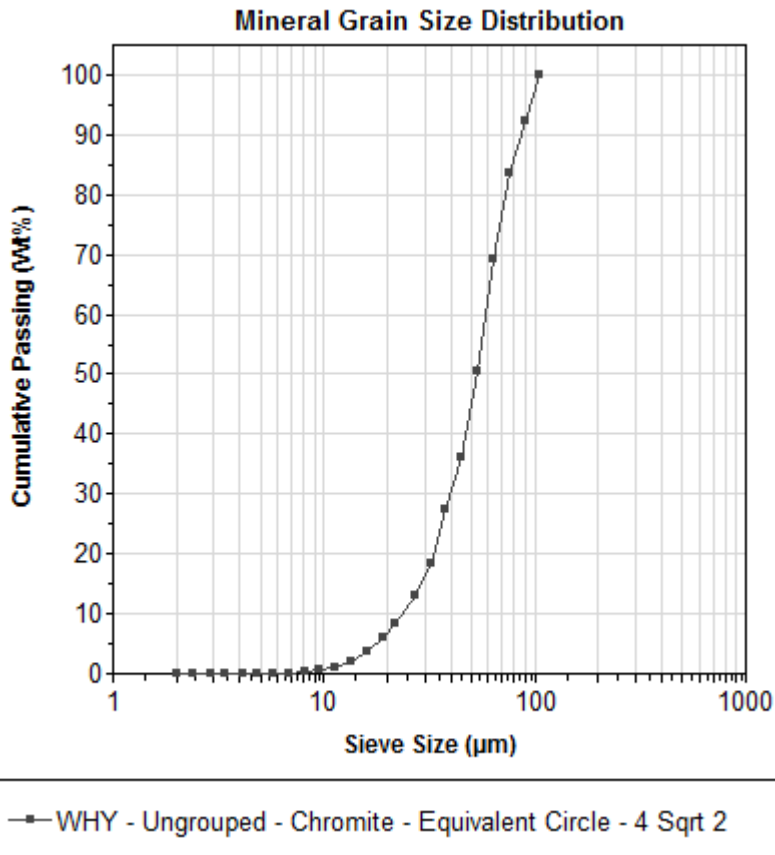

Figure 10. Chromite grain size distribution in the WHY Resources sample.

Mineral locking data showed that chromite had liberation of over 60% in the sample (Figure 11).

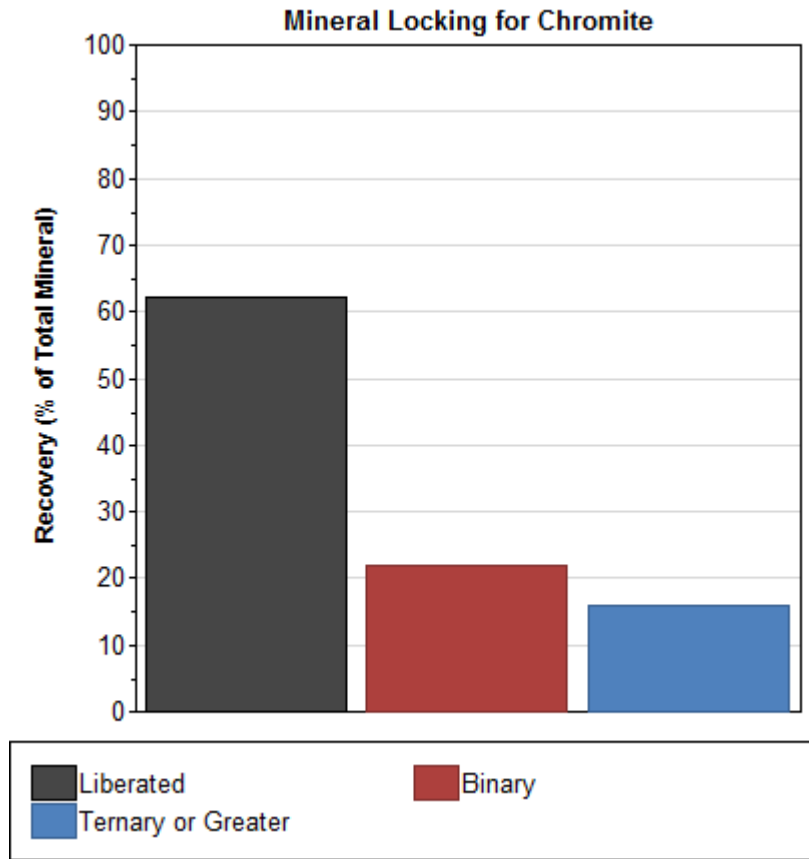

Figure 11. Mineral locking for chromite from the WHY Resources sample.

The mineral grain size distribution for serpentine (Figure 12) reflects the particle size distribution since it is also the most abundant phase in the sample at 74.1% modal concentration.

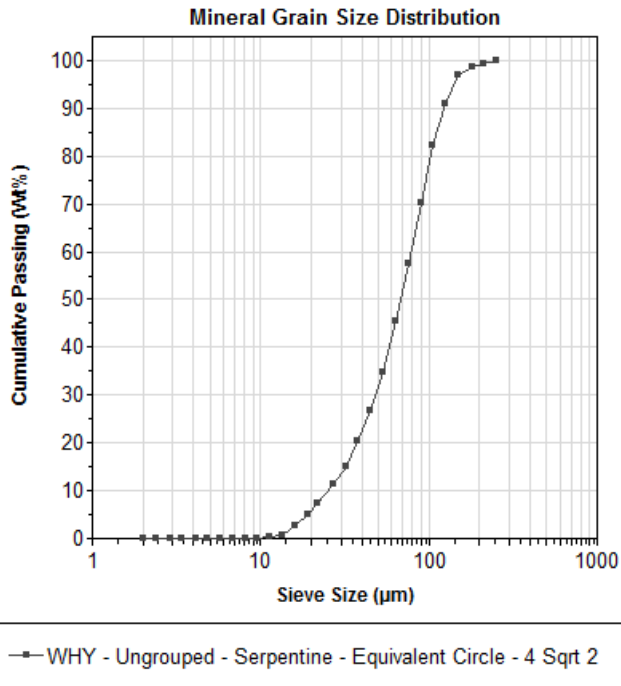

Figure 12. Serpentine grain size distribution in the WHY Resources sample.

The mineral locking data for serpentine (Figure 13) shows that it is also well-liberated at over 80%.

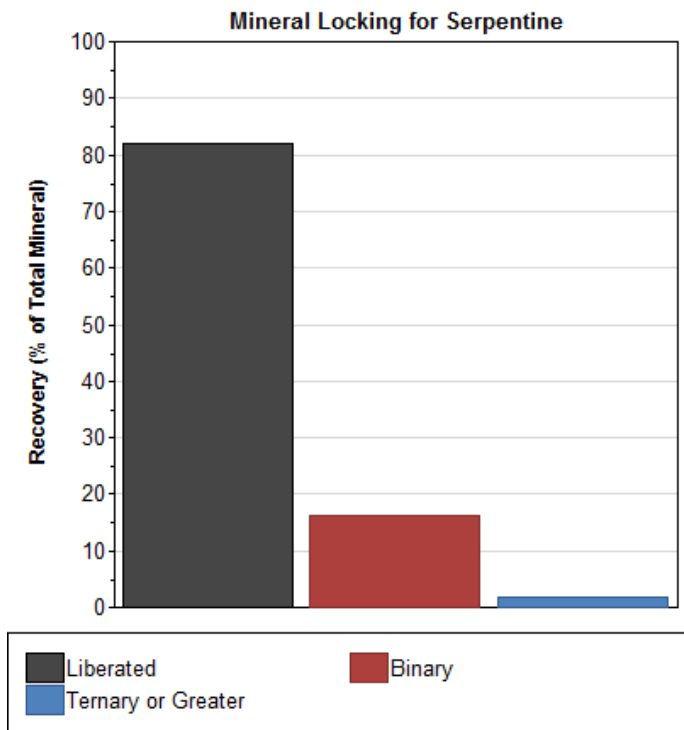

Figure 13. Mineral locking for serpentine from the WHY Resources sample.

X-Ray Diffraction

WHY Resources

The WHY Resources sample was analyzed by powder X-Ray diffraction (XRD) using a Rigaku Ultima IV diffractometer. The measurement conditions are shown in Table 3. The diffraction spectra were qualitatively evaluated using Rigaku PDXL peak search software. Candidate phases are listed in Table 4 and the peak assignments are shown in Table 5.

The WHY Resources sample appeared to be somewhat altered as was evident when attempting to determine candidate phases. The candidate phases were:

- Serpentine (Magnesium silicate hydrate),
- Talc,
- Magnetite,
- Olivine, and
- Diopside.

The XRD spectrum for the WHY resources sample is shown below in Figure 14 along with the spectra for the candidate phases.

Table 3. Powder XRD measurement conditions for the WHY Resources sample.**Measurement conditions - Rigaku Ultima IV / Standard**

X-Ray	40 kV , 44 mA	Scan speed / Duration time	20.0 deg./min.
Goniometer		Step width	0.020 deg.
Attachment	Standard	Scan axis	$\Theta / 2\Theta$
Filter	K-beta filter	Scan range	5.0000 - 90.0000 deg.
CBO selection slit	Bragg – Brentano focusing	Incident slit	2/3deg.
Diffracted beam mono.		Length limiting slit	-
Detector	D/teX Ultra	Receiving slit #1	8.00mm
Scan mode	Continuous	Receiving slit #2	Open

Table 4. Phases identified by qualitative powder XRD for the WHY Resources sample.**Qualitative analysis results**

Phase name	Formula	Figure of merit	DB card number
Magnesium Silicate Hydrate	3 Mg O · 2 Si O ₂ · 2 H ₂ O	0.817	00-001-0094
Talc-1A	Mg ₃ (Si ₂ O ₅) ₂ (O H) ₂	1.481	01-073-0147
iron diiron(III) oxide, Magnetite	Fe ₃ O ₄	3.217	01-076-0956
Diopside	Ca Mg (Si O ₃) ₂	1.932	00-017-0318
hydrogen octakis(magnesium silicate), olivine, syn	H (Mg ₂ (Si O ₄)) ₈	1.600	01-087-2045

Phase name	Formula	Space group	DB card number
Magnesium Silicate Hydrate	3 Mg O · 2 Si O ₂ · 2 H ₂ O	-	00-001-0094
Talc-1A	Mg ₃ (Si ₂ O ₅) ₂ (O H) ₂	2 : C-1	01-073-0147
iron diiron(III) oxide, Magnetite	Fe ₃ O ₄	57 : Pmca	01-076-0956
Diopside	Ca Mg (Si O ₃) ₂	15 : C12/c1,unique-b,cell-1	00-017-0318
hydrogen octakis(magnesium silicate), olivine, syn	H (Mg ₂ (Si O ₄)) ₈	1 : P1	01-087-2045

Table 5. XRD peak assignment for the WHY Resources sample.

Peak list					
No.	2-theta (deg)	d-spacing (angstroms)	Height (cps)	FWHM (deg)	Phase name
1	9.572(8)	9.232(7)	10412(417)	0.154(11)	Talc-1A(0,0,1)
2	12.215(5)	7.240(3)	34117(754)	0.286(7)	Magnesium Silicate Hydrate(0,0,0)
3	18.769(13)	4.724(3)	5850(312)	0.285(19)	iron diiron(III) oxide, Magnetite(1,0,2)
4	19.44(2)	4.563(5)	5064(291)	0.55(3)	Magnesium Silicate Hydrate(0,0,0),Talc-1A(0,2,0),hydrogen octakis(magnesium silicate), olivine,
5	22.98(3)	3.867(4)	3484(241)	0.19(4)	Talc-1A(1,-1,1),hydrogen octakis(magnesium silicate), olivine, syn(2,-1,0)
6	24.416(7)	3.6426(10)	25769(655)	0.287(12)	Magnesium Silicate Hydrate(0,0,0),hydrogen octakis(magnesium silicate), olivine, syn(2,1,-1)
7	28.735(8)	3.1043(9)	10970(428)	0.196(8)	Talc-1A(0,0,3),iron diiron(III) oxide, Magnetite(0,2,1)
8	30.21(3)	2.956(3)	2799(216)	0.34(6)	iron diiron(III) oxide, Magnetite(1,1,4),hydrogen octakis(magnesium silicate), olivine, syn(3,-1,0)
9	31.06(4)	2.877(4)	1672(167)	0.16(5)	Diopside(2,2,-1),hydrogen octakis(magnesium silicate), olivine, syn(1,-2,0)
10	32.432(17)	2.7583(14)	3773(251)	0.12(2)	Talc-1A(1,1,-3),Diopside(1,3,0),hydrogen octakis(magnesium silicate), olivine, syn(1,1,-3)
11	35.558(17)	2.5227(12)	7906(363)	0.19(3)	Talc-1A(1,-3,1),hydrogen octakis(magnesium silicate), olivine, syn(3,1,-2),Unknown
12	36.03(3)	2.4905(18)	11180(432)	0.87(4)	Talc-1A(1,3,1),iron diiron(III) oxide, Magnetite(2,1,2),Diopside(1,3,-1),hydrogen
13	36.60(3)	2.4531(17)	4636(278)	0.35(7)	Magnesium Silicate Hydrate(0,0,0),Talc-1A(2,0,-2),hydrogen octakis(magnesium silicate), olivine,
14	38.040(15)	2.3636(9)	2855(218)	0.24(5)	iron diiron(III) oxide, Magnetite(2,0,4),Diopside(1,3,1),hydrogen octakis(magnesium silicate),
15	41.913(18)	2.1537(9)	2326(197)	0.81(12)	Talc-1A(2,0,-3),iron diiron(III) oxide, Magnetite(2,2,0),Diopside(0,2,2),hydrogen
16	42.98(3)	2.1025(13)	2773(215)	0.60(4)	Magnesium Silicate Hydrate(0,0,0),Talc-1A(0,2,-4),Diopside(3,3,0)
17	51.02(3)	1.7887(9)	3144(229)	0.44(6)	Diopside(5,1,0),hydrogen octakis(magnesium silicate), olivine, syn(2,-2,4)
18	52.31(2)	1.7475(7)	2296(196)	0.35(5)	Magnesium Silicate Hydrate(0,0,0),Talc-1A(2,-2,-4),iron diiron(III) oxide,
19	56.99(4)	1.6147(10)	1807(174)	0.21(4)	Talc-1A(2,0,4),hydrogen octakis(magnesium silicate), olivine, syn(3,-3,-2)
20	60.32(4)	1.5331(10)	4052(260)	0.63(4)	Magnesium Silicate Hydrate(0,0,0),Talc-1A(1,-1,-6),iron diiron(III) oxide,
21	62.44(2)	1.4860(5)	2327(197)	2.51(7)	Talc-1A(3,3,0),iron diiron(III) oxide, Magnetite(2,2,8),Diopside(3,5,0),hydrogen
22	71.75(9)	1.3144(15)	1145(138)	2.27(9)	Magnesium Silicate Hydrate(0,0,0),Talc-1A(0,0,7),iron diiron(III) oxide,
23	82.7(5)	1.166(5)	245(64)	1.4(4)	Diopside(4,2,-4)

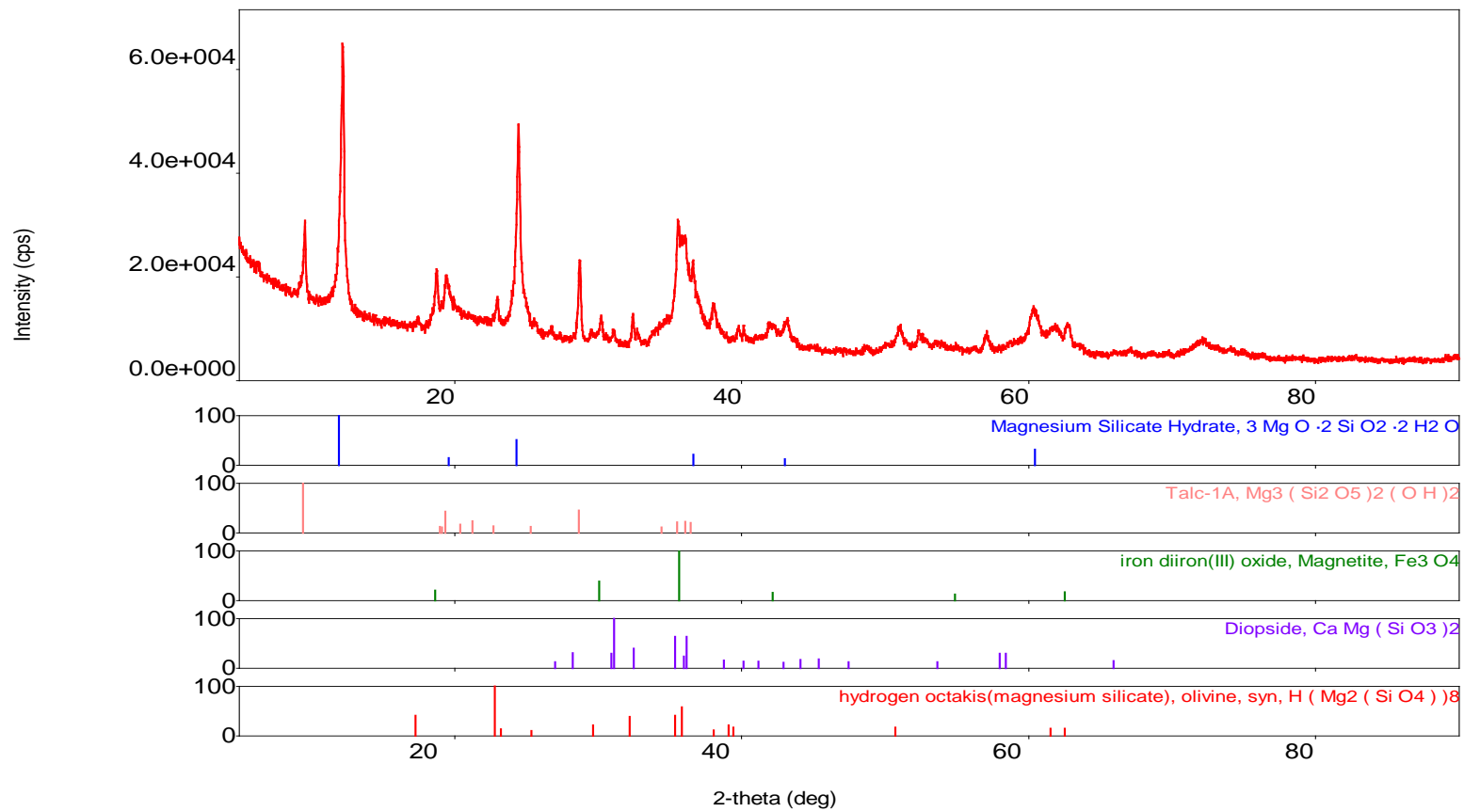

Figure 14. Raw spectrum for WHY Resources sample (red-top) and with candidate phases (below).

Bulk Chemical Analysis

Bulk chemical analysis was performed on the sample using lithium tetraborate fusion combined with inductively-coupled argon plasma-atomic emission spectroscopy (ICP-AES) for major metals, chromium and nickel. The elemental compositions for the sample by fusion/ICP-AES were compared with the MLA-calculated values and are presented in Table 6. Elemental compositions compared favorably between the two methods for the major elements magnesium, silicon, and iron. Fusion/ICP-AES for chromium was 0.38% and nickel was 0.26%. Chromium was slightly overestimated by MLA while nickel was underestimated by nearly an order of magnitude.

Table 6. Bulk Elemental Analysis of WHY Resources sample.

Element	Fusion / ICP-AES Results (%)	MLA-Calculated Results (%)
Magnesium	25.7	21.3
Silicon	21.0	17.2
Iron	6.65	10.4
Calcium	0.70	0.65
Chromium	0.38	0.60
Aluminum	0.32	0.51
Nickel	0.26	0.036
Potassium	0.053	0.053

Appendix B: Metallurgical Test Work on the West High Yield Resource Samples, Met-Solve, October 31, 2012



October 31, 2012

Frank Marasco
West High Yield Resources
P.O Box 68121
Calgary, Alberta
Canada T3G 3N8
Ph. 403.283-5555
Fax 403.206-7159

Dear Mr. Marasco,

Please find attached the **FINAL** report on the metallurgical test work on the West High Yield Resource samples..

Please feel free to contact us if there are any questions.

Sincerely,

Wilhelm Tse, B.A.Sc.
Metallurgist

Prepared for:

West High Yield Resources
P.O Box 68121
Calgary, Alberta
Canada T3G 3N8
Ph. 403.283-5555
Fax. 403.206-7159
Attn: Frank Marasco

Prepared by:

Met-Solve Laboratories Inc.
9850 201 Street
Langley, BC
V1M 4A3
Canada

Project Number:

MS1358

Wilhelm Tse, B.A.Sc.
Process Metallurgist

Ish Grewal, M.A.Sc. P.Eng
President

October 31, 2012

Note: This report refers to the samples as received. The information contained in this report is provided 'as is' without warranty of any kind with respect to the interpretation and use of the data by the client.

1.0 BACKGROUND

West High Yield (WHY) Resources holds 6,220 hectares of mineral claims and grants in the Rossland Mining camp of southern British Columbia. This property, known as the Record Ridge South property, is an intermediate-advanced stage magnesium exploration project, currently tested by 51 diamond drill holes. It is situated on the western outskirts of the town of Rossland in southeastern British Columbia, about 400 km east of Vancouver, B.C. and approximately 8 km north of the Canada-United States border.

Assays of the drill cores indicate an average grade of 23.1% Mg with a potential for higher grades along the eastern edge of the resource. Using a 12% Mg cut-off grade, it has been reported resource of 39.8 million tonnes with 9.16 million tonnes of contained magnesium¹.

Met-Solve Laboratories Inc. was contracted by WHY Resources to conduct test work to evaluate the potential of using a hydrometallurgical process to extract the magnesium and convert it to a marketable product.

1.1 OVERVIEW OF TEST PROGRAM

The program was designed to evaluate the parameters which affect the amount of magnesium extracted via acid leaching, slurry neutralization and impurity removal. Metallurgical test work focused on optimization of the extraction process and improving the grade and purity of a magnesium oxide end product. A process flow sheet was developed to generate a high purity magnesium oxide product.

1.2 PREVIOUS METALLURGICAL TEST WORK

Prior test work² found that a large amount of acid was required to recover the magnesium and that leaching with sulfuric acid resulted in higher extraction compared to using hydrochloric acid. Hence, the test program focused on using sulfuric acid for the leaching test work.

¹ As reported in Record Ridge South NI 43-101 Technical Report provided on WHY Resource's website (<http://whyresources.com/>)

² MS1103 dated Spetember 17, 2008 and October 28, 2008

1.3 SAMPLE DESCRIPTION AND PREPARATION

For this test program, Met-Solve received 29 bags of mid-grade material, 4 bags of high-grade material and 2 bags of low-grade material weighing approximately 15 kg – 20 kg per bag from:

WHY Resources
6 1995 Columbia Ave.
Rosland, BC

The bags contained drill core samples which were subjected to crushing, grinding and splitting. Only the mid-grade ore was used to form a composite from the drill cores. Grinding was carried out using a lab scale rod mill, with 24 stainless steel rods at a slurry pulp density of 40-50%. Four grind sizes of 228 µm, 183 µm, 95 µm and 59 µm were targeted for the test program.

2.0 METHODOLOGY

The key areas of the test program are enumerated below. A summary for each method is explained in more detail in the respective subsections.

- i) Head Assays
- ii) Bond Work Index (BWI)
- iii) Acid Leach Tests
 - Evaluate leach conditions by varying
 - Grind size
 - Acid addition / concentration
 - Leaching pulp density
- iv) Acid Leach Tests Under Intensive Conditions
 - Investigate intensive leaching conditions to maximize extraction with variables such as:
 - Temperature
 - One-stage or two-stage leaches
- v) Acid Leach Tests Under Preferred Conditions
 - Summarize data gathered from all the leach tests to determine preferred leach condition for the remaining test program
- vi) Acid Consumption
 - Calculate amount of “free acid” left in solution
- vii) Ferrous Titration
 - Investigate the nature of iron impurities in solution (ferrous vs. ferric)

- viii) Determine various methods for neutralizing slurry pH and removing impurities from pregnant leach solution by:
 - Adding de-slimes feed
 - Utilizing additional feed screened at 400 mesh (+37 μm) to pregnant leach solution to consume excess acid
 - Vary feed addition until target pH is achieved (to determine ideal pH for iron precipitation)
 - Using MgO to consume excess acid
 - Use of hydrogen peroxide for oxidation of ferrous to ferric
 - MgO added to raise pH (to determine ideal pH for iron precipitation)

- ix) Crystallization
 - Evaporation of pregnant leach solution to various extents to form hydrated magnesium sulfate crystals
 - Investigation of whether crystal formation can reject impurities into remaining solution

- x) Carbonate Precipitation
 - Production of high purity magnesium carbonate (MgCO_3) for calcination using sodium carbonate (Na_2CO_3) addition

- xi) Calcination
 - Calcination tests to better understand optimal decomposition temperature

- xii) Assay Analysis of final MgO product

- xiii) Process Flow Diagram
 - Overall representation of the test program

A general flow sheet of the test program is presented in **Figure 1**.

Figure 1. General Flow Sheet of Test Program for WHY Resources

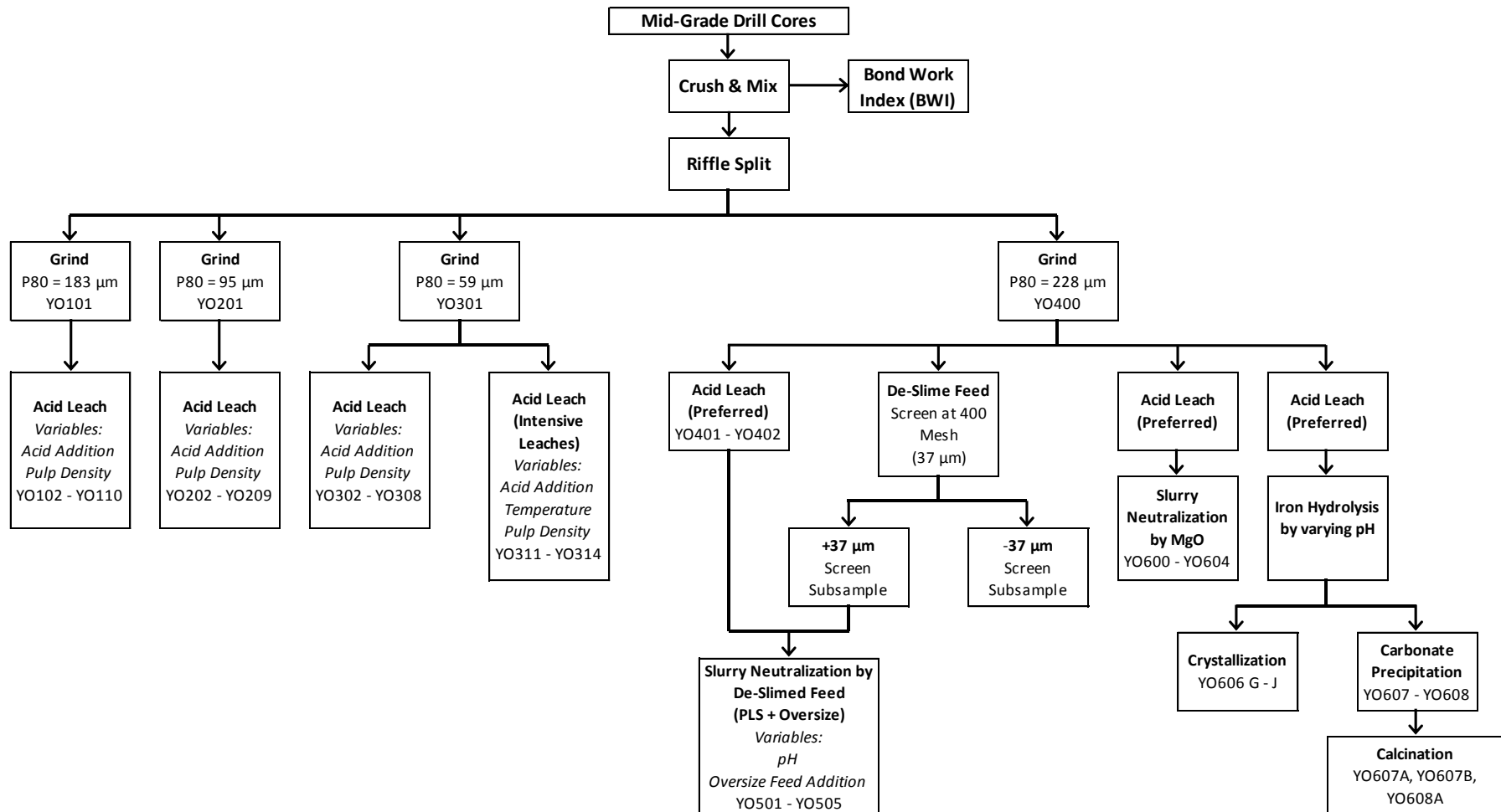

The appendix for this report is outlined below in **Table 1**.

Table 1. Appendix List

Appendix	Content	Test Number
A	Scoping Leach Test Reports	YO102 – YO110, YO202 – YO209, YO302 – YO308
B	Acid Leach Tests Under Intensive Conditions	YO311 – YO314
C	Acid Leach Tests Under Preferred Conditions	YO401 – YO402
D	Slurry Neutralization by De-Slimed Feed Addition	YO501 – YO505
E	Slurry Neutralization by MgO Addition	YO600 – YO604
F	Crystallization Tests	YO606, YO606 G – J
G	Carbonate Precipitation & Calcination	YO607 A – B, YO608 A
H	Process Flow Sheet of Metallurgical Test Work	
I	Acid Consumption Summary	
J	Assay Results	YO101, YO201, YO301, YO607A, YO608A
K	Particle Size Analysis (PSA)	YO101, YO201, YO301, YO400
L	Ferrous Test Work Procedure	
M	Bond Ball Work Index	

2.1 HEAD ASSAYS

Triplicate head assays were done on the WHY mid-grade material at the various target grind size and summarized below:

Table 2. Head Assay Summary

Sample Description	ICP Au ppm	ICP Pd ppm	ICP Pt ppm	ICP Ag ppm	ICP Al %	ICP As ppm	ICP Ba ppm	ICP Bi ppm	ICP Ca %	ICP Cd ppm	ICP Co ppm	ICP Cr ppm	ICP Cu ppm	ICP Fe %	ICP Hg ppm	ICP K %
Head (P ₈₀ = 183 µm)				0.3	0.1	34	<10	3	0.46	<0.5	111	399	<1	3.72	<3	0.02
Head (P ₈₀ = 95 µm)				0.2	0.11	34	<10	<2	0.46	<0.5	113	480	8	4.08	<3	0.02
Head (P ₈₀ = 59 µm)	0.065	0.005	<0.005	0.2	0.11	30	<10	<2	0.46	<0.5	113	633	9	4.41	<3	0.02

Sample Description	ICP La ppm	ICP Mg %	ICP Mn ppm	ICP Mo ppm	ICP Na %	ICP Ni ppm	ICP P ppm	ICP Pb ppm	ICP Sb ppm	ICP Sc ppm	ICP Sr ppm	ICP Ti %	ICP Tl ppm	ICP V ppm	ICP W ppm	ICP Zn ppm	ICP Zr ppm
Head (P ₈₀ = 183 µm)	<2	24.0	762	2	<0.01	1747	23	<2	<2	5	37	<0.01	<10	6	<10	30	<2
Head (P ₈₀ = 95 µm)	<2	23.4	775	3	<0.01	1789	26	<2	<2	5	38	<0.01	<10	7	<10	32	<2
Head (P ₈₀ = 59 µm)	<2	23.7	787	4	<0.01	1809	47	3	<2	5	38	<0.01	<10	8	<10	29	<2

The calculated average head grade, based on the assays presented in **Table 2**, of the WHY mid-grade sample was calculated to be 23.7% magnesium, 4.1% iron and 0.2% nickel.

Note that assaying work was outsourced to one of the many assay labs located in the Metro Vancouver area and some samples were sent to alternate labs for QC.

2.2 BOND WORK INDEX

The ball mill grindability of the WHY sample in terms of a Bond work index number was 21.6 kWh/t (metric) and 19.6 kWh/t (imperial). A copy of the work index report is provided in the appendices.

2.3 ACID LEACH TESTS (YO102 – YO110, YO202 – YO209, YO302 – YO308)

Prior test work carried out by Met-Solve found that a large amount of acid was required to recover the magnesium and that using sulfuric acid generated higher recoveries than hydrochloric acid. The base line leach tests in the current program were conducted for 2 hours at ambient temperature and atmospheric pressure while being stirred by an overhead agitator. The objective of the acid leach test was to elucidate the effects of a number of variable conditions on magnesium extraction.

The variables include:

- 1) Feed grind size ($P_{80} = 183 \mu\text{m}$, $95 \mu\text{m}$ and $59 \mu\text{m}$)
- 2) Leach pulp Density (15%, 25% and 35%)
- 3) Acid addition (200 kg/tonne, 350 kg/tonne and 500 kg/tonne)

Subsamples were taken at intervals of 15, 30 and 60 minutes to monitor the leaching kinetics.

Figure 2 illustrates the procedure used for the acid leach test.

Figure 2. Acid Leach Test Flow Sheet

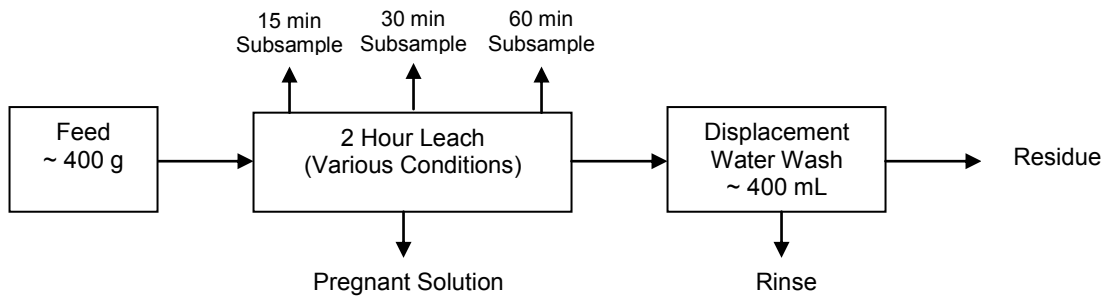

A displacement water wash was done on the residue to ensure minimal magnesium entrainment in the residue.

All of the acid leach test results are plotted in the following charts as shown in **Figure 3**.

Figure 3. Magnesium Extracted as a Function of Acid Addition at Various Grind Sizes and Pulp Densities

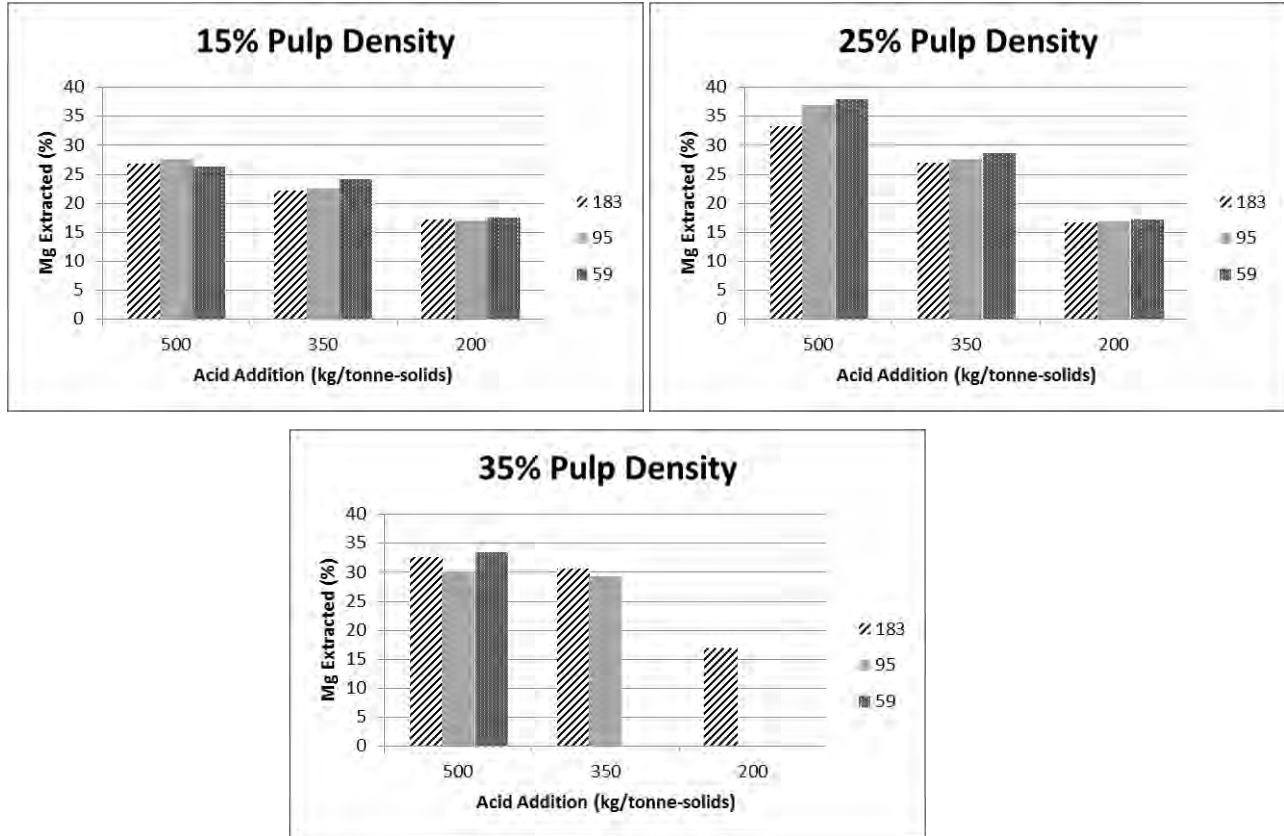

The results indicated that higher acid addition leached more magnesium into solution and was the most important factor for improving leach recovery.

Leaching at higher pulp densities at 25% and 35%, correlated to higher acid concentrations (due to less water being added), also increased magnesium extraction. Crystals were observed in the residue at pulp densities of 25% and 35%, likely due to saturation.

Decreasing particle size did not demonstrate a substantial improvement in leaching magnesium into solution. Therefore, a coarser feed at 228 µm was used for subsequent leach tests for the potential energy savings at full scale.

A review of the leach test data showed that the leach kinetics plateaued within 30 minutes for all of the tests.

Table 3 summarizes the results of the acid leach tests and are sorted by magnesium recovered from leaching.

Table 3. Acid Leach Test Results

Test #	P ₈₀ (microns)	Acid Addition (kg/tonne ore)	Pulp Density	%Wt. Loss of Solids	Acid Concentration (M)	% Mg Leached
YO305	59	500	25%	24.1%	1.80	37.9%
YO205	95	500	25%	24.5%	1.80	37.0%
YO308	59	500	35%	25.4%	3.07	33.4%
YO105	183	500	25%	24.9%	1.80	33.2%
YO108	183	500	35%	14.7%	3.07	32.5%
YO109	183	350	35%	21.5%	2.06	30.5%
YO208	95	500	35%	13.6%	3.07	30.1%
YO209	95	350	35%	22.4%	2.06	29.3%
YO306	59	350	25%	17.4%	1.23	28.6%
YO202	95	500	15%	19.9%	0.92	27.7%
YO206	95	350	25%	18.2%	1.23	27.6%
YO106	183	350	25%	17.8%	1.23	26.9%
YO102	183	500	15%	15.2%	0.92	26.7%
YO302	59	500	15%	20.9%	0.92	26.3%
YO303	59	350	15%	17.0%	0.64	24.1%
YO203	95	350	15%	17.5%	0.64	22.6%
YO103	183	350	15%	16.8%	0.64	22.0%
YO304	59	200	15%	13.8%	0.36	17.4%
YO204	95	200	15%	13.1%	0.36	17.1%
YO307	59	200	25%	13.2%	0.69	17.1%
YO104	183	200	15%	12.6%	0.36	17.0%
YO207	95	200	25%	13.5%	0.69	16.8%
YO110	183	200	35%	12.6%	1.13	16.8%
YO107	183	200	25%	13.1%	0.69	16.6%

As it became apparent that the percentage magnesium leached under the test conditions were low, a set of tests were performed under more intensive leach conditions.

2.4 ACID LEACH TESTS UNDER MORE INTENSIVE CONDITIONS (YO311 – YO314)

Additional leach tests were done focusing on acid addition and temperature, since these were identified as important variables in magnesium extraction. The results and procedures for these “intense” leach tests are outlined in **Table 4**.

Since crystallization was noticed on the cake surface upon drying, additional washing of the residue was included to ensure minimal magnesium entrainment in the leach residue.

Table 4. Parameters and Results from Acid Leach Test Under More Intense Conditions

Test #	P ₈₀ (microns)	Acid Addition (kg/tonne ore)	Pulp Density	Temperature (°C)	Acid Concentration (M)	Leach Duration (hr)	% Mg Leached
*YO312	59	500 + 500	25%	70	1.80	2 + 2	76.2%
*YO314	59	500 + 500	35%	70	3.07	0.5 + 0.5	74.6%
YO313	59	1000	25%	25	3.93	2	73.9%
*YO311	59	500 + 500	25%	25	1.80	1 + 1	39.8%

* 2-Stage Leach (Filtered residue from the 1st Stage leach would be re-leached with fresh leach solution in the 2nd Stage)

Leaching under more intense conditions, such as increasing acid addition and leaching at an elevated temperature had higher magnesium extraction into solution. Recoveries greater than 70% were obtainable for this sample.

By comparing a two-stage leach (Test YO311) and a single stage leach (Test YO313), the higher acid concentration in a single leach stage resulted in a larger amount of magnesium extraction.

2.5 ACID LEACH TESTS UNDER PREFERRED CONDITIONS

A set of metallurgical leach parameters was determined after a review of the results.

The description of each variable under these “preferred” conditions are listed as follows:

Acid Addition: 1000 kg/tonne-ore

Even though high acid addition and high temperature were deemed to be the defining variables in improving recovery, a high acid addition was preferred due to it being a more simple process. A 1000 kg/tonne-ore of acid addition was determined to be the theoretical requirement to completely leach all of the magnesium contained in the sample.

Leach Temperature: Ambient (25°C)

Leaching at an elevated temperature of 70°C only provided a slight improvement in recovery that can be compensated with high acid addition. It is important to note that the process is exothermic and the initial leach temperatures often reached 50°C - 60°C without any external source of heat.

Pulp Density: 20%

At pulp densities of 25% and 35%, crystals were seen to be forming in the residue during filtration, suggesting that the solution's concentration was near saturation. It was then proposed that pulp density should be kept at 20% to minimize crystallization.

Acid Concentration: 2.82 M

At a pulp density of 20%, the acid concentration of the leach was 2.82 M.

Particle Size: $P_{80} = 228 \mu\text{m}$

Decreasing particle size did not show a significant increase in recovery. Therefore, a coarser particle size was used, which was beneficial for decreasing filtration time and potentially reducing grinding costs.

Leach Duration: 30 minutes

Subsamples taken from the leach tests indicated that the kinetics of the leach were relatively fast and reached its extent within 30 minutes.

Under these preferred conditions, an average of **62.6%** magnesium was leached into solution. The results from these leach tests are summarized in **Table 5**.

Table 5. Extraction of Magnesium from Preferred Leach Results

Tests	YO401	YO402	YO606	YO607	YO608	Average
Mg Leached from Feed	63.9%	60.1%	68%	60.9%	60.2%	62.6%

For tests YO600 – YO604 and YO606 – YO608, a slurry neutralization test by adding MgO was done before collecting the PLS (see **Section 2.9**). Therefore, the leach recoveries of these tests were adjusted to account for the magnesium addition from MgO.

Tests YO600 – YO604 were preliminary tests run on a smaller sample size and were more susceptible to errors. While trying to reach target pH values, due to its titration-like characteristic, the amount of MgO added might have been overshoot, causing a slight discrepancy between the larger sized leach tests. Therefore, these results were not included in calculating the average leach recovery of the feed. The results of Tests YO600 – YO604 are presented below.

Table 6. Extraction of Magnesium from Preferred Leach Results with a Smaller Sample Size

Tests	YO600	YO601	YO602	YO603	YO604
Mg Leached from Feed	51%	50%	52%	54%	54%

After leaching, the pH of the pregnant leach solution was below 1 (before slurry neutralization) with approximately 7,000 ppm of iron, 23.4% of which was in the form of ferrous. The amount of wash stages also varied for each test.

2.6 ACID CONSUMPTION

The purpose of the acid consumption tests was to determine the amount of “free acid” left in solution after leaching.

The amount of acid consumed was determined using an oxalate/oxalic acid solution to complex the free metals. The results were then plotted (dpH vs volume of NaOH) to identify a titration peak. The initial and final concentration of the leach solution was then compared to find acid consumption levels.

A graph of the results is presented in **Figure 4**.

Figure 4. Magnesium Leached and its Relation to Acid Consumed

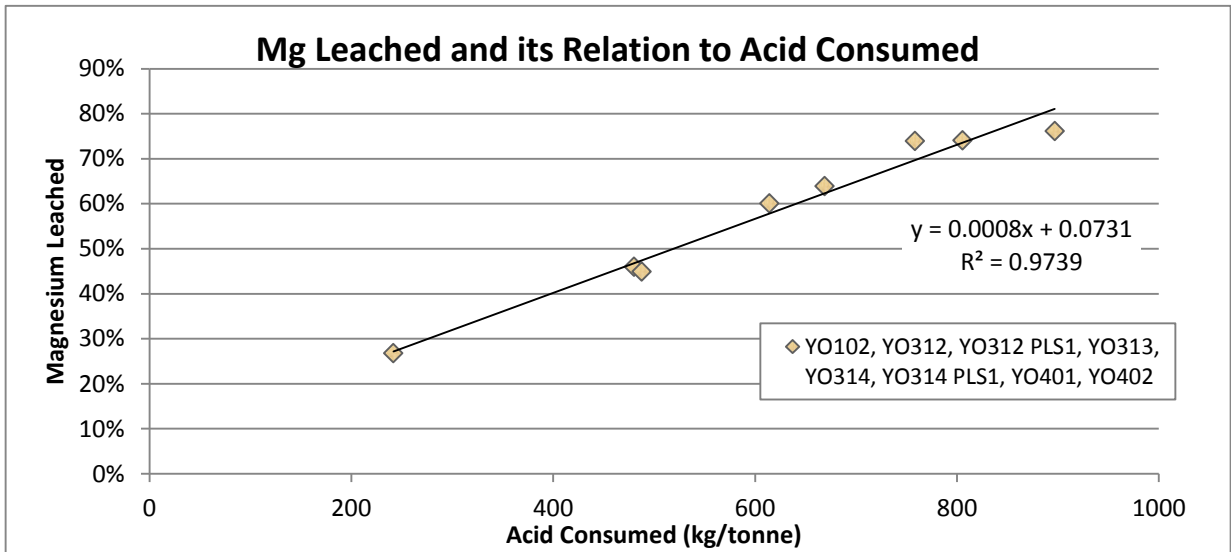

(Tests YO600 - YO604 was not included in the graph since the MgO addition consumed the remaining acid)

There was a strong correlation between magnesium recovery and acid consumed. With increasing acid consumption, an increase in magnesium recovery was observed.

For the acid leach tests under preferred conditions, approximately 62% of the acid was consumed. However, it must be noted that all of the acid was eventually consumed as a result of MgO addition to raise pH for iron precipitation (see **Section 2.9**).

2.7 SLURRY NEUTRALIZATION BY DE-SLIMED FEED ADDITION (YO501 – YO505)

Adding de-slimed feed was one of the methods tested to deplete any “free acid” contained in the pregnant leach solution. It was done to raise the pH for iron hydrolysis to occur and precipitate the impurities from solution.

“De-slime” refers to removal of fine particles in a slurry or sample. The de-slime leach process involved screening a coarser grind feed ($P_{80} = 228 \mu\text{m}$) at 400 mesh (+37 microns) and adding the coarser particles into the pregnant leach solution. De-sliming of the feed was done to improve filtration kinetics.

The de-slimed feed was split into 50 g, 100 g, 150 g and 200 g cuts and added into a 200 mL pregnant leach solution. This pregnant leach solution was obtained by leaching under the preferred leaching conditions (YO401 – YO402).

Once pH was stabilized to approximately 3, the slurry was filtered and the residue cake washed before being sent for assay. The procedure for the de-slime leach can be seen in **Figure 5**.

Figure 5. General Flow Sheet for Leach Test with De-Slimed Feed Addition

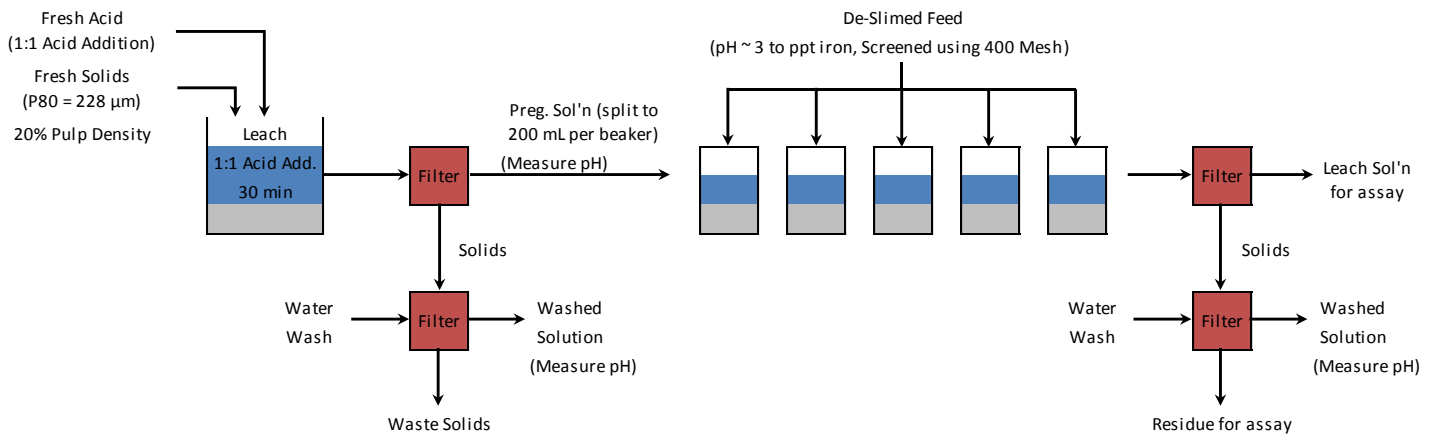

Three repeat tests were done on the 100 g, 150 g and 200 g cuts for quality control. These repeat tests were filtered after leaching for one hour. A summary of the results can be seen in **Figure 6**.

Figure 6. Various Effects of De-Slimed Feed Addition

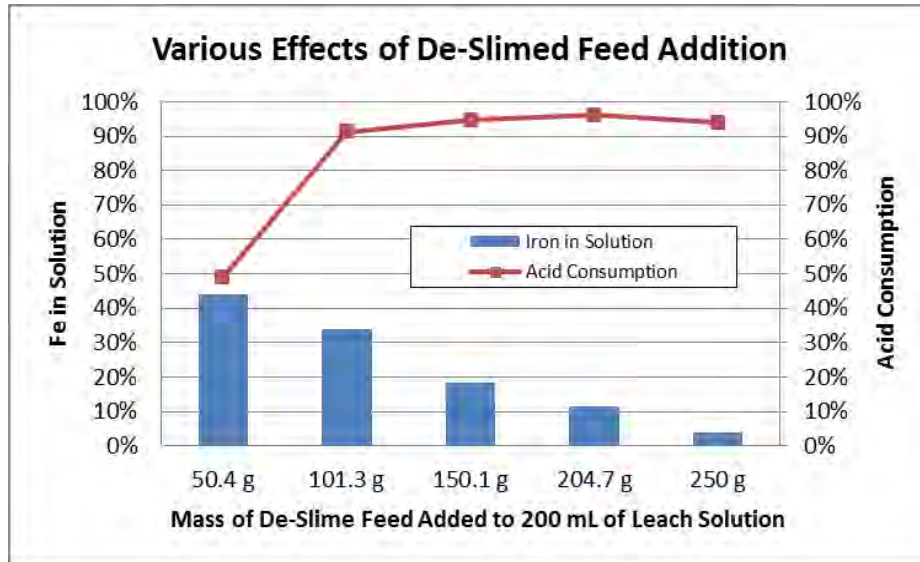

Adding fresh de-slimed feed consumed most of the “free acid” and successfully increased the pH enough to decrease iron levels in solution. However, the large amounts of de-slimed feed material required to decrease the iron content in solution did not make this an effective approach.

2.8 FERROUS TITRATION

A ferrous titration was prepared on the solution samples when assay results revealed that there were iron impurities contained in the leach solution.

The ferrous content in the leach solution was determined by using the ceric sulfate method to selectively oxidize the ferrous component to ferric. The procedure for the titration method is provided in the Appendix.

For the acid leach tests under preferred conditions, an average of 23.4% iron was present in a ferrous state. Oxidation of ferrous to ferric was done by adding hydrogen peroxide to the slurry after leaching.

2.9 SLURRY NEUTRALIZATION BY MgO ADDITION (YO600 – YO604)

Due the large amount of feed material required to reach the desired pH shift, an alternate method was tested to consume the remaining “free acid” and raise the pH for iron precipitation. This was done using MgO to consume excess acid. Hydrogen peroxide addition was also introduced to these tests to convert any iron present as ferrous to ferric in solution.

After leaching under preferred conditions, hydrogen peroxide was added into the slurry to ensure complete oxidation of ferrous to ferric. A 20% (w/w) MgO slurry was then added until target pH was reached. There were a total of eight tests completed at different pH levels. Once pH was stabilized, the slurry was filtered and washed twice with water. The flow sheet for this test procedure is presented in **Figure 7**.

Figure 7. General Flow Sheet for Leach Test with MgO Addition

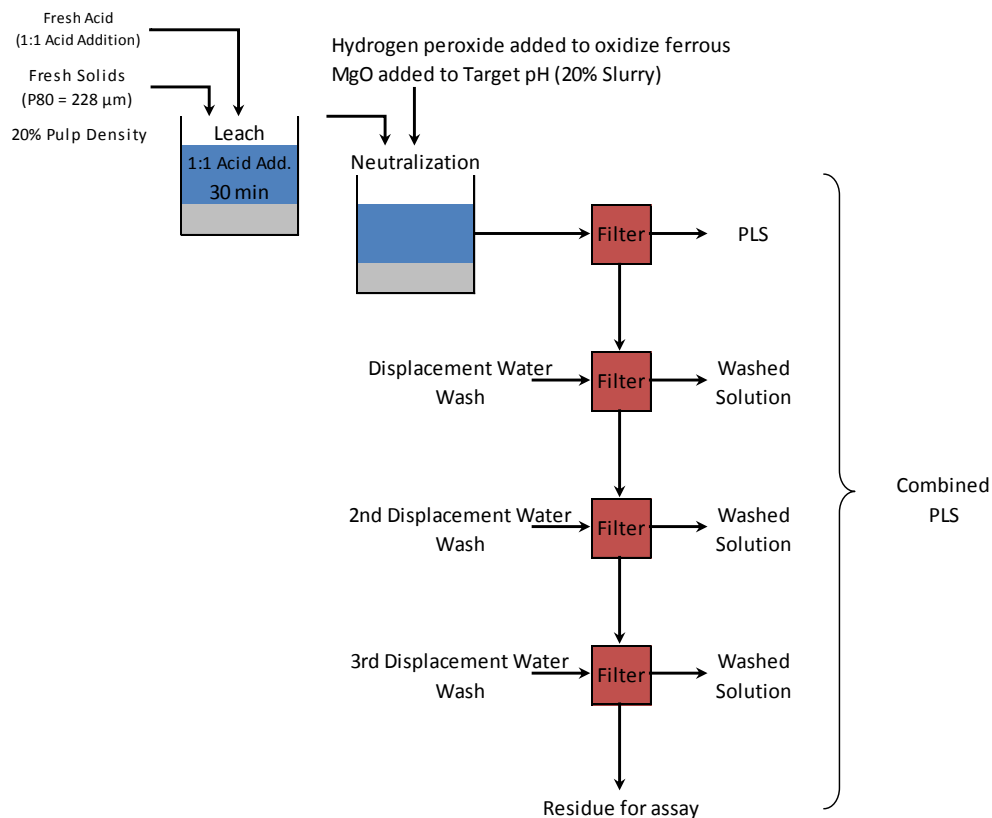

The results of iron hydrolysis tests are summarized in **Table 7**.

Table 7. Summary of Iron Hydrolysis Leach Test

Test Number	pH	Fe in PLS (ppm)	Ni in PLS (ppm)	MgO Required (kg/tonne-ore)	% of Mg added from MgO (compared to head assay)	PLS Filter Time
YO601	2.72	131	208	181.7	46.2%	12+ hours
YO604	3.06	38	192	173.6	44.2%	1 hr 45 mins
YO603	3.51	14	191	187.8	47.8%	50 min
YO602	3.75	5	177	187.3	47.7%	20 min
YO600	3.95	10	168	183.8	46.8%	20 min
YO606	5.52	3	108	179.0	45.6%	42 min
YO607	5.61	3	93	158.4	40.3%	43 min
*YO608	3.78	71	199	161.1	41.0%	3 hr 45 mins

** MgO was added at a slower rate to ensure pH stability*

Please note that at pH ~ 3.5, a small amount of additional MgO caused the pH to rise significantly.

While adding the MgO slurry, the pH would spike and slowly plateau. During filtration, it was noted that the pH continued to increase indicating that the reaction was not complete. Small amounts of excess MgO were observed to raise pH rapidly once a pH of ~3.5 was achieved.

Tests YO600 – YO604 were run on a smaller batch size and were more susceptible to errors so these tests were repeated using a larger feed mass.

Adding MgO to the slurry appeared to be exothermic as the slurry temperature was found to increase to 60°C – 70°C.

For Test YO608, MgO was added very slowly to ensure a stable final pH.

This approach successfully decreased iron values in solution.

Filtration kinetics were also improved by increasing pH, with the most optimal results at pH greater than 4.

An average 174 kg/tonne-ore of MgO was required to reach a pH ≥ 4 . The magnesium content from the MgO addition was approximately equal to 50% of the magnesium in the WHY mid-grade ore.

Approximately 98.5% of the acid was consumed.

2.10 CRYSTALLIZATION (YO606 G – J)

The objective of the crystallization test was to create magnesium sulfate crystals from the pregnant leach solution. It was expected that the formation of such crystals would reject impurities such as iron.

The pregnant solution and the water washes were collected from Test YO606 to form a combined PLS (refer to **Figure 7**). This combined PLS was then split into 200 mL portions and evaporated to various extents by weight. The solution was then cooled overnight allowing crystals to form. The un-crystallized solution was separated and assayed individually. Crystals were diluted to a known factor before being assayed.

A summary of the results can be seen in **Table 8** and **Table 9**.

Table 8. Summary of Crystallization Test

Test Number	YO606J	YO606I	YO606G	*YO606H
% of Soln Evaporated (by weight)	40%	45%	50%	60%
% Mg Distribution in Non-crystallized Soln	68.0%	61.6%	21.9%	0%
% Mg Distrubution in Crystallized Soln	32.0%	38.4%	78.1%	100%

* 100% crystallization for Test YO606H, no remaining solution (water content evaporated)

Table 9. Assay Summary for Crystallization Test

Test Number	YO606G		YO606H**	YO606I		YO606J	
% of Soln Evaporated	50%		60%	45%		40%	
Description	Saturatd Soln	Crystals *	Crystals *	Saturatd Soln	Crystals *	Saturatd Soln	Crystals *
Total Metals							
Calcium (Ca)-Total	330	904	1146	518	1724	300	2050
Cobalt (Co)-Total	3.1	3	4	3.3	4	3.4	3
Iron (Fe)-Total	<3.0	3	5	<3.0	3	<3.0	3
Magnesium (Mg)-Total	67,500	65,762	89,406	75,000	82,013	74,800	69,063
Manganese (Mn)-Total	232	120	193	211	100	183	116
Nickel (Ni)-Total	108	121	161	125	170	128	130
Silicon (Si)-Total	109	62	106	52.4	59	76.6	58
Sodium (Na)-Total	<200	193	347	<200	216	<200	223

* Crystal assays were back calculated from the dissolved crystal assays by dilution factor

** 100% crystallization for Test YO606H, no non-crystallized assay available

The saturated non-crystallized solution contained approximately 75,000 ppm Mg, 150 ppm Ni and negligible amounts of iron. The assay summary indicated that metal impurities remained in the crystals, hence this approach was abandoned.

Since the level of metal impurities present in the PLS solution after iron hydrolysis were relatively low and that crystallization was not effective in rejecting the metal impurities, it was decided that the PLS obtained after leaching and hydrolysis proceed directly to carbonate precipitation.

2.11 CARBONATE PRECIPITATION (YO607A, YO607B, YO608A)

Carbonate precipitation was required to convert all of the Mg ions in the PLS into a MgCO_3 precipitate.

A 100 g/L sodium carbonate solution was added to the combined PLS and wash solutions from the leach after iron hydrolysis. Sodium carbonate was added until no visible magnesium carbonate precipitate formed. The precipitate was filtered, dried and a representative sample was sent for assay. The spent solution after filtration was labeled as “barren solution”.

An average of 1,264 kg Na_2CO_3 per tonne of ore was required to precipitate all of the magnesium into MgCO_3 .

Crystals were observed to form (most likely sodium sulfate) in the barren solution after a few hours for Test YO607.

In Test YO608, three displacement water washes were done on the precipitate to ensure complete washing of the precipitate. Crystals were did not form in the YO608 barren solution. The precipitate was dried in an oven at 200°C to ensure complete dehydration.

Both Test YO607 and Test YO608 underwent three re-pulp washes before drying and calcining. After the re-pulp washes, most of the sodium and sulfur was removed. The purity of the MgO and assay results is presented in the next section.

2.12 CALCINATION (YO607A, YO607B, YO608A)

The MgCO_3 precipitate was calcined at a high temperature until it decomposed and converted to MgO .

A rough temperature profile (Test YO607B) was completed to better understand the optimal decomposition temperature. Decomposition appears to be complete at approximately 550°C . The results are plotted in **Figure 8**.

Figure 8. Weight VS Temperature Profile on Carbonate Sample

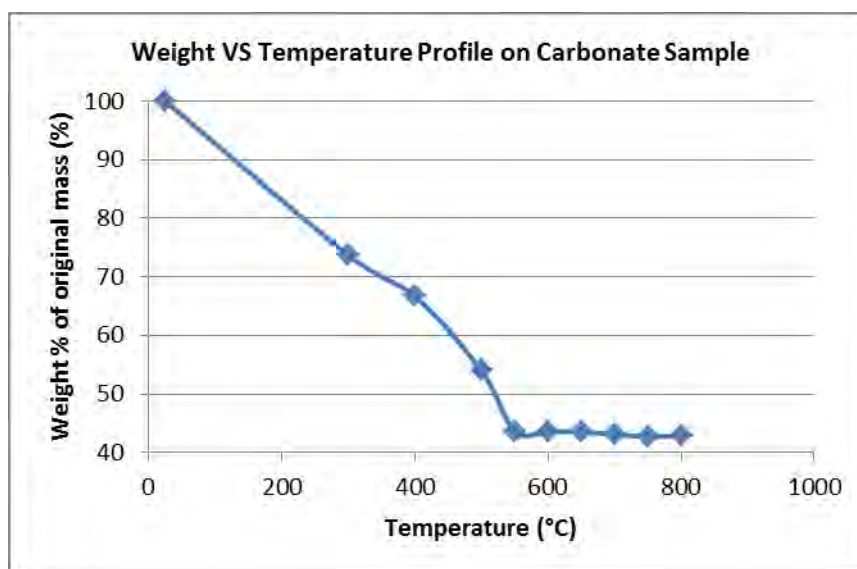

After assaying, it was found that a significant amount of sodium and sulfur was still present in the final calcined product. It was possible that Na_2SO_4 crystals were still contained within the carbonate. A re-pulp wash was conducted on the carbonate samples to ensure complete washing of the precipitate.

The weight of the dried magnesium carbonate precipitate from Tests YO607 and YO608 were weighed and recorded. A representative cut was split out and calcined at 800°C . The loss on ignition (LOI) was also recorded after calcination before sending a representative cut for assay.

The assay results of the final calcined product are summarized below.

Table 10. Calcined Product Before Re-pulp Wash

	Al ₂ O ₃	BaO	CaO	Cr ₂ O ₃	Fe ₂ O ₃	K ₂ O	MgO	MnO	Na ₂ O	P ₂ O ₅	SiO ₂	TiO ₂	SrO	LOI	Total
Sample	%	%	%	%	%	%	%	%	%	%	%	%	%	%	%
YO607A	0.03	<0.01	1.64	0.01	0.15	0.02	88.90	0.19	0.34	<0.01	1.27	0.01	<0.01	8.31	101
YO608A	0.20	<0.01	3.40	0.01	0.23	0.05	82.80	0.19	0.56	<0.01	4.10	0.01	0.01	9.13	101

Table 11. Fully Calcined Product After Re-pulp Wash

	Al ₂ O ₃	BaO	CaO	Cr ₂ O ₃	Fe ₂ O ₃	K ₂ O	MgO	MnO	Na ₂ O	P ₂ O ₅	SiO ₂	TiO ₂	SrO	LOI	Total
Sample	%	%	%	%	%	%	%	%	%	%	%	%	%	%	%
YO607A	<0.01	<0.01	0.952	<0.01	0.024	0.036	99.173	0.207	<0.01	<.01	0.119	<0.01	<0.01	-	101
YO608A	<0.01	<0.01	0.52	<0.01	0.144	0.076	99.247	0	0.085	<0.01	0.084	<0.01	<0.01	-	100

After a re-pulp wash, the grade of the MgO significantly increased to average **99.2%** purity. Removing any remaining sulfate species or crystals appeared to be an important factor for increasing the grade of the MgO.

3.0 SUMMARY

Met-Solve Laboratories Inc. conducted test work to evaluate the potential of using a hydrometallurgical process to extract the magnesium from a mineral sample provided by WHY Resources Inc. and convert it to a marketable product.

The program was designed to evaluate the parameters which affect the amount of magnesium extracted via acid leaching, slurry neutralization and impurity removal. Metallurgical test work focused on optimization of the extraction process and improving the grade and purity of a magnesium oxide end product. A process flow sheet was developed to generate a high purity magnesium oxide product.

Acid addition was determined to be the most important factor, compared to pulp density and particle size, for leaching magnesium from the material. Higher pulp densities, also associated with higher acid concentrations (due to lower water addition) yielded higher extractions.

Based on the scoping acid leach results, a set of preferred leach conditions were established for the remaining test program. These conditions are summarized below.

Table 12. Preferred Leach Conditions Established for the WHY Test Program

Variables	Description	Reasons
Acid Addition	1000 kg/tonne-ore	High acid addition was one of the most important and simpler option for increasing Mg extraction
Pulp Density	20%	To minimize crystallization in residue
Particle Size	P ₈₀ = 228 µm	A coarser feed to reduce grinding costs
Acid Concentration	2.82 M	Determined by pulp density
Leach Duration	30 minutes	Leach kinetics observed to plateau after 30 minutes of leaching
Initial Leach Temperature	Ambient	High acid addition was preferred over increasing temperature due to potential costs

Under the preferred leach conditions, an average of **62.6% magnesium** was leached into solution. The majority of impurities present in the pregnant leach solution consisted of iron, at an average assay of 6,000 ppm Fe, prior to iron hydrolysis. A ferrous titration on the leach solution reported that approximately 23% of the iron in solution was in the form of ferrous ions.

Hydrogen peroxide addition was used to convert the iron present in solution to ferric.

MgO addition was determined to be the preferred method for consuming the excess acid and raising pH to precipitate iron impurities out of the leach solution.

A 20% MgO slurry was added to the slurry to consume excess acid and raise the pH above 4.0. An average 174 kg MgO per tonne of ore was required to achieve a pH greater than 4. At pH values 4 and higher, near complete precipitation of iron and significantly improved filtration characteristics were observed.

A solution of sodium carbonate (100 g/L) was utilized to precipitate the magnesium as MgCO₃.

The precipitate was filtered, washed and then dried. The MgCO₃ precipitate was calcined to form a high purity MgO product.

While **62.6%** of the magnesium was leached, only **39.8%** of the total magnesium reported to the final MgO product at purity of **>99%**. The barren solution contained **18.9%** of the total magnesium, lost to the wash water, and is potentially recoverable via recirculation.

A process flow sheet was developed to represent the test program in **Figure 9**.

Please note that the calcined MgO product and barren solution was not actually recycled for the test work.

ORE HARDNESS

The bond work index for the material was determined to be 21.6 kWh/t (metric).

Figure 9. Process Flow Sheet of Metallurgical Test Work

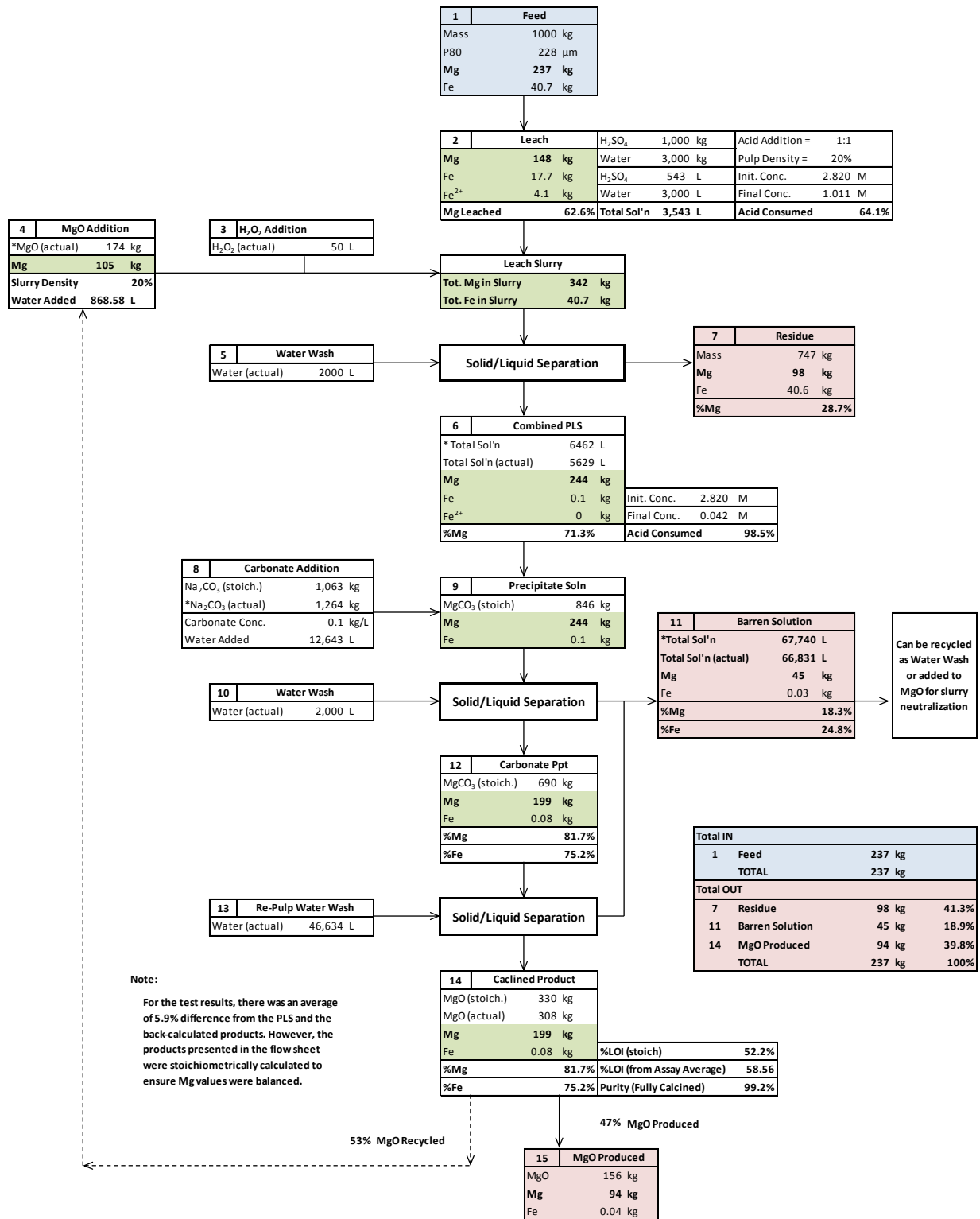

Assay for Fully Caclined Product (Average from Test YO607A and Test YO608A)																	
Al ₂ O ₃	BaO	CaO	Cr ₂ O ₃	Fe ₂ O ₃	K ₂ O	MgO	MnO	Na ₂ O	P ₂ O ₅	SiO ₂	TiO ₂	SrO	S	Ni	Co	Zn	Total
%	%	%	%	%	%	%	%	%	%	%	%	%	ppm	ppm	ppm	ppm	%
<0.01	<0.01	0.73	<0.01	0.08	0.06	99.2	0.22	0.09	<0.01	0.10	<0.01	<0.01	0.05	1522	64.6	56.4	101

* Assuming no loss of solution during test work and no retained solution in residue (100% solid/liquid separation)



Appendix List

Appendix	Content	Test Number
A	Scoping Leach Test Reports	YO102 – YO110, YO202 – YO209, YO302 – YO308
B	Acid Leach Tests Under Intensive Conditions	YO311 – YO314
C	Acid Leach Tests Under Preferred Conditions	YO401 – YO402
D	Slurry Neutralization by De-Slimed Feed Addition	YO501 – YO505
E	Slurry Neutralization by MgO Addition	YO600 – YO604
F	Crystallization Tests	YO606, YO606 G – J
G	Carbonate Precipitation & Calcination	YO607 A – B, YO608 A
H	Process Flow Sheet of Metallurgical Test Work	
I	Acid Consumption Summary	
J	Assay Results	YO101, YO201, YO301, YO607A, YO608A
K	Particle Size Analysis (PSA)	YO101, YO201, YO301, YO400
L	Ferrous Test Work Procedure	
M	Bond Ball Work Index	

Appendix A

Scoping Acid Leach Test Reports

Test Number	P80 (microns)	Acid Addition (kg/tonne-ore)	Pulp Density
YO102	183	500	15%
YO103	183	350	15%
YO104	183	200	15%
YO105	183	500	25%
YO106	183	350	25%
YO107	183	200	25%
YO108	183	500	35%
YO109	183	350	35%
YO110	183	200	35%
YO202	95	500	15%
YO203	95	350	15%
YO204	95	200	15%
YO205	95	500	25%
YO206	95	350	25%
YO207	95	200	25%
YO208	95	500	35%
YO209	95	350	35%
YO302	59	500	15%
YO303	59	350	15%
YO304	59	200	15%
YO305	59	500	25%
YO306	59	350	25%
YO307	59	200	25%
YO308	59	500	35%



SCOPING ACID LEACH TEST REPORT

Client: West High Yield Resources

Date: Nov. 30, 2011

Test: YO102

Project: MS1358

Description: 25 °C Sulfuric Acid Leach Duration: 120 minutes 400 mL Displacement Water Wash	Variables: <div style="text-align: right;"> Acid Addition = 500 kg/tonne P₈₀ = 183 μm Pulp Density = 15 % </div>
---	--

Products	Mass/Volume	Assay (ppm)	Units (mg)	Distribution (%)
		Mg	Mg	Mg
15 min Subsample (ℓ)	23.0 mL	8,030	185	0.2%
30 min Subsample (ℓ)	19.9 mL	8,850	176	0.2%
60 min Subsample (ℓ)	22.8 mL	9,360	213	0.2%
Preg Solution	1860.0 mL	11,900	22,134	23.1%
Water Rinse	500.0 mL	5,820	2,910	3.0%
15 min Subsample (s)	1.9 g	224,913	427	0.4%
30 min Subsample (s)	1.8 g	221,625	399	0.4%
60 min Subsample (s)	1.7 g	215,050	366	0.4%
Residue	341.6 g	201,900	68,969	72.0%
Calculated Feed		237,724	95,779	100.0%
Assayed Feed	402.9 g	236,900	95,447	

Solids Weight Loss = 15.2%

% Mg Leached = 26.7%

Time (minutes)	Mg Leached (%)
15	16.1%
30	17.8%
60	18.8%
120	23.9%

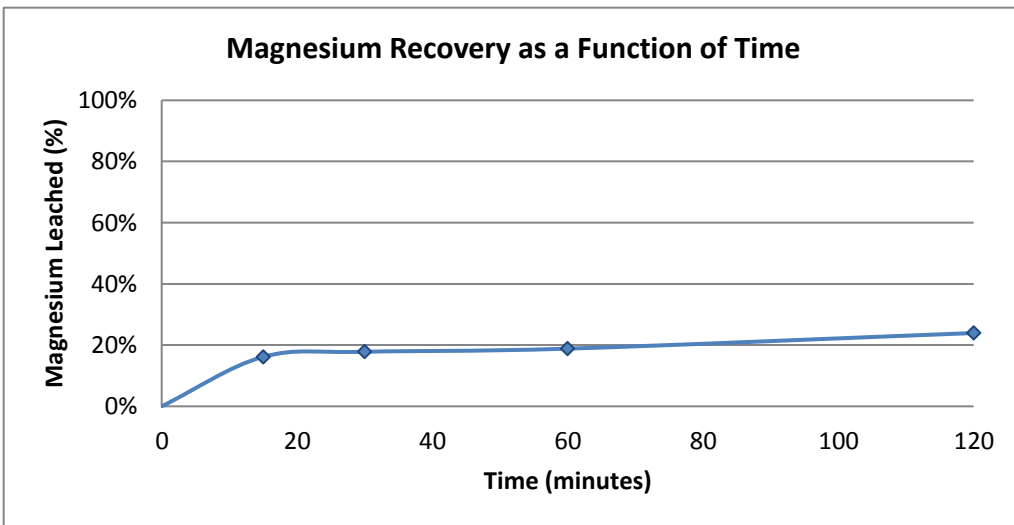



SCOPING ACID LEACH TEST REPORT

Client: West High Yield Resources

Date: Dec. 5, 2011

Test: YO103

Project: MS1358

Description: 25 °C Sulfuric Acid Leach Duration: 120 minutes 400 mL Displacement Water Wash	Variables: <div style="text-align: right;"> Acid Addition = 350 kg/tonne P₈₀ = 183 μm Pulp Density = 15 % </div>
---	--

Products	Mass/Volume	Assay (ppm)	Units (mg)	Distribution (%)
		Mg	Mg	Mg
15 min Subsample (ℓ)	20.6 mL	5,400	111	0.1%
30 min Subsample (ℓ)	11.2 mL	6,470	72	0.1%
60 min Subsample (ℓ)	11.3 mL	6,960	79	0.1%
Preg Solution	2100.0 mL	9,110	19,131	19.7%
Water Rinse	450.0 mL	4,290	1,931	2.0%
15 min Subsample (s)	1.8 g	226,975	409	0.4%
30 min Subsample (s)	1.8 g	225,750	406	0.4%
60 min Subsample (s)	1.8 g	223,300	402	0.4%
Residue	340.5 g	218,400	74,365	76.7%
Calculated Feed		236,818	96,906	100.0%
Assayed Feed	409.2 g	236,900	96,939	

Solids Weight Loss = 16.8%

% Mg Leached = 22.0%

Time (minutes)	Mg Leached (%)
15	11.9%
30	14.3%
60	15.4%
120	20.1%

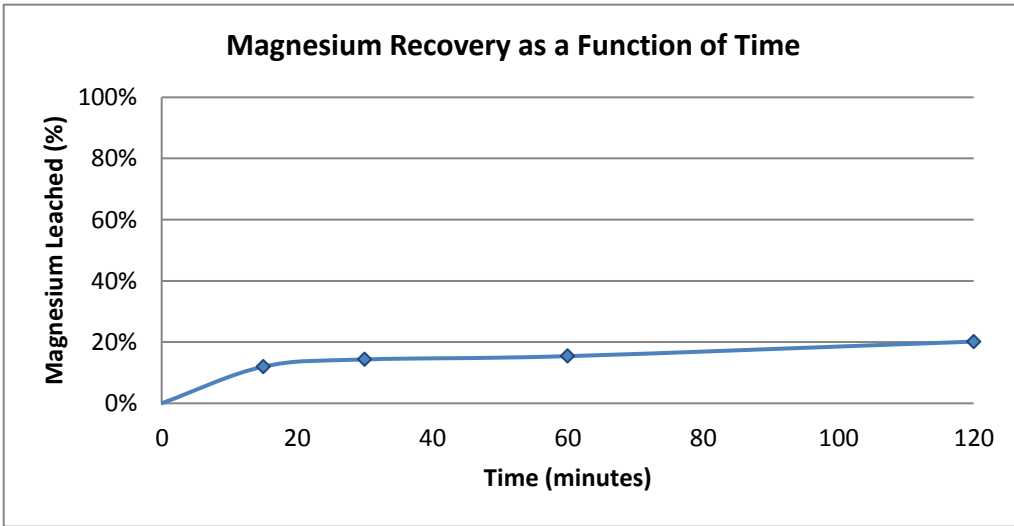



SCOPING ACID LEACH TEST REPORT

Client: West High Yield Resources
Test: YO104

Date: Dec. 13, 2011
Project: MS1358

Description: 25 °C Sulfuric Acid Leach Duration: 120 minutes 400 mL Displacement Water Wash	Variables: <div style="text-align: right;"> Acid Addition = 200 kg/tonne P₈₀ = 183 μm Pulp Density = 15 % </div>
---	--

Products	Mass/Volume	Assay (ppm)	Units (mg)	Distribution (%)
		Mg	Mg	Mg
15 min Subsample (ℓ)	15.0 mL	5,410	81	0.1%
30 min Subsample (ℓ)	16.9 mL	5,910	100	0.1%
60 min Subsample (ℓ)	17.4 mL	6,340	110	0.1%
Preg Solution	2120.0 mL	6,980	14,798	15.6%
Water Rinse	410.0 mL	2,470	1,013	1.1%
15 min Subsample (s)	1.8 g	226,825	408	0.4%
30 min Subsample (s)	1.8 g	225,450	406	0.4%
60 min Subsample (s)	1.8 g	222,700	401	0.4%
Residue	355.9 g	217,200	77,301	81.7%
Calculated Feed		232,249	94,618	100.0%
Assayed Feed	407.4 g	236,900	96,513	

Solids Weight Loss = 12.6%

% Mg Leached = 17.0%

Time (minutes)	Mg Leached (%)
15	12.4%
30	13.5%
60	14.5%
120	16.0%

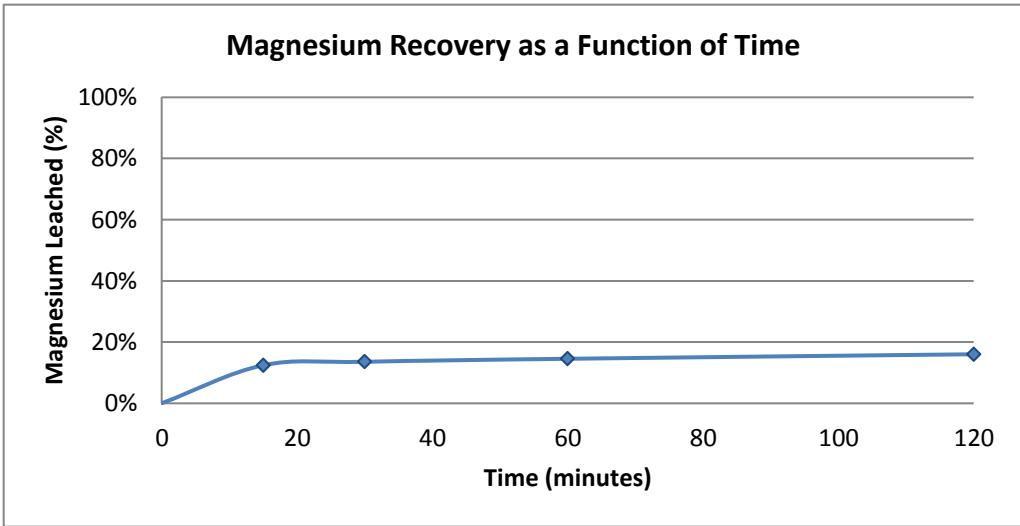



SCOPING ACID LEACH TEST REPORT

Client: West High Yield Resources
Test: YO105

Date: Dec. 19, 2011
Project: MS1358

Description: 25 °C Sulfuric Acid Leach Duration: 120 minutes 400 mL Displacement Water Wash	Variables: Acid Addition = 500 kg/tonne P ₈₀ = 183 μm Pulp Density = 25 %
---	--

Products	Mass/Volume	Assay (ppm)	Units (mg)	Distribution (%)
		Mg	Mg	Mg
15 min Subsample (ℓ)	15.0 mL	26,500	398	0.4%
30 min Subsample (ℓ)	16.0 mL	29,700	475	0.5%
60 min Subsample (ℓ)	14.9 mL	32,200	480	0.5%
Preg Solution	740.0 mL	31,200	23,088	24.1%
Water Rinse	450.0 mL	16,300	7,335	7.7%
15 min Subsample (s)	3.9 g	224,638	876	0.9%
30 min Subsample (s)	3.9 g	221,075	862	0.9%
60 min Subsample (s)	3.9 g	213,950	834	0.9%
Residue	307.2 g	199,700	61,348	64.1%
Calculated Feed		233,804	95,696	100.0%
Assayed Feed	409.3 g	236,900	96,963	

Solids Weight Loss = 24.9%

% Mg Leached = 33.2%

Time (minutes)	Mg Leached (%)
15	21.8%
30	24.4%
60	26.4%
120	25.6%

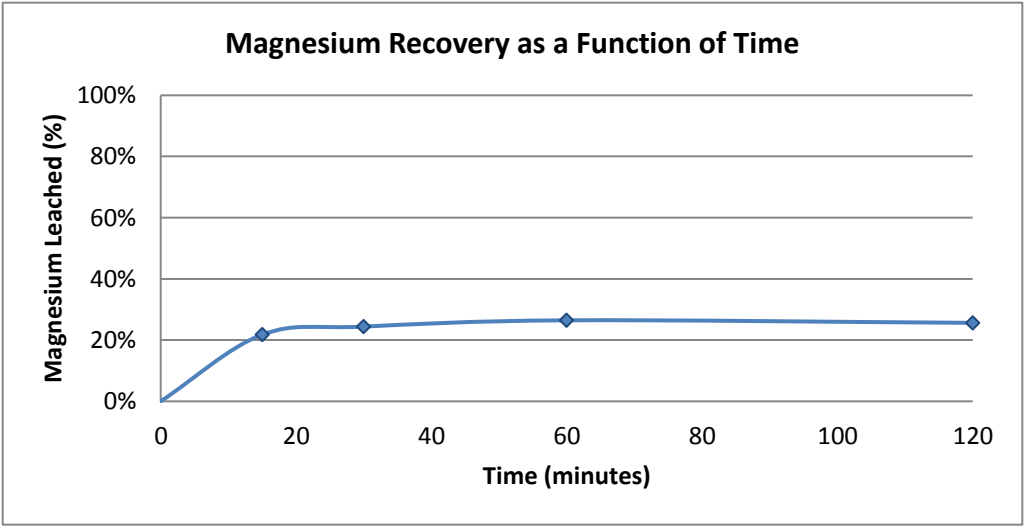



SCOPING ACID LEACH TEST REPORT

Client: West High Yield Resources
Test: YO106

Date: Dec. 28, 2011
Project: MS1358

Description: 25 °C Sulfuric Acid Leach Duration: 120 minutes 400 mL Displacement Water Wash	Variables: <div style="text-align: right;"> Acid Addition = 350 kg/tonne P₈₀ = 183 μm Pulp Density = 25 % </div>
---	--

Products	Mass/Volume	Assay (ppm)	Units (mg)	Distribution (%)
		Mg	Mg	Mg
15 min Subsample (ℓ)	16.0 mL	17,800	285	0.3%
30 min Subsample (ℓ)	15.9 mL	19,900	316	0.3%
60 min Subsample (ℓ)	12.5 mL	21,600	270	0.3%
Preg Solution	840.0 mL	22,700	19,068	20.4%
Water Rinse	480.0 mL	10,800	5,184	5.5%
15 min Subsample (s)	3.8 g	224,713	854	0.9%
30 min Subsample (s)	3.8 g	221,225	841	0.9%
60 min Subsample (s)	3.5 g	214,250	750	0.8%
Residue	329.2 g	200,300	65,939	70.5%
Calculated Feed		233,474	93,506	100.0%
Assayed Feed	400.5 g	236,900	94,878	

Solids Weight Loss = 17.8%

% Mg Leached = 26.9%

Time (minutes)	Mg Leached (%)
15	16.8%
30	18.8%
60	20.4%
120	21.5%

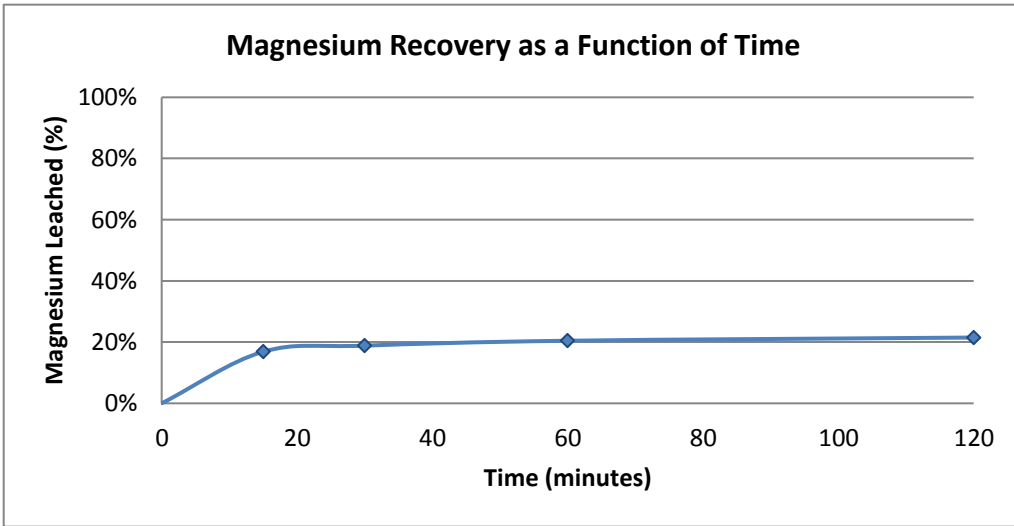



SCOPING ACID LEACH TEST REPORT

Client: West High Yield Resources
Test: YO107

Date: Jan. 6, 2012
Project: MS1358

Description: 25 °C Sulfuric Acid Leach Duration: 120 minutes 400 mL Displacement Water Wash	Variables: Acid Addition = 200 kg/tonne P ₈₀ = 183 μm Pulp Density = 25 %
---	--

Products	Mass/Volume	Assay (ppm)	Units (mg)	Distribution (%)
		Mg	Mg	Mg
15 min Subsample (ℓ)	19.6 mL	13,400	263	0.3%
30 min Subsample (ℓ)	15.0 mL	14,700	221	0.2%
60 min Subsample (ℓ)	18.5 mL	14,800	274	0.3%
Preg Solution	880.0 mL	14,300	12,584	12.9%
Water Rinse	450.0 mL	6,240	2,808	2.9%
15 min Subsample (s)	3.3 g	227,613	751	0.8%
30 min Subsample (s)	3.6 g	227,025	817	0.8%
60 min Subsample (s)	4.1 g	225,850	926	1.0%
Residue	351.5 g	223,500	78,560	80.8%
Calculated Feed		240,424	97,204	100.0%
Assayed Feed	404.3 g	236,900	95,779	

Solids Weight Loss = 13.1%

% Mg Leached = 16.6%

Time (minutes)	Mg Leached (%)
15	12.9%
30	14.1%
60	14.2%
120	13.7%

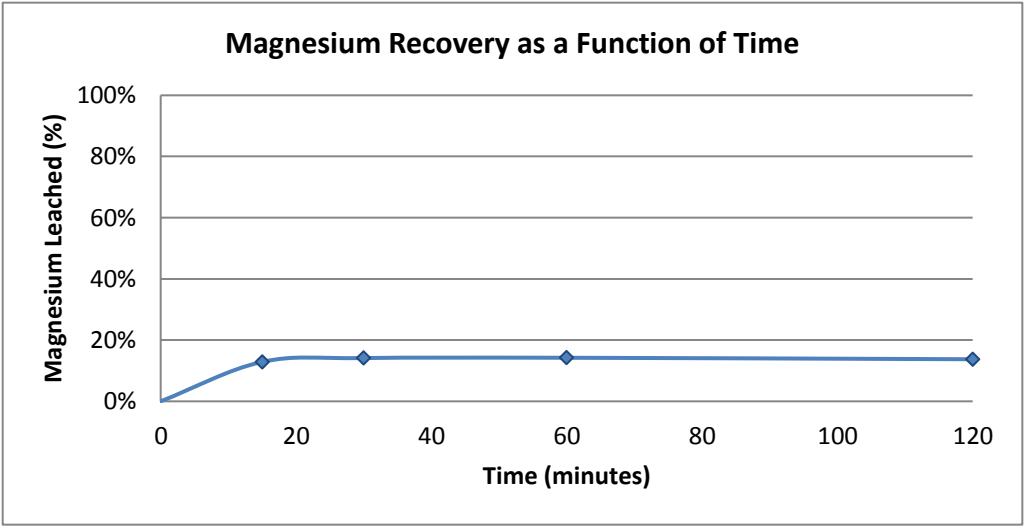



SCOPING ACID LEACH TEST REPORT

Client: West High Yield Resources

Date: Jan. 10, 2012

Test: YO108

Project: MS1358

Description: 25 °C Sulfuric Acid Leach Duration: 120 minutes 400 mL Displacement Water Wash	Variables: <div style="text-align: right;"> Acid Addition = 500 kg/tonne P₈₀ = 183 μm Pulp Density = 35 % </div>
---	--

Products	Mass/Volume	Assay (ppm)	Units (mg)	Distribution (%)
		Mg	Mg	Mg
15 min Subsample (ℓ)	8.5 mL	54,200	461	0.5%
30 min Subsample (ℓ)	7.5 mL	54,400	408	0.5%
60 min Subsample (ℓ)	7.0 mL	54,600	382	0.5%
Preg Solution	210.0 mL	47,900	10,059	12.0%
Water Rinse	470.0 mL	34,000	15,980	19.0%
15 min Subsample (s)	3.6 g	218,950	788	0.9%
30 min Subsample (s)	6.7 g	209,700	1,405	1.7%
60 min Subsample (s)	9.9 g	191,200	1,893	2.3%
Residue	341.9 g	154,200	52,721	62.7%
Calculated Feed		209,770	84,097	100.0%
Assayed Feed	400.9 g	236,900	94,973	

Solids Weight Loss = 14.7%

% Mg Leached = 32.5%

Time (minutes)	Mg Leached (%)
15	15.0%
30	15.1%
60	15.1%
120	13.3%

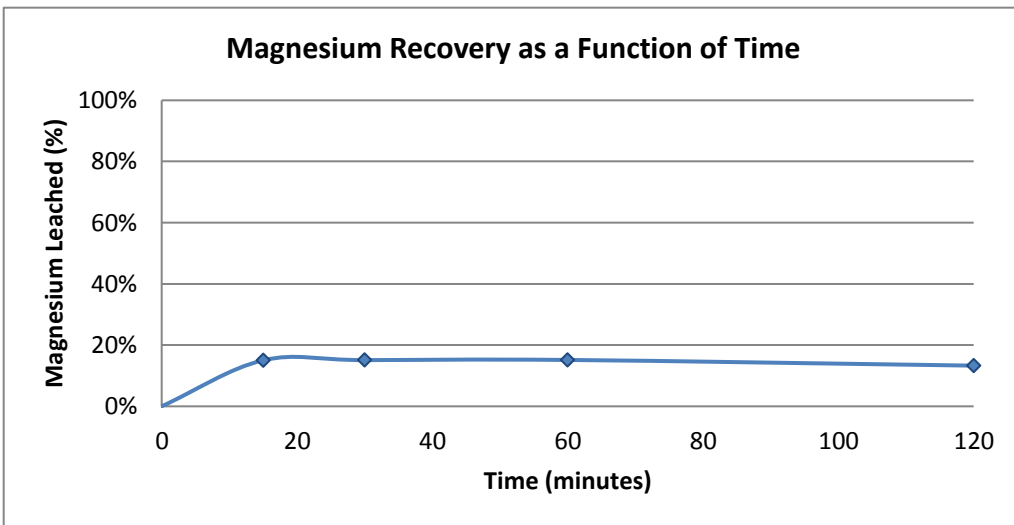



SCOPING ACID LEACH TEST REPORT

Client: West High Yield Resources
Test: YO109

Date: Jan. 12, 2012
Project: MS1358

Description: 25 °C Sulfuric Acid Leach Duration: 120 minutes 400 mL Displacement Water Wash	Variables: Acid Addition = 350 kg/tonne P ₈₀ = 183 μm Pulp Density = 35 %
---	--

Products	Mass/Volume	Assay (ppm)	Units (mg)	Distribution (%)
		Mg	Mg	Mg
15 min Subsample (ℓ)	16.0 mL	44,200	707	0.8%
30 min Subsample (ℓ)	13.0 mL	43,200	562	0.6%
60 min Subsample (ℓ)	15.0 mL	50,000	750	0.8%
Preg Solution	375.0 mL	43,000	16,125	17.8%
Water Rinse	485.0 mL	19,400	9,409	10.4%
15 min Subsample (s)	3.8 g	223,488	849	0.9%
30 min Subsample (s)	4.2 g	218,775	919	1.0%
60 min Subsample (s)	5.5 g	209,350	1,151	1.3%
Residue	314.5 g	190,500	59,912	66.3%
Calculated Feed		225,510	90,385	100.0%
Assayed Feed	400.8 g	236,900	94,950	

Solids Weight Loss = 21.5%

% Mg Leached = 30.5%

Time (minutes)	Mg Leached (%)
15	20.5%
30	20.0%
60	23.2%
120	19.9%

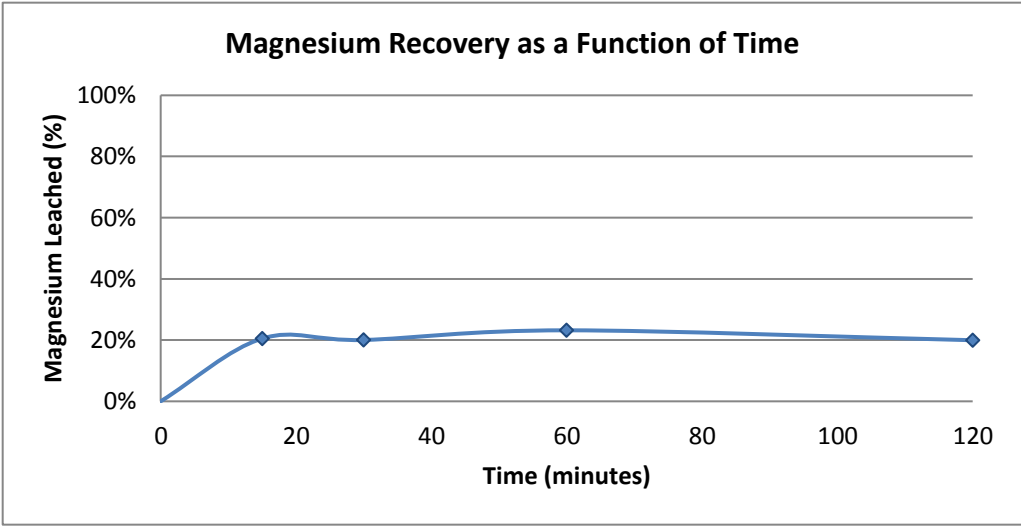



SCOPING ACID LEACH TEST REPORT

Client: West High Yield Resources

Date: Dec. 22, 2011

Test: YO110

Project: MS1358

Description: 25 °C Sulfuric Acid Leach Duration: 120 minutes 400 mL Displacement Water Wash	Variables: <div style="text-align: right;"> Acid Addition = 200 kg/tonne P₈₀ = 183 μm Pulp Density = 35 % </div>
---	--

Products	Mass/Volume	Assay (ppm)	Units (mg)	Distribution (%)
		Mg	Mg	Mg
15 min Subsample (ℓ)	4.9 mL	23,500	115	0.1%
30 min Subsample (ℓ)	3.0 mL	23,500	71	0.1%
60 min Subsample (ℓ)	3.2 mL	25,900	83	0.1%
Preg Solution	450.0 mL	23,500	10,575	11.5%
Water Rinse	460.0 mL	9,990	4,595	5.0%
15 min Subsample (s)	5.0 g	225,675	1,128	1.2%
30 min Subsample (s)	5.0 g	223,150	1,116	1.2%
60 min Subsample (s)	5.0 g	218,100	1,091	1.2%
Residue	352.6 g	208,000	73,341	79.6%
Calculated Feed		228,402	92,114	100.0%
Assayed Feed	403.3 g	236,900	95,542	

Solids Weight Loss = 12.6%

% Mg Leached = 16.8%

Time (minutes)	Mg Leached (%)
15	11.8%
30	11.8%
60	13.0%
120	11.8%

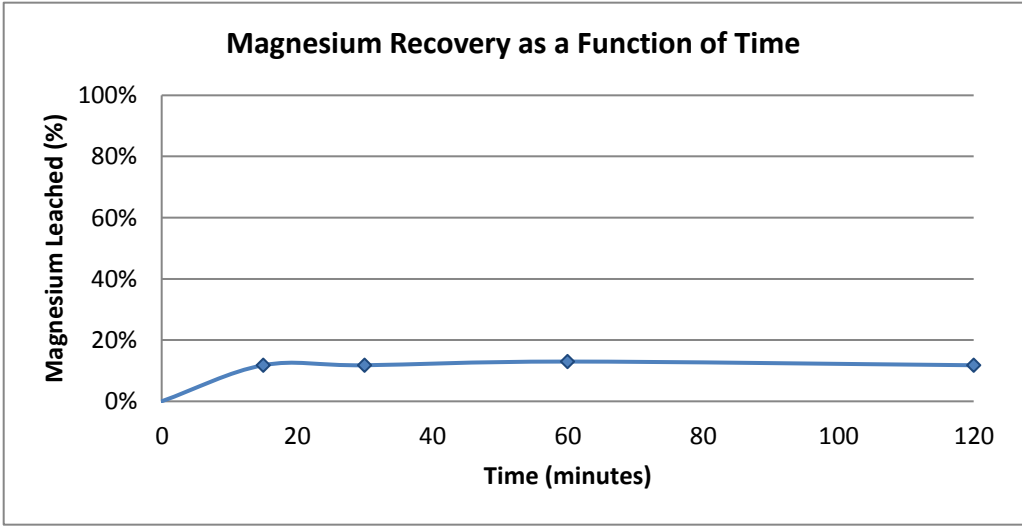



SCOPING ACID LEACH TEST REPORT

Client: West High Yield Resources
Test: YO202

Date: Dec. 6, 2011
Project: MS1358

Description: 25 °C Sulfuric Acid Leach Duration: 120 minutes 400 mL Displacement Water Wash	Variables: Acid Addition = 500 kg/tonne P ₈₀ = 95 μm Pulp Density = 15 %
---	---

Products	Mass/Volume	Assay (ppm)	Units (mg)	Distribution (%)
		Mg	Mg	Mg
15 min Subsample (ℓ)	19.0 mL	7,450	142	0.1%
30 min Subsample (ℓ)	12.0 mL	7,620	91	0.1%
60 min Subsample (ℓ)	11.9 mL	8,880	106	0.1%
Preg Solution	2100.0 mL	11,500	24,150	24.9%
Water Rinse	440.0 mL	5,420	2,385	2.5%
15 min Subsample (s)	1.8 g	226,225	407	0.4%
30 min Subsample (s)	1.8 g	224,250	404	0.4%
60 min Subsample (s)	1.8 g	220,300	397	0.4%
Residue	324.8 g	212,400	68,988	71.1%
Calculated Feed		239,261	97,068	100.0%
Assayed Feed	405.7 g	236,900	96,110	

Solids Weight Loss = 19.9%

% Mg Leached = 27.7%

Time (minutes)	Mg Leached (%)
15	16.4%
30	16.8%
60	19.6%
120	25.4%

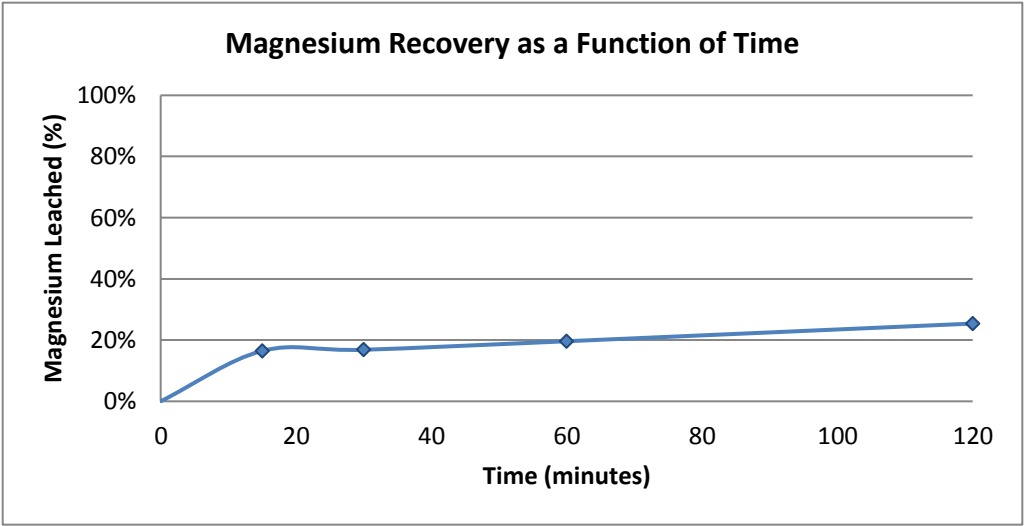



SCOPING ACID LEACH TEST REPORT

Client: West High Yield Resources
Test: YO203

Date: Dec. 8, 2011
Project: MS1358

Description: 25 °C Sulfuric Acid Leach Duration: 120 minutes 400 mL Displacement Water Wash	Variables: Acid Addition = 350 kg/tonne P ₈₀ = 95 μm Pulp Density = 15 %
---	---

Products	Mass/Volume	Assay (ppm)	Units (mg)	Distribution (%)
		Mg	Mg	Mg
15 min Subsample (ℓ)	17.7 mL	6,180	109	0.1%
30 min Subsample (ℓ)	19.0 mL	7,360	140	0.1%
60 min Subsample (ℓ)	17.0 mL	7,940	135	0.1%
Preg Solution	2050.0 mL	9,360	19,188	19.9%
Water Rinse	470.0 mL	4,610	2,167	2.2%
15 min Subsample (s)	1.8 g	227,038	409	0.4%
30 min Subsample (s)	1.8 g	225,875	407	0.4%
60 min Subsample (s)	1.8 g	223,550	402	0.4%
Residue	335.3 g	218,900	73,397	76.2%
Calculated Feed		237,208	96,354	100.0%
Assayed Feed	406.2 g	236,900	96,229	

Solids Weight Loss = 17.5%

% Mg Leached = 22.6%

Time (minutes)	Mg Leached (%)
15	13.5%
30	16.1%
60	17.3%
120	20.4%

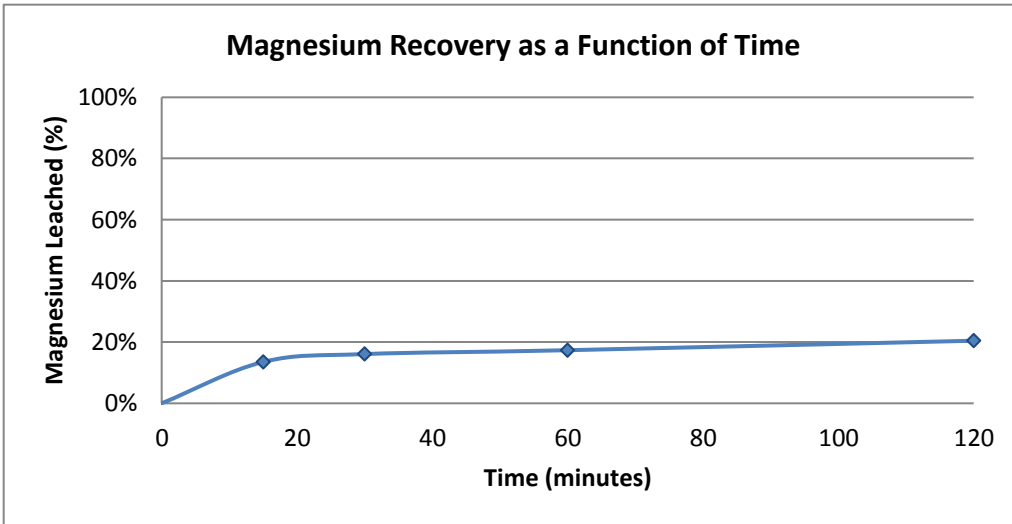



SCOPING ACID LEACH TEST REPORT

Client: West High Yield Resources
Test: YO204

Date: Dec. 14, 2011
Project: MS1358

Description: 25 °C Sulfuric Acid Leach Duration: 120 minutes 400 mL Displacement Water Wash	Variables: Acid Addition = 200 kg/tonne P ₈₀ = 95 μm Pulp Density = 15 %
---	---

Products	Mass/Volume	Assay (ppm)	Units (mg)	Distribution (%)
		Mg	Mg	Mg
15 min Subsample (ℓ)	15.7 mL	5,670	89	0.1%
30 min Subsample (ℓ)	19.2 mL	6,350	122	0.1%
60 min Subsample (ℓ)	17.0 mL	6,560	112	0.1%
Preg Solution	2070.0 mL	6,970	14,428	15.2%
Water Rinse	480.0 mL	3,170	1,522	1.6%
15 min Subsample (s)	1.8 g	227,100	409	0.4%
30 min Subsample (s)	1.8 g	226,000	407	0.4%
60 min Subsample (s)	1.8 g	223,800	403	0.4%
Residue	354.1 g	219,400	77,690	81.6%
Calculated Feed		233,456	95,180	100.0%
Assayed Feed	407.7 g	236,900	96,584	

Solids Weight Loss = 13.1%

% Mg Leached = 17.1%

Time (minutes)	Mg Leached (%)
15	12.6%
30	14.2%
60	14.6%
120	15.5%

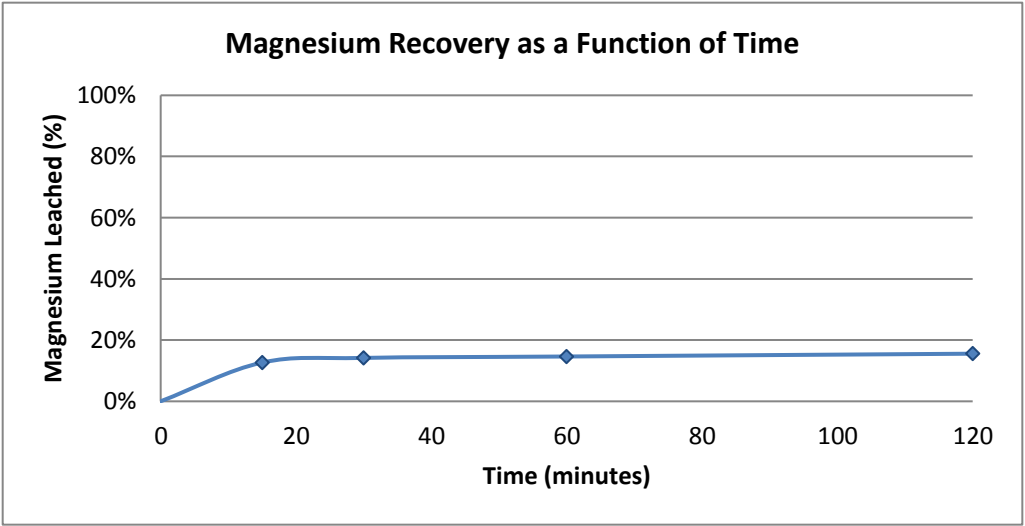



SCOPING ACID LEACH TEST REPORT

Client: West High Yield Resources

Date: Dec. 20, 2011

Test: YO205

Project: MS1358

Description: 25 °C Sulfuric Acid Leach Duration: 120 minutes 400 mL Displacement Water Wash	Variables: <div style="text-align: right;"> Acid Addition = 500 kg/tonne P₈₀ = 95 μm Pulp Density = 25 % </div>
---	---

Products	Mass/Volume	Assay (ppm)	Units (mg)	Distribution (%)
		Mg	Mg	Mg
15 min Subsample (ℓ)	18.0 mL	25,400	457	0.5%
30 min Subsample (ℓ)	17.9 mL	28,800	516	0.6%
60 min Subsample (ℓ)	15.2 mL	33,500	509	0.5%
Preg Solution	810.0 mL	31,700	25,677	27.5%
Water Rinse	470.0 mL	15,800	7,426	7.9%
15 min Subsample (s)	3.9 g	222,763	869	0.9%
30 min Subsample (s)	3.9 g	217,325	848	0.9%
60 min Subsample (s)	3.9 g	206,450	805	0.9%
Residue	305.1 g	184,700	56,352	60.3%
Calculated Feed		231,390	93,458	100.0%
Assayed Feed	403.9 g	236,900	95,684	

Solids Weight Loss = 24.5%

% Mg Leached = 37.0%

Time (minutes)	Mg Leached (%)
15	23.4%
30	26.5%
60	30.9%
120	29.2%

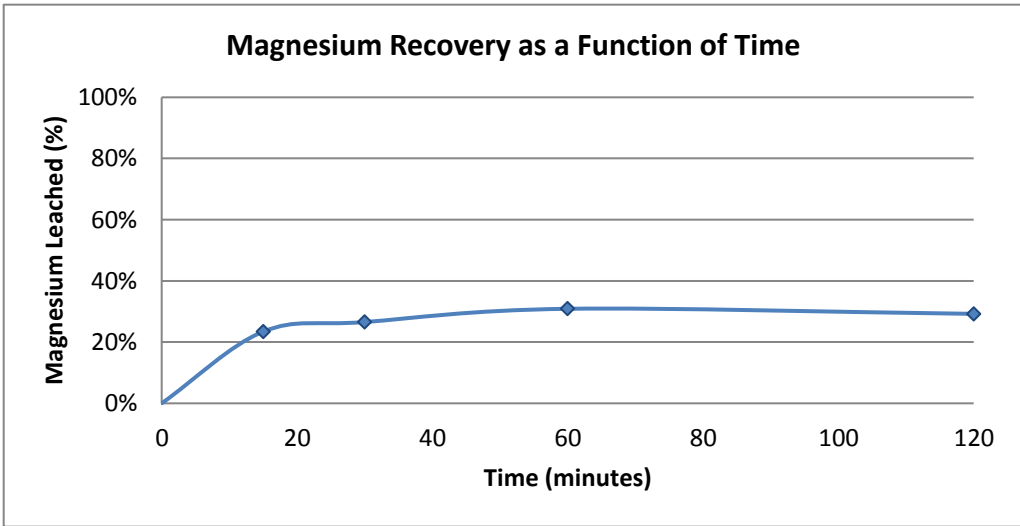



SCOPING ACID LEACH TEST REPORT

Client: West High Yield Resources
Test: YO206

Date: Dec. 29, 2011
Project: MS1358

Description: 25 °C Sulfuric Acid Leach Duration: 120 minutes 400 mL Displacement Water Wash	Variables: Acid Addition = 350 kg/tonne P ₈₀ = 95 μm Pulp Density = 25 %
---	---

Products	Mass/Volume	Assay (ppm)	Units (mg)	Distribution (%)
		Mg	Mg	Mg
15 min Subsample (ℓ)	13.9 mL	18,100	252	0.3%
30 min Subsample (ℓ)	9.7 mL	20,500	199	0.2%
60 min Subsample (ℓ)	10.0 mL	22,600	226	0.2%
Preg Solution	830.0 mL	22,900	19,007	19.5%
Water Rinse	450.0 mL	16,200	7,290	7.5%
15 min Subsample (s)	5.1 g	225,025	1,148	1.2%
30 min Subsample (s)	5.0 g	221,850	1,109	1.1%
60 min Subsample (s)	5.7 g	215,500	1,228	1.3%
Residue	331.2 g	202,800	67,167	68.8%
Calculated Feed		241,111	97,626	100.0%
Assayed Feed	404.9 g	236,900	95,921	

Solids Weight Loss = 18.2%

% Mg Leached = 27.6%

Time (minutes)	Mg Leached (%)
15	16.0%
30	18.1%
60	20.0%
120	20.3%

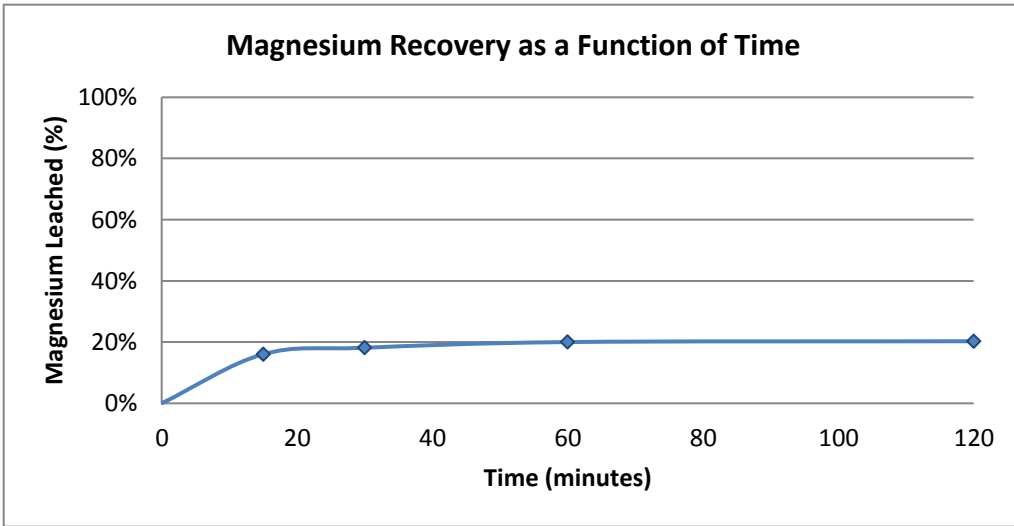



SCOPING ACID LEACH TEST REPORT

Client: West High Yield Resources
Test: YO207

Date: Jan. 5, 2012
Project: MS1358

Description: 25 °C Sulfuric Acid Leach Duration: 120 minutes 400 mL Displacement Water Wash	Variables: Acid Addition = 200 kg/tonne P ₈₀ = 95 μm Pulp Density = 25 %
---	---

Products	Mass/Volume	Assay (ppm)	Units (mg)	Distribution (%)
		Mg	Mg	Mg
15 min Subsample (ℓ)	18.3 mL	13,400	245	0.3%
30 min Subsample (ℓ)	16.5 mL	14,000	231	0.2%
60 min Subsample (ℓ)	12.0 mL	14,700	176	0.2%
Preg Solution	870.0 mL	14,300	12,441	12.9%
Water Rinse	500.0 mL	6,190	3,095	3.2%
15 min Subsample (s)	2.9 g	227,525	660	0.7%
30 min Subsample (s)	3.9 g	226,850	885	0.9%
60 min Subsample (s)	4.3 g	225,500	970	1.0%
Residue	347.6 g	222,800	77,445	80.5%
Calculated Feed		239,293	96,148	100.0%
Assayed Feed	401.8 g	236,900	95,186	

Solids Weight Loss = 13.5%

% Mg Leached = 16.8%

Time (minutes)	Mg Leached (%)
15	12.8%
30	13.3%
60	14.0%
120	13.6%

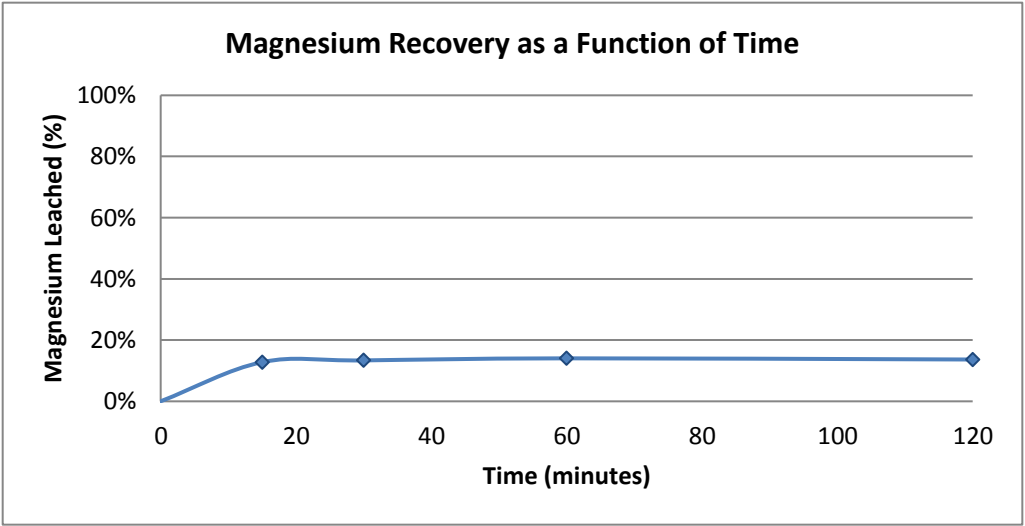



SCOPING ACID LEACH TEST REPORT

Client: West High Yield Resources
Test: YO208

Date: Jan. 10, 2012
Project: MS1358

Description: 25 °C Sulfuric Acid Leach Duration: 120 minutes 400 mL Displacement Water Wash	Variables: Acid Addition = 500 kg/tonne P ₈₀ = 95 μm Pulp Density = 35 %
---	---

Products	Mass/Volume	Assay (ppm)	Units (mg)	Distribution (%)
		Mg	Mg	Mg
15 min Subsample (ℓ)	6.0 mL	55,800	335	0.4%
30 min Subsample (ℓ)	6.9 mL	59,000	407	0.5%
60 min Subsample (ℓ)	6.9 mL	54,600	377	0.4%
Preg Solution	210.0 mL	50,600	10,626	12.0%
Water Rinse	470.0 mL	31,700	14,899	16.8%
15 min Subsample (s)	7.5 g	219,450	1,646	1.9%
30 min Subsample (s)	10.8 g	210,700	2,276	2.6%
60 min Subsample (s)	14.1 g	193,200	2,724	3.1%
Residue	349.8 g	158,200	55,338	62.4%
Calculated Feed		218,888	88,628	100.0%
Assayed Feed	404.9 g	236,900	95,921	

Solids Weight Loss = 13.6%

% Mg Leached = 30.1%

Time (minutes)	Mg Leached (%)
15	14.5%
30	15.3%
60	14.2%
120	13.1%

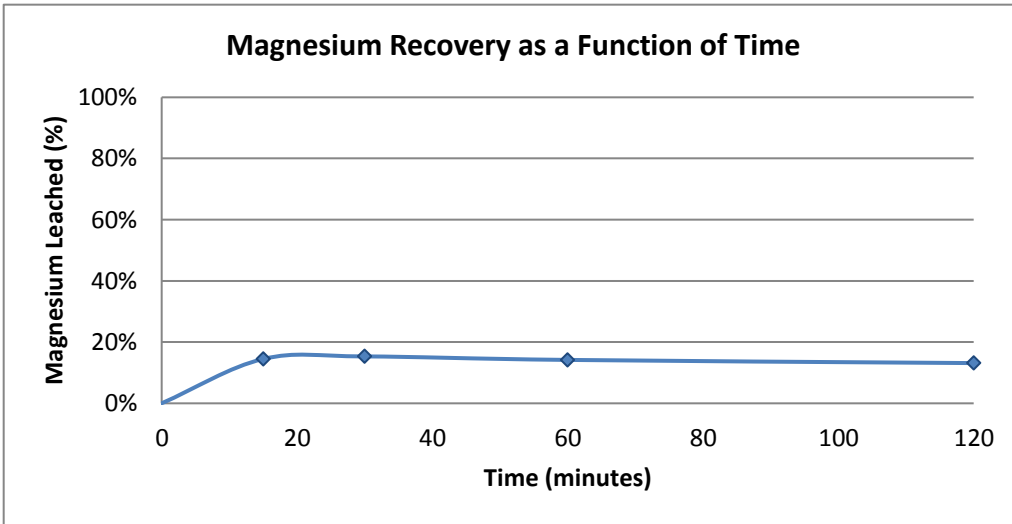



SCOPING ACID LEACH TEST REPORT

Client: West High Yield Resources

Date: Jan. 12, 2012

Test: YO209

Project: MS1358

Description: 25 °C Sulfuric Acid Leach Duration: 120 minutes 400 mL Displacement Water Wash	Variables: <div style="text-align: right;"> Acid Addition = 350 kg/tonne P₈₀ = 95 μm Pulp Density = 35 % </div>
---	---

Products	Mass/Volume	Assay (ppm)	Units (mg)	Distribution (%)
		Mg	Mg	Mg
15 min Subsample (ℓ)	13.5 mL	45,600	616	0.7%
30 min Subsample (ℓ)	12.0 mL	48,500	582	0.7%
60 min Subsample (ℓ)	12.0 mL	49,100	589	0.7%
Preg Solution	350.0 mL	39,900	13,965	16.1%
Water Rinse	450.0 mL	21,500	9,675	11.2%
15 min Subsample (s)	5.0 g	222,838	1,114	1.3%
30 min Subsample (s)	5.7 g	217,475	1,240	1.4%
60 min Subsample (s)	6.0 g	206,750	1,241	1.4%
Residue	311.3 g	185,300	57,684	66.5%
Calculated Feed		216,114	86,705	100.0%
Assayed Feed	401.2 g	236,900	95,044	

Solids Weight Loss = 22.4%

% Mg Leached = 29.3%

Time (minutes)	Mg Leached (%)
15	20.4%
30	21.7%
60	21.9%
120	17.8%

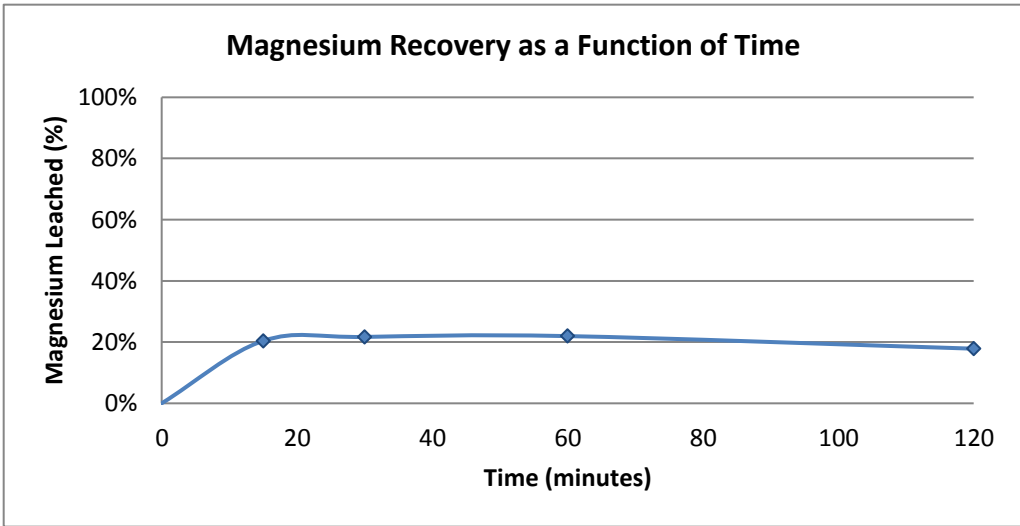



SCOPING ACID LEACH TEST REPORT

Client: West High Yield Resources
Test: YO302

Date: Dec. 7, 2011
Project: MS1358

Description: 25 °C Sulfuric Acid Leach Duration: 120 minutes 400 mL Displacement Water Wash	Variables: Acid Addition = 500 kg/tonne P ₈₀ = 59 μm Pulp Density = 15 %
---	---

Products	Mass/Volume	Assay (ppm)	Units (mg)	Distribution (%)
		Mg	Mg	Mg
15 min Subsample (ℓ)	18.9 mL	7,460	141	0.2%
30 min Subsample (ℓ)	12.0 mL	8,160	98	0.1%
60 min Subsample (ℓ)	13.5 mL	8,250	111	0.1%
Preg Solution	2010.0 mL	10,500	21,105	22.7%
Water Rinse	450.0 mL	6,670	3,002	3.2%
15 min Subsample (s)	1.8 g	226,013	407	0.4%
30 min Subsample (s)	1.8 g	223,825	403	0.4%
60 min Subsample (s)	1.8 g	219,450	395	0.4%
Residue	320.2 g	210,700	67,466	72.4%
Calculated Feed		230,172	93,128	100.0%
Assayed Feed	404.6 g	236,900	95,850	

Solids Weight Loss = 20.9%

% Mg Leached = 26.3%

Time (minutes)	Mg Leached (%)
15	16.5%
30	18.0%
60	18.2%
120	23.2%

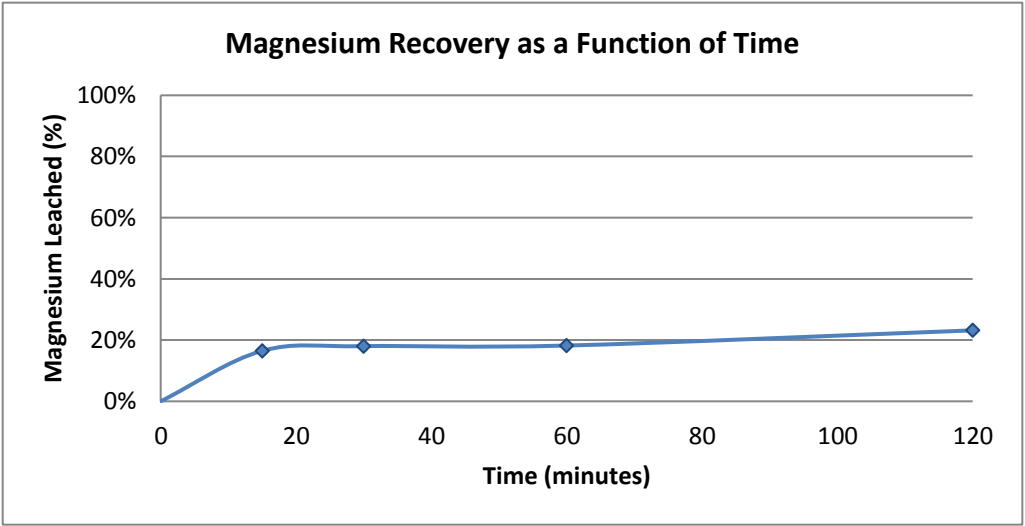



SCOPING ACID LEACH TEST REPORT

Client: West High Yield Resources
Test: YO303

Date: Dec. 9 , 2011
Project: MS1358

Description: 25 °C Sulfuric Acid Leach Duration: 120 minutes 400 mL Displacement Water Wash	Variables: Acid Addition = 350 kg/tonne P ₈₀ = 59 μm Pulp Density = 15 %
---	---

Products	Mass/Volume	Assay (ppm)	Units (mg)	Distribution (%)
		Mg	Mg	Mg
15 min Subsample (ℓ)	16.1 mL	7,030	113	0.1%
30 min Subsample (ℓ)	13.3 mL	7,450	99	0.1%
60 min Subsample (ℓ)	15.9 mL	7,970	127	0.1%
Preg Solution	2075.0 mL	10,200	21,165	21.6%
Water Rinse	420.0 mL	5,100	2,142	2.2%
15 min Subsample (s)	1.8 g	226,925	408	0.4%
30 min Subsample (s)	1.8 g	225,650	406	0.4%
60 min Subsample (s)	1.8 g	223,100	402	0.4%
Residue	336.0 g	218,000	73,248	74.7%
Calculated Feed		242,247	98,110	100.0%
Assayed Feed	405.0 g	236,900	95,945	

Solids Weight Loss = 17.0%

% Mg Leached = 24.1%

Time (minutes)	Mg Leached (%)
15	15.2%
30	16.1%
60	17.2%
120	22.0%

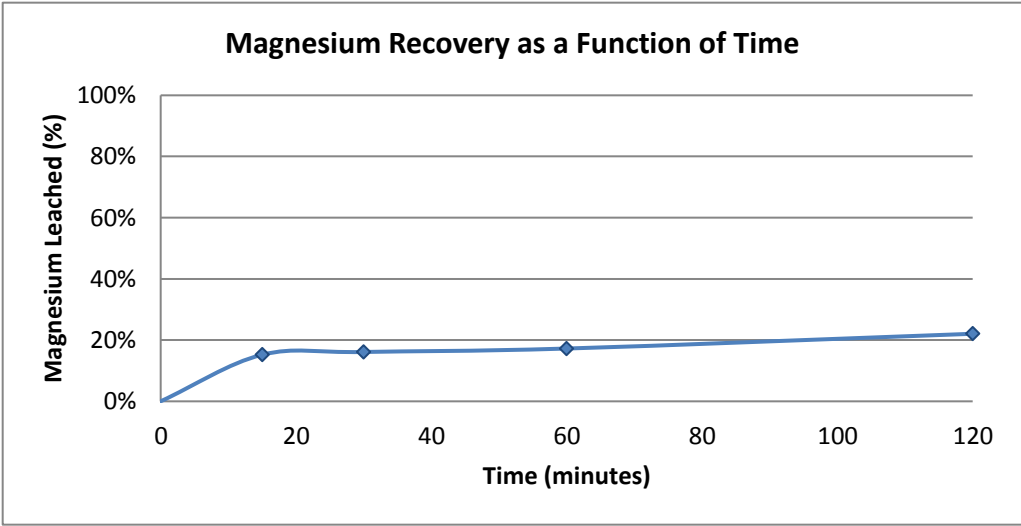



SCOPING ACID LEACH TEST REPORT

Client: West High Yield Resources
Test: YO304

Date: Dec. 15, 2011
Project: MS1358

Description: 25 °C Sulfuric Acid Leach Duration: 120 minutes 400 mL Displacement Water Wash	Variables: Acid Addition = 200 kg/tonne P ₈₀ = 59 μm Pulp Density = 15 %
---	---

Products	Mass/Volume	Assay (ppm)	Units (mg)	Distribution (%)
		Mg	Mg	Mg
15 min Subsample (ℓ)	19.1 mL	6,050	116	0.1%
30 min Subsample (ℓ)	17.0 mL	6,300	107	0.1%
60 min Subsample (ℓ)	21.8 mL	6,790	148	0.2%
Preg Solution	2050.0 mL	6,950	14,248	15.3%
Water Rinse	460.0 mL	3,420	1,573	1.7%
15 min Subsample (s)	1.8 g	226,675	408	0.4%
30 min Subsample (s)	1.8 g	225,150	405	0.4%
60 min Subsample (s)	1.8 g	222,100	400	0.4%
Residue	349.6 g	216,000	75,514	81.3%
Calculated Feed		229,144	92,918	100.0%
Assayed Feed	405.5 g	236,900	96,063	

Solids Weight Loss = 13.8%

% Mg Leached = 17.4%

Time (minutes)	Mg Leached (%)
15	13.7%
30	14.3%
60	15.4%
120	15.8%

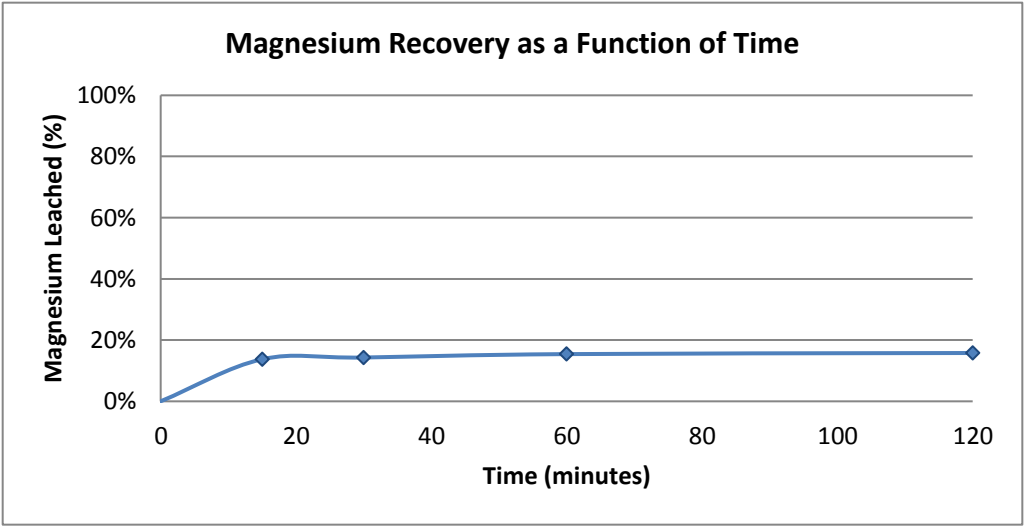



SCOPING ACID LEACH TEST REPORT

Client: West High Yield Resources
Test: YO305

Date: Dec. 21, 2011
Project: MS1358

Description: 25 °C Sulfuric Acid Leach Duration: 120 minutes 400 mL Displacement Water Wash	Variables: Acid Addition = 500 kg/tonne P ₈₀ = 59 µm Pulp Density = 25 %
---	---

Products	Mass/Volume	Assay (ppm)	Units (mg)	Distribution (%)
		Mg	Mg	Mg
15 min Subsample (ℓ)	21.2 mL	26,700	566	0.6%
30 min Subsample (ℓ)	19.0 mL	29,100	553	0.6%
60 min Subsample (ℓ)	15.5 mL	32,300	501	0.5%
Preg Solution	755.0 mL	34,000	25,670	26.8%
Water Rinse	490.0 mL	18,300	8,967	9.4%
15 min Subsample (s)	3.9 g	222,713	869	0.9%
30 min Subsample (s)	3.9 g	217,225	847	0.9%
60 min Subsample (s)	3.9 g	206,250	804	0.8%
Residue	308.7 g	184,300	56,893	59.5%
Calculated Feed		235,351	95,670	100.0%
Assayed Feed	406.5 g	236,900	96,300	

Solids Weight Loss = 24.1%

% Mg Leached = 37.9%

Time (minutes)	Mg Leached (%)
15	22.6%
30	24.7%
60	27.4%
120	28.8%

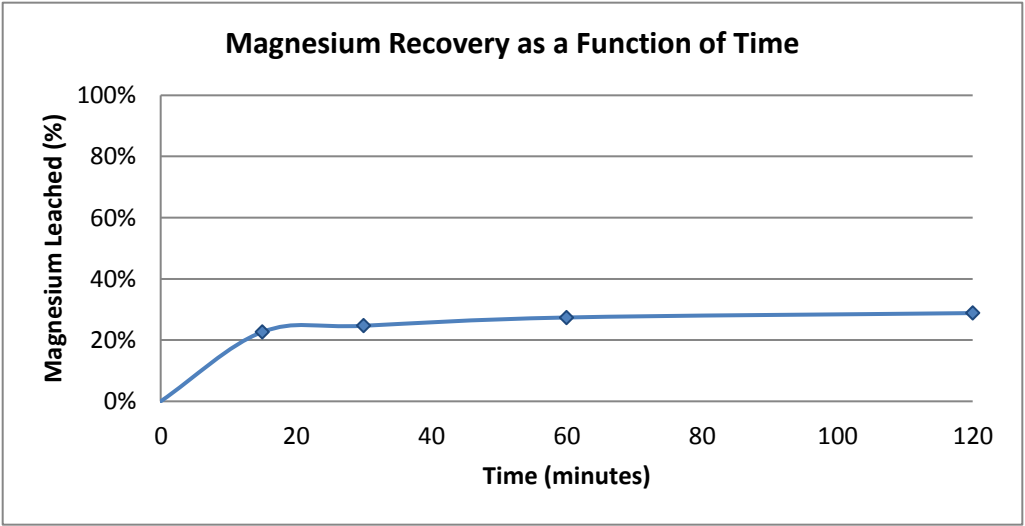



SCOPING ACID LEACH TEST REPORT

Client: West High Yield Resources

Date: Dec. 30, 2011

Test: YO306

Project: MS1358

Description: 25 °C Sulfuric Acid Leach Duration: 120 minutes 400 mL Displacement Water Wash	Variables: <div style="text-align: right;"> Acid Addition = 350 kg/tonne P₈₀ = 59 μm Pulp Density = 25 % </div>
---	---

Products	Mass/Volume	Assay (ppm)	Units (mg)	Distribution (%)
		Mg	Mg	Mg
15 min Subsample (ℓ)	12.5 mL	20,100	251	0.3%
30 min Subsample (ℓ)	11.8 mL	21,400	253	0.3%
60 min Subsample (ℓ)	9.5 mL	23,900	227	0.2%
Preg Solution	780.0 mL	24,700	19,266	20.9%
Water Rinse	415.0 mL	15,400	6,391	6.9%
15 min Subsample (s)	2.7 g	223,600	613	0.7%
30 min Subsample (s)	3.1 g	219,000	672	0.7%
60 min Subsample (s)	2.6 g	209,800	545	0.6%
Residue	335.0 g	191,400	64,119	69.4%
Calculated Feed		227,656	92,337	100.0%
Assayed Feed	405.6 g	236,900	96,087	

Solids Weight Loss = 17.4%

% Mg Leached = 28.6%

Time (minutes)	Mg Leached (%)
15	17.7%
30	18.9%
60	21.1%
120	21.8%

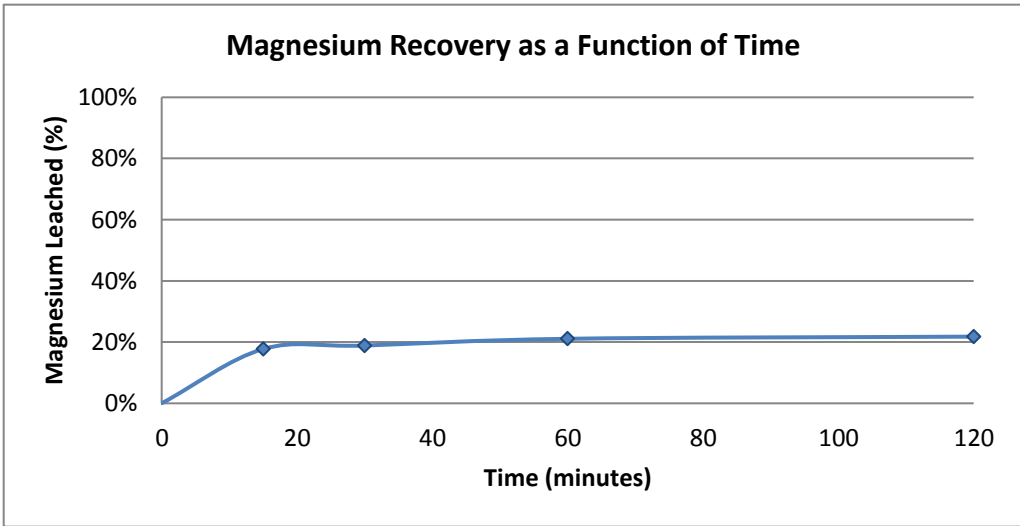



SCOPING ACID LEACH TEST REPORT

Client: West High Yield Resources
Test: YO307

Date: Jan. 9, 2012
Project: MS1358

Description: 25 °C Sulfuric Acid Leach Duration: 120 minutes 400 mL Displacement Water Wash	Variables: Acid Addition = 200 kg/tonne P ₈₀ = 59 µm Pulp Density = 25 %
---	---

Products	Mass/Volume	Assay (ppm)	Units (mg)	Distribution (%)
		Mg	Mg	Mg
15 min Subsample (ℓ)	16.5 mL	14,100	233	0.3%
30 min Subsample (ℓ)	12.8 mL	14,300	183	0.2%
60 min Subsample (ℓ)	12.5 mL	14,900	186	0.2%
Preg Solution	870.0 mL	14,000	12,180	13.3%
Water Rinse	475.0 mL	6,060	2,879	3.1%
15 min Subsample (s)	4.1 g	225,763	926	1.0%
30 min Subsample (s)	4.5 g	223,325	1,005	1.1%
60 min Subsample (s)	4.2 g	218,450	917	1.0%
Residue	350.5 g	208,700	73,149	79.8%
Calculated Feed		226,988	91,658	100.0%
Assayed Feed	403.8 g	236,900	95,660	

Solids Weight Loss = 13.2%

% Mg Leached = 17.1%

Time (minutes)	Mg Leached (%)
15	14.0%
30	14.2%
60	14.8%
120	13.9%

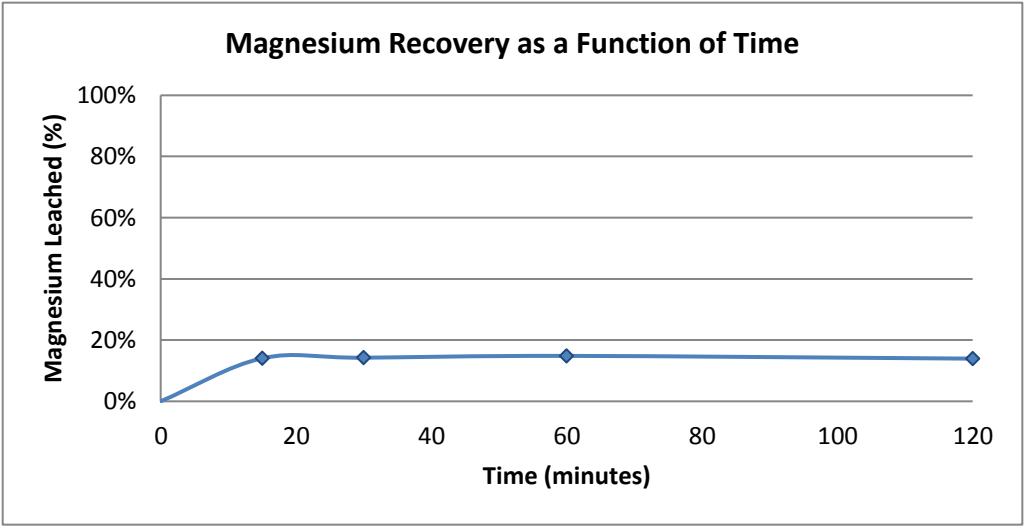



SCOPING ACID LEACH TEST REPORT

Client: West High Yield Resources
Test: YO308

Date: Jan. 11, 2012
Project: MS1358

Description: 25 °C Sulfuric Acid Leach Duration: 120 minutes 400 mL Displacement Water Wash	Variables: <div style="text-align: right;"> Acid Addition = 500 kg/tonne P₈₀ = 59 μm Pulp Density = 35 % </div>
---	---

Products	Mass/Volume	Assay (ppm)	Units (mg)	Distribution (%)
		Mg	Mg	Mg
15 min Subsample (ℓ)	7.0 mL	44,800	314	0.4%
30 min Subsample (ℓ)	8.5 mL	52,600	447	0.5%
60 min Subsample (ℓ)	7.8 mL	56,600	441	0.5%
Preg Solution	230.0 mL	43,800	10,074	11.9%
Water Rinse	525.0 mL	32,400	17,010	20.1%
15 min Subsample (s)	11.8 g	219,600	2,591	3.1%
30 min Subsample (s)	13.3 g	211,000	2,806	3.3%
60 min Subsample (s)	16.8 g	193,800	3,256	3.8%
Residue	300.0 g	159,400	47,820	56.4%
Calculated Feed		210,635	84,760	100.0%
Assayed Feed	402.4 g	236,900	95,329	

Solids Weight Loss = 25.4%

% Mg Leached = 33.4%

Time (minutes)	Mg Leached (%)
15	13.4%
30	15.7%
60	16.9%
120	13.1%

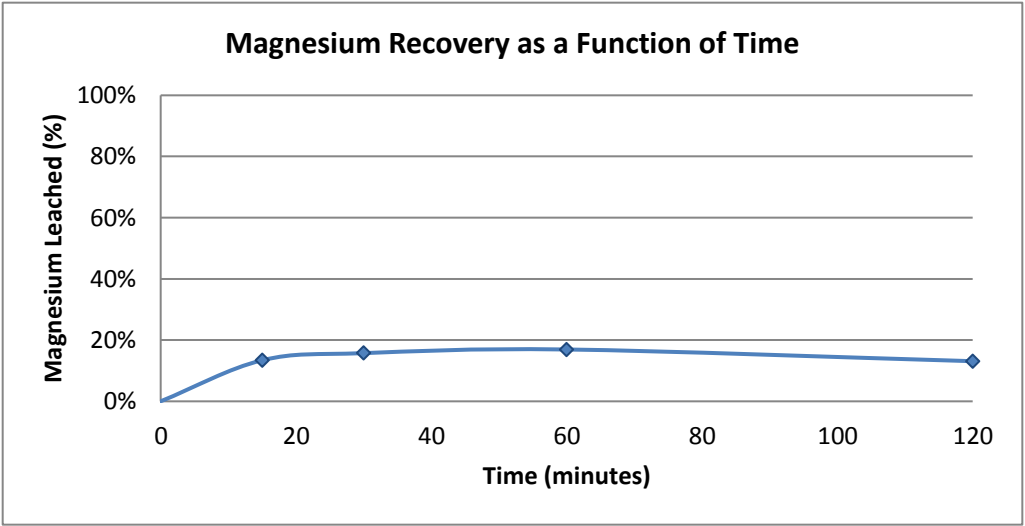

Appendix B

Acid Leach Tests Under Intensive Conditions



ACID LEACH TEST UNDER INTENSIVE CONDITION

Client: West High Yield Resources
Test: YO311

Date: Jan. 17, 2012
Project: MS1358

<p>Description:</p> <p>25 °C Sulfuric Acid Leach Duration: 120 minutes Add fresh acid 500 kg/tonne after 1 hour leach Filter, and releach at 500 kg/tonne for another hour (total = 2 hours) 400 mL Displacement Water Wash</p>	<p>Variables:</p> <p>Acid Addition = 500 + 500 kg/tonne P₈₀ = 59 μm Pulp Density = 25 %</p>
---	--

Products	Mass/Volume	Assay (ppm)	Units (mg)	Distribution (%)
		Mg	Mg	Mg
Preg Solution 1	900.0 mL	29,700	26,730	29.1%
Preg Solution 2	1460.0 mL	5,690	8,307	9.0%
Water Rinse	500.0 mL	3,000	1,500	1.6%
Residue	305.3 g	181,200	55,320	60.2%
Calculated Feed		227,090	91,858	100.0%
Assayed Feed	404.5 g	236,900	95,826	

Solids Weight Loss = 24.5%

% Mg Leached = 39.8%



ACID LEACH TEST UNDER INTENSIVE CONDITION

Client: West High Yield Resources

Date: Jan. 18, 2012

Test: YO312a

Project: MS1358

Description: <p style="text-align: center;">70 °C Sulfuric Acid Leach Duration: 120 minutes 400 mL Displacement Water Wash</p>	Variables: <p style="text-align: right;">Acid Addition = 500 kg/tonne P_{80} = 59 μm Pulp Density = 25 %</p>
---	---

Products	Mass/Volume	Assay (ppm)	Units (mg)	Distribution (%)
		Mg	Mg	Mg
15 min Subsample (ℓ)	16.9 mL	43,000	727	0.8%
30 min Subsample (ℓ)	18.2 mL	42,800	779	0.9%
60 min Subsample (ℓ)	16.0 mL	48,500	776	0.9%
Preg Solution	550.0 mL	50,000	27,500	30.5%
Water Rinse	475.0 mL	24,000	11,400	12.6%
15 min Subsample (s)	2.8 g	220,063	616	0.7%
30 min Subsample (s)	3.4 g	211,925	721	0.8%
60 min Subsample (s)	3.7 g	195,650	724	0.8%
Residue	287.7 g	163,100	46,924	52.0%
Calculated Feed		225,359	90,166	100.0%
Assayed Feed	400.1 g	236,900	94,784	

Solids Weight Loss = 28.1%

% Mg Leached = 45.7%

Time (minutes)	Mg Leached (%)
15	28.7%
30	28.5%
60	32.3%
120	33.3%

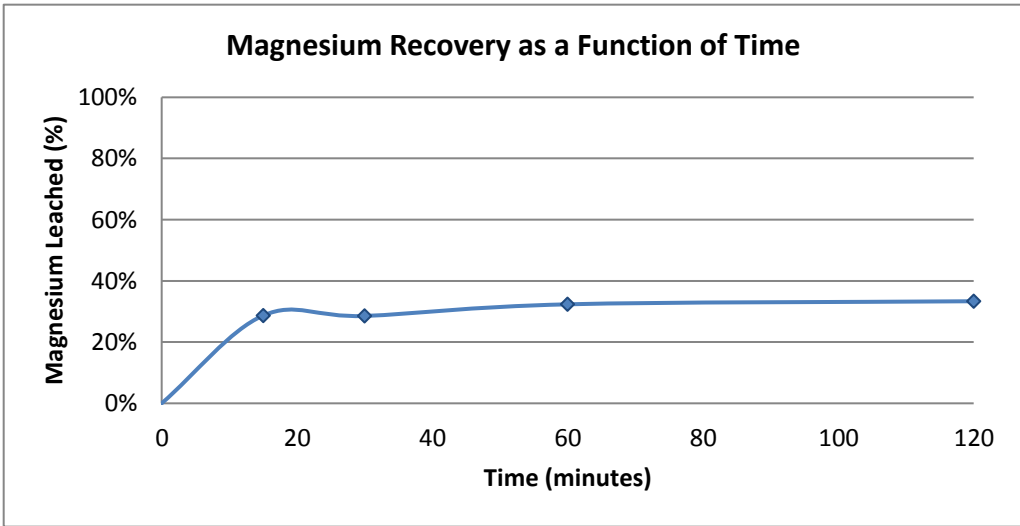



ACID LEACH TEST UNDER INTENSIVE CONDITION

Client: West High Yield Resources

Date: Jan. 18, 2012

Test: YO312b

Project: MS1358

Description: Relach Residue from Test YO312a 70 °C Sulfuric Acid Leach Duration: 120 minutes 400 mL Displacement Water Wash	Variables: Acid Addition = 500 kg/tonne P ₈₀ = 59 µm Pulp Density = 25 %
--	---

Products	Mass/Volume	Assay (ppm)	Units (mg)	Distribution (%)
		Mg	Mg	Mg
Preg Solution 2	350.0 mL	38,800	13,580	41.3%
Water Rinse 2	250.0 mL	23,600	5,900	17.9%
Residue	152.9 g	87,700	13,409	40.8%
Calculated Feed		164,364	32,889	100.0%
Assayed Feed	200.1 g			

Solids Weight Loss = 23.6%

% Mg Leached = 59.2%



ACID LEACH TEST UNDER INTENSIVE CONDITION

Client: West High Yield Resources
Test: YO312 (2-Stage Leach: Combined Test YO312a and YO312b)

Date: Jan. 18, 2012
Project: MS1358

<p>Description:</p> <p style="text-align: center;">Combination of Test YO312a and YO312b</p> <p style="text-align: center;">Releach after 2 hours 70 °C Sulfuric Acid Leach</p> <p>Duration: 120 minutes each leach (total 4 hours) 400 mL Displacement Water Wash after each leach</p>	<p>Variables:</p> <p style="text-align: right;">Acid Addition = 500 + 500 kg/tonne</p> <p style="text-align: right;">P₈₀ = 59 µm</p> <p style="text-align: right;">Pulp Density = 25 %</p>
---	---

Products	Mass/Volume	Assay (ppm)	Units (mg)	Distribution (%)
		Mg	Mg	Mg
15 min Subsample (ℓ)	16.9 mL	43,000	727	0.8%
30 min Subsample (ℓ)	18.2 mL	42,800	779	0.9%
60 min Subsample (ℓ)	16.0 mL	48,500	776	0.9%
Preg Solution 1	550.0 mL	50,000	27,500	30.7%
Water Rinse 1	475.0 mL	24,000	11,400	12.7%
15 min Subsample (s)	2.8 g	220,063	616	0.7%
30 min Subsample (s)	3.4 g	211,925	721	0.8%
60 min Subsample (s)	3.7 g	195,650	724	0.8%
Preg Solution 2	485.1 mL	38,800	18,822	21.0%
Water Rinse 2	346.5 mL	23,600	8,178	9.1%
Residue	219.8 g	87,700	19,280	21.5%
Calculated Feed		223,748	89,522	100.0%
Assayed Feed	400.1 g	236,900	94,784	

Solids Weight Loss = 45.1%

% Mg Leached = 76.2%

Time (minutes)	Mg Leached (%)
15	52.2%
30	51.9%
60	58.8%
120	60.7%
240	47.1%

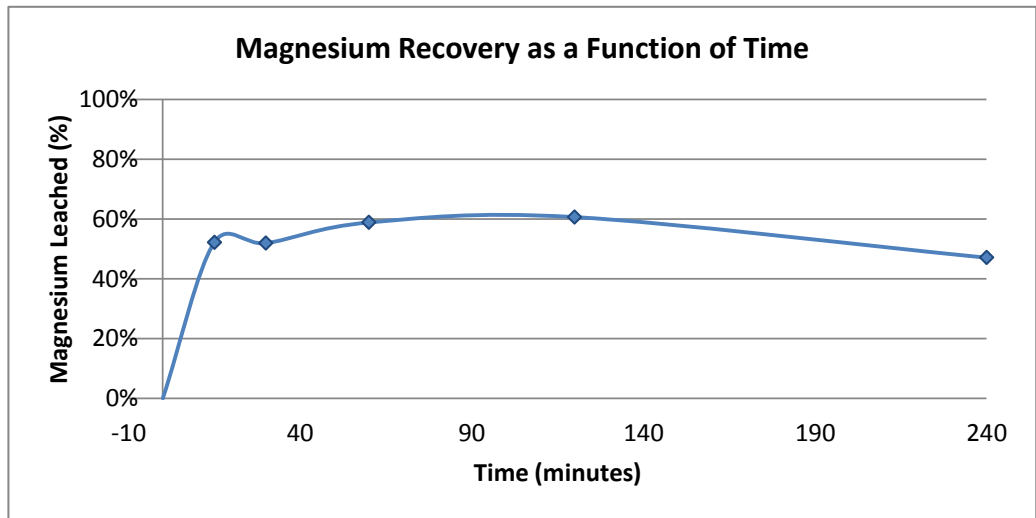



ACID LEACH TEST UNDER INTENSIVE CONDITION

Client: West High Yield Resources
Test: YO313

Date: Jan. 20, 2012
Project: MS1358

Description: 25 °C Sulfuric Acid Leach Duration: 120 minutes 200 mL Displacement Water Wash 1 400 mL Displacement Water Wash 2	Variables: Acid Addition = 1000 kg/tonne P ₈₀ = 59 µm Pulp Density = 25 %
---	--

Products	Mass/Volume	Assay (ppm)	Units (mg)	Distribution (%)
		Mg	Mg	Mg
15 min Subsample (ℓ)	6.0 mL	60,000	360	0.4%
30 min Subsample (ℓ)	6.2 mL	56,600	351	0.4%
60 min Subsample (ℓ)	6.6 mL	54,000	356	0.4%
Preg Solution	230.0 mL	48,900	11,247	12.5%
Water Rinse	295.0 mL	47,900	14,131	15.8%
Water Rinse 2	700.0 mL	56,900	39,830	44.4%
15 min Subsample (s)	11.7 g	88,300	1,033	1.2%
30 min Subsample (s)	14.4 g	84,700	1,220	1.4%
60 min Subsample (s)	14.9 g	80,900	1,205	1.3%
Residue	252.4 g	79,000	19,940	22.2%
Calculated Feed		222,678	89,673	100.0%
Assayed Feed	402.7 g	236,900	95,400	

Solids Weight Loss = 37.3%

% Mg Leached = 73.9%

Time (minutes)	Mg Leached (%)
15	16.6%
30	15.7%
60	15.0%
120	13.6%

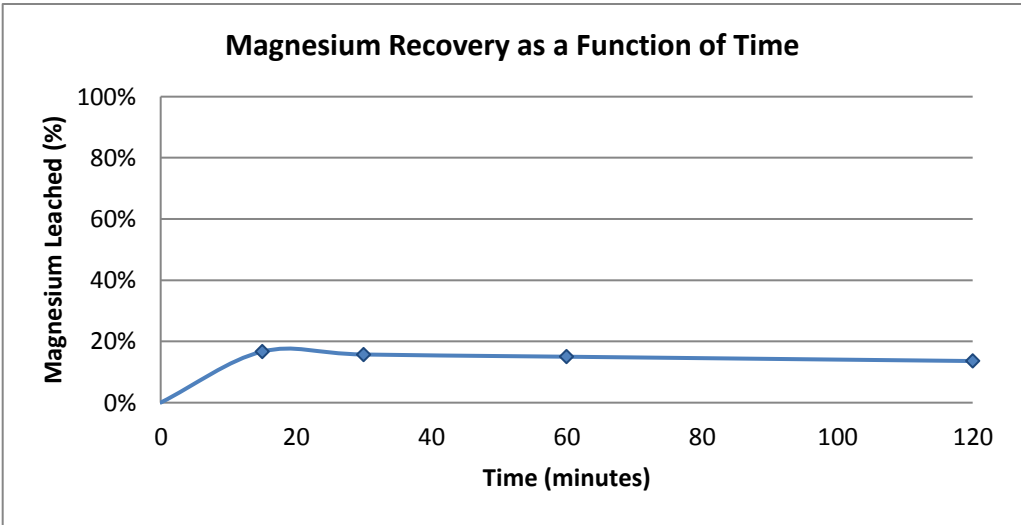



ACID LEACH TEST UNDER INTENSIVE CONDITION

Client: West High Yield Resources
Test: YO314

Date: Feb. 7, 2012
Project: MS1358

Description: <p style="text-align: center;">70 °C Sulfuric Acid Leach (2-Stage) Duration: 30 minutes + 30 minutes 400 mL Displacement Water Wash after each leach 600 mL Re-pulp Wash</p>	Variables: <p style="text-align: center;">Acid Addition = 500 + 500 kg/tonne $P_{80} = 59 \mu\text{m}$ Pulp Density = 35 %</p>
---	---

Products	Mass/Volume	Assay (ppm)	Units (mg)	Distribution (%)
		Mg	Mg	Mg
Preg Solution 1	250 mL	74,200	18,550	18.7%
Water Rinse 1	585 mL	44,300	25,916	26.2%
Preg Solution 2	500 mL	38,200	19,100	19.3%
Water Rinse 2	450 mL	21,700	9,765	9.9%
Re-Pulp Rinse	535 mL	869	465	0.5%
Residue	245.4 g	102,500	25,154	25.4%
Calculated Feed		245,044	98,949	100.0%
Assayed Feed	403.8 g	236,900	95,660	

Solids Weight Loss = 39.2%

% Mg Leached = 74.6%

Time (minutes)	Mg Leached (%)
30	18.7%
60	19.3%

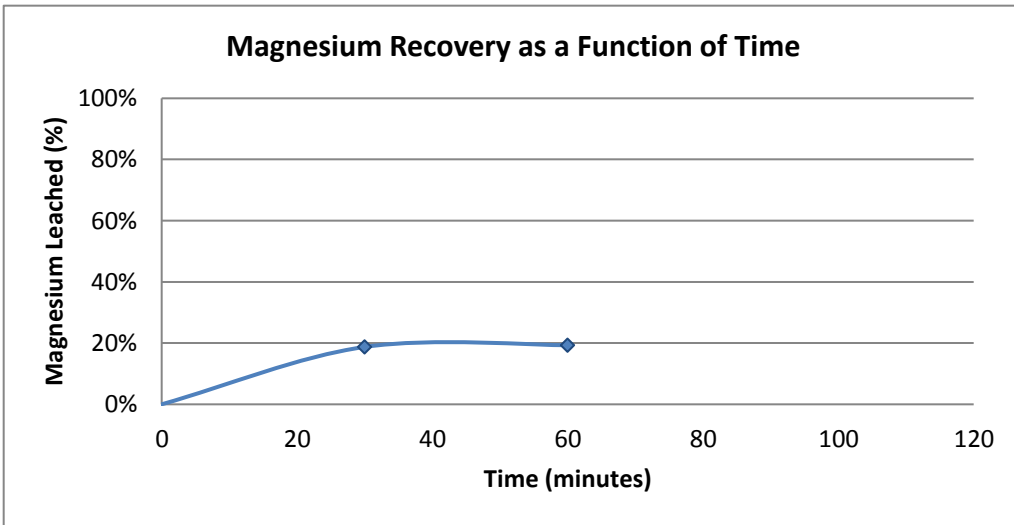

Appendix C

Acid Leach Tests Under Preferred Conditions



ACID LEACH TEST UNDER PREFERRED CONDITIONS

Client: West High Yield Resources
Test: YO401

Date: 03-Apr-12
Project: MS1358

Description: 25 °C Sulfuric Acid Leach Duration: 30 minutes 400 mL Displacement Water Wash	Variables: <div style="text-align: right;"> Acid Addition = 1000 kg/tonne P₈₀ = 228 µm Pulp Density = 20 % *Filtration Time = 6 hours </div> <p style="text-align: right; font-size: small;">*(Used 185 mm diameter Buchner funnel w/ #42 Whatman Filter Paper)</p>
--	---

Products	Mass/Volume	Assay (ppm)		Units (mg)		Distribution (%)		
		Mg	Fe	Mg	Fe	Mg	Fe	Ferrous
Preg Solution	1005.0 mL	46,200	6,890	46,431	6,924	47.9%	34.1%	27.5%
Water Rinse	520.0 mL	29,800	4,440	15,496	2,309	16.0%	11.4%	17.5%
Residue	300.0 g	116,700	37,000	35,010	11,100	36.1%	54.6%	
Calculated Feed		239,351	50,206	96,937	20,333	100.0%	100.0%	
Assayed Feed	405.0 g	236,900	40,700	95,945	16,484			

Solids Weight Loss = 25.9%

% Mg Leached = 63.9%

% Fe in Solution = 45.4%

Acid Consumption Test		
Method	Oxalic	Na ₂ CO ₃
Init. Concentration	2.82 M	2.82 M
Final Concentration	0.93 M	0.8 M
Acid Consumed	66.91 % 669 kg/tonne	71.65 % 717 kg/tonne



ACID LEACH TEST UNDER PREFERRED CONDITIONS

Client: West High Yield Resources
Test: YO402

Date: 04-Apr-12
Project: MS1358

Description: 25 °C Sulfuric Acid Leach Duration: 30 minutes 400 mL Displacement Water Wash (250 mL for larger Buchner funnel) 150 mL for smaller Buchner funnel)	Variables: <div style="text-align: right;"> Acid Addition = 1000 kg/tonne P₈₀ = 228 µm Pulp Density = 20 % *Filtration Time = 3 hours </div> *(Used 2 filters: One 185 mm diameter Buchner funnel and one 150 mm diameter Buchner funnel. Both filtered w/ #42 Whatman Filter Paper)
--	--

Products	Mass/Volume	Assay (ppm)		Units (mg)		Distribution (%)		
		Mg	Fe	Mg	Fe	Mg	Fe	Ferrous
Preg Solution	1040.0 mL	46,100	6,930	47,944	7,207	47.6%	32.9%	23.9%
Water Rinse	540.0 mL	23,200	3,540	12,528	1,912	12.4%	8.7%	14.5%
Residue	290.8 g	138,300	43,900	40,218	12,766	39.9%	58.3%	
Calculated Feed		248,739	54,064	100,690	21,885	100.0%	100.0%	
Assayed Feed	404.8 g	236,900	40,700	95,897	16,475			

Solids Weight Loss = 28.2%

% Mg Leached = 60.1%

% Fe in Solution = 41.7%

Acid Consumption Test		
Method	Oxalic	Na ₂ CO ₃
Init. Concentration	2.82 M	2.82 M
Final Concentration	1.09 M	1.04 M
Acid Consumed	61.43 % 614 kg/tonne	63.15 % 631 kg/tonne

Appendix D

Slurry Neutralization Leach Test by De-Slime Leach Addition

- 1) De-Slime Leach Tests
- 2) Repeat De-Slime Leach Tests
- 3) pH VS Time Charts for De-Slime Leach Tests

Test Number	pH	*De-Slime Feed Added (g)
YO501	3.55	250
YO502	0.24	50.4
YO503	1.09	101.3
YO504	2.36	150.1
YO505	2.71	204.7
YO503 Repeat	0.47	100.2
YO504 Repeat	1.14	146.7
YO505 Repeat	2.30	200.8

**De-Slime Feed added to 200 mL of PLS from Preferred Leach Tests YO401 or YO402*



DE-SLIMED LEACH TEST REPORT

Client: West High Yield Resources

Test: YO501 (Continuous Leach - Final pH = 3.55)

Project: MS1358

Description:	Variables:
De-slimes Feed added to PLS for acid consumption and iron hydrolysis 25 °C Preg. Sol'n Leach w/ De-slimes Feed De-slimes feed was continuously added at various intervals until pH stabilized at 3.55 300 mL Displacement Water Wash	Preg. Solution (Test YO401) Addition = 200 mL De-Slimes Feed Addition = 250 g P ₈₀ = +400 μm Duration = 135 min Final pH = 3.55 *Filtration Time = Overnight Filter *(Used 150 mm diameter Buchner funnel w/ #42 Whatman Filter Paper)

Products	Mass/Volume	Assay (ppm)		Units (mg)		Distribution (%)		
		Mg	Fe	Mg	Fe	Mg	Fe	Ferrous
Preg Solution	70.0 mL	63,500	3,680	4,445	258	6.7%	1.8%	-
Water Rinse	242.0 mL	37,300	1,120	9,027	271	13.7%	1.9%	-
Residue	243.1 g	216,400	56,900	52,607	13,832	79.6%	96.3%	
Calculated Feed		264,314	57,444	66,078	14,361	100.0%	100.0%	
Assayed Feed	250.0 g	236,900	51,300	59,225	12,825			

Solids Weight Loss = 2.8%

% Mg Leached = 20.4%

% Fe in Solution = 3.7%

Acid Consumption Test		
Method	Oxalic	Na ₂ CO ₃
Init. Concentration	0.93 M	- M
Final Concentration	0.06 M	- M
Acid Consumed	93.87 %	- %



DE-SLIMED LEACH TEST REPORT

Client: West High Yield Resources
Test: YO502 (Final pH = 0.24)

Project: MS1358

Description:	Variables:
De-slimer Feed added to PLS for acid consumption and iron hydrolysis 25 °C Preg. Sol'n Leach w/ De-slimer Feed De-slimer feed was only added at the beginning until pH stabilized 200 mL Displacement Water Wash	Preg. Solution (Test YO401) Addition = 200 mL De-Slimer Feed Addition = 50.4 g P ₈₀ = +400 µm Duration = 60 min Final pH = 0.24 *Filtration Time = 1 hour *(Used 150 mm diameter Buchner funnel w/ #42 Whatman Filter Paper)

Products	Mass/Volume	Assay (ppm)		Units (mg)		Distribution (%)		
		Mg	Fe	Mg	Fe	Mg	Fe	Ferrous
Preg Solution	182.0 mL	56,400	8,960	10,265	1,631	49.8%	40.8%	-
Water Rinse	182.0 mL	5,290	740	963	135	4.7%	3.4%	-
Residue	45.2 g	207,800	49,400	9,393	2,233	45.6%	55.8%	
Calculated Feed		409,130	79,331	20,620	3,998	100.0%	100.0%	
Assayed Feed	50.4 g	236,900	51,300	11,940	2,586			

Solids Weight Loss = 10.3%

% Mg Leached = 54.4%

% Fe in Solution = 44.2%

Acid Consumption Test		
Method	Oxalic	Na ₂ CO ₃
Init. Concentration	0.93 M	0.8 M
Final Concentration	0.48 M	0.39 M
Acid Consumed	49.02 %	51.25 %



DE-SLIMED LEACH TEST REPORT

Client: West High Yield Resources
Test: YO503 (Final pH = 1.09)

Project: MS1358

Description:	Variables:
De-slimes Feed added to PLS for acid consumption and iron hydrolysis 25 °C Preg. Sol'n Leach w/ De-slimes Feed De-slimes feed was only added at the beginning until pH stabilized 200 mL Displacement Water Wash	Preg. Solution (Test YO401) Addition = 200 mL De-Slimes Feed Addition = 101.3 g P ₈₀ = +400 μm Duration = 143 min Final pH = 1.09 *Filtration Time = 1 hour *(Used 150 mm diameter Buchner funnel w/ #42 Whatman Filter Paper)

Products	Mass/Volume	Assay (ppm)		Units (mg)		Distribution (%)		
		Mg	Fe	Mg	Fe	Mg	Fe	Ferrous
Preg Solution	179.9 mL	62,000	10,760	11,154	1,936	32.2%	27.1%	41.0%
Water Rinse	227.0 mL	17,700	2,180	4,018	495	11.6%	6.9%	-
Residue	93.5 g	208,200	50,500	19,467	4,722	56.2%	66.0%	
Calculated Feed		341,939	70,605	34,638	7,152	100.0%	100.0%	
Assayed Feed	101.3 g	236,900	51,300	23,998	5,197			

Solids Weight Loss = 7.7%

% Mg Leached = 43.8%

% Fe in Solution = 34.0%

Acid Consumption Test		
Method	Oxalic	*Na ₂ CO ₃
Init. Concentration	0.93 M	0.8 M
Final Concentration	0.08 M	0.015 M
Acid Consumed	91.19 %	98.13 %

*Note that the diluted solution had a pH that was too close to the titration point and might not be as accurate as the oxalic method



DE-SLIMED LEACH TEST REPORT

Client: West High Yield Resources
Test: YO504 (Final pH = 2.36)

Project: MS1358

Description:	Variables:
De-slimes Feed added to PLS for acid consumption and iron hydrolysis 25 °C Preg. Sol'n Leach w/ De-slimes Feed De-slimes feed was only added at the beginning until pH stabilized 200 mL Displacement Water Wash	Preg. Solution (Test YO401) Addition = 200 mL De-Slimes Feed Addition = 150.1 g P ₈₀ = +400 μm Duration = 188 min Final pH = 2.36 *Filtration Time = 1 hour *(Used 150 mm diameter Buchner funnel w/ #42 Whatman Filter Paper)

Products	Mass/Volume	Assay (ppm)		Units (mg)		Distribution (%)		
		Mg	Fe	Mg	Fe	Mg	Fe	Ferrous
Preg Solution	138.0 mL	54,200	7,280	7,480	1,005	18.0%	10.8%	-
Water Rinse	242.0 mL	15,700	2,850	3,799	690	9.1%	7.4%	-
Residue	141.2 g	214,300	53,900	30,259	7,611	72.8%	81.8%	
Calculated Feed		276,737	61,992	41,538	9,305	100.0%	100.0%	
Assayed Feed	150.1 g	236,900	51,300	35,559	7,700			

Solids Weight Loss = 5.9%

% Mg Leached = 27.2%

% Fe in Solution = 18.2%

Acid Consumption Test		
Method	Oxalic	Na ₂ CO ₃
Init. Concentration	0.93 M	- M
Final Concentration	0.05 M	- M
Acid Consumed	94.70 %	- %



DE-SLIMED LEACH TEST REPORT

Client: West High Yield Resources
Test: YO505 (Final pH = 2.71)

Project: MS1358

Description:	Variables:
De-slimer Feed added to PLS for acid consumption and iron hydrolysis 25 °C Preg. Sol'n Leach w/ De-slimer Feed De-slimer feed was only added at the beginning until pH stabilized 200 mL Displacement Water Wash	Preg. Solution (Test YO402) Addition = 200 mL De-Slimer Feed Addition = 204.7 g P ₈₀ = +400 μm Duration = 202 min Final pH = 2.71 *Filtration Time = 1 hour <small>*(Used 150 mm diameter Buchner funnel w/ #42 Whatman Filter Paper)</small>

Products	Mass/Volume	Assay (ppm)		Units (mg)		Distribution (%)		
		Mg	Fe	Mg	Fe	Mg	Fe	Ferrous
Preg Solution	102.0 mL	58,600	7,760	5,977	792	11.1%	6.6%	-
Water Rinse	292.5 mL	20,700	1,990	6,055	582	11.2%	4.9%	-
Residue	192.5 g	217,300	54,700	41,830	10,530	77.7%	88.5%	
Calculated Feed		263,128	58,150	53,862	11,903	100.0%	100.0%	
Assayed Feed	204.7 g	236,900	51,300	48,493	10,501			

Solids Weight Loss = 6.0%

% Mg Leached = 22.3%

% Fe in Solution = 11.5%

Acid Consumption Test		
Method	Oxalic	Na ₂ CO ₃
Init. Concentration	1.09 M	- M
Final Concentration	0.04 M	- M
Acid Consumed	96.17 %	- %



DE-SLIMED LEACH TEST REPORT

Client: West High Yield Resources

Test: YO503 Repeat Test (Final pH = 0.47)

Project: MS1358

Description:	Variables:
25 °C Preg. Sol'n Leach w/ De-slimes Feed Repeat Test for Quality Control De-slimes feed was only added at the beginning until pH stabilized. Test was stopped after 60 min. 200 mL Displacement Water Wash	Preg. Solution (Test YO402) Addition = 200 mL De-Slimes Feed Addition = 100.2 g P ₈₀ = +400 μm Duration = 60 min Final pH = 0.47 *Filtration Time = 1.5 hours
*(Used 150 mm diameter Buchner funnel w/ #42 Whatman Filter Paper)	

Products	Mass/Volume	Assay (ppm)		Units (mg)		Distribution (%)		
		Mg	Fe	Mg	Fe	Mg	Fe	Ferrous
Preg Solution	156.0 mL	58,800	9,880	9,173	1,541	29.0%	23.3%	-
Water Rinse	217.0 mL	13,700	1,920	2,973	417	9.4%	6.3%	-
Residue	90.4 g	215,000	51,400	19,436	4,647	61.5%	70.4%	
Calculated Feed		315,187	65,913	31,582	6,604	100.0%	100.0%	
Assayed Feed	100.2 g	236,900	51,300	23,737	5,140			

Solids Weight Loss = 9.8%

% Mg Leached = 38.5%

% Fe in Solution = 29.6%

Acid Consumption Test		
Method	Oxalic	Na ₂ CO ₃
Init. Concentration	1.09 M	- M
Final Concentration	0.25 M	- M
Acid Consumed	76.95 %	- %



DE-SLIMED LEACH TEST REPORT

Client: West High Yield Resources

Test: YO504 Repeat Test (Final pH = 1.14)

Project: MS1358

Description:	Variables:
25 °C Preg. Sol'n Leach w/ De-slimes Feed Repeat Test for Quality Control De-slimes feed was only added at the beginning until pH stabilized. Test was stopped after 60 min. 200 mL Displacement Water Wash	Preg. Solution (Test YO402) Addition = 200 mL De-Slimes Feed Addition = 146.7 g P ₈₀ = +400 μm Duration = 60 min Final pH = 1.14 *Filtration Time = 1.5 hours *(Used 150 mm diameter Buchner funnel w/ #42 Whatman Filter Paper)

Products	Mass/Volume	Assay (ppm)		Units (mg)		Distribution (%)		
		Mg	Fe	Mg	Fe	Mg	Fe	Ferrous
Preg Solution	130.0 mL	69,000	11,060	8,970	1,438	20.8%	24.1%	46.4%
Water Rinse	266.0 mL	20,200	2,850	5,373	758	12.4%	12.7%	-
Residue	134.8 g	213,900	28,003	28,834	3,775	66.8%	63.2%	
Calculated Feed		294,321	40,700	43,177	5,971	100.0%	100.0%	
Assayed Feed	146.7 g	236,900	51,300	34,753	7,526			

Solids Weight Loss = 8.1%

% Mg Leached = 33.2%

% Fe in Solution = 36.8%

Acid Consumption Test		
Method	Oxalic	Na ₂ CO ₃
Init. Concentration	1.09 M	- M
Final Concentration	0.05 M	- M
Acid Consumed	95.32 %	- %



DE-SLIMED LEACH TEST REPORT

Client: West High Yield Resources

Test: YO505 Repeat Test (Final pH = 2.30)

Project: MS1358

Description:	Variables:
25 °C Preg. Sol'n Leach w/ De-slimes Feed Repeat Test for Quality Control De-slimes feed was only added at the beginning until pH stabilized. Test was stopped after 60 min. 200 mL Displacement Water Wash	Preg. Solution (Test YO402) Addition = 200 mL De-Slimes Feed Addition = 200.8 g P ₈₀ = +400 μm Duration = 60 min Final pH = 2.30 *Filtration Time = 45 minutes

*(Used 185 mm diameter Buchner funnel w/ #42 Whatman Filter Paper)

Products	Mass/Volume	Assay (ppm)		Units (mg)		Distribution (%)		
		Mg	Fe	Mg	Fe	Mg	Fe	Ferrous
Preg Solution	127.0 mL	59,800	8,460	7,595	1,074	14.3%	9.1%	-
Water Rinse	258.0 mL	18,900	2,370	4,876	611	9.2%	5.2%	-
Residue	186.3 g	217,900	54,200	40,595	10,097	76.5%	85.7%	
Calculated Feed		264,271	58,682	53,066	11,783	100.0%	100.0%	
Assayed Feed	200.8 g	236,900	51,300	47,570	10,301			

Solids Weight Loss = 7.2%

% Mg Leached = 23.5%

% Fe in Solution = 14.3%

Acid Consumption Test		
Method	Oxalic	Na ₂ CO ₃
Init. Concentration	1.09 M	- M
Final Concentration	0.04 M	- M
Acid Consumed	96.76 %	- %

pH VS Time for De-Slimed Leach Tests

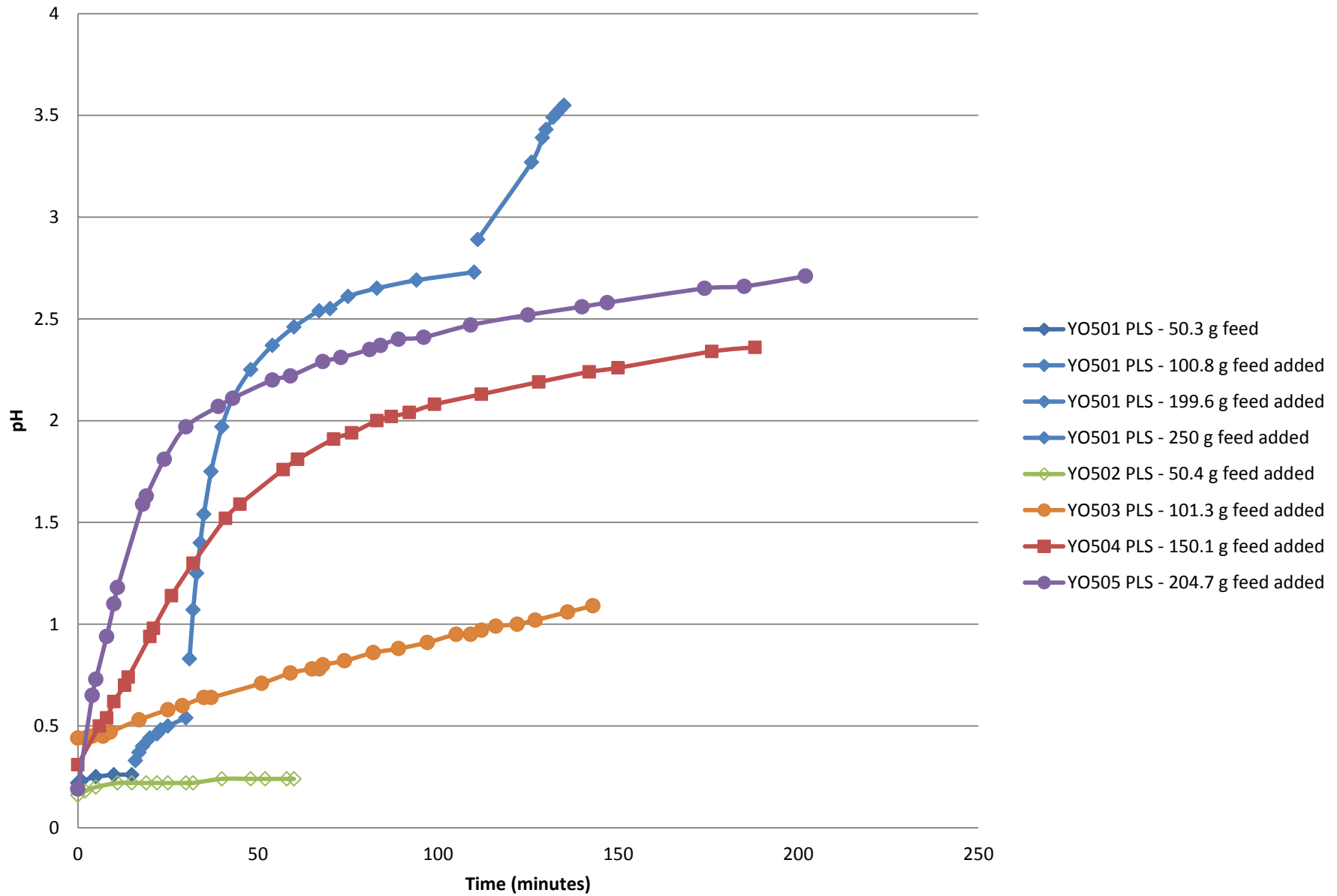

pH VS Time for De-Slimed Leach Tests and Repeat Tests

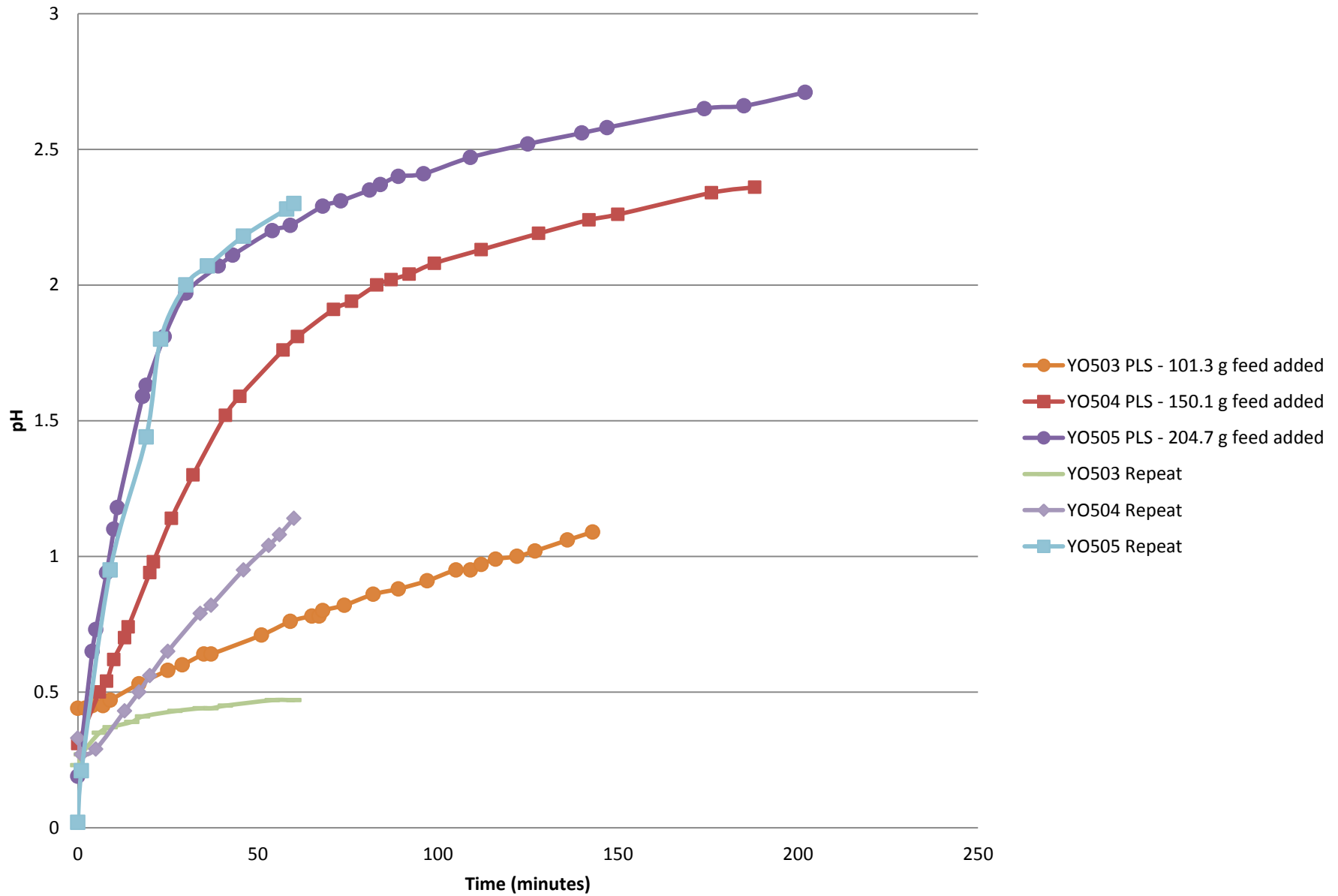

Appendix E

Slurry Neutralization by MgO Addition

1. YO601 (pH = 2.72)
2. YO604 (pH = 3.06)
3. YO603 (pH = 3.51)
4. YO602 (pH = 3.75)
5. YO600 (pH = 3.95)



ACID LEACH TEST WITH MgO ADDITION

Client: West High Yield Resources
Test: YO601 (pH = 2.72)

Date: 09-May-12
Project: MS1358

Description:	Variables:
<p>25 °C Sulfuric Acid Leach Duration: 30 minutes One 400 mL Displacement Water Wash 1 One 275 mL Displacement Water Wash 2</p> <p>10 mL of Hydrogen Peroxide added after leach <i>(5 min to stabilize ORP)</i></p> <p>MgO added after solution is oxidized 20% MgO slurry added = 178.4 g <i>(28 min for pH to stabilize)</i></p>	<p>Acid Addition = 1000 kg/tonne Total Feed = 196.4 g Pulp Density = 20 % P₈₀ = 228 μm Duration of Leach = 30 min</p> <p>Mass of MgO added = 35.7 g Mg from MgO added = 21,516 mg</p> <p>Final pH = 2.72 *Filtration Time for PLS = 12+ hours</p>

*(Used 185 mm diameter Buchner funnel w/ #42 Whatman Filter Paper)

Products	Mass/Volume	Assay (ppm)		Units (mg)		Distribution (%)		
		Mg	Fe	Mg	Fe	Mg	Fe	Ferrous
PLS before H ₂ O ₂	24.5 mL		3,187		78			21.3%
PLS after H ₂ O ₂	22.0 mL		3,194		70			1.8%
Preg Solution	483.5 mL	61,200	131	29,590	63	45.0%	0.7%	0.0%
Water Rinse 1	385.0 mL	32,700	41	12,590	16	19.2%	0.2%	
Water Rinse 2	325.0 mL	8,660	18	2,815	6	4.3%	0.1%	
<i>Combined PLS</i>	<i>1240.0 mL</i>	<i>36,286</i>	<i>68</i>	<i>44,994</i>	<i>85</i>	<i>68.5%</i>	<i>0.9%</i>	
PLS Leached	1240.0 mL	18,934	68	23,478	85	50.5%	0.9%	
Residue	149.2 g	138,900	64,000	20,724	9,549	31.5%	99.1%	
Calculated Feed		334,613	49,050	65,718	9,633	100.0%	100.0%	
Assayed Feed	196.4 g	236,900	40,700	46,527	7,993			
**Adjusted Feed	196.4 g	346,454		68,044				

**Combined PLS = Preg Solution + Water Rinse 1 + Water Rinse 2 + Water Rinse 3*

***Adjusted Feed includes the amount of Mg added from MgO*

Solids Weight Loss = 24.0%

% Mg Leached = 50.5%

(% Mg Leached does not include the Mg from MgO)

% Fe in Solution = 0.9%



ACID LEACH TEST WITH MgO ADDITION

Client: West High Yield Resources
Test: YO601 (pH = 2.72)

Date: 09-May-12
Project: MS1358

Description:	Variables:
25 °C Sulfuric Acid Leach Duration: 30 minutes One 400 mL Displacement Water Wash 1 One 275 mL Displacement Water Wash 2 10 mL of Hydrogen Peroxide added after leach <i>(5 min to stabilize ORP)</i> MgO added after solution is oxidized 20% MgO slurry added = 178.4 g <i>(28 min for pH to stabilize)</i>	Acid Addition = 1000 kg/tonne Total Feed = 196.4 g Pulp Density = 20 % P ₈₀ = 228 µm Duration of Leach = 30 min Mass of MgO added = 35.7 g Final pH = 2.72 *Filtration Time for PLS = 12+ hours

*(Used 185 mm diameter Buchner funnel w/ #42 Whatman Filter Paper)

Products	Mass/Volume	Assay (ppm)		Units (mg)		Distribution (%)	
		Ni	Co	Ni	Co	Ni	Co
PLS before H ₂ O ₂	24.5 mL						
PLS after H ₂ O ₂	22.0 mL						
Preg Solution	483.5 mL	208	7	101	4	22.7%	16.3%
Water Rinse 1	385.0 mL	115	4	44	2	10.0%	7.2%
Water Rinse 2	325.0 mL	32	1	10	0	2.3%	1.7%
Combined PLS	1240.0 mL	192	7	155	6	35.0%	25.2%
Residue	149.2 g	1,930	110	288	16	65.0%	74.8%
Calculated Feed		2,256	112	443	22	100.0%	100.0%
Assayed Feed	196.4 g	1,782	112	350	22		

Solids Weight Loss = 24.0%

% Ni in Solution = 35.0%

% Co in Solution = 25.2%



ACID LEACH TEST WITH MgO ADDITION

Client: West High Yield Resources
Test: YO604 (pH = 3.06)

Date: 14-May-12
Project: MS1358

Description:	Variables:
<p style="text-align: center;">25 °C Sulfuric Acid Leach Duration: 30 minutes</p> <p style="text-align: center;">Two 200 mL Displacement Water Washes</p> <p style="text-align: center;">10 mL of Hydrogen Peroxide added after leach (5 min to stabilize ORP)</p> <p style="text-align: center;">MgO added after solution is oxidized 20% MgO slurry added = 171.9 g (11 min for pH to stabilize)</p>	<p style="text-align: right;">Acid Addition = 1000 kg/tonne Total Feed = 198 g Pulp Density = 20 % P₈₀ = 228 μm Duration of Leach = 30 min</p> <p style="text-align: right;">Mass of MgO added = 34.4 g Mg from MgO added = 20,732 mg</p> <p style="text-align: right;">Final pH = 3.06 *Filtration Time for PLS = 105 min</p>

*(Used 185 mm diameter Buchner funnel w/ #42 Whatman Filter Paper)

Products	Mass/Volume	Assay (ppm)		Units (mg)		Distribution (%)		
		Mg	Fe	Mg	Fe	Mg	Fe	Ferrous
PLS before H ₂ O ₂	21.5 mL	38,800	5,870	834	126			23.9%
PLS after H ₂ O ₂	21.0 mL	39,600	5,880	832	123			0.9%
Preg Solution	511.5 mL	57,500	38	29,411	19	45.7%	0.2%	0.0%
Water Rinse 1	244.0 mL	42,100	14	10,272	3	16.0%	0.0%	
Water Rinse 2	312.4 mL	19,700	13	6,154	4	9.6%	0.0%	
<i>Combined PLS</i>	<i>1067.9 mL</i>	<i>42,923</i>	<i>25</i>	<i>45,838</i>	<i>27</i>	<i>71.2%</i>	<i>0.3%</i>	
PLS Leached	1067.9 mL	23,509	25	25,105	27	53.5%	0.3%	
Residue	155.2 g	119,300	65,000	18,515	10,088	28.8%	99.7%	
Calculated Feed		325,017	51,084	64,353	10,115	100.0%	100.0%	
Assayed Feed	198.0 g	236,900	40,700	46,906	8,059			
**Adjusted Feed	198.0 g	341,609		67,639				

*Combined PLS = Preg Solution + Water Rinse 1 + Water Rinse 2 + Water Rinse 3

**Adjusted Feed includes the amount of Mg added from MgO

Solids Weight Loss = 21.6%

% Mg Leached = 53.5%

(% Mg Leached does not include the Mg from MgO)

% Fe in Solution = 0.3%



ACID LEACH TEST WITH MgO ADDITION

Client: West High Yield Resources
Test: YO604 (pH = 3.06)

Date: 14-May-12
Project: MS1358

Description:	Variables:
<p>25 °C Sulfuric Acid Leach Duration: 30 minutes</p> <p>Two 200 mL Displacement Water Washes</p> <p>10 mL of Hydrogen Peroxide added after leach <i>(5 min to stabilize ORP)</i></p> <p>MgO added after solution is oxidized 20% MgO slurry added = 171.9 g <i>(11 min for pH to stabilize)</i></p>	<p>Acid Addition = 1000 kg/tonne</p> <p>Total Feed = 198 g</p> <p>Pulp Density = 20 %</p> <p>P₈₀ = 228 μm</p> <p>Duration of Leach = 30 min</p> <p>Mass of MgO added = 34.4 g</p> <p>Final pH = 3.06</p> <p>*Filtration Time for PLS = 105 min</p>

*(Used 185 mm diameter Buchner funnel w/ #42 Whatman Filter Paper)

Products	Mass/Volume	Assay (ppm)		Units (mg)		Distribution (%)	
		Ni	Co	Ni	Co	Ni	Co
PLS before H ₂ O ₂	21.5 mL	232	6	5	0		
PLS after H ₂ O ₂	21.0 mL	244	8	5	0		
Preg Solution	511.5 mL	192	6	98	3	22.2%	15.1%
Water Rinse 1	244.0 mL	142	5	35	1	7.8%	5.5%
Water Rinse 2	312.4 mL	69	2	21	1	4.8%	3.4%
Combined PLS	1110.4 mL	171	6	154	5	34.9%	24.1%
Residue	149.2 g	1,930	110	288	16	65.1%	75.9%
Calculated Feed		2,234	109	442	22	100.0%	100.0%
Assayed Feed	198.0 g	1,782	112	353	22		

Solids Weight Loss = 24.6%

% Ni in Solution = 34.9%

% Co in Solution = 24.1%



ACID LEACH TEST WITH MgO ADDITION

Client: West High Yield Resources
Test: YO603 (pH = 3.51)

Date: 11-May-12
Project: MS1358

Description:	Variables:
<p style="text-align: center;">25 °C Sulfuric Acid Leach Duration: 30 minutes</p> <p style="text-align: center;">Two 200 mL Displacement Water Washes</p> <p style="text-align: center;">10 mL of Hydrogen Peroxide added after leach (5 min to stabilize ORP)</p> <p style="text-align: center;">MgO added after solution is oxidized 20% MgO slurry added = 186.1 g (24 min for pH to stabilize)</p>	<p style="text-align: right;">Acid Addition = 1000 kg/tonne</p> <p style="text-align: right;">Total Feed = 198.2 g</p> <p style="text-align: right;">Pulp Density = 20 %</p> <p style="text-align: right;">P₈₀ = 228 µm</p> <p style="text-align: right;">Duration of Leach = 30 min</p> <p style="text-align: right;">Mass of MgO added = 37.2 g</p> <p style="text-align: right;">Mg from MgO added = 22,445 mg</p> <p style="text-align: right;">Final pH = 3.51</p> <p style="text-align: right;">*Filtration Time for PLS = 50 min</p>

*(Used 185 mm diameter Buchner funnel w/ #42 Whatman Filter Paper)

Products	Mass/Volume	Assay (ppm)		Units (mg)		Distribution (%)		
		Mg	Fe	Mg	Fe	Mg	Fe	Ferrous
PLS before H ₂ O ₂	- mL							-
PLS after H ₂ O ₂	24.0 mL		3,195	0	77			0.9%
Preg Solution	626.0 mL	59,600	14	37,310	9	55.4%	0.1%	0.0%
Water Rinse 1	211.0 mL	42,900	12	9,052	2	13.4%	0.0%	
Water Rinse 2	265.0 mL	4,670	3	1,238	1	1.8%	0.0%	
<i>Combined PLS</i>	<i>1126.0 mL</i>	<i>42,273</i>	<i>11</i>	<i>47,599</i>	<i>12</i>	<i>70.7%</i>	<i>0.1%</i>	
PLS Leached	1126.0 mL	22,339	11	25,154	12	53.6%	0.1%	
Residue	152.4 g	129,300	70,200	19,705	10,698	29.3%	99.9%	
Calculated Feed		339,578	54,038	67,304	10,710	100.0%	100.0%	
Assayed Feed	198.2 g	236,900	40,700	46,954	8,067			
**Adjusted Feed	198.2 g	350,145		69,399				

**Combined PLS = Preg Solution + Water Rinse 1 + Water Rinse 2 + Water Rinse 3*

***Adjusted Feed includes the amount of Mg added from MgO*

Solids Weight Loss = 23.1%

% Mg Leached = 53.6%

(% Mg Leached does not include the Mg from MgO)

% Fe in Solution = 0.1%



ACID LEACH TEST WITH MgO ADDITION

Client: West High Yield Resources
Test: YO603 (pH = 3.51)

Date: 11-May-12
Project: MS1358

Description:	Variables:
<p>25 °C Sulfuric Acid Leach Duration: 30 minutes</p> <p>Two 200 mL Displacement Water Washes</p> <p>10 mL of Hydrogen Peroxide added after leach <i>(5 min to stabilize ORP)</i></p> <p>MgO added after solution is oxidized 20% MgO slurry added = 186.1 g <i>(24 min for pH to stabilize)</i></p>	<p>Acid Addition = 1000 kg/tonne Total Feed = 198.2 g Pulp Density = 20 % P₈₀ = 228 μm Duration of Leach = 30 min</p> <p>Mass of MgO added = 37.2 g</p> <p>Final pH = 3.51 *Filtration Time for PLS = 50 min</p>

*(Used 185 mm diameter Buchner funnel w/ #42 Whatman Filter Paper)

Products	Mass/Volume	Assay (ppm)		Units (mg)		Distribution (%)	
		Ni	Co	Ni	Co	Ni	Co
PLS before H ₂ O ₂	- mL						
PLS after H ₂ O ₂	24.0 mL						
Preg Solution	626.0 mL	191	7	120	4	27.1%	19.3%
Water Rinse 1	211.0 mL	139	5	29	1	6.6%	4.7%
Water Rinse 2	265.0 mL	17	1	4	0	1.0%	0.7%
Combined PLS	1126.0 mL	173	6	153	5	34.8%	24.6%
Residue	149.2 g	1,930	110	288	16	65.2%	75.4%
Calculated Feed		2,227	110	441	22	100.0%	100.0%
Assayed Feed	198.2 g	1,782	112	353	22		

Solids Weight Loss = 24.7%

% Ni in Solution = 34.8%

% Co in Solution = 24.6%



ACID LEACH TEST WITH MgO ADDITION

Client: West High Yield Resources
Test: YO602 (pH = 3.75)

Date: 10-May-12
Project: MS1358

Description:	Variables:
<p style="text-align: center;">25 °C Sulfuric Acid Leach Duration: 30 minutes</p> <p style="text-align: center;">Two 200 mL Displacement Water Washes</p> <p style="text-align: center;">10 mL of Hydrogen Peroxide added after leach (6 min to stabilize ORP)</p> <p style="text-align: center;">MgO added after solution is oxidized 20% MgO slurry added = 193.4 g (13 min for pH to stabilize)</p>	<p style="text-align: right;">Acid Addition = 1000 kg/tonne</p> <p style="text-align: right;">Total Feed = 206.5 g</p> <p style="text-align: right;">Pulp Density = 20 %</p> <p style="text-align: right;">P₈₀ = 228 μm</p> <p style="text-align: right;">Duration of Leach = 30 min</p> <p style="text-align: right;">Mass of MgO added = 38.7 g</p> <p style="text-align: right;">Mg from MgO added = 23,326 mg</p> <p style="text-align: right;">Final pH = 3.75</p> <p style="text-align: right;">*Filtration Time for PLS = 20 min</p>

*(Used 185 mm diameter Buchner funnel w/ #42 Whatman Filter Paper)

Products	Mass/Volume	Assay (ppm)		Units (mg)		Distribution (%)		
		Mg	Fe	Mg	Fe	Mg	Fe	Ferrous
PLS before H ₂ O ₂	25.0 mL	32,100	4,960	803	124			21.6%
PLS after H ₂ O ₂	20.0 mL	35,000	5,280	700	106			0.9%
Preg Solution	678.0 mL	56,800	5	38,510	3	55.7%	0.0%	0.0%
Water Rinse 1	242.0 mL	39,300	7	9,511	2	13.8%	0.0%	
Water Rinse 2	212.0 mL	2,850	1	604	0	0.9%	0.0%	
<i>Combined PLS</i>	<i>1132.0 mL</i>	<i>42,955</i>	<i>5</i>	<i>48,625</i>	<i>5</i>	<i>70.3%</i>	<i>0.0%</i>	
PLS Leached	1132.0 mL	22,350	5	25,300	5	51.7%	0.0%	
Residue	159.2 g	129,000	69,200	20,537	11,017	29.7%	100.0%	
Calculated Feed		334,925	53,374	69,162	11,022	100.0%	100.0%	
Assayed Feed	206.5 g	236,900	40,700	48,920	8,405			
**Adjusted Feed	206.5 g	349,857		72,245				

**Combined PLS = Preg Solution + Water Rinse 1 + Water Rinse 2 + Water Rinse 3*

***Adjusted Feed includes the amount of Mg added from MgO*

Solids Weight Loss = 22.9%

% Mg Leached = 51.7%

(% Mg Leached does not include the Mg from MgO)

% Fe in Solution = 0.0%



ACID LEACH TEST WITH MgO ADDITION

Client: West High Yield Resources
Test: YO602 (pH = 3.75)

Date: 10-May-12
Project: MS1358

Description:	Variables:
<p>25 °C Sulfuric Acid Leach Duration: 30 minutes</p> <p>Two 200 mL Displacement Water Washes</p> <p>10 mL of Hydrogen Peroxide added after leach <i>(6 min to stabilize ORP)</i></p> <p>MgO added after solution is oxidized 20% MgO slurry added = 193.4 g <i>(13 min for pH to stabilize)</i></p>	<p>Acid Addition = 1000 kg/tonne</p> <p>Total Feed = 206.5 g</p> <p>Pulp Density = 20 %</p> <p>P₈₀ = 228 µm</p> <p>Duration of Leach = 30 min</p> <p>Mass of MgO added = 38.7 g</p> <p>Final pH = 3.75</p> <p>*Filtration Time for PLS = 20 min</p>

*(Used 185 mm diameter Buchner funnel w/ #42 Whatman Filter Paper)

Products	Mass/Volume	Assay (ppm)		Units (mg)		Distribution (%)	
		Ni	Co	Ni	Co	Ni	Co
PLS before H ₂ O ₂	25.0 mL	201	5	5	0		
PLS after H ₂ O ₂	20.0 mL	224	7	4	0		
Preg Solution	678.0 mL	177	6	120	4	27.2%	18.1%
Water Rinse 1	242.0 mL	126	4	30	1	6.9%	4.6%
Water Rinse 2	212.0 mL	13	0	3	0	0.6%	0.4%
Combined PLS	1177.0 mL	180	6	153	5	34.7%	23.1%
Residue	149.2 g	1,930	110	288	16	65.3%	76.9%
Calculated Feed		2,137	103	441	21	100.0%	100.0%
Assayed Feed	206.5 g	1,782	112	368	23		

Solids Weight Loss = 27.7%

% Ni in Solution = 34.7%

% Co in Solution = 23.1%



ACID LEACH TEST WITH MgO ADDITION

Client: West High Yield Resources
Test: YO600 (pH = 3.95)

Date: 08-May-12
Project: MS1358

Description:	Variables:
<p>25 °C Sulfuric Acid Leach Duration: 30 minutes Two 200 mL Displacement Water Washes</p> <p>10 mL of Hydrogen Peroxide added after leach <i>(8 min to stabilize ORP)</i></p> <p>MgO added after solution is oxidized 10% MgO slurry added = 199.1 g 20% MgO slurry added = 87.9 g <i>(20 min for pH to stabilize)</i></p>	<p>Acid Addition = 1000 kg/tonne Total Feed = 204 g Pulp Density = 20 % P₈₀ = 228 µm Duration = 30 min</p> <p>Mass of MgO added = 37.5 g Mg from MgO added = 22,608 mg</p> <p>Final pH = 3.95 *Filtration Time for PLS = 20 min</p>

*(Used 185 mm diameter Buchner funnel w/ #42 Whatman Filter Paper)

Products	Mass/Volume	Assay (ppm)		Units (mg)		Distribution (%)		
		Mg	Fe	Mg	Fe	Mg	Fe	Ferrous
PLS before H ₂ O ₂	25.0 mL		3,357		84			22.2%
PLS after H ₂ O ₂	- mL							-
Preg Solution	675.0 mL	52,200	10	35,235	7	54.1%	0.1%	0.0%
Water Rinse 1	295.0 mL	36,300	14	10,709	4	16.5%	0.0%	
Water Rinse 2	246.0 mL	5,060	2	1,245	1	1.9%	0.0%	
<i>Combined PLS</i>	<i>1216.0 mL</i>	<i>38,806</i>	<i>9</i>	<i>47,188</i>	<i>11</i>	<i>72.5%</i>	<i>0.1%</i>	
PLS Leached	1216.0 mL	20,214	9	24,580	11	50.9%	0.1%	
Residue	151.5 g	118,100	70,500	17,892	10,681	27.5%	99.9%	
Calculated Feed		319,022	52,412	65,080	10,692	100.0%	100.0%	
Assayed Feed	204.0 g	236,900	40,700	48,328	8,303			
**Adjusted Feed	204.0 g	347,723		70,936				

*Combined PLS = Preg Solution + Water Rinse 1 + Water Rinse 2 + Water Rinse 3

**Adjusted Feed includes the amount of Mg added from MgO

Solids Weight Loss = 25.7%

% Mg Leached = 50.9%

(% Mg Leached does not include the Mg from MgO)

% Fe in Solution = 0.1%



ACID LEACH TEST WITH MgO ADDITION

Client: West High Yield Resources
Test: YO600 (pH = 3.95)

Date: 08-May-12
Project: MS1358

Description:	Variables:
25 °C Sulfuric Acid Leach Duration: 30 minutes Two 200 mL Displacement Water Washes 10 mL of Hydrogen Peroxide added after leach <i>(8 min to stabilize ORP)</i> MgO added after solution is oxidized 10% MgO slurry added = 199.1 g 20% MgO slurry added = 87.9 g <i>(20 min for pH to stabilize)</i>	Acid Addition = 1000 kg/tonne Total Feed = 204 g Pulp Density = 20 % P ₈₀ = 228 µm Duration = 30 min Mass of MgO added = 37.5 g Final pH = 3.95 *Filtration Time for PLS = 20 min

*(Used 185 mm diameter Buchner funnel w/ #42 Whatman Filter Paper)

Products	Mass/Volume	Assay (ppm)		Units (mg)		Distribution (%)	
		Ni	Co	Ni	Co	Ni	Co
PLS before H ₂ O ₂	25.0 mL						
PLS after H ₂ O ₂	- mL						
Preg Solution	675.0 mL	168	5	113	4	25.7%	17.1%
Water Rinse 1	295.0 mL	119	4	35	1	7.9%	5.2%
Water Rinse 2	246.0 mL	22	1	5	0	1.2%	0.7%
Combined PLS	1241.0 mL	191	6	154	5	34.8%	23.1%
Residue	149.2 g	1,930	110	288	16	65.2%	76.9%
Calculated Feed		2,166	105	442	21	100.0%	100.0%
Assayed Feed	204.0 g	1,782	112	363	23		

Solids Weight Loss = 26.9%

% Ni in Solution = 34.8%

% Co in Solution = 23.1%

Appendix F

Crystallization Tests



ACID LEACH TEST WITH MgO ADDITION

Client: West High Yield Resources
Test: YO606 (pH = 5.52)

Date: 29-May-12
Project: MS1358

Description:	Variables:
<p style="text-align: center;">25 °C Sulfuric Acid Leach Duration: 30 minutes</p> <p style="text-align: center;">Three 400 mL Displacement Water Washes</p> <p style="text-align: center;">20 mL of Hydrogen Peroxide added after leach (4 min to stabilize ORP)</p> <p style="text-align: center;">MgO added after solution is oxidized 20% MgO slurry added = 358.9 g (9 min for pH to stabilize)</p>	<p style="text-align: right;">Acid Addition = 1000 kg/tonne Total Feed = 401 g Pulp Density = 20 % P₈₀ = 228 µm Duration of Leach = 30 min</p> <p style="text-align: right;">Mass of MgO added = 71.8 g Mg from MgO added = 43,286 mg</p> <p style="text-align: right;">Final pH = 5.52 *Filtration Time for PLS = 42 minutes</p>

*(Used one 185 mm diameter Buchner funnel w/ #42 Whatman Filter Paper)

Products	Mass/Volume	Assay (ppm)		Units (mg)		Distribution (%)		
		Mg	Fe	Mg	Fe	Mg	Fe	Ferrous
Preg Solution	1406.0 mL	60,200	3	84,641	4	53.0%	0.0%	0.4%
Water Rinse 1	515.0 mL	46,400	3	23,896	2	15.0%	0.0%	
Water Rinse 2	462.9 mL	20,600	2	9,536	1	6.0%	0.0%	
Water Rinse 3	517.1 mL	2,540	0	1,313	0	0.8%	0.0%	
<i>*Combined PLS</i>	<i>2901.0 mL</i>	<i>37,200</i>	<i>2</i>	<i>107,917</i>	<i>4</i>	<i>67.5%</i>	<i>0.0%</i>	<i>0.5%</i>
PLS Leached	2901.0 mL	22,279	2	64,631	4	68.0%	0.0%	
Residue	299.6 g	134,900	69,300	40,416	20,762	25.3%	100.0%	
Calculated Feed		398,510	51,793	159,802	20,769	100.0%	100.0%	
Assayed Feed	401.0 g	236,900	40,700	94,997	16,321			
**Adjusted Feed	401.0 g	344,845		138,283				

**Combined PLS = Preg Solution + Water Rinse 1 + Water Rinse 2 + Water Rinse 3*

***Adjusted Feed includes the amount of Mg added from MgO*

Solids Weight Loss = 25.3%

% Mg Leached = 68.0%

% Fe in Solution = 0.0%

(% Mg Leached does not include the Mg from MgO)



ACID LEACH TEST WITH MgO ADDITION

Client: West High Yield Resources
Test: YO606 (pH = 5.52)

Date: 29-May-12
Project: MS1358

Description:	Variables:
<p>25 °C Sulfuric Acid Leach Duration: 30 minutes</p> <p>Three 400 mL Displacement Water Washes</p> <p>20 mL of Hydrogen Peroxide added after leach <i>(4 min to stabilize ORP)</i></p> <p>MgO added after solution is oxidized 20% MgO slurry added = 358.9 g <i>(9 min for pH to stabilize)</i></p>	<p>Acid Addition = 1000 kg/tonne</p> <p>Total Feed = 401 g</p> <p>Pulp Density = 20 %</p> <p>P₈₀ = 228 µm</p> <p>Duration of Leach = 30 min</p> <p>Mass of MgO added = 71.8 g</p> <p>Final pH = 5.52</p> <p>*Filtration Time for PLS = 42 minutes</p>

**(Used one 185 mm diameter Buchner funnel w/ #42 Whatman Filter Paper)*

Products	Mass/Volume	Assay (ppm)		Units (mg)		Distribution (%)	
		Ni	Co	Ni	Co	Ni	Co
Preg Solution	1406.0 mL	108	2.8	152	4	17.3%	8.7%
Water Rinse 1	515.0 mL	79	1.7	41	1	4.6%	1.9%
Water Rinse 2	462.9 mL	36	1.9	17	1	1.9%	2.0%
Water Rinse 3	517.1 mL	6	0.9	3	0	0.3%	1.0%
*Combined PLS	2901.0 mL	66	1.7	191	5	21.8%	10.8%
Residue	299.6 g	2,220	130	665	39	75.8%	86.4%
Calculated Feed		2,187	112	877	45	100.0%	100.0%
Assayed Feed	401.0 g	1,782	112	714	45		

**Combined PLS = Preg Solution + Water Rinse 1 + Water Rinse 2 + Water Rinse 3*

Solids Weight Loss = 25.3%

% Ni in Solution = 24.2%

% Co in Solution = 13.6%



YO607 CRYSTALLIZATION TEST

Client: West High Yield Resources
 Test: YO606 G - J (Crystallization Test)

Date: 11-Jun-12
 Project: MS1358

YO606G - 50% Evaporation by Weight

Products	Mass/Volume	Assay (ppm)			Units (mg)			Distribution (%)		
		Mg	Fe	Ni	Mg	Fe	Ni	Mg	Fe	Ni
Mass of Non-Cryst. Soln	31.0 g									
Non-Crystallized Soln	24.0 mL	67,500	3	108	1,620	0	3	21.9%	22.0%	19.6%
Mass of Crystals	88.1 g									
Dissolved Crystal Soln	426.0 mL	13,600	1	25	5,794	0	11	78.1%	78.0%	80.4%
Calculated Feed		31,534	1	56	7,414	0	13	100.0%	100.0%	100.0%
Assayed Combined PLS	235.1 g	37,200	2	66	8,746	0	15			

YO606H - 60% Evaporation by Weight (All Crystallized)

Products	Mass/Volume	Assay (ppm)			Units (mg)			Distribution (%)		
		Mg	Fe	Ni	Mg	Fe	Ni	Mg	Fe	Ni
Mass of Non-Cryst. Soln	0.0 g									
Non-Crystallized Soln	0.0 mL	0	0	0	0	0	0	0.0%	0.0%	0.0%
Mass of Crystals	98.9 g									
Dissolved Crystal Soln	855.0 mL	10,300	1	19	8,807	1	16	100.0%	100.0%	100.0%
Calculated Feed		37,459	2	67	8,807	1	16	100.0%	100.0%	100.0%
Assayed Combined PLS	235.1 g	37,200	2	66	8,746	0	15			

YO606I - 45% Evaporation by Weight

Products	Mass/Volume	Assay (ppm)			Units (mg)			Distribution (%)		
		Mg	Fe	Ni	Mg	Fe	Ni	Mg	Fe	Ni
Mass of Non-Cryst. Soln	88.6 g									
Non-Crystallized Soln	70.0 mL	75,000	3	125	5,250	0	9	61.6%	61.9%	56.3%
Mass of Crystals	39.9 g									
Dissolved Crystal Soln	430.0 mL	7,610	0	16	3,272	0	7	38.4%	38.1%	43.7%
Calculated Feed		36,250	1	66	8,522	0	16	100.0%	100.0%	100.0%
Assayed Combined PLS	235.1 g	37,200	2	66	8,746	0	15			

YO606J - 40% Evaporation by Weight

Products	Mass/Volume	Assay (ppm)			Units (mg)			Distribution (%)		
		Mg	Fe	Ni	Mg	Fe	Ni	Mg	Fe	Ni
Mass of Non-Cryst. Soln	99.1 g									
Non-Crystallized Soln	77.5 mL	74,800	3	128	5,797	0	10	68.0%	63.8%	65.9%
Mass of Crystals	39.5 g									
Dissolved Crystal Soln	220.0 mL	12,400	1	23	2,728	0	5	32.0%	36.2%	34.1%
Calculated Feed		36,261	2	64	8,525	0	15	100.0%	100.0%	100.0%
Assayed Combined PLS	235.1 g	37,200	2	66	8,746	0	15			

Crystallization Tests Assay Summary

Test Number	YO606G			YO606H**		YO606I			YO606J		
% of Soln Evaporated	50%			60%		45%			40%		
Description	Saturatd Soln	Dissolved Crystals	Crystals *	Dissolved Crystals	Crystals *	Saturatd Soln	Dissolved Crystals	Crystals *	Saturatd Soln	Dissolved Crystals	Crystals *
Total Metals											
Calcium (Ca)-Total	330	187	904	132	1146	518	160	1724	300	368	2050
Cobalt (Co)-Total	3.1	0.60	3	0.45	4	3.3	0.36	4	3.4	0.55	3
Iron (Fe)-Total	<3.0	<0.60	3	<0.60	5	<3.0	<0.30	3	<3.0	<0.60	3
Magnesium (Mg)-Total	67500	13600	65762	10300	89406	75000	7610	82013	74800	12400	69063
Manganese (Mn)-Total	232	24.9	120	22.2	193	211	9.26	100	183	20.9	116
Nickel (Ni)-Total	108	25.0	121	18.5	161	125	15.8	170	128	23.3	130
Silicon (Si)-Total	109	12.9	62	12.2	106	52.4	5.45	59	76.6	10.5	58
Sodium (Na)-Total	<200	<40	193	<40	347	<200	<20	216	<200	<40	223
Dilution factor			4.84		8.68			10.78			5.57

* Crystal assays were back calculated from the dissolved crystal assays by dilution factor

** 100% crystallization for Test YO606H, no non-crystallized assay available

Appendix G

Carbonate Precipitation & Calcination Tests

- 1.**
 - a) Leach Test (Test YO607)**
 - b) Carbonate Precipitation & Calcination with Three Re-Pulp Washes (YO607A)**
 - c) Temperature Profile Analysis (YO607B)**

- 2.**
 - a) Leach Test (YO608)**
 - b) Carbonate Precipitation & Calcination with Three Re-Pulp Washes (YO608A)**



ACID LEACH TEST WITH MgO ADDITION

Client: West High Yield Resources
Test: YO607 (pH = 5.61)

Date: 26-Jun-12
Project: MS1358

Description:	Variables:
<p>25 °C Sulfuric Acid Leach Duration: 30 minutes</p> <p>Three 400 mL Displacement Water Washes</p> <p>20 mL of Hydrogen Peroxide added after leach (5 min to stabilize ORP)</p> <p>MgO added after solution is oxidized 20% MgO slurry added = 317.3 g (9 min for pH to stabilize)</p>	<p>Acid Addition = 1000 kg/tonne Total Feed = 400.7 g Pulp Density = 20 % P₈₀ = 228 µm Duration of Leach = 30 min</p> <p>Mass of MgO added = 63.5 g Mg from MgO added = 38,269 mg</p> <p>Final pH = 5.61 *Filtration Time for PLS = 43 minutes</p>

*(Used one 185 mm diameter Buchner funnel w/ #42 Whatman Filter Paper)

Products	Mass/Volume	Assay (ppm)		Units (mg)		Distribution (%)	
		Mg	Fe	Mg	Fe	Mg	Fe
Preg Solution	1000.0 mL	63,600	3.0	63,600	3	47.0%	0.0%
Water Rinse 1	435.0 mL	41,800	3.0	18,183	1	13.4%	0.0%
Water Rinse 2	418.0 mL	28,600	1.5	11,955	1	8.8%	0.0%
Water Rinse 3	560.0 mL	7,200	0.6	4,032	0	3.0%	0.0%
<i>*Combined PLS</i>	<i>2413.0 mL</i>	<i>39,800</i>	<i>1.5</i>	<i>96,037</i>	<i>4</i>	<i>71.0%</i>	<i>0.0%</i>
PLS Leached	2413.0 mL	23,941	1.5	57,769	4	60.9%	0.0%
Residue	283.4 g	132,600	73,300	37,579	20,773	27.8%	100.0%
Calculated Feed		337,780	51,855.5	135,349	20,778	100.0%	100.0%
Assayed Feed	400.7 g	236,900	40,700	94,926	16,308		
**Adjusted Feed	400.7 g	332,405		133,195			

*Combined PLS = Preg Solution + Water Rinse 1 + Water Rinse 2 + Water Rinse 3 - Mg gained from MgO

**Adjusted Feed includes the amount of Mg added from MgO

Solids Weight Loss = 29.3%

% Mg Leached = 60.9%

(% Mg Leached does not include the Mg from MgO)

% Fe in Solution = 0.0%



ACID LEACH TEST WITH MgO ADDITION

Client: West High Yield Resources
Test: YO607 (pH = 5.61)

Date: 26-Jun-12
Project: MS1358

Description:	Variables:
<p>25 °C Sulfuric Acid Leach Duration: 30 minutes</p> <p>Three 400 mL Displacement Water Washes</p> <p>20 mL of Hydrogen Peroxide added after leach <i>(5 min to stabilize ORP)</i></p> <p>MgO added after solution is oxidized 20% MgO slurry added = 317.3 g</p>	<p>Acid Addition = 1000 kg/tonne</p> <p>Total Feed = 400.7 g</p> <p>Pulp Density = 20 %</p> <p>P₈₀ = 228 μm</p> <p>Duration of Leach = 30 min</p> <p>Mass of MgO added = 63.5 g</p> <p>Final pH = 5.61</p> <p>*Filtration Time for PLS = 43 minutes</p>

*(Used one 185 mm diameter Buchner funnel w/ #42 Whatman Filter Paper)

Products	Mass/Volume	Assay (ppm)		Units (mg)		Distribution (%)	
		Ni	Co	Ni	Co	Ni	Co
Preg Solution	1000.0 mL	93	2.3	93	2	11.2%	4.7%
Water Rinse 1	435.0 mL	59	1.3	26	1	3.1%	1.2%
Water Rinse 2	418.0 mL	40	0.9	17	0	2.0%	0.7%
Water Rinse 3	560.0 mL	11	0.2	6	0	0.8%	0.3%
*Combined PLS	2413.0 mL	59	1.5	142	4	17.1%	7.6%
Residue	283.4 g	2,420	160.0	686	45	82.9%	93.1%
Calculated Feed		2,065	121.5	827	49	100.0%	100.0%
Assayed Feed	400.7 g	1,782	112	714	45		

*Combined PLS = Preg Solution + Water Rinse 1 + Water Rinse 2 + Water Rinse 3

Solids Weight Loss = 29.3%

% Ni in Solution = 17.1%

% Co in Solution = 6.9%



CARBONATE PRECIPITATION & CALCINATION

Client: West High Yield Resources

Date: 05-Jul-12

Test: YO607A (Carbonate Precipitation & Calcination - Re-Pulped Wash x 3)

Project: MS1358

Test Description:	Variables:
Adding Sodium Carbonate Solution to Combined PLS to make Magnesium Carbonate	*YO607 Combined PLS = 2413 mL YO607 Feed = 400.7 g
Then, calcining the MgCO ₃ product until decomposition to MgO	Volume of Na ₂ CO ₃ Solution = 4669.9 mL Mass of Na₂CO₃ used = 467.0 g
Sodium Carbonate Solution (Concentration = 100 g/L)	Mass of MgCO ₃ Precipitate = 302.0 g
MgCO ₃ was added until no precipitate was observed	Temperature calcined at ~ 800 - 1000 °C
Carbonate Precipitation & Calcination Tests Three Re-pulp Washes were performed	Please Note: Results are extrapolated to match the results taken from subsamples

Carbonate Precipitate (Dried):

Products	Mass/Volume	Assay (ppm)		Units (mg)		Distribution (%)	
		Mg	Fe	Mg	Fe	Mg	Fe
Na ₂ CO ₃ Soln Addition	4669.9 mL						
Barren Solution	5478.9 mL	1,590	1.2	8,711	7	9.6%	23.6%
Re-Pulp Wash 1	6,425.8 mL	1,010	0.2	6,490	1	7.2%	3.5%
Re-Pulp Hot Water Wash 2	4,872.9 mL	242	0.0	1,179	0	1.3%	0.5%
Re-Pulp Hot Water Wash 3	5,408.4 mL	485	0.0	2,623	0	2.9%	0.6%
MgCO ₃ Precipitate (Dried)	302.0 g	236,530	66.4	71,435	20	79.0%	71.9%
Calculated Combined PLS		37,480	11.6	90,438	28	100.0%	100.0%
YO607 Combined PLS	2413.0 mL	39,800	1.5	96,037	4		

Loss on Ignition (LOI) = 60.2%

%Mg in Dried Carbonate = 23.7%

Assayed Impurities from Carbonate Product

Al ₂ O ₃	BaO	CaO	Cr ₂ O ₃	Fe ₂ O ₃	K ₂ O	MgO	
%	%	%	%	%	%	%	
<0.01	<0.01	0.376	<0.01	0.02	0.01	39.2	
MnO	Na ₂ O	P ₂ O ₅	SiO ₂	TiO ₂	SrO	LOI	Total
%	%	%	%	%	%	%	%
0.086	<0.01	<0.01	0.023	<0.01	<0.01	60.24	100

Fully calcined:

Products	Mass/Volume	Assay (ppm)		Units (mg)		Distribution (%)	
		Mg	Fe	Mg	Fe	Mg	Fe
Na ₂ CO ₃ Soln Addition	4669.9 mL						
Barren Solution	5478.9 mL	1,590	1.2	8,711	7	9.6%	36.7%
Re-Pulp Wash 1	6,425.8 mL	1,010	0.2	6,490	1	7.1%	5.4%
Re-Pulp Hot Water Wash 2	4,872.9 mL	242	0.0	1,179	0	1.3%	0.8%
Re-Pulp Hot Water Wash 3	5,408.4 mL	485	0.0	2,623	0	2.9%	0.9%
Calcined MgO Product	120.1 g	598,051	83.9	71,814	10	79.1%	56.2%
Calculated Combined PLS		37,637	7.4	90,818	18	100.0%	100.0%
YO607 Combined PLS	2413.0 mL	39,800	1.5	96,037	4		

Purity of MgO = 99.17%

Assay for Fully Caclined Product

Al ₂ O ₃	BaO	CaO	Cr ₂ O ₃	Fe ₂ O ₃	K ₂ O	MgO	MnO	Na ₂ O
%	%	%	%	%	%	%	%	%
<0.01	<0.01	0.95	<0.01	0.02	0.04	99.17	0.21	<0.01
P ₂ O ₅	SiO ₂	TiO ₂	SrO	S	Ni	Co	Zn	Total
%	%	%	%	%	ppm	ppm	ppm	%
<.01	0.12	<0.01	<0.01	0.05	873	44	55	101



TEMPERATURE PROFILE ANALYSIS

Client: West High Yield Resources
Test: YO607B (Calcination Test w/ Temperature Analysis)

Date: 05-Jul-12
Project: MS1358

Calcination Test Description:

Calcine $MgCO_3$ precipitate and derive weight loss from representative sample

Temperature Profile: Simulated a TGA

From 300 °C to 500°C (100°C increment) - record mass

From 500°C to 800°C (50°C increment) - record mass

Crucible is cooled before mass is recorded

Carbonate Precipitation & Calcination Tests

Temperature Profile - Heat to 800°C

Initial Mass before Calcination 26.132 g ($MgCO_3$ sample dried at 75°C)

Final Mass after Calcination 11.188 g

Weight Loss (Decomposition) = 57.2%

Temperature Profile for Converting $MgCO_3$ to MgO by Calcination

Temp (°C)	Comb. Wt. (g)	Wt. (%)	Wt. Loss (%)
25	26.132	100	0.0
300	19.258	73.7	26.3
400	17.434	66.7	33.3
500	14.097	53.9	46.1
550	11.403	43.6	56.4
600	11.377	43.5	56.5
650	11.38	43.5	56.5
700	11.252	43.1	56.9
750	11.167	42.7	57.3
800	11.188	42.8	57.2

Weight loss begins to plateau at ~ 580°C

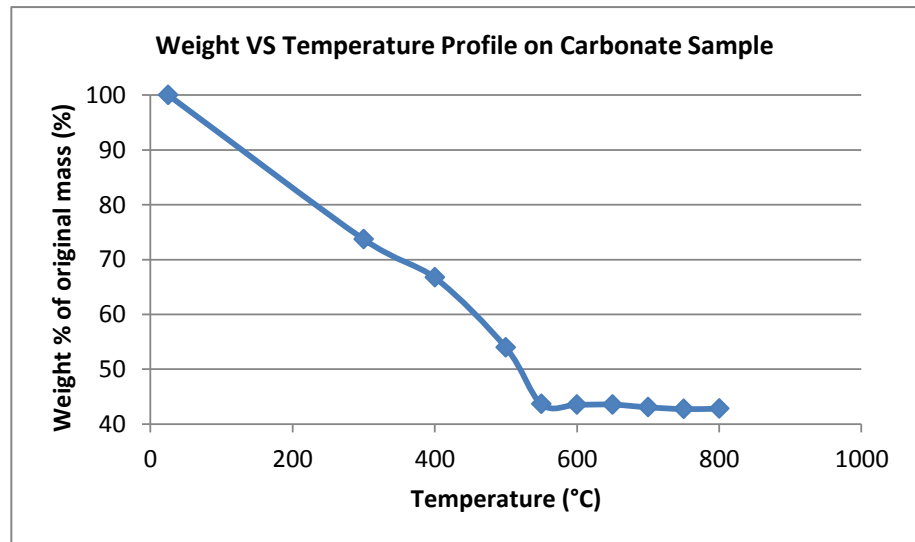



ACID LEACH TEST WITH MgO ADDITION

Client: West High Yield Resources
Test: YO608 (pH = 3.78)

Date: 27-Jun-12
Project: MS1358

Description:	Variables:
<p style="text-align: center;">25 °C Sulfuric Acid Leach Duration: 30 minutes</p> <p style="text-align: center;">Three 400 mL Displacement Water Washes</p> <p style="text-align: center;">20 mL of Hydrogen Peroxide added after leach (4 min to stabilize ORP)</p> <p style="text-align: center;">MgO added after solution is oxidized 20% MgO slurry added = 324.2 g (33 min for pH to stabilize)</p>	<p style="text-align: right;">Acid Addition = 1000 kg/tonne Total Feed = 402.4 g Pulp Density = 20 % P₈₀ = 228 μm Duration of Leach = 30 min</p> <p style="text-align: right;">Mass of MgO added = 64.8 g Mg from MgO added = 39,101 mg</p> <p style="text-align: right;">Final pH = 3.78 *Filtration Time for PLS = 225 minutes</p>

*(Used one 185 mm diameter Buchner funnel w/ #42 Whatman Filter Paper)

Products	Mass/Volume	Assay (ppm)		Units (mg)		Distribution (%)	
		Mg	Fe	Mg	Fe	Mg	Fe
Preg Solution	1060 mL	55,300	71.0	58,618	75	47.9%	0.4%
Water Rinse 1	430 mL	38,300	46.3	16,469	20	13.5%	0.1%
Water Rinse 2	390 mL	21,100	22.5	8,229	9	6.7%	0.0%
Water Rinse 3	520 mL	5,200	4.7	2,704	2	2.2%	0.0%
<i>*Combined PLS</i>	<i>2400 mL</i>	<i>40,200</i>	<i>47.8</i>	<i>96,480</i>	<i>115</i>	<i>78.9%</i>	<i>0.6%</i>
PLS Leached	2400.0 mL	23,908	47.8	57,379	115	60.2%	0.6%
Residue	280.6 g	129,200	68,500	36,254	19,221	29.6%	99.4%
Calculated Feed		303,861	48,030.5	122,274	19,327	100.0%	100.0%
Assayed Feed	402.4 g	236,900	40,700	95,329	16,378		
**Adjusted Feed	402.4 g	334,070		134,430			

**Combined PLS = Preg Solution + Water Rinse 1 + Water Rinse 2 + Water Rinse 3*

***Adjusted Feed includes the amount of Mg added from MgO*

Solids Weight Loss = 30.3%

% Mg Leached = 60.2%

% Fe in Solution = 0.6%

(% Mg Leached does not include the Mg from MgO)



ACID LEACH TEST WITH MgO ADDITION

Client: West High Yield Resources
Test: YO608 (pH = 3.78)

Date: 27-Jun-12
Project: MS1358

Description:	Variables:
<p>25 °C Sulfuric Acid Leach Duration: 30 minutes</p> <p>Three 400 mL Displacement Water Washes</p> <p>20 mL of Hydrogen Peroxide added after leach <i>(4 min to stabilize ORP)</i></p> <p>MgO added after solution is oxidized 20% MgO slurry added = 324.2 g</p>	<p>Acid Addition = 1000 kg/tonne</p> <p>Total Feed = 402.4 g</p> <p>Pulp Density = 20 %</p> <p>P₈₀ = 228 μm</p> <p>Duration of Leach = 30 min</p> <p>Mass of MgO added = 64.8 g</p> <p>Final pH = 3.78</p> <p>*Filtration Time for PLS = 225 minutes</p>

*(Used one 185 mm diameter Buchner funnel w/ #42 Whatman Filter Paper)

Products	Mass/Volume	Assay (ppm)		Units (mg)		Distribution (%)	
		Ni	Co	Ni	Co	Ni	Co
Preg Solution	1060 mL	199	6.4	211	7	26.8%	13.7%
Water Rinse 1	430 mL	139	4.5	60	2	7.6%	3.9%
Water Rinse 2	390 mL	78	2.6	30	1	3.9%	2.1%
Water Rinse 3	520 mL	21	0.7	11	0	1.4%	0.7%
*Combined PLS	2400 mL	141	4.5	338	11	43.0%	21.9%
Residue	280.6 g	1,690	140.0	474	39	60.3%	79.6%
Calculated Feed		1,954	122.7	786	49	100.0%	100.0%
Assayed Feed	402.4 g	1,782	112	717	45		

*Combined PLS = Preg Solution + Water Rinse 1 + Water Rinse 2 + Water Rinse 3

Solids Weight Loss = 30.3%

% Ni in Solution = 39.7%

% Co in Solution = 20.4%



CARBONATE PRECIPITATION & CALCINATION

Client: West High Yield Resources

Date: 05-Jul-12

Test: YO608A (Carbonate Precipitation & Calcination - Re-Pulped Wash x 3)

Project: MS1358

Test Description:	Variables:
Adding Sodium Carbonate Solution to Combined PLS to make Magnesium Carbonate	*YO608 Combined PLS = 2400 mL YO608 Feed = 402.4 g
Then, calcining the MgCO ₃ product until decomposition to MgO	Volume of Na ₂ CO ₃ Solution = 4388.6 mL Mass of Na₂CO₃ used = 438.9 g
Sodium Carbonate Solution (Concentration = 100 g/L)	Mass of MgCO ₃ Precipitate = 295.3 g
MgCO ₃ was added until no precipitate was observed	Temperature calcined at ~ 800 - 1000 °C
Carbonate Precipitation & Calcination Tests Three Displacement Wash and Three Re-pulp Wash were performed	Please Note: Results are extrapolated to match the results taken from subsamples

Carbonate Precipitate (Dried):

Products	Mass/Volume	Assay (ppm)		Units (mg)		Distribution (%)	
		Mg	Fe	Mg	Fe	Mg	Fe
Na ₂ CO ₃ Soln Addition	4388.6 mL						
Barren Solution	5485.7 mL	1,350	1.2	7,406	7	8.2%	10.5%
Water Wash 1	1782.9 mL	1,710	0.6	3,049	1	3.4%	1.7%
Water Wash 2	1755.4 mL	459	0.3	806	1	0.9%	0.8%
Water Wash 3	1728.0 mL	267	0.1	461	0	0.5%	0.3%
Re-Pulp Wash 1	6,204.7 mL	233	0.1	1,446	0	1.6%	0.6%
Re-Pulp Hot Water Wash 2	6,632.6 mL	75.9	0.0	503	0	0.6%	0.3%
Re-Pulp Hot Water Wash 3	7,916.3 mL	64.1	0.0	507	0	0.6%	0.4%
MgCO ₃ Precipitate	295.3 g	257,244	181.8	75,953	54	84.3%	85.4%
Calculated Combined PLS		37,555	26.2	90,131	63	100.0%	100.0%
YO608 Combined PLS	2400.0 mL	40,200	1.5	96,480	4		

Loss on Ignition (LOI) = 56.9%

%Mg in Dried Carbonate = 25.7%

Assayed Impurities from Caclined Product

Al ₂ O ₃	BaO	CaO	Cr ₂ O ₃	Fe ₂ O ₃	K ₂ O	MgO	
%	%	%	%	%	%	%	
<0.01	<0.01	0.214	<0.01	0.05	<0.01	42.7	
MnO	Na ₂ O	P ₂ O ₅	SiO ₂	TiO ₂	SrO	LOI	Total
%	%	%	%	%	%	%	%
0.1	0.094	<0.01	0.01	<0.01	<0.01	56.87	100

Fully calcined:

Products	Mass/Volume	Assay (ppm)		Units (mg)		Distribution (%)	
		Mg	Fe	Mg	Fe	Mg	Fe
Na ₂ CO ₃ Soln Addition	4388.6 mL						
Barren Solution	5485.7 mL	1,350	1.2	7,406	7	8.2%	9.0%
Water Wash 1	1782.9 mL	1,710	0.6	3,049	1	3.4%	1.5%
Water Wash 2	1755.4 mL	459	0.3	806	1	0.9%	0.7%
Water Wash 3	1728.0 mL	267	0.1	461	0	0.5%	0.3%
Re-Pulp Wash 1	6204.7 mL	233	0.1	1,446	0	1.6%	0.5%
Re-Pulp Hot Water Wash 2	6632.6 mL	75.9	0.0	503	0	0.6%	0.3%
Re-Pulp Hot Water Wash 3	7916.3 mL	64.1	0.0	507	0	0.6%	0.3%
Calcined MgO Product	127.3 g	598,497	503.6	76,215	64	84.3%	87.5%
Calculated Combined PLS		37,664	30.6	90,393	73	100.0%	100.0%
YO607 Combined PLS	2400.0 mL	40,200	1.5	96,480	4		

Purity of MgO = 99.25%

Assay for Fully Caclined Product

Al ₂ O ₃	BaO	CaO	Cr ₂ O ₃	Fe ₂ O ₃	K ₂ O	MgO	MnO	Na ₂ O
%	%	%	%	%	%	%	%	%
<0.01	<0.01	0.52	<0.01	0.14	0.08	99.25	0.24	0.09
P ₂ O ₅	SiO ₂	TiO ₂	SrO	S	Ni	Co	Zn	Total
%	%	%	%	%	ppm	ppm	ppm	%
<0.01	0.08	<0.01	<0.01	0.05	2170	85	58	100

Appendix H

Process Flow Sheet of Metallurgical Test Work

Sample Description	ICP Au ppm	ICP Pd ppm	ICP Pt ppm	ICP Ag ppm	ICP Al %	ICP As ppm	ICP Ba ppm	ICP Bi ppm	ICP Ca %	ICP Cd ppm	ICP Co ppm	ICP Cr ppm	ICP Cu ppm	ICP Fe %	ICP Hg ppm	ICP K %
Head (P80 = 183 μm)				0.3	0.1	34	<10	3	0.46	<0.5	111	399	<1	3.72	<3	0.02
Head (P80 = 95 μm)				0.2	0.11	34	<10	<2	0.46	<0.5	113	480	8	4.08	<3	0.02
Head (P80 = 59 μm)	0.065	0.005	<0.005	0.2	0.11	30	<10	<2	0.46	<0.5	113	633	9	4.41	<3	0.02

Sample Description	ICP La ppm	ICP Mg %	ICP Mn ppm	ICP Mo ppm	ICP Na %	ICP Ni ppm	ICP P ppm	ICP Pb ppm	ICP Sb ppm	ICP Sc ppm	ICP Sr ppm	ICP Ti %	ICP Tl ppm	ICP V ppm	ICP W ppm	ICP Zn ppm	ICP Zr ppm
Head (P80 = 183 μm)	<2	24.0	762	2	<0.01	1747	23	<2	<2	5	37	<0.01	<10	6	<10	30	<2
Head (P80 = 95 μm)	<2	23.4	775	3	<0.01	1789	26	<2	<2	5	38	<0.01	<10	7	<10	32	<2
Head (P80 = 59 μm)	<2	23.7	787	4	<0.01	1809	47	3	<2	5	38	<0.01	<10	8	<10	29	<2

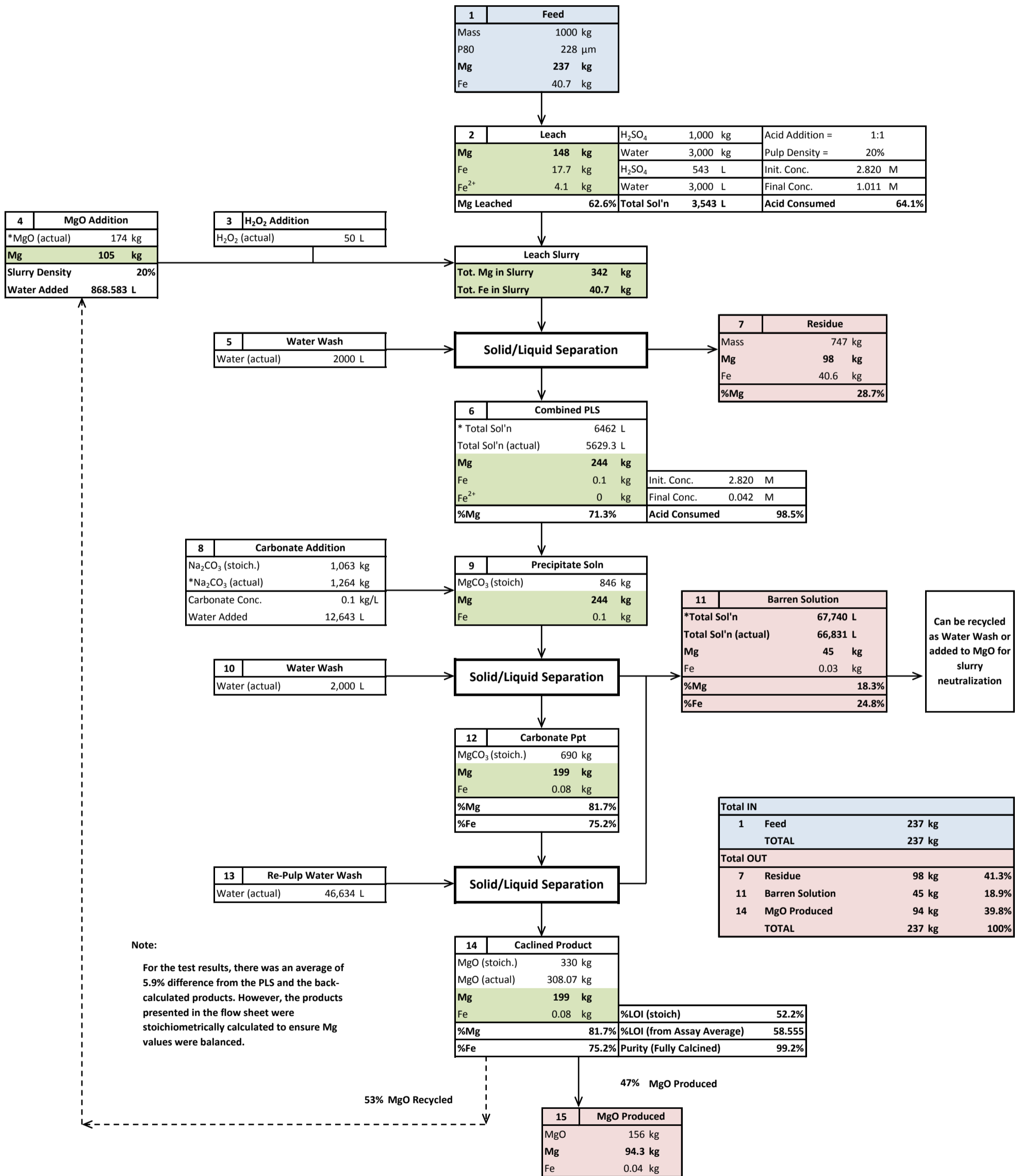

Al ₂ O ₃	BaO	CaO	Cr ₂ O ₃	Fe ₂ O ₃	K ₂ O	MgO	MnO	Na ₂ O	P ₂ O ₅	SiO ₂	TiO ₂	SrO	S	Ni	Co	Zn	Total
%	%	%	%	%	%	%	%	%	%	%	%	%	%	ppm	ppm	ppm	%
<0.01	<0.01	0.73	<0.01	0.08	0.06	99.2	0.22	0.09	<0.01	0.10	<0.01	<0.01	0.05	1522	64.6	56.4	101

* Assuming no loss of solution during test work and no retained solution in residue (100% solid/liquid separation)

MW MgO	40.3044 kg/kmol
MW Mg	24.3050 kg/kmol
MW MgSO4	120.3676 kg/kmol
MW Na2CO3	105.9886 kg/kmol
MW MgCO3	84.3139 kg/kmol
MW H2SO4	98.079 kg/kmol
MW Fe	55.8450 kg/kmol
MW H2O2	34.0147 kg/kmol
Bottle Grade H2SO4	98%
Density H2O	1 kg/L
Density H2O2	1.45 kg/L
Density H2SO4	1.84 kg/L

1. Feed - Head Assay

Tests	YO101	YO201	YO301	Average
Mg in Head Assay	24.0%	23.4%	23.7%	23.7%
Fe in Head Assay	3.7%	4.1%	4.4%	4.1%

2. Leach - Leach Data

Tests	YO401	YO402	YO606	YO607	YO608	Average
Mg Leached from Feed	63.9%	60.1%	68.0%	60.9%	60.2%	62.6%
Total Mg in PLS	-	-	67.5%	71.0%	78.9%	72.5%

Theoretical acid required

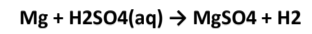

237	kg Mg =	9.75	kmol Mg
9.75	kmol Mg =	9.75	kmol H2SO4
	=	956	kg H2SO4

Tests	YO401	YO402	Average
Fe in Leach	45.4%	41.7%	43.5%

Tests	YO401	YO402	YO600	YO601	YO602	YO603	YO604	Average
Ferrous in Leach	27.5%	23.9%	22.2%	21.3%	21.6%	-	23.9%	23.4%

Acid Consumption Under Preferred Conditions (Oxalic Method) - Before Slurry Neutralization

Tests	YO401	YO402	Average
Init. Conc. (M)	2.820	2.820	2.820
Final Conc. (M)	0.933854167	1.088541667	1.011
Acid Consumed	66.9%	61.4%	64.1%

3. H2O2 Addition

Used 20 mL per 400 g Feed (the amount of H2O2 required was determined when ORP stabilized)

Therefore, volume of H2O2 required is 50 L/tonne-ore

4.0 MgO Addition

Tests	pH	MgO Added (g)	Feed Ore (g)	MgO per Feed kg/tonne-ore
YO601	2.72	35.68	196.4	181.7
YO604	3.06	34.38	198	173.6
YO603	3.51	37.22	198.2	187.8
YO602	3.75	38.68	206.5	187.3
YO608	3.78	64.84	402.4	161.1
YO600	3.95	37.49	204	183.8
YO606	5.52	71.78	401	179.0
YO607	5.61	63.46	400.7	158.4

Stoich. Calculation

MgO added to neutralize slurry and ppt out iron impurities
MgO added as a 20% slurry until pH > 4

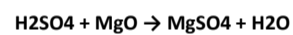

$$1.011 \text{ M H}_2\text{SO}_4 = 1.0111979 \text{ M MgO}$$

$$= 40.8 \text{ g MgO/L PLS}$$

Therefore, 3,543 L sol'n = 144.4 kg MgO req'd

Average MgO required to reach pH ≥ 3.95 (kg MgO/tonne-ore) = 173.7 (Added as a 20% slurry)

5. Water Wash After Slurry Neutralization

Tests	YO401	YO402	YO600	YO601	YO602	YO603	YO604	YO606	YO607	YO608
Water Added (L)	0.4	0.4	0.4	0.675	0.4	0.4	0.4	1.2	1.2	1.2
Feed Ore (g)	405	404.8	204	196.4	206.5	198.2	198	401	400.7	402.4
Water per Feed (L/tonne-ore)	988	988	1961	3437	1937	2018	2020	2993	2995	2982
Stages of 1000 L H2O/tonne-ore	1	1	2	3.5	2	2	2	3	3	3
3rd stage wash %Mg in Sol'n								0.8%	3.0%	2.2%

Each stage of displacement wash was done by adding 1000L H2O/tonne-ore

Since the 3rd stage recovery of Mg is fairly low, most of the magnesium is washed out of the residue by the second stage of water wash

Therefore, only 2000 L/tonne-ore is required for water wash

6. Combined PLS

Tests	YO600	YO601	YO602	YO603	YO604	YO606	YO607	YO608	Average
PLS Volume (mL)	1216	1240	1132	1126	1067.9	2901	2413	2400	
Feed Ore (g)	204	196.4	206.5	198.2	198	401	400.7	402.4	
PLS per tonne-ore (L/tonne-ore)	5961	6314	5482	5681	5393	7234	6022	5964	5629
Total Mg in Leach Sol'n incl MgO	72.5%	68.5%	70.3%	70.7%	71.2%	67.5%	71.0%	78.9%	71.3%
Total Mg in PLS incl MgO (mg)	47,188	44,994	48,625	47,599	45,838	107,917	96,037	96,480	
Total Mg in PLS/Feed (kg Mg/tonne-ore)	231.3	229.1	235.5	240.2	231.5	269.1	239.7	239.8	239.5

Leach Data after Slurry Neutralization

Tests	YO600	YO601	YO602	YO603	YO604	YO606	YO607	YO608	Average
Fe in PLS after MgO (%Fe out of total Fe)	0.1%	0.9%	0.0%	0.1%	0.3%	0.0%	0.0%	0.6%	0.3%

Tests	YO600	YO601	YO602	YO603	YO604	YO606	YO607	YO608	Average
Ferrous in PLS after MgO	0.0%	0.0%	0.0%	0.0%	0.0%	0.5%	0.0%	0.0%	0.0%

Tests	YO600	YO601	YO602	YO603	YO604	YO606	Average
Init. Conc. (M)	2.820	2.820	2.820	2.820	2.820	2.820	2.820
Final Conc. (M)	0.051	0.048	0.048	0.051	0.051	0.006	0.042
Acid Consumed	98.2%	98.3%	98.3%	98.2%	98.2%	99.8%	98.5%

7. Residue

Tests	YO600	YO601	YO602	YO603	YO604	YO606	YO607	YO608	Average
% Weight Loss from Feed	25.7%	24.0%	22.9%	23.1%	21.6%	25.3%	29.3%	30.3%	25.3%

Amount of Mg in Residue	28.7%
Amount of Fe in Residue	99.7%

8. Carbonate Addition (100 g/L Na2CO3)

Concentration of Na2CO3 Sol'n = 100 g Na2CO3/L

Tests	YO607	YO608	Average
Volume of Carbonate Soln Added (mL)	4669.864706	5486	
Mass of Carbonate Added (g)	466.9864706	549	
Feed Ore (g)	400.7	402.4	
Carbonate Added (kg Na2CO3/tonne-ore)	1165.42668	1363	1264
Water Required (mL)			12,643

Stoich. Calculation

Adding Na2CO3 until no ppt is seen forming

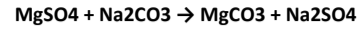

244 kg Mg	=	1207 kg MgSO4
	=	10.0 kmol MgSO4
10.0 kmol MgSO4	=	10.0 kmol Na2CO3
Carbonate Required	=	1063 kg Na2CO3 req

9. Precipitate Solution

Total Mg in Leach Sol'n incl MgO	71.3%	(from Stream 6)
Total Mg in PLS/Feed (kg Mg/tonne-ore)	239.5	(from Stream 6)

Stoich. Calculation

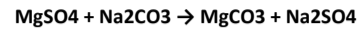

10.0 kmol MgSO4	=	10.0 kmol MgCO3
Theoretical mass of MgCO3 in ppt sol'n	=	846 kg MgCO3

10. Water Wash

Each stage of wash was done by adding 1000L H2O/tonne-ore

Only 2 stage is required - Must make sure re-pulp wash to ensure sodium and sulfate ions are washed out of precipitate

Therefore, only 2000 L/tonne-ore is required for water wash

11. Barren Solution

Tests	Non-fully calcined		Fully calcined		Average
	YO607	YO608	YO607	YO608	
%Mg in Barren Sol'n (from PLS)	9.6%	8.2%	9.6%	8.2%	8.9%
%Mg in all Washes (from PLS)	11.4%	7.5%	11.3%	7.5%	9.4%
Total % Mg NOT in MgO (from PLS)	21.0%	15.7%	20.9%	15.7%	18.3%

Tests	Non-fully calcined		Fully calcined		Average
	YO607	YO608	YO607	YO608	
%Fe in Barren Sol'n (from PLS)	23.6%	10.5%	36.7%	9.0%	19.9%
%Fe in all Washes (from PLS)	4.6%	4.2%	7.1%	3.6%	4.8%
Total % Fe NOT in MgO (from PLS)	28.1%	14.6%	43.8%	12.5%	24.8%

Tests	Barren (mL)	Wash (mL)	Re-Pulp (mL)	Total Vol. (mL)	Feed Ore (g)	Barren/Feed (L/tonne-ore)
YO607	5479	0	16,707	22,186	401	55,368
YO608	5486	5266	20,754	31,506	402	78,294
Average Volume of Barren Soln per tonne ore						66,831

12. Carbonate Precipitate

Total % Mg in MgO (from PLS)	81.7%
Total % Fe in MgO (from PLS)	75.2%

Stoich. Calculation

=	199 kg Mg =	690 kg MgCO3
		(Theoretical Mass of Dried MgCO3)

13. Re-Pulp Water Wash

YO607 Re-Pulp Washes	41,695 L water/tonne-ore
YO608 Re-Pulp Washes	51,574 L water/tonne-ore
Average Water Required for Re-Pulp Wash	46,634 L water/tonne-ore

14. Calcined Product

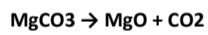

690 kg MgCO3	=	8.2 kmol MgCO3
8.2 kmol MgCO3	=	8.2 kmol MgO

Theoretical Mass of Calcined MgO = 330.1 kg MgO

Tests	Carbonate Ppt			Fully calcined			Total Average
	YO607	YO608	Average	YO607	YO608	Average	
%LOI	60.2%	56.9%	58.6%	60.2%	56.9%	58.6%	58.6%
Mass of Product (g)	302.0	295.3	298.6	120.1	127.3	123.7	211.2
Feed Ore (g)	400.7	402.4	401.6	400.7	402.4	401.6	401.6
Mass of calcined MgO (kg MgO/tonne-ore)	753.7	733.7	743.7	299.7	316.5	308.1	525.9
%Mg Difference from PLS to Prodct	5.8%	6.6%	6.2%	5.4%	6.3%	5.9%	6.0%

Calcined Assays

Assayed Impurities from Carbonate Product (YO607A)

Al2O3	BaO	CaO	Cr2O3	Fe2O3	K2O	MgO	MnO	Na2O	P2O5	SiO2	TiO2	SrO	LOI	Total
%	%	%	%	%	%	%	%	%	%	%	%	%	%	%
<0.01	<0.01	0.376	<0.01	0.02	0.01	39.2	0.086	<0.01	<0.01	0.023	<0.01	<0.01	60.24	100

Assay for Fully Calcined Product (YO607A)

Al2O3	BaO	CaO	Cr2O3	Fe2O3	K2O	MgO	MnO	Na2O
%	%	%	%	%	%	%	%	%
<0.01	<0.01	0.95	<0.01	0.02	0.04	99.17	0.21	<0.01
P2O5	SiO2	TiO2	SrO	S	Ni	Co	Zn	Total
%	%	%	%	%	ppm	ppm	ppm	%
<.01	0.12	<0.01	<0.01	0.05	873	44	55	101

Assayed Impurities from Carbonate Product (YO608A)

Al2O3	BaO	CaO	Cr2O3	Fe2O3	K2O	MgO	MnO	Na2O	P2O5	SiO2	TiO2	SrO	LOI	Total
%	%	%	%	%	%	%	%	%	%	%	%	%	%	%
<0.01	<0.01	0.214	<0.01	0.05	<0.01	42.7	0.1	0.094	<0.01	0.01	<0.01	<0.01	56.87	100

Assay for Fully Calcined Product (YO608A)

Al2O3	BaO	CaO	Cr2O3	Fe2O3	K2O	MgO	MnO	Na2O
%	%	%	%	%	%	%	%	%
<0.01	<0.01	0.52	<0.01	0.14	0.08	99.25	0.24	0.09
P2O5	SiO2	TiO2	SrO	S	Ni	Co	Zn	Total
%	%	%	%	%	ppm	ppm	ppm	%
<0.01	0.08	<0.01	<0.01	0.05	2,170	85	58	100

Appendix I

Acid Consumption Summary

Client: West High Yield Resources
Test: Acid Consumption Summary

Date: Feb.21, 2012
Project: MS1358

Acid Leach & Intense Acid Leaches

Tests	P80 (µm)	Pulp Density	Leach Temp. (°C)	Duration (hours)	Acid Addition (kg/tonne)	Acid Consumed (kg/tonne)	Acid Consumed	Mg Leached	Initial Conc. (M)	Final Conc. (M)
YO102	183	15%	25	2	500	241.7	48.3%	26.7%	0.92	0.48
YO312 PLS 1	59	25%	70	2	500	480.1	96.0%	46.0%	1.80	0.07
YO312 PLS 2	59	25%	70	2	500	416.8	83.4%	30.2%	1.80	0.30
YO313	59	25%	25	2	1000	758.4	75.8%	73.9%	3.93	0.95
YO314 PLS 1	59	35%	70	0.5	500	487.8	97.6%	44.9%	3.07	0.08
YO314 PLS 2	59	35%	70	0.5	500	317.8	63.6%	29.2%	3.07	1.12

2 Stage Test (combined PLS)	P80 (µm)	Pulp Density	Leach Temp. (°C)	Duration (hours)	Acid Addition (kg/tonne)	Acid Consumed (kg/tonne)	Acid Consumed	Mg Leached
YO312	59	25%	70	2 + 2	1000	896.9	89.7%	76.2%
YO314	59	35%	70	0.5 + 0.5	1000	805.6	80.6%	74.1%

Acid Leaches (Preferred Conditions)

Tests	P80 (µm)	Pulp Density	Leach Temp. (°C)	Duration (hours)	Acid Addition (kg/tonne)	Acid Consumed (kg/tonne)	Acid Consumed	Mg Leached	Initial Conc. (M)	Final Conc. (M)
YO401	228	20%	25	0.5	1000	668.8	66.9%	63.9%	2.82	0.93
YO402	228	20%	25	0.5	1000	613.9	61.4%	60.1%	2.82	1.09

Acid Leaches (Preferred Conditions) - MgO Addition to Consume Acid

Tests	P80 (µm)	Pulp Density	Leach Temp. (°C)	Duration (hours)	Acid Addition (kg/tonne)	Acid Consumed (kg/tonne)	Acid Consumed	Mg Leached from Feed	Initial Conc. (M)	Final Conc. (M)	Mg Leached in Sol'n (incl. Mg from MgO)
YO600	228	20%	25	0.5	1000	982.0	98.2%	50.9%	2.82	0.051	72.5%
YO601	228	20%	25	0.5	1000	983.2	98.3%	50.5%	2.82	0.048	68.5%
YO602	228	20%	25	0.5	1000	983.2	98.3%	51.7%	2.82	0.048	70.3%
YO603	228	20%	25	0.5	1000	982.0	98.2%	53.6%	2.82	0.051	70.7%
YO604	228	20%	25	0.5	1000	982.0	98.2%	53.5%	2.82	0.051	71.2%

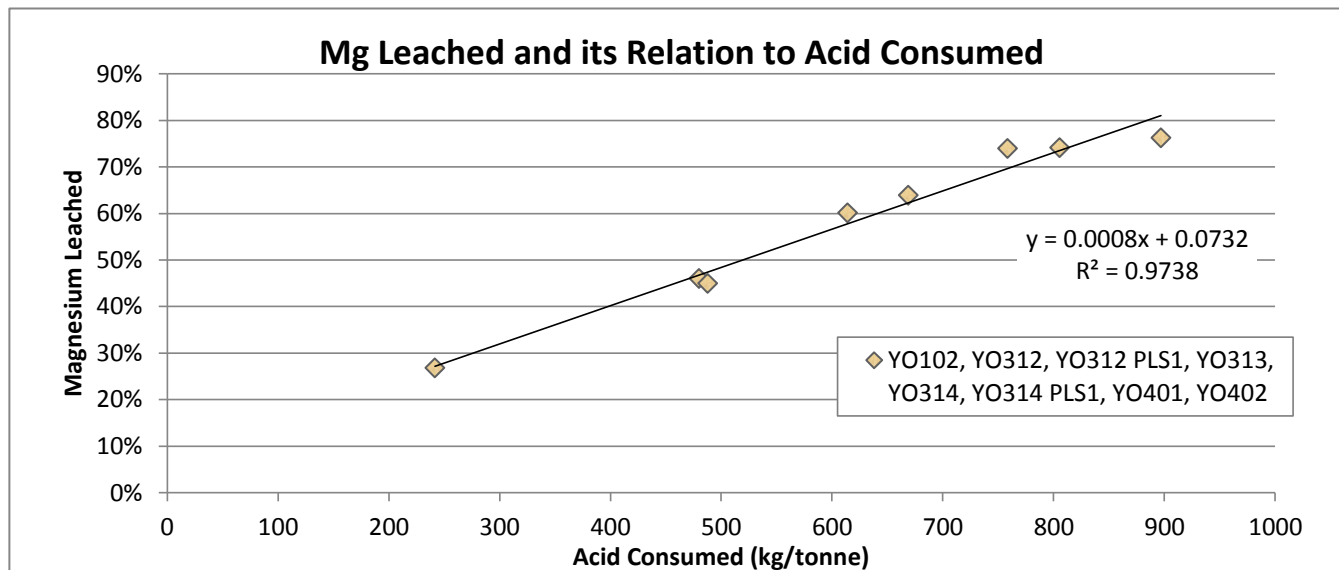

(Tests YO600 - YO604 was not included in the graph since the MgO addition consumed the remaining acid)

Appendix J

Assay Results

1. **Head Assays**
 - a) YO101
 - b) YO201
 - c) YO301

2. **Product Assays**
 - a) YO607A
 - b) YO607B



MS1358: WHY Head Assay Summary

Sample Number	Sample Description	ICP Au ppm	ICP Pd ppm	ICP Pt ppm	ICP Ag ppm	ICP Al %	ICP As ppm	ICP Ba ppm	ICP Bi ppm	ICP Ca %	ICP Cd ppm	ICP Co ppm	ICP Cr ppm	ICP Cu ppm	ICP Fe %	ICP Hg ppm	ICP K %
88330	Head (P80 = 183 µm)				0.3	0.1	34	<10	3	0.46	<0.5	111	399	<1	3.72	<3	0.02
88331, 88944	Head (P80 = 95 µm)				0.2	0.11	34	<10	<2	0.46	<0.5	113	480	8	4.08	<3	0.02
88332, 90950	Head (P80 = 59 µm)	0.065	0.005	<0.005	0.2	0.11	30	<10	<2	0.46	<0.5	113	633	9	4.41	<3	0.02

Sample Number	Sample Description	ICP La ppm	ICP Mg %	ICP Mn ppm	ICP Mo ppm	ICP Na %	ICP Ni ppm	ICP P ppm	ICP Pb ppm	ICP Sb ppm	ICP Sc ppm	ICP Sr ppm	ICP Ti %	ICP Tl ppm	ICP V ppm	ICP W ppm	ICP Zn ppm	ICP Zr ppm
88330	Head (P80 = 183 µm)	<2	24.0	762	2	<0.01	1,747	23	<2	<2	5	37	<0.01	<10	6	<10	30	<2
88331, 88944	Head (P80 = 95 µm)	<2	23.4	775	3	<0.01	1,789	26	<2	<2	5	38	<0.01	<10	7	<10	32.0	<2
88332, 90950	Head (P80 = 59 µm)	<2	23.7	787	4	<0.01	1,809	47	3	<2	5	38	<0.01	<10	8	<10	29.0	<2



MS1358: WHY Product Assay Summary

Lithium Borate Fusion - Summation of Oxides, XRF finish (CARBONATE PRECIPITATE PRODUCT - Before Roasting)

Sample Number	Sample Description	Al ₂ O ₃ %	BaO %	CaO %	Cr ₂ O ₃ %	Fe ₂ O ₃ %	K ₂ O %	MgO %	MnO %	Na ₂ O %	P ₂ O ₅ %	SiO ₂ %	TiO ₂ %	SrO %	LOI %	Total %
92226	YO607A	<0.01	<0.01	0.376	<0.01	0.019	0.01	39.223	0.086	<0.01	<0.01	0.023	<0.01	<0.01	60.24	100
92227	YO608A	<0.01	<0.01	0.214	<0.01	0.052	<0.01	42.658	0.1	0.094	<0.01	0.01	<0.01	<0.01	56.87	100

4 Acid Digest - ICP/ICP-MS finish (FULLY CALCINED PRODUCT)

Sample Number	Sample Description	Ag ppm	Al %	As ppm	Ba ppm	Be ppm	Bi ppm	Ca %	Cd ppm	Ce ppm	Co ppm	Cr ppm	Cs ppm	Cu ppm	Fe %	Ga ppm	Ge ppm	Hf ppm	In ppm
92226	YO607A	0.05	<0.01	14.8	1	0.07	0.02	0.44	0.5	0.07	44.2	1.4	0.09	104	<0.01	<0.05	<0.05	<0.1	<0.005
92227	YO608A	0.26	<0.01	9.5	1	0.11	0.46	0.25	0.48	0.36	85	1.5	0.2	157	0.02	<0.05	<0.05	<0.1	<0.005

Sample Number	Sample Description	K %	La ppm	Li ppm	Mg %	Mn ppm	Mo ppm	Na %	Nb ppm	Ni ppm	P ppm	Pb ppm	Rb ppm	Re ppm	S %	Sb ppm	Sc ppm	Se ppm	Sn ppm
92226	YO607A	<0.01	<0.5	0.4	12.7	681	2.14	0.01	0.1	873	<10	20.5	0.4	0.008	0.05	0.13	0.1	<0.5	<0.2
92227	YO608A	0.05	1	6.6	12.6	771	1.5	0.07	0.1	2170	13	41.1	2.2	0.005	0.05	0.46	0.2	<0.5	<0.2

Sample Number	Sample Description	Sr ppm	Ta ppm	Te ppm	Th ppm	Ti %	Tl ppm	U ppm	V ppm	W ppm	Y ppm	Zn ppm	Zr ppm
92226	YO607A	16.1	0.21	0.02	<0.1	<0.01	<0.01	0.028	4.5	6.7	<0.1	54.6	<0.5
92227	YO608A	18.5	0.15	0.01	<0.1	<0.01	<0.01	0.079	6.5	3.4	1.6	58.1	<0.5

Lithium Borate Fusion - Summation of Oxides, XRF finish (FULLY CALCINED PRODUCT)

Sample Number	Sample Description	Al ₂ O ₃ %	BaO %	CaO %	Cr ₂ O ₃ %	Fe ₂ O ₃ %	K ₂ O %	MgO %	MnO %	Na ₂ O %	P ₂ O ₅ %	SiO ₂ %	TiO ₂ %	SrO %	LOI %	Total %
92226	YO607A	<0.01	<0.01	0.952	<0.01	0.024	0.036	99.173	0.207	<0.01	<.01	0.119	<0.01	<0.01	-	101
92227	YO608A	<0.01	<0.01	0.52	<0.01	0.144	0.076	99.247	0	0.085	<0.01	0.084	<0.01	<0.01	-	100

Appendix K

Particle Size Analysis (PSA)

- 1) PSA on Grinded Head Material (P80 = 183 μm)**
- 2) PSA on Grinded Head Material (P80 = 95 μm)**
- 3) PSA on Grinded Head Material (P80 = 59 μm)**
- 4) PSA on Grinded Head Material (P80 = 228 μm)**



PARTICLE SIZE ANALYSIS

Client: West High Yield Resources

Test: YO101

Sample: WHY samples received Oct 5 2011
15 min grind

Date: 10-Nov-11

Project: MS1358

Sieve Size		Weight		Cummulative (%)	
US Mesh	Microns	(g)	(%)	Retained	Passing
8	2,360	0.0			
10	2,000	0.0			
16	1,180	0.0			
20	850	0.0			
30	600	0.0			
40	425	0.0			
50	300	4.0	3.80	3.80	96.20
70	212	12.6	11.98	15.78	84.22
100	150	14.8	14.07	29.85	70.15
140	106	10.8	10.27	40.11	59.89
200	75	8.2	7.79	47.91	52.09
270	53	8.7	8.27	56.18	43.82
400	37	6.3	5.99	62.17	37.83
Undersize	-37	39.8	37.83	100.00	
TOTAL:		105.2	100.0		

Rosin-Rammler Model

Size (um)	Passing P (%)
183	80
68	50

Linear Interpolation

Size (um)	Passing P (%)
193	80
69	50

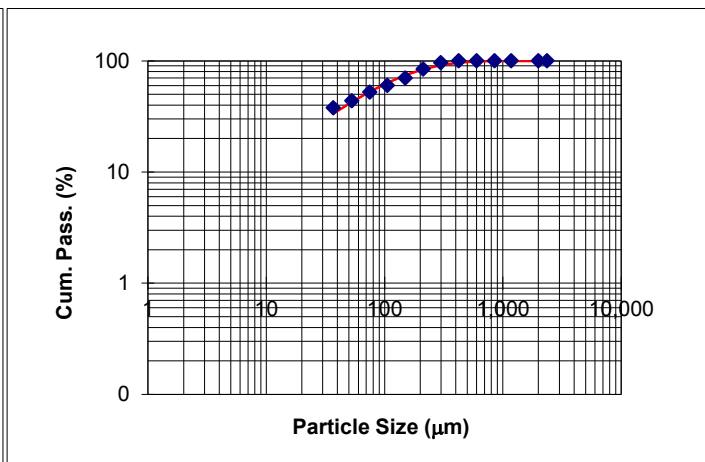
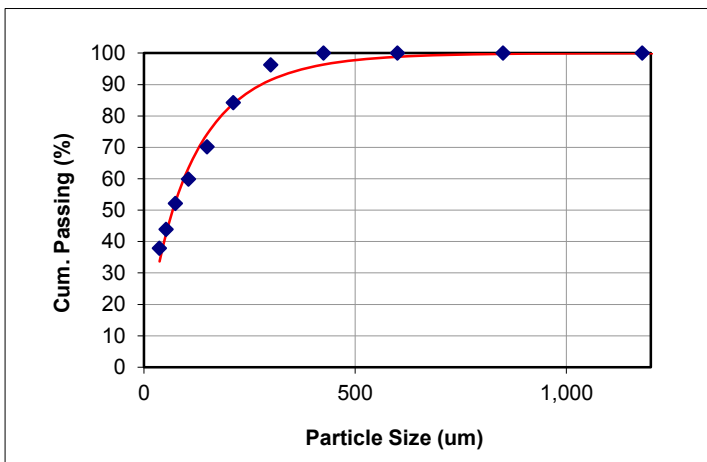



PARTICLE SIZE ANALYSIS

Client: West High Yield Resources

Test: YO201

Sample: WHY samples received Oct 5 2011
25 min grind

Date: 14-Nov-11

Project: MS1358

Sieve Size		Weight		Cummulative (%)	
US Mesh	Microns	(g)	(%)	Retained	Passing
8	2,360	0.0			
10	2,000	0.0			
16	1,180	0.0			
20	850	0.0			
30	600	0.0			
40	425	0.0			
50	300	0.0			
70	212	1.3	0.98	0.98	99.02
100	150	7.3	5.48	6.46	93.54
140	106	14.8	11.11	17.57	82.43
200	75	16.7	12.54	30.11	69.89
270	53	14.6	10.96	41.07	58.93
400	37	12.9	9.68	50.75	49.25
Undersize	-37	65.6	49.25	100.00	
TOTAL:		133.2	100.0		

Size (um)	Passing P (%)
95	80
40	50

Size (um)	Passing P (%)
100	80
38	50

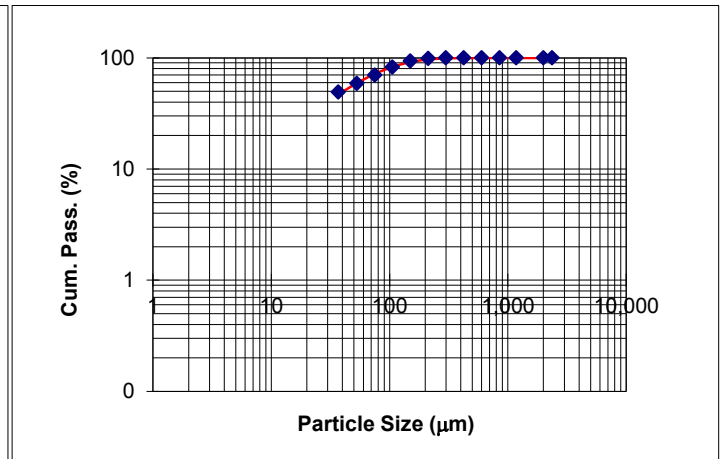
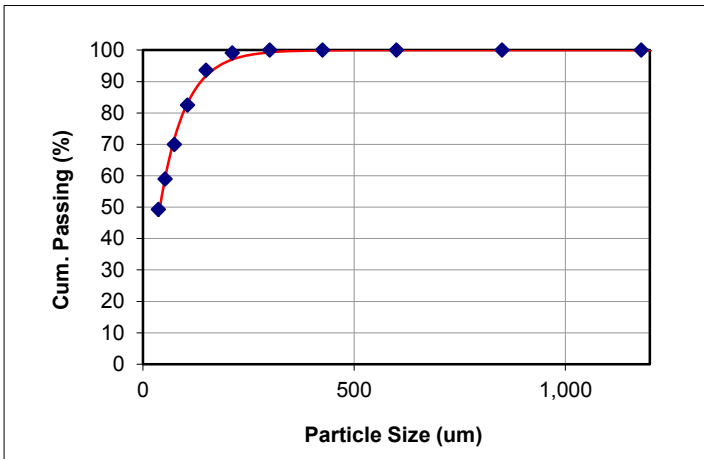



PARTICLE SIZE ANALYSIS

Client: West High Yield Resources

Test: YO301

Sample: WHY samples received Oct 5 2011
41 min grind

Date: 15-Nov-11

Project: MS1358

Sieve Size		Weight		Cummulative (%)	
US Mesh	Microns	(g)	(%)	Retained	Passing
8	2,360	0.0			
10	2,000	0.0			
16	1,180	0.0			
20	850	0.0			
30	600	0.0			
40	425	0.0			
50	300	0.0			
70	212	0.0			
100	150	0.7	0.42	0.42	99.58
140	106	4.7	2.81	3.23	96.77
200	75	14.8	8.85	12.07	87.93
270	53	21.2	12.67	24.75	75.25
400	37	24.4	14.58	39.33	60.67
Undersize	-37	101.5	60.67	100.00	
TOTAL:		167.3	100.0		

Rosin-Rammler Model

Size (um)	Passing P (%)
59	80
29	50

Linear Interpolation

Size (um)	Passing P (%)
61	80
24	50

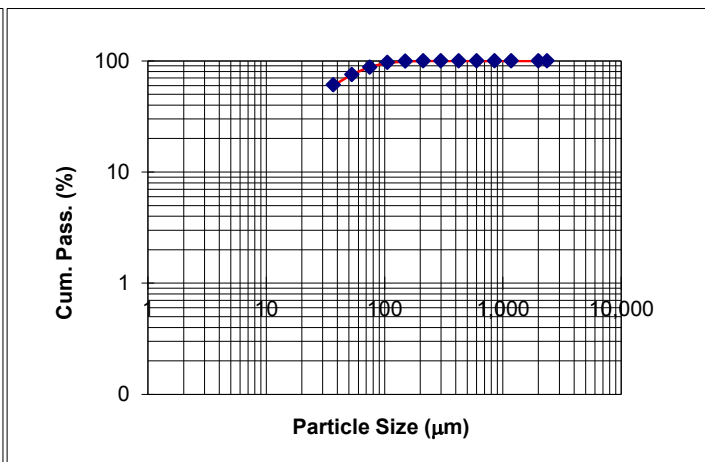
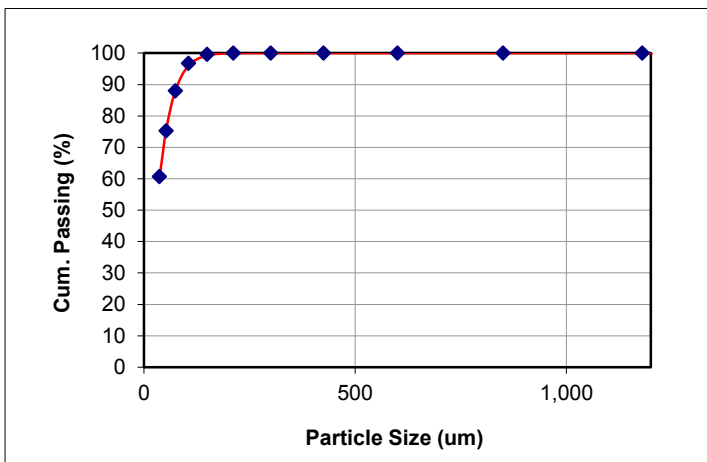



PARTICLE SIZE ANALYSIS

Client: West High Yield Resources
Test: 14min Grind PSA YO400
Sample: WHY Head (Fine Crushed)
 10 kg sample

Date: 20-Mar-12
Project: MS1358

Sieve Size		Weight		Cumulative (%)	
US Mesh	Microns	(g)	(%)	Retained	Passing
8	2,360	0.0			
10	2,000	0.0			
16	1,180	0.0			
20	850	0.0			
30	600	0.0			
40	425	1.7	1.29	1.29	98.71
50	300	12.9	9.78	11.07	88.93
70	212	18.6	14.10	25.17	74.83
100	150	14.6	11.07	36.24	63.76
140	106	11.1	8.42	44.66	55.34
200	75	9.8	7.43	52.08	47.92
270	53	7.8	5.91	58.00	42.00
400	37	9.2	6.97	64.97	35.03
Undersize	-37	46.2	35.03	100.00	
TOTAL:		131.9	100.0		

Size (um)	Passing P (%)
228	80
80	50

Size (um)	Passing P (%)
244	80
84	50

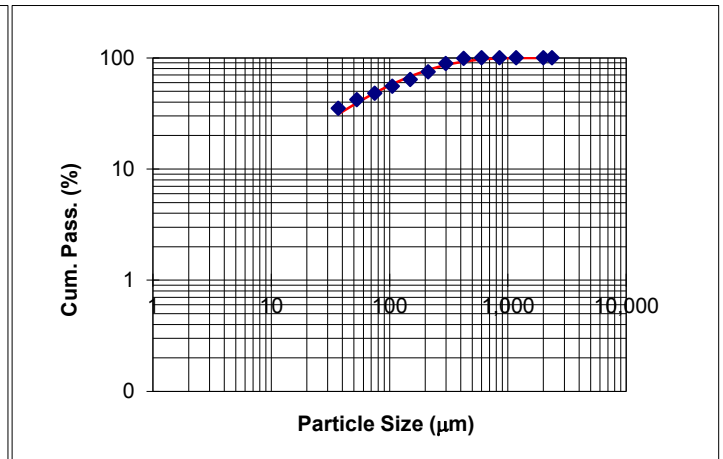
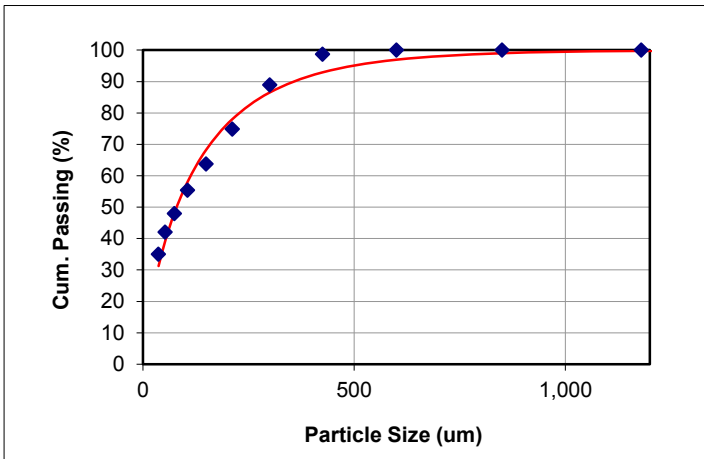

Appendix L

Ferrous Test Work Procedure

Determination of Ferrous Concentration in an Acidified Ferric/Ferrous Solution

Purpose: To determine the Ferrous content in a catholyte product containing mixture of Ferric and Ferrous chlorides and hydrochloric acid by using a redox titration with an internal indicator. Ceric sulphate is used to selectively oxidize the Ferrous component to Ferric with N-Phenylanthranilic acid as the internal redox indicator.

Reagents:

1. 0.1 N Standard Ceric sulphate solution
2. 0.1% w/w N-Phenylanthranilic acid indicator solution

Apparatus:

1. Burette, 50 ml
2. Pipette, 5 ml
3. Erlenmeyer flask, 250 ml
4. Analytical balance, +/- 0.1 mg
5. Plastic beaker, 50 ml

Procedure:

1. Pipette 5 mls of catholyte sample solution and weigh on an analytical balance to the nearest 0.1 mg using a 50 ml plastic beaker.
2. Quantitatively transfer the content into a 250 ml Erlenmeyer flask containing approximately 50 mls of demineralized water.
3. Add 1 to 2 mls of 0.1% N-Phenylanthranilic acid indicator solution to the mixture.
4. Titrate with 0.1 N standard Ceric sulphate solution from a light greenish-yellow to dark wine colour end point. Titre "A" mls.

Calculations:

$$\text{Ferrous Conc (wt \%)} = \frac{\text{Titre 'A' (mls)} \times \text{Normality of Ceric Sulphate} \times \text{Equivalent Wt of Ferrous} \times 100}{\text{Sample Wt. (g)}}$$

$$\text{Ferrous Concentration (wt\%)} = \frac{\text{Titre 'A' x 0.5585}}{\text{Sample Wt. (g)}}$$

Appendix M

Bond Ball Work Index

SGS Minerals Services

Standard Bond Ball Mill Grindability Test

Project No.: 50203-001 Date: 22-Nov-11
 Sample: MS 1358

Purpose: To determine the ball mill grindability of the sample in terms of a Bond work index number.

Procedure: The equipment and procedure duplicate the Bond method for determining ball mill work indices.

Test Conditions: Feed 100% Passing 6 mesh
 Mesh of grind: 100 mesh
 Test feed weight (700 mL): 1,204 grams
 Equivalent to : 1,721 kg/m³ at Minus 6 mesh
 Weight % of the undersize material in the ball mill feed: 4.8%
 Weight of undersize product for 250% circulating load: 344 grams

Results: Gram per Rev Average for the Last Three Stages = **0.94 g**
 Circulation load = **251%**

CALCULATION OF A BOND WORK INDEX

$$BWI = \frac{44.5}{P_1^{0.23} \times Grp^{0.82} \times \left\{ \frac{10}{\sqrt{P}} - \frac{10}{\sqrt{F}} \right\}}$$

P₁ = 100% passing size of the product 150 microns
 Grp = Grams per revolution 0.94 grams
 P₈₀ = 80% passing size of product 111 microns
 F₈₀ = 80% passing size of the feed 2,701 microns

BWI = **19.6 kWh/t** (imperial)

BWI = **21.6 kWh/t** (metric)

Comments:

Stage No.	# of Revs	New Feed (grams)	Product in Feed (grams)	Material to Be Ground (grams)	Material Passing 100 mesh in Product (grams)	Material Ground Per Mill Rev (grams)
1	100	1,204	58	286	165	1.07
2	314	165	8	336	269	0.83
3	398	269	13	331	367	0.89
4	367	367	18	326	366	0.95
5	344	366	18	326	337	0.93
6	353	337	16	328	350	0.95
7	346	350	17	327	344	0.94
Average for Last Three Stages =					344 g	0.94 g

SGS Minerals Services

Standard Bond Ball Mill Grindability Test

Project No.: 50203-001
 Sample: MS 1358

Date: 22-Nov-11

Feed Particle Size Analysis

Mesh	Size µm	Weight grams	% Retained		% Passing		
			Individual	Cumulative	Cumulative		
6	3,360	0.00	0.00	0.00	100.0		
7	2,800	49.2	15.5	15.5	84.5		
8	2,360	61.9	19.5	34.9	65.1		
10	1,700	72.1	22.7	57.6	42.4		
14	1,180	46.2	14.5	72.1	27.9		
20	850	23.0	7.23	79.3	20.7		
28	600	17.0	5.34	84.7	15.3		
35	425	12.8	4.02	88.7	11.3		
48	300	9.10	2.86	91.6	8.43		
65	212	6.20	1.95	93.5	6.48		
100	150	5.20	1.63	95.2	4.84		
115	125						
150	106						
200	75						
270	53						
400	38						
Pan	-	15.4	4.8	100.0	-		
Total	-	318.1	100.0	F₈₀: 2,701	154.5	100.0	P₈₀: 111

Product Particle Size Analysis

Weight grams	% Retained		% Passing
	Individual	Cumulative	Cumulative
0.00	0.00	0.00	100.0
0.00	0.00	0.00	100.0
22.0	14.2	14.2	85.8
12.6	8.16	22.4	77.6
25.4	16.4	38.8	61.2
17.9	11.6	50.4	49.6
13.2	8.54	59.0	41.0
63.4	41.0	100.0	-

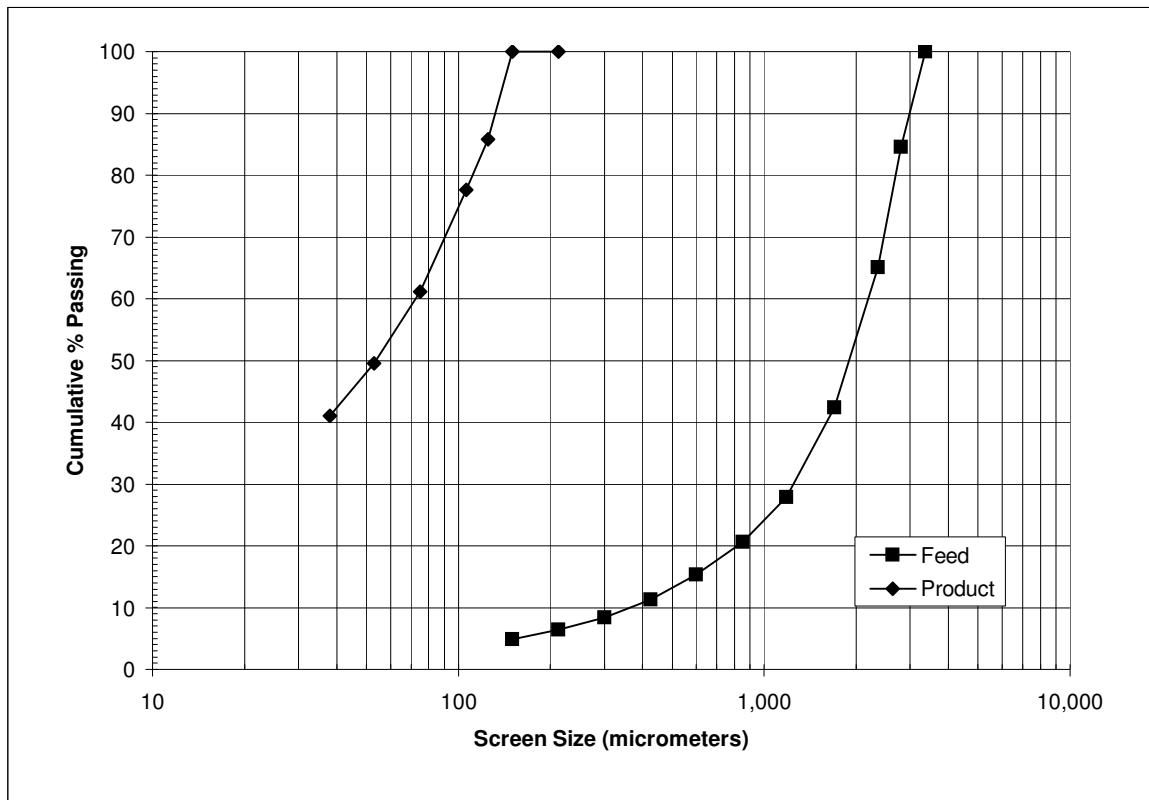

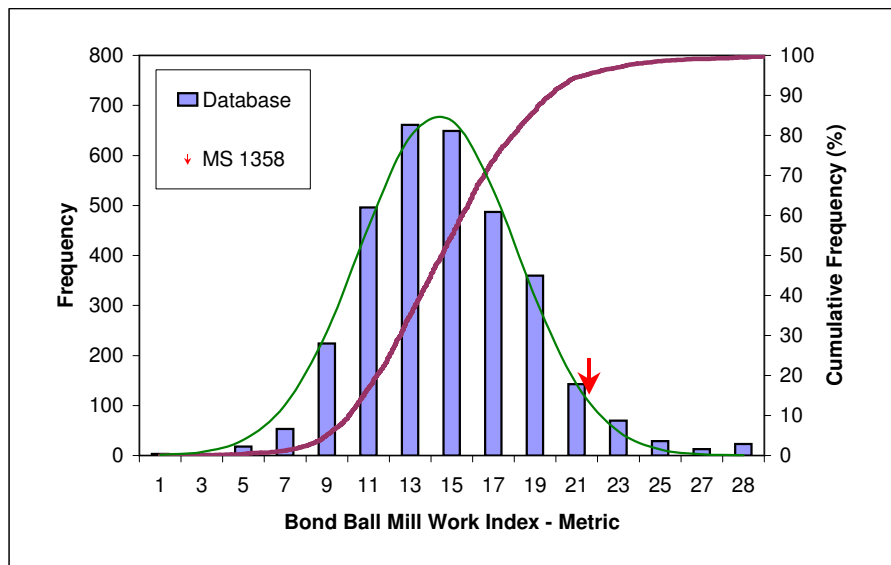
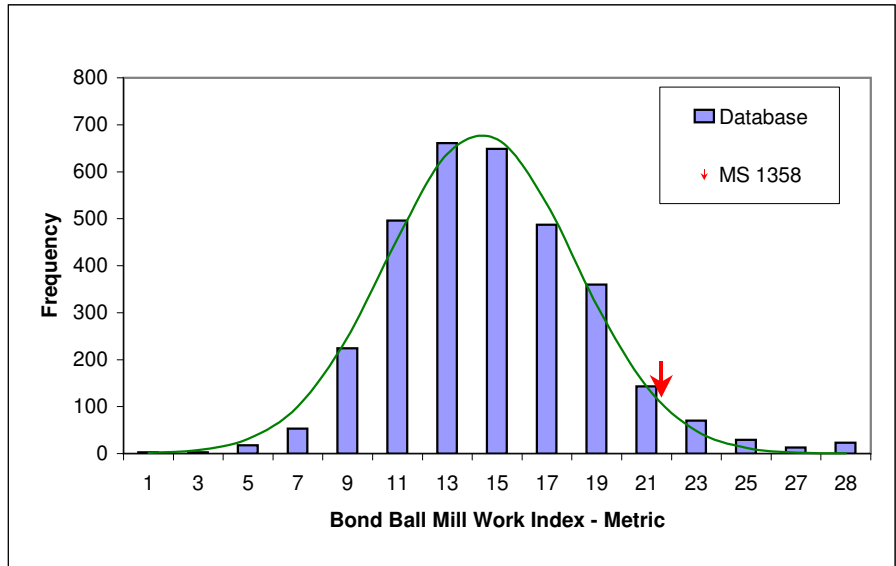

Appendix C: West High Yield Resources; Supplemental Process Development Test Work, Met-Solve, April 18, 2013

West High Yield Resources

Supplemental Process Development Test Work

Prepared for: West High Yield Resources
P.O Box 68121
Calgary, Alberta
Canada T3G 3N8
Ph. 403.283-5555
Fax. 403.206-7159
Attn: Frank Marasco

Prepared by: Met-Solve Laboratories Inc.
101B – 9850 – 201 Street
Langley, BC
V1M 4A3
Canada

Project Number: MS1358

Wilhelm Tse, B.A.Sc.
Metallurgist
wilhelm@met-sovelabs.com

Ish Grewal, M.A.Sc. P.Eng
President
ish@met-sovelabs.com

April 18, 2013

Note: This report refers to the samples as received. The information contained in this report is provided 'as is' without warranty of any kind with respect to the interpretation and use of the data by the client.

TABLE OF CONTENTS

1.0 BACKGROUND	1
2.0 OVERVIEW	2
3.0 PROCEDURES AND RESULTS	4
3.1 SAMPLE DESCRIPTION AND PREPARATION.....	4
3.2 LEACHING.....	5
3.3 IRON HYDROLYSIS AND SLURRY NEUTRALIZATION	7
3.4 SLURRY NEUTRALIZATION	8
3.5 CARBONATE PRECIPITATION.....	9
3.6 CALCINATION.....	11
4.0 SUMMARY.....	12
5.0 POTENTIAL OPTIMIZATION TEST WORK.....	18

1.0 BACKGROUND

Met-Solve Laboratories Inc. was contracted by WHY Resources to conduct test work to evaluate the potential of using a hydrometallurgical process to extract the magnesium and convert it to a marketable product.

The fundamental work done for this project was completed and reported previously in the Final Report dated October 1st, 2012. This report is referred to as the “Previous Report” herein.

Based on a review of the previous findings, the client requested additional test work to improve the overall magnesium extraction.

Additional test work, presented herein, was done utilizing conditions that showed the highest probability for improving overall magnesium extraction and recovery.

2.0 OVERVIEW

The current test program was completed to demonstrate the feasibility and repeatability of improved magnesium leach recovery throughout the overall process flow sheet (including slurry neutralization, carbonate precipitation and calcination) as seen in **Figure 1**.

Based on the Previous Report (Section 2.4: Acid Leach Tests Under More Intensive Conditions), leaching at an elevated temperature and increased pulp density were determined to be the most effective variables in achieving leach recoveries exceeding 70%.

The WHY material was tested under the following parameters:

Test #	Description	P ₈₀ (µm)	Temperature	Pulp Density	Slurry Neutralization Method	Reagent Addition	Final pH
YO607/YO608 (Previous Test Work)	1:1 H ₂ SO ₄ leach @ 20% pulp density for 30 min w/ MgO addition for neutralization	228	Ambient	20%	MgO Addition	174 kg MgO/tonne-feed	3.78 - 5.61
YO901a	1:1 H ₂ SO ₄ leach @ 25% pulp density for 60 min w/ MgO addition for neutralization	53	~70°C	25%	MgO Addition	67 kg MgO/tonne-feed	5.64
YO901b	1:1 H ₂ SO ₄ leach @ 25% pulp density for 60 min (Leach test only)	53	~70°C	25%	<i>Duplicate test of leach stage only</i>		N/A
YO902a	1:1 H ₂ SO ₄ leach @ 25% pulp density for 60 min w/ MgO addition for neutralization	228	~70°C	25%	MgO Addition	81 kg MgO/tonne-feed	6.63
YO902b	1:1 H ₂ SO ₄ leach @ 25% pulp density for 60 min (Leach test only)	228	~70°C	25%	<i>Duplicate test of leach stage only</i>		N/A
YO903a	1:1 H ₂ SO ₄ leach @ 25% pulp density for 60 min w/ NaOH addition for neutralization	53	~70°C	25%	NaOH Addition	127 kg NaOH/tonne-feed	5.49

Tests YO901 – YO903 represent the supplementary test work that was completed for this test program. Tests YO607/YO608 were presented in the Previous Report and presented herein for comparison.

Test YO901a, YO902a and YO903a followed the overall process flow sheet presented in **Figure 1**.

Test YO901b and YO902b were repeat tests on the leach stage only to verify leach stage extractions.

Figure 1: Overall Process Flow Sheet

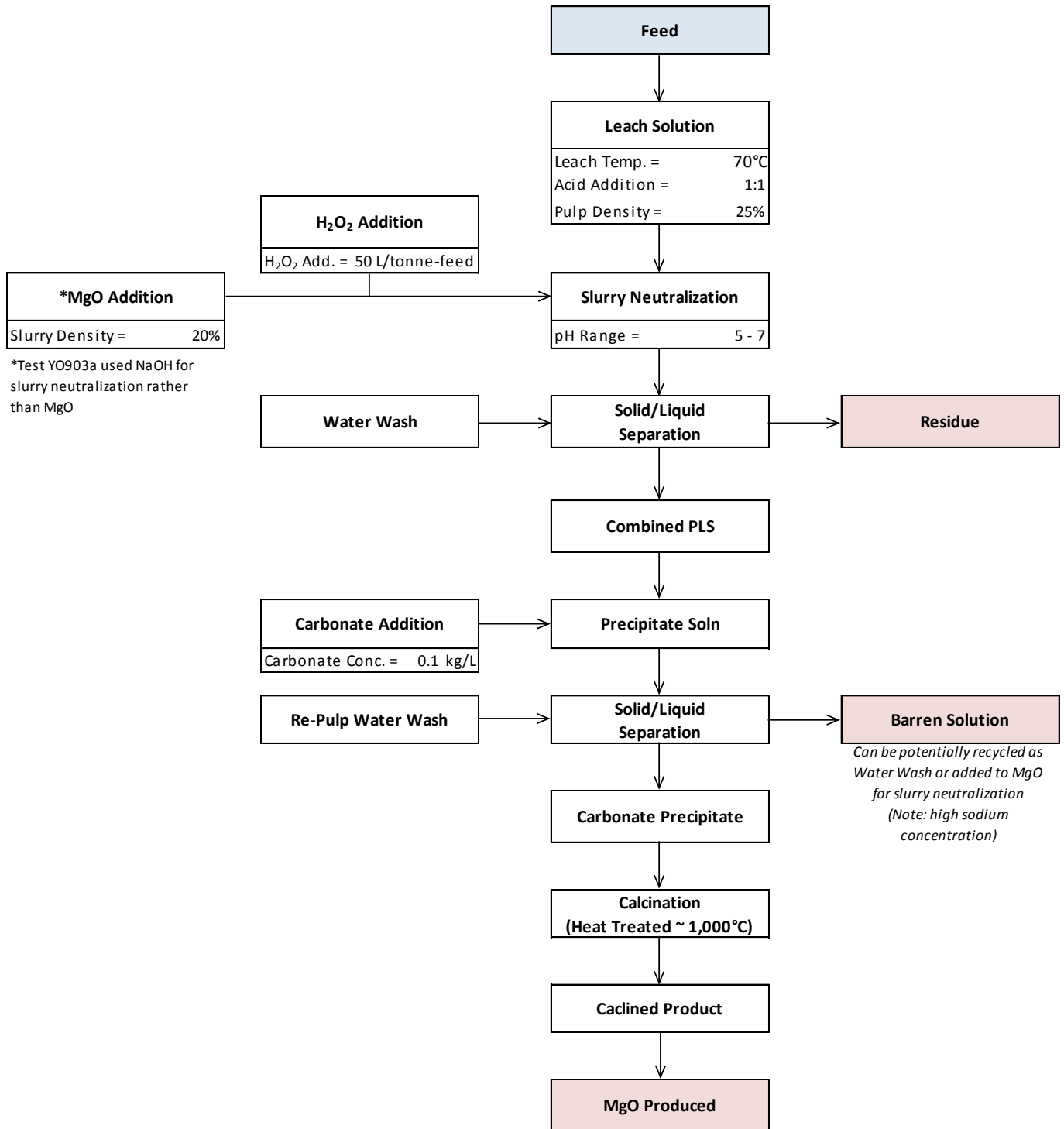

3.0 PROCEDURES AND RESULTS

3.1 SAMPLE DESCRIPTION AND PREPARATION

The samples were prepared in the same manner mentioned in Section 1.3 of the Previous Report. Two grind sizes of 228 μm and 53 μm were targeted for the current test work.

Previous test work (Previous Report, Section 2.3) demonstrated that finer particle size generated slightly improved magnesium leach recovery. The finer grind size testing was done as supplementary work to compare the magnesium leach recovery with the coarser grind size.

3.2 LEACHING

The leaching tests were conducted at a pulp density of 25% solids for a duration of one hour. A hot plate used to maintain the leach slurry above 70°C. Bottle-grade sulfuric acid (95 – 98% v/v) was added slowly while being stirred by an overhead agitator. Multiple re-pulp washes were done on the residue after leaching to ensure minimum magnesium entrainment.

The descriptions of each variable under the leach conditions for this test program are listed as follows:

Acid Addition: 1,000 kg H₂SO₄/tonne-ore

High acid addition was deemed to be one of the important variables in affecting recovery. When acid was added initially, the exothermic reaction causes the slurry to reach temperatures greater than 90°C.

Leach Temperature: Maintained above 70°C

Leaching at an elevated temperature was found to improve leach recovery in the previous test work. Due to the exothermic reaction during acid addition, external heating was used only to maintain temperature rather than to raise it.

Pulp Density: 25%

At higher pulp densities, the reduced water addition increases acid concentration and promotes higher leach recovery. Previous work also showed that leaching at a pulp density of 25% at an elevated temperature produced small saturated crystals in the residue but readily dissolved back into solution after re-pulp washes.

Acid Concentration: 3.93 M

At 1,000 kg/tonne-ore acid addition and a pulp density of 25%, the acid concentration of the leach was 3.93 M.

Leach Duration: 60 minutes

To ensure higher leach recovery, a slightly longer leach time was preferred for this test program. Previous test work done on the WHY sample indicated that the leach kinetics began to plateau after 30 minutes (Previous Report, Section 2.5).

The results of the leach tests are presented in **Table 1**.

Table 1: Acid Leach Test Summary

Test #	P ₈₀ (µm)	Mg Leach Recovery (%)	Assayed Feed Grade (%)	Calculated Feed Grade (%)	Leach Residue Grade (%)	Acid Consumption (%)
YO607/YO608 (Previous Test Work)	228	62.6	23.7	22.4	13.09	64.1
YO901a	53	86.0	23.7	24.5	6.6	N/A
YO901b	53	86.9	23.7	26.7	6.5	92.0
YO902a	228	80.5	23.7	24.3	8.1	N/A
YO902b	228	84.3	23.7	24.2	6.7	90.8
YO903a	53	81.2	23.7	23.5	7.0	N/A

The results show that greater than 80% magnesium leach recovery was achievable and repeatable under the current leach conditions. Leaching at a finer grind size had similar or slightly improved leach extractions.

Greater than 90% of the acid was consumed during leaching which resulted in a reduced amount of reagent required for slurry neutralization. This is higher than the previous test work which only achieved 64.1% acid consumption.

Thorough washing of the residue was necessary to ensure entrained magnesium was recovered. Due to the high concentration of acid during leaching, saturated crystals were observed to be embedded in the residue after leaching. Performing re-pulp washes was significant in ensuring any entrained magnesium was recovered. However, solid-liquid separation of the pregnant leach solution from the residue was relatively slow.

3.3 IRON HYDROLYSIS AND SLURRY NEUTRALIZATION

The complete overall flow sheet presented in **Figure 1** was done on Tests YO901a, YO902a and YO903a. These tests proceeded to iron precipitation, slurry neutralization, carbonate addition and calcination after leaching.

Iron precipitation was performed on the leach slurry since previous testing revealed that iron impurities were also leached into solution. Of the iron present in solution, 23% iron was determined to be in the ferrous form (Section 2.8 in Previous Report). Hydrogen peroxide was added to oxidize ferrous to ferric to improve impurity removal during solid-liquid separation. The amount of hydrogen peroxide required was determined by observing the ORP spike and stabilization. It was found that 50 L H₂O₂/tonne-ore was an ideal amount required for iron hydrolysis. Further testing could be done to determine the optimal amount of hydrogen peroxide required.

Adding hydrogen peroxide into the slurry slightly raised the temperature and created a thick froth. Hydrogen peroxide was added slowly to ensure that the froth would not spill over the edge of the leaching reactor.

Performing iron hydrolysis was also observed to improve solid-liquid separation kinetics.

3.4 SLURRY NEUTRALIZATION

Slurry neutralization was required to consume the remaining free acid and increase the pH for iron precipitation. A pH ≥ 4 was determined to successfully precipitate out iron from the leach slurry (Previous Report, Section 2.9).

A 20% (w/w) MgO slurry was used to neutralize the leach slurry for Tests YO901a and YO902a.

A solution of NaOH (5.0 M) was used to neutralize the leach slurry for Test YO903a.

The method for slurry neutralization and the amount of reagents used are presented in **Table 2**.

Table 2: Slurry Neutralization Summary

Test #	P ₈₀ (µm)	Temperature	Pulp Density	Slurry			Potential MgO Recycled
				Neutralization Method	Reagent Addition	Final pH	
YO607/YO608 (Previous Test Work)	228	Ambient	20%	MgO Addition	174 kg MgO/tonne-feed	3.78 - 5.61	53%
YO901a	53	~70°C	25%	MgO Addition	67 kg MgO/tonne-feed	5.64	26%
YO902a	228	~70°C	25%	MgO Addition	81 kg MgO/tonne-feed	6.63	30%
YO903a	53	~70°C	25%	NaOH Addition	127 kg NaOH/tonne-feed	5.49	N/A

Compared to the previous test work (Test YO607/YO608), the potential MgO recycled for slurry neutralization was lowered to 26% - 30% due to higher acid consumption. Since more acid was consumed ($\geq 90\%$ compared to 64.1%, **Table 1**), a lower amount of reagent was required for neutralization.

Test YO903a suggests that NaOH can also be used to neutralize slurry without the use of MgO addition. The overall results show that using NaOH for neutralization reduced the amount of magnesium reporting to the barren solution stream.

3.5 CARBONATE PRECIPITATION

Sodium carbonate solution (100 g/L) was added to the combined pregnant leach solution to precipitate the Mg ions into a MgCO_3 precipitate. The formation of the precipitate was fast and was visually observable to be forming in the leach solution. Sodium carbonate was added until no visible magnesium carbonate precipitate formed. The precipitate was filtered, dried and a representative sample was sent for assay. The spent solution after filtration was labeled as “barren solution”.

A comparison of the sodium carbonate addition is presented in **Table 3**.

Table 3: Sodium Carbonate Addition Summary

Test #	Carbonate Addition (required based on stoich.)	Carbonate Addition (actually added)
YO607/YO608	1,063 kg/tonne-feed	1,264 kg/tonne-feed
YO901a	1,036 kg/tonne-feed	845 kg/tonne-feed
YO902a	1,024 kg/tonne-feed	845 kg/tonne-feed
YO903a	839 kg/tonne-feed	770 kg/tonne-feed

The amount of sodium carbonate added in the previous Previous Report (YO607/YO608) was also determined visually, however, excess carbonate was added to ensure complete carbonate precipitation.

Due to the large excess of reagent used in the previous test work (YO607/YO608), the amount of sodium carbonate added in the supplementary test work was stopped immediately once carbonate precipitates were not seen forming in the leach solution. Therefore, the amount of carbonate added for Tests YO901a – YO903a are much lower and did not reach the stoichiometric amount required. The amount of MgCO_3 precipitate (associated with MgO) produced from these tests might also not have reached its maximum.

For these tests, crystals were not seen forming in the barren solution (unlike the previous tests, YO607/YO608).

Test YO903a required less sodium carbonate for precipitation because no additional magnesium ions were added into the leach solution during slurry neutralization. NaOH was used for slurry neutralization in Test YO903a instead of MgO. Since less magnesium ions were in solution, less carbonate was required for precipitation.

For all of the supplementary tests (YO901a – YO903a), precipitate was seen forming in the barren solution after one or two days. This suggests that there may be some conditions that may be inhibiting precipitation kinetics. Further testing, such as modifying the pH and/or temperature of the barren solution, could improve precipitation kinetics and reduce the amount of magnesium in the barren stream.

Re-pulp washes were done on the carbonate precipitate. Effective washing of the carbonate precipitate was an important factor in producing high grade MgO. Further optimization on washing the carbonate precipitate will ensure a higher quality MgO product.

The solid-liquid separation (filtration) of the barren solution from the magnesium carbonate precipitate was fast.

3.6 CALCINATION

The magnesium carbonate precipitate was dried in an oven at temperatures of 100°C overnight prior to calcination. A sub-sample from the dried carbonate precipitate was sent to an assay lab for a XRF - Whole Rock Analysis accompanied by a Loss on Ignition (LOI) analysis. The LOI furnace at the assay lab was reported to achieve ~1,000°C and served to calcine the carbonate precipitate to MgO. This MgO product was then re-assayed (XRF – Whole Rock Analysis) to obtain a MgO purity value, thus providing an accurate LOI and assay reading while minimizing air-borne impurities and moisture.

The assay results of the calcined product are summarized below.

Table 4: Calcined Product Summary

Test #	MgO Produced (kg MgO/tonne-feed)	MgO Purity (%)
YO607/YO608	*156	99.2
YO901a	*188	>99.7
YO902a	*193	97.7
YO903a	250	97.7

** MgO produced adjusted for the amount of MgO potentially recycled for slurry neutralization*

The main impurities retained in the calcined product are CaO, MnO, some compounds of sodium, silicon and sulfur. As mentioned in Section 3.5, the purity of the MgO product may be enhanced by effectively washing the magnesium carbonate precipitate prior to calcination.

The supplementary tests (YO901a and YO902a) produced more MgO product than the previous test work (Test YO607/YO608) due to increased leach recovery, higher acid utilization and reduced magnesium loss in barren solution.

Test YO903a produced the largest amount of MgO since the process flow sheet did not require the MgO product to be potentially recycled for slurry neutralization.

4.0 SUMMARY

Met-Solve Laboratories Inc. conducted supplementary test work to improve overall recovery of the magnesium product. This supplementary test work focused on improving recovery by leaching at an elevated temperature and higher pulp density. The process flow sheet for this test program is presented in **Figure 1**.

The differences between the five tests that were completed for this supplementary test program are presented below.

Test	P ₈₀ (µm)	Slurry Neutralization
YO901a	53	MgO Addition
YO901b (leach test only)	53	-
YO902a	228	MgO Addition
YO902b (leach test only)	228	-
YO903a	53	NaOH Addition

Based on previous leach test results, the following leach parameters were established for obtaining improved leach recoveries.

Table 5: Leach Conditions

Variables	Description	Reasons
Acid Addition	1,000 kg/tonne-feed	High acid addition was one of the most important and simpler option for increasing Mg extraction
Pulp Density	25%	Increase higher acid concentration for more efficient leaching (results in more acid consumed)
Leach Temperature	Maintained at 70°C	Leaching at elevated temperature provided a significant increase in leach recovery
Acid Concentration	3.93 M	Determined by pulp density
Leach Duration	60 minutes	Preferred leach duration to ensure complete leaching

Under the leach conditions of this supplementary test program, the leach results can be summarized by the following key points.

- Achieved greater than 80% magnesium leach recovery by leaching at an elevated temperature and higher pulp density (previous magnesium leach recovery was 62.6%)
- Leach results demonstrate consistency and repeatability
- Due to the exothermic reaction during acid addition, temperature only required to be maintained not raised
- Does not have to be leached at a finer grind size due to similar leach recoveries
- Reagent required for slurry neutralization was lowered due to higher acid consumption

Thorough washing of the leach residue was necessary to obtain high recovery. Due to the high concentration of the acid leach, proper washing ensures minimum magnesium entrainment in the residue. However, the solid-liquid separation of the pregnant leach solution from the residue was fairly slow.

Hydrogen peroxide addition was effective in converting the iron present in solution to ferric. It was found that 50 L H₂O₂/tonne-ore was an ideal amount required for iron hydrolysis.

Both methods of slurry neutralization (MgO addition and NaOH addition) were effective in consuming excess acid and precipitating iron impurities out of the leach solution. The summary regarding reagent addition summary and results are presented in **Table 6**.

Table 6: Test Work Summary

Test #	Avg. Mg Leach Rec. (%)	Slurry Neut. Method	Reagent Add. (kg/tonne-feed)	Final pH	Carbonate Add. (actually added)	MgO Produced (kg/tonne-feed)	MgO Purity(%)
*YO607/YO608	62.6	MgO Addition	174	3.78 - 5.61	1,264 kg/tonne-feed	**156	99.2
YO901	86.5	MgO Addition	67	5.64	845 kg/tonne-feed	**188	>99.7
YO902	82.4	MgO Addition	81	6.63	845 kg/tonne-feed	**193	97.7
YO903	81.2	NaOH Addition	127	5.49	770 kg/tonne-feed	250	97.7

* Results based on previous test work in Final Report

** MgO produced adjusted for the amount of MgO potentially recycled for slurry neutralization

MgO addition (Test YO901 and YO902) was the preferred method for slurry neutralization whereas NaOH addition (Test YO903) was done as a prospective alternative.

During slurry neutralization, a 20% MgO slurry (Test YO901 and YO902) or a 5.0 M NaOH solution (Test YO903) was added until pH was raised above 4.0. Due to the improved leach recovery, more free acid was consumed resulting in a reduced amount of reagent required for neutralization.

A 100 g/L solution of sodium carbonate (a.k.a. soda ash) was added to the pregnant leach solution to form a MgCO₃ precipitate. The amount of sodium carbonate added was significantly lower than the previous test work (YO607/YO608) since excess of reagent was not added during this stage. The addition of sodium carbonate was stopped immediately once carbonate precipitates were not seen forming in the leach solution.

Although insufficient sodium carbonate was added, the amount of MgO produced still surpassed previous test work results (YO607/YO608). This was mainly due to the increase in magnesium leach recovery. Test YO903 had the largest amount of MgO produced since the process flow sheet did not require the MgO produced to be potentially recycled for slurry neutralization.

Magnesium carbonate was seen to be forming in the barren solution one or two days after solid-liquid separation.

Overall, a MgO product greater than 97.7% purity was produced. A MgO product with purity greater than 99% was proven to be obtainable.

A process flow sheet developed to represent the test work of YO901a, YO902a and YO903a can be seen in **Figure 1, 2 and 3**.

A summary of the magnesium distribution for each test is presented below.

Table 7: Magnesium Distribution Summary

Test #	Mg Distribution				MgO Purity (%)
	Residue (%)	Barren Solution (%)	MgO (%)	TOTAL (%)	
YO607/YO608	41.3	18.9	39.8	100	99.2
YO901	16.8	35.5	47.7	100	>99.7
YO902	21.5	28.6	49.9	100	97.7
YO903	18.8	17.7	63.5	100	97.7

Please note that the calcined MgO product and barren solution was not actually recycled for the test work.

Figure 1: Process Flow Sheet of Test Work YO901 (P₈₀ = 53 μm, MgO Slurry Neutralization)

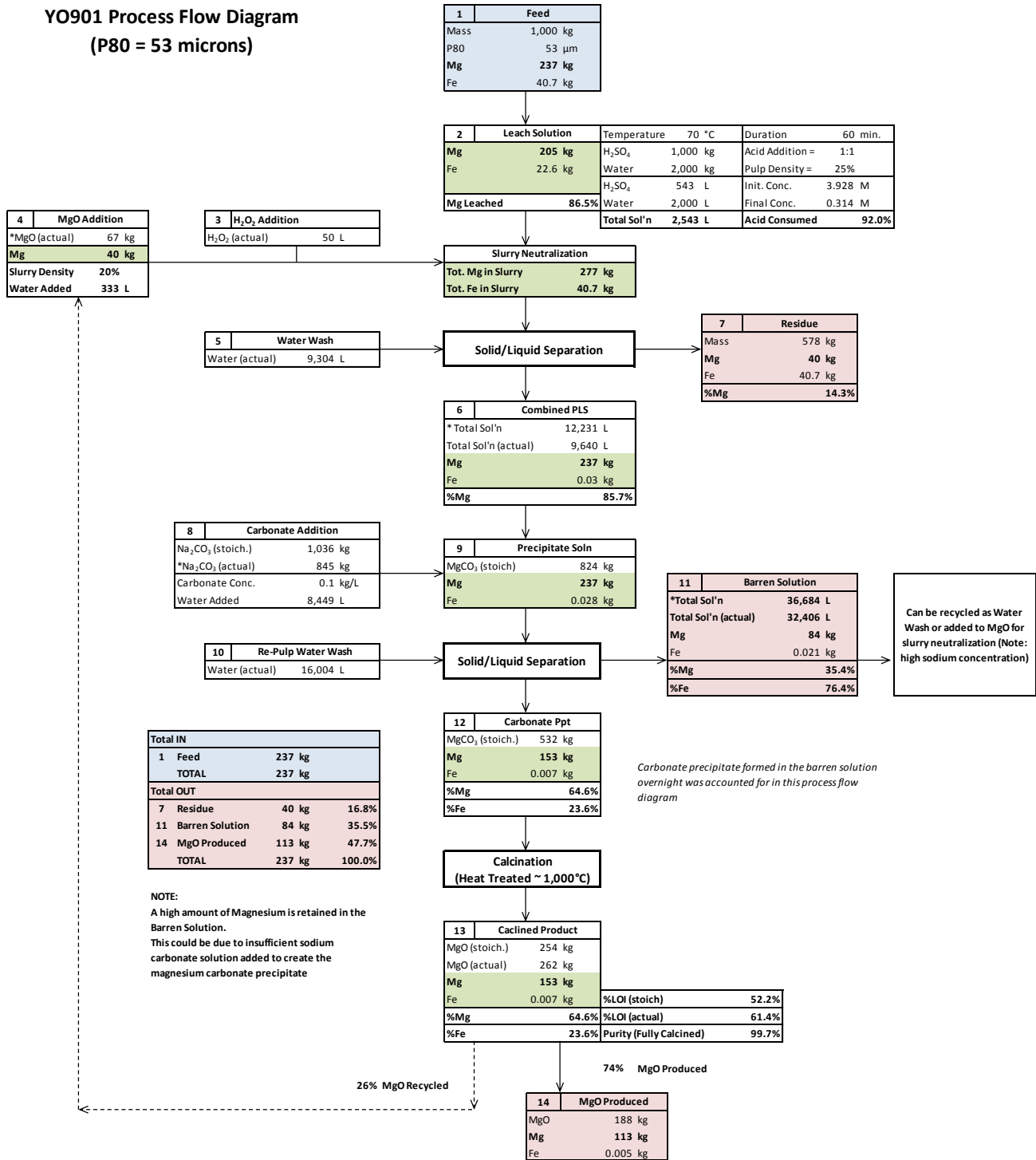

Assay for Fully Caclined Product (Assay from Test YO901a)

Al ₂ O ₃	BaO	CaO	Cr ₂ O ₃	Fe ₂ O ₃	K ₂ O	**MgO	MnO	Na ₂ O	P ₂ O ₅	SiO ₂	TiO ₂	SrO	V ₂ O ₅	Total
%	%	%	%	%	%	%	%	%	%	%	%	%	%	%
<0.01	<0.01	0.18	<0.01	<0.01	0.06	>99.7	0.03	<0	<0.01	<0.01	0.06	<0.01	<0.01	100

* Assuming no loss of solution during test work and no retained solution in residue (100% solid/liquid separation)

** Actual MgO assay was 100% purity, a normalized 99.7% purity was used for calculations

Figure 2: Process Flow Sheet of Test Work YO902 (P₈₀ = 228 μm, MgO Slurry Neutralization)

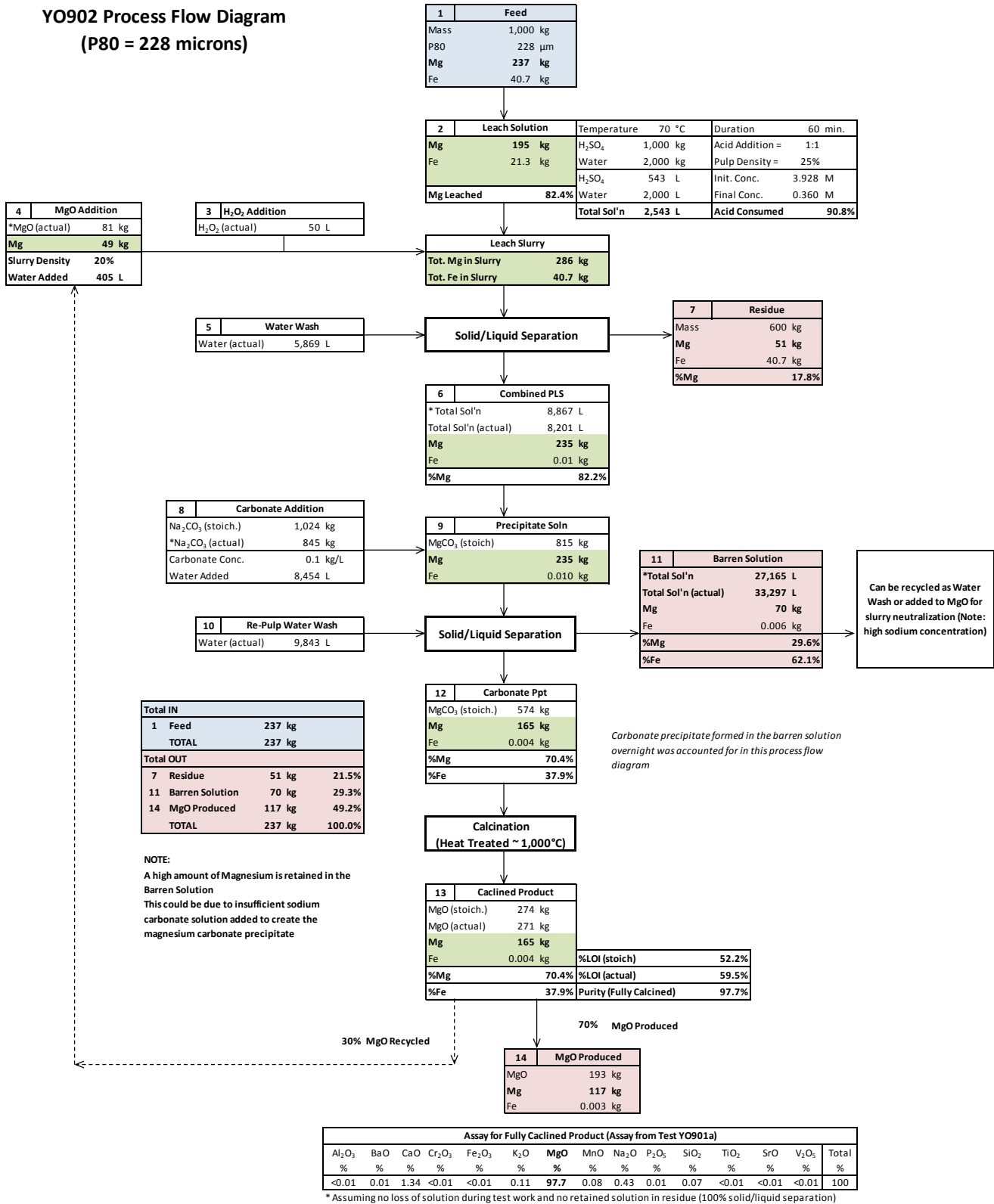
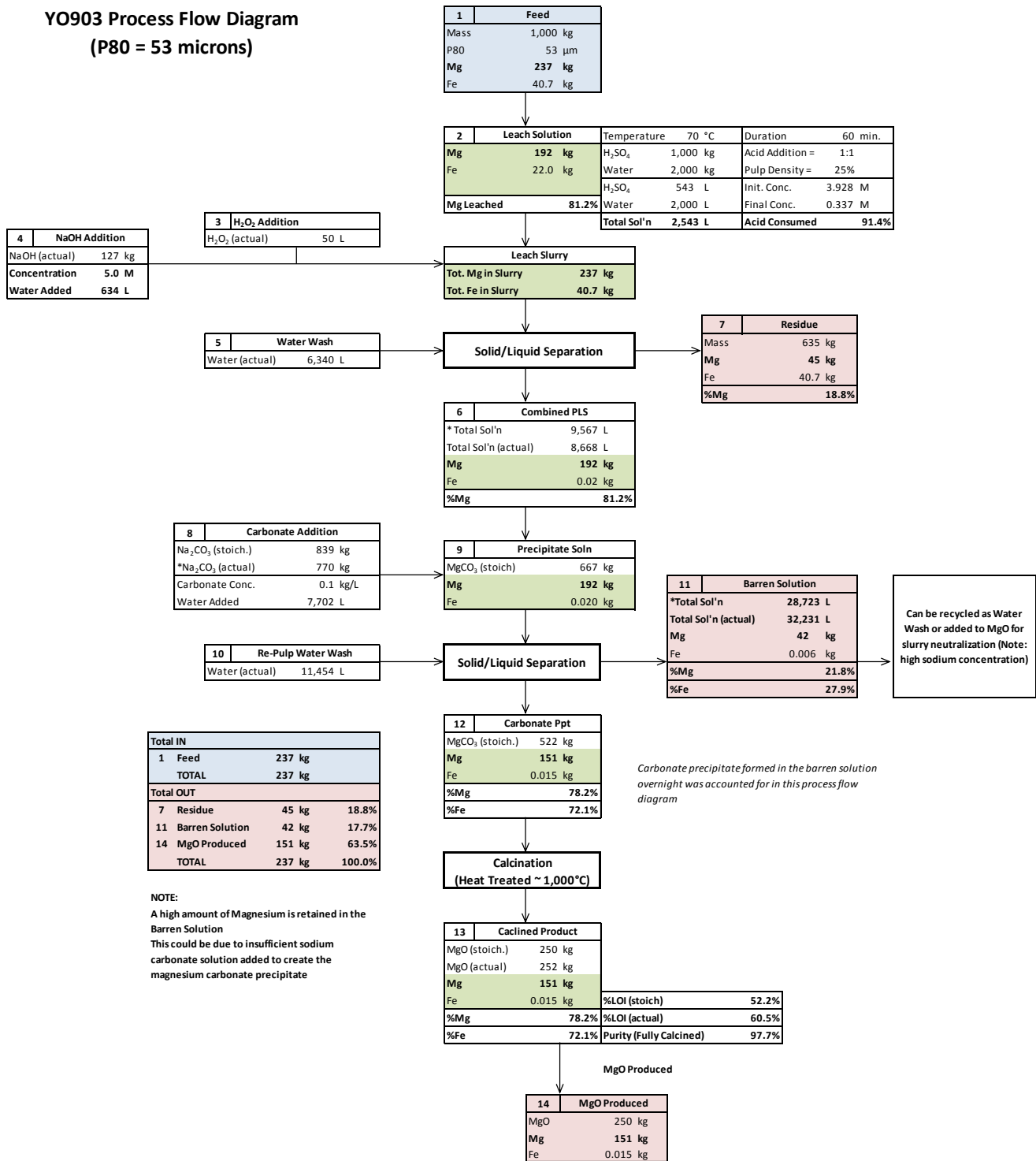

Figure 3: Process Flow Sheet of Test Work YO903 (P₈₀ = 53 μm, NaOH Slurry Neutralization)



Assay for Fully Caclined Product (Assay from Test YO901a)

Al ₂ O ₃	BaO	CaO	Cr ₂ O ₃	Fe ₂ O ₃	K ₂ O	MgO	MnO	Na ₂ O	P ₂ O ₅	SiO ₂	TiO ₂	SrO	V ₂ O ₅	Total
%	%	%	%	%	%	%	%	%	%	%	%	%	%	%
<0.01	<0.01	1.71	<0.01	0.05	0.02	97.7	0.33	<0	<0.01	0.26	0.01	<0.01	<0.01	100

* Assuming no loss of solution during test work and no retained solution in residue (100% solid/liquid separation)

5.0 POTENTIAL OPTIMIZATION TEST WORK

Further optimization on leach variables can be done to decrease potential costs in the overall process. Due to the hardness of the ore (21.6 kW/t), finding an optimum grind size that would not sacrifice leach recovery would be beneficial.

Scoping test work presented in the Previous Report has already determined various variables that affect leach recovery. Variables such as leach duration, temperature level, acid concentration or pulp density, have not yet been fully tested together, which could potentially lead to an even more efficient process.

All of the test work indicated that most of the magnesium was lost through the barren solution. Even though the barren solution is potentially recoverable in a close-circuit process, a study on the precipitation behavior of magnesium carbonate (such as response to varying pH in barren solution) could significantly improve overall recovery and provide a cleaner barren solution for recycling.

An alternate method for slurry neutralization was tested (Test YO903) by adding NaOH instead of MgO. The results from this test demonstrated that with a reasonable amount of NaOH, the slurry could easily be neutralized while reducing the amount of magnesium retained in the leach residue and barren solution. Without the need of recycling any MgO product, using NaOH could provide a potentially alternative approach to reduce magnesium losses to the barren solution stream.

Appendix

Appendix	Content
A	Process Flow Diagram of Test YO901 (P80 = 53 μm , MgO slurry neutralization)
B	Process Flow Diagram of Test YO902 (P80 = 228 μm , MgO slurry neutralization)
C	Process Flow Diagram of Test YO903 (P80 = 53 μm , NaOH slurry neutralization)
D	Process Flow Diagram of Test YO607/YO608 - Previous Test Work (P80 = 228 μm , MgO slurry neutralization)
E	Test YO901a and YO901b Mass Balance
F	Test YO902a and YO902b Mass Balance
G	Test YO903a Mass Balance
H	Assay Summary
I	Particle Size Analysis

Appendix A

Process Flow Diagram

Test YO901

(P80 = 53 microns, Slurry Neutralization Method: MgO)

Sample Description	ICP Au ppm	ICP Pd ppm	ICP Pt ppm	ICP Ag ppm	ICP Al %	ICP As ppm	ICP Ba ppm	ICP Bi ppm	ICP Ca %	ICP Cd ppm	ICP Co ppm	ICP Cr ppm	ICP Cu ppm	ICP Fe %	ICP Hg ppm	ICP K %
Head (P80 = 183 µm)				0.3	0.1	34	<10	3	0.46	<0.5	111	399	<1	3.72	<3	0.02
Head (P80 = 95 µm)				0.2	0.11	34	<10	<2	0.46	<0.5	113	480	8	4.08	<3	0.02
Head (P80 = 59 µm)	0.065	0.005	<0.005	0.2	0.11	30	<10	<2	0.46	<0.5	113	633	9	4.41	<3	0.02

Sample Description	ICP La ppm	ICP Mg %	ICP Mn ppm	ICP Mo ppm	ICP Na %	ICP Ni ppm	ICP P ppm	ICP Pb ppm	ICP Sb ppm	ICP Sc ppm	ICP Sr ppm	ICP Ti %	ICP Tl ppm	ICP V ppm	ICP W ppm	ICP Zn ppm	ICP Zr ppm
Head (P80 = 183 µm)	<2	24.0	762	2	<0.01	1747	23	<2	<2	5	37	<0.01	<10	6	<10	30	<2
Head (P80 = 95 µm)	<2	23.4	775	3	<0.01	1789	26	<2	<2	5	38	<0.01	<10	7	<10	32	<2
Head (P80 = 59 µm)	<2	23.7	787	4	<0.01	1809	47	3	<2	5	38	<0.01	<10	8	<10	29	<2

YO901 Process Flow Diagram (P80 = 53 microns)

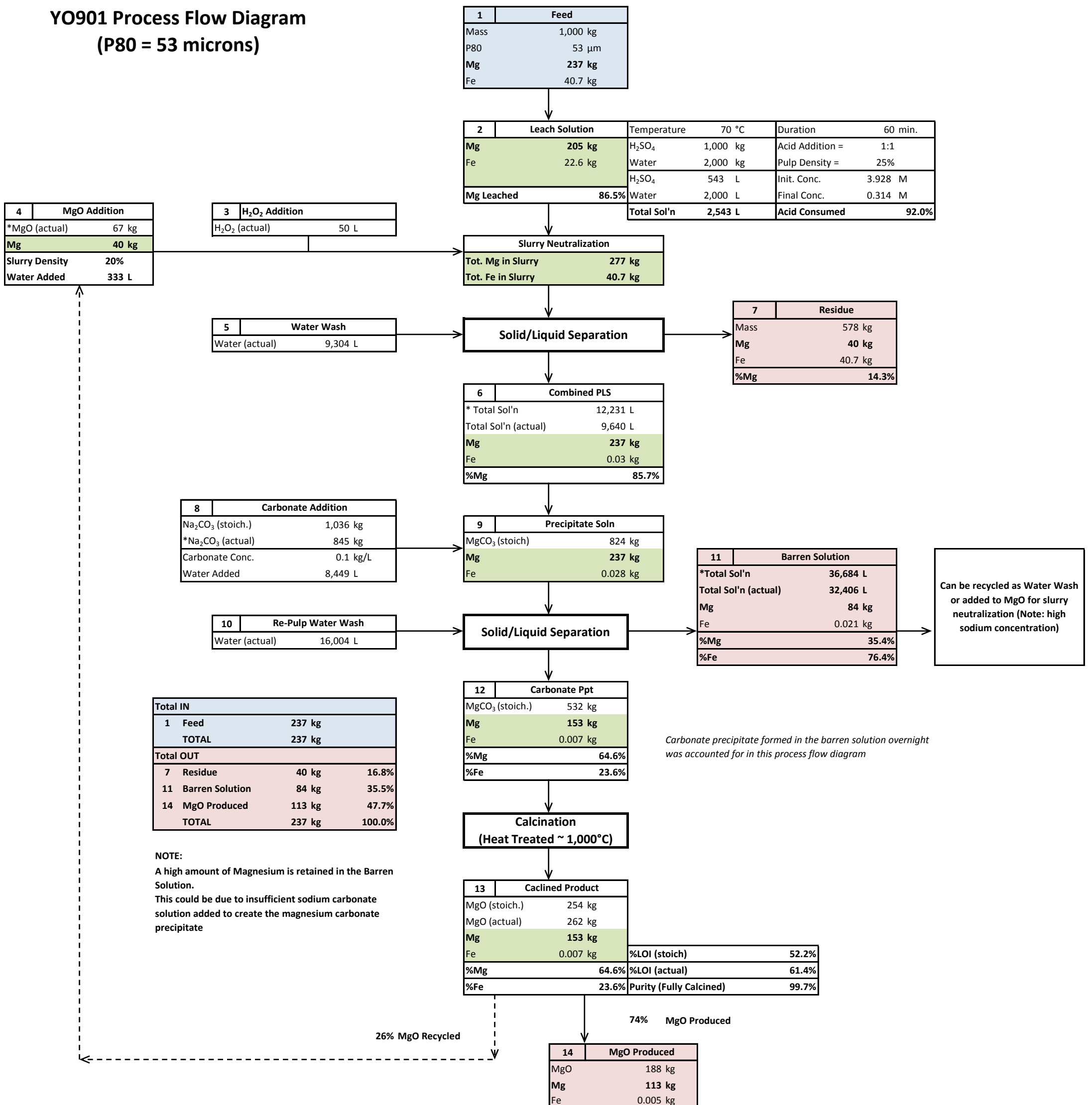

Al ₂ O ₃	BaO	CaO	Cr ₂ O ₃	Fe ₂ O ₃	K ₂ O	**MgO	MnO	Na ₂ O	P ₂ O ₅	SiO ₂	TiO ₂	SrO	V ₂ O ₅	Total
<0.01	<0.01	0.18	<0.01	<0.01	0.06	>99.7	0.03	<0.01	<0.01	<0.01	0.06	<0.01	<0.01	100

* Assuming no loss of solution during test work and no retained solution in residue (100% solid/liquid separation)
** Actual MgO assay was 100% purity, a normalized 99.7% purity was used for calculations

MW MgO	40.3044 kg/kmol
MW Mg	24.3050 kg/kmol
MW MgSO4	120.3676 kg/kmol
MW Na2CO3	105.9886 kg/kmol
MW MgCO3	84.3139 kg/kmol
MW H2SO4	98.079 kg/kmol
MW Fe	55.8450 kg/kmol
MW H2O2	34.0147 kg/kmol
Bottle Grade H2SO4	98%
Density H2O	1 kg/L
Density H2O2	1.45 kg/L
Density H2SO4	1.84 kg/L

1. Feed - Head Assay

Tests	YO101	YO201	YO301	Average
Mg in Head Assay	24.0%	23.4%	23.7%	23.7%
Fe in Head Assay	3.7%	4.1%	4.4%	4.1%

2. Leach - Leach Data

Tests	YO901a	YO901b	Average
Mg Leached from Feed	86.0%	86.9%	86.5%
Total Mg in PLS	85.7%	-	85.7%

Tests	YO901b	Average
Fe in Leach	55.6%	55.6%

Theoretical acid required

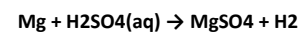

237	kg Mg =	9.75	kmol Mg
9.75	kmol Mg =	9.75	kmol H2SO4
	=	956	kg H2SO4

Acid Consumption (Oxalic Method) - Before Slurry Neutralization

Tests	YO901b	Average
Init. Conc. (M)	3.928	3.928
Final Conc. (M)	0.314	0.314
Acid Consumed	92.0%	92.0%

3. H2O2 Addition

Used 20 ml per 400 g Feed (the amount of H2O2 required was determined when ORP stabilized)

Therefore, volume of H2O2 required is 50 L/tonne-ore

4.0 MgO Addition

Tests	pH	MgO Added (g)	Feed Ore (g)	MgO per Feed kg/tonne-ore
YO901a	5.64	26.8	402.4	66.7

MgO required to reach pH = 5.64 (kg MgO/tonne-ore) = 66.7
(Added as a 20% slurry)

Stoich. Calculation

MgO added to neutralize slurry and ppt out iron impurities

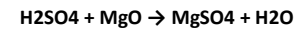

0.314 M H2SO4	=	0.314 M MgO
	=	12.7 g MgO/L PLS

Theoretical: 2,543 L sol'n = 32.2 kg MgO req'd

5. Water Wash After Slurry Neutralization

Tests	YO901a	YO901b (3-stage)
Total Water Added (L)	-	3.77
Feed Ore (g)	402.4	405
Water per Feed (L/tonne-ore)	-	9,304

Note that more water was probably added than required due to limitation with performing a re-pulp wash

Wash Wash for current process: 9,304 L/tonne-ore

6. Combined PLS

Tests	YO901a	YO901b	Average
PLS Volume (mL)	3,110	4,678	
Feed Ore (g)	402.4	405	
PLS per tonne-ore (L/tonne-ore)	7,729	11,551	9,640
Total Mg in Leach Sol'n incl MgO	85.7%		85.7%
Total Mg in PLS incl MgO (mg)	98,189		
Total Mg in PLS/Feed (kg Mg/tonne-ore)	244.0		244.0

YO901b did not have any MgO addition

Leach Data after Slurry Neutralization

Tests	YO901a	Average
Fe in PLS after MgO (%Fe out of total Fe)	0.1%	0.1%

*Previous test work showed 0.3% Fe in PLS after MgO

7. Residue

Tests	YO901a	YO901b	Average
% Weight Loss from Feed	38.2%	46.3%	42.2%

Amount of Mg in Leach Residue	14.3%
Amount of Fe in Leach Residue	99.9%

8. Carbonate Addition (100 g/L Na2CO3)

Concentration of Na2CO3 Sol'n = 100 g Na2CO3/L

Tests	YO901a	Average
Volume of Carbonate Soln Added (mL)	3,400	
Mass of Carbonate Added (g)	340	
Feed Ore (g)	402.4	
Carbonate Added (kg Na2CO3/tonne-ore)	845	845
Water Required (mL)		8,449

Stoich. Calculation

Adding Na2CO3 until no ppt is seen forming

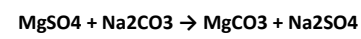

$$\begin{aligned} 237 \text{ kg Mg} &= 1176 \text{ kg MgSO}_4 \\ &= 9.8 \text{ kmol MgSO}_4 \\ 9.8 \text{ kmol MgSO}_4 &= 9.8 \text{ kmol Na}_2\text{CO}_3 \end{aligned}$$

$$\text{Theoretical Carbonate Req.} = 1,036 \text{ kg Na}_2\text{CO}_3$$

9. Precipitate Solution

Total Mg in Leach Sol'n incl MgO	85.7%	(from Stream 6)
Total Mg in PLS/Feed (kg Mg/tonne-ore)	244.0	(from Stream 6)

Stoich. Calculation

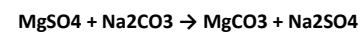

$$9.8 \text{ kmol MgSO}_4 = 9.8 \text{ kmol MgCO}_3$$

$$\text{Theoretical mass of MgCO}_3 \text{ in ppt sol'n} = 824 \text{ kg MgCO}_3$$

10. Re-Pulp Water Wash

Tests	YO901a
Total Water Added (L)	6.44
Feed Ore (g)	402.4
Water per Feed (L/tonne-ore)	16,004

$$\text{Actual Water per Feed} = 16,004 \text{ L/tonne-ore}$$

11. Barren Solution

Tests	YO901a	Average
%Mg in Barren Sol'n (from PLS)	22.2%	22.2%
%Mg in all Washes (from PLS)	13.3%	13.3%
Total % Mg NOT in MgO (from PLS)	35.4%	35.4%

Tests	YO901a	Average
%Fe in Barren Sol'n (from PLS)	63.4%	63.4%
%Fe in all Washes (from PLS)	12.9%	12.9%
Total % Fe NOT in MgO (from PLS)	76.4%	76.4%

Tests	Barren (mL)	Re-Pulp (mL)	Total Vol. (mL)	Feed Ore (g)	Barren/Feed (L/tonne-ore)
YO901a	6,600	6,440	13,040	402	32,406
Average Volume of Barren Soln per tonne ore					32,406

12. Carbonate Precipitate

Total % Mg in MgO (from PLS)	64.6%
Total % Fe in MgO (from PLS)	23.6%

Stoich. Calculation

$$153 \text{ kg Mg} = 532 \text{ kg MgCO}_3$$

(Theoretical Mass of Dried MgCO3)

13. Calcined Product

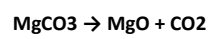

$$\begin{aligned} 532 \text{ kg MgCO}_3 &= 6.3 \text{ kmol MgCO}_3 \\ 6.3 \text{ kmol MgCO}_3 &= 6.3 \text{ kmol MgO} \end{aligned}$$

$$\text{Theoretical Mass of Calcined MgO} = 254.2 \text{ kg MgO}$$

Tests	Fully calcined	
	YO901a	Average
%LOI	61.4%	61.4%
Mass of Product (g)	105.4	105.4
Feed Ore (g)	402.4	402.4
Mass of calcined MgO (kg MgO/tonne-ore)	261.9	261.9
%Mg Difference from PLS to Prodct		

14. MgO Produced Assays

Al ₂ O ₃	BaO	CaO	Cr ₂ O ₃	Fe ₂ O ₃	K ₂ O	**MgO	MnO	Na ₂ O	P ₂ O ₅	SiO ₂	TiO ₂	SrO	V ₂ O ₅	Total
%	%	%	%	%	%	%	%	%	%	%	%	%	%	%
<0.01	<0.01	0.18	<0.01	<0.01	0.06	>99.7	0.03	<0.01	<0.01	<0.01	0.06	<0.01	<0.01	100

** Actual MgO assay was 100% purity, a normalized 99.7% purity was used for calculations

Appendix B

Process Flow Diagram

Test YO902

(P80 = 228 microns, Slurry Neutralization Method: MgO)

Sample Description	ICP Au ppm	ICP Pd ppm	ICP Pt ppm	ICP Ag ppm	ICP Al %	ICP As ppm	ICP Ba ppm	ICP Bi ppm	ICP Ca %	ICP Cd ppm	ICP Co ppm	ICP Cr ppm	ICP Cu ppm	ICP Fe %	ICP Hg ppm	ICP K %
Head (P80 = 183 µm)				0.3	0.1	34	<10	3	0.46	<0.5	111	399	<1	3.72	<3	0.02
Head (P80 = 95 µm)				0.2	0.11	34	<10	<2	0.46	<0.5	113	480	8	4.08	<3	0.02
Head (P80 = 59 µm)	0.065	0.005	<0.005	0.2	0.11	30	<10	<2	0.46	<0.5	113	633	9	4.41	<3	0.02

Sample Description	ICP La ppm	ICP Mg %	ICP Mn ppm	ICP Mo ppm	ICP Na %	ICP Ni ppm	ICP P ppm	ICP Pb ppm	ICP Sb ppm	ICP Sc ppm	ICP Sr ppm	ICP Ti %	ICP Tl ppm	ICP V ppm	ICP W ppm	ICP Zn ppm	ICP Zr ppm
Head (P80 = 183 µm)	<2	24.0	762	2	<0.01	1747	23	<2	<2	5	37	<0.01	<10	6	<10	30	<2
Head (P80 = 95 µm)	<2	23.4	775	3	<0.01	1789	26	<2	<2	5	38	<0.01	<10	7	<10	32	<2
Head (P80 = 59 µm)	<2	23.7	787	4	<0.01	1809	47	3	<2	5	38	<0.01	<10	8	<10	29	<2

YO902 Process Flow Diagram (P80 = 228 microns)

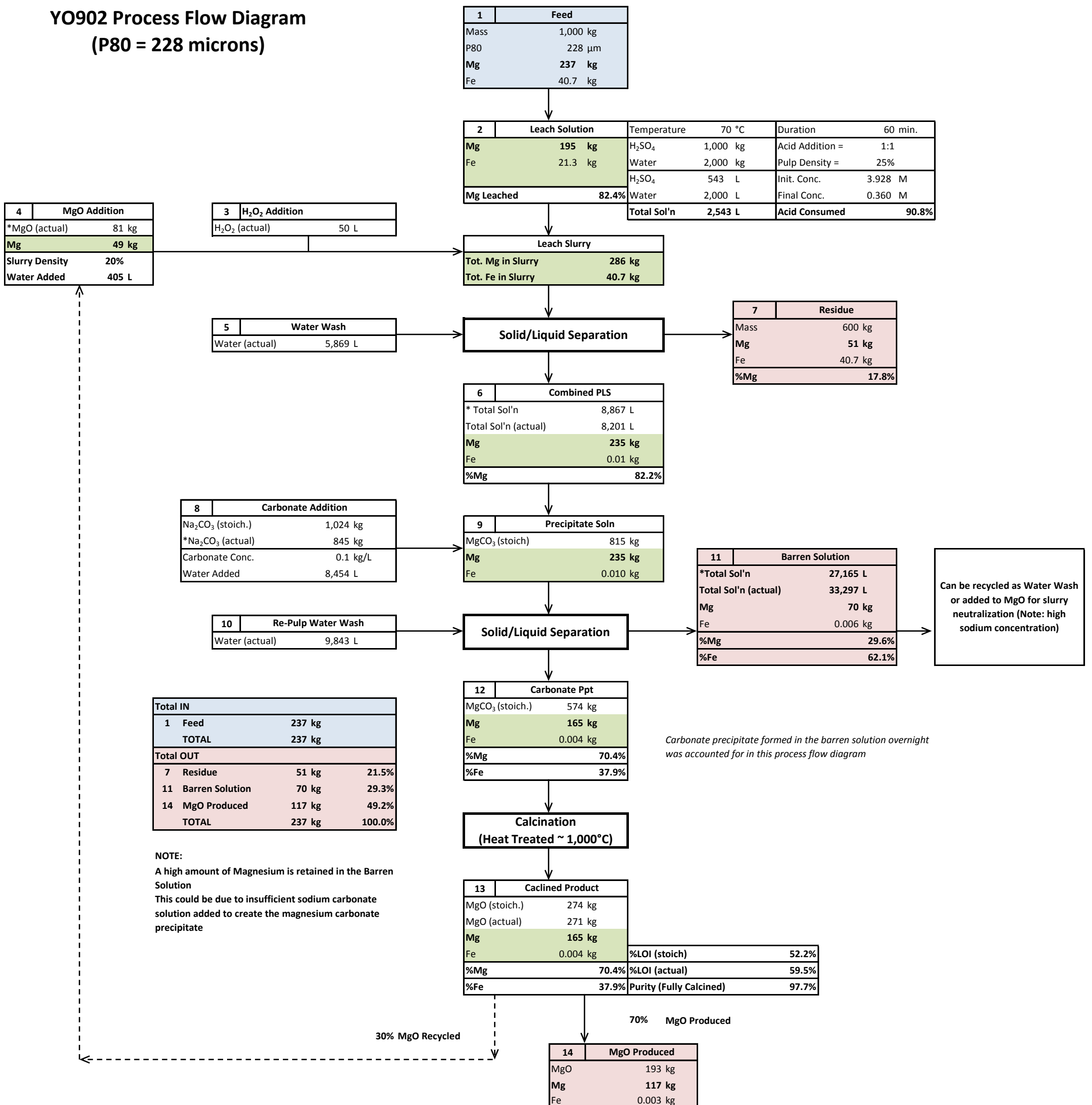

Assay for Fully Caclined Product (Assay from Test YO901a)														
Al ₂ O ₃	BaO	CaO	Cr ₂ O ₃	Fe ₂ O ₃	K ₂ O	MgO	MnO	Na ₂ O	P ₂ O ₅	SiO ₂	TiO ₂	SrO	V ₂ O ₅	Total
%	%	%	%	%	%	%	%	%	%	%	%	%	%	%
<0.01	0.01	1.34	<0.01	<0.01	0.11	97.7	0.08	0.43	0.01	0.07	<0.01	<0.01	<0.01	100

* Assuming no loss of solution during test work and no retained solution in residue (100% solid/liquid separation)

MW MgO	40.3044 kg/kmol
MW Mg	24.3050 kg/kmol
MW MgSO4	120.3676 kg/kmol
MW Na2CO3	105.9886 kg/kmol
MW MgCO3	84.3139 kg/kmol
MW H2SO4	98.079 kg/kmol
MW Fe	55.8450 kg/kmol
MW H2O2	34.0147 kg/kmol
Bottle Grade H2SO4	98%
Density H2O	1 kg/L
Density H2O2	1.45 kg/L
Density H2SO4	1.84 kg/L

1. Feed - Head Assay

Tests	YO101	YO201	YO301	Average
Mg in Head Assay	24.0%	23.4%	23.7%	23.7%
Fe in Head Assay	3.7%	4.1%	4.4%	4.1%

2. Leach - Leach Data

Tests	YO902a	YO902b	Average
Mg Leached from Feed	80.5%	84.3%	82.4%
Total Mg in PLS	80.5%	-	80.5%

Tests	YO902b	Average
Fe in Leach	52.4%	52.4%

Theoretical acid required

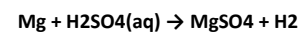

237	kg Mg =	9.75	kmol Mg
9.75	kmol Mg =	9.75	kmol H2SO4
	=	956	kg H2SO4

Acid Consumption (Oxalic Method) - Before Slurry Neutralization

Tests	YO902b	Average
Init. Conc. (M)	3.928	3.928
Final Conc. (M)	0.360	0.360
Acid Consumed	90.8%	90.8%

3. H2O2 Addition

Used 20 ml per 400 g Feed (the amount of H2O2 required was determined when ORP stabilized)

Therefore, volume of H2O2 required is 50 L/tonne-ore

4.0 MgO Addition

Tests	pH	MgO Added (g)	Feed Ore (g)	MgO per Feed kg/tonne-ore
YO902a	6.63	33.52	414	81.0

MgO required to reach pH = 5.64 (kg MgO/tonne-ore) = 81.0
(Added as a 20% slurry)

Stoich. Calculation

MgO added to neutralize slurry and ppt out iron impurities

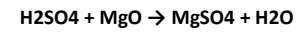

0.360 M H2SO4	=	0.3595 M MgO
	=	14.5 g MgO/L PLS

Theoretical: 2,543 L sol'n = 36.9 kg MgO req'd

5. Water Wash After Slurry Neutralization

Tests	YO902a (2-stage)	YO902b (2-stage)	Average
Total Water Added (L)	2,895	1,920	
Feed Ore (g)	414	404.6	
Water per Feed (L/tonne-ore)	6,993	4,745	5,869

Note that more water was probably added than required due to limitation with performing a re-pulp wash

Wash Wash for current process: 5,869 L/tonne-ore

6. Combined PLS

Tests	YO902a	YO902b	Average
PLS Volume (mL)	3,700	3,020	
Feed Ore (g)	414	404.6	
PLS per tonne-ore (L/tonne-ore)	8,937	7,464	8,201
Total Mg in Leach Sol'n incl MgO	82.2%		82.2%
Total Mg in PLS incl MgO (mg)	99,160		
Total Mg in PLS/Feed (kg Mg/tonne-ore)	239.5		239.5

YO901b did not have any MgO addition

Leach Data after Slurry Neutralization

Tests	YO902a	Average
Fe in PLS after MgO (%Fe out of total Fe)	0.02%	0.02%

*Previous test work showed 0.3% Fe in PLS after MgO

7. Residue

Tests	YO902a	YO902b	Average
% Weight Loss from Feed	36.1%	43.8%	40.0%

Amount of Mg in Leach Residue	17.8%
Amount of Fe in Leach Residue	99.98%

8. Carbonate Addition (100 g/L Na2CO3)

Concentration of Na2CO3 Sol'n = 100 g Na2CO3/L

Tests	YO902a	Average
Volume of Carbonate Soln Added (mL)	3,500	
Mass of Carbonate Added (g)	350	
Feed Ore (g)	414	
Carbonate Added (kg Na2CO3/tonne-ore)	845	845
Water Required (mL)		8,454

Stoich. Calculation

Adding Na2CO3 until no ppt is seen forming

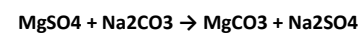

$$\begin{aligned} 235 \text{ kg Mg} &= 1163 \text{ kg MgSO}_4 \\ &= 9.7 \text{ kmol MgSO}_4 \\ 9.7 \text{ kmol MgSO}_4 &= 9.7 \text{ kmol Na}_2\text{CO}_3 \end{aligned}$$

$$\text{Theoretical Carbonate Req.} = 1,024 \text{ kg Na}_2\text{CO}_3$$

9. Precipitate Solution

Total Mg in Leach Sol'n incl MgO	82.2%	(from Stream 6)
Total Mg in PLS/Feed (kg Mg/tonne-ore)	239.5	(from Stream 6)

Stoich. Calculation

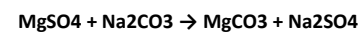

$$9.7 \text{ kmol MgSO}_4 = 9.7 \text{ kmol MgCO}_3$$

$$\text{Theoretical mass of MgCO}_3 \text{ in ppt sol'n} = 815 \text{ kg MgCO}_3$$

10. Re-Pulp Water Wash

Tests	YO902a
Total Water Added (L)	4,075
Feed Ore (g)	414
Water per Feed (L/tonne-ore)	9,843

$$\text{Actual Water per Feed} = 9,843 \text{ L/tonne-ore}$$

11. Barren Solution

Tests	YO902a	Average
%Mg in Barren Sol'n (from PLS)	25.4%	25.4%
%Mg in all Washes (from PLS)	4.2%	4.2%
Total % Mg NOT in MgO (from PLS)	29.6%	29.6%

Tests	YO902a	Average
%Fe in Barren Sol'n (from PLS)	56.2%	56.2%
%Fe in all Washes (from PLS)	5.9%	5.9%
Total % Fe NOT in MgO (from PLS)	62.1%	62.1%

Tests	Barren (mL)	Re-Pulp (mL)	Total Vol. (mL)	Feed Ore (g)	Barren/Feed (L/tonne-ore)
YO902a	9,710	4,075	13,785	414	33,297
Average Volume of Barren Soln per tonne ore					33,297

12. Carbonate Precipitate

Total % Mg in MgO (from PLS)	70.4%
Total % Fe in MgO (from PLS)	37.9%

Stoich. Calculation

$$165 \text{ kg Mg} = 574 \text{ kg MgCO}_3$$

(Theoretical Mass of Dried MgCO3)

13. Calcined Product

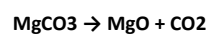

$$\begin{aligned} 574 \text{ kg MgCO}_3 &= 6.8 \text{ kmol MgCO}_3 \\ 6.8 \text{ kmol MgCO}_3 &= 6.8 \text{ kmol MgO} \end{aligned}$$

$$\text{Theoretical Mass of Calcined MgO} = 274.2 \text{ kg MgO}$$

Tests	Fully calcined	
	YO902a	Average
%LOI	59.5%	59.5%
Mass of Product (g)	112.3	112.3
Feed Ore (g)	414.0	414.0
Mass of calcined MgO (kg MgO/tonne-ore)	271.2	271.2
%Mg Difference from PLS to Prodct		

14. MgO Produced Assays

Al ₂ O ₃	BaO	CaO	Cr ₂ O ₃	Fe ₂ O ₃	K ₂ O	MgO	MnO	Na ₂ O	P ₂ O ₅	SiO ₂	TiO ₂	SrO	V ₂ O ₅	Total
%	%	%	%	%	%	%	%	%	%	%	%	%	%	%
<0.01	0.01	1.34	<0.01	<0.01	0.11	97.7	0.08	0.43	0.01	0.07	<0.01	<0.01	<0.01	100

Appendix C

Process Flow Diagram

Test YO903

(P80 = 53 microns, Slurry Neutralization Method: NaOH)

Sample Description	ICP Au ppm	ICP Pd ppm	ICP Pt ppm	ICP Ag ppm	ICP Al %	ICP As ppm	ICP Ba ppm	ICP Bi ppm	ICP Ca %	ICP Cd ppm	ICP Co ppm	ICP Cr ppm	ICP Cu ppm	ICP Fe %	ICP Hg ppm	ICP K %
Head (P80 = 183 µm)				0.3	0.1	34	<10	3	0.46	<0.5	111	399	<1	3.72	<3	0.02
Head (P80 = 95 µm)				0.2	0.11	34	<10	<2	0.46	<0.5	113	480	8	4.08	<3	0.02
Head (P80 = 59 µm)	0.065	0.005	<0.005	0.2	0.11	30	<10	<2	0.46	<0.5	113	633	9	4.41	<3	0.02

Sample Description	ICP La ppm	ICP Mg %	ICP Mn ppm	ICP Mo ppm	ICP Na %	ICP Ni ppm	ICP P ppm	ICP Pb ppm	ICP Sb ppm	ICP Sc ppm	ICP Sr ppm	ICP Ti %	ICP Tl ppm	ICP V ppm	ICP W ppm	ICP Zn ppm	ICP Zr ppm
Head (P80 = 183 µm)	<2	24.0	762	2	<0.01	1747	23	<2	<2	5	37	<0.01	<10	6	<10	30	<2
Head (P80 = 95 µm)	<2	23.4	775	3	<0.01	1789	26	<2	<2	5	38	<0.01	<10	7	<10	32	<2
Head (P80 = 59 µm)	<2	23.7	787	4	<0.01	1809	47	3	<2	5	38	<0.01	<10	8	<10	29	<2

YO903 Process Flow Diagram (P80 = 53 microns)

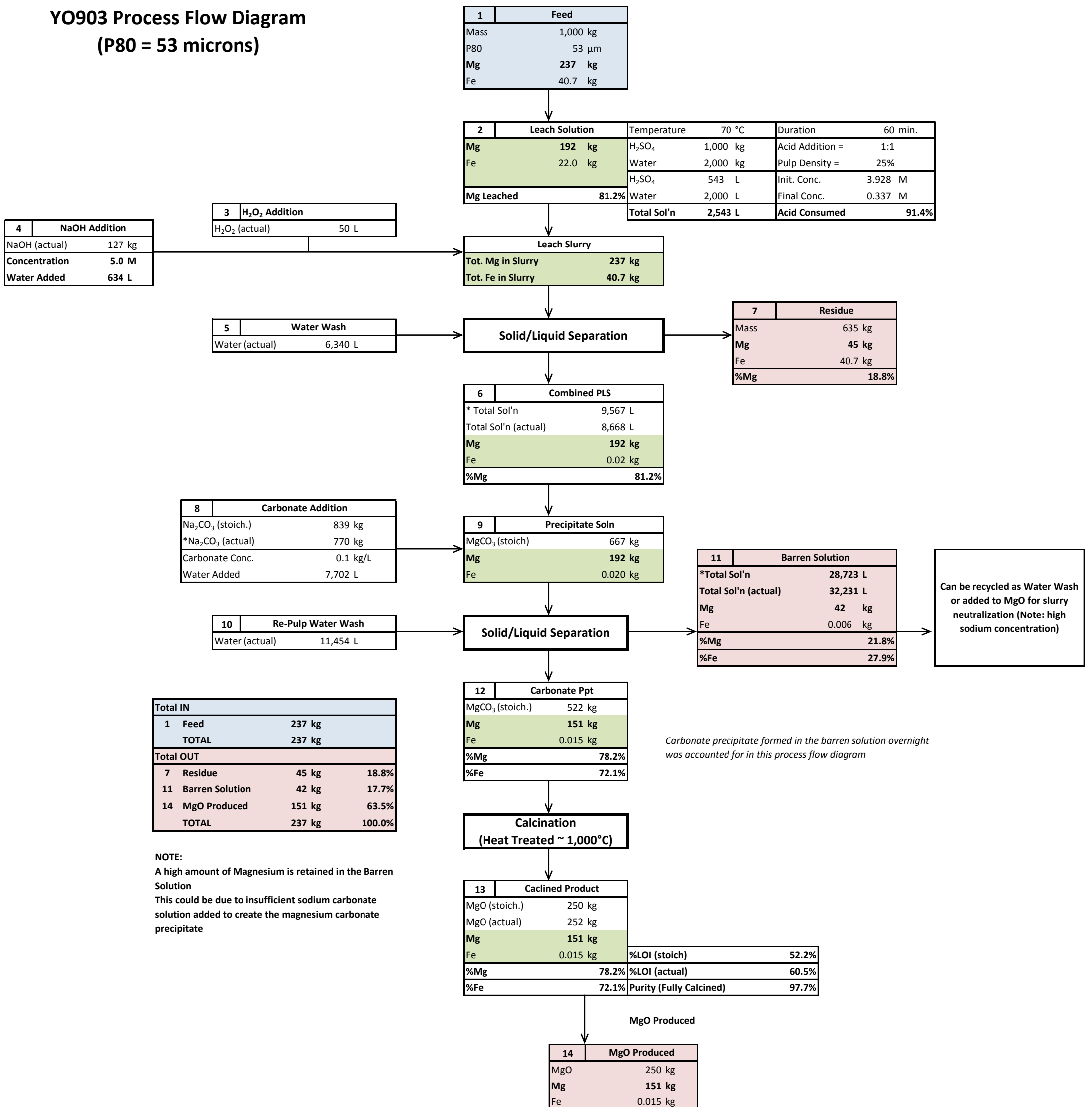

Assay for Fully Calcined Product (Assay from Test YO901a)														
Al ₂ O ₃	BaO	CaO	Cr ₂ O ₃	Fe ₂ O ₃	K ₂ O	MgO	MnO	Na ₂ O	P ₂ O ₅	SiO ₂	TiO ₂	SrO	V ₂ O ₅	Total
<0.01	<0.01	1.71	<0.01	0.05	0.02	97.7	0.33	<0.01	<0.01	0.26	0.01	<0.01	<0.01	100

* Assuming no loss of solution during test work and no retained solution in residue (100% solid/liquid separation)

MW NaOH	39.9970 kg/kmol
MW MgO	40.3044 kg/kmol
MW Mg	24.3050 kg/kmol
MW MgSO4	120.3676 kg/kmol
MW Na2CO3	105.9886 kg/kmol
MW MgCO3	84.3139 kg/kmol
MW H2SO4	98.079 kg/kmol
MW Fe	55.8450 kg/kmol
MW H2O2	34.0147 kg/kmol
Bottle Grade H2SO4	98%
Density H2O	1 kg/L
Density H2O2	1.45 kg/L
Density H2SO4	1.84 kg/L

1. Feed - Head Assay

Tests	YO101	YO201	YO301	Average
Mg in Head Assay	24.0%	23.4%	23.7%	23.7%
Fe in Head Assay	3.7%	4.1%	4.4%	4.1%

2. Leach - Leach Data

Tests	YO903a	Average
Mg Leached from Feed	81.2%	81.2%

Tests	YO901b	YO902b	Average
Fe in Leach	55.6%	52.4%	54.0%

Theoretical acid required

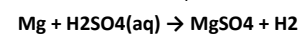

237	kg Mg =	9.75	kmol Mg
9.75	kmol Mg =	9.75	kmol H2SO4
	=	956	kg H2SO4

Acid Consumption (Oxalic Method) - Before Slurry Neutralization

Tests	YO901b	YO902b	Average
Init. Conc. (M)	3.928	3.928	3.928
Final Conc. (M)	0.314	0.360	0.337
Acid Consumed	92.0%	90.8%	91.4%

3. H2O2 Addition

Used 20 mL per 400 g Feed (the amount of H2O2 required was determined when ORP stabilized)

Therefore, volume of H2O2 required is 50 L/tonne-ore

4.0 NaOH Addition (Added at 5.0 M NaOH Solution ~ 200 g/L)

Tests	pH	NaOH Added (g)	Feed Ore (g)	NaOH per Feed kg/tonne-ore
YO903a	5.49	51.2	403.8	126.8
NaOH required to reach pH = 5.49 (kg MgO/tonne-ore) =				126.8
(Added at concentrations of 200 g NaOH per Liter of Water)				

Stoich. Calculation

NaOH added to neutralize slurry and ppt out iron impurities

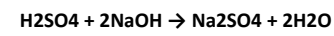

0.337 M H2SO4	=	0.6735 M NaOH
	=	26.9 g MgO/L PLS

Theoretical: 2,543 L sol'n = 68.5 kg MgO req'd

5. Water Wash After Slurry Neutralization

Tests	YO903a (2-stage)	Average
Total Water Added (L)	2,560	
Feed Ore (g)	403.8	
Water per Feed (L/tonne-ore)	6,340	6,340

Note that more water was probably added than required due to limitation with performing a re-pulp wash

Wash Wash for current process: 6,340 L/tonne-ore

6. Combined PLS

Tests	YO903a	Average
PLS Volume (mL)	3,500	
Feed Ore (g)	403.8	
PLS per tonne-ore (L/tonne-ore)	8,668	8,668
Total Mg in Leach Sol'n	81.2%	81.2%
Total Mg in PLS (mg)	77,000	
Total Mg in PLS/Feed (kg Mg/tonne-ore)	190.7	190.7

YO901b did not have any MgO addition

Leach Data after Slurry Neutralization

Tests	YO903a	Average
Fe in PLS after NaOH (%Fe out of total Fe)	0.05%	0.05%

*Previous test work showed 0.3% Fe in PLS after MgO

7. Residue

Tests	YO903a	Average
% Weight Loss from Feed	36.5%	36.5%

Amount of Mg in Leach Residue	18.8%
Amount of Fe in Leach Residue	99.95%

8. Carbonate Addition (100 g/L Na₂CO₃)

Concentration of Na₂CO₃ Sol'n = 100 g Na₂CO₃/L

Tests	YO903a	Average
Volume of Carbonate Soln Added (mL)	3,110	
Mass of Carbonate Added (g)	311	
Feed Ore (g)	403.8	
Carbonate Added (kg Na ₂ CO ₃ /tonne-ore)	770	770
Water Required (mL)		7,702

Stoich. Calculation

Adding Na₂CO₃ until no ppt is seen forming

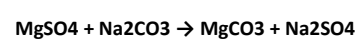

$$192 \text{ kg Mg} = 953 \text{ kg MgSO}_4$$

$$= 7.9 \text{ kmol MgSO}_4$$

$$7.9 \text{ kmol MgSO}_4 = 7.9 \text{ kmol Na}_2\text{CO}_3$$

$$\text{Theoretical Carbonate Req.} = 839 \text{ kg Na}_2\text{CO}_3$$

9. Precipitate Solution

Total Mg in Leach Sol'n incl MgO	81.2%	(from Stream 6)
Total Mg in PLS/Feed (kg Mg/tonne-ore)	190.7	(from Stream 6)

Stoich. Calculation

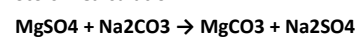

$$7.9 \text{ kmol MgSO}_4 = 7.9 \text{ kmol MgCO}_3$$

$$\text{Theoretical mass of MgCO}_3 \text{ in ppt sol'n} = 667 \text{ kg MgCO}_3$$

10. Re-Pulp Water Wash

Tests	YO903a
Total Water Added (L)	4,625
Feed Ore (g)	403.8
Water per Feed (L/tonne-ore)	11,454

$$\text{Actual Water per Feed} = 11,454 \text{ L/tonne-ore}$$

11. Barren Solution

Tests	YO903a	Average
%Mg in Barren Sol'n (from PLS)	18.5%	18.5%
%Mg in all Washes (from PLS)	3.2%	3.2%
Total % Mg NOT in MgO (from PLS)	21.8%	21.8%

Tests	YO903a	Average
%Fe in Barren Sol'n (from PLS)	20.4%	20.4%
%Fe in all Washes (from PLS)	7.4%	7.4%
Total % Fe NOT in MgO (from PLS)	27.9%	27.9%

Tests	Barren (mL)	Re-Pulp (mL)	Total Vol. (mL)	Feed Ore (g)	Barren/Feed (L/tonne-ore)
YO903a	8,390	4,625	13,015	404	32,231
Average Volume of Barren Soln per tonne ore					32,231

12. Carbonate Precipitate

Total % Mg in MgO (from PLS)	78.2%
Total % Fe in MgO (from PLS)	72.1%

Stoich. Calculation

$$151 \text{ kg Mg} = 522 \text{ kg MgCO}_3$$

(Theoretical Mass of Dried MgCO₃)

13. Calcined Product

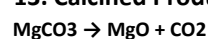

$$522 \text{ kg MgCO}_3 = 6.2 \text{ kmol MgCO}_3$$

$$6.2 \text{ kmol MgCO}_3 = 6.2 \text{ kmol MgO}$$

$$\text{Theoretical Mass of Calcined MgO} = 249.6 \text{ kg MgO}$$

Tests	Fully calcined	
	YO903a	Average
%LOI	60.5%	60.5%
Mass of Product (g)	101.6	101.6
Feed Ore (g)	403.8	403.8
Mass of calcined MgO (kg MgO/tonne-ore)	251.7	251.7
%Mg Difference from PLS to Prodct		

14. MgO Produced Assays

Al ₂ O ₃	BaO	CaO	Cr ₂ O ₃	Fe ₂ O ₃	K ₂ O	MgO	MnO	Na ₂ O	P ₂ O ₅	SiO ₂	TiO ₂	SrO	V ₂ O ₅	Total
%	%	%	%	%	%	%	%	%	%	%	%	%	%	%
<0.01	<0.01	1.71	<0.01	0.05	0.02	97.7	0.33	<0.01	<0.01	0.26	0.01	<0.01	<0.01	100

Appendix D

Process Flow Diagram

Test YO607/YO608 (Previous Test Work)

(P80 = 228 microns, Slurry Neutralization Method: MgO)

Sample Description	ICP Au ppm	ICP Pd ppm	ICP Pt ppm	ICP Ag ppm	ICP Al %	ICP As ppm	ICP Ba ppm	ICP Bi ppm	ICP Ca %	ICP Cd ppm	ICP Co ppm	ICP Cr ppm	ICP Cu ppm	ICP Fe %	ICP Hg ppm	ICP K %
Head (P80 = 183 µm)				0.3	0.1	34	<10	3	0.46	<0.5	111	399	<1	3.72	<3	0.02
Head (P80 = 95 µm)				0.2	0.11	34	<10	<2	0.46	<0.5	113	480	8	4.08	<3	0.02
Head (P80 = 59 µm)	0.065	0.005	<0.005	0.2	0.11	30	<10	<2	0.46	<0.5	113	633	9	4.41	<3	0.02

Sample Description	ICP La ppm	ICP Mg %	ICP Mn ppm	ICP Mo ppm	ICP Na %	ICP Ni ppm	ICP P ppm	ICP Pb ppm	ICP Sb ppm	ICP Sc ppm	ICP Sr ppm	ICP Ti %	ICP Tl ppm	ICP V ppm	ICP W ppm	ICP Zn ppm	ICP Zr ppm
Head (P80 = 183 µm)	<2	24.0	762	2	<0.01	1747	23	<2	<2	5	37	<0.01	<10	6	<10	30	<2
Head (P80 = 95 µm)	<2	23.4	775	3	<0.01	1789	26	<2	<2	5	38	<0.01	<10	7	<10	32	<2
Head (P80 = 59 µm)	<2	23.7	787	4	<0.01	1809	47	3	<2	5	38	<0.01	<10	8	<10	29	<2

YO607/YO608 Process Flow Diagram (P80 = 228 microns)

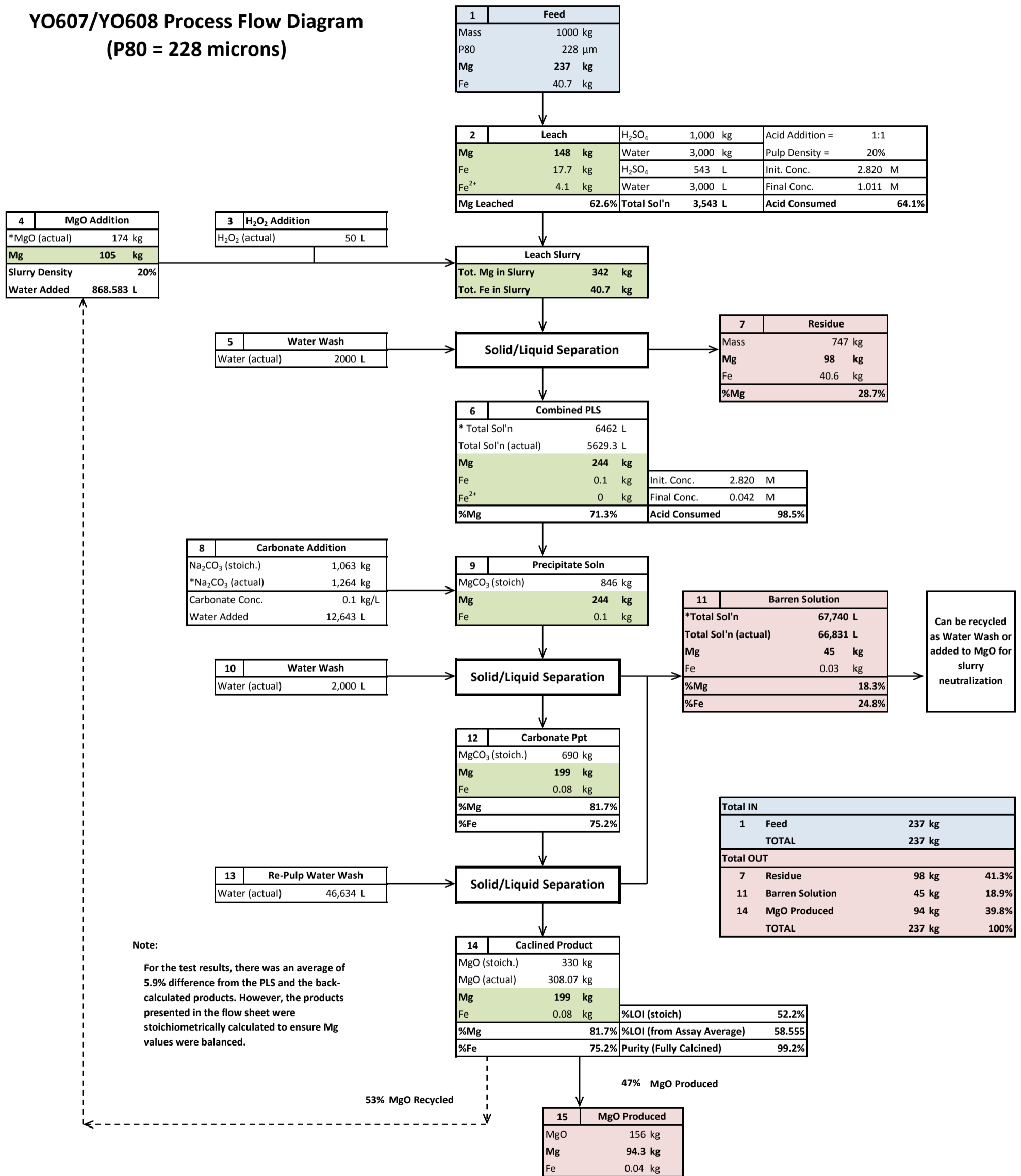

Assay for Fully Caclined Product (Average from Test YO607A and Test YO608A)																	
Al ₂ O ₃	BaO	CaO	Cr ₂ O ₃	Fe ₂ O ₃	K ₂ O	MgO	MnO	Na ₂ O	P ₂ O ₅	SiO ₂	TiO ₂	SrO	S	Ni	Co	Zn	Total
%	%	%	%	%	%	%	%	%	%	%	%	%	%	ppm	ppm	ppm	%
<0.01	<0.01	0.73	<0.01	0.08	0.06	99.2	0.22	0.09	<0.01	0.10	<0.01	<0.01	0.05	1522	64.6	56.4	101

* Assuming no loss of solution during test work and no retained solution in residue (100% solid/liquid separation)

MW MgO	40.3044 kg/kmol
MW Mg	24.3050 kg/kmol
MW MgSO4	120.3676 kg/kmol
MW Na2CO3	105.9886 kg/kmol
MW MgCO3	84.3139 kg/kmol
MW H2SO4	98.079 kg/kmol
MW Fe	55.8450 kg/kmol
MW H2O2	34.0147 kg/kmol
Bottle Grade H2SO4	98%
Density H2O	1 kg/L
Density H2O2	1.45 kg/L
Density H2SO4	1.84 kg/L

1. Feed - Head Assay

Tests	YO101	YO201	YO301	Average
Mg in Head Assay	24.0%	23.4%	23.7%	23.7%
Fe in Head Assay	3.7%	4.1%	4.4%	4.1%

2. Leach - Leach Data

Tests	YO401	YO402	YO606	YO607	YO608	Average
Mg Leached from Feed	63.9%	60.1%	68.0%	60.9%	60.2%	62.6%
Total Mg in PLS	-	-	67.5%	71.0%	78.9%	72.5%

Theoretical acid required

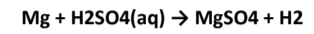

237	kg Mg =	9.75	kmol Mg
9.75	kmol Mg =	9.75	kmol H2SO4
	=	956	kg H2SO4

Tests	YO401	YO402	Average
Fe in Leach	45.4%	41.7%	43.5%

Tests	YO401	YO402	YO600	YO601	YO602	YO603	YO604	Average
Ferrous in Leach	27.5%	23.9%	22.2%	21.3%	21.6%	-	23.9%	23.4%

Acid Consumption Under Preferred Conditions (Oxalic Method) - Before Slurry Neutralization

Tests	YO401	YO402	Average
Init. Conc. (M)	2.820	2.820	2.820
Final Conc. (M)	0.933854167	1.088541667	1.011
Acid Consumed	66.9%	61.4%	64.1%

3. H2O2 Addition

Used 20 mL per 400 g Feed (the amount of H2O2 required was determined when ORP stabilized)

Therefore, volume of H2O2 required is 50 L/tonne-ore

4.0 MgO Addition

Tests	pH	MgO Added (g)	Feed Ore (g)	MgO per Feed kg/tonne-ore
YO601	2.72	35.68	196.4	181.7
YO604	3.06	34.38	198	173.6
YO603	3.51	37.22	198.2	187.8
YO602	3.75	38.68	206.5	187.3
YO608	3.78	64.84	402.4	161.1
YO600	3.95	37.49	204	183.8
YO606	5.52	71.78	401	179.0
YO607	5.61	63.46	400.7	158.4

Stoich. Calculation

MgO added to neutralize slurry and ppt out iron impurities
MgO added as a 20% slurry until pH > 4

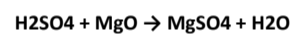

$$1.011 \text{ M H}_2\text{SO}_4 = 1.0111979 \text{ M MgO}$$

$$= 40.8 \text{ g MgO/L PLS}$$

Therefore, 3,543 L sol'n = 144.4 kg MgO req'd

Average MgO required to reach pH ≥ 3.95 (kg MgO/tonne-ore) = 173.7 (Added as a 20% slurry)

5. Water Wash After Slurry Neutralization

Tests	YO401	YO402	YO600	YO601	YO602	YO603	YO604	YO606	YO607	YO608
Water Added (L)	0.4	0.4	0.4	0.675	0.4	0.4	0.4	1.2	1.2	1.2
Feed Ore (g)	405	404.8	204	196.4	206.5	198.2	198	401	400.7	402.4
Water per Feed (L/tonne-ore)	988	988	1961	3437	1937	2018	2020	2993	2995	2982
Stages of 1000 L H2O/tonne-ore	1	1	2	3.5	2	2	2	3	3	3
3rd stage wash %Mg in Sol'n								0.8%	3.0%	2.2%

Each stage of displacement wash was done by adding 1000L H2O/tonne-ore

Since the 3rd stage recovery of Mg is fairly low, most of the magnesium is washed out of the residue by the second stage of water wash

Therefore, only 2000 L/tonne-ore is required for water wash

6. Combined PLS

Tests	YO600	YO601	YO602	YO603	YO604	YO606	YO607	YO608	Average
PLS Volume (mL)	1216	1240	1132	1126	1067.9	2901	2413	2400	
Feed Ore (g)	204	196.4	206.5	198.2	198	401	400.7	402.4	
PLS per tonne-ore (L/tonne-ore)	5961	6314	5482	5681	5393	7234	6022	5964	5629
Total Mg in Leach Sol'n incl MgO	72.5%	68.5%	70.3%	70.7%	71.2%	67.5%	71.0%	78.9%	71.3%
Total Mg in PLS incl MgO (mg)	47,188	44,994	48,625	47,599	45,838	107,917	96,037	96,480	
Total Mg in PLS/Feed (kg Mg/tonne-ore)	231.3	229.1	235.5	240.2	231.5	269.1	239.7	239.8	239.5

Leach Data after Slurry Neutralization

Tests	YO600	YO601	YO602	YO603	YO604	YO606	YO607	YO608	Average
Fe in PLS after MgO (%Fe out of total Fe)	0.1%	0.9%	0.0%	0.1%	0.3%	0.0%	0.0%	0.6%	0.3%

Tests	YO600	YO601	YO602	YO603	YO604	YO606	YO607	YO608	Average
Ferrous in PLS after MgO	0.0%	0.0%	0.0%	0.0%	0.0%	0.5%	0.0%	0.0%	0.0%

Tests	YO600	YO601	YO602	YO603	YO604	YO606	Average
Init. Conc. (M)	2.820	2.820	2.820	2.820	2.820	2.820	2.820
Final Conc. (M)	0.051	0.048	0.048	0.051	0.051	0.006	0.042
Acid Consumed	98.2%	98.3%	98.3%	98.2%	98.2%	99.8%	98.5%

7. Residue

Tests	YO600	YO601	YO602	YO603	YO604	YO606	YO607	YO608	Average
% Weight Loss from Feed	25.7%	24.0%	22.9%	23.1%	21.6%	25.3%	29.3%	30.3%	25.3%

Amount of Mg in Residue	28.7%
Amount of Fe in Residue	99.7%

8. Carbonate Addition (100 g/L Na2CO3)

Concentration of Na2CO3 Sol'n =		100 g Na2CO3/L		
Tests	YO607	YO608	Average	
Volume of Carbonate Soln Added (mL)	4669.9	5486		
Mass of Carbonate Added (g)	467.0	549		
Feed Ore (g)	400.7	402.4		
Carbonate Added (kg Na2CO3/tonne-ore)	1165	1363	1264	
Water Required (mL)				12,643

Stoich. Calculation

Adding Na2CO3 until no ppt is seen forming

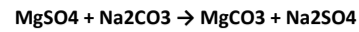

244 kg Mg	=	1207 kg MgSO4
	=	10.0 kmol MgSO4
10.0 kmol MgSO4	=	10.0 kmol Na2CO3
Carbonate Required =		1063 kg Na2CO3 req

9. Precipitate Solution

Total Mg in Leach Sol'n incl MgO	71.3%	(from Stream 6)
Total Mg in PLS/Feed (kg Mg/tonne-ore)	239.5	(from Stream 6)

Stoich. Calculation

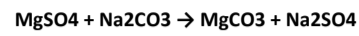

10.0 kmol MgSO4	=	10.0 kmol MgCO3
Theoretical mass of MgCO3 in ppt sol'n =		846 kg MgCO3

10. Water Wash

Each stage of wash was done by adding 1000L H2O/tonne-ore

Only 2 stage is required - Must make sure re-pulp wash to ensure sodium and sulfate ions are washed out of precipitate

Therefore, only 2000 L/tonne-ore is required for water wash

11. Barren Solution

Tests	Non-fully calcined		Fully calcined		Average
	YO607	YO608	YO607	YO608	
%Mg in Barren Sol'n (from PLS)	9.6%	8.2%	9.6%	8.2%	8.9%
%Mg in all Washes (from PLS)	11.4%	7.5%	11.3%	7.5%	9.4%
Total % Mg NOT in MgO (from PLS)	21.0%	15.7%	20.9%	15.7%	18.3%

Tests	Non-fully calcined		Fully calcined		Average
	YO607	YO608	YO607	YO608	
%Fe in Barren Sol'n (from PLS)	23.6%	10.5%	36.7%	9.0%	19.9%
%Fe in all Washes (from PLS)	4.6%	4.2%	7.1%	3.6%	4.8%
Total % Fe NOT in MgO (from PLS)	28.1%	14.6%	43.8%	12.5%	24.8%

Tests	Barren (mL)	Wash (mL)	Re-Pulp (mL)	Total Vol. (mL)	Feed Ore (g)	Barren/Feed (L/tonne-ore)
YO607	5479	0	16,707	22,186	401	55,368
YO608	5486	5266	20,754	31,506	402	78,294
Average Volume of Barren Soln per tonne ore						66,831

12. Carbonate Precipitate

Total % Mg in MgO (from PLS)	81.7%
Total % Fe in MgO (from PLS)	75.2%

Stoich. Calculation

=	199 kg Mg =	690 kg MgCO3
		(Theoretical Mass of Dried MgCO3)

13. Re-Pulp Water Wash

YO607 Re-Pulp Washes	41,695 L water/tonne-ore
YO608 Re-Pulp Washes	51,574 L water/tonne-ore
Average Water Required for Re-Pulp Wash	46,634 L water/tonne-ore

14. Calcined Product

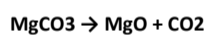

690 kg MgCO3	=	8.2 kmol MgCO3
8.2 kmol MgCO3	=	8.2 kmol MgO

Theoretical Mass of Calcined MgO = 330.1 kg MgO

Tests	Carbonate Ppt			Fully calcined			Total Average
	YO607	YO608	Average	YO607	YO608	Average	
%LOI	60.2%	56.9%	58.6%	60.2%	56.9%	58.6%	58.6%
Mass of Product (g)	302.0	295.3	298.6	120.1	127.3	123.7	211.2
Feed Ore (g)	400.7	402.4	401.6	400.7	402.4	401.6	401.6
Mass of calcined MgO (kg MgO/tonne-ore)	753.7	733.7	743.7	299.7	316.5	308.1	525.9
%Mg Difference from PLS to Prodct	5.8%	6.6%	6.2%	5.4%	6.3%	5.9%	6.0%

Calcined Assays

Assayed Impurities from Carbonate Product (YO607A)

Al2O3	BaO	CaO	Cr2O3	Fe2O3	K2O	MgO	MnO	Na2O	P2O5	SiO2	TiO2	SrO	LOI	Total
%	%	%	%	%	%	%	%	%	%	%	%	%	%	%
<0.01	<0.01	0.376	<0.01	0.02	0.01	39.2	0.086	<0.01	<0.01	0.023	<0.01	<0.01	60.24	100

Assay for Fully Calcined Product (YO607A)

Al2O3	BaO	CaO	Cr2O3	Fe2O3	K2O	MgO	MnO	Na2O
%	%	%	%	%	%	%	%	%
<0.01	<0.01	0.95	<0.01	0.02	0.04	99.17	0.21	<0.01
P2O5	SiO2	TiO2	SrO	S	Ni	Co	Zn	Total
%	%	%	%	%	ppm	ppm	ppm	%
<.01	0.12	<0.01	<0.01	0.05	873	44	55	101

Assayed Impurities from Carbonate Product (YO608A)

Al2O3	BaO	CaO	Cr2O3	Fe2O3	K2O	MgO	MnO	Na2O	P2O5	SiO2	TiO2	SrO	LOI	Total
%	%	%	%	%	%	%	%	%	%	%	%	%	%	%
<0.01	<0.01	0.214	<0.01	0.05	<0.01	42.7	0.1	0.094	<0.01	0.01	<0.01	<0.01	56.87	100

Assay for Fully Calcined Product (YO608A)

Al2O3	BaO	CaO	Cr2O3	Fe2O3	K2O	MgO	MnO	Na2O
%	%	%	%	%	%	%	%	%
<0.01	<0.01	0.52	<0.01	0.14	0.08	99.25	0.24	0.09
P2O5	SiO2	TiO2	SrO	S	Ni	Co	Zn	Total
%	%	%	%	%	ppm	ppm	ppm	%
<0.01	0.08	<0.01	<0.01	0.05	2,170	85	58	100

Appendix E

Mass Balance

Test YO901a and Test YO901b

(P80 = 53 microns, Slurry Neutralization Method: MgO)

- a) Acid Leach Test Mass Balance (YO901a)**
- b) Carbonate Precipitation and Calcination Mass Balance (YO901a)**
- c) Acid Leach Test Mass Balance (YO901b)**



Acid Leach Test with MgO Addition

Client: West High Yield Resources

Date: 05-Mar-13

Test: YO901a (pH = 5.64)

Project: MS1358

Sample: YO800 Feed (P80 = 53 microns)

Description:	Variables:
<p><i>Sulfuric Acid Leach at Elevated Temp. (~70 °C)</i></p> <p>Feed Particle Size = 53 microns</p> <p>20 mL of Hydrogen Peroxide added after leach (30 min to stabilize ORP)</p> <p>MgO added after solution is oxidized 20% MgO slurry added = 134.2 g (30 min for pH to stabilize)</p>	<p>Total Feed = 402.4 g</p> <p>Acid Addition = 1,000 kg/tonne</p> <p>Pulp Density = 25 %</p> <p>P₈₀ = 53 μm</p> <p>Duration of Leach = 60 min</p> <p>Mass of MgO added = 26.8 g</p> <p>Mg from MgO added = 16,186 mg</p> <p>Final pH = 5.64</p> <p>*Filtration Time for PLS = 90 minutes</p>

*(Filtered w/ 185 mm diameter Buchner funnel: 25 μm filter paper & #1 Whatman Filter Paper)

Products	Mass/Volume	Assay (ppm)		Units (mg)		Distribution (%)	
		Mg	Fe	Mg	Fe	Mg	Fe
*Combined PLS	3110 mL	31,572	5.0	98,189	16	85.7%	0.1%
PLS Leached	3110 mL	26,368	5.0	82,004	16	86.0%	0.1%
Residue	248.8 g	66,000	92,300	16,421	22,964	14.3%	99.9%
Calc. Overall Feed		284,816	57,107	114,610	22,980	100.0%	100.0%
**Adj. Calc. Feed		244,594	-	98,424	-		
Assayed Feed	402.4 g	236,900	40,700	95,329	16,378		

*Combined PLS = Preg Solution + All Water Washes (Includes Mg leached from MgO addition)

Combined PLS assay was normalized from carbonate precipitation and barren solution

** Calc. Overall Feed includes Mg added from MgO

Adjusted Calculated Feed is adjusted to disregard the amount of Mg added from MgO for Assayed Feed comparison

Solids Weight Loss = 38.2%

% Mg Leached = 86.0%

(% Mg Leached does not include the Mg from MgO)

% Fe in Solution = 0.07%



CARBONATE PRECIPITATION & CALCINATION

Client: West High Yield Resources

Date: 06-Mar-13

Test: YO901a (Carbonate Precipitation & Calcination)

Project: MS1358

Sample: YO800 Feed (P80 = 53 microns)

Test Description:	Variables:
<p>Adding Sodium Carbonate Solution to Combined PLS to make Magnesium Carbonate</p> <p>MgCO₃ product would be dried at 100°C for minimum one day</p> <p>A sub-sample of the dried MgCO₃ product would be sent to assay lab for lithium borate fusion which would calcine the sub-sample and obtain an LOI value</p> <p align="center">Sodium Carbonate Solution (Concentration = 100 g/L)</p> <p>Na₂CO₃ was added until no precipitate was observed</p>	<p>YO901a Combined PLS = 3110 mL</p> <p>Total Feed = 402.4 g</p> <p>Volume of Na₂CO₃ Solution = 3400.0 mL</p> <p>Mass of Na₂CO₃ used = 340.0 g</p> <p>Mass of MgCO₃ Precipitate = 267.8 g</p> <p>*Temperature calcined at = ~ 1,000 °C</p> <p>*Approximate lithium borate fusion temperature (supplied by assay lab)</p>

Products	Mass/Volume	Assay (ppm)		Units (mg)		Distribution (%)	
		Mg	Fe	Mg	Fe	Mg	Fe
Na ₂ CO ₃ Soln Addition	3400.0 mL						
Barren Solution	6600.0 mL	3,300	<1.5	21,780	9.9	22.2%	63.4%
Re-Pulp Wash 1	4530.0 mL	2,584	0	11,704	1.7	11.9%	11.1%
Re-Pulp Wash 2	1910.0 mL	689	0	1,317	0.3	1.3%	1.8%
*MgCO ₃ ppt in Barren Soln	14 g						
Potential MgO in Barren Soln	5.4 g						
MgCO ₃ Precipitate	287.1 g						
Calcined MgO Product	105.4 g	601,410	35	63,388	3.7	64.6%	23.6%
Calculated Combined PLS		31,572	5	98,189	15.6	100.0%	100.0%
*YO901a Combined PLS	3110.0 mL	-	-	-	-		

*MgCO₃ precipitate that would form in barren solution overnight

**Accounted for sodium carbonate addition

Loss on Ignition (LOI) = 61.4%

Purity of MgO = 99.7%

Assayed Compounds from Caclined Product

Al ₂ O ₃	BaO	CaO	Cr ₂ O ₃	Fe ₂ O ₃	K ₂ O	**MgO	MnO	Na ₂ O
%	%	%	%	%	%	%	%	%
<0.01	<0.01	0.18	<0.01	<0.01	0.06	>99.7	0.03	<0.01
P ₂ O ₅	SiO ₂	TiO ₂	SrO	V ₂ O ₅	Total			
%	%	%	%	%	%			
<0.01	<0.01	0.06	<0.01	<0.01	100			

** Actual MgO assay was 100% purity, a normalized 99.7% purity was used for calculations

Note:

Carbonate precipitate formed in the barren solution overnight was included in determining the "**Calcined MgO Product**"



Acid Leach Test with MgO Addition

Client: West High Yield Resources

Date: 04-Mar-13

Test: YO901b

Project: MS1358

Sample: YO800 Feed (P80 = 53 microns)

Description:	Variables:
<p><i>Sulfuric Acid Leach at Elevated Temp. (~70 °C)</i></p> <p>Feed Particle Size = 53 microns</p> <p><i>This test was done to evaluate leach recovery</i></p>	<p>Total Feed = 405 g</p> <p>Acid Addition = 1,000 kg/tonne</p> <p>Pulp Density = 25 %</p> <p>P₈₀ = 53 μm</p> <p>Duration of Leach = 60 min</p> <p>*Filtration Time for PLS = +180 minutes</p>

*(Filtered w/ 185 mm diameter Buchner funnel: 25 μm filter paper & #1 Whatman Filter Paper)

Products	Mass/Volume	Assay (ppm)		Units (mg)		Distribution (%)	
		Mg	Fe	Mg	Fe	Mg	Fe
Preg Solution	910 mL	74,060	10,410	67,395	9,473	-	-
Re-Pulp Wash 1	1590 mL	15,100	2,030	24,009	3,228	-	-
Re-Pulp Wash 2	638 mL	3,150	394	2,010	251	-	-
Re-Pulp Wash 3	1540 mL	399	34	614	53	-	-
*Combined PLS	4678 mL	20,100	2,780	94,028	13,005	86.9%	55.6%
Residue	217.5 g	65,100	47,800	14,159	10,397	13.1%	44.4%
Calculated Feed		267,129	57,781	108,187	23,401	100.0%	100.0%
Assayed Feed	405.0 g	236,900	40,700	95,945	16,484		

*Combined PLS = Preg Solution + All Water Washes (Includes Mg leached from MgO addition)

Solids Weight Loss = 46.3%

% Mg Leached = 86.9%

% Fe in Solution = 55.6%

(% Mg Leached does not include the Mg from MgO)

Appendix F

Mass Balance

Test YO902a and Test YO902b

(P80 = 228 microns, Slurry Neutralization Method: MgO)

- a) Acid Leach Test Mass Balance (YO902a)**
- b) Carbonate Precipitation and Calcination Mass Balance (YO902a)**
- c) Acid Leach Test Mass Balance (YO902b)**



Acid Leach Test with MgO Addition

Client: West High Yield Resources

Date: 11-Mar-13

Test: YO902a (pH = 6.63)

Project: MS1358

Sample: YO400 Feed (P80 = 228 microns)

Description:	Variables:
<p><i>Sulfuric Acid Leach at Elevated Temp. (~70 °C)</i></p> <p>Feed Particle Size = 228 microns</p> <p>20 mL of Hydrogen Peroxide added after leach (30 min to stabilize ORP)</p> <p>MgO added after solution is oxidized 20% MgO slurry added = 167.6 g (30 min for pH to stabilize)</p>	<p>Total Feed = 414 g</p> <p>Acid Addition = 1,000 kg/tonne</p> <p>Pulp Density = 25 %</p> <p>P₈₀ = 228 μm</p> <p>Duration of Leach = 60 min</p> <p>Mass of MgO added = 33.5 g</p> <p>Mg from MgO added = 20,214 mg</p> <p>Final pH = 6.63</p> <p>*Filtration Time for PLS = 90 minutes</p>

*(Filtered w/ 185 mm diameter Buchner funnel: 25 μm filter paper & #1 Whatman Filter Paper)

Products	Mass/Volume	Assay (ppm)		Units (mg)		Distribution (%)	
		Mg	Fe	Mg	Fe	Mg	Fe
Preg Solution	805 mL	70,200	<3.0	56,511	2	-	-
Re-Pulp Wash 1	1795 mL	22,500	<1.5	40,388	3	-	-
Re-Pulp Wash 2	1100 mL	5,780	0.4	6,358	0	-	-
<i>*Combined PLS</i>	<i>3700 mL</i>	<i>26,800</i>	<i><1.5</i>	<i>99,160</i>	<i>6</i>	<i>82.2%</i>	<i>0.0%</i>
PLS Leached	3700 mL	21,337	<1.5	78,946	6	80.5%	0.0%
Residue	264.6 g	81,300	89,800	21,512	23,761	17.8%	100.0%
Calc. Overall Feed		291,478	57,407	120,672	23,767	100.0%	100.0%
**Adj. Calc. Feed		242,652	-	100,458	-		
Assayed Feed	414.0 g	236,900	40,700	98,077	16,850		

*Combined PLS = Preg Solution + All Water Washes (Includes Mg leached from MgO addition)

** Calc. Overall Feed includes Mg added from MgO

Adjusted Calculated Feed is adjusted to disregard the amount of Mg added from MgO for Assayed Feed comparison

Solids Weight Loss = 36.1%

% Mg Leached = 80.5%

(% Mg Leached does not include the Mg from MgO)

% Fe in Solution = 0.02%



CARBONATE PRECIPITATION & CALCINATION

Client: West High Yield Resources

Date: 11-Mar-13

Test: YO902a (Carbonate Precipitation & Calcination)

Project: MS1358

Sample: YO400 Feed (P80 = 228 microns)

Test Description:	Variables:
<p>Adding Sodium Carbonate Solution to Combined PLS to make Magnesium Carbonate</p> <p>MgCO₃ product would be dried at 100°C for minimum one day</p> <p>A sub-sample of the dried MgCO₃ product would be sent to assay lab for lithium borate fusion which would calcine the sub-sample and obtain an LOI value</p> <p style="text-align: center;">Sodium Carbonate Solution (Concentration = 100 g/L)</p> <p>Na₂CO₃ was added until no precipitate was observed</p>	<p style="text-align: right;">YO902a Combined PLS = 3700 mL Total Feed = 414 g</p> <p style="text-align: right;">Volume of Na₂CO₃ Solution = 3500.0 mL Mass of Na₂CO₃ used = 350.0 g</p> <p style="text-align: right;">Mass of MgCO₃ Precipitate = 267.8 g</p> <p style="text-align: right;">*Temperature calcined at = ~ 1,000 °C</p> <p><small>*Approximate lithium borate fusion temperature (supplied by assay lab)</small></p>

Products	Mass/Volume	Assay (ppm)		Units (mg)		Distribution (%)	
		Mg	Fe	Mg	Fe	Mg	Fe
Na ₂ CO ₃ Soln Addition	3500.0 mL						
Barren Solution	9710.0 mL	2,460	<0.6	23,887	6	25.4%	56.2%
Re-Pulp Wash 1	3000.0 mL	1,090	<0.2	3,270	0	3.5%	4.3%
Re-Pulp Wash 2	1075.0 mL	603	<0.2	648	0	0.7%	1.6%
*MgCO ₃ ppt in Barren Soln	9.4 g						
MgO in Barren Soln overnight	3.8 g						
MgCO ₃ Precipitate	277.2 g						
Calcined MgO Product	112.3 g	589,168	35	66,144	4	70.4%	37.9%
Calculated Combined PLS		25,391	3	93,948	10	100.0%	100.0%
**YO902a Combined PLS	3700.0 mL	26,800	2	99,160	6		

**MgCO₃ precipitate that would form in barren solution overnight*

***Accounted for sodium carbonate addition*

Loss on Ignition (LOI) = 59.5%

Purity of MgO = 97.7%

Assayed Compounds from Caclined Product

Al ₂ O ₃	BaO	CaO	Cr ₂ O ₃	Fe ₂ O ₃	K ₂ O	MgO	MnO	Na ₂ O
%	%	%	%	%	%	%	%	%
<0.01	0.01	1.34	<0.01	<0.01	0.11	97.7	0.08	0.43
P ₂ O ₅	SiO ₂	TiO ₂	SrO	V ₂ O ₅	Total			
%	%	%	%	%	%			
0.01	0.07	<0.01	<0.01	<0.01	100			

Note:

Carbonate precipitate formed in the barren solution overnight was included in determining the "**Calcined MgO Product**"



Acid Leach Test with MgO Addition

Client: West High Yield Resources

Date: 10-Mar-13

Test: YO902b

Project: MS1358

Sample: YO400 Feed (P80 = 228 microns)

Description:	Variables:
<p><i>Sulfuric Acid Leach at Elevated Temp. (~70 °C)</i></p> <p>Feed Particle Size = 228 microns</p> <p><i>This test was done to evaluate leach recovery</i></p>	<p>Total Feed = 404.6 g</p> <p>Acid Addition = 1,000 kg/tonne</p> <p>Pulp Density = 25 %</p> <p>P₈₀ = 228 µm</p> <p>Duration of Leach = 60 min</p> <p>*Filtration Time for PLS = +180 minutes</p>

*(Filtered w/ 185 mm diameter Buchner funnel: 25 µm filter paper & #1 Whatman Filter Paper)

Products	Mass/Volume	Assay (ppm)		Units (mg)		Distribution (%)	
		Mg	Fe	Mg	Fe	Mg	Fe
PLS + Re-Pulp 1	2360 mL	39,100	5,280	92,276	12,461	-	-
Re-Pulp Wash 2	660 mL	2,720	275	1,795	182	-	-
*Combined PLS	3020 mL	27,300	3,780	82,446	11,416	84.3%	52.4%
Residue	227.3 g	67,300	45,600	15,297	10,365	15.7%	47.6%
Calculated Feed		241,580	53,832	97,743	21,780	100.0%	100.0%
Assayed Feed	404.6 g	236,900	40,700	95,850	16,467		

*Combined PLS = Preg Solution + All Water Washes (Includes Mg leached from MgO addition)

Solids Weight Loss = 43.8%

% Mg Leached = 84.3%

% Fe in Solution = 52.4%

(% Mg Leached does not include the Mg from MgO)

Appendix G

Mass Balance

Test YO903a

(P80 = 53 microns, Slurry Neutralization Method: NaOH)

- a) Acid Leach Test Mass Balance (YO903a)**
- b) Carbonate Precipitation and Calcination Mass Balance (YO903a)**



Acid Leach Test with NaOH Addition

Client: West High Yield Resources

Date: 18-Mar-13

Test: YO903a (pH = 5.49)

Project: MS1358

Sample: YO800 Feed (P80 = 53 microns)

Description:	Variables:
<p><i>Sulfuric Acid Leach at Elevated Temp. (~70 °C)</i></p> <p>Feed Particle Size = 53 microns</p> <p>20 mL of Hydrogen Peroxide added after leach (30 min to stabilize ORP)</p> <p>NaOH added after solution is oxidized 5.0M NaOH solution added = 256 mL (30 min for pH to stabilize)</p>	<p>Total Feed = 403.8 g</p> <p>Acid Addition = 1,000 kg/tonne</p> <p>Pulp Density = 25 %</p> <p>P₈₀ = 228 μm</p> <p>Duration of Leach = 60 min</p> <p>Mass of NaOH added = 51.2 g</p> <p>Final pH = 5.49</p> <p>*Filtration Time for PLS = 90 minutes</p>

*(Filtered w/ 185 mm diameter Buchner funnel: 25 μm filter paper & #1 Whatman Filter Paper)

Products	Mass/Volume	Assay (ppm)		Units (mg)		Distribution (%)	
		Mg	Fe	Mg	Fe	Mg	Fe
Preg Solution	940 mL	45,900	9.9	43,146	9	-	-
Re-Pulp Wash 1	1080 mL	17,700	<1.5	19,116	2	-	-
Re-Pulp Wash 2	1480 mL	3,900	<0.6	5,772	1	-	-
<i>*Combined PLS</i>	<i>3500 mL</i>	<i>22,000</i>	<i>3.1</i>	<i>77,000</i>	<i>11</i>	<i>81.2%</i>	<i>0.0%</i>
Residue	256.5 g	69,600	85,500	17,852	21,931	18.8%	100.0%
Calculated Feed		234,899	54,338	94,852	21,942	100.0%	100.0%
Assayed Feed	403.8 g	236,900	40,700	95,660	16,435		

*Combined PLS = Preg Solution + All Water Washes

Solids Weight Loss = 36.5%

% Mg Leached = 81.2%

% Fe in Solution = 0.05%

(% Mg Leached does not include the Mg from MgO)



CARBONATE PRECIPITATION & CALCINATION

Client: West High Yield Resources

Date: 19-Mar-13

Test: YO903a (Carbonate Precipitation & Calcination)

Project: MS1358

Sample: YO800 Feed (P80 = 53 microns)

Test Description:	Variables:
<p>Adding Sodium Carbonate Solution to Combined PLS to make Magnesium Carbonate</p> <p>MgCO₃ product would be dried at 100°C for minimum one day</p> <p>A sub-sample of the dried MgCO₃ product would be sent to assay lab for lithium borate fusion which would calcine the sub-sample and obtain an LOI value</p> <p align="center">Sodium Carbonate Solution (Concentration = 100 g/L)</p> <p>Na₂CO₃ was added until no precipitate was observed</p>	<p>YO903a Combined PLS = 3500 mL Total Feed = 403.8 g</p> <p>Volume of Na₂CO₃ Solution = 3110.0 mL Mass of Na₂CO₃ used = 311.0 g</p> <p>Mass of MgCO₃ Precipitate = 211.2 g</p> <p>*Temperature calcined at = ~ 1,000 °C</p> <p>*Approximate lithium borate fusion temperature (supplied by assay lab)</p>

Products	Mass/Volume	Assay (ppm)		Units (mg)		Distribution (%)	
		Mg	Fe	Mg	Fe	Mg	Fe
Na ₂ CO ₃ Soln Addition	3110.0 mL						
Barren Solution	8390.0 mL	1,690	<0.60	14,179	5	18.5%	20.4%
Re-Pulp Wash 1	2520.0 mL	663	<0.60	1,671	2	2.2%	6.1%
Re-Pulp Wash 2	1235.0 mL	429	<0.15	530	0	0.7%	0.8%
Re-Pulp Wash 3	870.0 mL	320	<0.15	278	0	0.4%	0.5%
*MgCO ₃ ppt in Barren Soln	46.1 g						
MgO in Barren Soln overnight	18.2 g						
MgCO ₃ Precipitate	257.3 g						
Calcined MgO Product	101.6 g	589,168	175	59,879	18	78.2%	72.1%
Calculated Combined PLS		21,868	7	76,537	25	100.0%	100.0%
**YO903a Combined PLS	3500.0 mL	22,000	3	77,000	11		

*MgCO₃ precipitate that would form in barren solution overnight

**Accounted for sodium carbonate addition

Loss on Ignition (LOI) = 60.5%

Purity of MgO = 97.7%

Assayed Compounds from Caclined Product

Al ₂ O ₃	BaO	CaO	Cr ₂ O ₃	Fe ₂ O ₃	K ₂ O	MgO	MnO	Na ₂ O
%	%	%	%	%	%	%	%	%
<0.01	<0.01	1.71	<0.01	0.05	0.02	97.7	0.33	<0.01
P ₂ O ₅	SiO ₂	TiO ₂	SrO	V ₂ O ₅	Total			
%	%	%	%	%	%			
<0.01	0.26	0.01	<0.01	<0.01	100			

Note:

Carbonate precipitate formed in the barren solution overnight was included in determining the "**Calcined MgO Product**"

Appendix H

Assay Summary

- a) **Head Assay Summary**
- b) **YO901 Test Work Solution ICP Assays**
- c) **YO902 Test Work Solution ICP Assays**
- d) **YO903 Test Work Solution ICP Assays**
- e) **Leach Residue ICP Assays**
- f) **Product Assay Summary**



MS1358: WHY Head Assay Summary

Sample Number	Sample Description	ICP Au ppm	ICP Pd ppm	ICP Pt ppm	ICP Ag ppm	ICP Al %	ICP As ppm	ICP Ba ppm	ICP Bi ppm	ICP Ca %	ICP Cd ppm	ICP Co ppm	ICP Cr ppm	ICP Cu ppm	ICP Fe %	ICP Hg ppm	ICP K %
88330	Head (P80 = 183 µm)				0.3	0.1	34	<10	3	0.46	<0.5	111	399	<1	3.72	<3	0.02
88331, 88944	Head (P80 = 95 µm)				0.2	0.11	34	<10	<2	0.46	<0.5	113	480	8	4.08	<3	0.02
88332, 90950	Head (P80 = 59 µm)	0.065	0.005	<0.005	0.2	0.11	30	<10	<2	0.46	<0.5	113	633	9	4.41	<3	0.02

Sample Number	Sample Description	ICP La ppm	ICP Mg %	ICP Mn ppm	ICP Mo ppm	ICP Na %	ICP Ni ppm	ICP P ppm	ICP Pb ppm	ICP Sb ppm	ICP Sc ppm	ICP Sr ppm	ICP Ti %	ICP Tl ppm	ICP V ppm	ICP W ppm	ICP Zn ppm	ICP Zr ppm
88330	Head (P80 = 183 µm)	<2	24.0	762	2	<0.01	1,747	23	<2	<2	5	37	<0.01	<10	6	<10	30	<2
88331, 88944	Head (P80 = 95 µm)	<2	23.4	775	3	<0.01	1,789	26	<2	<2	5	38	<0.01	<10	7	<10	32.0	<2
88332, 90950	Head (P80 = 59 µm)	<2	23.7	787	4	<0.01	1,809	47	3	<2	5	38	<0.01	<10	8	<10	29.0	<2



MS1358: YO901 Solution ICP Assay Summary

Sample Number	Test	Sample Description	ICP Al ppm	ICP Sb ppm	ICP As ppm	ICP Ba ppm	ICP Be ppm	ICP Bi ppm	ICP B ppm	ICP Cd ppm	ICP Ca ppm	ICP Cr ppm	ICP Co ppm	ICP Cu ppm	ICP Fe ppm	ICP Pb ppm	ICP Li ppm	ICP Mg ppm
93733	YO901a	Barren Solution	<10	<10	<10	<0.50	<0.25	<10	<5.0	<0.50	4	<0.50	<0.50	<0.50	<1.5	<2.5	<0.50	3,300
93734	YO901a	MgCO3 Water Wash 1	<2.0	<2.0	<2.0	<0.10	<0.050	<2.0	<1.0	<0.10	19	<0.10	<0.10	<0.10	<0.30	<0.50	0.12	825
93735	YO901a	MgCO3 Water Wash 2	<1.0	<1.0	<1.0	<0.050	<0.025	<1.0	<0.50	<0.050	11	<0.050	<0.050	<0.050	<0.15	<0.25	<0.050	395
93738	YO901b	Combined PLS	63	<10	<10	<0.50	<0.25	<10	<5.0	<0.50	415	14.6	2.77	1.26	2,780.0	<2.5	0.63	20,100
93739	YO901b	Re-Pulp Wash 1	46	<10	<10	<0.50	<0.25	<10	<5.0	<0.50	491	10.2	2.04	1.06	2,030.0	<2.5	<0.50	15,100
93740	YO901b	Re-Pulp Wash 2	11	<1.0	<1.0	<0.050	<0.025	<1.0	1.0	<0.050	430	2.2	0.45	0.55	394.0	<0.25	0.79	3,150
93741	YO901b	Re-Pulp Wash 3	1	<1.0	<1.0	<0.050	<0.025	<1.0	<0.50	<0.050	310	0.3	0.09	0.24	34.4	<0.25	0.29	399

Sample Number	Test	Sample Description	ICP Mn ppm	ICP Mo ppm	ICP Ni ppm	ICP P ppm	ICP K ppm	ICP Se ppm	ICP Si ppm	ICP Ag ppm	ICP Na ppm	ICP Sr ppm	ICP Tl ppm	ICP Sn ppm	ICP Ti ppm	ICP V ppm	ICP Zn ppm
93733	YO901a	Barren Solution	<0.25	<1.5	<2.5	<15	<100	<10	4.60	<0.50	19,700	<0.25	<10	<1.5	<0.50	<1.5	<0.25
93734	YO901a	MgCO3 Water Wash 1	<0.050	<0.30	<0.50	<3.0	<20	<2.0	1.38	<0.10	5,440	0.21	<2.0	<0.30	<0.10	<0.30	<0.050
93735	YO901a	MgCO3 Water Wash 2	<0.025	<0.15	<0.25	<1.5	<10	<1.0	0.60	<0.050	543	0.07	<1.0	<0.15	<0.050	<0.15	<0.025
93738	YO901b	Combined PLS	68.7	<1.5	103.0	<15	<100	<10	55.90	<0.50	<100	2.77	<10	<1.5	1.15	<1.5	1.95
93739	YO901b	Re-Pulp Wash 1	50.1	<1.5	78.2	<15	<100	<10	34.90	<0.50	<100	2.5	<10	<1.5	0.77	<1.5	1.65
93740	YO901b	Re-Pulp Wash 2	10.6	<0.15	16.8	<1.5	<10	<1.0	56.70	<0.050	<10	1.24	<1.0	<0.15	0.11	<0.15	0.60
93741	YO901b	Re-Pulp Wash 3	1.4	<0.15	2.5	<1.5	<10	<1.0	24.60	<0.050	<10	0.777	<1.0	<0.15	<0.050	<0.15	0.29



MS1358: YO902 Solution ICP Assay Summary

Sample Number	Test	Sample Description	ICP Al ppm	ICP Sb ppm	ICP As ppm	ICP Ba ppm	ICP Be ppm	ICP Bi ppm	ICP B ppm	ICP Cd ppm	ICP Ca ppm	ICP Cr ppm	ICP Co ppm	ICP Cu ppm	ICP Fe ppm	ICP Pb ppm	ICP Li ppm	ICP Mg ppm
93742	YO902a	PLS	<20	<20	<20	<1.0	<0.50	<20	<10	<1.0	4	<1.0	<1.0	<1.0	<3.0	<5.0	<1.0	70,200
93743	YO902a	Combined PLS	<10	<10	<10	<0.50	<0.25	<10	<5.0	<0.50	404	<0.50	<0.50	<0.50	<1.5	<2.5	<0.50	26,800
93745	YO902a	Re-Pulp Wash 1	<10	<10	<10	<0.50	<0.25	<10	<5.0	<0.50	469	<0.50	<0.50	<0.50	<1.5	<2.5	<0.50	22,500
93746	YO902a	Re-Pulp Wash 2	<2.0	<2.0	<2.0	<0.10	<0.050	<2.0	2.4	<0.10	338	<0.10	<0.10	<0.10	0.4	<0.50	0.30	5,780
93744	YO902a	Barren Solution	<4.0	<4.0	<4.0	<0.20	<0.10	<4.0	<2.0	<0.20	25	<0.20	<0.20	<0.20	<0.60	<1.0	<0.20	2,460
93747	YO902a	MgCO3 Water Wash 1	<1.0	<1.0	<1.0	<0.050	<0.025	<1.0	0.6	<0.050	52	<0.050	<0.050	<0.050	<0.15	<0.25	0.08	1,090
93748	YO902a	MgCO3 Water Wash 2	<1.0	<1.0	<1.0	<0.050	<0.025	<1.0	<0.50	<0.050	13	<0.050	<0.050	<0.050	<0.15	<0.25	0.07	603
93749	YO902b	PLS + Re-Pulp Wash 1	117	<20	<20	<1.0	<0.50	<20	<10	<1.0	401	24.7	4.90	2.20	5,280.0	<5.0	3.00	39,100
93750	YO902b	Re-Pulp Wash 2	8	<1.0	<1.0	<0.050	<0.025	<1.0	1.0	<0.050	428	1.6	0.59	0.35	275.0	<0.25	0.28	2,720
93751	YO902b	Combined PLS	86	<10	<10	<0.50	<0.25	<10	6.7	<0.50	378	18.2	3.55	1.57	3,780.0	<2.5	2.21	27,300

Sample Number	Test	Sample Description	ICP Mn ppm	ICP Mo ppm	ICP Ni ppm	ICP P ppm	ICP K ppm	ICP Se ppm	ICP Si ppm	ICP Ag ppm	ICP Na ppm	ICP Sr ppm	ICP Ti ppm	ICP Sn ppm	ICP Ti ppm	ICP V ppm	ICP Zn ppm
93742	YO902a	PLS	58.5	<3.0	14.8	<30	<200	<20	29.70	<1.0	<200	5.15	<20	<3.0	<1.0	<3.0	<0.50
93743	YO902a	Combined PLS	19.5	<1.5	6.5	<15	<100	<10	34.40	<0.50	<100	2.67	<10	<1.5	<0.50	<1.5	<0.25
93745	YO902a	Re-Pulp Wash 1	13.2	<1.5	5.5	<15	<100	<10	33.50	<0.50	<100	2.42	<10	<1.5	<0.50	<1.5	<0.25
93746	YO902a	Re-Pulp Wash 2	2.8	<0.30	2.4	<3.0	<20	<2.0	42.90	<0.10	<20	1.49	<2.0	<0.30	<0.10	<0.30	<0.050
93744	YO902a	Barren Solution	<0.10	<0.60	<1.0	<6.0	<40	<4.0	5.80	<0.20	14,400	0.24	<4.0	<0.60	<0.20	<0.60	<0.10
93747	YO902a	MgCO3 Water Wash 1	<0.025	<0.15	<0.25	<1.5	<10	<1.0	1.65	<0.050	4,220	0.406	<1.0	<0.15	<0.050	<0.15	<0.025
93748	YO902a	MgCO3 Water Wash 2	<0.025	<0.15	<0.25	<1.5	<10	<1.0	1.02	<0.050	1,460	0.295	<1.0	<0.15	<0.050	<0.15	<0.025
93749	YO902b	PLS + Re-Pulp Wash 1	132.0	<3.0	194.0	<30	<200	<20	78.10	<1.0	<200	4.06	<20	<3.0	2.10	<3.0	3.48
93750	YO902b	Re-Pulp Wash 2	9.1	<0.15	18.0	<1.5	<10	<1.0	74.40	<0.050	<10	1.5	<1.0	<0.15	<0.050	<0.15	0.46
93751	YO902b	Combined PLS	96.1	<1.5	142.0	<15	<100	<10	74.00	<0.50	<100	3.24	<10	<1.5	1.53	<1.5	2.63



MS1358: YO903 Solution ICP Assay Summary

Sample Number	Test	Sample Description	ICP Al ppm	ICP Sb ppm	ICP As ppm	ICP Ba ppm	ICP Be ppm	ICP Bi ppm	ICP B ppm	ICP Cd ppm	ICP Ca ppm	ICP Cr ppm	ICP Co ppm	ICP Cu ppm	ICP Fe ppm	ICP Pb ppm	ICP Li ppm	ICP Mg ppm
93887	YO903a	PLS	<20	<20	<20	<1.0	<0.50	<20	<10	<1.0	4	<1.0	1.90	<1.0	9.9	<5.0	<1.0	45,900
93888	YO903a	Re-Pulp Wash 1	<10	<10	<10	<0.50	<0.25	<10	<5.0	<0.50	433	<0.50	0.71	<0.50	<1.5	<2.5	<0.50	17,700
93889	YO903a	Re-Pulp Wash 2	<4.0	<4.0	<4.0	<0.20	<0.10	<4.0	<2.0	<0.20	284	<0.20	0.21	<0.20	<0.60	<1.0	<0.20	3,900
93891	YO903a	Combined PLS	<10	<10	<10	<0.50	<0.25	<10	<5.0	<0.50	391	<0.50	0.96	<0.50	3.1	<2.5	<0.50	22,000
93890	YO903a	Barren Solution	<4.0	<4.0	<4.0	<0.20	<0.10	<4.0	<2.0	<0.20	21	<0.20	<0.20	<0.20	<0.60	<1.0	<0.20	1,690
93892	YO903a	MgCO3 Water Wash 1	<4.0	<4.0	<4.0	<0.20	<0.10	<4.0	<2.0	<0.20	68	<0.20	<0.20	<0.20	<0.60	<1.0	<0.20	663
93893	YO903a	MgCO3 Water Wash 2	<1.0	<1.0	<1.0	<0.050	<0.025	<1.0	<0.50	<0.050	44	<0.050	<0.050	<0.050	<0.15	<0.25	<0.050	429
93894	YO903a	MgCO3 Water Wash 3	<1.0	<1.0	<1.0	<0.050	<0.025	<1.0	<0.50	<0.050	32	<0.050	<0.050	<0.050	<0.15	<0.25	<0.050	320

Sample Number	Test	Sample Description	ICP Mn ppm	ICP Mo ppm	ICP Ni ppm	ICP P ppm	ICP K ppm	ICP Se ppm	ICP Si ppm	ICP Ag ppm	ICP Na ppm	ICP Sr ppm	ICP Tl ppm	ICP Sn ppm	ICP Ti ppm	ICP V ppm	ICP Zn ppm
93887	YO903a	PLS	128.0	<3.0	57.6	<30	<200	<20	25.80	<1.0	17,200	5.30	<20	<3.0	<1.0	<3.0	<0.50
93888	YO903a	Re-Pulp Wash 1	47.2	<1.5	23.9	<15	<100	<10	26.80	<0.50	6,650	2.67	<10	<1.5	<0.50	<1.5	<0.25
93889	YO903a	Re-Pulp Wash 2	9.8	<0.60	8.3	<6.0	<40	<4.0	27.20	<0.20	1,530	0.92	<4.0	<0.60	<0.20	<0.60	<0.10
93891	YO903a	Combined PLS	59.1	<1.5	29.4	<15	<100	<10	28.00	<0.50	8,110	2.89	<10	<1.5	<0.50	<1.5	<0.25
93890	YO903a	Barren Solution	<0.10	<0.60	<1.0	<6.0	<40	<4.0	5.50	<0.20	15,100	0.23	<4.0	<0.60	<0.20	<0.60	<0.10
93892	YO903a	MgCO3 Water Wash 1	<0.10	<0.60	<1.0	<6.0	<40	<4.0	<1.0	<0.20	1,640	0.52	<4.0	<0.60	<0.20	<0.60	<0.10
93893	YO903a	MgCO3 Water Wash 2	<0.025	<0.15	<0.25	<1.5	<10	<1.0	0.75	<0.050	461	0.297	<1.0	<0.15	<0.050	<0.15	<0.025
93894	YO903a	MgCO3 Water Wash 3	<0.025	<0.15	<0.25	<1.5	<10	<1.0	0.67	<0.050	95	0.194	<1.0	<0.15	<0.050	<0.15	<0.025



MS1358: Leach Residue ICP Assay Summary

Sample Number	Test	Sample Description	ICP Al %	ICP As %	ICP Ca %	ICP Co %	ICP Cr %	ICP Cu %	ICP Fe %	ICP Pb %	ICP Mg %	ICP Mn %	ICP Mo %	ICP Ni %	ICP K %	ICP Si %	ICP S %	ICP Sn %
93752	YO901a	Leach Residue	0.45	0.02	0.56	0.014	0.486	0.013	9.23	0.01	6.60	0.06	<0.005	0.31	0.07	25.30	1.63	0.04
93753	YO901b	Leach Residue	0.37	<0.005	0.35	0.013	0.498	0.007	4.78	<0.005	6.51	0.04	<0.005	0.21	0.06	28.80	0.26	0.04
93754	YO902a	Leach Residue	0.42	0.01	0.45	0.015	0.449	0.008	8.98	<0.005	8.13	0.12	<0.005	0.35	0.06	24.80	1.50	0.03
93755	YO902b	Leach Residue	0.36	<0.005	0.68	0.013	0.423	0.004	4.56	<0.005	6.73	0.04	<0.005	0.20	0.06	28.70	0.61	0.03
93884	YO903a	Leach Residue	0.47	0.01	0.49	0.015	0.481	0.010	8.55	<0.005	6.96	0.07	<0.005	0.34	<0.05	25.40	1.57	0.03

Sample Number	Test	Sample Description	ICP Ti %	ICP V %	ICP Zn %
93752	YO901a	Leach Residue	0.01	<0.005	0.02
93753	YO901b	Leach Residue	0.01	<0.005	0.01
93754	YO902a	Leach Residue	0.01	0.01	0.01
93755	YO902b	Leach Residue	0.01	<0.005	0.01
93884	YO903a	Leach Residue	0.01	<0.005	0.01



MS1358: WHY Product Assay Summary

Lithium Borate Fusion - Summation of Oxides, XRF finish (CARBONATE PRECIPITATE PRODUCT - After Roasting)

Sample Number	Sample Description	Al ₂ O ₃ %	BaO %	CaO %	Cr ₂ O ₃ %	Fe ₂ O ₃ %	K ₂ O %	MgO %	MnO %	Na ₂ O %	P ₂ O ₅ %	SiO ₂ %	TiO ₂ %	SrO %	V ₂ O ₅ %	Total %
93756	YO901a	<0.01	<0.01	0.18	<0.01	<0.01	0.06	100	0.03	<0.01	<0.01	<0.01	0.06	<0.01	<0.01	100.3
93758	YO902a	<0.01	0.01	1.34	<0.01	<0.01	0.11	97.7	0.08	0.43	0.01	0.07	<0.01	<0.01	<0.01	99.8
93886	YO903a	<0.01	<0.01	1.71	<0.01	0.05	0.02	97.7	0.33	<0.01	<0.01	0.26	0.01	<0.01	<0.01	100.1

Lithium Borate Fusion - Summation of Oxides, XRF finish (CARBONATE PRECIPITATE PRODUCT - Before Roasting)

Sample Number	Sample Description	Al ₂ O ₃ %	BaO %	CaO %	Cr ₂ O ₃ %	Fe ₂ O ₃ %	K ₂ O %	MgO %	MnO %	Na ₂ O %	P ₂ O ₅ %	SiO ₂ %	TiO ₂ %	SrO %	V ₂ O ₅ %	LOI %	Total %
93756	YO901a	<0.01	<0.01	0.07	<0.01	<0.01	<0.01	39.2	0.01	<0.01	<0.01	<0.01	<0.01	<0.01	<0.01	61.4	101.0
93758	YO902a	<0.01	<0.01	0.56	<0.01	0.01	<0.01	39.6	0.04	0.27	<0.01	0.07	0.01	<0.01	<0.01	59.5	100.0
93886	YO903a	0.04	<0.01	0.69	<0.01	0.02	0.01	37.9	0.13	0.03	<0.01	0.3	<0.01	<0.01	<0.01	60.5	99.6

Appendix I

Particle Size Analysis

- a) Particle Size Analysis of YO400 Head (P80 = 228 microns)**
- b) Particle Size Analysis of YO800 Head (P80 = 53 microns)**



PARTICLE SIZE ANALYSIS

Client: West High Yield Resources

Test: 14min Grind PSA YO400

Sample: WHY Head (Fine Crushed)
10 kg sample

Date: 20-Mar-12

Project: MS1358

Sieve Size		Weight		Cumulative (%)	
US Mesh	Microns	(g)	(%)	Retained	Passing
8	2,360	0.0			
10	2,000	0.0			
16	1,180	0.0			
20	850	0.0			
30	600	0.0			
40	425	1.7	1.29	1.29	98.71
50	300	12.9	9.78	11.07	88.93
70	212	18.6	14.10	25.17	74.83
100	150	14.6	11.07	36.24	63.76
140	106	11.1	8.42	44.66	55.34
200	75	9.8	7.43	52.08	47.92
270	53	7.8	5.91	58.00	42.00
400	37	9.2	6.97	64.97	35.03
Undersize	-37	46.2	35.03	100.00	
TOTAL:		131.9	100.0		

Rosin-Rammler Model

Size (um)	Passing P (%)
228	80
80	50

Linear Interpolation

Size (um)	Passing P (%)
244	80
84	50

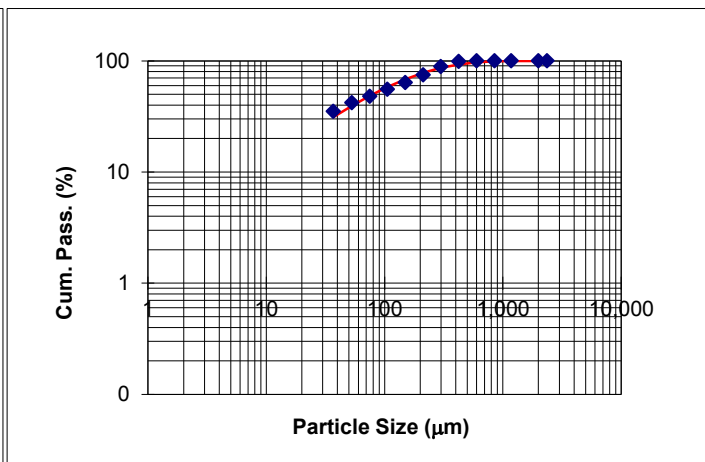
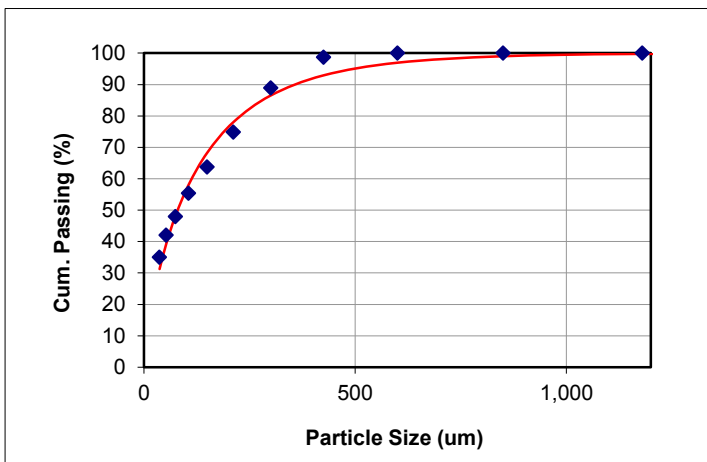



PARTICLE SIZE ANALYSIS

Client: West High Yield Resources

Test: YO800 (40 min grind PSA)

Sample: WHY Head (Fine Crushed, Mid-Grade)

Date: 03-Dec-12

Project: MS1358

Sieve Size		Weight		Cumulative (%)	
US Mesh	Microns	(g)	(%)	Retained	Passing
8	2,360	0.0			
10	2,000	0.0			
16	1,180	0.0			
20	850	0.0			
30	600	0.0			
40	425	0.0			
50	300	0.0			
70	212	0.0			
100	150	0.4	0.20	0.20	99.80
140	106	5.0	2.51	2.71	97.29
200	75	11.6	5.82	8.53	91.47
270	53	24.0	12.04	20.57	79.43
400	37	26.7	13.40	33.97	66.03
Undersize	-37	131.6	66.03	100.00	
TOTAL:		199.3	100.0		

Rosin-Rammler Model

Size (um)	Passing P (%)
53	80
25	50

Linear Interpolation

Size (um)	Passing P (%)
54	80
19	50

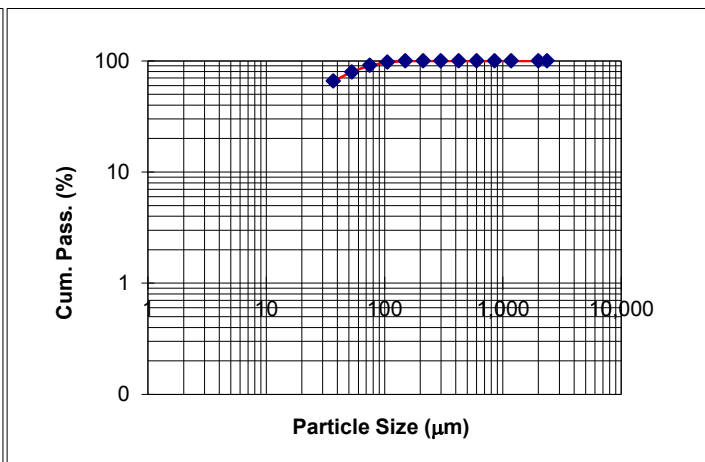
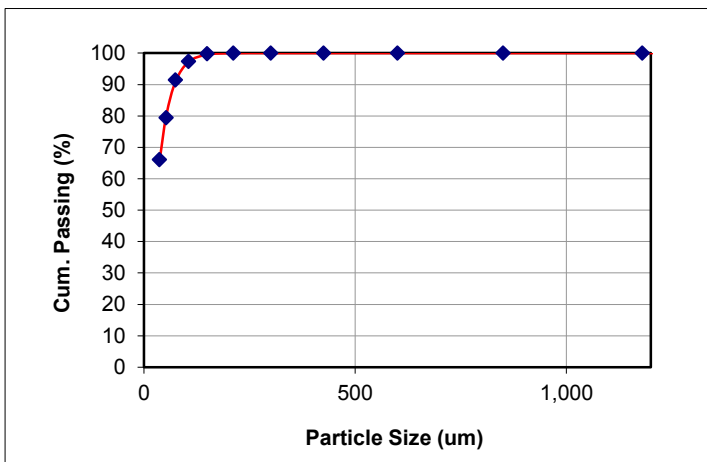

Appendix D: Certificates of Qualified Persons

CERTIFICATE OF AUTHOR

I, Bart A. Stryhas PhD, CPG # 11034, do hereby certify that:

1. I am a Principal Associate Resource Geologist of SRK Consulting (U.S.), Inc., 7175 W. Jefferson Ave, Suite 3000, Denver, CO, USA, 80235.
2. This certificate applies to the technical report titled "Revised NI 43-101 Technical Report, Preliminary Economic Assessment, Record Ridge Project, British Columbia, Canada" with an Effective Date of April 18, 2013, and a Report Date of June 3, 2013 (the "Technical Report").
3. I graduated with a Doctorate degree in Structural Geology from Washington State University in 1988. In addition, I have obtained a Master of Science degree in Structural Geology from the University of Idaho in 1985 and a Bachelor of Arts degree in Geology from the University of Vermont in 1983. I am a current member of the American Institute of Professional Geologists. I have worked as a Geologist for a total of 30 years since my graduation from university. My relevant experience includes minerals exploration, mine geology, project development and resource estimation. I have conducted resource estimations since 1988 and have been involved in technical reports since 2004.
4. I have read the definition of "qualified person" set out in National Instrument 43-101 (NI 43-101) and certify that by reason of my education, affiliation with a professional association (as defined in NI 43-101) and past relevant work experience, I fulfill the requirements to be a "qualified person" for the purposes of NI 43-101.
5. I visited the Record Ridge property on November 18, 2008 for two days.
6. I am responsible for the preparation of Sections 1, 2.1, 2.2, 2.3, 3 through 10, and 12 of the Technical Report.
7. I am independent of the issuer applying all of the tests in section 1.5 of NI 43-101.
8. I have had prior involvement with the property that is the subject of the Technical Report. I was the QP for the report titled "*NI 43-101 Technical Report on Resources, West High Yield Resources Ltd., Record Ridge South, Rossland, British Columbia*, dated February 11, 2009.
9. I have read NI 43-101 and Form 43-101-F1 and the sections of the Technical Report I am responsible for have been prepared in compliance with that instrument and form.
10. As of the aforementioned effective date, to the best of my knowledge, information and belief, the sections of the Technical Report I am responsible for contains all scientific and technical information that is required to be disclosed to make the Technical Report not misleading.

Dated this 3rd Day of June, 2013.

"Signed"

Bart A. Stryhas PhD, CPG

U.S. Offices:

Anchorage	907.677.3520
Denver	303.985.1333
Elko	775.753.4151
Fort Collins	970.407.8302
Reno	775.828.6800
Tucson	520.544.3688

Mexico Office:

Guadalupe, Zacatecas	52.492.927.8982
----------------------	-----------------

Canadian Offices:

Saskatoon	306.955.4778
Sudbury	705.682.3270
Toronto	416.601.1445
Vancouver	604.681.4196
Yellowknife	867.873.8670

Group Offices:

Africa
Asia
Australia
Europe
North America
South America

CERTIFICATE OF AUTHOR

I, Bret C. Swanson, B.Eng. (Mining), MAusIMM, MMSAQP do hereby certify that:

1. I am Principal Mining Engineer of SRK Consulting (U.S.), Inc., 7175 W. Jefferson Ave, Suite 3000, Denver, CO, USA, 80235.
2. This certificate applies to the technical report titled "Revised NI 43-101 Technical Report Preliminary Economic Assessment, Record Ridge Project, British Columbia, Canada" with an Effective Date of April 18, 2013, and a Report Date of June 3, 2013 (the "Technical Report").
3. I graduated with a degree in Bachelor of Engineering in Mining Engineering from the University of Wollongong in 1997. I am a current member of the Mining & Metallurgical Society of America #01418QP. I have worked as a Mining Engineer for a total of 15 years since my graduation from university. My relevant experience includes contributions to numerous feasibility, pre-feasibility, preliminary assessment and competent person reports while employed with SRK, Denver. Previously, I worked on the design and implementation of mine planning and scheduling systems, long term mine design with environmental focus, and mine planning corporate standards for Solid Energy, New Zealand. In addition, have worked in various sales and support roles utilizing Vulcan Software and MineSuite Production Statistics where I gained considerable exposure to mining operations and projects around the world.
4. I have read the definition of "qualified person" set out in National Instrument 43-101 (NI 43-101) and certify that by reason of my education, affiliation with a professional association (as defined in NI 43-101) and past relevant work experience, I fulfill the requirements to be a "qualified person" for the purposes of NI 43-101.
5. I visited the Record Ridge property on September 26, 2011, for three days.
6. I am responsible for the preparation of Sections 13, 15, 16, and 18 through 25 of the Technical Report.
7. I am independent of the issuer applying all of the tests in section 1.5 of NI 43-101
8. I have not had prior involvement with the property that is the subject of the Technical Report. The nature of my prior involvement is.
9. I have read NI 43-101 and Form 43-101-F1 and the sections of the Technical Report I am responsible for have been prepared in compliance with that instrument and form.
10. As of the aforementioned effective date, to the best of my knowledge, information and belief, the sections of the Technical Report I am responsible for contains all scientific and technical information that is required to be disclosed to make the Technical Report not misleading.

Dated this 3rd Day of June, 2013.

"Signed"

Bret Swanson, BEng Mining, MAusIMM, MMSAQP

U.S. Offices:

Anchorage	907.677.3520
Denver	303.985.1333
Elko	775.753.4151
Fort Collins	970.407.8302
Reno	775.828.6800
Tucson	520.544.3688

Mexico Office:

Guadalupe, Zacatecas	52.492.927.8982
----------------------	-----------------

Canadian Offices:

Saskatoon	306.955.4778
Sudbury	705.682.3270
Toronto	416.601.1445
Vancouver	604.681.4196
Yellowknife	867.873.8670

Group Offices:

Africa
Asia
Australia
Europe
North America
South America

CERTIFICATE OF AUTHOR

I, Corby G. Anderson CEng FIMMM, FIChemE MMSA QP, do hereby certify that:

1. I am currently employed as an Engineer by: Allihies Engineering Incorporated, P.O. Box 123, Butte, Montana 59703.
2. This certificate applies to the technical report titled "Revised NI 43-101 Technical Report, Preliminary Economic Assessment, Record Ridge Project, British Columbia, Canada" with an Effective Date of April 18, 2013, and a Report Date of June 3, 2013 (the "Technical Report").
3. I graduated with a Bachelor of Science degree in Chemical Engineering from Montana State University 1979, a Master of Science degree in Metallurgical Engineering from Montana Tech in 1984, and a PhD in Mining Engineering – Metallurgy from the University of Idaho in 1987. I am a Qualified Professional as a registered member 01079QP of the Mining and Metallurgical Society of America and as a Fellow of the Institute of Materials, Minerals and Mining. I have worked as an engineer continuously for nearly 34 years since graduation from undergraduate university.
4. I have read the definition of "qualified person" set out in National Instrument 43-101 ("NI 43-101") and certify that by reason of my education, affiliation with a professional association (as defined in NI 43-101) and past relevant work experience, I fulfill the requirements to be a "qualified person" for the purposes of NI 43-101.
5. I visited the laboratories at Met-Solve in Vancouver, B.C., Canada on two separate occasions, in October of 2011 and April of 2012.
6. I am responsible for the preparation of Sections 11: Mineral Processing and Metallurgical Testing and 14: Recovery Methods, of the Technical Report.
7. I am independent of West High Yield Resources Ltd. and all their subsidiaries as defined in Section 1.5 of NI 43-101.
8. I have had no prior involvement with the property or project.
9. I have read NI 43-101 and Form 43-101-F1 and the sections of the Technical Report I am responsible for have been prepared in compliance with that instrument and form.
10. As of the aforementioned effective date, to the best of my knowledge, information and belief, the sections of the Technical Report I am responsible for contains all scientific and technical information that is required to be disclosed to make the Technical Report not misleading.

The Technical Report contains information relating to mineral titles, permitting, environmental issues, regulatory matters and legal agreements. I am not a legal, environmental or regulatory professional, and do not offer a professional opinion regarding these issues.

A copy of this report is submitted as a computer readable file in Adobe Acrobat PDF format.

The requirements of electronic filing necessitate submitting the report as an unlocked, editable file. I accept no responsibility for any changes made to the file after it leaves my control.

Dated this 3rd Day of June, 2013.

"Signed"

"Sealed"

Corby G. Anderson, CEng FIMMM, FIChemE MMSA QP

CERTIFICATE OF QUALIFIED PERSON

I, Arlene Laudrum, residing at 48 Rycon Drive, Yellowknife, NT X1A 2V6 do hereby certify that:

- 1) I am a Senior Consultant with the firm of SRK Consulting (Canada) Inc. ("SRK") with an office at Suite 202, 5204 – 50th Avenue, Yellowknife, NT, Canada X1A 1E2;
- 2) This certificate applies to the technical report titled "Revised NI 43-101 Technical Report, Preliminary Economic Assessment, Record Ridge Project, British Columbia, Canada" with an Effective Date of April 18, 2013, and a Report Date of June 3, 2013 (the "Technical Report").
- 3) I am a graduate of the University of Western Ontario in 1986, I obtained a degree of Bachelor of Science. I have practiced my profession continuously for 27 years. For the past 14 years my experience has focused on the environmental management of mine sites from exploration through to post-closure in Canada. A significant portion of this has related to environmental support for the engineering, construction and closure of mining projects including baseline studies, environmental approvals and remediation management. My earlier experience includes 5 years in mineral exploration, 4 years in mine operations and 4 additional years of conducting environmental studies on mining and exploration sites;
- 4) I am a Professional Geoscientist registered with the Northwest Territories and Nunavut Association of Professional Engineers and Geoscientists (Member Number 1777) and the Association of Professional Engineers and Geoscientists of British Columbia (Licence Number 25206);
- 5) I visited the Record Ridge Property on September 27 and 28, 2011;
- 6) I have read the definition of "qualified person" set out in National Instrument 43-101 and certify that by virtue of my education, affiliation to a professional association and past relevant work experience, I fulfill the requirements to be a "qualified person" for the purposes of National Instrument 43-101 and this technical report has been prepared in compliance with National Instrument 43-101 and Form 43-101F1;
- 7) I, as a qualified person, I am independent of the issuer as defined in Section 1.5 of National Instrument 43-101;
- 8) I am the co-author of this report and responsible for Sections 2.4, 2.5 and 17 and accept professional responsibility for that section of the Technical Report;
- 9) I have had no prior involvement with the subject property;
- 10) I have read National Instrument 43-101 and confirm that this technical report has been prepared in compliance therewith;
- 11) SRK Consulting (Canada) Inc. was retained by West High Yield Resources Ltd. to prepare a technical audit of the Record Ridge Project. In conducting our audit a gap analysis of project technical data was completed using CIM "Best practices" and Canadian Securities Administrators National Instrument 43-101 guidelines. The preceding report is based on a site visit, a review of project files and discussions with West High Yield Resources Ltd. personnel;
- 12) I have not received, nor do I expect to receive, any interest, directly or indirectly, in the Record Ridge Project or securities of West High Yield Resources Ltd.; and
- 13) As of the aforementioned effective date, to the best of my knowledge, information and belief, the sections of the Technical Report I am responsible for contains all scientific and technical information that is required to be disclosed to make the Technical Report not misleading.

Dated this 4th Day of June, 2013.

"Signed"

"Sealed"

Arlene Laudrum, B.Sc., P.Geo.