

**MAGNA GOLD CORP.**

**NI 43-101 F1 TECHNICAL REPORT  
PRE-FEASIBILITY STUDY  
FOR THE  
SAN FRANCISCO GOLD PROJECT  
SONORA, MEXICO**

**Report Date: August 28, 2020  
Effective Date: August 8, 2020**

**Prepared by:**

**William J. Lewis, P.Geo.  
Richard M. Gowans, P.Eng.  
Rodrigo Calles-Montijo, CPG  
Nigel Fung, B.Sc.H, B.Eng., P.Eng.  
Christopher Jacobs, CEng, MIMMM  
Ing. Alan San Martin, MAusIMM(CP)**

**Table of Contents**

<b>1.0</b>	<b>SUMMARY .....</b>	<b>1</b>
1.1	GENERAL.....	1
1.2	PROPERTY DESCRIPTION AND LOCATION.....	1
1.2.1	Magna Acquisition and Ownership of the San Francisco Project .....	2
1.2.2	Mexican Mining Laws .....	2
1.3	ACCESSIBILITY, CLIMATE, PHYSIOGRAPHY, LOCAL RESOURCES AND INFRASTRUCTURE .....	3
1.4	HISTORY .....	3
1.5	GEOLOGICAL SETTING AND MINERALIZATION .....	4
1.6	EXPLORATION PROGRAMS .....	4
1.6.1	Historical Alio Exploration Programs .....	4
1.6.2	Magna Exploration Programs .....	5
1.7	MINERAL RESOURCE AND RESERVE ESTIMATES .....	6
1.7.1	Mineral Resource Estimate .....	6
1.7.2	Mineral Reserve Estimate .....	9
1.8	OPERATIONAL DATA FOR THE SAN FRANCISCO PROJECT .....	10
1.8.1	Mine Plans and Activities .....	11
1.9	METALLURGY AND PROCESSING.....	11
1.10	PROJECT ECONOMICS .....	13
1.10.1	Capital and Operating Costs .....	13
1.10.2	Economic Analysis .....	15
1.10.3	Project Cash Flow .....	17
1.10.4	Sensitivity Study and Risk Assumptions .....	20
1.10.5	Economic Conclusion .....	21
1.11	CONCLUSIONS AND RECOMMENDATIONS .....	21
<b>2.0</b>	<b>INTRODUCTION.....</b>	<b>23</b>
2.1	INFORMATION REGARDING SAN FRANCISCO PROPERTY FROM PREVIOUS MICON REPORTS ALONG WITH UPDATED INFORMATION .....	23
2.2	OTHER INFORMATION .....	24
<b>3.0</b>	<b>RELIANCE ON OTHER EXPERTS .....</b>	<b>28</b>
<b>4.0</b>	<b>PROPERTY DESCRIPTION AND LOCATION .....</b>	<b>29</b>
4.1	GENERAL.....	29
4.2	OWNERSHIP .....	30
4.2.1	Magna Ownership Information.....	30
4.2.2	Magna Acquisition Information.....	33
4.3	MEXICAN MINING LAW .....	38
4.4	PERMITTING AND ENVIRONMENTAL.....	38
<b>5.0</b>	<b>ACCESSIBILITY, CLIMATE, LOCAL RESOURCES, INFRASTRUCTURE AND PHYSIOGRAPHY .....</b>	<b>40</b>

	<b>Page</b>
5.1	ACCESSIBILITY ..... 40
5.2	LOCAL RESOURCES AND INFRASTRUCTURE ..... 41
5.3	CLIMATE AND PHYSIOGRAPHY ..... 42
<b>6.0</b>	<b>HISTORY ..... 43</b>
6.1	SAN FRANCISCO PROPERTY AND GOLD MINE..... 43
6.1.1	General History Prior to Alio Ownership ..... 43
6.1.2	Alio Incorporation and Ownership of the San Francisco Project ..... 46
6.1.3	Magna Ownership of the San Francisco Project..... 47
6.2	HISTORICAL RESOURCE AND RESERVE ESTIMATES ..... 47
6.2.1	Pre-2005 Historical Mineral Resource Estimates ..... 47
6.2.2	2018 Historical Mineral Resource and Reserve Estimates ..... 48
6.3	HISTORICAL PRODUCTION FROM THE SAN FRANCISCO PROJECT..... 50
6.3.1	Historical Production ..... 50
<b>7.0</b>	<b>GEOLOGICAL SETTING AND MINERALIZATION..... 54</b>
7.1	REGIONAL GEOLOGY ..... 54
7.2	PROPERTY GEOLOGY ..... 55
7.2.1	Geology of the La Chicharra Pit ..... 58
7.3	MINERALIZATION ..... 59
7.4	OTHER PROJECTS WITHIN THE SAN FRANCISCO PROPERTY ..... 61
7.4.1	El Durazno Project ..... 61
7.4.2	Vetatierra Project ..... 63
<b>8.0</b>	<b>DEPOSIT TYPES ..... 64</b>
8.1	SAN FRANCISCO MINERAL DEPOSIT ..... 64
<b>9.0</b>	<b>EXPLORATION..... 65</b>
9.1	SUMMARY OF PRIOR EXPLORATION BY ALIO ..... 65
9.2	2013 TO 2015 EXPLORATION PROGRAMS (SAN FRANCISCO AND LA CHICHARRA DEPOSITS) ..... 67
9.3	EL DURAZNO, VETATIERRA, 1B AREA AND LA PIMA PROJECTS ..... 69
9.3.1	El Durazno Project ..... 69
9.3.2	Vetatierra Project ..... 71
9.3.3	1B Area Project..... 72
9.3.4	La Pima Project..... 72
9.4	MAGNA EXPLORATION PROGRAMS FOR THE SAN FRANCISCO PROPERTY ..... 74
9.4.1	San Francisco Mine (San Francisco and La Chicharra Pits)..... 74
9.4.2	Vetatierra Project ..... 80
9.4.3	La Pima Project..... 83
9.5	MICON COMMENTS ..... 84
<b>10.0</b>	<b>DRILLING ..... 85</b>

	<b>Page</b>
10.1 DRILL TYPES AT THE SAN FRANCISCO PROJECT .....	85
10.1.1 Percussion Rotary Air Blast (RAB) Drilling .....	85
10.1.2 Reverse Circulation (RC) Drilling .....	85
10.1.3 Diamond Core Drilling .....	86
10.2 GENERAL INFORMATION .....	88
10.3 DRILLING PRIOR TO 2014 .....	88
10.3.1 Alio Exploration Programs Since 2005 .....	88
10.4 EXPLORATION AND IN-FILL DRILLING 2014 TO 2015 AT THE SAN FRANCISCO MINE .....	102
10.4.1 2014 In-fill RC Drilling on Phase 3 from Bench 530 .....	102
10.4.2 2014 In-fill RC Drilling on Phase 4 from Bench 650 .....	106
10.4.3 Exploration and In-fill Drilling along the South Wall of the San Francisco Pit, Phase 5 .....	109
10.4.4 2015, In-fill RC Drilling Below Phase 4 of the San Francisco Pit .....	116
10.5 EXPLORATION DRILLING 2014 TO 2015 ON THE SAN FRANCISCO PROPERTY .....	117
10.5.1 RAB Drilling North of the San Francisco Mine .....	118
10.5.2 La Mexicana – Vetatierra RAB Drilling .....	121
10.5.3 1B Area RC and Core Drilling in 2014 .....	121
10.5.4 Vetatierra Area .....	127
10.6 IN-FILL DRILLING JULY, 2016 TO MARCH, 2017 AT THE SAN FRANCISCO PROJECT .....	133
10.7 2017 IN-FILL DRILLING PROGRAM FOR THE SAN FRANCISCO MINE .....	142
10.8 2018 IN-FILL DRILLING PROGRAM FOR THE SAN FRANCISCO MINE .....	153
10.9 MAGNA DRILLING PROGRAMS .....	159
10.10 MICON COMMENTS .....	160
<b>11.0 SAMPLE PREPARATION, ANALYSES AND SECURITY .....</b>	<b>161</b>
11.1 ALIO SAMPLE PREPARATION, ANALYSIS AND SECURITY PROGRAMS .....	161
11.2 REVERSE CIRCULATION DRILLING .....	161
11.3 CORE DRILLING .....	163
11.4 SAMPLE COLLECTION AND TRANSPORTATION .....	164
11.4.1 Reverse Circulation Drilling .....	164
11.4.2 RAB Drilling .....	165
11.4.3 Core Drilling .....	166
11.4.4 General QA/QC Procedures .....	166
11.4.5 Preparation Laboratories .....	170
11.5 QA/QC PROGRAM RESULTS .....	177
11.5.1 July, 2010 to June, 2011 QA/QC Program Results .....	177
11.5.2 July, 2011 to June 2013 QA/QC Program Results .....	180
11.6 RESULTS OF THE JANUARY, 2014 TO DECEMBER, 2015 QA/QC PROGRAM .....	184

	<b>Page</b>
11.6.1 Screen Metallic Assaying .....	184
11.7 RESULTS OF THE AUGUST, 2016 TO MARCH, 2017 QA/QC PROGRAM.....	187
11.7.1 Standard Reference Material Samples .....	187
11.7.2 Duplicates .....	193
11.7.3 Blank Samples .....	194
11.8 2017 AND 2018 DRILLING PROGRAM QA/QC.....	197
11.8.1 August to December, 2017 Drilling Program QA/QC.....	197
11.8.2 2018 Drilling Program QA/QC.....	197
11.9 MICON COMMENTS .....	201
<b>12.0 DATA VERIFICATION .....</b>	<b>202</b>
12.1 NOTES FROM PREVIOUS ALIO SITE VISITS .....	203
12.2 2017 SITE VISIT.....	203
12.3 2020 SITE VISIT.....	203
12.4 MICON DATA VERIFICATION FOR MAGNA RESOURCES AND RESERVES .....	204
12.5 GENERAL MICON COMMENTS.....	207
<b>13.0 MINERAL PROCESSING AND METALLURGICAL TESTING.....</b>	<b>209</b>
13.1 2012 TESTWORK BY METCON .....	209
13.1.1 Discussion of the 2012 Test Results .....	209
13.2 ON-SITE INTERNAL TESTWORK .....	211
13.2.1 Discussion of Column Test Results .....	213
13.3 MICON COMMENTS/CONCLUSIONS .....	214
<b>14.0 MINERAL RESOURCE ESTIMATES.....</b>	<b>215</b>
14.1 INTRODUCTION .....	215
14.2 CIM MINERAL RESOURCE DEFINITIONS AND CLASSIFICATIONS.....	215
14.3 CIM ESTIMATION OF MINERAL RESOURCES BEST PRACTICES GUIDELINES.....	217
14.4 AUGUST 8, 2020 MINERAL RESOURCE ESTIMATE STATEMENT.....	217
14.5 MINERAL RESOURCE ESTIMATION PROCEDURES .....	218
14.5.1 Database.....	218
14.5.2 Compositing.....	221
14.5.3 Block Model.....	221
14.5.4 Mineralized Outlines.....	222
14.5.5 Block Model Rock Domains.....	222
14.5.6 Specific Gravity .....	222
14.5.7 Grade Interpolation .....	223
14.5.8 Mineral Resource Classification .....	224
14.5.9 Block Model Validation.....	224
14.5.10 Resource Pit Optimization and Economic Parameters .....	226
<b>15.0 MINERAL RESERVE ESTIMATES.....</b>	<b>229</b>

	<b>Page</b>
15.1 INTRODUCTION .....	229
15.2 CIM MINERAL RESERVE DEFINITIONS AND CLASSIFICATIONS.....	229
15.3 MINERAL RESERVE ANALYSIS.....	230
15.3.1 Reserve Pit Optimization and Economic Analysis .....	230
15.4 MINING RECOVERY AND DILUTION .....	230
15.5 AUGUST 8, 2020 MINERAL RESERVE ESTIMATE STATEMENT.....	231
15.6 RECONCILIATION.....	231
<b>16.0 MINING METHODS .....</b>	<b>232</b>
16.1 MINING PRODUCTION TO DATE.....	232
16.2 OPEN PIT MINE DESIGN .....	232
16.2.1 Geotechnical Studies and Slope Design Criteria .....	232
16.2.2 2016 Southwall Stability.....	236
16.2.3 Hydrological Considerations .....	236
16.2.4 Phased Pit Designs.....	237
16.2.5 Waste Rock Management .....	237
16.3 OPEN PIT MINE OPERATIONS.....	255
16.4 UNDERGROUND DESIGN AND OPERATIONS .....	255
16.4.1 Underground Design.....	255
16.4.2 Underground Operations.....	256
16.5 PRODUCTION SCHEDULE.....	258
<b>17.0 RECOVERY METHODS .....</b>	<b>260</b>
17.1 PROCESSING DESCRIPTION.....	260
17.1.1 Crushing and Conveying.....	260
17.1.2 Leaching.....	260
17.1.3 Adsorption/Desorption/Recovery Plants .....	262
17.1.4 Process Plant Layout.....	265
17.1.5 Manpower .....	267
17.1.6 Consumables and Maintenance.....	267
17.2 SCHEDULE OF GOLD PRODUCTION.....	267
<b>18.0 PROJECT INFRASTRUCTURE.....</b>	<b>269</b>
18.1 ADMINISTRATION, ENGINEERING AND EXISTING INFRASTRUCTURE .....	269
18.1.1 Manpower Organization .....	269
18.1.2 Offices, Workshops and Stores.....	270
18.1.3 Electrical Power Supply.....	273
18.1.4 Water Supply .....	273
<b>19.0 MARKET STUDIES AND CONTRACTS.....</b>	<b>275</b>
19.1 MARKET AND MARKET STUDIES.....	275
19.2 MINING CONTRACTS.....	276
19.2.1 Contractor Requirements .....	276
19.2.2 Owner Mining Requirements.....	277
19.2.3 Magna Discussions with the Mining Contractor .....	277

	<b>Page</b>
19.3 REFINING AND SALES CONTRACTS .....	277
19.3.1 Refining Agreement.....	277
19.3.2 Master Purchase Contract and Bill of Sale and Trading Agreement .....	278
19.3.3 Blasting Services.....	278
<b>20.0 ENVIRONMENTAL STUDIES, PERMITTING AND SOCIAL OR COMMUNITY IMPACT.....</b>	<b>279</b>
20.1 DETAILS FROM THE MAY 25, 2017 TECHNICAL REPORT .....	279
20.1.1 Environmental Considerations.....	279
20.1.2 Community and Social Considerations.....	280
20.2 MAGNA ENVIRONMENTAL, SOCIAL AND COMMUNITY ACTIVITIES .....	282
<b>21.0 CAPITAL AND OPERATING COSTS.....</b>	<b>283</b>
21.1 CAPITAL COSTS .....	283
21.2 OPERATING COSTS .....	283
21.2.1 Mine Operating Costs .....	284
21.2.2 Processing Operating Costs .....	284
21.2.3 General and Administration Costs .....	284
21.2.4 Selling Costs .....	284
<b>22.0 ECONOMIC ANALYSIS .....</b>	<b>285</b>
22.1 CAUTIONARY STATEMENT .....	285
22.2 BASIS OF EVALUATION .....	286
22.3 MACRO-ECONOMIC ASSUMPTIONS .....	286
22.3.1 Exchange Rate and Inflation.....	286
22.3.2 Weighted Average Cost of Capital .....	286
22.3.3 Expected Metal Prices.....	286
22.3.4 Taxation Regime.....	287
22.3.5 Royalty .....	287
22.4 TECHNICAL ASSUMPTIONS.....	287
22.4.1 Mine Production Schedule.....	287
22.4.2 Processing Schedule.....	288
22.4.3 Project Cash Flow .....	289
22.5 SENSITIVITY STUDY AND RISK ANALYSIS .....	291
22.5.1 Metal Price and Exchange Rate Assumptions .....	291
22.6 CONCLUSION.....	293
<b>23.0 ADJACENT PROPERTIES .....</b>	<b>294</b>
<b>24.0 OTHER RELEVANT DATA AND INFORMATION .....</b>	<b>295</b>
<b>25.0 INTERPRETATION AND CONCLUSIONS .....</b>	<b>296</b>
25.1 OVERVIEW .....	296
25.2 MINERAL RESOURCES, MINERAL RESERVES AND PRODUCTION SCHEDULE.....	296

	<b>Page</b>
25.3 PROJECT ECONOMICS .....	297
25.3.1 Capital and Operating Costs .....	297
25.3.2 Economic Analysis .....	298
25.3.3 Economic Conclusion .....	298
<b>26.0 RECOMMENDATIONS.....</b>	<b>300</b>
26.1 MAGNA EXPLORATION BUDGETS.....	300
26.1.1 San Francisco Mine (San Francisco and La Chicharra Pits) 2020- 2021 Exploration Program .....	300
26.1.2 Vetatierra Project 2020 Exploration Program.....	301
26.1.3 La Pima Project 2020 Exploration Program .....	302
26.2 FURTHER RECOMMENDATIONS.....	304
<b>27.0 DATE AND SIGNATURE PAGES.....</b>	<b>305</b>
<b>28.0 REFERENCES.....</b>	<b>307</b>
28.1 TECHNICAL REPORTS, PAPERS AND OTHER SOURCES.....	307
28.2 INTERNET SOURCES .....	313
<b>29.0 CERTIFICATES OF AUTHORS .....</b>	<b>314</b>

### List of Appendices

APPENDIX I	GLOSSARY OF TERMS
APPENDIX II	TITLE OPINION: MINING CONCESSIONS SAN FRANCISCO PROJECT
APPENDIX III	VIEWS OF THE SAN FRANCISCO AND LA CHICHARRA PITS FROM 2008 TP 2020 AND DIAGRAMS SHOWING THE YEARLY GROWTH OF THE PITS FROM 2009 TO 2019
APPENDIX IV	EXTRACTS FROM ALIO GOLD 2017 TO 2020 PRESS RELEASES REGARDING THE SAN FRANCISCO PROJECT



**List of Tables**

Table 1.1	Pit Optimization Parameters for the August 8, 2020 Resource Estimate for the San Francisco and La Chicharra Deposits .....	7
Table 1.2	Underground Parameters for the August 8, 2020 Resource Estimate for the San Francisco Project .....	8
Table 1.3	Mineral Resource Estimate for the San Francisco and La Chicharra Deposits as of August 8, 2020 .....	9
Table 1.4	Mineral Reserves within the San Francisco and La Chicharra Pit Design (August 8, 2020) after Mining Recovery and Dilution .....	10
Table 1.5	Combined San Francisco and La Chicharra Pits and Underground LOM Production Schedule .....	12
Table 1.6	Summary of the Leach Pad Phases Based Upon the Permits Acquired for the San Francisco Mine .....	13
Table 1.7	Annual Gold Production .....	14
Table 1.8	Capital Cost Summary .....	15
Table 1.9	Summary of Life-of-Mine Operating Costs .....	15
Table 1.10	Life-of-Mine Cash Flow Summary .....	18
Table 1.11	Base Case Life-of-Mine Annual Cash Flow .....	19
Table 1.12	Sensitivity of NPV <sub>5</sub> to Gold Price .....	21
Table 1.13	Total Estimated Exploration Expenditures for Magna’s Three Focus Areas on the San Francisco Property .....	22
Table 2.1	List of Abbreviations .....	25
Table 4.1	San Francisco Project, Summary of Mineral Concessions .....	31
Table 4.2	San Francisco Project, Summary of the Regional Mineral Concessions .....	34
Table 6.1	San Francisco Project – Historical Reserves and Resources as of July 1, 2018 .....	49
Table 6.2	San Francisco Project, Geomaque Annual Production 1996 to 2002 .....	50
Table 6.3	San Francisco Project, Annual Production from April, 2010 to the End of December, 2019 (by Quarter) .....	52
Table 6.4	San Francisco Project, Annual Ore Stockpiled and Processed from April, 2010 to the End of December, 2019 (by Quarter) .....	53
Table 9.1	Summary of the Exploration Expenditures for the Period July, 2013 to December, 2015 .....	68
Table 9.2	Summary of Magna’s Proposed RC Drilling Program for the San Francisco Project .....	78

Table 9.3	Estimated Budget for the 2020-2021 Infill and Exploration Drilling Programs at the San Francisco Project.....	79
Table 9.4	Estimated Budget for the 2020 Exploration Program at the Vetatierra Project .....	82
Table 9.5	Estimated Budget for the 2020 Exploration Program at the La Pima Project .....	84
Table 10.1	Summary of the Location and Significant Assays for the RC Drilling on Phase 3 from Bench 530 to 536 .....	104
Table 10.2	Summary of the Location and Significant Assays for the RC Drilling on Phase 4 from Bench 650 .....	106
Table 10.3	Summary of the Location and Significant Assays for the RC Drilling on Phase 5 between Sections 880W to 1160W.....	110
Table 10.4	Summary of the Location and Significant Assays for the Core Drilling on Phase 5 between Sections 880W to 1160W.....	114
Table 10.5	Summary of the Location and Significant Assays for the RC Drilling Below Phase 4 of the San Francisco Pit.....	116
Table 10.6	Summary of the Location, Type, Metres Drilled and Number of Drill Holes for the Programs North of the San Francisco Pit.....	118
Table 10.7	Summary of the Most Significant RAB Drill Intersections along Section 3500W .....	120
Table 10.8	Summary of the Most Significant RAB Drill Intersections along Section 4100W .....	120
Table 10.9	Summary of the Significant RAB Drill Intersections along Section 4700W .....	120
Table 10.10	Summary of the Significant RAB Drilling Results for the Area Between the La Mexicana and La Vetatierra Projects.....	121
Table 10.11	Summary of Significant 2014 RC Drilling Intersections in the 1B Area.....	122
Table 10.12	Summary of the Significant Assay Results for the Three Core Holes Drilled in the 1B Area.....	126
Table 10.13	Summary of the Significant 2014 Core Intersections at the Vetatierra Program.....	128
Table 10.14	Summary of the Significant 2014 RC Intersections at the Vetatierra Program.....	131
Table 10.15	Summary of the Location and Significant Assays for the RC Drilling between July, 2016 and March, 2017 .....	134

Table 10.16	Significant Assay Intercepts, August to December, 2017 Reverse Circulation Drill Program .....	143
Table 10.17	Summary of the 2018 Monthly RC In-fill Drilling .....	154
Table 10.18	Significant Assay Intercepts, May to July, 2018 Reverse Circulation Drill Program .....	155
Table 11.1	Standard Reference Material Samples used During the Drilling Programs .....	169
Table 11.2	ALS Method Code and Description for Alio Sample Preparation.....	175
Table 11.3	ALS Method Code and Description for Alio Sample Preparation.....	175
Table 11.4	Summary of the Au-AA23 and Au-AA24 Fire Assay Fusion, AAS Finish Assay Details .....	176
Table 11.5	Summary of the ALS Ag-GRA21, Ag-GRA22, Au-GRA21 and Au GRA22 Precious Metals Gravimetric Analysis Methods .....	176
Table 11.6	Comparison of the Original Assays with the ALS-Chemex Check Assays, 2010 to 2011 Drilling Program.....	177
Table 11.7	Summary of Inspectorate Assaying versus the Standard Reference Material .....	179
Table 11.8	San Francisco Gold Project, Summary of Blank Assay Data for the 2010 to 2011 Drill Program .....	179
Table 11.9	Summary of Results for the Duplicate Samples, July, 2010 to June, 2011 Drill Program .....	180
Table 11.10	Comparison of the Original Assays with the ALS-Chemex, Inspectorate and SGS Check Assays, 2011 to 2013 Drill Program.....	181
Table 11.11	Summary of SRMs Used to Check Inspectorate, ALS and Skyline Assaying.....	182
Table 11.12	San Francisco Gold Project, Summary of Blank Assay Data for the 2011 to 2013 Drill Program .....	183
Table 11.13	Summary of Results for the Duplicate Samples, July, 2011 to June, 2013 Drill Program .....	184
Table 11.14	Summary and Graph Showing the Gold Variation in the Five Pairs of Samples Rejects vs Field Duplicates .....	186
Table 11.15	Summary of Standard Material Reference Samples Used at Check Inspectorate and ALS Minerals .....	188
Table 11.16	Summary of the Analysis Information for Standard Reference Sample OXC-145.....	198
Table 11.17	Summary of the Analysis Information for Standard Reference Sample OXD-144.....	198

	<b>Page</b>
Table 11.18	Summary of the Analysis Information for Standard Reference Sample OXG-124.....199
Table 13.1	Summary of Column Leach Test Results, Crush Size P <sub>80</sub> 9.5 mm, 127 Days Leach Time .....210
Table 13.2	Summary of Column Leach Test Results, Crush Size P <sub>80</sub> 6.3 mm, 127 Days Leach Time .....210
Table 13.3	Summary of the 2015 Internal Metallurgical Testwork.....211
Table 13.4	Summary of the 2017 Internal Metallurgical Testwork.....212
Table 14.1	Mineral Resource Estimate for the San Francisco and La Chicharra Deposits as of August 8, 2020 .....217
Table 14.2	Applied Grade Capping on 3 m Composites for the San Francisco Resource Model .....220
Table 14.3	Applied Grade Capping on 3 m Composites for the San Francisco Resource Model (by Resource Area).....220
Table 14.4	3-D Block Model Limits and Dimensions .....221
Table 14.5	Rock Domain Code and Specific Gravity.....222
Table 14.6	Applied Search Parameters for Ordinary Kriging Grade Interpolation for the San Francisco Pit.....223
Table 14.7	Applied Search Parameters for Ordinary Kriging Grade Interpolation for the La Chicharra Pit.....223
Table 14.8	Pit Optimization Parameters for the August 8, 2020 Resource Estimate for the San Francisco and La Chicharra deposits.....227
Table 14.9	Underground Parameters for the August 8, 2020 Resource Estimate for the San Francisco UG Lenses.....228
Table 15.1	Mineral Reserves within the San Francisco and La Chicharra Pit Design (August 8, 2020) after Mining Recovery and Dilution .....231
Table 16.1	San Francisco Project, Annual Production from January, 2019 to the End of July, 2020* (by Quarter) .....233
Table 16.2	San Francisco Project, Annual Ore Stockpiled and Processed from January, 2019 to the End of July, 2020* (by Quarter).....233
Table 16.3	Contractor’s Mining Equipment List when the Open Pits were in Operation to the End of 2018.....255
Table 16.4	2020 Underground Mining Schedule .....257
Table 16.5	Combined San Francisco and La Chicharra Pits and Underground LOM Production Schedule .....259
Table 17.1	Summary of the Leach Pad Phases Based Upon the Permits Acquired for the San Francisco Mine .....262

Table 17.2	Manpower at the San Francisco Mine Process Plant and Associated Facilities .....	267
Table 17.3	San Francisco Process Reagents (Consumables) Usage Rates and Costs.....	267
Table 17.4	Annual Gold Production .....	268
Table 18.1	Total Manpower for the San Francisco Mine .....	270
Table 18.2	Summary of the Installed Transformer Capacity .....	273
Table 19.1	Average Annual High and Low London PM Fix for Gold and Silver from 2000 to March 20, 2020 .....	275
Table 19.2	Contract Mining Rates .....	276
Table 21.1	Capital Cost Summary .....	283
Table 21.2	Summary of Life-of-Mine Operating Costs .....	283
Table 22.1	Life-of-Mine Cash Flow Summary .....	289
Table 22.2	Base Case Life-of-Mine Annual Cash Flow .....	290
Table 22.3	Sensitivity of NPV <sub>5</sub> to Gold Price.....	292
Table 25.1	Summary of Life-of-Mine Operating Costs .....	298
Table 25.2	Base Case Life-of-Mine Annual Cash Flow .....	299
Table 26.1	Estimated Budget for the 2020-2021 Infill and Exploration Drilling Programs at the San Francisco Project.....	301
Table 26.2	Estimated Budget for the 2020 Exploration Program at the Vetatierra Project .....	302
Table 26.3	Estimated Budget for the 2020 Exploration Program at the La Pima Project .....	303
Table 26.4	Total Estimated Exploration Expenditures for Magna’s Three Focus Areas on the San Francisco Property .....	303

**List of Figures**

Figure 1.1	Mining Production Schedule.....	16
Figure 1.2	LOM Grade Profile .....	17
Figure 1.3	La Chicharra and San Francisco Heap Leach Profiles.....	17
Figure 1.4	Life-of-Mine Cash Flows.....	18
Figure 1.5	Sensitivity of NPV <sub>5</sub> to Capital, Operating Costs and Gold Price .....	20
Figure 4.1	San Francisco Project Location Map .....	29
Figure 4.2	San Francisco Property (Concessions) Map .....	32
Figure 4.3	San Francisco Project Regional Mineral Concessions Map .....	35
Figure 5.1	San Francisco Mine as Viewed from Highway 15 Driving South from Santa Ana.....	40
Figure 5.2	View of a Water Well Located on the San Francisco Project.....	41
Figure 5.3	View of the Sonora Desert Surrounding the Property .....	42
Figure 6.1	Location of One of the Rotary Drill Sites Located to Southeast of the Main Pit.....	44
Figure 6.2	View of the San Francisco Gold Mine with Estación Llano in the Background.....	44
Figure 6.3	Extraction of Gravel from the Original Leach Pads for Construction Use .....	46
Figure 7.1	Geology of the San Francisco Property .....	56
Figure 7.2	San Francisco and La Chicharra Minesite Geology Map .....	57
Figure 7.3	La Chicharra Pit Looking Southeast showing the Lineament.....	60
Figure 9.1	Map indicating the El Durazno Geology, and Some Grab and Trench Sampling Locations .....	71
Figure 9.2	Geology and Sampling Locations at the Vetatierra Project.....	73
Figure 9.3	Geological Map of the La Pima Project Showing the Locations of the Exploration Targets.....	75
Figure 9.4	Geological Map of the La Pima Mine Exploration Target and the Location of the Longitudinal Section .....	76
Figure 9.5	Longitudinal Section Across the La Pima Mine Exploration Target Showing the Artisanal Workings in the Mineralized Zone .....	77
Figure 9.6	Drill Program Map Based on the Down-Dip Projection of the Mineralization at USD 1,350/ oz Au for the San Francisco and La Chicharra Pits.....	77

Figure 9.7	3D Projection of the High-Grade Veins Identified along the South Wall of the SF Pit.....	79
Figure 9.8	2014 Drill Holes in Relation to the Geology at the Vetatierra Project .....	81
Figure 9.9	2020 Drill Program Location Map on the Vetatierra Project.....	82
Figure 10.1	RC Drilling in the San Francisco Pit in July, 2011 .....	86
Figure 10.2	Diamond Drill Rig Set-Up on a Drill Hole Southeast of the San Francisco Pit.....	87
Figure 10.3	Location Marker for Drill Hole TF-1522.....	88
Figure 10.4	Cross- Section 580W on the San Francisco Pit.....	92
Figure 10.5	Cross-Section 800W on the San Francisco Pit.....	93
Figure 10.6	July, 2010 to June, 2011 Drill Hole Location Map Around the San Francisco and La Chicharra Pits, including Condemnation Drilling .....	94
Figure 10.7	July, 2011 to June, 2013 Drill Hole Location Map on the San Francisco Pit.....	95
Figure 10.8	Cross-Section 220W on the San Francisco Pit.....	96
Figure 10.9	Cross-Section 480W on the San Francisco Pit.....	98
Figure 10.10	Location Drill Map in the La Chicharra Area.....	99
Figure 10.11	Section 2540W in the La Chicharra Pit.....	100
Figure 10.12	Section 2780W on the La Chicharra Pit.....	101
Figure 10.13	Plan View of the Various 2014 In-fill Drilling Programs within the San Francisco Pit.....	103
Figure 10.14	Location Plan of the 2014 Condemnation Drilling Program .....	104
Figure 10.15	Plan View of the November, 2014 Core Drilling Program on the South Wall of the San Francisco Pit .....	114
Figure 10.16	Plan View of the RAB Drilling along Section Lines 3500W, 4100W and 4700W .....	119
Figure 10.17	Plan View of the RAB, RC and Core Drilling Conducted in the 1B Area.....	127
Figure 10.18	Plan View of Geology and the 2014 RC and Core Drilling at the Vetatierra Project .....	133
Figure 10.19	Location of the July, 2016 to March, 2017 In-Fill Drilling Program in the Area of the San Francisco Pit.....	140
Figure 10.20	Location of the July, 2016 to March, 2017 In-Fill Drilling Program in the Area of the La Chicharra Pit .....	141

Figure 10.21	RC Drill Program at the San Francisco Pit as of December, 2017, East-Southeast View .....	153
Figure 10.22	Plan View of the 2018 Drilling Program at the San Francisco Project.....	154
Figure 11.1	Specimen Trays for Drill Hole TF-1566.....	162
Figure 11.2	Reverse Circulation Sample Collection .....	164
Figure 11.3	Fragment of Basalt used for Blank Sample.....	168
Figure 11.4	Blank Sample Bag ready to be Inserted into the Sample Sequence.....	168
Figure 11.5	Oven for Drying Samples in the Preparation Facilities .....	172
Figure 11.6	Combo Boyd/RSD Boyd Crusher with Single Split .....	172
Figure 11.7	Drill Hole VT14-005 Showing a Location with Visible Gold in the Core.....	185
Figure 11.8	Summary and Graph Showing the Assays Results for the Five Samples .....	185
Figure 11.9	Summary and Graph Showing the Gold Variation in the Samples Screen Metallics vs Fire Assays .....	187
Figure 11.10	Precision Plot – Gold in Reference Standard CDN-GS-2M for the San Francisco Pit In-Fill Drilling.....	188
Figure 11.11	Precision Plot – Gold in Reference Standard OXH-97 for the San Francisco Pit In-Fill Drilling.....	189
Figure 11.12	Precision Plot – Gold in Reference Standard CDN-GS-P7H for the San Francisco Pit In-Fill Drilling.....	189
Figure 11.13	Precision Plot – Gold in Reference Standard OXC-109 for the San Francisco Pit In-Fill Drilling.....	190
Figure 11.14	Precision Plot – Gold in Reference Standard OXE-101 for the San Francisco Pit In-Fill Drilling.....	190
Figure 11.15	Precision Plot – Gold in Reference Standard OXF-105 for the San Francisco Pit In-Fill Drilling.....	191
Figure 11.16	Precision Plot – Gold in Reference Standard OXJ-95 for the San Francisco Pit In-Fill Drilling.....	191
Figure 11.17	Precision Plot – Gold in Reference Standard OXC-109 for the N and NW La Chicharra Drilling .....	192
Figure 11.18	Precision Plot – Gold in Reference Standard CDN-GS-7PH for the N and NW La Chicharra Drilling .....	192
Figure 11.19	Results for the Duplicate Samples Plotted as a Relative Error Diagram for the San Francisco Pit, August, 2016 to March, 2017 Drill Program.....	193



Figure 11.20	Results for the Duplicate Samples Plotted as a Relative Error Diagram for the North and Northwest La Chicharra Pits, August, 2016 to March, 2017 Drill Program.....	194
Figure 11.21	Plot of Blank Assay Data from the Bureau Veritas Laboratory for the 2016 to 2017 Drill Program at San Francisco Pit .....	195
Figure 11.22	Plot of Blank Assay Data from the ALS Minerals Laboratory for the 2016 to 2017 Drill Program at San Francisco Pit .....	195
Figure 11.23	Plot of Blank Assay Data from the Bureau Veritas Laboratory for the 2016 to 2017 Drill Program at N & NW Chicharra Pit .....	196
Figure 11.24	Plot of Blank Assay Data from the ALS Minerals Laboratory for the 2016 to 2017 Drill Program at N & NW Chicharra Pit .....	196
Figure 11.25	Plot for the Analysis Information for Standard Reference Sample OXC-145.....	198
Figure 11.26	Plot for the Analysis Information for Standard Reference Sample OXD-144.....	199
Figure 11.27	Plot for the Analysis Information for Standard Reference Sample OXG-124.....	200
Figure 11.28	Plot of the Duplicate Sample Analysis for the 2018 Drilling Program.....	201
Figure 12.1	View of the San Francisco Pit Looking East .....	205
Figure 12.2	View of the La Chicharra Pit Looking West-Northwest .....	205
Figure 12.3	View Looking Southeast Towards the San Francisco Pit.....	206
Figure 12.4	View Looking Southwest Towards the La Chicharra Waste Pile and Pit in the Distance .....	206
Figure 12.5	View of ADR Plant 2 .....	207
Figure 12.6	Partial View of the Crushing Facility.....	207
Figure 13.1	Historical Cumulative Plant Gold Recoveries .....	213
Figure 14.1	Plan View of the Drill Hole Collars at the San Francisco Mine .....	219
Figure 14.2	3-D Profile of the Topography and the Drill Holes at the San Francisco and La Chicharra Pits .....	220
Figure 14.3	3-D View of the Topography and Interpreted Mineralized Constraints at the San Francisco and La Chicharra Deposits .....	221
Figure 16.1	Pit Wall Angle Measurements: San Francisco Pit .....	234
Figure 16.2	Pit Wall Angle Measurements: La Chicharra Pit.....	235
Figure 16.3	Piezometer (PFP-01A) Installed to Monitor Water Flow Surrounding the Pit .....	236

	<b>Page</b>
Figure 16.4	Plan View of the La Chicharra and San Francisco Pits: End of Year 2020.....238
Figure 16.5	Plan View of the La Chicharra and San Francisco Pits: End of Year 2021.....239
Figure 16.6	Plan View of the La Chicharra and San Francisco Pits: End of Year 2022.....240
Figure 16.7	Plan View of the La Chicharra* and San Francisco Pits: End of Year 2023.....241
Figure 16.8	Plan View of the La Chicharra* and San Francisco Pits: End of Year 2024.....242
Figure 16.9	Plan View of the La Chicharra* and San Francisco Pits: End of Year 2025.....243
Figure 16.10	Plan View of the La Chicharra* and San Francisco Pits: End of Year 2026.....244
Figure 16.11	Plan View of the La Chicharra* and San Francisco Pits: End of Year 2027.....245
Figure 16.12	Plan View of the La Chicharra* and San Francisco Pits: End of Year 2028.....246
Figure 16.13	Final Design for the San Francisco Pit (2028).....247
Figure 16.14	Final design for the La Chicharra Pit (2023) .....248
Figure 16.15	Plan View of the Current San Francisco Pit Showing the Location of the Longitudinal and Cross-Sections Demonstrating the Growth of the Pit Since 2009 with the Projected Growth to 2028.....249
Figure 16.16	Longitudinal Section (3357580 North) Demonstrating the Growth of the San Francisco Pit Since 2009 with the Projected Growth to 2028 .....250
Figure 16.17	Cross-Section (488700 East) Demonstrating the Growth of the San Francisco Pit Since 2009 with the Projected Growth to 2028 .....251
Figure 16.18	Plan View of the Current La Chicharra Pit Showing the Location of the Longitudinal and Cross-Sections Demonstrating the Growth of the Pit Since 2009 with the Projected Growth to 2023.....252
Figure 16.19	Longitudinal Section (3,357,950 North) Demonstrating the Growth of the La Chicharra Pit Since 2009 with the Projected Growth to 2023.....253
Figure 16.20	Cross-Section (488,700 East) Demonstrating the Growth of the La Chicharra Pit Since 2009 with the Projected Growth to 2023 .....254
Figure 16.21	Relationship between the San Francisco and La Chicharra Pits, Leach Pads, Waste Piles and Other Infrastructure 2017-Present .....256
Figure 16.22	Plan View of the Underground Development Workings with Timing .....257

Figure 16.23	Section View of the Underground Development Workings and Stopes with Timing.....	258
Figure 17.1	Crushing Circuit 1 Flowsheet (100% passing 9.5 mm) .....	261
Figure 17.2	Crushing Circuit 2 Flowsheet (100% passing 9.5 mm) .....	261
Figure 17.3	Heap Leach Circuit Showing the Solution Balance .....	263
Figure 17.4	Overall Gold Recovery Circuit (ADR) Flowsheet.....	264
Figure 17.5	View of the Second ADR Plant .....	264
Figure 17.6	Plan View of the Current Crushing Facilities <sup>1</sup> .....	265
Figure 17.7	View of the Crushing Facilities and Heap Leach Pads as Seen from the Lookout at the San Francisco Pit (Zoom Lens) .....	266
Figure 17.8	Heap Leach Pads as Viewed from the Road to the La Chicharra Pit with Phase 6 Under Construction in the Foreground (May, 2017).....	266
Figure 18.1	2016 General Site Layout .....	269
Figure 18.2	Exploration Sample Storage and Preparation Facility .....	271
Figure 18.3	Core Stored in the Exploration Sample Storage and Preparation Facility .....	272
Figure 18.4	Pulp Samples Stored in the Exploration Sample Storage and Preparation Facility.....	272
Figure 18.5	Fresh Water Distribution Network at the San Francisco Mine.....	274
Figure 22.1	Ten Year Price History .....	287
Figure 22.2	Mining Production Schedule.....	288
Figure 22.3	LOM Grade Profile .....	288
Figure 22.4	La Chicharra and San Francisco Heap Leach Profiles.....	289
Figure 22.5	Life-of-Mine Cash Flows.....	291
Figure 22.6	Sensitivity to Capital, Operating Costs and Gold Price .....	292

## 1.0 SUMMARY

### 1.1 GENERAL

Magna Gold Corp. (TSXV: MGR, OTCQB: MGLQF) (MGR or Magna) has retained Micon International Limited (Micon) to prepare an independent Technical Report for the San Francisco Gold Project (San Francisco Project or the Project) in the state of Sonora, Mexico. The purpose of this Technical Report is to support disclosure for Magna's Pre-Feasibility Study for the San Francisco Project. The San Francisco Project is owned by Magna's wholly-owned subsidiary Molimentales del Noroeste, S.A. de C.V. (Molimentales) which owns a 100% interest in the Project and the surrounding mineral concessions.

Micon's most recent Technical Report for the Project was entitled "NI 43-101 F1 Technical Report for the San Francisco Gold Project, Sonora, Mexico", dated June 1, 2020. That Technical Report was filed by Magna on the System for Electronic Document Analysis and Retrieval (SEDAR, [www.sedar.com](http://www.sedar.com)). Micon has written 11 prior reports on the San Francisco Project since 2005.

Micon does not have nor has it previously had any material interest in Magna or related entities. The relationship with Magna or related entities is and has been solely a professional association between the client and the independent consultant. This report is prepared in return for fees based upon agreed commercial rates and the payment of these fees is in no way contingent on the results of this report.

This report includes technical information which requires subsequent calculations or estimates to derive sub-totals, totals and weighted averages. Such calculations or estimations inherently involve a degree of rounding and consequently introduce a margin of error. Where these occur, Micon does not consider them to be material.

This report is intended to be used by Magna subject to the terms and conditions of its agreement with Micon. That agreement permits Magna to file this report as a Technical Report with the Canadian Securities Administrators pursuant to provincial securities legislation or with the SEC in the United States. Except for the purposes legislated under provincial securities laws, any other use of this report, by any third party, is at that party's sole risk.

The conclusions and recommendations in this report reflect the authors' best independent judgment in light of the information available to them at the time of writing. The authors and Micon reserve the right, but will not be obliged, to revise this report and conclusions if additional information becomes known to them subsequent to the date of this report. Use of this report acknowledges acceptance of the foregoing conditions.

### 1.2 PROPERTY DESCRIPTION AND LOCATION

The San Francisco property is situated in the north central portion of the state of Sonora, Mexico, approximately 150 kilometres (km) north of the state capital, Hermosillo. In this

report, the term San Francisco Project refers to the area within the exploitation or mining concessions controlled by Magna, while the term San Francisco property (the property) refers to the entire land package (mineral exploitation and exploration concessions) under Magna's control.

The San Francisco Project is comprised of two previously mined open pits (San Francisco and La Chicharra), together with heap leach processing facilities and associated infrastructure located close to the San Francisco pit. At the time Magna acquired the San Francisco Project, the leach pads were on a residual leach cycle with no mining being conducted. However, Magna has begun to process material from the low-grade stockpile, as well as having restarted mining at the La Chicharra pit.

### **1.2.1 Magna Acquisition and Ownership of the San Francisco Project**

On March 6, 2020, Magna announced that it has entered into a definitive purchase agreement with Timmins GoldCorp Mexico S.A. de C.V. (Timmins), a wholly-owned subsidiary of Alio Gold Inc. (Alio), to acquire the San Francisco mine.

On May 6, 2020, Magna announced that it had closed the acquisition of the San Francisco mine pursuant to a definitive share purchase agreement dated March 5, 2020, as amended April 24, 2020, between Timmins, a wholly-owned subsidiary of Alio, and itself.

Magna advises that it holds the San Francisco Project, which consists of 13 mining concessions, through its indirect wholly-owned subsidiary Molimentales. All concessions are contiguous and each varies in size for a total property area of 33,667.72 hectares (ha). In late 2005, the original Timmins II concession was subdivided into two concessions (Timmins II Fraccion Sur and Pima), as part of separate exploration strategies for the original Timmins II concession. All concessions are subject to a bi-annual fee and the filing of reports in May of each year covering the work accomplished on the property between January and December of the preceding year. The fee rates are estimated in US dollars based on the rates published in the "Diario Oficial de la Federacion (DOF)" as of February 28, 2020.

On February 23, 2011, Molimentales staked an additional 95,000 hectare (ha) of claims along the highly prospective Sonora-Mojave Megashear structural province in northern Sonora. In 2015 and 2016, the regional concessions were reduced with Molimentales only keeping the ground that it deemed significant to future exploration. A total of 13,284.19 ha was retained in the regional package of mineral concessions.

### **1.2.2 Mexican Mining Laws**

The Mexican mining laws were changed in 2005 and, as a result, all mineral concessions granted by the Dirección General de Minas (DGM) became mining concessions. There are no longer separate specifications for a mineral exploration or exploitation concession. A second change to the mining laws was that all mining concessions are granted for 50 years, provided

that the concessions remain in good standing. As part of this change, all former exploration concessions which were previously granted for 6 years became eligible for the 50-year term.

Concessions are extendable, provided that the application is made within the five-year period prior to the expiry of the concession and the bi-annual fee and work requirements are in good standing. The bi-annual fee, payable to the Mexican government to hold the group of contiguous mining concessions for the San Francisco operations is USD 604,710. The bi-annual fee to hold the group of contiguous mining concessions which comprise the regional mineral property is USD 205,327.

### **1.3 ACCESSIBILITY, CLIMATE, PHYSIOGRAPHY, LOCAL RESOURCES AND INFRASTRUCTURE**

The Project is located in the Arizona-Sonora desert in the northern portion of the Mexican state of Sonora, 2 km west of the town of Estación Llano (Estación), approximately 150 km north of Hermosillo and 120 km south of the United States/Mexico border city of Nogales along Highway 15 (Pan American highway). The closest accommodations are in Santa Ana, a small city located 21 km to the north on Highway 15.

The climate at the Project site ranges from semi-arid to arid. The average ambient temperature is 21°C, with minimum and maximum temperatures of -5°C and 50°C, respectively. The average annual rainfall for the area is 330 mm with an upper extreme of 880 mm. The desert vegetation surrounding the San Francisco mine is composed of low lying scrub, thickets and various types of cacti, with the vegetation type classified as Sarcocaulus Thicket.

Physiographically, the San Francisco property is situated within the southern Basin and Range Province, characterized by elongate, northwest-trending ranges separated by wide alluvial valleys. The San Francisco mine is located in a relatively flat area of the desert with the topography ranging between 700 and 750 m above sea level.

### **1.4 HISTORY**

After conducting exploration on the Project between 1983 and 1992, Compañía Fresnillo S.A. de C.V. (Fresnillo) sold the property in 1992 to Geomaque Explorations Ltd. (Geomaque). After conducting further exploration, Geomaque decided to bring the Project into production in 1995. Due to economic conditions, mining ceased and the operation entered into the leach-only mode in November, 2000. In May, 2002, the last gold pour was conducted; the plant was mothballed, and clean-up activities at the mine site began.

In 2003, Geomaque sought and received shareholder approval to amalgamate the corporation under a new Canadian company, Defiance Mining Corporation (Defiance). On November 24, 2003, Defiance sold its Mexican subsidiaries (Geomaque de Mexico and Mina San Francisco), which held the San Francisco gold mine, to the Astiazaran family of Sonora and their private company.

Since June, 2006, the Astiazaran family and their company Desarrollos Prodesa S.A. de C.V. have been extracting sand and gravel intermittently from both the waste dumps and the leach pads for use in highway construction and other construction projects.

Alio acquired an option to earn an interest in the property in early 2005, whereupon it conducted a review of the available data and started a reverse circulation drilling program in August and September, 2005. This was followed by a second drilling program comprised of both reverse circulation and diamond drilling in 2006, based on the results of the 2005 drilling program.

In April, 2010, Alio announced that the San Francisco mine had entered back into production.

As noted above, Magna completed its acquisition of the San Francisco Project on May 6, 2020.

## **1.5 GEOLOGICAL SETTING AND MINERALIZATION**

The San Francisco Project is a gold occurrence with trace to small amounts of other metallic minerals. The gold occurs in granitic gneiss and the deposit contains principally free gold and occasionally electrum. The mineralogy, the possibility of associated tourmaline, the style of mineralization and fluid inclusion studies suggest that the San Francisco deposits may be of mesothermal origin.

The San Francisco deposits are roughly tabular with multiple phases of gold mineralization. The deposits strike 60° to 65° west, dip to the northeast, range in thickness from 4 to 50 metres (m), extend over 1,500 m along strike and are open ended. Another deposit, the La Chicharra zone, was mined by Geomaque, as a separate pit.

## **1.6 EXPLORATION PROGRAMS**

### **1.6.1 Historical Alio Exploration Programs**

From 2007 to 2009, concurrent with the feasibility study which focused on re-starting the mining operations, Alio conducted exploration comprised mainly of in-fill and confirmation drilling in and around of the San Francisco and La Chicharra pits. The drilling results as of the end of 2009 indicated that the mineralization extended both along strike and down dip of the known deposit, a situation which led to the decision to accelerate the drilling in the first 6 months of 2010. The results from the 2010 drilling, when combined with the previous results, led to Alio updating the resource and reserve estimations, as well as its mine plan.

Between July, 2010 and June, 2011, Alio conducted an intensive exploration drilling program which included deeper drilling to explore the mineralization at depth, both in and around the La Chicharra and San Francisco pits. The results of this drilling indicated that the mineralization is located in parallel mineralized bodies both along strike and at depth.

From July, 2011 to June, 2013, 1,464 reverse circulation (RC) and core holes were drilled for a total of 327,853 m. Most of the drilling was undertaken in and around the San Francisco pit and the La Chicharra pit. The RC drilling included 13,219 m in 62 holes of condemnation drilling and 3,842 m in 20 holes for water monitoring. A further 8 RC holes totalling 107 m were drilled on the low-grade stockpile for grade control.

In the period between 2013 and 2017, Alio conducted a small number of exploration drilling programs comprised of in-fill drilling in the San Francisco pit to cover gaps in drilling on the lower benches, exploration drilling to outline preliminary underground resources beneath the south wall of the pit and exploration drilling to the north of the San Francisco pit to potentially identify a secondary deposit which would supply feed to the heap leach pad and processing facilities at the San Francisco mine.

Alio's in-fill drilling programs led to 2 small satellite pits to the north and northeast being identified around the La Chicharra deposit and a small pit to the southeast of the San Francisco deposit. These small pits are only a few benches deep.

In 2017 and 2018 Alio conducted in-fill drilling programs at the San Francisco pit to further define and upgrade the classification of mineralized material within the various mining phases of the pit. Alio also conducted exploration drilling to further identify the extent and grade of the mineralization at depth within the pit.

### **1.6.2 Magna Exploration Programs**

In addition to bringing the mining operations back into production, Magna is also in the process of outlining and budgeting exploration activities in three areas of the San Francisco property as follows:

1. San Francisco mine (San Francisco and La Chicharra Pits).
2. Vetatierra Project.
3. La Pima Project.

In order to ensure the continuity of the operations within the San Francisco and La Chicharra pits, Magna has designed a reverse circulation drill program comprised of both infill and exploration holes at specific sites in and around both pits. The program is based on the down dip projections of the mineralized zones, using the accumulated data gathered from the years of exploration and operational drilling and mining of the San Francisco mine and a gold price of USD 1,350/oz of gold. Based on this interpretation, a drill program was designed to test the extension of the mineralization and/or the connection between different mineralized intercepts within the perimeters of the down dip interpretation, as well as focusing on connecting smaller neighbouring mineralized areas. A program of infill drilling has also been outlined in and around the crushing circuit, seeking the feasibility of relocating the circuit and thereby potentially allowing the mining of the mineral resources currently located under it.



In addition to the program outlined above, Magna is scheduled to conduct a core drill program on the south wall of the San Francisco pit, specifically on the Phase 7A segment of the mine plan. The drill program is targeted to further outline the repetitive high gold grade drill intercepts encountered in past drilling campaigns which appear to be related to the vein system located at the San Francisco and El Carmen areas of the project.

Magna has also outlined an exploration program at the Vetatierra Project to follow up on Alio's previous 2014 exploration program which suggested that the majority of the mineralization is hosted in a diorite stock which is very poorly exposed. Magna will conduct an initial drilling program to define the continuity of the mineral intercepts from the previous campaign, to explore the potential lateral extension of the gold mineralization detected during the previous drilling program and to gain a better understanding of the diorite geometry at depth.

The third exploration program which Magna will undertake is at the La Pima Project. At this project Magna has proposed conducting additional exploration that includes a geophysical survey using either IP-R or CSAMT and a core drilling program. The geophysical survey will initially consist of two lines to try to obtain response features of the host rock at depth and the continuity of the main structures. Depending on the initial results, additional lines could be required to assist with designing the drill plan.

## **1.7 MINERAL RESOURCE AND RESERVE ESTIMATES**

### **1.7.1 Mineral Resource Estimate**

The database of the San Francisco and La Chicharra deposits consists of 4,570 drill holes with 434,708 sample intervals, mostly 1.5 m in length, for a total of 640,782 m of drilling for all the property, including exploration drilling outside of the San Francisco and La Chicharra pits. The current database includes 245 new holes drilled in 2017 and 2018, for 35,570 m of drilling.

Approximately 13% of the sampling intervals are greater than or equal to 2 m length, about 84% of the intervals are between 1.5 and 2.0 m in length, and about 3% are less than 1.5 m in length. In the case of duplicate samples, the original sample was used in the database.

High-grade outlier assays were capped on 3 m composites at different gold grades, according to the geological domains.

A total of 68 specific gravity determinations were made, covering all rock domains. Results range from a high of 2.84 to a low of 2.61, with an arithmetic mean of 2.76. The specific gravity for each rock type is used in the resource estimate

All blocks in the model were interpolated using the Ordinary Kriging method. The parameters were derived from the variographic analysis and applied to the different domains and zones accordingly. However, for the current resource update in San Francisco deposit, the interpolation process was relaxed to allow multiple domains to inform blocks on each interpolation run, because the remaining resources are predominantly gabbro (Rock Code 11).

Once Micon had audited and accepted the Magna block models, Magna proceeded to run a pit optimization program in order to estimate the resources. The gold price used for estimating resources was USD 1,500 per ounce.

The parameters used in the pit optimization for the estimation of the resources are summarized in Table 1.1. They are the parameters determined by Micon and Magna, taking into account the actual historical operating costs.

**Table 1.1**  
**Pit Optimization Parameters for the August 8, 2020 Resource Estimate for the San Francisco and La Chicharra Dposits**

Area	Costs			
	Description	Units	Amount	
San Francisco Model	Waste mining cost OP	USD/t	2.20	
	Ore mining cost OP	USD/t	2.20	
	Process cost	USD/t	4.15	
	G & A cost	USD/t	0.41	
	Gold price	USD/oz	1,500	
	<b>Rock Densities and Recoveries</b>			
		<b>Name/code</b>	<b>Density</b>	<b>Recovery %</b>
		Diorite (2)	2.72	54.50
		Gneiss (4)	2.75	71.10
		Granite (5)	2.76	76.00
		Schist (6)	2.75	74.40
		Lamprophite Dike (8)	2.76	54.50
		Pegmatite (10)	2.85	74.40
		Gabbro (11)	2.81	63.80
		Conglomerate (12)	2.00	64.50
	General Recovery		64.00	
La Chicharra Model	<b>Costs</b>			
	<b>Description</b>	<b>Units</b>	<b>Amount</b>	
	Waste mining cost	USD/t	1.79	
	Ore mining cost	USD/t	1.79	
	Process cost	USD/t	4.15	
	G & A cost	USD/t	0.41	
	Gold price	USD/oz	1,500	
	<b>Rock Densities and Recoveries</b>			
		<b>Name/code</b>	<b>Density</b>	<b>Recovery %</b>
		All Rock (100-500)	2.9	78.00
	General Recovery		78.00	

Table provided by Magna.

As shown in Table 1.1, not only do the various rock codes have a different density, the metallurgical recovery varies with the rock code as well. Currently the San Francisco mine

plan will be predominantly processing the gabbro (11) and gneiss (4) rock types.

Previous drilling programs have outlined a number of lenses of higher-grade mineralization beneath the southwall of the San Francisco pit. Alio investigated these lenses and developed a drift on one of them in 2015-2016, with the objective of mining this material using underground cut and fill methods. Alio later shelved the idea of conducting underground mining in favour of just conducting a pushback in this area. Magna has revived the underground scenario for mining the higher grade lenses. The parameters used for estimating the underground resources in the southern wall of the San Francisco pit are summarized in Table 1.2.

**Table 1.2**  
**Underground Parameters for the August 8, 2020 Resource Estimate for the San Francisco Project**

Area	Costs		
	Description	Units	Amount
San Francisco Underground Model	Waste mining cost UG	USD/t	36.50
	Ore mining cost UG	USD/t	36.50
	Process cost (crushing and leach)	USD/t	4.00
	G & A cost	USD/t	0.50
	Contingency	USD/t	2.00
	Gold price	USD/oz	1,500
	<b>Rock Densities and Recoveries</b>		
	<b>Name/code</b>	<b>Density</b>	<b>Recovery %</b>
	All Rock	2.90	64.00
	General Recovery		64.00

Table provided by Magna.

The mineral resources, as estimated by Magna, are presented in Table 1.3. This resource estimate includes the mineral reserves.

Micon is not aware of any environmental, permitting, legal, title, taxation, socio-economic, marketing or political issues which would adversely affect the mineral resources estimated above. However, mineral resources that are not mineral reserves do not have demonstrated economic viability. The mineral resource figures in Table 1.3 have been rounded to reflect that they are estimates and therefore the addition may not sum in the table.

Both the CIM and the Australasian Joint Ore Reserves Committee (JORC) codes state that mineral resources must meet the condition of “a reasonable prospect for eventual economic extraction.” Magna developed a Lerchs Grossman pit shell geometry at reasonable gold prices, costs and recovery assumptions, in order to satisfy this condition. The resource estimate presented in Table 1.3 is based on a pit shell designed at a gold price of USD 1,500 per ounce and additional cost and recovery parameters developed by Magna.

**Table 1.3**  
**Mineral Resource Estimate for the San Francisco and La Chicharra Deposits as of August 8, 2020**  
**(Inclusive of Mineral Reserves) (Gold Price of USD 1,500/Oz)**

Area	Cut-off (Au g/t)	Category	Tonnes	Au (g/t)	Gold (Oz)
San Francisco Mine OP	0.14	Measured	22,975,000	0.424	313,000
		Indicated	49,500,000	0.426	678,000
		<b>Measured &amp; Indicated</b>	<b>72,475,000</b>	<b>0.426</b>	<b>992,000</b>
		Inferred*	10,385,000	0.465	155,000
San Francisco UG	1.40	Measured	111,000	4.160	15,000
		Indicated	236,000	3.907	30,000
		<b>Measured &amp; Indicated</b>	<b>347,000</b>	<b>3.988</b>	<b>44,000</b>
La Chicharra Mine OP	0.12	Measured	11,589,000	0.502	187,000
		Indicated	15,289,000	0.42	206,000
		<b>Measured &amp; Indicated</b>	<b>26,878,000</b>	<b>0.455</b>	<b>393,000</b>
		Inferred*	989,000	0.488	16,000
Total Resources		Measured	34,675,000	0.462	515,000
		Indicated	65,025,000	0.437	914,000
		<b>Measured &amp; Indicated</b>	<b>99,700,000</b>	<b>0.446</b>	<b>1,430,000</b>
		Inferred*	11,374,000	0.467	171,000

\*Inferred resources in this table only include material within the limits of the USD 1,500/oz Au pit shell and do not include material outside the pit limits.

## 1.7.2 Mineral Reserve Estimate

The reserve estimate completed by Magna as of August 8, 2020 and audited by Micon, is compliant with the current CIM standards and definitions specified by NI 43-101, and supersedes all previous reserve estimates for the San Francisco mine. In addition, Magna has carried out a reserve estimate for the La Chicharra deposit. That estimate has also been audited by Micon.

The gold price used for estimating the reserves at the San Francisco mine was USD 1,350 per ounce.

The parameters used in the pit optimization for the estimation of reserves are the same as those described previously in connection with the estimation of resources.

Mining recovery has been estimated at 98% for both the San Francisco and La Chicharra deposits. Micon agrees with this estimate, as it is based on actual experience at the mine.

The average dilution for the San Francisco pit is estimated at 6.3%. The La Chicharra deposit uses a dilution factor that varies between 4.0% and 6.0 %.

Table 1.4 presents the reserves estimated within the pit design outline, including mine recovery and dilution factors.

**Table 1.4**  
**Mineral Reserves within the San Francisco and La Chicharra Pit Design (August 8, 2020) after Mining Recovery and Dilution**

<b>Mining Method</b>	<b>Area</b>	<b>Classification</b>	<b>K tonnes</b>	<b>Gold (g/t)</b>	<b>Contained Gold K Ounces</b>
<b>Surface</b>	<b>San Francisco</b>	Proven	15,063	0.492	238
		Probable	22,783	0.496	364
		<b>Total</b>	<b>37,846</b>	<b>0.494</b>	<b>602</b>
<b>Underground</b>		Proven	91	4.186	12
		Probable	20	3.657	2
		<b>Total</b>	<b>111</b>	<b>4.089</b>	<b>15</b>
<b>Surface</b>	<b>La Chicharra</b>	Proven	5,904	0.503	96
		Probable	2,986	0.419	40
		<b>Total</b>	<b>8,890</b>	<b>0.475</b>	<b>136</b>
<b>All</b>	<b>Total Mining</b>	Proven	21,058	0.511	346
		Probable	25,789	0.490	406
		<b>Total</b>	<b>46,847</b>	<b>0.499</b>	<b>752</b>
	<b>San Francisco Mine</b>	<b>Low-Grade Stockpile</b>	<b>782</b>	<b>0.256</b>	<b>6</b>
<b>Total Surface + Underground + Stockpile</b>			<b>47,629</b>	<b>0.495</b>	<b>758</b>

Table provided by Magna.

The proven and probable reserves in Table 15.1 have been derived from the measured and indicated mineral resources summarized in Table 14.1. The figures in Table 15.1 have been rounded to reflect that they are estimates.

The mineral reserve estimate has been reviewed and audited by Micon. It is Micon's opinion that the August 8, 2020, mineral reserve estimate has been prepared in accordance with the CIM standards and definitions for mineral reserve estimates and that Magna can use this estimate as a basis for further mine planning and operational optimization at the San Francisco Project.

## **1.8 OPERATIONAL DATA FOR THE SAN FRANCISCO PROJECT**

Mining at the San Francisco Project was and is currently conducted by a contractor, using open pit mining methods, with stockpiling the lower grade material for processing once the open pit was and is no longer producing. Although Alio drew material from the stockpiles intermittently from 2014, routine processing of the stockpile material began at the end of 2018 when the production from the open pits ceased and continued through 2019. At the beginning of 2020, operations were solely focused on recovery of the residual inventory ounces.

Magna has now started to process ore from the low-grade stockpiles as well from the La Chicharra pit and plans to initiate underground mining from the higher grade lenses in the southwall of the San Francisco pit, as well as resuming open pit mining in portions of the San Francisco pit.

Magna will also establish its own stockpile for the lower grade material (but above the cut-off grade) being mined. This lower grade material can be processed later in the mine life, used to

top up the crushing capacity from time to time or left to be processed at the end of the mine life.

The original plant equipment and later additions have allowed the crushing circuit to operate at 22,000 tonnes per day (t/d).

### **1.8.1 Mine Plans and Activities**

Production from the La Chicharra deposit recommenced in June, 2020. The San Francisco and La Chicharra pits are planned to be mined at the same time. Magna is also processing the remainder of Alio's low-grade stockpile. The La Chicharra pit is located 1,000 m west of the San Francisco pit.

All mining activities are being conducted by the contractor, Peal Mexico, S.A. de C.V. (Peal Mexico), of Navojoa, Mexico. The contractor is obliged to supply and maintain the appropriate principal and auxiliary mining equipment and personnel required to produce the tonnage mandated by Magna, in accordance with the mining plan. Peal Mexico was also the contractor for Alio, during its mining phase at the San Francisco Project.

Magna provides contract supervision, geology, engineering and planning and survey services, using its own employees at the mine.

Magna's planned mine production schedule is summarized in Table 1.5. Over an operating life extending to 2028, it is planned to mine approximately 47.6 million tonnes of ore at an average grade of 0.495 grams of gold per tonne, containing approximately 758,000 ounces of gold. Approximately 119 million tonnes of waste will be mined for an average stripping ratio of approximately 2.5 tonnes of waste per tonne of ore.

## **1.9 METALLURGY AND PROCESSING**

The San Francisco property has been in production since 2010 and, to date, there have been no processing factors or deleterious elements identified that have had a material negative effect on economic extraction. Gold is recovered from the mineralization mined from the San Francisco and La Chicharra deposits by using conventional crushing and heap leach technology.

Ore is crushed using two crushing and screen circuits, with a current combined crushing operating rate of 22,000 t/d. The product size from the crusher circuits is 100% passing 9.5 mm.

**Table 1.5  
Combined San Francisco and La Chicharra Pits and Underground LOM Production Schedule**

<b>La Chicharra Pit</b>	<b>Units</b>	<b>2020</b>	<b>2021</b>	<b>2022</b>	<b>2023</b>	<b>2024</b>	<b>2025</b>	<b>2026</b>	<b>2027</b>	<b>2028</b>	<b>Grand Total</b>
Ore	diluted tonnes	616,783	4,613,162	3,189,670	470,356	0	0	0	0	0	8,889,972
Gold grade	diluted g/t	0.283	0.286	0.448	0.426	0	0	0	0	0	0.475
Gold contained	oz	5,618	67,876	54,051	8,215	0	0	0	0	0	135,762
Waste	tonnes	6,435,302	15,661,944	6,043,201	165,641	0	0	0	0	0	28,306,088
Total tonnes	tonnes	7,052,086	20,275,106	9,232,871	635,998	0	0	0	0	0	37,196,060
Strip Ratio	W:O	10.43365	3.39505622	1.89461626	0.35216065	0	0	0	0	0	3.18
<b>San Francisco Pit</b>	<b>Units</b>	<b>2020</b>	<b>2021</b>	<b>2022</b>	<b>2023</b>	<b>2024</b>	<b>2025</b>	<b>2026</b>	<b>2027</b>	<b>2028</b>	<b>Grand Total</b>
Ore	diluted tonnes	271,977	1,334,866	3,003,257	5,490,843	5,625,166	7,004,925	7,038,030	7,043,118	1,034,193	37,846,375
Gold grade	diluted g/t	0.373	0.382	0.428	0.515	0.493	0.493	0.465	0.551	0.593	0.494
Gold contained	oz	3,261	16,415	41,312	90,907	89,145	110,920	105,130	124,865	19,707	601,662
Waste	tonnes	420,822	5,026,670	17,826,781	18,861,024	17,860,091	15,207,777	10,717,742	4,485,598	186,009	90,592,514
Total tonnes	tonnes	692,799	6,361,536	20,830,039	24,351,867	23,485,257	22,212,702	17,755,772	11,528,717	1,220,201	128,438,889
Strip Ratio	W:O	1.55	3.77	5.94	3.43	3.18	2.17	1.52	0.64	0.18	2.39
<b>San Francisco Underground</b>	<b>Units</b>	<b>2020</b>	<b>2021</b>	<b>2022</b>	<b>2023</b>	<b>2024</b>	<b>2025</b>	<b>2026</b>	<b>2027</b>	<b>2028</b>	<b>Grand Total</b>
Ore	diluted tonnes	110,503	0	0	0	0	0	0	0	0	110,503
Gold grade	diluted g/t	4.089	0	0	0	0	0	0	0	0	4.089
Gold contained	Oz	14,529	0	0	0	0	0	0	0	0	14,529
Waste	tonnes	0	0	0	0	0	0	0	0	0	0
Total tonnes	tonnes	110,503	0	0	0	0	0	0	0	0	110,503
Strip Ratio	W:O	0	0	0	0	0	0	0	0	0	0
<b>Stockpile</b>	<b>Units</b>	<b>2020</b>	<b>2021</b>	<b>2022</b>	<b>2023</b>	<b>2024</b>	<b>2025</b>	<b>2026</b>	<b>2027</b>	<b>2028</b>	<b>Grand Total</b>
Ore tonnes	tonnes	782,048	0	0	0	0	0	0	0	0	782,048
Gold grade	grade	0.256	0	0	0	0	0	0	0	0	0.256
Gold contained	oz	6,437	0	0	0	0	0	0	0	0	6,437
<b>Total Mined</b>	<b>Units</b>	<b>2020</b>	<b>2021</b>	<b>2022</b>	<b>2023</b>	<b>2024</b>	<b>2025</b>	<b>2026</b>	<b>2027</b>	<b>2028</b>	<b>Grand Total</b>
Ore	diluted tonnes	1,781,311	5,948,028	6,192,927	5,961,199	5,625,166	7,004,925	7,038,030	7,043,118	1,034,193	47,628,898
Gold grade	diluted g/t	0.521	0.441	0.479	0.517	0.493	0.493	0.465	0.551	0.593	0.495
Gold contained	oz	29,845	84,291	95,363	99,122	89,145	110,920	105,130	124,865	19,707	758,390
Waste	tonnes	6,856,124	20,688,614	23,869,982	19,026,665	17,860,091	15,207,777	10,717,742	4,485,598	186,009	118,898,602
Total tonnes	tonnes	8,637,436	26,636,642	30,062,909	24,987,865	23,485,257	22,212,702	17,755,772	11,528,716	1,220,202	166,527,500
Strip Ratio	W:O	3.85	3.48	3.85	3.19	3.18	2.17	1.52	0.64	0.18	2.50
Daily ore throughput	t/d	4,880	16,296	16,967	16,332	15,411	19,192	19,282	19,296	2,833	16,875
Total daily moved	t/d	23,664	72,977	82,364	68,460	64,343	60,857	48,646	31,586	3,343	57,758
<b>Crusher Plan</b>	<b>Units</b>	<b>2020</b>	<b>2021</b>	<b>2022</b>	<b>2023</b>	<b>2024</b>	<b>2025</b>	<b>2026</b>	<b>2027</b>	<b>2028</b>	<b>Grand Total</b>
Total ore	tonnes	1,781,311	5,948,028	6,192,927	5,961,199	5,625,166	7,004,925	7,038,030	7,043,118	1,034,193	47,628,898
Gold grade	g/t	0.521	0.441	0.479	0.517	0.493	0.493	0.465	0.551	0.593	0.495
Gold Oz	oz	29,845	84,291	95,364	99,122	89,145	110,920	105,130	124,865	19,707	758,390
T/D crushed	avg. t/d	4,880	16,296	16,967	16,332	15,411	19,192	19,282	19,296	2,833	16,875

Product from the crushing plant is transported to the leach pad on overland conveyors and deposited on the pad with a stacker, forming 8 m to 12 m high lifts. Since the start-up of the operation, the construction of the leach pad has developed as six different phases, based on the permits granted by the Mexican Environmental Agency (PROFEPA, Procuraduría Federal de Protección al Ambiente). Table 1.6 summarizes the leach pad phases.

**Table 1.6**  
**Summary of the Leach Pad Phases Based Upon the Permits Acquired for the San Francisco Mine**

# Phase	Duration	Area	Nominal Capacity	Capacity to date	Status
1 & 2	Nov. 2009 to Nov. 2013	36 ha	26 Mt	25 Mt	Releached
3	Nov. 2013 to Aug. 2015	25 ha	18 Mt	18 Mt	On Irrigation
4	Aug. 2015 to Oct. 2016	16 ha	12 Mt	12 Mt	On Irrigation
5	Oct. 2016 to June 2017	12 ha	9 Mt	7 Mt	On Irrigation
6	June 2017 to Oct. 2020	17 ha	12 Mt	5 Mt	Depositing Ore
<b>Total</b>			<b>77 Mt</b>	<b>67 Mt</b>	

Table provided by Magna in August, 2020.

The leach solution fed to the heap consists of 0.05% sodium cyanide with lime addition to obtain a pH of between 10.5 to 11. Pregnant solution containing the leached gold is fed to two parallel adsorption-desorption-recovery (ADR) plants where gold is adsorped onto activated carbon then stripped using Zadra type elution circuits. Gold is recovered by electrowinning followed by smelting to produce gold doré bars.

Gold remaining in the old leach pads (Phases 1 and 2) is recovered in a parallel intermediate solution process where solution is continually recirculated until it is enriched enough to be fed to one of the ADR plants.

Magna's most recent LOM plan uses gold recovery curves that maximize after 150 days of leaching at 73% and 66% gold recovery for La Chicharra and San Francisco mineralization, respectively. This forecast is based on testwork and historical operating results.

The planned annual schedule of gold production is summarized in Table 1.7.

## **1.10 PROJECT ECONOMICS**

### **1.10.1 Capital and Operating Costs**

Magna has estimated the forecast capital and operating costs for the Project, and Micon has reviewed those forecasts for reasonableness. All estimates are expressed in second quarter 2020 United States dollars, without escalation. The expected accuracy of the estimates is  $\pm 20\%$ .

Given that the mine, processing plant and infrastructure at San Francisco mine are already established, there is no significant capital investment required in order to bring the Project back into operation.



**Table 1.7  
Annual Gold Production**

<b>Crusher Plan</b>	<b>Units</b>	<b>2020</b>	<b>2021</b>	<b>2022</b>	<b>2023</b>	<b>2024</b>	<b>2025</b>	<b>2026</b>	<b>2027</b>	<b>2028</b>	<b>Grand Total</b>
Total ore	kt	1,781	5,948	6,193	5,961	5,625	7,005	7,038	7,043	1,034	47,629
Gold grade	g/t	0.52	0.44	0.48	0.52	0.49	0.49	0.47	0.55	0.59	0.50
Gold Oz	oz	29,845	84,291	95,364	99,122	89,145	110,920	105,130	124,865	19,707	758,390
Residual Gold leached	oz	9,559	4,736	0	0	0	0	0	0	0	14,295
Newly-Mined Gold Leached	oz	15,010	61,531	62,640	68,125	58,336	71,892	70,066	82,564	22,189	512,354
Total Gold Production	oz	24,569	66,267	62,640	68,125	58,336	71,892	70,066	82,564	22,189	526,649
Recovery ex newly-mined ore	% cumulative	50%	67%	66%	67%	67%	66%	66%	66%	68%	68%

Provision is made for additional heap leach pad area to be built in seven (7) annual phases, at a unit cost rate of \$0.30/t heaped capacity. In addition, a provision is made for replacement or refurbishment of existing equipment, in the sum of \$100,000 per month over the LOM period. During the first 4 months after startup, this allowance is increased to a total of \$0.75 million. Total capital costs are forecast as shown in Table 1.8.

**Table 1.8**  
**Capital Cost Summary**

Area	Initial (Yr.1) Capital (\$M)	Sustaining (Yrs 2-8) Capital (\$M)	LOM Total Capital (\$M)
Leach Pad extensions	1.86	11.65	13.51
Equipment replacement	1.55	8.10	9.65
<b>Total</b>	<b>3.41</b>	<b>19.75</b>	<b>23.16</b>

Estimated cash operating costs over the life of the project are summarized in Table 1.9.

**Table 1.9**  
**Summary of Life-of-Mine Operating Costs**

Area	Life-of-Mine Cost (\$ 000)	Unit Cost \$/t ore milled	Unit Cost \$/oz Gold
Mining	353.79	\$7.43	672
Processing	211.93	\$4.45	402
General & Administrative	27.68	\$0.58	53
Selling costs	1.32	\$0.03	3
<b>Cash Operating Costs</b>	<b>594.72</b>	<b>\$12.49</b>	<b>1,129</b>
Royalties and Mining Tax	16.28	\$0.34	31
<b>Total Cash Cost</b>	<b>611.00</b>	<b>\$12.83</b>	<b>1,160</b>

Open pit mining costs are based on contracted rates for drill, blast, load and haul.

### 1.10.2 Economic Analysis

Micon has prepared its assessment of the Project on the basis of a discounted cash flow model, from which Net Present Value (NPV) can be determined. Assessments of NPV are generally accepted within the mining industry as representing the economic value of a project after allowing for the cost of capital invested.

The objective of the study was to determine the viability of the proposed restart of the San Francisco mine, heap-leaching facility and ADR plant. In order to do this, the cash flow arising from the base case has been forecast, enabling a computation of the NPV to be made. The sensitivity of this NPV to changes in the base case assumptions is then examined.

All results are expressed in United States dollars. Cost estimates and other inputs to the cash flow model for the Project have been prepared using constant, second quarter 2020 money terms, i.e., without provision for escalation or inflation.

In order to determine the NPV of the cash flows forecast for the Project, an appropriate discount factor must be applied which represents the weighted average cost of capital (WACC) imposed on the Project by the capital markets. The cash flow projections used for the evaluation have been prepared on an all-equity basis. This being the case, WACC is equal to the market cost of equity.

Micon has selected an annual discount rate of 5% for its base case, and has tested the sensitivity of the Project to changes in this rate.

Project revenues will be generated from the sale of gold/silver doré bars. However, for the purpose of this evaluation, only the value of the gold content has been considered.

The Project has been evaluated using constant gold price of \$1,450/oz. While below current market levels, the forecast gold price approximates the average achieved over the past 24 months.

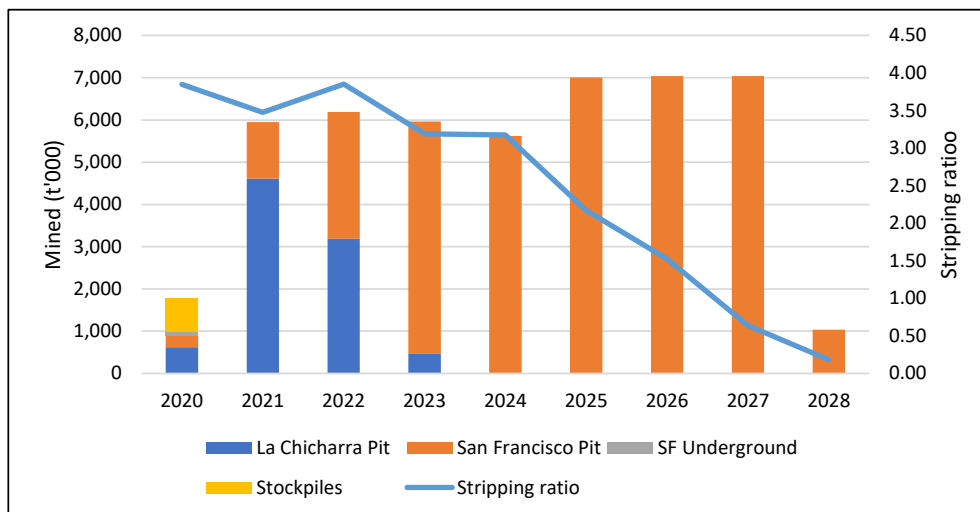
Mexican federal corporate income and mining taxes have been allowed for.

A tax credit of \$3.60 million is taken into consideration to off-set income tax payable at the rate of 30%. Capital depreciation allowances of approximately \$17.50 million are also taken into account over the LOM period.

State royalty on gold sales of 0.5%, as well as a royalty of 1.0% to previous owners of the property, have been provided for in the cash flow model.

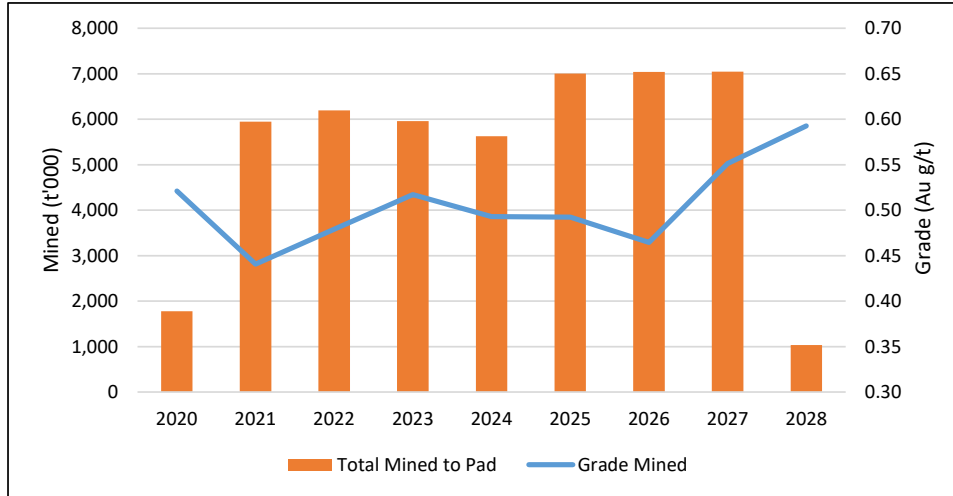
Figure 1.1 shows the annual tonnages of material heaped from each source, together with the overall waste stripping ratio.

**Figure 1.1**  
**Mining Production Schedule**



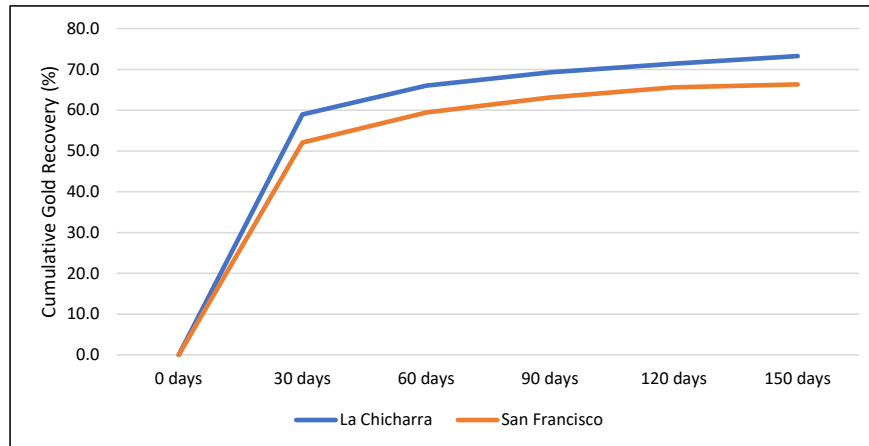
The annual tonnage and average grade of resource heaped is shown in Figure 1.2.

**Figure 1.2**  
**LOM Grade Profile**



The processing and gold production schedule takes into account the respective leach kinetics and ultimate gold recovery from La Chicharra and San Francisco material. In order to account for any delay in bringing mined material under leach, processing is assumed to start at the beginning of the following month, with gold being recovered from that material over the following five months as shown in Figure 1.3.

**Figure 1.3**  
**La Chicharra and San Francisco Heap Leach Profiles**



### 1.10.3 Project Cash Flow

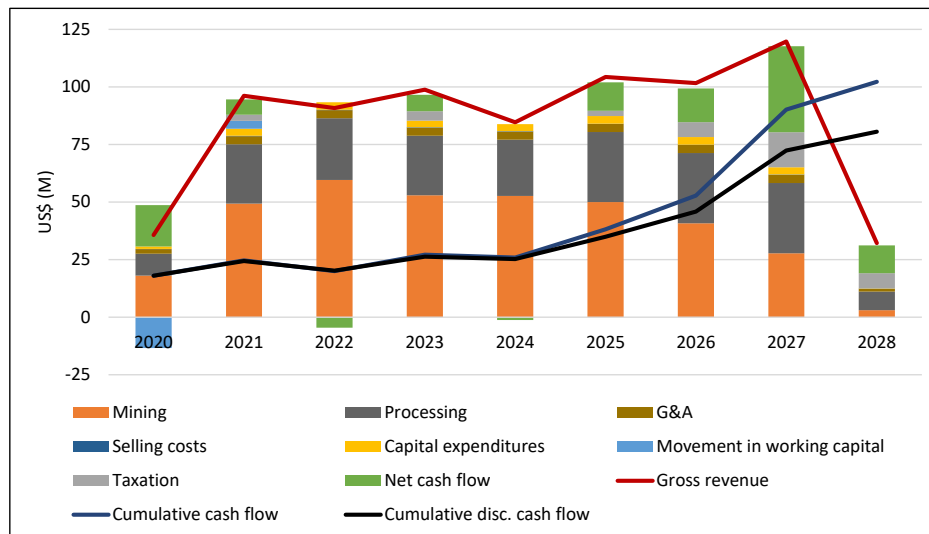
The LOM base case cash flow is summarized in Table 1.10. Annual cash flows are set out in Table 1.11 and summarized in Figure 1.4.

The after-tax cash flows, discounted at the rate of 5% per year, evaluate to a net present value (NPV<sub>5</sub>) of \$80.5 million. Owing to the absence of an initial negative cash flow, it is not possible to calculate an internal rate of return or payback period for the project.

**Table 1.10**  
**Life-of-Mine Cash Flow Summary**

	LOM Total \$'000	USD/t Treated	USD/oz Au
<b>Gross Revenue</b>	<b>763.64</b>	<b>\$16.03</b>	<b>1,450</b>
Mining costs	353.79	\$7.43	672
Processing costs	211.93	\$4.45	402
General & administrative costs	27.68	\$0.58	53
Selling expenses	1.32	\$0.03	3
<b>Cash operating cost</b>	<b>594.72</b>	<b>\$12.49</b>	<b>1,129</b>
Royalties & mining tax	16.28	\$0.34	31
<b>Total Cash Cost</b>	<b>611.00</b>	<b>\$12.83</b>	<b>1,160</b>
Net profit before tax	152.64	\$3.20	290
Taxation	37.24	\$0.78	71
<b>Net profit after tax</b>	<b>115.40</b>	<b>\$2.42</b>	<b>219</b>
Capital expenditure	23.16	\$0.49	44
Movement in working capital	(9.95)	(\$0.21)	(19)
<b>Net Cash flow after tax</b>	<b>102.20</b>	<b>\$2.15</b>	<b>194</b>
Cash Operating Cost per ounce			1,129
Total Cash Cost per ounce			1,160
All-in Sustaining Cost per ounce			1,204

**Figure 1.4**  
**Life-of-Mine Cash Flows**



**Table 1.11**  
**Base Case Life-of-Mine Annual Cash Flow**

Period	LOM Total	2020	2021	2022	2023	2024	2025	2026	2027	2028
Gold Sales (koz)	526.65	24.57	66.27	62.64	68.13	58.34	71.89	70.07	82.56	22.19
Gross revenue (USD '000)	763.64	35.63	96.09	90.83	98.78	84.59	104.24	101.60	119.72	32.17
Mining	353.79	17.99	49.28	59.53	52.93	52.66	49.97	40.70	27.69	3.04
Processing	211.93	9.56	25.80	26.86	25.86	24.40	30.38	30.53	30.55	7.99
G&A	27.68	2.01	3.50	3.50	3.50	3.50	3.50	3.50	3.50	1.17
Selling costs	1.32	0.06	0.17	0.16	0.17	0.15	0.18	0.18	0.21	0.06
Cash Operating Costs	594.72	29.62	78.75	90.05	82.46	80.71	84.03	74.91	61.95	12.25
Royalties & Mining Tax	16.28	0.40	1.52	2.19	2.24	2.14	2.27	2.34	2.11	1.08
Total Cash Costs (USD'000)	611.00	30.02	80.27	92.24	84.70	82.85	86.30	77.24	64.05	13.33
Net Profit before tax	152.64	5.60	15.82	(1.41)	14.08	1.74	17.95	24.35	55.66	18.84
Taxation	37.24	0.00	2.63	0.00	4.12	0.00	2.29	6.39	15.21	6.60
Net Profit after tax	115.40	5.60	13.19	(1.41)	9.97	1.74	15.65	17.96	40.46	12.24
Capital expenditures	23.16	1.05	3.06	3.22	2.83	3.06	3.31	3.31	3.10	0.20
Movement in working capital	(9.95)	(13.40)	3.45	0.00	0.00	0.00	0.00	0.00	0.00	0.00
Net cash flow	102.20	17.95	6.68	(4.63)	7.14	(1.33)	12.34	14.65	37.36	12.04
Cumulative cash flow		17.95	24.63	20.00	27.14	25.81	38.15	52.80	90.16	102.20
Discounted cash flow at 5%	80.49	17.95	6.36	(4.20)	6.16	(1.09)	9.67	10.93	26.55	8.15
Cumulative disc. cash flow		17.95	24.32	20.12	26.28	25.19	34.86	45.79	72.34	80.49
<b>Net Present Value (USD'000)</b>	<b>80.49</b>									
<b>Internal Rate of Return</b>	<b>n/a</b>	<i>NB - there must be a negative cash flow to enable IRR to be calculated</i>								
Cash Operating Cost(\$ per ounce)	1,129	1,206	1,188	1,438	1,210	1,384	1,169	1,069	750	552
Total Cash Cost (\$ per ounce)	1,160	1,222	1,211	1,472	1,243	1,420	1,200	1,102	776	601
All-in Sustaining Cost (\$ per ounce)	1,204	1,265	1,257	1,524	1,285	1,473	1,246	1,150	813	610

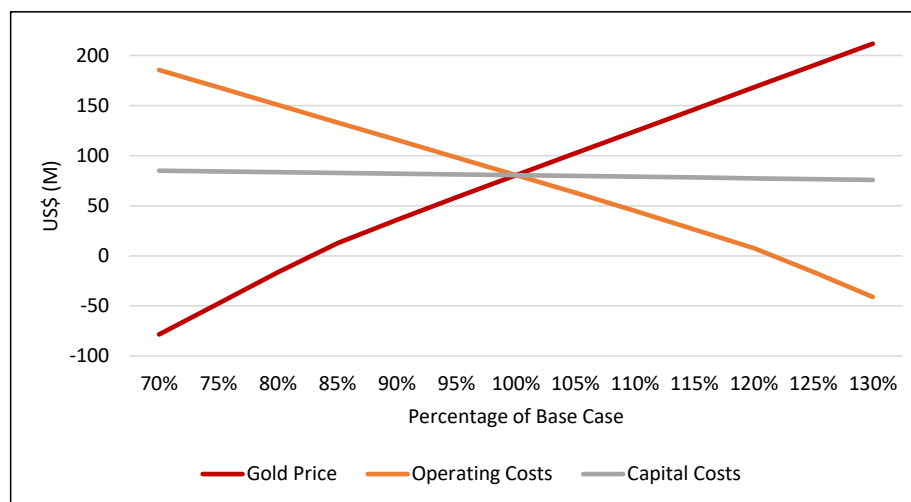
## 1.10.4 Sensitivity Study and Risk Assumptions

### 1.10.4.1 Metal Price and Exchange Rate Assumptions

The sensitivity of the after-tax NPV<sub>5</sub> to changes in metal price, operating costs and capital investment was tested for a range of 30% above and below base case values. The impact on Project NPV<sub>5</sub> to changes in other revenue drivers, such as gold grade of material treated and the percentage recovery of gold from processing, is equivalent to gold price changes of the same magnitude, so these factors can be considered as equivalent to the price sensitivity.

Figure 1.5 shows the results of changes in each factor separately. The chart demonstrates that the project is most sensitive to gold price, with a reduction of 17.5% giving rise to NPV<sub>5</sub> of close to zero. The project is slightly less sensitive to operating costs, with an increase of more than 21% required to reduce NPV<sub>5</sub> to near-zero. Unsurprisingly, given the relatively small capital costs required to restart the mine, NPV<sub>5</sub> is reduced by less than \$5 million for an increase of 30% in capital cost.

**Figure 1.5**  
**Sensitivity of NPV<sub>5</sub> to Capital, Operating Costs and Gold Price**



Separately, Micon also tested the sensitivity of the Project NPV<sub>5</sub> for specific gold prices above and below the base case price of \$1,450/oz. Table 1.12 shows the results of this exercise. A \$50/oz change in the gold price results in a change of approximately \$15 million in NPV<sub>5</sub>.

In August, 2020, gold prices reached a high of more than \$2,050/oz, and that the average price for the month was above \$1,950/oz.

**Table 1.12**  
**Sensitivity of NPV<sub>5</sub> to Gold Price**

<b>Gold Price (USD/oz)</b>	<b>NPV<sub>5</sub> (USDM)</b>
1,200	1.45
1,250	18.65
1,300	34.52
1,350	50.23
1,400	65.39
<b>1,450</b>	80.49
1,500	95.58
1,550	110.66
1,600	125.69
1,650	140.71
1,700	155.73
1,750	170.75
1,800	185.76
1,850	200.78
1,900	215.79
1,950	230.79
2,000	245.79

### **1.10.5 Economic Conclusion**

Micon concludes that, based on the forecast production, capital and operating costs presented in this study, the Project demonstrates an all-in sustaining cost (AISC) of \$1,204/oz, and that reopening the San Francisco mine represent a viable project at gold prices above \$1,250/oz.

### **1.11 CONCLUSIONS AND RECOMMENDATIONS**

Magna has completed its acquisition of 100% of Alio’s indirect wholly-owned subsidiary Molimentales which owns a 100% interest in the San Francisco Project.

Magna has also recommenced operations at the San Francisco Project by restarting mining at the La Chicharra pit and restarting the processing of the low-grade stockpile at the site.

In addition to bringing the mining operations back into production, Magna is also in the process of outlining and budgeting exploration activities in three areas of the San Francisco property as follows:

1. San Francisco mine (San Francisco and La Chicharra Pits).
2. Vetatierra Project.
3. La Pima Project.

Exploration at the San Francisco mine will consist of in-fill drilling to upgrade the material for the purposes of mining, and down dip exploration drilling to explore the extent and continuity of the mineralized zones below the current workings. Exploration at the Vetatierra and La Pima



Projects is being conducted to determine if these areas are potentially economic and could act as potential secondary feed sources for the operations.

Table 1.13 summarizes the estimated expenditures for Magna’s exploration programs for 2020 and 2021 for the three focus areas on the San Francisco property.

**Table 1.13**  
**Total Estimated Exploration Expenditures for Magna’s Three Focus Areas on the San Francisco Property**

<b>Year</b>	<b>Area</b>	<b>Expenditures (USD)</b>
2020-2021	San Francisco Mine (San Francisco and La Chicharra Pits)	4,369,575
2020	Vetatierra Project	374,704
2020	La Pima Project	605,350
<b>Total</b>		<b>5,349,629</b>

Table provided by Magna, August, 2020.

Micon has reviewed the exploration budgets proposed by Magna for each of the three areas and recommends that Magna proceed with the budget as proposed, subject to funding and other operational changes that may arise.

Given the prospective nature of the property, it is Micon’s opinion that the San Francisco Project and surrounding property merits further exploration with the objective of identifying additional mineralized zones with the potential to extend Project life. Further exploration programs and drilling on the property at a number of mineralized areas are necessary in order to identify other potential secondary mineral deposits which may be economic and provide secondary feed for the processing facilities.

Micon agrees with the general direction of Magna’s exploration and development program for the property and makes the following additional recommendations:

1. Magna can improve the mineralization wireframes for San Francisco and La Chicharra from being a series of extruded flat polygons to full 3D wireframes which would better define the mineralization boundaries.
2. Magna should do the assay compositing for both San Francisco and La Chicharra within the mineralization wireframes intercepts, instead of compositing the entire hole from collar to toe; this will potentially lead to higher average grades and improve the interpolation results.
3. Magna should continue the practice of ongoing column leach testwork on-site, using samples that represent future planned mining areas and potential new mineral resources identified during exploration. The data gleaned from this work will improve the understanding of the various mineralization types and help to optimize the recovery of gold.

## 2.0 INTRODUCTION

At the request of Miguel Soto, P.Ge. Vice President of Exploration for Magna Gold Corp. (TSXV: MGR, OTCQB: MGLQF) (MGR or Magna) Micon International Limited (Micon) has been retained to prepare an independent Technical Report for the San Francisco Gold Project (San Francisco Project or the Project) in the state of Sonora, Mexico. The purpose of this Technical Report is to support disclosure Magna's Pre-Feasibility Study for the San Francisco Project. The San Francisco Project is owned by Magna's wholly-owned subsidiary Molimentales del Noroeste, S.A. de C.V. (Molimentales) which owns a 100% interest in the Project and the surrounding mineral concessions.

Micon's most recent Technical Report for the Project was entitled "NI 43-101 F1 Technical Report for the San Francisco Gold Project, Sonora, Mexico", dated June 1, 2020. That Technical Report was filed by Magna on the System for Electronic Document Analysis and Retrieval (SEDAR, [www.sedar.com](http://www.sedar.com)). Micon has written 11 prior reports on the San Francisco Project since 2005.

### 2.1 INFORMATION REGARDING SAN FRANCISCO PROPERTY FROM PREVIOUS MICON REPORTS ALONG WITH UPDATED INFORMATION

Micon's most recent site visit to the San Francisco Project was conducted between May 15 and 17, 2017, during which the resources and reserves, as well as various aspects of the operation and mine plan, were discussed. The in-fill drilling programs and possible future exploration programs were also discussed. The site visit included a tour of the open pits, the locations of the planned pit push backs, crushing circuit and locations where the new crushing circuit was to be set-up.

Mani Verma, P.Eng. and William J. Lewis, P.Ge., conducted the May, 2017 site visit. Mr. Lewis has conducted a number of site visits to the San Francisco Project since 2005 and is very familiar with the Project.

The Qualified Persons (QPs) responsible for the preparation of this report are:

- William J. Lewis, P.Ge. Senior Geologist with Micon.
- Richard M. Gowans, P.Eng., President and Principal Metallurgist with Micon.
- Christopher Jacobs, CEng, MIMMM., Vice-President and Mining Economist with Micon.
- Nigel Fung, B.Sc.H, B.Eng., P.Eng., Vice-President and Senior Mining Engineer with Micon.
- Ing. Alan San Marin, MAusIMM(CP), Mineral Resource Specialist with Micon.
- Rodrigo Calles-Montijo, CPG, General Administrator and Principal Consultant with the firm Servicios Geológicos IMEx, S.C.

Mr. Lewis is responsible for the independent summary and review of the geology, exploration, Quality Assurance and Quality Control (QA/QC) program, as well as the resources for the San Francisco Project and the comments on the propriety of Magna's plans and budget for the next phase of exploration and in-fill drilling.

Various aspects of the San Francisco Project were reviewed by the other QPs, with Mr. Gowans covering the metallurgical aspects, Mr. Jacobs reviewing the economics, Mr. Fung reviewing the mining aspects and Mr. San Martin undertaking the review of the block model and audit of the mineral resource completed by Magna.

In conjunction with this report, a number of discussions were held via Skype, Zoom and telephone conference calls between Micon personnel in Toronto and Magna personnel in Hermosillo, regarding the database, block model and parameters for the mineral resource and reserve estimate, mine plan, as well as other topics related to the preparation of this Technical Report.

Mr. Lewis conducted site visits in relation to the majority of the previous Technical Reports that Micon has written for the San Francisco Project. These reports spanned the original acquisition and early exploration, through the production phase of the Project. Site visits in conjunction with Technical Reports were conducted in 2005, 2007, 2008, 2009, 2010, 2011, 2013, 2016 (2) and 2017.

The most recent site visit was completed on May 29, 2020, by Mr. Rodrigo Calles-Montijo, CPG, who is an independent consultant and Certified Professional Geologist (CPG), as well as a member of the American Institute of Professional Geologists (AIPG). Mr. Calles-Montijo, based in Hermosillo, México, was contracted by the management of Magna to undertake the current site visit, as required by NI 43-101 and which was unable to be executed by the representatives of Micon due the situation and travel limitations created by the COVID-19 pandemic. Prior to the site visit, a Skype meeting was organized with the participation of William J. Lewis (Micon), Miguel Soto (Magna) and Mr. Calles-Montijo, in order to delineate the objectives during the site visit. Mr. Calles-Montijo visited the mine accompanied by Miguel Soto and Jose Luis Soto, Manager of the San Francisco mine.

## **2.2 OTHER INFORMATION**

All currency amounts are stated in US dollars (USD) or Mexican pesos (MXN), as specified, with costs and commodity prices typically expressed in US dollars. Quantities are generally stated in metric units, the standard Canadian and international practice, including metric tons (tonnes, t) and kilograms (kg) for weight, kilometres (km) or metres (m) for distance, hectares (ha) for area, grams (g) and grams per metric tonne (g/t) for gold and silver grades (g/t Au, g/t Ag). Wherever applicable, Imperial units have been converted to Système International d'Unités (SI) units for reporting consistency. Precious metal grades may be expressed in parts per million (ppm) or parts per billion (ppb) and their quantities may also be reported in troy ounces (ounces, oz), a common practice in the mining industry. A list of abbreviations is provided in Table 2.1. Appendix 1 contains a glossary of mining and other related terms.

**Table 2.1  
List of Abbreviations**

<b>Name</b>	<b>Abbreviation</b>	<b>Name</b>	<b>Abbreviation</b>
Accurassay Laboratories	Accurassay	McClland Laboratories Inc.	McClland
Acme Analytical Laboratories Ltd.	ACME	METCON Research Inc.	METCON
Adsorption/desorption/reactivation	ADR	Metre(s)	m
All-in sustaining costs	AISC	Mexican peso	MXN
Alio Gold Inc.	Alio	Micon International Limited	Micon
ALS-Chemex Laboratories	ALS-Chemex	Million (eg million tonnes, million ounces, million years)	M (Mt, Moz, Ma)
Canadian Institute of Mining, Metallurgy and Petroleum	CIM	Milligram(s)	mg
Canadian National Instrument 43-101	NI 43-101	Millimetre(s)	mm
Canadian Securities Administrators	CSA	Molimentales del Noroeste de S.A. de C.V.	Molimentales
Centimetre(s)	cm	North American Datum	NAD
Certified Professional Geologist	CPG	Net present value, at discount rate of 5%/y	NPV, NPV <sub>8</sub>
Chartered Engineer	CEng	Net smelter return	NSR
Compania Fresnillo S.A. de C.V.	Fresnillo	Not available/applicable	n.a.
Defiance Mining Corporation	Defiance	Ounces (troy)/ounces per year	oz, oz/y
Degree(s), Degrees Celsius	°, °C	Parts per billion, part per million	ppb, ppm
Digital elevation model	DEM	Percent(age)	%
Dirección General de Minas	DGM	Professional Engineer	P.Eng.
Discounted cash flow	DCF	Quality Assurance/Quality Control	QA/QC
Diversified Drilling, S.A. de C.V.	Diversified	Qualified Person	QP
Electronic Data Gathering, Analysis and Retrieval	EDGAR	Run of mine	ROM
		Secretaría del Trabajo y Previsión Social	STPS
Explotaciones Mineras Del Noroeste S.A. de C.V.	Explotaciones Mineras	Servicios Industriales Peñoles, S.A. de C.V.	Peñoles
Geomaque de Mexico, S.A. de C.V.	Geomaque de Mexico	SGS Mineral Services	SGS
Geomaque Explorations Inc.	Geomaque	Sol & Adobe Ingenieros Asociados S.A. de C.V.	Sol & Adobe.
Golder Associates Ltd.	Golder Associates	Specific gravity	SG
Grams per metric tonne	g/t	Square kilometre(s)	km <sup>2</sup>
Hectare(s)	ha	System for Electronic Document Analysis and Retrieval	SEDAR
Hour	h	Three-dimensional	3-D
Inch(es)	in	Timmins Gold Corp.	Timmins or TMM
Independent Mining Consultants, Inc.	IMC	Timmins Goldcorp Mexico, S.A. de C.V.	Timmins
Inductively Coupled Plasma – Emission Spectrometry	ICP-ES	Tonne (metric)/tonnes per day, tonnes per hour	t, t/d, t/h
Internal diameter	ID	Tonne-kilometre	t-km
Internal rate of return	IRR	Tonnes per cubic metre	t/m <sup>3</sup>
Impuesto al Valor Agregado (or VAT)	IVA	TSL Laboratories Inc.	TSL
Kappes, Cassiday and Associates	Kappes Cassiday	United States Dollar(s)	USD
Kilogram(s)	kg	US gallons per minute	USgpm
Kilometre(s)	km	US Securities and Exchange Commission	SEC

Name	Abbreviation	Name	Abbreviation
Life-of-mine	LOM	Universal Transverse Mercator	UTM
Litre(s)	L	Value Added Tax (or IVA)	VAT or IVA
Magna Gold Corp.	Magna	Year	y

The review of the San Francisco Project was based on published material researched by Micon, as well as data, professional opinions and unpublished material submitted by the professional staff of Magna or its consultants. Much of these data came from reports prepared and provided by Magna or the previous owner Alio.

Micon does not have nor has it previously had any material interest in Magna or related entities. The relationship with Magna and related entities is solely a professional association between the client and the independent consultant. This report is prepared in return for fees based upon agreed commercial rates and the payment of these fees is in no way contingent on the results of this report.

This report includes technical information which requires subsequent calculations or estimates to derive sub-totals, totals and weighted averages. Such calculations or estimations inherently involve a degree of rounding and consequently introduce a margin of error. Where these occur, Micon does not consider them to be material.

The conclusions and recommendations in this report reflect the authors' best independent judgment in light of the information available to them at the time of writing. The authors and Micon reserve the right, but will not be obliged, to revise this report and conclusions if additional information becomes known to them subsequent to the date of this report. Use of this report acknowledges acceptance of the foregoing conditions.

This report is intended to be used by Magna subject to the terms and conditions of its agreement with Micon. That agreement permits Magna to file this report as a Technical Report with the Canadian Securities Administrators pursuant to provincial securities legislation or with the SEC in the United States. Except for the purposes legislated under provincial securities laws, any other use of this report, by any third party, is at that party's sole risk.

The descriptions of geology, mineralization and exploration used in this report are taken from reports prepared by various organizations and companies or their contracted consultants, as well as from various government and academic publications. The conclusions of this report are based in part on data available in published and unpublished reports supplied by the companies which have conducted exploration on the property, and information supplied by Magna. The information provided to Magna was supplied by reputable companies. Micon has no reason to doubt its validity and has used the information where it has been verified through its own review and discussions.

Micon is pleased to acknowledge the helpful cooperation of Magna management and consulting field staff, all of whom made any and all data requested available and responded openly and helpfully to all questions, queries and requests for material.

Some of the figures and tables for this report were reproduced or derived from historical reports written on the property by various individuals and/or supplied to Micon by the prior operator Alio for its previous Technical Reports or by Magna for this current report. Most of the photographs were taken by Mr. Lewis during his previous site visits or by Mr. Calles-Montijo during his recent site visit. In the cases where photographs, figures or tables were supplied by other individuals or Magna, they are referenced below the inserted item.

### **3.0 RELIANCE ON OTHER EXPERTS**

In this report, discussions regarding royalties, permitting, taxation, bullion sales agreements and environmental matters are based on material provided by Magna. Micon is not qualified to comment on such matters and has relied on the representations and documentation provided by Magna for such discussions.

All data used in this report were originally provided by either Alio or Magna. Micon has reviewed and analyzed this data and has drawn its own conclusions therefrom, augmented by its direct field examinations during the 2005, 2006, 2007, 2010, 2011, 2013, 2016 (2) and 2017 site visits.

Micon offers no legal opinion as to the validity of the title to the mineral concessions claimed by Magna and its wholly-owned Mexican subsidiaries and has relied on information provided by them. An updated legal opinion regarding the mineral concessions and its subsidiaries was provided to Micon by Magna for this Technical Report. The legal opinion was dated August 12, 2020 and was prepared and executed by the law firm of DBR Abogados, S.C. situated at Av. Nuevo León No. 22, Piso 4, Col. Hipódromo 06100, Ciudad de México. A copy of the updated legal opinion is attached to this report as Appendix II.

## 4.0 PROPERTY DESCRIPTION AND LOCATION

### 4.1 GENERAL

The San Francisco property is located in the north central portion of the Mexican state of Sonora, which borders on the American state of Arizona, and is approximately 150 km north of the city of Hermosillo, the capital of Sonora. The latitude and longitude for the Project site are approximately 30°21'13" N, 111°06'52" W. The UTM coordinates are 3,357,802 N, 489,017 E and the datum used was NAD 27 Mexico. The Project is located 2 km west of the town of Estación Llano and is accessed via Mexican State Highway 15 (Pan American highway) from Hermosillo.

The term San Francisco Project refers to the area related to the exploitation concessions controlled by Alio, while the term San Francisco property refers to the entire land package (mineral exploitation and exploration concessions) under Magna's control. The location of the San Francisco property is shown in Figure 4.1.

**Figure 4.1**  
**San Francisco Project Location Map**

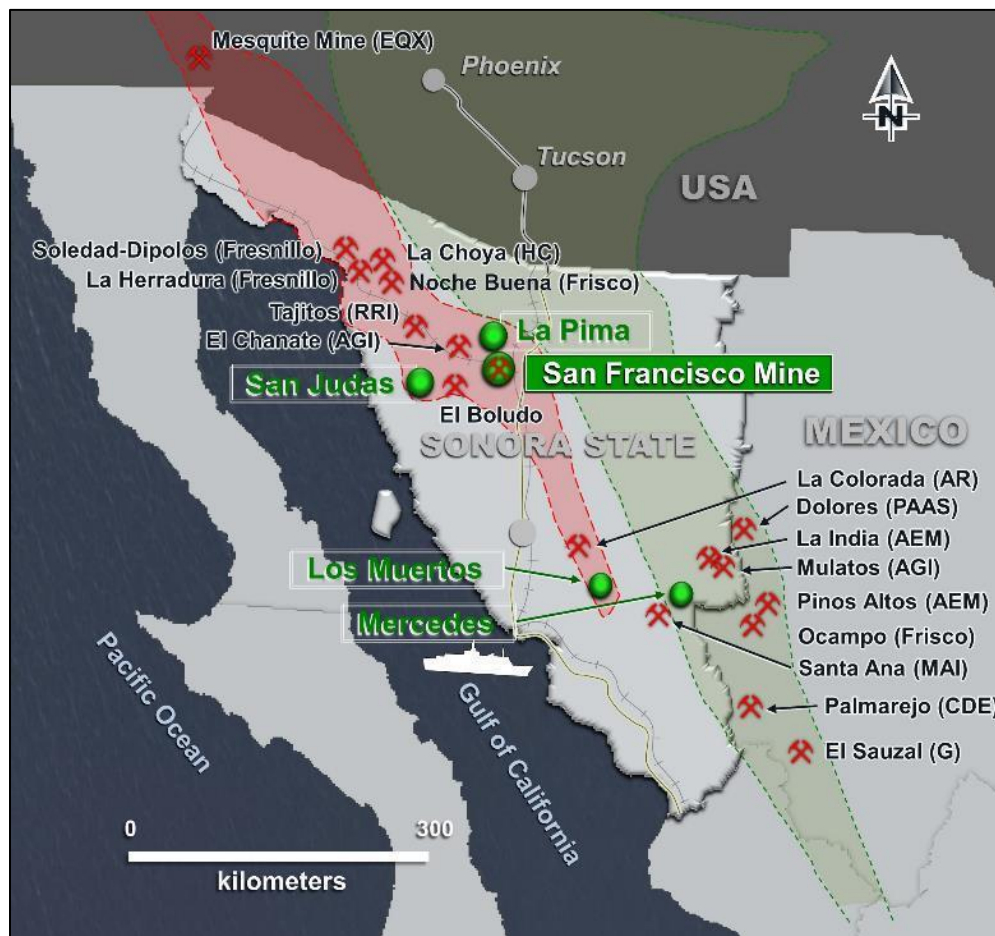


Figure originally provided by Magna Gold Corp. Figure dated July, 2020.



## 4.2 OWNERSHIP

### 4.2.1 Magna Ownership Information

Magna advises that it holds the San Francisco Project, which consists of 13 mining concessions, through its indirect wholly-owned subsidiary Molimentales. All the concessions are contiguous and each varies in size for a total property area of 33,667.72 hectares (ha). In late 2005, the original Timmins II concession was subdivided into two concessions (Timmins II Fraccion Sur and Pima), as part of separate exploration strategies for the original Timmins II concession. All concessions are subject to a bi-annual fee and the filing of reports in May of each year covering the work accomplished on the property between January and December of the preceding year. The fee rates are estimated in US dollars based on the rates published in the “Diario Oficial de la Federacion (DOF)” as of February 28, 2020.

The size of the primary mineral concessions was reduced in 2015 by eliminating those areas deemed have very little exploration potential, while maintaining the integrity of the overall concessions. After 2015, Molimentales retained approximately 19,713 ha, which it believed contained the most prospective geology and mineralized targets upon which to base further exploration. The reduction in the size of the concessions has also resulted in a reduction in the bi-annual fees for the Project. A further reduction occurred in 2016 when the El Exito and El Picacho concessions were dropped. A total of 13,284.19 ha was retained in the regional package of mineral concessions.

The information for the thirteen concessions is summarized in Table 4.1. A map of the mineral concessions for the San Francisco property is provided in Figure 4.2.

In 2006, a temporary occupancy agreement was signed with an agrarian community (an Ejido) in Mexico called Los Chinos, whereby Molimentales was granted access privileges to 674 ha, the use of the Ejido’s roads, as well as being able to perform all exploration work on the area covered by the agreement.

During August and September, 2009, Molimentales acquired the 800 ha of surface land on which the San Francisco mine is located, by means of five purchase agreements covering all of the Ejido Jesus Garcia Heroe de Nacozari’s five former parcels that together form the 800 ha.

In September, 2011, Molimentales acquired 732 ha from Ejido Los Chinos, which was originally part of the exploration agreement signed in 2006.

Other parties control two mineral concessions which are contained within the area of the mineral concessions owned by Molimentales but neither of these concessions impacts the main area of the San Francisco Project.

**Table 4.1**  
**San Francisco Project, Summary of Mineral Concessions**  
**(with Fees for 2020 noted)**

Mineral Concession Name	Title Number	Owner	Location (UTM Nad 27 Mex)	Mineral Concession Type	Area (hectares) <sup>1</sup>	Location Date	Expiry Date	Bi-Annual Fee (USD) <sup>2,3</sup>
San Francisco	198971	Molimentales del Noroeste, S.A de C.V.	488,675.174 E 3,359,396.801 N	Mining Concession	48.0000	February 11, 1994	February 10, 2044	865
San Francisco Dos	209618	Molimentales del Noroeste, S.A de C.V.	488,675.174 E 3,359,396.801 N	Mining Concession	315.6709	August 3, 1999	August 2, 2049	5,600
San Francisco Cuatro	219301	Molimentales del Noroeste, S.A de C.V.	488,675.174 E 3,359,396.801 N	Mining Concession	5,189.7041	February 25, 2003	February 25, 2053	93,000
Llano II	197203	Molimentales del Noroeste, S.A. de C.V.	483,652.702 E 3,356,290.081 N	Mining Concession	500.0000	December 19, 1991	December 18, 2041	8,960
Llano III	197202	Molimentales del Noroeste, S.A de C.V.	483,652.702 E 3,356,290.081 N	Mining Concession	500.0000	December 19, 1991	December 18, 2041	8,960
Llano IV	222787	Molimentales del Noroeste, S.A. de C.V.	488,675.174 E 3,359,396.801 N	Mining Concession	500.0000	August 31, 2004	August 30, 2054	8,960
Llano V	222788	Molimentales del Noroeste, S.A. de C.V.	483,652.702 E 3,356,290.081 N	Mining Concession	500.0000	August 31, 2004	August 30, 2054	8,960
Timmins	226519	Molimentales del Noroeste, S.A. de C.V.	488,675.174 E 3,359,396.801 N	Mining Concession	337.0000	January 24, 2006	January 23, 2056	6,050
Timmins III Fraccion 1	227237	Molimentales del Noroeste, S.A. de C.V.	481,529.246 E 3,371,837.280 N	Mining Concession	346.0004	May 26, 2006	May 25, 2056	6,200
Timmins III Fraccion 2	227238	Molimentales del Noroeste, S.A. de C.V.	481,529.246 E 3,371,837.280 N	Mining Concession	54.2835	May 26, 2006	May 25, 2056	975
Timmins II Fraccion Sur <sup>1</sup>	228260	Molimentales del Noroeste, S.A. de C.V.	488,675.174 E 3,359,396.801 N	Mining Concession	20,370.0604	March 14, 2006	March 13, 2056	366,000
Pima Reduccion <sup>1</sup>	228261	Molimentales del Noroeste, S.A. de C.V.	486,058.775 E 3,375,493.728 N	Mining Concession	4,997.0000	March 14, 2007	March 13, 2056	90,000
La Mexicana	191137	Molimentales del Noroeste, SA de CV	487,910,487 E 3*363,995.686 N	Mining Concession	10.0000	April, 29, 1991	April 28, 2041	180
<b>Total:</b>	-	-	-	-	<b>33,667.72</b>	-	-	<b>604,710</b>

Table provided by Alio Gold Inc.

Notes:

<sup>1</sup> The Timmins II claim, originally staked with a surface of 39,403.0000 ha, was titled by the Direccion General de Minas (DGM) with a surface of 36,142.0604 ha after surveying was completed. In 2008, due to a change in exploration strategy, the Timmins II claim was divided into two claims, Timmins II Fraccion Sur and Pima. In 2015, the surface area of the Pima claim was reduced from 15,772 ha to 4,997 ha

<sup>2</sup> Fees are estimated in US dollars based on the rates published in the "Diario Oficial de la Federacion (DOF)". The exchange rate used is 19 pesos = 1 US Dollar.

<sup>3</sup> The table includes payment for both semesters of 2020, the first semester has already been paid by Alio and the payment for the second semester in July, 2020 will be paid by Magna.

**Figure 4.2**  
**San Francisco Property (Concessions) Map**

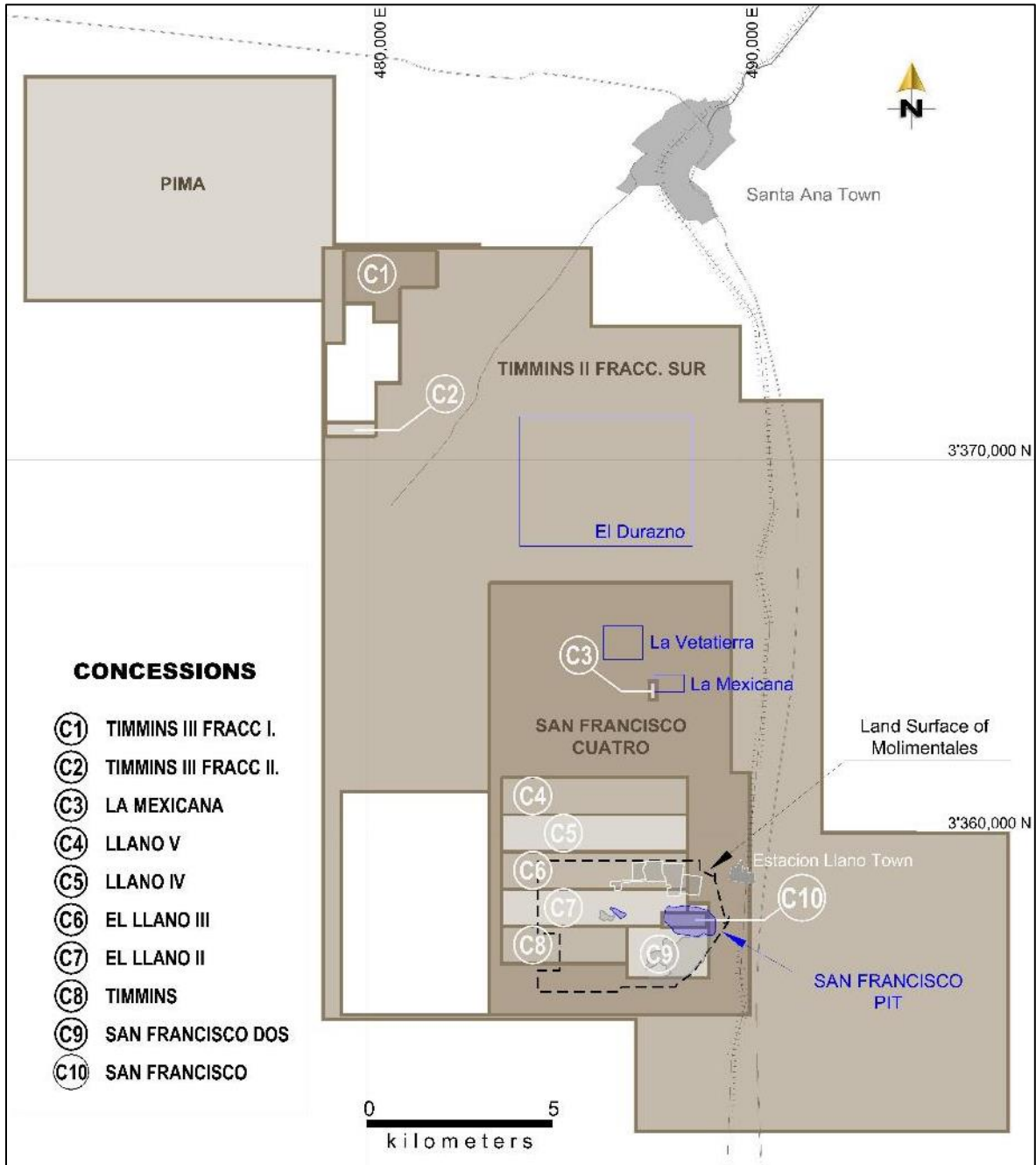


Figure taken from June, 2020, Micon Technical Report and dated May, 2017.

On February 23, 2011, an additional 95,000 ha of claims were staked along the highly prospective Sonora-Mojave Megashear structural province in northern Sonora with additional claims staked in subsequent years. In 2015 and 2016, the regional concessions were reduced with only ground that was deemed significant to future exploration kept. The information

regarding the regional mineral concessions staked is summarized in Table 4.2. A map of the regional concessions is provided in Figure 4.3.

On July 6, 2011, Molimentales acquired (through a straight purchase) a 10-ha mineral concession called La Mexicana by paying the vendor, Mr. Agustin Albelais, a buy-out price of USD 250,000. The La Mexicana mineral concession was the last area in the metamorphic package that did not belong to Alio.

Molimentales has completed the process of converting the 674 hectares contracted from the Los Chinos Ejido into private property. The 674 ha was purchased by Molimentales, in 2011, and the final public instrument documenting the purchase was issued on February 9, 2015.

Since completing the purchase of the 674 ha from the Los Chinos Ejido, Molimentales has not undertaken any further land purchases and believes no further purchases are necessary at this time.

#### **4.2.2 Magna Acquisition Information**

Magna announced that it had entered into a definitive purchase agreement with Timmins, a wholly-owned subsidiary of Alio, to acquire the San Francisco mine, on March 6, 2020. Details for the acquisition are noted below:

##### **“Summary of the Acquisition”**

*“Under the terms of the Definitive Agreement, Magna will acquire 100% of Alio’s indirect wholly-owned subsidiary Molimentales del Noroeste, S.A. de C.V., which owns a 100% interest in the San Francisco mine and the surrounding mineral concessions, in exchange for:”*

*“On Closing: The issuance of 9,740,000 common shares in the capital of the Company (Common Shares), representing approximately 19.9% of the issued and outstanding Common Shares upon closing of the Acquisition (the Consideration Shares).”*

*“12 Months from Closing: USD 5 million in cash or a 1% net smelter return royalty on a portion of the San Francisco mine, at the election of Magna.”*

*“The Consideration Shares will be subject to a lock-up agreement until the earlier of:*

- (i) the date that is 12 months from the closing of the Acquisition, and;*
- (ii) the date on which Timmins and its affiliates collectively hold less than 9.9% of the Common Shares on an undiluted basis. In the event that Timmins wishes to sell any or all of the Consideration Shares, Magna will have the option to arrange the purchaser of such shares until Timmins and its affiliates collectively hold less than 9.9% of the Common Shares on an undiluted basis.”*

**Table 4.2**  
**San Francisco Project, Summary of the Regional Mineral Concessions**  
**(with Fees for 2020 Noted)**

Mineral Concession Name <sup>1</sup>	Title Number	Owner	Location (UTM Nad 27 Mex)	Mineral Concession Type	Area (hectares)	Location Date	Expiry Date	Bi-Annual Fee (USD) <sup>2,3</sup>
Norma Reduccion	229257	Molimentales del Noroeste, S.A de C.V	452,096,625 E 3,365,740.855 N	Mining Concession	4,989.0250	March 28, 2007	March 27, 2057	90,000
Patricia	229241	Molimentales del Noroeste, S.A de C.V	423,787.078 E 3,333,878.085 N	Mining Concession	3,539.4141	March 27, 2007	March 26, 2057	63,500
Los Carlos	227334	Molimentales del Noroeste, S.A de C.V	423,787.078 E 3,333,878.085 N	Mining Concession	9.0000	March 5, 2002	March 4, 2052	162
Los Carlos 2	215707	Molimentales del Noroeste, S.A de C.V	423,787.078 E 3,333,878.085 N	Mining Concession	93.3800	March 4, 2002	March 5, 2052	1,675
Los Carlos 3	225423	Molimentales del Noroeste, S.A de C.V	423,787.078 E 3,333,878.085 N	Mining Concession	177.6907	September 6, 2005	September 5, 2055	3,200
Dulce	228428	Molimentales del Noroeste, S.A de C.V	472,205,063E 3,348,823,297N	Mining Concession	150.0000	November 22, 2006	November 21, 2056	2,690
Dulce I	240007	Molimentales del Noroeste, S.A de C.V	503,058.158 E 3'384,863.624 N	Mining Concession	4,325.6836	March 29, 2012	March 28, 2062	44,100
<b>Total:</b>	-	-	-	-	<b>13,284.1934</b>		-	<b>205,327</b>

Table provided by Alio Gold Inc.

Notes:

<sup>1</sup> During 2015 and 2016, a number of the claims to the northwest of the existing operation that comprised the regional exploration area were dropped but the claims containing the most significant exploration targets were maintained.

<sup>2</sup> Fees are estimated in US dollars based on the rates published in the “Diario Oficial de la Federacion (DOF)”. The exchange rate used is 19 pesos = 1 US Dollar.

<sup>3</sup> The table includes payment for both semesters of 2020, the first semester has already been paid by Alio and the payment for the second semester in July, 2020 will be paid by Magna.

**Figure 4.3**  
**San Francisco Project Regional Mineral Concessions Map**

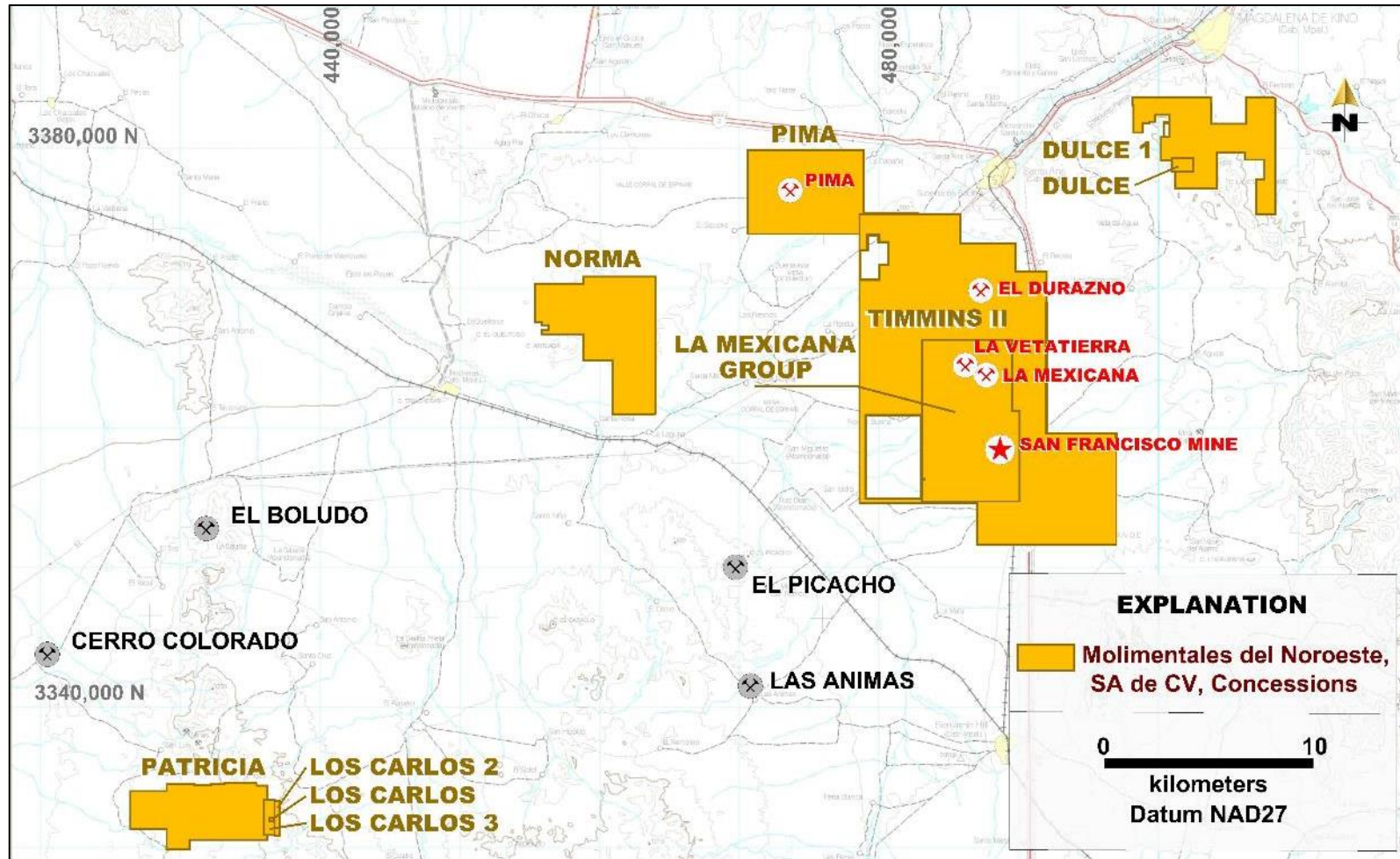


Figure provided by Magna Gold Corp. Figure dated March, 2020.

*“Magna expects to conclude an ongoing arbitration process with a prior mining contractor that is related to operations at the San Francisco mine. Discussions between Magna and the contractor have been meaningfully advanced, and the Magna expects to come to a positive resolution in the near term.”*

*“Completion of the Acquisition is subject to a number of customary conditions, including receipt of all regulatory approvals and the acceptance of the TSX Venture Exchange.”*

*“The Acquisition is expected to close at the end of March, 2020.”*

On April 24, 2020, Magna announced that the the acquisition agreement was amended by Magna and Timmins as follows:

***“Amendment to Definitive Agreement and Private Placement”***

*“Timmins and the Company have entered into an amendment to the Definitive Agreement to include the closing of the Private Placement (as defined below) as a condition precedent to the closing of the Acquisition for the benefit of Timmins. Further to the news release dated March 6, 2020, the Private Placement will be structured as a non-brokered private placement of a minimum of 5,143,000 and a maximum of 5,714,286 common shares in the capital of the Company (the “Offered Shares”) at a price of \$0.35 per Offered Share for aggregate gross proceeds of a minimum of approximately \$1,800,050 and a maximum of approximately \$2,000,000 (the “Private Placement”).”*

*“The net proceeds from the Private Placement will be used for the acquisition of, and for working capital purposes in connection with, the San Francisco mine.”*

*“In connection with the Private Placement, certain parties may receive a finder’s fee payment equal to 6% of the gross proceeds of the Offered Shares that are sold to subscribers introduced by such parties, payable in cash or common shares in the capital of the Company at the discretion of the Company, and warrants (the “Finder’s Warrants”) to purchase that number of common shares in the capital of the Company (the “Finder’s Warrant Shares”) equal to 5% of the Offered Shares that are sold to subscribers introduced by such parties, with each Finder’s Warrant being exercisable for one Finder’s Warrant Share at a price of \$0.35 per Finder’s Warrant Share for a period of two years from the date of the closing of the Private Placement. The finder’s fee payment and the Finder’s Warrants are subject to the approval of, and will be issued in accordance with, the rules of the Exchange.”*

*“The securities issued in connection with the Private Placement will be subject to a four month hold period from the date of issuance in accordance with applicable Canadian securities laws. The Private Placement is subject to the receipt of all required regulatory approvals, including the acceptance of the Exchange.”*

*“The Offered Shares have not been, nor will they be, registered under the United States Securities Act of 1933, as amended (the “Securities Act”), and may not be offered, sold or*

*delivered, directly or indirectly, within the United States, or to or for the account or benefit of U.S. persons, unless the Offered Shares are registered under the Securities Act or pursuant to an applicable exemption from the registration requirements of the Securities Act. This news release does not constitute an offer to sell, nor is it a solicitation of an offer to buy securities, nor shall there be any sale of securities in any state in the United States in which such offer, solicitation or sale would be unlawful.”*

### **“Settlement of Arbitration Proceedings”**

*“In connection with the Acquisition, the Company has also entered into a binding letter of intent with Peal de Mexico, S.A. de C.V. (“Peal”) to settle the existing arbitration proceedings between Peal and Molimentales del Noroeste, S.A. de C.V., the entity to be acquired by the Company which owns a 100% interest in the San Francisco mine, following closing of the Acquisition for aggregate consideration of approximately USD6,354,782.81 (plus value added taxes), to be satisfied by the issuance of 11,000,000 common shares in the capital of the Company (the “Settlement Shares”) at a deemed price of \$0.35 per Settlement Share on the date settlement and USD3,495,130.18 (plus valued added taxes) to be paid in cash within a period of 18 months from the date of settlement, with a grace period of six months at the election of the Company (the “Settlement”).”*

*“The Settlement Shares will be subject to a lock-up agreement until the earlier of (i) the date that is 12 months from the issuance of the Settlement Shares and (ii) the date on which Peal and its affiliates collectively hold less than 9.9% of the outstanding common shares in the capital of the Company. In the event that Peal wishes to sell any or all of the Settlement Shares, the Company will have the option to arrange the purchaser of such shares so long as Peal and its affiliates collectively hold more than 9.9% of the outstanding common shares in the capital of the Company. For so long as Peal and its affiliates collectively hold 10% or more of the outstanding common shares in the capital of the Company, Peal shall have the right to participate in any future share issuance made by the Company up to a maximum of 19% of the outstanding common shares in the capital of the Company on the same terms as the applicable equity offering, subject to certain customary exceptions.”*

*“The Settlement is subject to a number of conditions customary for a transaction of this nature, including the entering into of definitive documentation, the completion of the Acquisition and the receipt of all required regulatory approvals, including the acceptance of the Exchange.”*

*“The Settlement Shares will be subject to resale restrictions pursuant to the policies of the Exchange which will expire four months and one day from the date of issuance of the Settlement Shares.”*

On May 6, 2020, Magna announced that it had closed the acquisition of the San Francisco mine pursuant to a definitive share purchase agreement dated March 5, 2020, as amended April 24, 2020, between Timmins, a wholly-owned subsidiary of Alio, and itself.



Magna also announced the following key milestones:

- The closing of a concurrent non-brokered private placement, providing the Company with gross proceeds of approximately C\$2,000,000.
- A favourable agreement with Peal, the prior mining contractor for the San Francisco mine, with respect to the ongoing arbitration process (the Settlement).

#### **4.3 MEXICAN MINING LAW**

When the Mexican mining law was amended in 2006, all mineral concessions granted by the Dirección General de Minas (DGM) became simple mining concessions and there was no longer a distinction between mineral exploration or exploitation concessions. A second change to the mining law resulted in all mining concessions being granted for a period of 50 years, provided that the concessions remained in good standing. As part of the second change, all former exploration concessions which were previously granted for a period of 6 years became eligible for the 50-year term.

For any concession to remain valid, the bi-annual fees must be paid and a report has to be filed during the month of May of each year which covers the work conducted during the preceding year. Concessions are extendable, provided that the application is made within the five-year period prior to the expiry of the concession and the bi-annual fee and work requirements are in good standing. The bi-annual fee, payable to the Mexican government to hold the group of contiguous mining concessions for the San Francisco operations is USD 604,710. The bi-annual fee to hold the group of contiguous mining concessions which comprise the regional mineral property is USD 205,327.

All mineral concessions must have their boundaries orientated astronomically north-south and east-west and the lengths of the sides must be one hundred metres or multiples thereof, except where these conditions cannot be satisfied because they border on other mineral concessions. The locations of the concessions are determined on the basis of a fixed point on the land, called the starting point, which is either linked to the perimeter of the concession or located thereupon. Prior to being granted a concession, the company must present a topographic survey to the DGM within 60 days of staking. Once this is completed the DGM will usually grant the concession.

#### **4.4 PERMITTING AND ENVIRONMENTAL**

Since the San Francisco Project is located on a number of concessions upon which mining has previously been conducted, all exploration work continues to be covered by the environmental permitting already in place and no further notice is required to be given to any division of the Mexican government. The specific environmental permitting of the San Francisco mine site was obtained in December, 2007, via an environmental assessment, and it is valid for the duration of the seven mining concessions that comprise the mine, provided that Molimentales keeps the permitting in good standing. Water for any drilling programs at the San Francisco Project is obtained from the on-site water wells.

Micon is unable to comment on any remediation which may have been undertaken by previous owners. Environmental studies and permitting by Alio for its San Francisco Project are discussed in Section 20.0 of this report. Magna has not completed any further environmental studies and permitting as of the date of this report.

## 5.0 ACCESSIBILITY, CLIMATE, LOCAL RESOURCES, INFRASTRUCTURE AND PHYSIOGRAPHY

This Section has been partly extracted from the June 1, 2020, Technical Report completed by Micon for Magna and updated with further information, if applicable.

### 5.1 ACCESSIBILITY

The San Francisco property is readily accessible from Hermosillo, the state capital of Sonora, via Mexican State Highway 15 (Pan American Highway). The property is 150 km north of Hermosillo and is 120 km south of the United States/Mexico border city of Nogales, also on Highway 15. The San Francisco mine site is 2 km west of the town of Estación Llano. The major population centre for the region is Magdalena de Kino (Magdalena) to the north, with a population of over 50,000 inhabitants. Figure 5.1 is a view of the San Francisco mine from Highway 15 driving south towards Hermosillo.

**Figure 5.1**  
**San Francisco Mine as Viewed from Highway 15 Driving South from Santa Ana**



Photograph taken during the May, 2017 Micon site visit.

The mineral concessions are located approximately due west and north of Estación Llano, with the closest accommodations being in Santa Ana, a small city located to the north on Highway 15.

## 5.2 LOCAL RESOURCES AND INFRASTRUCTURE

Guarded gates are maintained across the access road to the mine and immediate Project area. Exploration can be conducted throughout the year, with the desert monsoon season occurring between July and September. Materials needed to supply the mine are transported by either truck (utilizing Mexican State Highway 15) or by rail (utilizing the Ferrocarril del Pacifico railway), both of which pass through the community of Estación Llano.

Magna has been granted the temporary occupation of surface rights at the San Francisco mine by the DGM for the duration of the exploitation concessions. In the case of an exploration concession, the holder is granted temporary occupancy for the creation of land easements needed to carry out exploration for the duration of the mineral concession. In order to commence mining, the holder of the concession is required to negotiate the surface rights with the legal holder of these rights or to acquire the surface rights through a temporary expropriation. The current surface rights are more than adequate to cover the infrastructure, mining and stockpile areas needed for the life of the Project.

Water for the drilling programs is available from three wells located on the mine site. The water table in the area of the mine is approximately 25 m below the surface. A typical water well is shown in Figure 5.2.

**Figure 5.2**  
**View of a Water Well Located on the San Francisco Project**



Photograph taken during the 2017 Micon site visit.

The surrounding cities and towns supply the majority of the workers, with the professional staff coming from other parts of Mexico.

The site contains all of the necessary infrastructure to maintain and operate the equipment and mine.

### 5.3 CLIMATE AND PHYSIOGRAPHY

The Project is located in the Arizona-Sonora desert in the northern portion of the Mexican state of Sonora. The climate at the Project site ranges from semi-arid to arid. The average ambient temperature is 21°C, with minimum and maximum temperatures of -5°C and 50°C, respectively. The average annual rainfall for the area is 330 mm, with an upper extreme of 880 mm.

The wet season or desert monsoon season is between July and September and heavy rainfall can hamper exploration at times.

The San Francisco property is situated within the southern Basin and Range physiographic province, which is characterized by elongate, northwest-trending ranges separated by wide alluvial valleys. The San Francisco mine is located in a relatively flat area of the desert with the topography ranging between 700 and 750 m above sea level.

The desert vegetation surrounding the San Francisco mine is composed of low lying scrub, thickets and various types of cacti, with the vegetation type classified as *Sarcocaulus* Thicket. The state of Sonora is well known for its mining and cattle industries, although US manufacturing firms have moved into the larger centres as a result of the North American Free Trade Agreement (NAFTA). See Figure 5.3 for a view of the desert surrounding the San Francisco Project, between the distant hills, as viewed driving south towards the project from the community of Santa Ana.

**Figure 5.3**  
**View of the Sonora Desert Surrounding the Property**



Photograph taken during the 2017 Micon Site Visit.

## 6.0 HISTORY

This Section has been partly extracted from the June 1, 2020, Technical Report completed by Micon for Magna and updated with further information, if applicable.

### 6.1 SAN FRANCISCO PROPERTY AND GOLD MINE

#### 6.1.1 General History Prior to Alio Ownership

The San Francisco mine is a heap leach operation which was in production originally between 1995 and 2002. However, during the last two years of operation, gold was being recovered from the leach pads only, with no mining being conducted from the San Francisco and La Chicharra open pits.

Placer mining and small scale underground mining began in the San Francisco mine area during the early 1940s. This limited work drew Fresnillo to the area in 1983. In 1985, three diamond drill holes and 30 conventional percussion drill holes were completed on the property. The results of these drill holes were encouraging enough to warrant additional diamond drilling during 1986. In 1987, 540 m of underground development was conducted, including a decline and a number of drifts and cross-cuts. The decline was completed to the 685 m elevation above sea level, where numerous 1.8 by 1.5 m drifts and cross-cuts were developed. Fresnillo drilled 10 diamond drill holes and 25 reverse circulation drill holes in 1988, and an additional 226 reverse circulation holes in 1989. Metallurgical testing and an induced polarization survey were also completed in 1989. In 1990 and 1991, Fresnillo completed an additional 108 reverse circulation drill holes. See Figure 6.1 for an example of one of the rotary drill site locations southeast of the main pit.

Fresnillo decided to sell the property in 1992, at which time it was acquired by Geomaque. As part of the Geomaque purchase, Fresnillo retained a 3% NSR royalty and the option to re-acquire a 50% interest by paying Geomaque twice the amount which it had expended. Geomaque completed a feasibility study in 1993 and drilled a further 69 reverse circulation drill holes in 1994. Geomaque acquired the NSR royalty and option back from Fresnillo in 1995 for USD 4,700,000.

Geomaque conducted its activities in Mexico through its subsidiaries, Geomaque de Mexico, S.A. de C.V. (Geomaque de Mexico) and Mina San Francisco, S.A. de C.V. (Mina San Francisco).

Geomaque began construction of the San Francisco mine in 1995, with production beginning late in that year. Production began at the rate of 3,000 t/d of ore or 30,000 oz/y of gold. As a result of the discovery of additional reserves, an expansion of the mining fleet, crushing system and gold recovery plant was undertaken in an effort to increase production to 10,000 t/d of ore. Due to the prevailing market conditions in February, 2000, Geomaque announced a revised mine plan whereby higher grade ore with a lower stripping ratio would be mined from the San Francisco pit and the La Chicharra deposit, which is located west of the San Francisco pit.

The San Francisco area contained the El Manto, the San Francisco, the En Medio and the El Polvorin deposits. All of these deposits were later incorporated into the main San Francisco pit. The La Chicharra zone was mined during the last two years of production as a second pit.

**Figure 6.1**  
**Location of One of the Rotary Drill Sites Located to Southeast of the Main Pit**



Photograph was taken during the 2005 Micon site visit.

Mining ended and the operation entered into a leach-only mode in November, 2000. In May, 2002, the last gold pour was conducted, the plant was mothballed, and clean-up activities at the mine site began. See Figure 6.2 for a photographic overview of the San Francisco pit and leach pad taken from a hill to the southwest of the mine site prior to the current phase of production. Much of the foreground now is within the limits of the pit.

In 2001, to settle debts related to lease arrangements of construction equipment to Geomaque de Mexico, Butler Machinery Co. (Butler) accepted a payment of USD 500,000, the proceeds in excess of USD 500,000 on the sale of certain equipment from the San Francisco mine and a 1% net smelter return (NSR) royalty on any future gold production from the unmined resources in the main pit of the San Francisco mine. No present value was ascribed to the rights at the time of the agreement. Micon was advised by Alio that the agreement between Geomaque and Butler had ended and that it has received an opinion that the property was transferred to Molimentales free of any royalties. It was the opinion of Alio's solicitors that Alio had free and clear title to the equipment on the property and no obligations to pay any NSR royalties.

**Figure 6.2**  
**View of the San Francisco Gold Mine with Estación Llano in the Background**

(Looking Northeast)



Photograph was taken during the 2005 Micon site visit.

Geomaque signed a Surface Rights Agreement with a group of rights holders (the Ejido Jesus Garcia Heroe De Nacozari (Ejido Jesus Garcia)). Based on a letter agreement dated July 7, 1999, the Ejido Jesus Garcia agreed to transfer to the company a surface area of 800 ha, for a total consideration of USD 1,000,000, of which USD 75,000 was due and payable on signing of the agreement. The letter agreement and its efficacy were the subject of litigation between Geomaque and the Ejido Jesus Garcia, whereby the company sought to have the agreement declared void, its deposit returned and other remedies, and the Ejido Jesus Garcia sought to have the agreement held effective and sought, inter alia, the payment of the balance of the purchase price and other relief.

In the summer of 2003, Geomaque sought and received shareholder approval to amalgamate the corporation under a new Canadian company, Defiance Mining Corporation (Defiance).

On November 24, 2003, Defiance sold its Mexican subsidiaries, Geomaque de Mexico and Mina San Francisco, to the Astiazaran family and their private Mexican company for a total consideration of USD 235,000. The Mexican subsidiaries held the San Francisco gold mine and the sale relieved Defiance of long-term liabilities totalling USD 1,900,000, including a USD 925,000 surface rights purchase obligation, approximately USD 760,000 in reclamation provisions and other payables totalling USD 263,000. The litigation of the surface rights



between the Ejido Jesus Garcia and Geomaque de Mexico was settled in favour of Geomaque de Mexico on January 20, 2005. Geomaque de Mexico was granted by the DGM the temporary occupation of surface rights at the San Francisco mine for the duration of the exploitation concessions.

Since June, 2006, the Astiazaran family and their company, Desarrollos Prodesa S.A. de C.V. (Prodesa) have retained ownership of the waste dumps and the original leach pads, and have been extracting sand and gravel intermittently for use in highway construction and other construction projects. Figure 6.3 is a view of gravel extraction from the original leach pads at the San Francisco mine site in 2005. The reprocessing and extraction of sand and gravel material has continued from the original leach pads and was ongoing during the 2013, 2016 and 2017 site visits.

**Figure 6.3**  
**Extraction of Gravel from the Original Leach Pads for Construction Use**



Photograph taken during the 2005 Micon site visit.

### **6.1.2 Alio Incorporation and Ownership of the San Francisco Project**

Alio was incorporated as Timmins Gold Corp. on March 17, 2005 under the Business Corporations Act of British Columbia. Alio originally acquired the exploitation concessions

covering the San Francisco Project through its wholly-owned Mexican subsidiary, via an option agreement with Geomaque de Mexico on April 18, 2005. That option agreement was subsequently superseded by an acquisition agreement. Initially, Alio had the option to earn a 50% interest in the exploitation concessions by spending USD 2,500,000 on exploration and development over a two-year period and, after Alio had earned its interest, the property would be operated as a joint venture, with Alio as the operator.

In a press release dated March 19, 2007, Alio announced that it had entered into an agreement to acquire a 100% interest in Molimentales, a company specifically formed to own 100% of the past producing San Francisco mine. On October 29, 2007, Alio announced that it had paid the full and final USD 2.5 million to complete the acquisition of the San Francisco mine.

In April, 2010, Alio announced that the San Francisco mine had entered back into production.

On March 23, 2011, Alio announced that its common shares were, as of that date, listed for trading on the Toronto Stock Exchange (TSX) and delisted from the TSX Venture Exchange (TSX-V).

On November 1, 2011, Alio announced that its common shares would be listed for trading on the NYSE Amex under the ticker symbol TGD as of November 4, 2011. It also noted that the shares would continue to trade on TSX.

On May 12, 2017, Alio announced that its shareholders had approved its name change from Timmins Gold Corp. to Alio Gold Inc.

### **6.1.3 Magna Ownership of the San Francisco Project**

On March 6, 2020, Magna announced that it has entered into a definitive purchase agreement with Timmins GoldCorp Mexico S.A. de C.V. (Timmins), a wholly-owned subsidiary of Alio, to acquire the San Francisco mine. On May 6, 2020, Magna announced that it has closed the acquisition of the San Francisco mine.

## **6.2 HISTORICAL RESOURCE AND RESERVE ESTIMATES**

### **6.2.1 Pre-2005 Historical Mineral Resource Estimates**

When Alio acquired the San Francisco mine, it contained a historical 2001 mineral resource estimate completed by Geomaque prior to closing the mine for economic reasons. There was no Technical Report in relation to this resource estimate. It was based upon the lateral and depth extensions of the mineralization previously mined from the San Francisco pit and was derived from a number of drill holes which intersected this mineralization.

Alio used this mineral resource as the basis of its acquisition of the Project and then proceeded to conduct a program of compilation work and further exploration to verify the mineralization

as outlined by Geomaque. The exploration and verification work allowed Alio to conduct an updated resource estimate that superseded 2001 Geomaque estimate.

### **6.2.2 2018 Historical Mineral Resource and Reserve Estimates**

In a news release dated August 10, 2018, Alio reported the Mineral Reserves and Mineral Resources as of July 1, 2018 for the San Francisco mine. The following information regarding the 2018 mineral resources and reserves has been extracted from the press release as follows:

*“The Mineral Reserve estimates at San Francisco from April 1, 2017 was updated as of July 1, 2018 utilizing the latest available information, including mining depletion over the period and in-fill and grade-control drilling carried out as part of the mining operations during the period. Mining depletion of Mineral Reserves was partly offset by expansion of the reserves in Phases 6 through 9 of the San Francisco Pit. Total proven and probable mineral reserves totaled 854,472 ounces of gold (55.5 million tonnes at 0.49 g/t) as of July 1, 2018, an approximate decrease of 74,228 ounces of gold or 8% from April 1, 2017.”*

Table 6.1 summarizes the mineral resources and reserves from the August 10, 2018, Alio Press Release. Resources were estimated at a gold price of USD 1,350 per ounce and were reported inclusive of reserves. Reserves were based on a gold price of USD 1,250 per ounce.

Magna has stated that it considers the July 1, 2018 Alio mineral resources and reserves to be historical. Micon and its QPs also consider that Alio’s 2018 mineral resources and reserves were historical for the purposes of the transaction between Alio and Timmins. At the time of the previous June 1, 2020 Technical Report, Micon and its QPs had not conducted sufficient work to classify the historical Alio estimate as current mineral resources and reserves.

Magna has conducted a new resource and reserve estimation for the San Francisco Project which Micon has reviewed. The new resource and reserve estimates supersede the estimates reported by Alio in its news release dated August 10, 2018. The current 2020 mineral resources and reserves, by Magna, were conducted following the CIM guidelines and best practices and are discussed in Sections 14 and 15 of this Technical Report.

**Table 6.1**  
**San Francisco Project – Historical Reserves and Resources as of July 1, 2018**

Mineral Reserves	Proven			Probable			Proven & Probable		
	Metric Tonnes	Au g/t	Contained Au Ounces	Metric Tonnes	Au g/t	Contained Au Ounces	Metric Tonnes	Au g/t	Contained Au Ounces
San Francisco	17,757,023	0.518	273,741	23,359,785	0.540	405,239	41,116,808	0.514	678,980
La Chicharra Pit	5,328,803	0.522	89,489	1,835,220	0.437	25,804	7,164,023	0.501	115,292
<b>Total</b>	<b>23,085,826</b>	<b>0.489</b>	<b>363,230</b>	<b>25,195,005</b>	<b>0.532</b>	<b>431,043</b>	<b>48,280,831</b>	<b>0.512</b>	<b>794,272</b>
Low-grade stockpile	7,199,000	0.260	60,200				7,199,000	0.260	60,200

Mineral Resources	Measured			Indicated			Measured & Indicated		
	Metric Tonnes	Au g/t	Contained Au Ounces	Metric Tonnes	Au g/t	Contained Au Ounces	Metric Tonnes	Au g/t	Contained Au Ounces
San Francisco	33,041,153	0.547	580,545	38,485,816	0.557	688,856	71,526,969	0.552	1,269,403
La Chicharra Pit	6,674,718	0.550	118,028	6,019,509	0.500	96,766	12,694,227	0.526	214,794
<b>Total</b>	<b>39,715,871</b>	<b>0.547</b>	<b>698,574</b>	<b>44,505,325</b>	<b>0.549</b>	<b>785,621</b>	<b>84,221,196</b>	<b>0.548</b>	<b>1,484,197</b>

Mineral Resources	Inferred		
	Metric Tonnes	Au g/t	Contained Au Ounces
San Francisco	1,725,608	0.528	29,293
La Chicharra Pit	222,238	0.462	3,301
<b>Total</b>	<b>1,947,846</b>	<b>0.520</b>	<b>32,594</b>

Figures may not total due to rounding

In a press release of March 6, 2020, Magna discussed its plans for the San Francisco Project as follows:

***“Operational Improvement Plan”***

*“Following closing of the Acquisition, Magna intends to execute a mine operational improvement plan that will include a full review and update to (i) the mine design and production plan, (ii) metallurgy and processing, (iii) workforce management, and (iv) local and regional exploration. Based on Magna’s review to date, the Company believes it can re-commence mining operations in the near term with the goal of establishing profitable mining operations.”*

*“Magna will provide additional details with respect to the mine operational improvement plan following the closing of the Acquisition. The mine operational improvement plan will be supported by a preliminary economic assessment, pre-feasibility study or feasibility study.”*

**6.3 HISTORICAL PRODUCTION FROM THE SAN FRANCISCO PROJECT**

**6.3.1 Historical Production**

6.3.1.1 Historical Production from 1996 to 2002

Historical production occurred at the San Francisco gold mine between 1996 and 2002. Production was conducted using open pit mining methods, with gold recovered by heap leaching. During this production phase, the San Francisco mine extracted 13,490,184 t at a grade of 1.13 g/t gold for a total of 488,680 contained ounces of gold (Table 6.2). A total of 300,281 oz gold and 96,149 oz of silver were recovered, with the gold recovery estimated to be 61.4%.

**Table 6.2  
San Francisco Project, Geomaque Annual Production 1996 to 2002**

Year	Dry Crush on Pads (t)	Grade (g/t)	Ounces on Pad	Gold/Silver Ounces Doré	Gold Ounces Doré	Gold Recovered (%)
1996	1,735,550	1.32	73,655	46,787	36,127	49.0
1997	2,288,662	1.12	82,412	75,847	54,519	66.2
1998	3,074,902	1.05	103,803	86,940	58,808	56.7
1999	3,010,639	1.14	110,345	98,726	64,371	58.3
2000	3,380,431	1.09	118,465	104,953	69,100	58.3
2001					17,092	
2002					264	
<b>Total</b>	<b>13,490,184</b>	<b>1.13</b>	<b>488,680</b>		<b>300,281</b>	<b>61.4</b>

Note: 301,893 tonnes of mineral and 975,900 tonnes of waste rock were mined in 1995.

Table taken from the 2006 San Francisco Scoping Study by Sol & Adobe Ingenieros Asociados S.A. de C.V.

### 6.3.1.2 Historical Production from April, 2010 to 2019

The San Francisco mine resumed commercial production in April, 2010. Table 6.3 summarizes production from April, 2010 to the end of 2019, by quarter. Ore of lower grade was stockpiled for processing at the end of the mine life. Alio reports that, at the end of March, 2016, a total of 8.121 Mt at an average grade of 0.260 g/t gold had been placed on the low-grade stockpile since 2010, as shown in Table 6.4. As the end of December, 2019, Alio had processed from the stockpiles a total of 7.406 Mt at an average grade of 0.224 g/t gold.

During July, 2011, Alio expanded of the crushing system to 15,000 t/d. In December, 2012, a new crushing circuit was installed to provide an additional capacity of 5,000 t/d. In August, 2013, the second crushing circuit was expanded by 2,000 t/d. The processing rate at the time of the 2017 Micon Technical Report was 22,000 t/d and had been operating at this rate since the 2013 Micon Technical Report was released. During 2019, Alio ceased processing material from the open pits and concentrated on processing material from the stockpiles. When Magna acquired the project in 2020 the operation was on residue leach.

Appendix III includes views of the San Francisco and La Chicharra pits from 2008 to 2020 taken during the site visits as well diagrams showing the yearly growth of both pits up to 2019.

Appendix IV contains extracts from 2017 to 2020 Alio press releases with further details regarding its operations at the San Francisco Project during this period.

**Table 6.3**  
**San Francisco Project, Annual Production from April, 2010 to the End of December, 2019 (by Quarter)**

Year	Quarter	Total Ore Extracted (dry tonnes)	Avg Grade Extracted (g/t Gold)	Total Gold Extracted (oz Au)	ROM extracted (dry tonnes)	Avg Grade ROM Extracted (g/t Gold)	Waste Mined (dry tonnes)	Strip Ratio (w:o)	Processed Ore (dry tonnes)	Avg Processed Grade (g/t Gold)	Gold Placed on Leach Pad (oz Au)	Gold Sold (oz Au)	Days in Quarter	Average Ore Mined (tonnes/day)	Average Ore Processed (tonnes/day)	Total Mined (tonnes/day)
2010	April – June	989,146	0.768	24,427	0	0	4,057,842	4.10	905,296	0.718	20,904	10,375	91	10,870	9,948	55,461
	July – September	1,110,169	0.862	30,756	0	0.000	3,630,021	3.27	1,090,768	0.817	28,667	15,685	92	12,067	11,856	51,524
	October - December	1,271,281	0.947	38,712	0	0.000	4,498,925	3.54	1,208,677	0.939	36,483	20,030	92	13,818	13,138	62,720
2011	January – March	1,624,297	0.721	37,656	0	0.000	4,701,677	2.90	1,207,339	0.895	34,743	17,020	90	18,048	13,415	70,289
	April – June	1,648,231	0.762	40,370	0	0.000	4,239,137	2.57	1,239,075	0.859	34,235	16,676	91	18,112	13,616	64,696
	July – September	2,030,276	0.650	42,429	0	0.000	5,097,292	2.51	1,364,290	0.804	35,282	17,287	92	22,068	14,829	77,474
2012	October - December	2,097,621	0.582	39,282	0	0.000	4,160,488	1.98	1,327,299	0.778	33,195	21,524	92	22,800	14,427	68,023
	January – March	2,092,389	0.593	39,864	0	0.000	3,879,662	1.85	1,255,477	0.772	31,150	21,532	91	22,993	13,796	65,627
	April – June	2,098,087	0.656	44,274	0	0.000	4,342,495	2.07	1,347,112	0.901	39,028	23,203	91	23,056	14,803	70,776
2013	July – September	2,266,504	0.646	47,090	0	0.000	4,210,428	1.86	1,420,414	0.887	40,490	25,154	92	24,636	15,439	70,401
	October - December	1,867,512	0.707	42,439	0	0.000	5,295,383	2.84	1,493,623	0.819	39,339	24,556	92	20,299	16,235	77,858
	January – March	2,113,611	0.712	48,383	0	0.000	6,375,048	3.02	1,787,262	0.825	47,434	28,328	90	23,485	19,858	94,318
2014	April – June	2,233,783	0.702	50,394	0	0.000	6,235,920	2.79	1,848,832	0.814	48,380	28,024	91	24,547	20,317	93,074
	July – September	2,110,667	0.684	46,425	0	0.000	5,441,889	2.58	1,815,709	0.771	45,016	29,139	92	22,942	19,736	82,093
	October – December	2,284,242	0.737	54,118	0	0.000	5,307,526	2.32	2,014,968	0.872	56,504	34,166	92	24,829	21,902	82,519
2015	January – March	2,373,603	0.727	55,477	0	0.000	5,520,468	2.33	2,122,650	0.760	51,838	35,413	90	26,373	23,585	87,712
	April – June	2,461,018	0.625	49,467	0	0.000	5,810,088	2.36	2,184,316	0.650	45,616	32,932	91	27,044	24,003	90,891
	July – September	2,017,523	0.561	36,359	0	0.000	6,208,303	3.08	2,213,740	0.504	35,889	26,675	92	21,930	24,062	89,411
2016	October – December	1,944,436	0.650	40,656	0	0.000	6,417,044	3.30	2,101,873	0.563	38,078	25,007	92	21,135	22,846	90,886
	January – March	2,086,331	0.563	37,779	0	0.000	5,997,897	2.88	2,074,788	0.532	35,469	24,155	90	23,181	23,053	89,825
	April – June	2,118,215	0.565	38,476	0	0.000	7,151,798	3.38	2,252,591	0.527	38,176	22,869	91	23,277	24,754	101,868
2017	July – September	1,962,879	0.548	34,601	0	0.000	7,000,474	3.57	2,200,292	0.510	36,072	23,387	92	21,336	23,916	97,428
	October - December	1,712,867	0.486	26,788	0	0.000	6,857,052	4.00	1,921,060	0.458	28,314	22,787	92	18,618	20,881	93,151
	January – March	1,999,320	0.620	39,840	0	0.000	4,708,661	2.36	2,003,712	0.622	40,038	25,121	91	21,971	22,019	73,714
2018	April – June	1,848,675	0.604	35,892	0	0.000	3,729,153	2.02	1,939,567	0.604	37,640	25,863	91	20,315	21,314	61,295
	July – September	1,745,081	0.604	33,901	0	0.000	3,724,904	2.14	1,791,399	0.610	35,135	24,053	92	18,968	19,472	59,456
	October - December	1,864,407	0.486	29,123	0	0.000	2,365,312	1.27	1,917,965	0.482	29,703	25,287	92	20,265	20,847	45,975
2019	January – March	1,942,117	0.485	30,255	0	0.000	3,241,871	1.67	1,963,307	0.475	29,996	26,048	90	21,579	21,815	57,600
	April – June	1,651,256	0.523	27,779	0	0.000	4,300,791	2.61	1,933,253	0.466	28,958	22,012	91	18,146	21,245	65,407
	July – September	1,645,607	0.468	24,750	0	0.000	5,184,524	3.15	1,916,332	0.400	24,616	19,428	92	17,887	20,830	74,241
2020	October - December	1,709,950	0.533	29,326	53,311	0.193	6,232,422	3.65	1,777,461	0.449	25,632	16,069	92	18,586	19,320	86,330
	January – March	1,725,744	0.481	26,683	1,100,860	0.168	5,810,318	3.37	1,714,564	0.416	22,960	16,860	90	19,175	19,051	83,734
	April – June	1,620,935	0.433	22,574	543,376	0.171	4,038,721	2.49	1,617,158	0.463	24,086	13,534	91	17,812	17,771	62,194
2021	July – September	1,539,587	0.481	23,816	117,788	0.141	1,984,781	1.29	1,602,613	0.481	24,770	10,857	92	16,735	17,420	38,308
	October - December	1,159,962	0.478	17,838	0	0.000	3,618,151	3.12	1,576,781	0.418	21,168	10,136	92	12,608	17,139	51,936
	January – March	0	0.000	0	0	0.000	0	0.00	1,619,443	0.274	14,290	10,876	90	0	17,994	0
2022	April – June	0	0.000	0	0	0.000	0	0.00	1,744,165	0.274	15,349	10,204	91	0	19,167	0
	July – September	0	0.000	0	0	0.000	0	0.00	1,607,925	0.248	12,809	8,167	92	0	17,477	0
	October - December	0	0.000	0	0	0.000	0	0.00	1,183,727	0.228	8,665	7,097	92	0	12,867	0
<b>Total</b>		<b>64,967,330</b>	<b>0.617</b>	<b>1,287,999</b>	<b>1,815,336</b>	<b>0.168</b>	<b>171,376,466</b>	<b>2.64</b>	<b>66,306,823</b>	<b>0.599</b>	<b>1,276,118</b>	<b>817,534</b>	<b>3,562</b>	<b>20,321</b>	<b>18,615</b>	<b>73,927</b>

Table provided by Magna.

**NOTES:**

- Alio's management team decided to process ROM ore by the end of 2017. The record of this ore is not reflected in the above table. Approximately 1.8 Mt were processed in this manner.
- From Q4, 2018 till Q4, 2019, the low-grade ore stockpiled was processed and placed on pads.
- Total Ore Extracted columns take into account the low-grade ore sent to stockpile.
- Total Processed Ore columns include the low-grade ore rehandled and processed. These figures do not reflect the ROM ore extracted and placed over pads.

**Table 6.4**  
**San Francisco Project, Annual Ore Stockpiled and Processed from April, 2010 to the End of December, 2019 (by Quarter)**

Year	Quarter	Low-Grade Stockpile (Dry Tonnes)	Average Grade (g/t Gold)	Gold Oz Stockpiled	Low-Grade Processed (Dry tonnes)	Average Grade (g/t Gold)	Ounces LG Processed (oz Au)
2010	April – June	77,828	0.366	916	0	0.000	0
	July - September	24,324	0.344	269	0	0.000	0
	October - December	48,730	0.320	501	0	0.000	0
2011	January - March	395,254	0.258	3,283	0	0.000	0
	April – June	379,778	0.276	3,371	0	0.000	0
	July - September	671,185	0.276	5,960	0	0.000	0
2012	October - December	812,586	0.274	7,160	0	0.000	0
	January - March	804,585	0.271	7,001	0	0.000	0
	April – June	791,775	0.252	6,414	0	0.000	0
	July - September	842,973	0.229	6,197	0	0.000	0
2013	October - December	526,800	0.265	4,487	0	0.000	0
	January - March	399,784	0.261	3,354	0	0.000	0
	April – June	456,950	0.248	3,645	0	0.000	0
	July – September	445,603	0.255	3,660	0	0.000	0
2014	October - December	349,338	0.253	2,839	0	0.000	0
	January - March	288,021	0.259	2,396	0	0.000	0
	April – June	399,075	0.245	3,140	124,606	0.286	1,147
	July – September	67,598	0.245	533	148,021	0.282	1,344
2015	October - December	158,625	0.225	1,146	260,406	0.291	2,435
	January - March	112,206	0.257	927	0	0.000	0
	April – June	47,446	0.283	432	45,106	0.259	376
	July – September	16,030	0.409	211	20,055	0.259	167
2016	October - December	968	0.328	10	0	0.000	0
	January - March	3,966	0.244	31	0	0.000	0
	April – June	0	0.000	0	0	0.000	0
	July - September	0	0.000	0	0	0.000	0
2017	October - December	0	0.000	0	0	0.000	0
	January - March	0	0.000	0	0	0.000	0
	April – June	0	0.000	0	129,525	0.250	1,041
	July - September	0	0.000	0	130,063	0.250	1,045
2018	October - December	0	0.000	0	13,100	0.250	105
	January - March	0	0.000	0	0	0.000	0
	April – June	0	0.000	0	0	0.000	0
	July - September	0	0.000	0	38,082	0.250	306
2019	October - December	0	0.000	0	341,788	0.242	2,657
	January - March	0	0.000	0	1,619,443	0.218	11,335
	April – June	0	0.000	0	1,744,165	0.217	12,157
	July - September	0	0.000	0	1,607,925	0.214	11,040
<b>Total</b>	October - December	0	0.000	0	1,183,727	0.212	8,073
	<b>Total</b>	<b>8,121,427</b>	<b>0.260</b>	<b>67,883</b>	<b>7,406,012</b>	<b>0.224</b>	<b>53,230</b>

Table provided by Magna.



## 7.0 GEOLOGICAL SETTING AND MINERALIZATION

This section has been extracted from the June 1, 2020, Technical Report completed by Micon for Magna. As there have been no changes since the date of that Technical Report the information is still valid to be used in this report.

### 7.1 REGIONAL GEOLOGY

The following descriptions of the regional geology were extracted from Prenn (1995):

*“The San Francisco property is situated in a belt of metamorphic rocks that hosts numerous gold occurrences along the trace of the Mojave-Sonora megashear, which trends southeast from south-central California into Sonora. The megashear is a left-lateral transform fault which became active during the Jurassic period and exhibits up to 800 km of displacement. Deformation along the megashear occurred along with metamorphism (Calmus et al, 1992) and since the formation of the megashear the area has been subjected to both tectonic compressional and tensional forces.”*

*“The following description is extracted from Silberman (1992). The northwest-trending range-front faults and numerous low-angle shear zones related to thrust or detachment faults are the most common structures. The Mojave-Sonora megashear as defined by Silver and Anderson (1974) is a regional northwest-trending feature. It separates the Precambrian basement rocks of slightly differing ages. The Jurassic rocks which occupy the zone are strongly deformed along low-angle thrust faults and the associated sedimentary rocks are tightly folded. The south-western boundary of the megashear appears to be a major fault that juxtaposes Precambrian basement rocks against the Jurassic magmatic terrane (Anderson and Silver, 1979). Up to 800 km of left lateral movement has been proposed for this shear after the Middle Jurassic period. Others (Jaques et al., 1989) have suggested that the megashear is a Cretaceous thrust front reactivated as a middle Tertiary detachment. The metamorphism in the area has been postulated to have occurred with the megashear or the magmatic activity of the Middle to Late Jurassic periods (Tosdal et al, 1989). However, others propose a close relationship between deformation and the closing of the marginal basin after its subduction below the volcanic arc, or the result of Late Cretaceous or Tertiary compression associated with uplift and low-grade metamorphism (De Jong et al, 1988). Calmus (1992) believes it is unquestionable that a Cretaceous-Tertiary (Larimide) tectonic event occurred but that it is superimposed upon older Nevada and Lower Cretaceous compressional and extensional phases. Many of the Sonoran gold deposits are located at or near the Mojave-Sonora megashear.”*

The Basin and Range province, which extends into Sonora from the United States, is characterized by northwest-trending valleys and ranges. Paleozoic rocks, including quartzite and limestone, overlie the Precambrian locally. The valleys are covered and in-filled by recent gravels. See Figure 7.1 for the regional geology map of the San Francisco mine area and location of the San Francisco and La Chicharra pits.

## 7.2 PROPERTY GEOLOGY

The San Francisco property lies in a portion of the Mojave-Sonora megashear belt characterized by the presence of Precambrian to Tertiary age rocks represented by different grades of deformation and metamorphism as evidenced in the field by imbricate tectonic laminates. The rocks principally involved in the process of deformation and associated with the gold mineralization in the region are of Precambrian, Jurassic and Cretaceous age.

The oldest rocks within the property are a package of metamorphic rocks which include banded quartz-feldspathic gneiss and augen gneiss, green schist, amphibolite gneiss and some amphibolite and marble lenses (Calmus et al., 1992). All metamorphic rocks exhibit foliation which generally varies in strike direction from between 30° to 72° west and dips to the northeast from 24° to 68°. See Figure 7.2 for a geological map of the San Francisco and La Chicharra mine site.

The metamorphic rocks are intruded by a Tertiary igneous package, which includes leucocratic granite with visible feldspar and quartz, and is porphyritic to gneissic in texture. It appears that the granite was emplaced along low angle northwest-southeast shear zones in the system which developed between an older gabbro and the metamorphic sequence. This is the reason that in some places the granite bodies appear as stratiform lenses that vary in width from centimetres to more than 40 m and are subparallel to the foliation. It is seen, however, that the emplacement of leucocratic granite also favours the N30°W fault system, causing the granite to take an elongated form, principally in direction N60°W, but with extensions along the N30°W system.

Besides the gabbro and the granite, dikes of different composition, including diorite, andesite, monzonite and lamprophyre, intrude the metamorphic sequence. In addition, lenses of pegmatite associated with the schist have been mapped, emplaced along the foliation planes, occasionally forming lenses within the gabbro and within the gneiss and on the border of the leucocratic granite bodies. All of the rocks described above form the San Francisco unit which is the most important unit for exploration, with the leucocratic granite being especially significant because it is the primary host rock for gold mineralization.

Mapping of isolated outcrops and their geological interpretation demonstrates that the San Francisco unit is extensive within the property, covering a surface area of approximately 100 km<sup>2</sup>. The unit hosts at least 15 gold occurrences which are considered to be favourable exploration targets, in addition to the known San Francisco and La Chicharra gold deposits

**Figure 7.1**  
**Geology of the San Francisco Property**

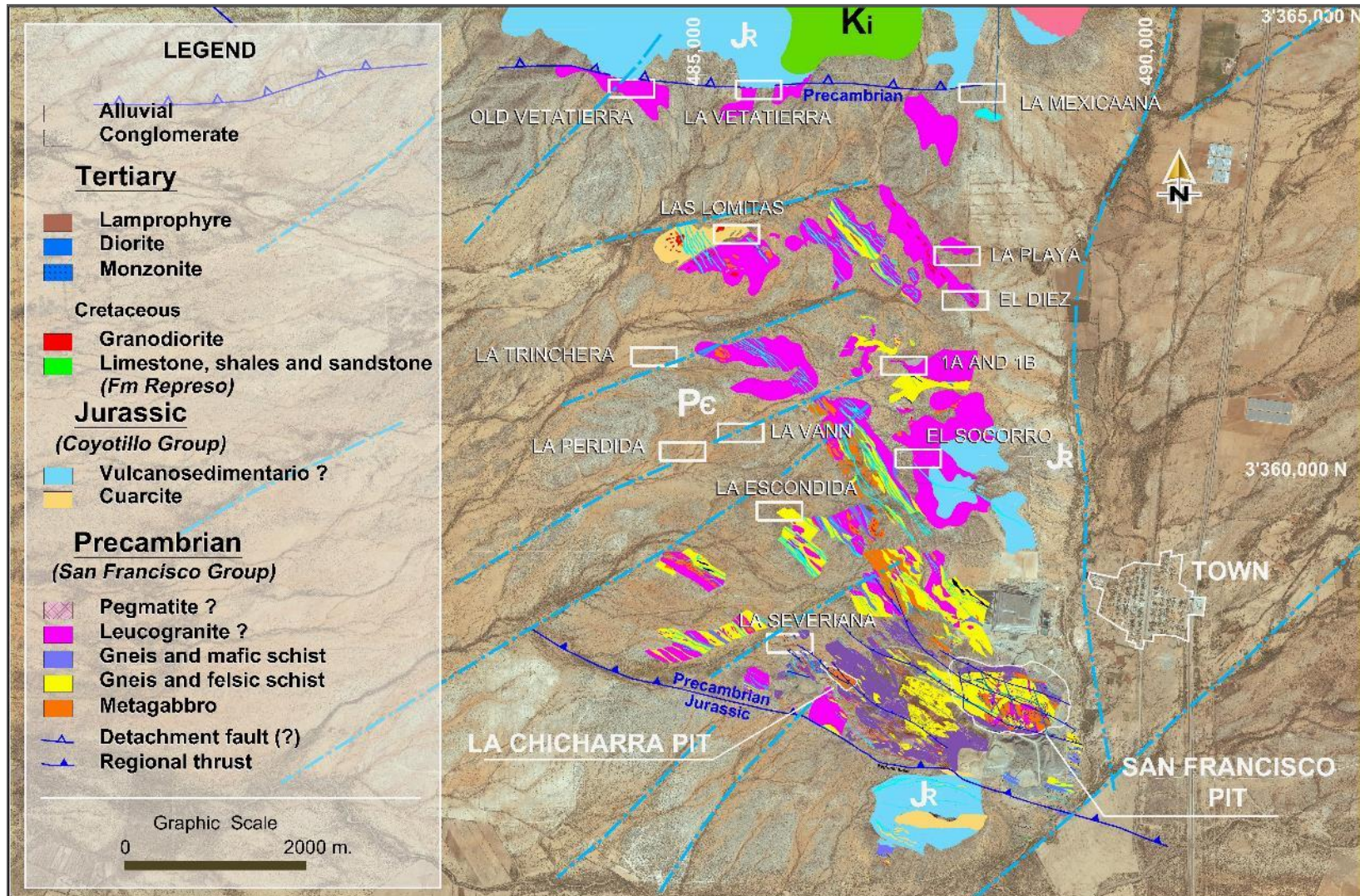


Figure provided by Alio Gold Inc. Figure dated May, 2017.

**Figure 7.2**  
**San Francisco and La Chicharra Minesite Geology Map**

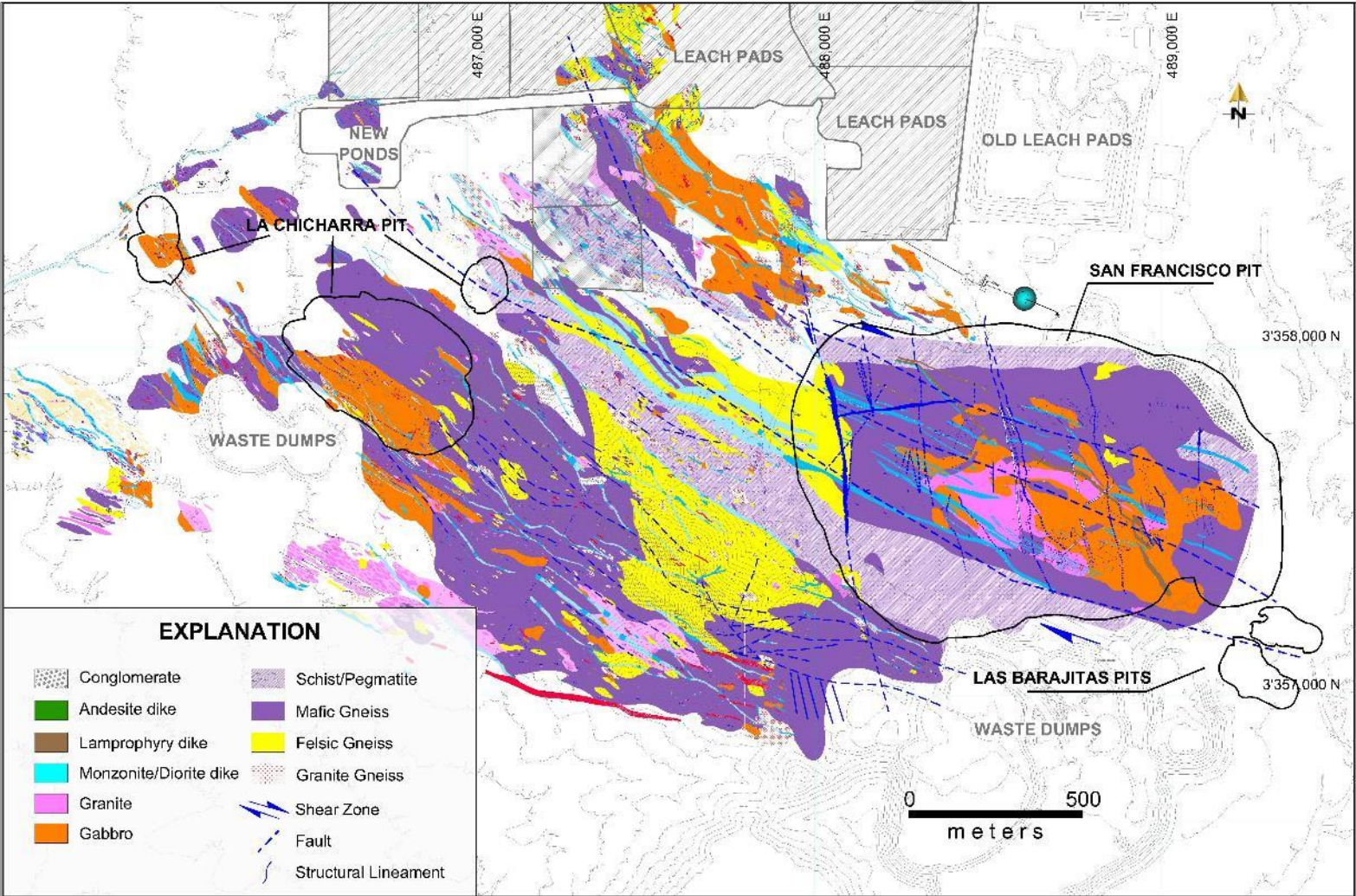


Figure provided by Alio Gold Inc. Figure dated May, 2017.

In the north and south, the San Francisco unit is in contact with the Coyotillo unit which is a weakly metamorphosed package of sandstone, quartzite, phyllite, conglomerate, volcanics and limestones of Jurassic age.

The granitic gneiss containing the mineralization at the San Francisco Project is intensely fractured with a total of five fracture sets having been identified, although there are only two primary sets. One of the primary sets strikes  $36^{\circ}$  to  $60^{\circ}$  east and dips northwest  $70^{\circ}$  to  $90^{\circ}$ , while the other strikes  $64^{\circ}$  to  $73^{\circ}$  west and dips northeast  $46^{\circ}$  to  $66^{\circ}$ . The regional fracture sets are generally parallel to major faults and perpendicular to foliation planes.

The main vein systems in the region strike  $50^{\circ}$  to  $80^{\circ}$  west with dips ranging from northeast to southwest. These vein systems are the San Francisco, La Playa, El Diez, La Chicharra, and several systems in the La Mexicana area, Area 1B and La Escondida. A secondary system of veins includes the La Trinchera, Casa de Piedra, unnamed veins in portions of Area 1B and the La Mexicana veins which strike  $60^{\circ}$  to  $80^{\circ}$  east and dip northwest to southeast. Although the age relation between the two systems is unknown, it is believed that the northeast system is probably later stage.

The metamorphic foliation in the San Francisco deposit primarily strikes  $78^{\circ}$  west and dips to the northeast at  $68^{\circ}$ . Regionally the foliation is variable, generally ranging from east-west to  $60^{\circ}$  west with varying dips to the northeast.

The original bedding is recognized in the metavolcanic-sedimentary rocks to the south at Cerro La Bajarita, and is variable with strikes ranging from  $70^{\circ}$  to  $80^{\circ}$  west and dips to the north. The sedimentary beds of the Represo Formation in the northern portion of the property strike  $60^{\circ}$  to  $70^{\circ}$  west and dip to the northeast.

Dikes of intermediate composition in the Project area strike predominantly  $63^{\circ}$  west and dip to the northeast at  $58^{\circ}$ . Several dikes are intruded along planes of foliation, and others cut foliation of the metamorphic units. In the Sierra La Vetatierra mountains in the northern portion of the Project, dikes strike  $60^{\circ}$  to the east, dip to the northwest, and represent a later system of fractures.

Metamorphic folds, including isoclinal, open symmetrical and kink folds, have been described, but no systematic description of folds has been found in the literature.

### **7.2.1 Geology of the La Chicharra Pit**

The La Chicharra pit is located 2 km west of the San Francisco pit. Discovered by Geomaque in the late 1990's, it is estimated that approximately 37,000 oz of gold were extracted and processed during Geomaque's last year of operations.

The discovery of this deposit was the consequence of exploration programs comprised of magnetic ground surveys and soil geochemistry, using both conventional soil sampling and mobile metal ion (MMI) techniques. In both cases, samples returned very high values for the

main mineralized zone in an area of low magnetics. Trenches were excavated to conduct chip sampling which confirmed the presence of gold mineralization in the bedrock and drilling delineated a deposit with a resource of 60,000 to 70,000 oz of gold.

The geology of the La Chicharra deposit, although it is hosted in the San Francisco group, differs from the geology found in the San Francisco pit (Figure 7.2). While the geology consists of quartz-feldspar gneiss, pegmatite, schist, granite and gabbro, the mineralization is hosted principally in gabbro. The gabbro has a very sheared appearance, almost like a breccia, comprised of large fragments with lenses of pegmatite between the fragments. Due to the shearing process, the blocks of gabbro are highly fractured and the fractures are filled with quartz veins and veinlets. The gold mineralization is hosted by the pegmatite lenses and in the veins and veinlets within the gabbro. The limits of the mineralized gabbro are very well delineated by the shear zones, at both the hanging wall and footwall. This geological control allowed for better operational planning during the exploitation by Geomaque.

The gabbro at La Chicharra is different from the gabbro bodies at the San Francisco mine, as it contains no magnetic minerals which are generally produced by the destruction of the original minerals contained within the gabbro during the tectonic and mineralization processes. As well, due to strong shearing, the minerals are oxidized. The gabbro is a tabular body dipping to the northeast at approximately 30 to 40° and striking approximately 60° west, with the mineralization potentially open both along strike and down dip.

Alio completed a program of core drilling seeking the extension of mineralization down dip and along strike, and confirming continuity for the first 150 m from the northern limit of the pit, with the mineralization open in the northwest direction towards La Severiana.

Structurally, all of the metamorphic and igneous interpretation is based on the High Resolution Airborne Magnetics which indicate a regional lineament varying in direction from 60° to 30° to the west. The gold deposits are located in the southern portion on each side of this main lineament, and are related to the extension faulting of the system west-northwest and west-east. Other grassroots gold targets are located along this lineament, related to quartz veins with gold mineralization emplaced along the shear zones of the system to the west-northwest and east-west.

Figure 7.3 is a view of the La Chicharra pit looking towards the southwest and showing the lineament.

### **7.3 MINERALIZATION**

The San Francisco property is located within the Sierra Madre Occidental metallogenic province which extends along western Mexico from the state of Sonora, south to the state of Jalisco. In the state of Sonora, the most important metal produced in the Sierra Madre province is copper, with the Cananea porphyry copper deposit being the most well-known. Gold and silver projects are next in importance and are hosted mainly in sedimentary rocks and brecciated volcanic domes.

**Figure 7.3**  
**La Chicharra Pit Looking Southeast showing the Lineament**  
**(Pit in 2005)**



Figure provided by Alio Gold Inc.

At the San Francisco Project, gold occurs principally as free gold and occasionally as electrum. Gold is found, in decreasing abundance, with goethite after pyrite, with pyrite and, to a much lesser extent, with quartz, galena and petzite ( $\text{Ag}_3\text{AuTe}_2$ ). Although it is clear that the gold was deposited at the same time as the sulphides, the paragenetic relationships are not well understood. There is the possibility that some secondary remobilization may have occurred as evidenced by minor amounts of gold occurring in irregular forms along with or on top of drusy quartz (Prenn, 1995).

The gold occurs in a granitic gneiss and the presence of pyrite (or goethite after pyrite) may be an indication of gold. Stockwork quartz veinlets, some with tourmaline, also exist in the mineralized zone. However, the presence of quartz, even with tourmaline, is not necessarily an indication of the presence of gold. Quartz veinlets with tourmaline but without gold mineralization were found hundreds of metres away from the San Francisco deposit. Alvarez (in Prenn, 1995) suggested that some tourmaline was part of the mineralizing system, but could be distinguished from the tourmaline found elsewhere.

The relationship between the quartz and tourmaline at the Project is not well understood, though at least one event is closely related to the gold mineralization. Calmus (1992) and Perez (1992) described the gold as being in quartz, acicular tourmaline, and albite veins and breccias. It was noted (Perez, 1992) that two types of tourmaline exist: schorl and dravite, but these are difficult to distinguish. There is some suggestion that a more greenish tourmaline is associated with the San Francisco zone while the black tourmaline (schorl) is generally barren of gold. If this can be verified, it could become a valuable exploration tool for the region. Horner (in Prenn, 1995) also noted the possibility of two or more types of tourmaline in the cobbles sampled in the stream beds. Horner believes that only one set of the tourmaline veins is associated with the gold and suggests that bismuth is also associated with one tourmaline quartz vein event.

Other metallic minerals associated with the deposit include trace to small amounts of chalcopyrite, galena, sphalerite, covelite, bornite, argentite-acanthite and pyrrhotite. Trace amounts of molybdenite and wulfenite have also been reported. Metal mineralization is low, with copper reaching into the hundreds of ppm, arsenic reaching about 100 ppm, and antimony rarely over 10 ppm. Petzite was recognized but tellurium values rarely reached 10 ppm. The mineral relationships, the possibility of associated tourmaline, and the style of mineralization suggest that the San Francisco deposit might be of mesothermal origin (see Prens, 1995 for discussion). Others have suggested the same genesis based on these and other factors, including fluid inclusion studies (in Prens, 1995).

The San Francisco deposits are roughly tabular with multiple phases of gold mineralization. The deposits strike 60° west to 65° west, dip to the northeast, range in thickness from 4 to 50 m, extend over 1,500 m along strike and are open ended. The San Francisco deposits consisted of the El Manto, the San Francisco, the En Medio and the El Polvorin deposits. All of these deposits were later incorporated into the main San Francisco pit. The El Manto deposit (north pit), to the north of the San Francisco (main pit), is tabular, strikes 65° west, dips relatively shallowly to the northeast, and ranges in thickness from 5 to 35 m. The En Medio (in the main pit north of San Francisco) strikes 60° west, dips to the northeast and varies in thickness from 4 to 20 m. The El Polvorin (west pit) is a northwest extension of the San Francisco mineralization which strikes 65° west, dips moderately to the northeast and ranges in thickness from 4 to 20 m.

Alteration related to the mineralization consists of negligible to locally intense sericitization, coarse-grained pyritization and rare local silicification. This alteration forms a halo extending a few metres from the mineral deposits, but may also be absent. Supergene alteration consisting of oxidation of pyrite to goethite is common. Additionally, there is supergene alteration of feldspar to kaolin and sericite.

Analysis by Geomaque of 110 samples in seven mineralized zones showed a silver/gold ratio of less than 1 to 10, with very low values of zinc, copper, molybdenum, bismuth, antimony and mercury. Lead is occasionally high, but not above 1%, while gold shows a good correlation locally with arsenic and lead. However, none of the other elements is a good indicator for gold.

## **7.4 OTHER PROJECTS WITHIN THE SAN FRANCISCO PROPERTY**

### **7.4.1 El Durazno Project**

El Durazno is located approximately 12 km north of San Francisco mine. The geology is dominated by the El Claro granitoid intrusion and sediments of the El Represo Formation. The El Claro intrusion is large mass of medium to fine biotite granodiorite intruded by series of monzonite, biotite granite, andesites, diorite and lamprophyre dikes trending northwest. The large mass of biotite granodiorite was dated by Poulsen et. al., (2008) using U-Pb in zircon giving an age of  $66.0 \pm 2.0$  Ma.



The biotite granodiorite is cross-cut by multiple major high angle platy foliate structures trending to the northwest which contain quartz-tourmaline with minor sulphides and gold mineralization. The intrusive-hosted foliate structures can vary in thickness from a quarter metre to several metres. The structures are preferentially altered and mineralized, carrying sericite (greisen), pyrite, quartz and tourmaline. Where the structures are located, it is common to find signs of past prospecting, and they are geochemically anomalous in gold, silver, lead, tellurium, molybdenum and bismuth.

The main structural feature is the El Durazno fault which lies at the contact between the sedimentary rocks and biotite granodiorite. The foliated N60°W shear zones are more likely evidence of faulting along the east margin of the intrusive, although foliated shear zones have been found all around the intrusion in lesser abundance.

Mineralized areas usually occur as quartz veins relatively near the contacts of the El Claro intrusive and more often within the intrusive. The mineralogy of the veins is primarily quartz-tourmaline with a low sulphur content of less than 0.5%. Closer to the contact with the sediments, a number of quartz-sericite (greisen) veins in the more central parts of the intrusive have been identified. Structurally there are four groups of veins and veinlets within the granitoid El Claro:

1. One group of veins belongs to the thicker quartz-tourmaline veins in the area which occasionally reach widths greater than 1 metre, have a general N55°W trend and dip to the northeast similar to the monzonitic, diorite, lamprophyre and andesitic dikes. These veins are associated with ductile shear zones. The mineral lineation observed in the granite foliation plane has a strike of N50°W and the tourmaline crystals strike N52°W, indicating that emplacement of this first generation of veins is contemporary with the ductile deformation.
2. The second group of veins have thicknesses of less than half a metre, with a general strike of N40° to 50°E, and are also located in areas with ductile shear zones occurring mainly at the area known as El Pinto.
3. The third group of veins apparently are emplaced in a ductile-brittle deformation environment, developing sheeted veins with thicknesses less than one centimetre within the intrusive. The general trend of the sheeted veins is N15° to 25°W.
4. The fourth, poorly represented group of veins strike N65° to 80°E, are located primarily in the central part of the El Claro intrusive and are characterized by quartz-sericite (greisen)-pyrite, with a general trend of N60°W. This last type of veins is very poor in gold with local values up to 0.1 g/t Au, but with high anomalous values of tungsten and molybdenum.

The contact between the granite and Cretaceous sediments is characterized by the development of an alteration zone of quartz-epidote-chlorite-garnet skarn and locally forms low-grade metamorphism of the hornfels type. Although quartz-gold-bearing veins are not very common in sediments, they occur locally in conjunction with a high content of sulphides.

#### 7.4.2 Vetatierra Project

The Vetatierra Project is located approximately 8 km north of the San Francisco mine. It is a very early stage exploration project and its geology is dominated by detrital sediments of the El Represo Formation, intruded by small stocks of fine grained dioritic intrusions and diorite dikes. A sequence of fine grained sandstones, shales, medium bedded conglomerates and locally lenticular limestones commonly trend east-west and dip to the north. These represent the majority of the rock types at the Vetatierra Project. This sequence is intruded by a diorite stock that covers an area of 600 m by 200 m, oriented to the northeast. Both sequences are cut by a series of dioritic dikes oriented NE 50° to 80° in strike direction. Locally, the contacts between the sediments and diorite intrusion develop an alteration halo, forming low-grade metamorphic rocks as hornfels or slate types.

The sediments are cut by multiple, major high angle platy foliated structures, with a preferential northeast trend, at the southwestern portion of the project. The sediments host foliated structures that vary in thickness from a quarter metre to several metres which have been interpreted as shear zones. Low-angle brecciated faults have been interpreted to be located on the south side of this area. This has been interpreted as a possible structural contact between the San Francisco Precambrian rocks and the Cretaceous sediments of the Represo Formation.

The sequence of sediments and diorite stock has been cut by a number of quartz-tourmaline and quartz veins trending east-northeast, which occur within the diorite stock and all the surrounding areas. At least 3 groups of veins have been noted:

1. A group of low angle quartz-tourmaline veins trending west-northwest to east northeast, dipping to the north and varying in thickness from a centimetre to over a metre.
2. A group of high angle quartz-tourmaline veins and veinlets, trending northwest and dipping to north.
3. A group of veinlets with less than 1 cm thickness and trending northwest, but dipping to the south.

The diorite intrusion appears to be the most favourable rock to host the gold bearing quartz-tourmaline veins in the Project area, due the better reactivity and competency of the rock.

West of the diorite stock, a series of conglomerate lenses outcrop which show a strong silicification and oxidation, with local quartz veinlets. The conglomerate covers an area of 300 m by 150 m.

## 8.0 DEPOSIT TYPES

This section has been extracted from the June 1, 2020, Technical Report completed by Micon for Magna. As there have been no changes since the date of that Technical Report the information is still valid to be used in this report.

### 8.1 SAN FRANCISCO MINERAL DEPOSIT

At the San Francisco Project, Alio was targeting large volume, low-grade disseminated gold deposits contained within leucocratic granite, granite-gneiss and gneiss and schist horizons. Leucocratic granite and gneiss are the main rocks hosting the gold mineralization.

The gold mineralization occurs in a series of west-northwest to east-northeast trending quartz-tourmaline veins and veinlets that lie sub-parallel to the local lithology and foliation trends, dipping to the southwest, within the more brittle rocks such as the leucocratic granite and more felsic lithologies within the Precambrian sequence. Extensive studies of the veins and alteration describe the mineralization as mesothermal/orogenic in style, but with a potential link to magmatic fluids and an intrusive source (Calmus et al., 1992; Luna and Gastelum, 1992; Perez Segura, 1992; Perezsegura et al., 1996; Perez Segura, 2008; Albinson, 1997; Poulsen and Mortensen, 2008).

Micon has conducted a number of discussions with Alio personnel during its prior site visits to the mine and in Hermosillo and notes that the exploration programs at the San Francisco Project were planned and executed on the basis of the deposit models discussed above. Micon has also observed the various stages of the drilling programs during a number of site visits at the San Francisco Project since 2005 and notes that those programs were always been conducted according to the deposit model which has been proposed for the Project.

Magna will continue to target the same or similar mineralization at the San Francisco Project that Alio did.

## 9.0 EXPLORATION

This section has been extracted from the June 1, 2020, Technical Report completed by Micon for Magna and updated where applicable.

### 9.1 SUMMARY OF PRIOR EXPLORATION BY ALIO

In 2007 and early 2008, geochemical surveys were conducted over the area occupied by the package of igneous and metamorphic rocks within the concessions. A total of 222 chip samples and 2,697 soil samples were collected. The sampling covered an area of just over 60 km<sup>2</sup> using a sampling grid of 100 m x 50 m, oriented 25° E. Most of the area is covered by alluvium and the presence of the igneous-metamorphic package has been interpreted and defined from isolated outcrops distributed in the area (80 km<sup>2</sup>).

The results confirmed the targets already identified from historical shallow underground workings developed by former owners along quartz veins containing high gold values. Extending sampling along the dominant structural trend allowed for new interpretations to identify possible conduits which could be feeder zones. The area covering the favourable lithologic unit between the San Francisco and La Chicharra pits was broadly sampled to identify further potential targets.

During May, 2007, Alio contracted the Mexican Geological Service to survey 1,227 km of high resolution aeromagnetic lineaments and radiometry and acquired raw data for a further 1,569 km previously surveyed by the same institution which fully covered the surface of the property, over 40,000 ha. The resolution of the data varies due to the flight height, which ranged between 75 and 100 m, with the lines spaced every 100 m. Information sets were given to Engineering Zonge in Tucson for processing and interpretation.

The conclusion of this study was the definition of the indicative structural lineaments of the tectonic sequence in northern Sonora. For the San Francisco Project, these lineaments should be correlated with geological and geochemical controls, combined with geological mapping and geochemistry, to identify the best exploration targets for gold and other types of mineralization, particularly in the northern portion of property where the metamorphic package hosts the El Durazno and La Pima mineral areas which are favourable for silver deposits and base metals in a replacement environment within the limestone rocks.

With a view to a more detailed interpretation as mentioned by Zonge in its conclusions, a Natural Source Audio-Frequency Magnetotelluric (NSAMT) survey was completed on the San Francisco mine along the lines 200E, 0, 800W, 1,000W, 1,200W, 1,400W, 1,600W and on the La Chicharra pit along the lines 2,500W and 2,700W. A total of 19.2 km of coverage in 10 survey lines with dipoles of 25 m was completed. Two lines were 2,400 m long and the remainder were 1,800 m.

Lines 800W and 1,000W oriented along the main mineralized zone in the San Francisco pit and line 2,700W on the main mineralized zone of La Chicharra were conducted with the aim of obtaining a geophysical signature for the mineral deposits of San Francisco.

The ten NSAMT lines completed on the San Francisco Project provide a detailed image of resistivity changes relating to geology in the vicinity of the San Francisco open pit mine. As this area is centred on a shear zone associated with a thrust fault, the geology is complex. Intrusive rocks are present as pegmatites, granites and gabbros. Gneiss and schist, with what is assumed to be various degrees of alteration, are also present in this zone. Rock property measurements indicate that the resistivities differ between rock types, ranging from intrusive to a metamorphosed host.

In the shear zone, gold is associated to some degree with granite, gneiss and gabbro rocks. Both the La Chicharra and the San Francisco pits are located in zones with conductive contacts, however, in contrast, these locations are associated with moderately resistive areas. This difference indicates that, while surface resistivities are high, there is differentiation between resistive rocks (intrusive) and more conductive rocks (pegmatite or altered rock) at moderate depth.

Individual 2-D vertical imaged sections suggest that resistive and conductive banding, identified in the vicinity of the San Francisco mine, dips to the northeast. Recent drilling indicates that gold values are typically associated with pyrite in the more resistive intrusive rocks. Except possibly along contacts, conductive geology (possibly altered host rock) may not be important. The resistive trend coincident with the San Francisco peak may be due to the presence of gold in this area, but is not the focus of this Project. The shear zone associated with the thrust fault defines the area hosting gold.

The magnetic and radiometric data provide a different view of the geology. Magnetic high values are associated with the San Francisco pit. The contact between magnetic highs and magnetic lows appears to match the resistive trends identified previously. In contrast to the San Francisco pit, the La Chicharra pit is located in a zone of magnetic lows. The difference here could simply be due to the intrusive rock hosting primary gold values in each pit. For example, the rock properties demonstrate that the gabbro (at 550 uCGS) has over 100 times the magnetic susceptibility of granite (at 3 uCGS). However, drilling results along Line 800 suggest that both rock types may host gold. Based on these observations, it would be expected that the granite would be the primary source of gold in the San Francisco pit, with gabbro at the La Chicharra pit. Gneiss may host gold at either site.

Radiometric data identify trends that match changes in the Total Magnetic Field plan view map, as well as resistive-conductive trends. Radiometric gamma radiation is strongly controlled by conditions at the surface, as radiation from deeper sources is absorbed by overlying geology. The thorium gamma count appears to identify patterns of surface weathering that may relate to outcropping structures. Magnetic and radiometric data in the vicinity of the La Chicharra and San Francisco pits may be controlled by the thrust fault passing through this zone (the 2-D NSAMT imaged sections for Lines 800, 1,400 and 1,600 identify

similar contacts associated with this thrust fault, which dip to the northeast). While the San Francisco peak is centred between NSAMT Lines 1,400 and 1,600, the peak itself appears non-magnetic, with the peak and associated ridge, extending to the northwest, defining a boundary between non-magnetic rock (granite or pegmatite for example) to the southwest and more magnetic rock (gabbro and gneiss for example) to the northeast.

The San Francisco pit is clearly located within the magnetic high zone, positioned along a linear contact seen in the radiometric data. In contrast, the La Chicharra pit is located in a non-magnetic zone also positioned along a linear contact observed in the radiometric data. Both pit locations are within the area thought to be the shear zone, and locally in areas characterized by contacts between intrusive (more resistive) and possibly altered (more conductive) rock types. The NSAMT program successfully identified the shear zone and provided sub-surface imaging of geologic trends that have been identified by airborne magnetic and radiometric surveys, in the test area.

Alio has concluded that the interpretation of NSAMT is a useful indicator of the different lithologies associated with the mineralization or host rock. The linking of areas of high resistivity at the gabbro basement, together with the overlying metamorphic sequence that was affected by several phases of tectonism, resulted in large shear zones and/or thrusting of the Precambrian metamorphic rocks over younger rocks, without generating areas of weakness. This resulted principally in high and low angle faulting through which granite bodies have been emplaced, some of which were subjected to compression and tension and consequent fracturing.

At the end of 2008, the services of a structural geologist, Mr. Tony Starling Ph.D., were recruited to obtain a greater understanding of the structural evolution of the region and in particular the tectonic complex in the San Francisco mine area, and thereby to define the structural controls for the mineralization. The goal of the study was to generate a series of geological and structural criteria that could be applied to the exploration of the property. The work consisted of 10 field days and a further 10 days for the review of existing information and discussions with field geologists. The conclusions from this structural report have assisted Alio in outlining subsequent exploration programs.

## **9.2 2013 TO 2015 EXPLORATION PROGRAMS (SAN FRANCISCO AND LA CHICHARRA DEPOSITS)**

From July, 2013 to December, 2015, very little exploration was conducted around the San Francisco and La Chicharra deposits. This is primarily because Alio focused most of its exploration efforts on fully exploring the area immediately surrounding the pits prior to the publication of the 2013 Technical Report.

Table 9.1 summarizes the mine expenditures for the exploration programs at the San Francisco Project from July, 2013 to December, 2015.

**Table 9.1**  
**Summary of the Exploration Expenditures for the Period July, 2013 to December, 2015**

Item	Concept	2013	2014	2015	Total
1	Salaries and consulting fees	831,109	2,025,395	1,250,788	4,107,292
2	Drilling	-	2,666,148	768,440	3,434,588
3	Surface rights	-	-	550,603	550,603
4	Mining taxes	39	870,650	887,930	1,758,619
5	Acquisition cost	-	-	-	-
6	Assaying	13,137	874,054	98,492	985,683
7	Exploration expenses	15,849	432,990	80,769	497,910
8	Camp and accommodation	7,685	18,037	21,878	47,600
9	Claim staking	-	-	-	-
10	Property investigation	-	-	-	-
11	Legal fees	14,186	30,291	18,918	63,395
12	Travel	21,282	43,055	14,265	78,602
13	Telecommunications	-	-	-	-
14	Drafting, reporting, reproduction and maps	-	-	-	-
15	Other	-	1,105	22,378	23,483
16	Office expenses	93,561	189,669	158,134	441,364
17	Engineering and feasibility	-	-	-	-
18	Equipment rental	-	-	-	-
19	Insurance and labor related taxes	-	-	-	-
20	Trenching and road work	-	-	-	-
21	Geophysical surveying	-	-	-	-
22	Promotion	-	-	-	-
24	Land	-	-	-	-
	<b>Total per Year</b>	<b>965,150</b>	<b>7,151,394</b>	<b>3,872,595</b>	<b>11,989,139</b>

Table provided by Alio Gold Inc.

While Table 9.1 generally appears to indicate an increase in exploration expenditures since 2013, it is only because the expenditures include the 2014 to 2015 in-fill drilling in the San Francisco pit, the 2014 condemnation drilling for the new leach cells, land use change fees for leach pads and southwest waste pads (USD 550,603), as well as the mining taxes for the concessions. In some instances, the in-fill pit and the condemnation drilling, land use change fees and land use mining taxes would not necessarily be considered exploration expenditures but rather mining expenditures related to grade control and infrastructure. However, when compared to the exploration expenditures of USD 39,498,426 for the period from July, 2011 to July, 2013, the reduction in exploration expenditures was actually substantial.

Details of the in-fill and condemnation drilling programs are outlined in Section 10.0 of this report.

Very little exploration has been conducted in the San Francisco and La Chicharra areas since 2015.

### **9.3 EL DURAZNO, VETATIERRA, 1B AREA AND LA PIMA PROJECTS**

Alio had started to explore the other mineralized areas located on the San Francisco property. The El Durazno and Vetatierra Projects, located 12 km and 8 km north of the San Francisco mine, respectively, were first discussed in the previous 2013 Technical Report and portions are summarized here. The 1B Area and La Pima Projects are 3.2 km and 25 km north of the San Francisco Project, respectively.

#### **9.3.1 El Durazno Project**

The El Durazno Project is located approximately 12 km north of the San Francisco mine and is contained within the confines of the San Francisco property. No exploration has been conducted at the El Durazno Project since the 2013 Technical Report was published.

The previous work from the 2013 Technical Report is summarized as follows:

Alio collected 1,611 soil samples from the Durazno Project; samples were collected on 100 m spaced stations on lines spaced 100 m apart. The samples consisted of between 0.5 and 1.0 kg of -12 mesh soil, taken from the near-surface B horizon (0 to 30 cm) from each sample site.

The soil samples were submitted to ACME Analytical Laboratories Ltd. (ACME Analytical), where they were sieved 100 g to -80 mesh and analyzed 30 g for 53 elements by aqua regia digestion ultra-trace elements inductively coupled plasma mass spectrometry (ICP-MS). ACME Analytical is an independent analytical laboratory.

The soil anomaly at El Durazno main area is defined by 158 samples with values greater than 20 ppb Au; 74 samples have values >50 ppb up to a maximum value of 894 ppb of gold. The soil anomaly covers an area of 1 km in width by 2 km in length that trends to the north. The gold soil anomaly has an internal Pb anomaly with samples greater than 20 ppb, with 19 values above 100 ppm.

The soil sampling north of the main El Durazno area was intended to cover the area in which the Cretaceous sediments outcrop. Three gold anomalies covering the Cretaceous sediments were identified that are characterized by gold values up to 20 ppb. The first two anomalies are located as follows; approximately 1.5 km north of the main area, an east-west trending gold anomaly was identified that covers an area 1.2 km in length by 500 m in width, and 2.8 km north-northwest of the main area there is a 1.4 km long by 500 m wide area with anomalous gold values that appears to trend east-northeast. Dimensionally smaller than the first two anomalies described, a third gold anomaly is located east of the main area that covers an area of 600 m in length by 500 m in width.

In the area known as El Durazno Sur, a soil sampling program was carried out with the objective of determining if the gold mineralization found in quartz-tourmaline veins, which are hosted by El Claro granitic intrusion, continues to the south, below the quaternary soil cover.



A total of 107 samples were taken but the gold anomaly was only identified in the areas where quartz-tourmaline veins have been mapped.

In late 2012, Alio initiated a sampling program primarily comprised of rock grab samples with some trench samples, beginning with the El Durazno main area. The sampling was conducted over those areas where the quartz veining was mapped around the intrusive and also over the sediments, but focused in the early stages on the El Durazno main area and the El Pinto area. Subsequently, grab samples were also collected in the Durazno Sur and El Pedregoso areas, in the central part of the intrusive known as El Tungsteno, and from several outlying areas between those prospects, as well as several small isolated areas.

The total number of grab samples collected through from late 2012 through the first quarter of 2013 is 930.

In late 2012, the initial focus of the rock sampling was at the area of El Durazno and within the intrusive. Subsequently, a first pass prospecting sampling was done over the Cretaceous sediments north of El Durazno main area. The intention of the sampling was to define the surface mineralized zones delimited by the old artisanal diggings. The grab chip sampling covers an area of approximately 5 km in length by 4 km in width in either the intrusive or sediments.

From the total number of samples collected, 283 samples yield values up to 0.1 g/t Au, 44 samples yield values up to 1 g/t Au and the highest gold value in a sample at El Durazno returned 22.614 g/t Au, 511.9 g/t Ag, 0.86% Pb, 0.03% Mo and 221 ppm Te.

Rock samples were submitted to Inspectorate Laboratory (Inspectorate) and analyzed for gold by fire assay and atomic absorption finish plus 29 elements by four acid digestion with ICP-AES finish. Mercury was analyzed by cold vapour and atomic absorption finish, and tellurium by ultra-trace analysis via aqua regia digest and atomic absorption finish. Inspectorate is an independent laboratory.

The multi-element geochemistry of the rock sampling assists in the understanding of the evolution of the El Claro intrusion mineralization. Geochemically, there is a high correlation of quartz tourmaline veins with Au-Ag, with occasional high values of Pb, Mo, Bi and Te, in the El Durazno main area, and the El Pinto and El Durazno Sur areas. Correlation coefficients of the total samples collected, primarily in the granodiorite intrusive, show a high relationship of gold with Ag and Te. Silver shows a strong relationship with Bi, Te and Pb, suggesting that those minerals occur as telluride complexes, similar as the occurrences found at the San Francisco mine as calaverita ( $\text{AuTe}_2$ ), hessita ( $\text{Ag}_2\text{Te}$ ), altaite ( $\text{PbTe}$ ) and bismuth tellurides ( $\text{Bi}_2\text{Te}_3$ ).

The multi-element geochemistry also shows a lateral southwest to northeast zonation from tungsten in the southwest, to arsenic to the northeast, with gold plus tellurides in the middle. This zonation may be indicative of the large hydrothermal system over all of the El Claro intrusion.

Figure 9.1 is a map showing the El Durazno geology and some sampling locations.

**Figure 9.1**  
**Map indicating the El Durazno Geology, and Some Grab and Trench Sampling Locations**

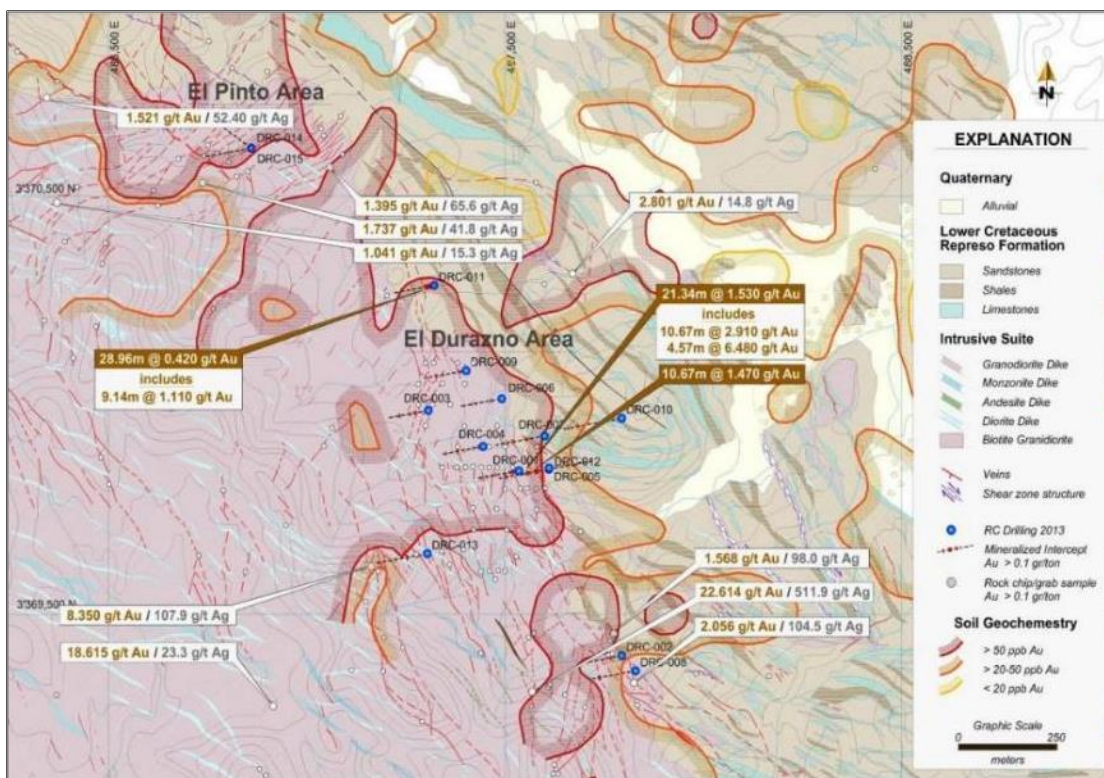


Figure provided by Alio Gold Inc. and dated August, 2013.

### 9.3.2 Vetatierra Project

The early stage Vetatierra Project is located approximately 8 km north of the San Francisco mine and is contained within the confines of the San Francisco property. Mapping and chip sampling was conducted on the Vetatierra Project. The results were briefly discussed in the 2013 report and are summarized below.

Alio initiated a rock chip grab sampling program on the Vetatierra Project in March, 2013. The rock chip sampling was conducted in those areas where the quartz veining was mapped all around the intrusive and over the sediments, focusing on the diorite stock and the surrounding areas. Subsequently, grab samples were also collected southwest of the main area. The total number of rock grab samples collected up to the second quarter of 2013 was 261. The objective of the sampling was to define the surface mineralized zones, with the sampling covering an area approximately of 1.8 km long by 0.7 km wide.

The initial rock chip samples collected returned significant gold values, with a few samples yielding high-grade values of silver. Sample No. 4601 contained the highest gold value at 29.56 g/t Au, 27.1 g/t Ag and 0.35 % Pb and sample No. 4857 yielded 1.0 g/t Au, 905.5 g/t Ag, 3.63%

Pb. Both samples were collected from a dump near an old artisanal mine. In addition, 520 channel chip samples were collected from 3 main trenches. Figure 9.2 is a map indicating the geology and 2013 sampling locations at the Vetatierra Project.

In 2014, Alio conducted a drilling program comprised of 4 reverse circulation (RC) and 6 diamond drilling (core) holes on the Vetatierra Project. The RC drilling totalled 1,197.86 m and the core drilling totalled 2,311.3 m for a combined total of 3,509.16 m. Details of the drilling program at the Vetatierra Project are discussed in Section 10.0 of this report.

### **9.3.3 1B Area Project**

The 1B area is located 3.2 km north of the San Francisco pit. Geological mapping indicates that a pair of shear zones, containing gold mineralization, are exposed at surface. The shear zones are approximately 300 m apart in this area, which appears to be the widest portion of a broader zone with the shear zones corresponding to both the footwall and hangingwall, respectively. In 2014, Alio scheduled a preliminary drilling program for this area to better understand how the gold mineralization was related to the low-angle highly oxidized shear zone-hosted quartz veining in the local granitic rocks. Surface rock sampling returned up to 4.50 g/t gold, south of the shear zone over what is interpreted to be the eroded footwall of the shear zone.

The drilling program was comprised of 57 RC holes totalling 8,040.40 m and 3 core holes totalling 758.7 m. Details of the drilling program at the 1B Area Project are discussed in Section 10.0 of this report.

### **9.3.4 La Pima Project**

The early stage La Pima Project is located approximately 25 km north of San Francisco mine within the San Francisco property.

The mineralization within the La Pima Project is related to structurally controlled hydrothermal Ba-Ca-Ag-Pb-Zn breccias with over a 2.5 km strike length that are hosted in fossiliferous limestones of Cretaceous age. Artisanal mines and diggings have been developed within the limestone beds.

Four main exploration targets were identified within the project area: West Target (WT), Central Target (CT), North Target (NT) and Pima Mine Target (PMT). At the PMT, artisanal underground workings were developed early in the 1900's along two main structures striking NE 50° and dipping NW 20°. The developed workings stretch over 100 m in length with a maximum width of 10 m and are 60 m deep. The NT is in a flat area north of the PMT and is approximately 85% covered by alluvial material containing small outcrops of interbedded siltstones and sandstones and Ba-Ca breccias with anomalous values of Ag-Pb-Zn. The CT and WT areas have a geological, structural and mineralization signature very similar to the PMT.

**Figure 9.2**  
**Geology and Sampling Locations at the Vetatierra Project**

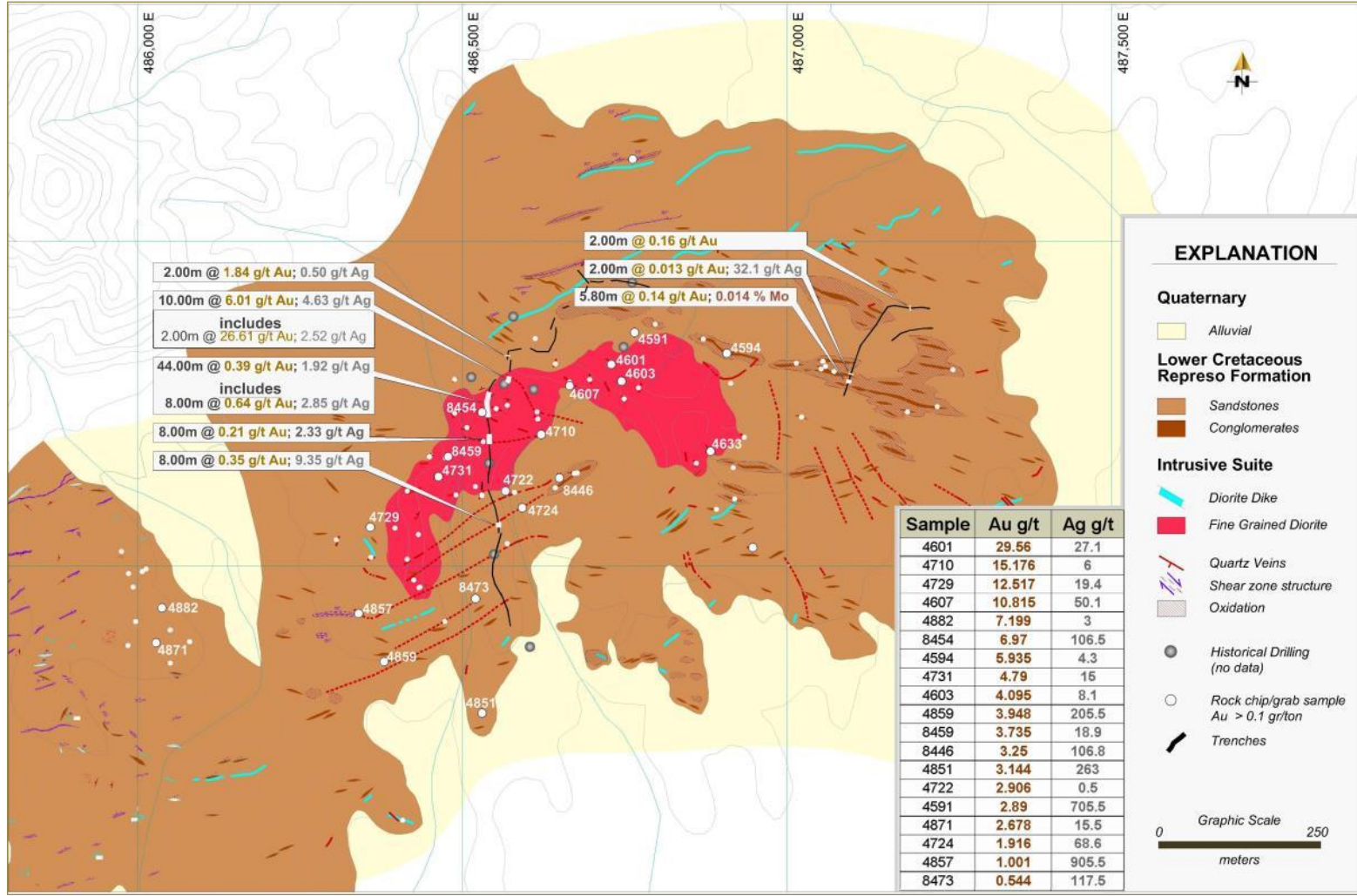


Figure provided by Alio Gold Inc. and dated August, 2013.

Initial surface grab sampling returned significant silver values, with a few samples yielding values of over 1 kg/t Ag from both surface and underground. The chip surface sample No. 7894 returned 2,103.52 g/t Ag with no significant values of Pb and Zn. The underground chip sample No. 5951 returned 1,026.6 g/t Ag, 2.05% Pb and 0.50% Zn. An additional 845 samples were taken from the other targets including underground sampling.

Rock samples were submitted to the San Francisco mine laboratory and were analyzed by fire assay and atomic absorption. 215 pulp samples were submitted to ALS Minerals laboratory (ALS) as assay checks and the results showed slightly lower values than those reported by the San Francisco mine laboratory. Once the variation in assay values were tabulated, Alio decided that all of the samples should be reassayed and that the values from ALS were used as the correct numbers.

Figure 9.3 is a geological plan view of the La Pima Project showing the target areas under investigation. Figure 9.4 is a closer view of the geological plan for the La Pima mine target. Figure 9.5 is a longitudinal section demonstrating the extent of the artisanal workings from the early 1900's within the mineralized zone.

## **9.4 MAGNA EXPLORATION PROGRAMS FOR THE SAN FRANCISCO PROPERTY**

### **9.4.1 San Francisco Mine (San Francisco and La Chicharra Pits)**

On March 6, 2020, Magna announced that it has entered into a definitive purchase agreement with Timmins, a wholly-owned subsidiary of Alio, to acquire the San Francisco Project. After a period of reviewing the available geological data previously provided by Alio, Magna identified a number of infill and exploration targets around the existing San Francisco and La Chicharra pits as well as a other targets located on the concessions.

In order to ensure the continuity of the operations within the San Francisco and La Chicharra pits, Magna has designed a reverse circulation drill program comprised of both infill and exploration holes at specific sites in and around both pits. The program is based on the down dip projections of the mineralized zones indicated by the accumulated data gathered from the years of exploration and operational drilling and mining of the San Francisco mine, using a gold price of USD 1,350/oz of gold.

Figure 9.6 illustrates the San Francisco and La Chicharra pits, with the corresponding down dip mineralization interpretation at USD 1,350/oz of gold. Based on this interpretation, a drill program has been designed to test the extension of the mineralization and/or the connection between different mineralized intercepts within the perimeters of the down dip interpretation, as well as focusing on connecting smaller neighbouring mineralized areas. A program of infill drilling has also been outlined in and around the crushing circuit, to determine the feasibility of relocating the circuit and thereby potentially allowing the mining of the mineral resources currently located under it.

**Figure 9.3**  
**Geological Map of the La Pima Project Showing the Locations of the Exploration Targets**

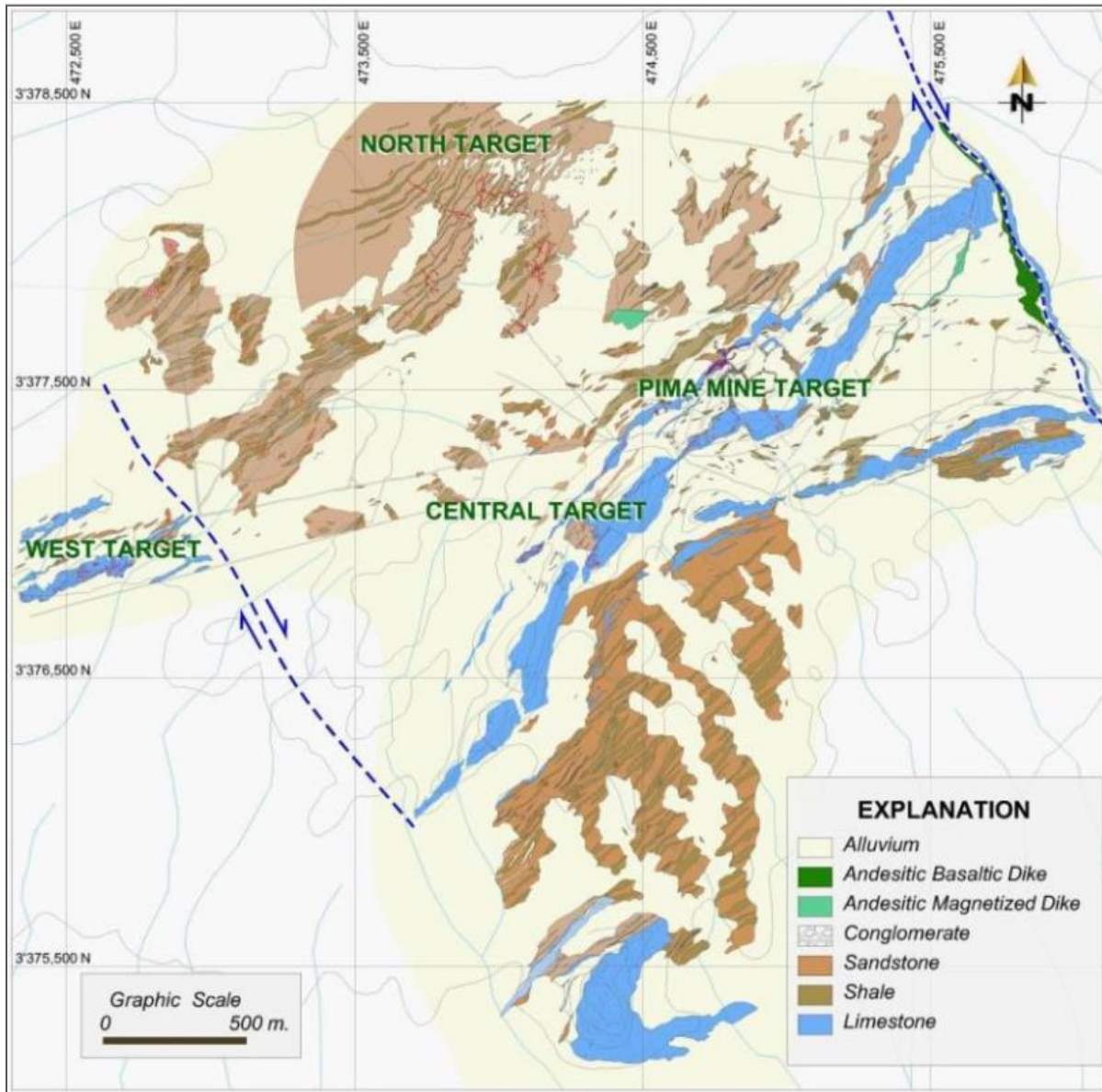


Figure provided by Alio Gold Inc., Figure dated February, 2016.

**Figure 9.4**  
**Geological Map of the La Pima Mine Exploration Target and the Location of the Longitudinal Section**

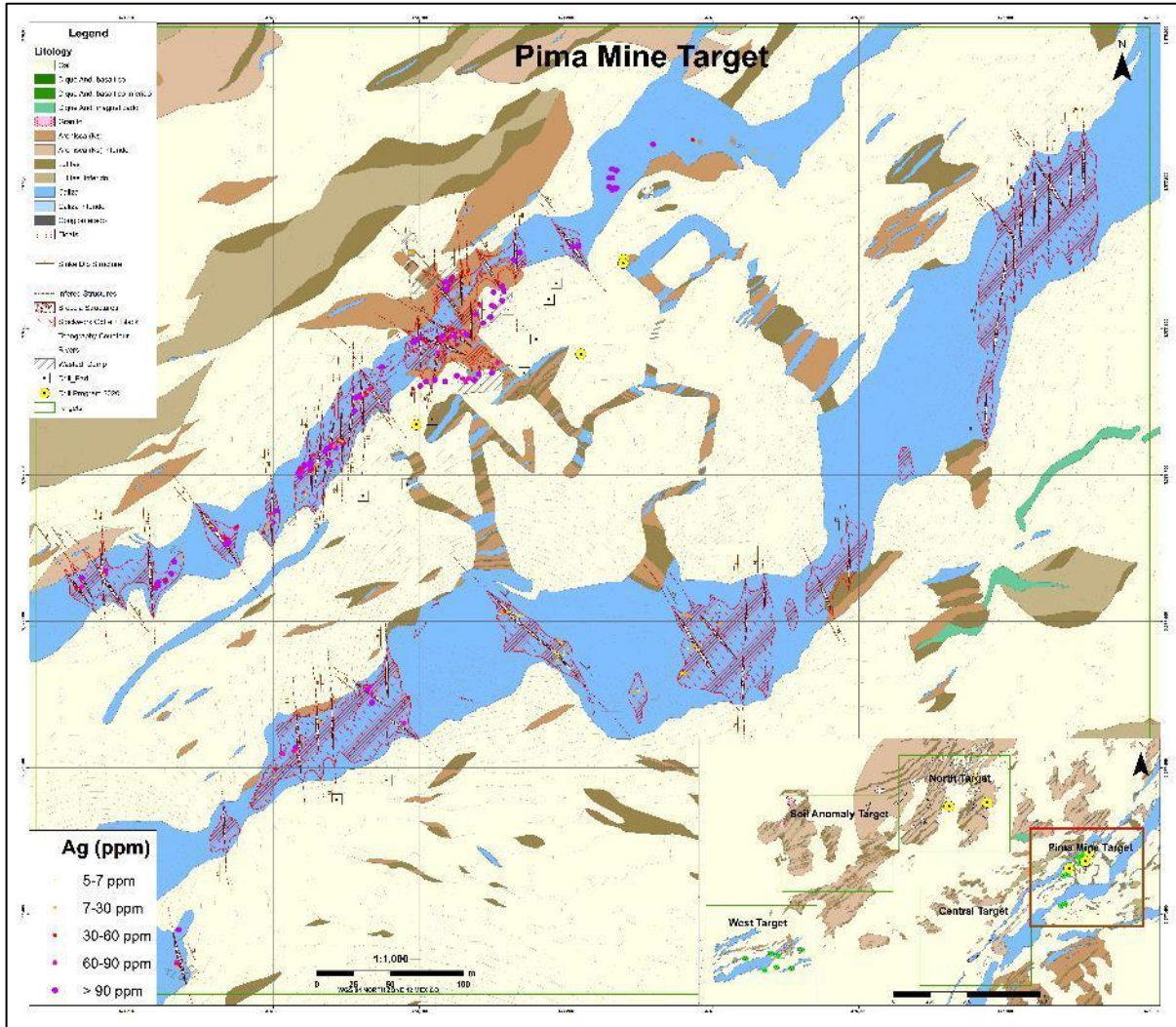


Figure provided by Magna Gold Corp. Figure dated May, 2020.

**Figure 9.5**  
Longitudinal Section Across the La Pima Mine Exploration Target Showing the Artisanal Workings in the Mineralized Zone



Figure originally provided by Alio Gold Inc. Figure dated February, 2016.

**Figure 9.6**  
Drill Program Map Based on the Down-Dip Projection of the Mineralization at USD 1,350/ oz Au for the San Francisco and La Chicharra Pits

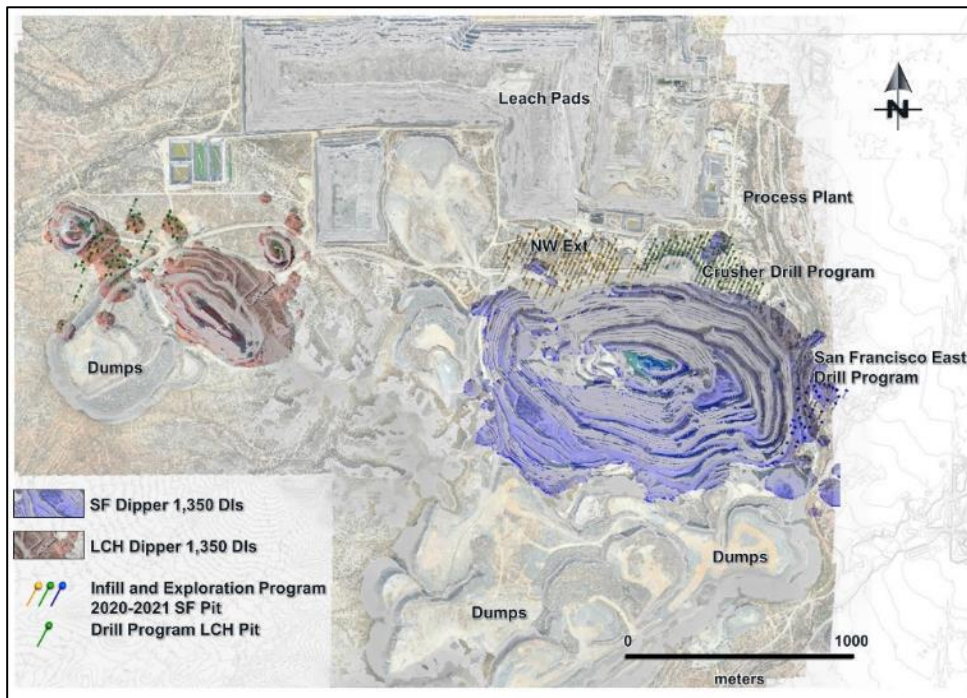


Figure provided by Magna in July, 2020.



The Magna drill program consists of a total of 46,250 m distributed in 290 RC drill holes, as summarized in Table 9.2.

**Table 9.2**  
**Summary of Magna’s Proposed RC Drilling Program for the San Francisco Project**

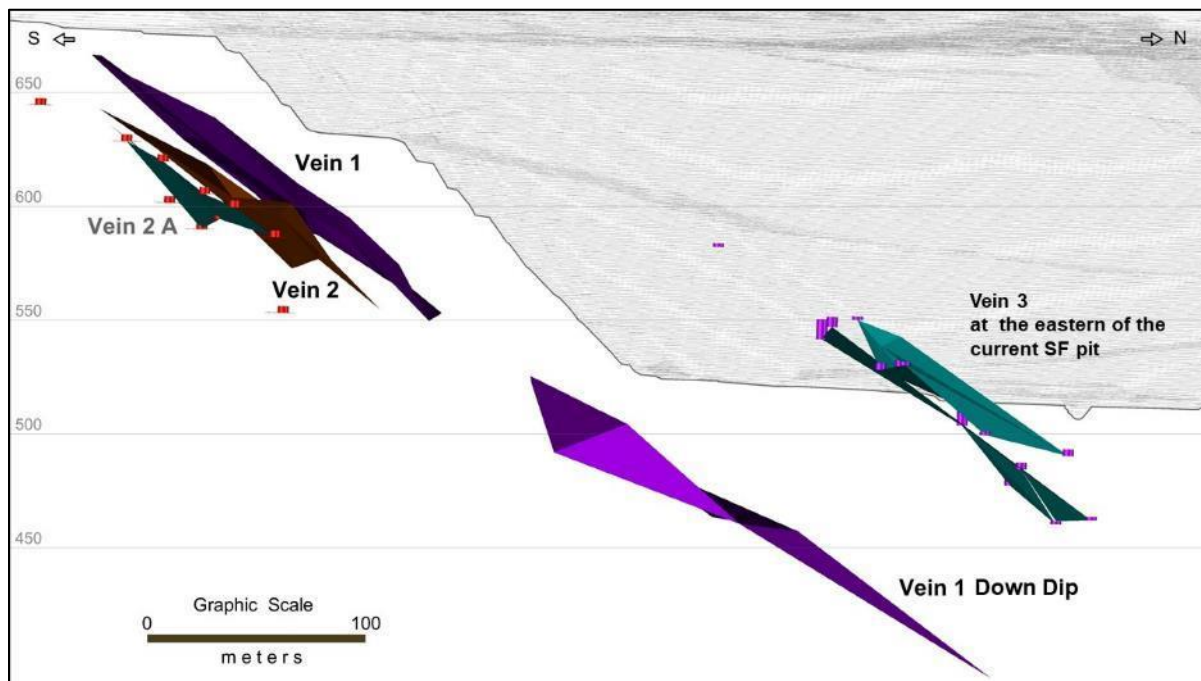
Location	Number of Drill Holes	Total Metres (m)
San Francisco SE	17	1,700
La Chicharra NW	91	7,600
L-200 NW Extension	71	13,450
SF Crushing Site	76	15,200
SF East Extension	35	8,300
<b>Total</b>	<b>290</b>	<b>46,250</b>

In addition to the program outlined above, Magna is scheduled to conduct a core drill program on the south wall of the San Francisco pit, specifically on the Phase 7A segment of the mine plan. The drill program is targeted to further outline the repetitive high gold grade drill intercepts encountered in past drilling campaigns which appear to be related to the vein system located at the San Francisco and El Carmen areas of the Project. This vein system was the origin of the mining at the San Francisco Project, when small scale underground mine workings were developed along high gold grade material during the early 1940s.

During 2014 and 2015, a re-interpretation using selective criteria was conducted of the mineral intercepts from approximately 40 RC and core holes located in the area. This re-interpretation identified the possibility of high-grade mineralization located in three mineralized veins which were named simply Vein 1, Vein 2 and Vein 3. The veins contained grades ranging between 3 to 5 g/t gold along parallel quartz structures with widths varying from 1 m to 12 m and averaging 3 m. In 2015, an underground pilot test was started along Vein 1 that involved the development of 445 m of tunnels, including an access ramp and a drift along the mineralized structure. A total of approximately 90 m of mine workings were conducted along the mineralized structure, including several inclined raises to test the continuity of the high-grade structure (Vein 1) in up-dip direction. By the end of the two month pilot test period, a total of 7,960 t averaging 4.07 g/t Au were extracted and added to a leach pad designed for this material. Figure 9.7 shows the position within the San Francisco pit of the three high gold grade veins.

In order to follow up on this previous work and taking advantage of existing underground workings, Magna has scheduled additional underground development to further extract the mineralization identified during the 2015 program. Magna also plans to conduct a core drilling program which aims to extend the mineralization along strike, confirm the continuity of the mineralization of Vein 1 in the up and down dip directions from the existing workings, and explore Vein 2 located in the footwall of Vein 1. It may be possible to access Vein 2 by conducting a short extension from the existing underground development workings on Vein 1.

**Figure 9.7**  
**3D Projection of the High-Grade Veins Identified along the South Wall of the SF Pit**



The Magna drill program will be comprised of approximately 4,000 m in 38 short core holes. Table 9.3 summarizes the estimated budget for the 2020-2021 infill and exploration drilling programs at the San Francisco Project.

**Table 9.3**  
**Estimated Budget for the 2020-2021 Infill and Exploration Drilling Programs at the San Francisco Project**

Description	Unit	Unit Cost (USD)	No. Units	Total Cost (USD)
<b>Geology and exploration</b>				
Project management	Month	12,000	12	144,000
Geologist (salaries and consulting fees)	Month	30,000	12	360,000
Field hands	Month	9,000	12	108,000
Camp, foods and accommodation	Month	2,500	12	30,000
Exploration expenses and supplies	Lump	5,000	2	10,000
Reverse circulation drilling	Metre	46,250	55	2,543,750
Core drilling	Metre	4,000	90	360,000
Assaying for gold (external, prep and assay)	Samples	41,875	11	460,625
Geochemical assays (multielements)				-
Engineering and feasibility	Lump	50,000	1	50,000
Metallurgical testwork	Lump	50,000	1	50,000
Drafting, reporting, reproduction, maps	Lump	2,500	12	30,000
Hardware and software (maintenance and new one)	Lump	30,000	1	30,000
Logistic exploration support	Lump	2,000	12	24,000
Vehicle renting	3	6,000	12	72,000

Description	Unit	Unit Cost (USD)	No. Units	Total Cost (USD)
Gasoline and maintenance	Lump	2,100	12	25,200
Travel expenses				-
Safety equipment	Lump	900	12	10,800
Social security and labour related taxes	Estimated	612,000	10%	61,200
<b>Total exploration and administration</b>				<b>4,369,575</b>

Table provided by Magna, August 2020.

## 9.4.2 Vetatierra Project

The Vetatierra Project is located 6 km to the north of the San Francisco mine, within concession San Francisco 4. The area was previously explored by Fresnillo, in the 1980's, along with some core drilling, the records of which were apparently lost or destroyed. In 2014, Alio carried out a geological exploration program comprised of mapping, sampling of rock chips in trenches and finally a drill program of 5 core holes and 4 reverse circulation holes drilled along a single line coincident with the best gold values obtained from the existing outcrops and from other holes on the site. The most important mineralized intersection occurred in drill hole VT14-002, with an interval of 33.85 m grading 1.28 g/t Au, including 22.40 m of 1.87 g/t Au and 12.50 m of 3.26 g/t Au. The 2014 drilling suggests that the majority of the mineralization is hosted in a diorite stock which is very poorly exposed.

Magna has proposed an initial 2,000 m drilling program to define the continuity of the mineral intercepts from the previous campaign, to explore the potential lateral extension of the gold mineralization detected during the previous drilling program, and to gain a better understanding of the diorite geometry at depth.

Figure 9.8 shows 2014 drilling in relationship to the geology for the Vetatierra Project. Figure 9.9 shows the proposed 2020 drill hole locations.

**Figure 9.8**  
2014 Drill Holes in Relation to the Geology at the Vetatierra Project

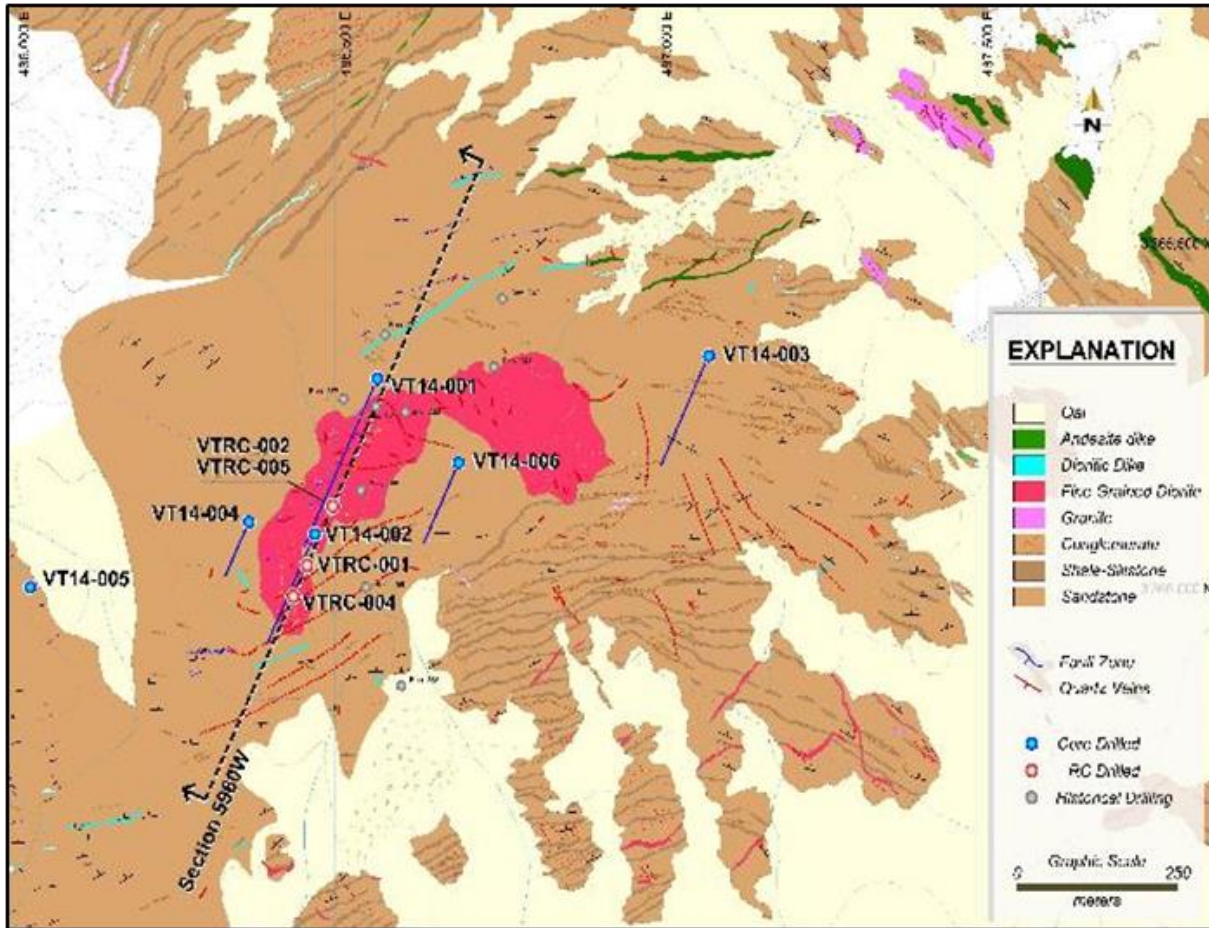


Figure provided by Magna, August 2020.

**Figure 9.9**  
**2020 Drill Program Location Map on the Vetatierra Project**

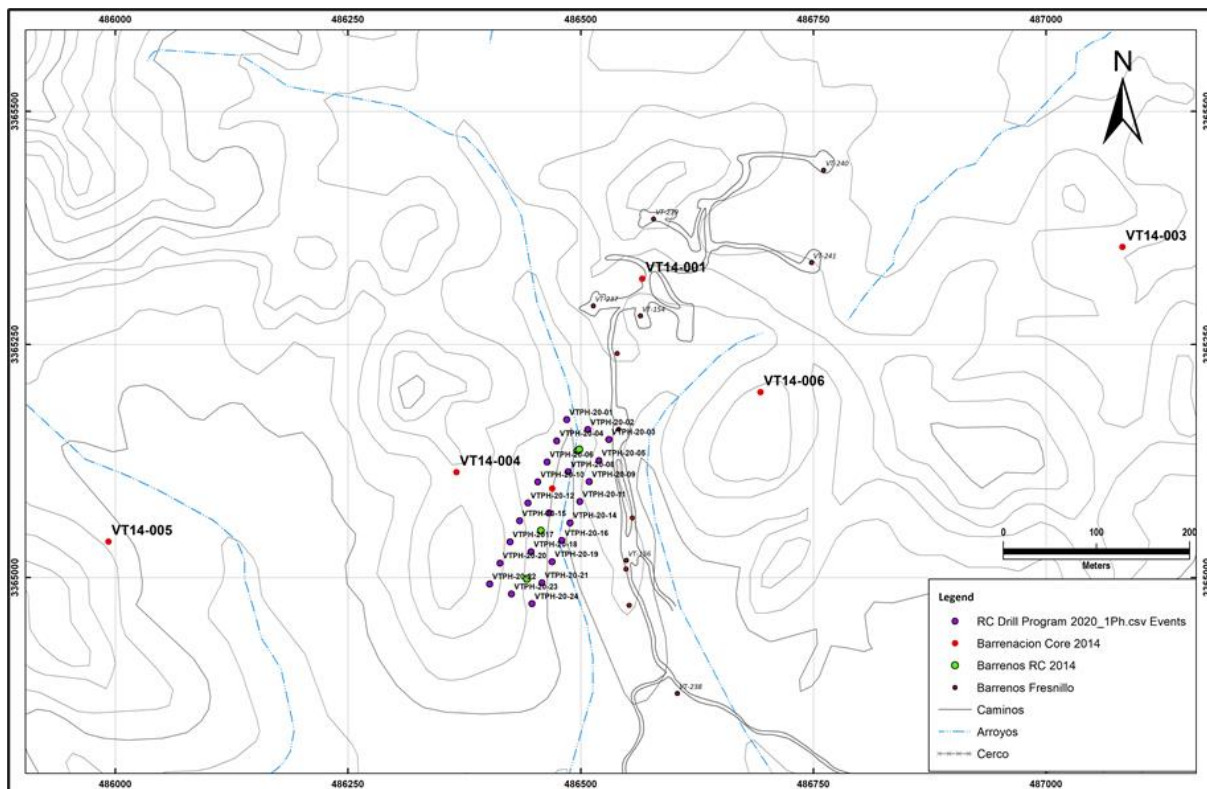


Figure provided by Magna, August 2020.

Table 9.4 summarizes the budget for the 2020 exploration program at the Vetatierra Project.

**Table 9.4**  
**Estimated Budget for the 2020 Exploration Program at the Vetatierra Project**

Description	Unit	Unit Cost (USD)	No. Units	Total Cost (USD)
<b>Geology and exploration</b>				
Project management	Month	5,000	3	15,000
Geologist (salaries and consulting fees)	Month	25,000	3	75,000
Field hands	Month	9,000	3	27,000
Camp, foods and accommodation	Month	2,500	3	7,500
Exploration expenses and supplies	Lump	5,000	1	5,000
Reverse circulation drilling	Metre	2,000	55	110,000
Core drilling		-		-
Assaying for gold (external, prep and assay)	Samples	1,667	18	30,000
Geochemical assays (multielements)		1,667	12	20,004
Geophysical supervising (IP-R, CSAMT)	Lump	50,000	1	50,000
Drafting, reporting, reproduction, maps	Month	900	3	2,700
Logistic exploration support				-
Vehicle renting	Vehicle	4,000	3	12,000
Gasoline and maintenance	Lump	2,100	3	6,300

Description	Unit	Unit Cost (USD)	No. Units	Total Cost (USD)
Safety equipment	Lump	900	3	2,700
Social security and labour related taxes	Lump	115,000	0	11,500
<b>Total exploration and administration</b>				<b>374,704</b>

Table provided by Magna, August 2020.

### 9.4.3 La Pima Project

The La Pima Project is located 25 km northwest of the San Francisco Project, within the San Francisco property.

The mineralization at the La Pima Project is related to structurally controlled hydrothermal Ba-Ca-Ag-Pb-Zn breccias, replacements and in-filling fractures with over a 2.5 km strike length which are hosted in fossiliferous limestones of the Cretaceous age. Artisanal mines and diggings have been developed within the limestone up to a depth of 60 m.

Along the mineralized trend, four targets have been delineated, with two of them, Pima mine target (PMT) and West target (WT), having high silver values. At the PMT target, underground artisanal workings were developed in the early's 1990's along two main structures striking N50°E and N20°W. At the intersection of these two structures a mineralized breccia has formed which is rich in silver. The underground artisanal workings stretch over 100 m in length, with widths varying from 5 m to 15 m, and are 60 m in depth. Geological mapping and chip channel sampling has been completed within these existing workings. The WT has similar features but there is no access to the underground workings.

Sampling at the Project included 746 chips surface samples, with 235 samples grading over 30 g/t Ag and maximum grade of 2.1 k/ton Ag, and 102 chip samples within the underground workings with 86 samples grading over 30 g/t Ag and a few samples yielding over 500 g/t Ag.

Magna has proposed conducting additional exploration at the La Pima Project that includes a geophysical survey using either IP-R or CSAMT and a core drilling program. The geophysical survey will initially consist of two lines. Depending on the initial results additional lines could be required to assist with designing the drill plan.

Magna is in the process of scheduling a core drilling program of 3,000 m distributed across different targets within the Project area.

Table 9.5 summarizes the budget for the 2020 exploration program at the La Pima Project.

**Table 9.5**  
**Estimated Budget for the 2020 Exploration Program at the La Pima Project**

Description	Unit	Unit Cost (USD)	No. Units	Total Cost (USD)
<b>Geology and exploration</b>				
Project management	Month	5,000	4	20,000
Geologist (salaries and consulting fees)	Month	25,000	4	100,000
Field hands	Month	9,000	4	36,000
Camp, foods and accommodation	Month	2,500	4	10,000
Exploration expenses and supplies	Lump	2,500	1	2,500
Reverse circulation drilling	Metre	-		-
Core drilling	Metre	3,000	90	270,000
Assaying for silver and multielements (external, prep and assay)	Samples	3,000	16	48,000
Geochemical assays (multielements)				-
Geophysical supervising (IP-R, CSAMT)	Lump	60,000	1	60,000
Drafting, reporting, reproduction, maps	Month	900	4	3,600
Logistic exploration support				-
Vehicle renting	Vehicle	4,000	4	16,000
Gasoline and maintenance	Lump	2,100	4	8,400
Safety equipment	Lump	900	4	3,600
Social security and labour related taxes	Lump	272,500	0	27,250
<b>Total exploration and administration</b>				<b>605,350</b>

Table provided by Magna, August 2020.

## 9.5 MICON COMMENTS

Micon's QP has reviewed the exploration programs and has visited the various exploration sites, as well as discussing the exploration programs, procedures and practices with personnel during the numerous site visits to the San Francisco Project. Micon believes that the exploration programs were managed according to the Exploration Best Practice Guidelines, as established by the CIM in August, 2003 and recently updated in 2019. Furthermore, the sampling methods and sample quality are generally good and are representative of an early stage program where grab sampling and localized trench sampling, along with soil sampling are conducted to identify the general area and extent of the mineralization, prior to defining areas of interest where further sampling or drilling may be conducted in subsequent programs.

As Magna is in the process of conducting drilling at the San Francisco Project with the objective of extending the minelife. Given the initial mining history at the San Francisco Project, Micon believes that there is a very good chance that Magna could outline a sufficient underground resources to continue operations. Magna is also in the process of actively exploring the potential of the San Francisco property to host secondary mineral deposits which could either provide feed for the San Francisco operation or provide feed for independent secondary operations.

## 10.0 DRILLING

This section has been extracted from the June 1, 2020, Technical Report completed by Micon for Magna and updated where applicable.

### 10.1 DRILL TYPES AT THE SAN FRANCISCO PROJECT

Three types of drilling are used for exploration at the San Francisco Project:

1. Percussion rotary air blast (RAB) drilling.
2. Reverse circulation (RC) drilling.
3. Diamond core drilling.

#### 10.1.1 Percussion Rotary Air Blast (RAB) Drilling

RAB drilling is also known as down-the-hole drilling. The drill uses a pneumatic reciprocating piston-driven hammer to drive a heavy drill bit into the rock. The drill bit is hollow steel and has approximately 20 mm thick tungsten rods protruding from the steel matrix as buttons. The tungsten buttons are the cutting face of the bit.

The cuttings are blown up the outside of the rods and collected at surface. Air or a combination of air and foam lift the cuttings from the drill hole.

RAB drilling is used primarily for mineral exploration, water bore drilling and blasthole drilling in mines, as well as for other applications. RAB drilling produces lower quality samples because the cuttings are blown up the outside of the rods and can be contaminated from contact with other rock types.

RAB drilling was conducted on the San Francisco Project between January, 2014 and December, 2014. However, the results of RAB drilling have not been used in the estimation of the mineral resources and reserves discussed herein or in any of the previous Micon Technical Reports. Recovery of the material from the RAB drilling is generally good with better than 90% of the material recovered at the San Francisco Project.

#### 10.1.2 Reverse Circulation (RC) Drilling

RC drilling uses hardened steel or tungsten blades to bore a hole into unconsolidated ground. The drill bit has three blades arranged around the bit head. The rods are hollow and contain an inner tube inside the hollow outer rod barrel.

The drilling mechanism is a pneumatic reciprocating piston known as a hammer, driving a tungsten-steel drill bit. RC drilling utilizes large rigs and machinery and depths of up to 500 m are routinely achieved. RC drilling ideally produces dry rock chips, as large air compressors dry the rock ahead of the advancing drill bit. RC drilling is slower and costlier but achieves



better penetration than RAB drilling; it is less expensive than diamond coring and is thus preferred for most mineral exploration work.

Reverse circulation is achieved by blowing air down the rods, with the differential pressure creating air lift of the water and cuttings up the inner tube. The cuttings reach the bell at the top of the hole, then move through a sample hose which is attached to the top of the cyclone. The drill cuttings travel around the inside of the cyclone until they fall through an opening at the bottom and are collected in a sample bag or pail.

Although RC drilling is air-powered, water is also used, to reduce dust, keep the drill bit cool, and assist in pushing the cuttings back upwards. A drilling mud is mixed with water and pumped into the rod string, down the hole. When the drill reaches hard rock, a collar is put down the hole around the rods. Collaring a hole prevents the walls from caving in and bogging the rod string at the top of the hole. Recoveries of the material from RC drilling at the San Francisco Project are good with better than 95% recovery.

Figure 10.1 is a view of one of the RC drill rigs in operation in the San Francisco pit during the Micon site visit in July, 2011.

**Figure 10.1**  
**RC Drilling in the San Francisco Pit in July, 2011**



### **10.1.3 Diamond Core Drilling**

Diamond core drilling utilizes an annular diamond-impregnated drill bit attached to the end of hollow drill rods to cut a cylindrical core of solid rock. The diamonds used are fine to microfine

industrial grade diamonds. They are set within a matrix of varying hardness, from brass to high-grade steel. Holes within the bit allow water to be delivered to the cutting face.

Core samples are retrieved via the use of a lifter tube, a hollow tube lowered inside the rod string by a winch cable until it stops inside the core barrel. As drilling proceeds, the core barrel slides over the core as it is cut. The winch is then retracted, pulling the core barrel to the surface.

Once the core barrel is removed from the hole, the core is removed and catalogued. The core is washed, measured and broken into smaller pieces to make it fit into the sample trays.

Diamond rigs can also be part of a multi-combination rig. Multi-combination rigs are capable of operating in either an RC or diamond drilling mode (though not at the same time). This is a common scenario where exploration drilling is being performed in an isolated location.

Figure 10.2 is a view of a core diamond drilling set-up southeast of the San Francisco pit during Micon's site visit in July, 2011.

**Figure 10.2**  
**Diamond Drill Rig Set-Up on a Drill Hole Southeast of the San Francisco Pit**



In general, core recovery for the diamond drill holes at the San Francisco Project was better than 98% and no core loss due to poor drilling methods or procedures was experienced.

## 10.2 GENERAL INFORMATION

Since the San Francisco project is located on a number of concessions upon which mining has been conducted, any exploration work on these concessions continues to fall under the environmental permitting already in place for the mine and no further notice is required to be given to any division of the Mexican government. The original environmental permitting of the San Francisco mine site is valid for the duration of the exploitation concessions. Water for the drilling programs at the San Francisco project is obtained from on-site water wells.

The drill hole collar locations were established using a high precision GPS unit and marked prior to drilling with wooden stakes denoting the drill hole collar plus a front sight line to indicate the azimuth of the hole. After a drill hole was completed, the collar location was marked with a cement marker denoting the drill hole number. Figure 10.3 is a photograph of the cement marker located on drill hole TF-1522. Once the drilling program was completed, all drill hole collars were surveyed by the Alio exploration staff using its own GPS Total Station Trimble 5700 movil and 4700 rover (base).

**Figure 10.3**  
**Location Marker for Drill Hole TF-1522**



## 10.3 DRILLING PRIOR TO 2014

### 10.3.1 Alio Exploration Programs Since 2005

During August and September, 2005, Alio conducted a drilling program comprised of 14 RC holes, based on the results of previous drilling conducted by both Fresnillo and Geomaque.

The 2005 RC drilling program focused on confirming and exploring extensions of the gold mineralization to the northwest and southeast of the existing San Francisco pit. The results of the drilling program confirmed the extension of the gold mineralization to the northwest, beyond the limits of the pit, and the presence of a higher grade gold zone. To the southeast, the 2005 drilling results did not confirm the previous drilling conducted by Geomaque, with only erratic values detected. However, drill hole TF-06 ended in 6.10 m averaging 2.817 g/t gold.

In 2006, Alio conducted an intensive exploration drill program which was based on the analysis of Geomaque's drilling results, the 2005 Alio drill results, the geological and geochemical data and a structural re-interpretation of the gold mineralization controls within the known deposit. The drilling program consisted of 28 RC and 28 diamond drill holes within three general target areas. The first area covered by the drilling program was the immediate area north and northwest of the existing San Francisco pit, with a particular emphasis placed on drilling in the area covered by the former crusher. The second area covered by the 2006 drilling program was located to the north and south of the La Chicharra pit. The third area covered by the drill program investigated places where direct observations by Alio geologists and previous geological mapping indicated favourable lithology, hydrothermal alteration and geochemical results for the continuation of the mineralization around the existing San Francisco pit.

The 2006 drilling program to the north of the San Francisco pit was considered to be successful, as it confirmed the continuity, both laterally and at depth, of the mineralized intersections known from previous drill holes, in a portion of the Project which comprises the area from Section 880NE to 1040NE, a distance of 160 metres along the main mineralized system and 150 metres following the northwest extension.

The results of the 2006 drilling in the immediate area of La Chicharra pit confirmed the extension of the gold mineralization in the projected dip direction to the north.

During 2007, Alio conducted field work and exploration drilling to evaluate the extent of the gold mineralization in other zones on the property. This program was primarily concentrated to the north of the existing San Francisco pit limits and to the north of the La Chicharra pit. Forty holes totalling 4,838 m of core drilling were completed in this program which also included 1,327 m of condemnation drilling west of the original leach pads.

In the west pit area a total of 7 drill holes were completed which totalled 972.25 m. The drilling confirmed the continuity of the high-grade intersections previously encountered. In the area of the La Chicharra pit a total of 9 drill holes were completed totalling 1,369 m. The results of this drilling extended the strike length by 300 m and confirmed the down dip extension of the La Chicharra deposit to at least 400 m.

Nineteen holes totalling 1,700 m of in-fill drilling were completed in the crusher area and, of this total, 341 m in three drill holes were completed during the 2007 drilling program. This portion of the drilling program was designed to increase the confidence of the previously identified mineralized area by increasing the drilling density to be able to classify this material as a mineral resource. The three new holes did not represent a material change in this area.

Granite and gabbro are exposed along 400 m of the south wall of the San Francisco pit and, as these rock types are two of the principal hosts of the gold-bearing veins and veinlets, a total of six drill holes were drilled in this area. The six drill holes totalled 450 m and were drilled to test the down dip extent of the gold mineralization found in this area.

Alio conducted a block model analysis of the San Francisco deposit and identified at least five zones where the drill hole density was not sufficient to satisfy the confidence levels for either an indicated or measured resource. Based on this information, Alio selected the two zones (Southeastern and Polvorines) which were recognized as being the most prospective for upgrading the resources from inferred to an indicated or measured category.

Two drill holes were completed southeast of the present pit adjacent to the waste dumps in order to confirm the presence of gold mineralization intersected by previous operators. Both holes were successful in outlining the gold mineralization further in this area

Two drill holes were drilled southwest of the San Francisco pit in the Polvorines area. The two holes were successful in increasing drill hole density and mineral resource confidence level in this area.

An 11-hole condemnation drilling program totalling 1,327 m was completed in the area west of the present leach pads. An area 500 m by 500 m was identified as being suitable for locating the future heap pads and/or operating facilities.

Between 2008 and 2010, Alio's exploration programs focused on determining the drill priorities which best achieved its aim of increasing the mineral resources in the areas near the San Francisco and La Chicharra pits, in the area between the two pits and in geochemically anomalous areas along the projection of the San Francisco mineral trend to the northwest. As well, exploration targets to the north of the igneous-metamorphic package were investigated.

During the period from 2008 to the end of July, 2010, a total of 57,753 m in 613 drill holes were completed. Of this total, 48 holes totalling 3,723 m were exploration RAB type holes drilled in the area between the La Chicharra and San Francisco pits and 50 holes totalling 5,207 m were condemnation drilling in the area of the waste piles and new leach pads.

From July, 2010 to June, 2011, 691 RC and core holes were drilled for a total of 94,148 m. These holes were drilled to cover several objectives; most of the RC drilling and the entire core drilling were performed in and around the San Francisco pit and in June, 2011, 36 RC holes totalling 6,170 m were drilled in the northern area of the La Chicharra pit. The RC drilling included 9,817 m in 67 holes of condemnation drilling which covered two areas; the first area was to the south of the existing waste dumps with the second area to the west of the new leach pads. The negative results allowed Alio to expand the existing waste dumps to the south and the negative results to the west of the leach pads allowed for this area to be used for the stockpile of the low-grade material.

The drilling conducted within and around the San Francisco pit comprised more than 80% of the drilling undertaken between July, 2010 and June, 2011. Both the RC and core drilling in

this area indicated that the mineralization extends along strike, down-dip and occurs in new mineralized zones below of the floor of the designed pit. The results indicated that additional mineralization occurred beneath the floor of the pit as parallel repetitions of the mineralized zones located in the pit, with a vertical extension of at least 200 m, continuing beyond the current pit limits. Due to the positive results, a third core drill was added to the program.

Figure 10.4 and Figure 10.5 show cross-sections 580 W and 800 W, indicating the parallel zones and extensions of the mineralization beneath the San Francisco pit between July, 2010 and June, 2011.

In the area, north of the La Chicharra pit, 6,170 m of drilling in 36 RC holes identified the extension of the mineral deposit in the down-dip direction for a distance of almost 250 m.

Figure 10.6 shows the location of the drilling between July, 2010 and June, 2011 surrounding the San Francisco and La Chicharra pits, including condemnation drilling.

From July, 2011 to June, 2013, 1,464 RC and core holes were drilled for a total of 327,853 m. Most of the drilling was undertaken in and around the San Francisco pit and the La Chicharra pit. The RC drilling included 13,219 m in 62 holes of condemnation drilling and 3,842 m in 20 holes for water monitoring. A further 8 RC holes totalling 107 m were drilled on the low-grade stockpile for grade control purposes.

The drilling conducted within and around the San Francisco and La Chicharra pits comprised more than 92.8% of the drilling undertaken between July, 2011 and June, 2013. Both the RC and core drilling in these areas identified the extent of the mineralization along strike, as well as the extent down-dip, which remains open.

The in-fill and exploration holes in and around the San Francisco pit totalled 141,073 m of RC drilling in 650 holes and 10,052 m in 20 core holes. These holes were conducted to confirm and explore the extent of the mineralization at the San Francisco pit. In that regard, the program was successful in outlining the extent of the exploration in and around the pit. Drilling was completed at the pit area so that future drilling could be regarded as more of an in-fill drilling exercise rather than true exploration drilling. Figure 10.7 shows the locations of the holes drilled in the San Francisco pit area between July, 2011 and June, 2013.

Figure 10.8 and Figure 10.9 show cross-sections 220 W and 480 W, indicating the parallel zones and extensions of the mineralization identified beneath the San Francisco pit between July, 2011 and June, 2013.

**Figure 10.4**  
**Cross- Section 580W on the San Francisco Pit**

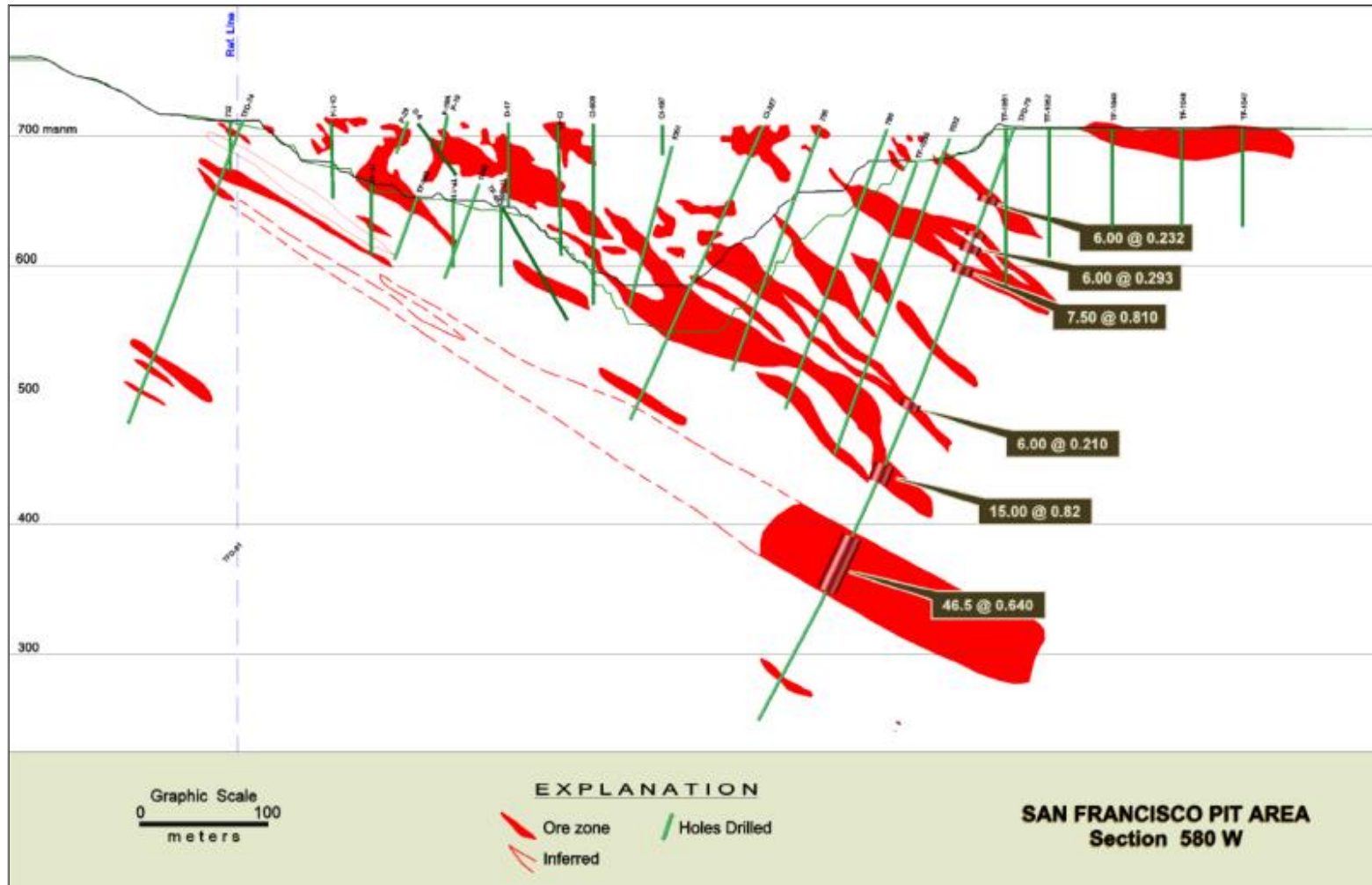


Figure provided by Alio Gold Inc. for the November, 2011 Technical Report.

**Figure 10.5**  
**Cross-Section 800W on the San Francisco Pit**

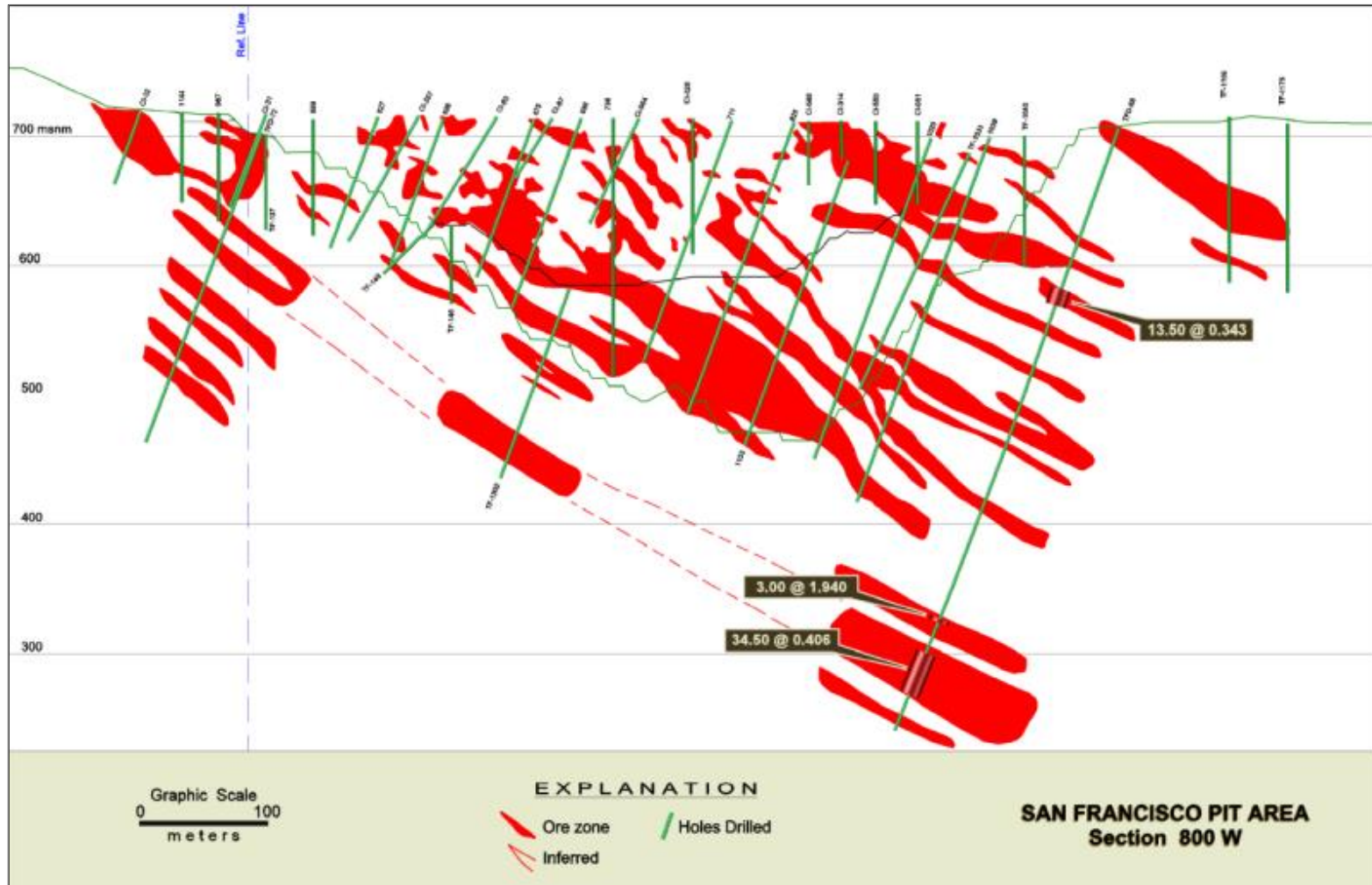


Figure provided by Alio Gold Inc. for the November, 2011 Technical Report.



**Figure 10.6**  
July, 2010 to June, 2011 Drill Hole Location Map Around the San Francisco and La Chicharra Pits, including Condemnation Drilling

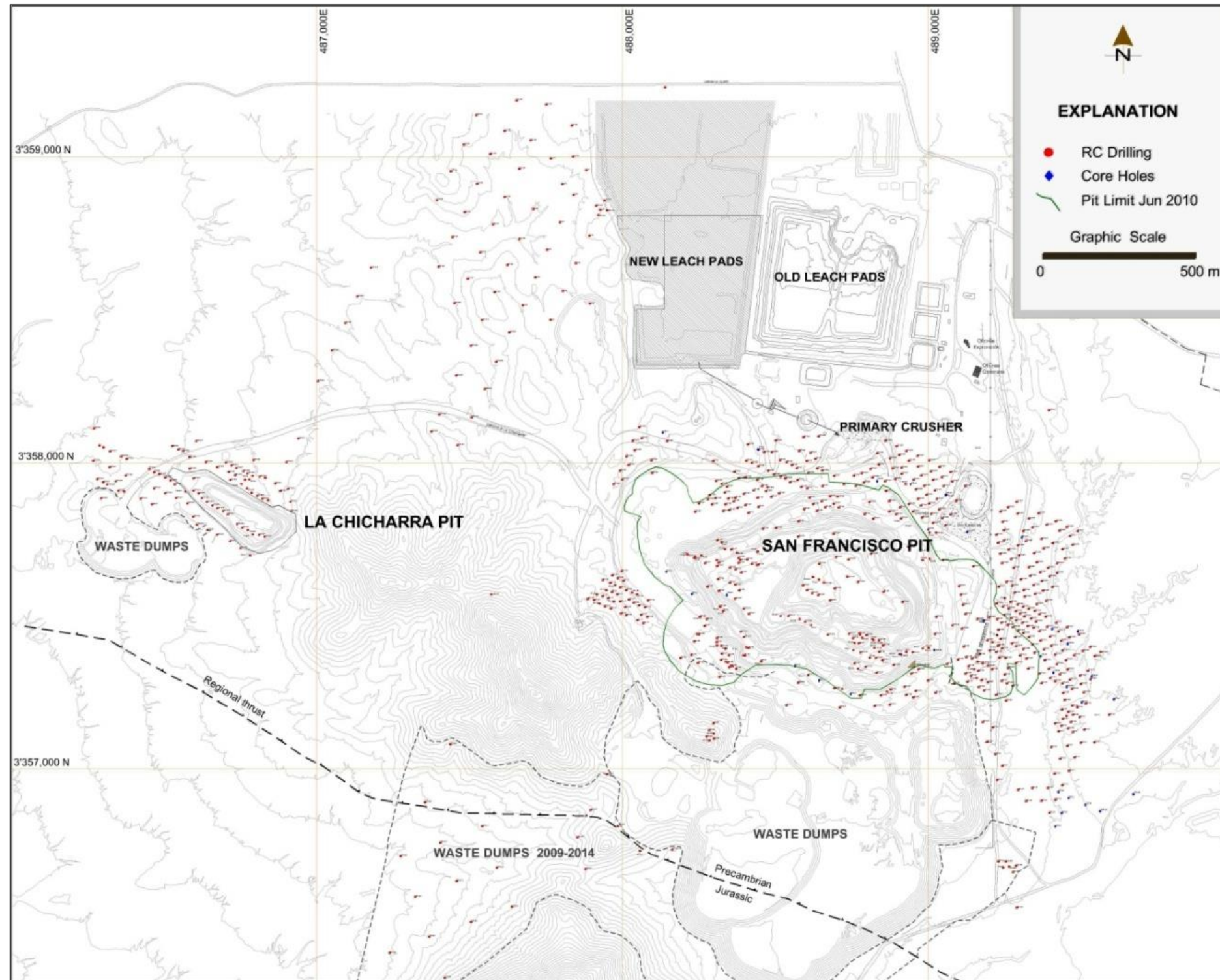


Figure provided by Alio Gold Inc. for the November, 2011 Technical Report.

**Figure 10.7**  
**July, 2011 to June, 2013 Drill Hole Location Map on the San Francisco Pit**

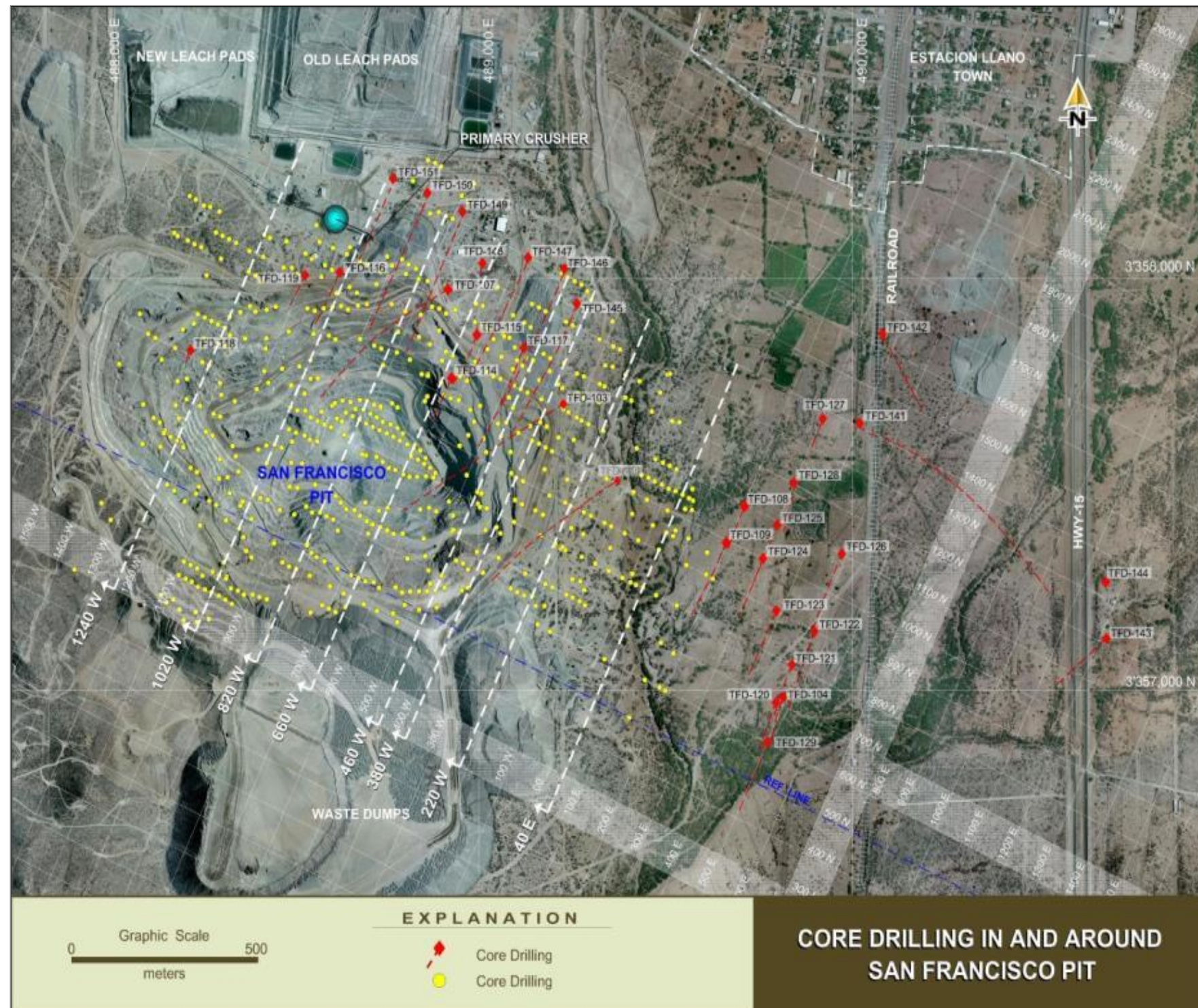


Figure provided by Alio Gold Inc., Figure dated September, 2013.

**Figure 10.8**  
**Cross-Section 220W on the San Francisco Pit**

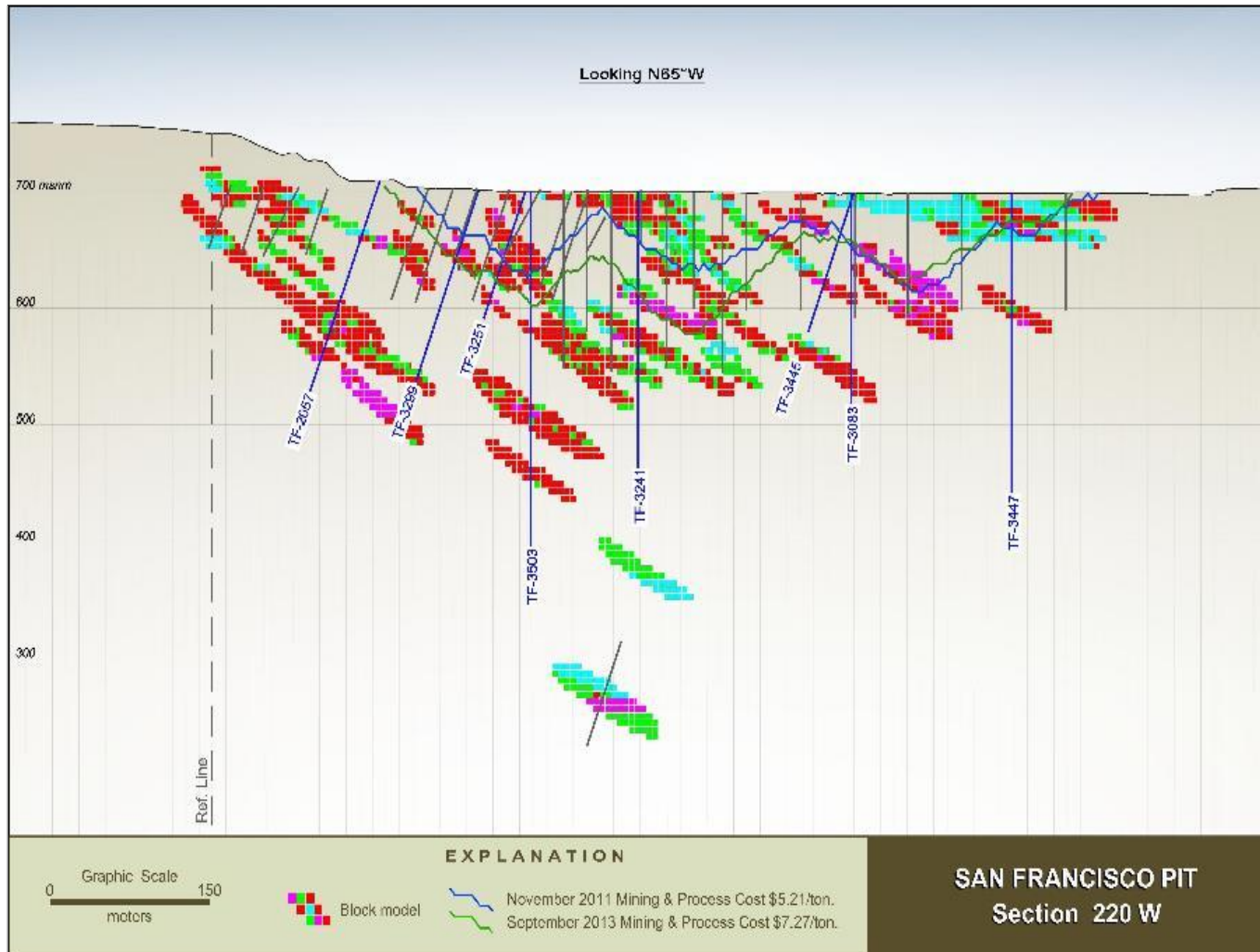


Figure provided by Alio Gold Inc., Figure dated September, 2013.

From July, 2011 to June, 2013, 640 holes totalling 141,314 m, including core and reverse circulation, were drilled in the La Chicharra pit and in the area surrounding the La Chicharra pit. The objectives were to conduct an in-fill drill program to upgrade the inferred mineral resource in the original block model to measured or indicated resources, and to potentially add to the mineral resources. The exploration program was successful in outlining the extent of the mineralization and upgrading the resource estimation at the La Chicharra pit and surrounding area.

The La Chicharra drill campaign for 2011 and a portion of 2012 focused on the area to the north of the existing pit and within the pit. This campaign was generally in-fill drilling to upgrade the existing inferred resource to indicated or measured resources. Based upon this program and the analysis of previous drilling campaign results, the drilling was extended, to the east-southeast and to the west-northwest. In the east-southeast direction, the mineralized zone is spotty and is restricted to narrow intervals with erratic gold values. In general, the results of the programs allowed the resources to be successfully upgraded to indicated and measured resources and for mine planning to be conducted.

Figure 10.10 shows the distribution of the drill holes conducted during the period from July, 2011 to June, 2013 in the La Chicharra pit and in the surrounding area. There was no drilling done, between March, 2013 and June, 2013 and the dates July, 2011 to June, 2013 refer to the period covered by the Technical Reports, rather than the actual periods during which drilling was conducted.

Figure 10.11 and Figure 10.12 illustrate cross-sections 2540W and 2780 W, along with the block model and the limits of the mineralization for 2011 and 2013.

Where extensions of the known mineralization were expected to be encountered around the San Francisco and La Chicharra pits, only RC and core drilling were conducted with these drilling results were used for resource estimation at the mine.

From the beginning of the drilling programs in 2005, recoveries of the drilling material have been good, with RAB drilling recoveries being better than 90%, RC drilling recoveries better than 95% and core drilling better than 98%.

Figure 10.9  
Cross-Section 480W on the San Francisco Pit

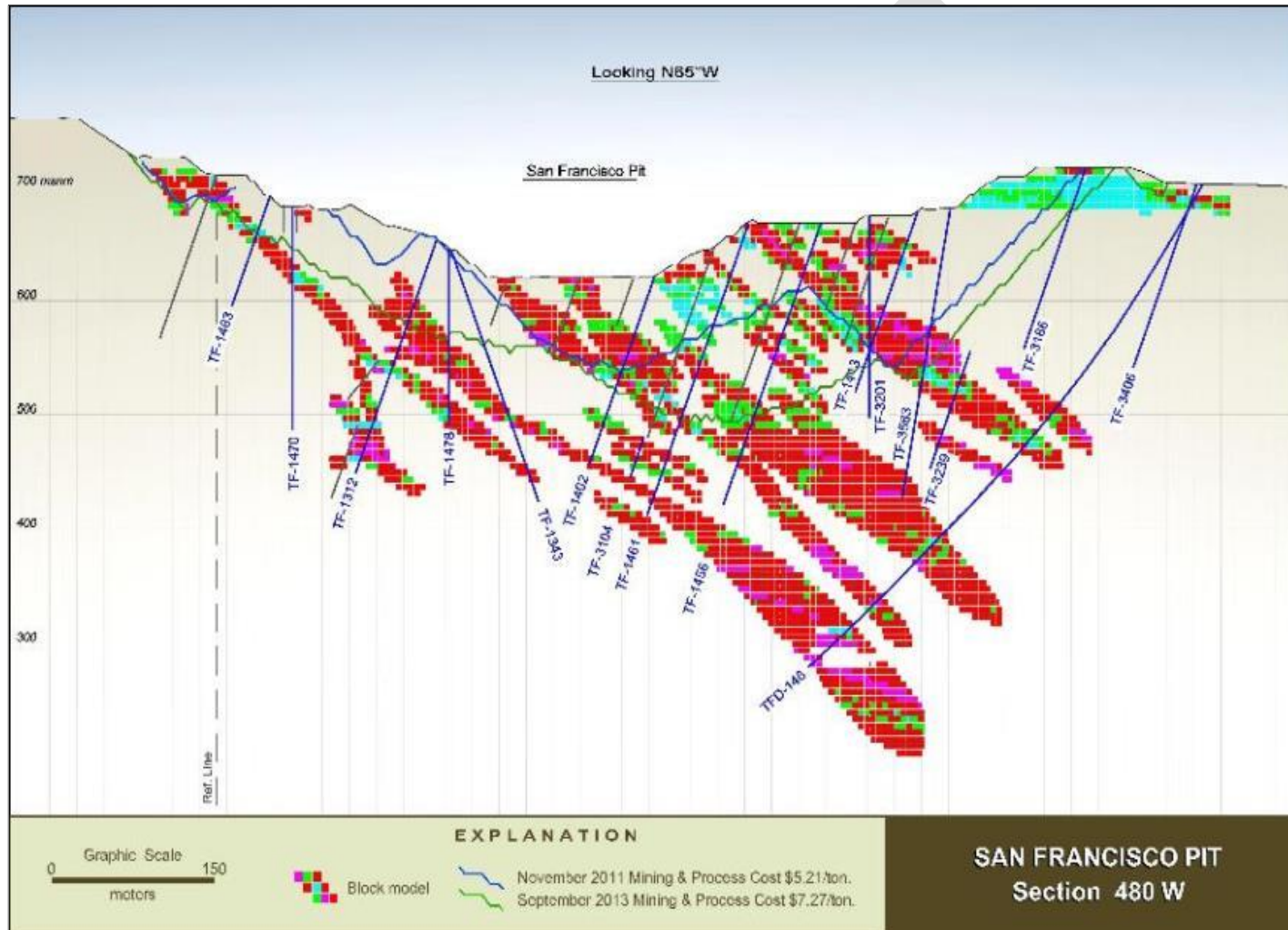


Figure provided by Alio Gold Inc., Figure dated September, 2013.

**Figure 10.10**  
**Location Drill Map in the La Chicharra Area**



Figure provided by Alio Gold Inc., and dated September, 2013

**Figure 10.11**  
**Section 2540W in the La Chicharra Pit**

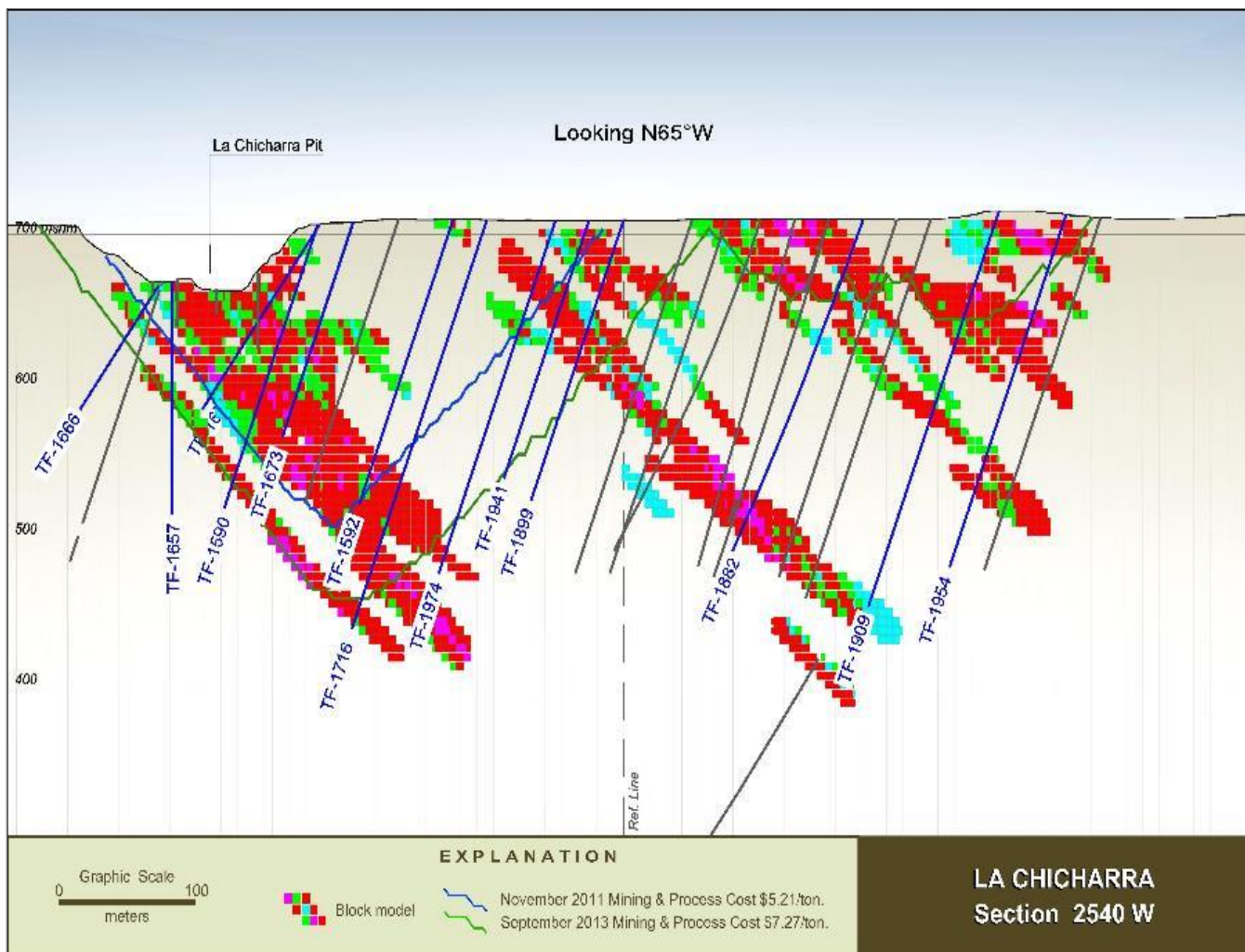


Figure provided by Alio Gold Inc., and dated September, 2013.

Figure 10.12  
Section 2780W on the La Chicharra Pit

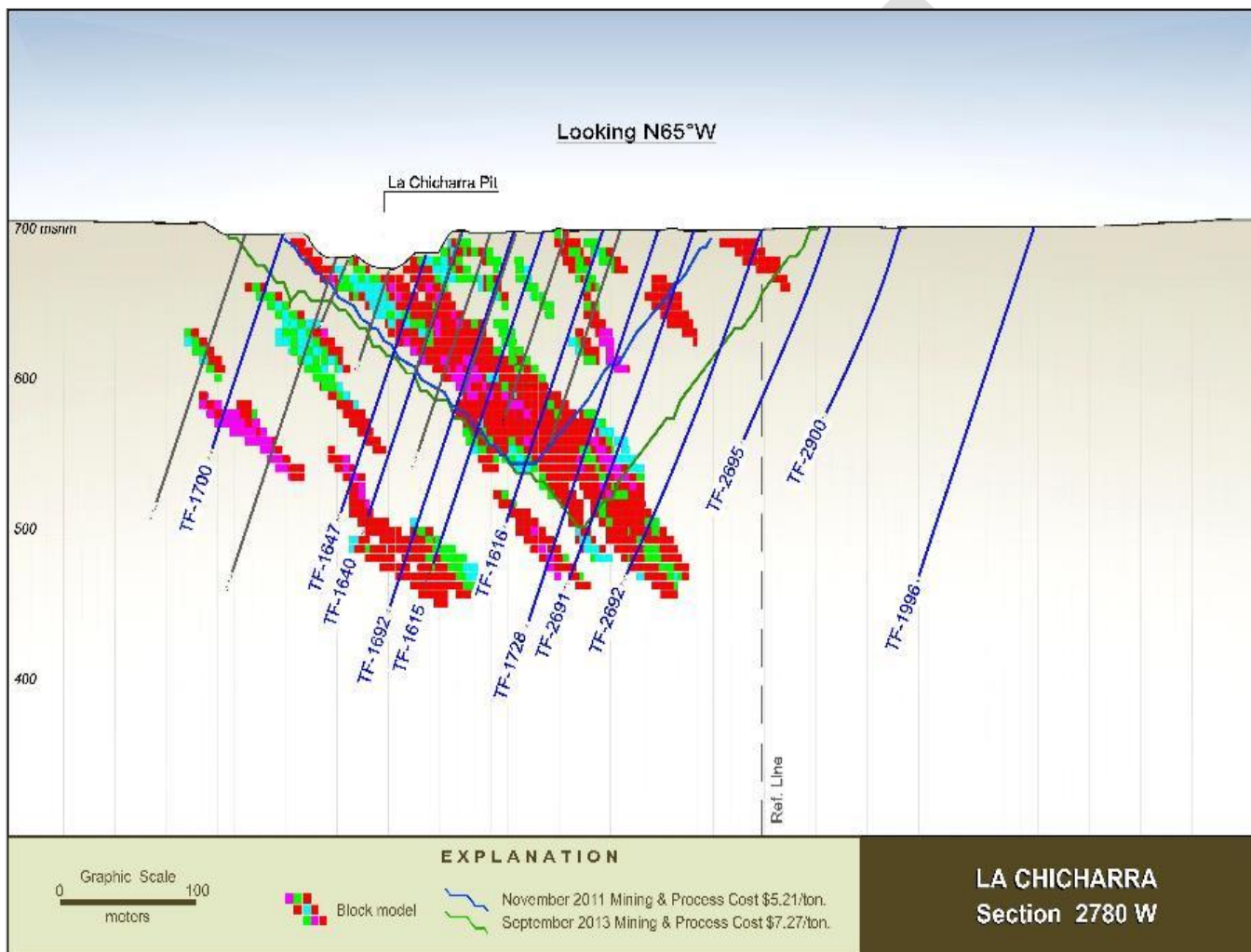


Figure provided by Alio Gold Inc. and dated September, 2013.



## **10.4 EXPLORATION AND IN-FILL DRILLING 2014 TO 2015 AT THE SAN FRANCISCO MINE**

A total of 6,783.75 m in 63 RC holes were drilled between 2014 and 2015 as part of the San Francisco mine in-fill drilling program on Phase 3, Phase 4 East and Phase 4 down. The aim of both drill programs was to confirm the gold mineralization in the short term mine plan, as well as to reduce the drilling spacing and confirm the mineralization reported by the historical drill holes.

An exploration/in-fill drill program (Phase 5) was executed on the south wall of the San Francisco pit with the aim of exploring the continuity of the gold mineralization below Phase 3. An in-fill drill program on the south wall was also conducted to partly identify the extent of the high-grade gold mineralization related to two main structures that could potentially be extracted using underground mining methods. Thirty-one RC holes totalling 4,376.92 m and 20 core holes totalling 2,185.30 m were drilled on south wall of the San Francisco pit.

In 2014, a program of RC condemnation drilling was conducted on the western side of the existing leach pads. The program consisted of 21 holes totalling 3,642 m. The assay results for this program did not indicate any economic gold intersections in this area.

Figure 10.13 is a plan view of the various in-fill drilling programs conducted within the San Francisco pit during 2014. Figure 10.14 is a location plan of the RC condemnation drilling.

### **10.4.1 2014 In-fill RC Drilling on Phase 3 from Bench 530**

Fifteen RC drill holes on Phase 3 were distributed along a strike distance of 160 m spaced every 20 m from Section 660W to Section 820W at the bottom of the San Francisco pit, on benches 530 to 536. The program totalled 1,100 m and Table 10.1 summarizes the location and significant assays for the RC drilling on Phase 3 from benches 530 to 536.

Figure 10.13  
Plan View of the Various 2014 In-fill Drilling Programs within the San Francisco Pit

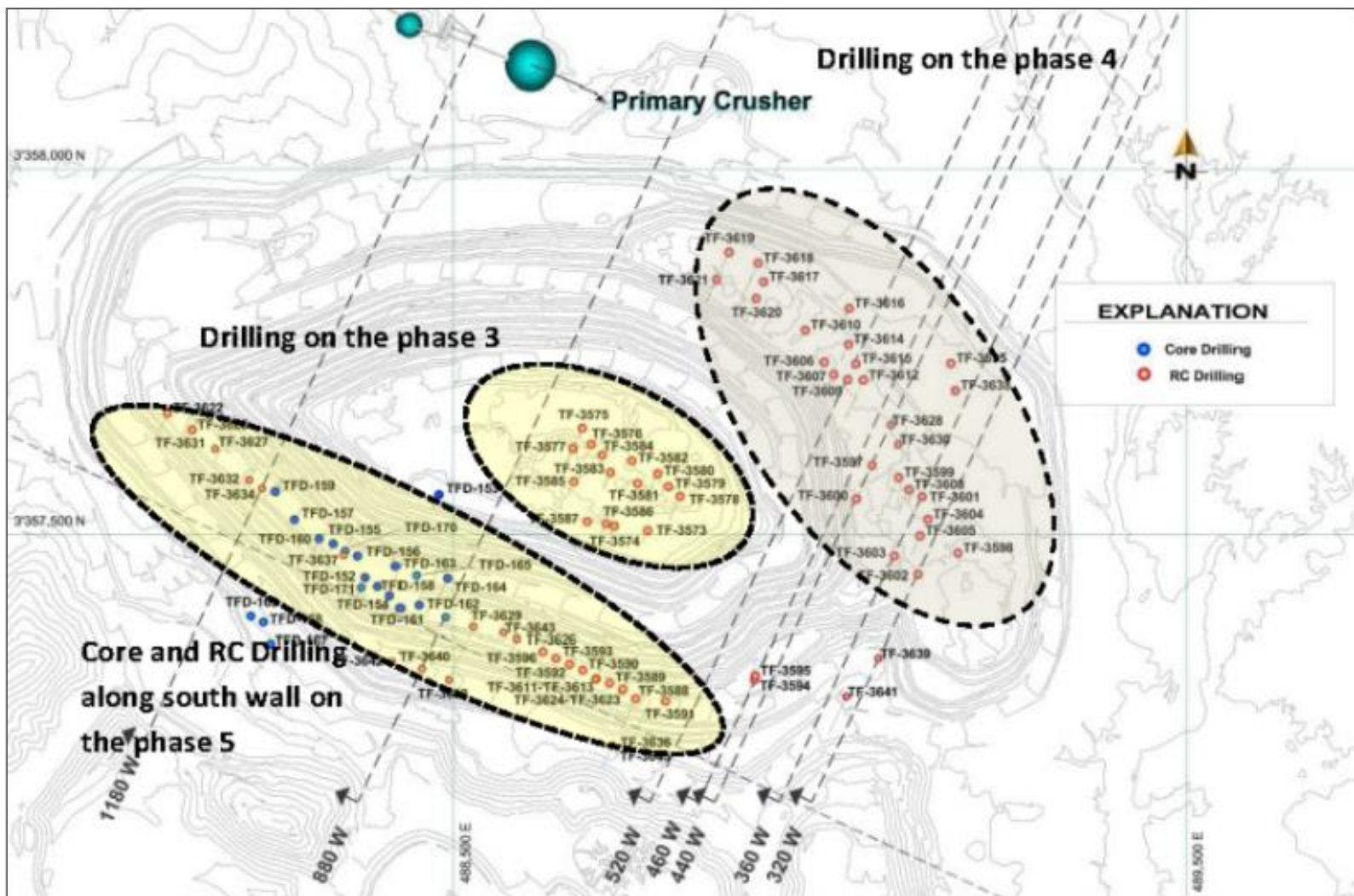


Figure provided by Alio Gold Inc. Figure dated February, 2016.

**Figure 10.14**  
**Location Plan of the 2014 Condemnation Drilling Program**



Figure provided by Alio Gold Inc. Figure dated February, 2016.

**Table 10.1**  
**Summary of the Location and Significant Assays for the RC Drilling on Phase 3 from Bench 530 to 536**

Drill Hole Number	Depth (m)	Angle (°)	Az (°)	Section Line	North Coordinate	Bench (Elev)	Mineral Drill Intersections				
								From (m)	To (m)	True Width (m)	Au (g/t)
TF-3573	51.82	-70	205	680 W	750	536		0.00	12.19	12.19	0.601
							including	9.14	10.67	1.52	2.021
								15.24	16.76	1.52	0.155
								25.91	27.43	1.52	12.400
							48.77	51.82	3.05	0.368	
TF-3574	51.82	-70	205	720 W	725	536		25.91	27.43	1.52	0.877
TF-3575	82.30	-70	205	820 W	835	536		0.00	1.52	1.52	0.326
								16.76	35.05	18.29	1.087
							Including	18.29	19.81	1.52	3.208
								38.10	39.62	1.52	0.154
								42.67	44.20	1.52	0.290
								45.72	48.77	3.05	0.161
	50.29	76.20	25.91	0.305							
TF-3576	70.10	-70	205	800 W	825	536		7.62	25.91	18.29	0.324
								33.53	39.62	6.10	0.853

Drill Hole Number	Depth (m)	Angle (°)	Az (°)	Section Line	North Coordinate	Bench (Elev)	Mineral Drill Intersections				
								From (m)	To (m)	True Width (m)	Au (g/t)
								44.20	56.39	12.19	0.249
								60.96	70.10	9.14	0.376
TF-3577	82.30	-70	205	820 W	810	536		0.00	35.05	35.05	0.580
								38.10	39.62	1.52	0.118
								41.15	42.67	1.52	0.848
								45.72	48.77	3.05	0.879
							including	45.72	47.24	1.52	2.022
								53.34	67.06	13.72	0.529
							including	60.96	62.48	1.52	2.092
								70.10	80.77	10.67	0.486
TF-3578	100.58	-70	205	660 W	810	536		0.00	1.52	1.52	0.261
								18.29	19.81	1.52	0.183
								30.48	32.00	1.52	0.171
								91.44	99.06	7.62	1.350
							including	96.01	97.54	1.52	2.827
TF-3579	100.58	-90	0	680 W	815	536		3.05	6.10	3.05	0.302
								22.86	39.62	16.76	2.053
							including	27.43	28.96	1.52	7.032
							including	33.53	39.62	6.10	3.378
								45.72	47.24	1.52	0.150
								48.77	56.39	7.62	<b>0.577</b>
								67.06	71.63	4.57	0.351
								77.72	79.25	1.52	0.163
TF-3580	100.58	-70	205	700 W	825	536		0.00	3.05	3.05	0.533
								12.19	13.72	1.52	0.139
								15.24	16.76	1.52	0.122
								35.05	36.58	1.52	0.156
								39.62	41.15	1.52	0.127
								44.20	45.72	1.52	0.220
								51.82	76.20	24.38	0.771
							including	53.34	54.86	1.52	2.498
								94.49	97.54	3.05	0.172
TF-3581	82.30	-70	205	720 W	802	536		4.57	6.10	1.52	0.116
								12.19	21.34	9.14	1.647
							including	12.19	15.24	3.05	5.320
								25.91	30.48	4.57	0.423
								36.58	76.20	39.62	1.236
							including	42.67	44.20	1.52	5.782
							including	54.86	57.91	3.05	2.363
							including	59.44	60.96	1.52	4.320
	65.53	68.58	3.05	2.564							
TF-3582	91.44	-90	0	740 W	825	536		0.00	21.34	21.34	0.628
							including	18.29	19.81	1.52	3.218
								28.96	30.48	1.52	0.334
								54.86	68.58	13.72	0.378
	74.68	91.44	16.76	0.547							
TF-3583	70.10	-70	205	760 W	800	536		7.62	9.14	1.52	0.987

Drill Hole Number	Depth (m)	Angle (°)	Az (°)	Section Line	North Coordinate	Bench (Elev)	Mineral Drill Intersections				
								From (m)	To (m)	True Width (m)	Au (g/t)
								28.96	36.58	7.62	0.698
								41.15	42.67	1.52	1.115
								45.72	70.10	24.38	0.527
							including	67.06	68.58	1.52	3.546
								0.00	21.34	21.34	1.058
TF-3584	70.10	-90	0	780 W	816	536	including	6.10	7.62	1.52	3.659
							including	9.14	13.72	4.57	1.469
								24.38	25.91	1.52	0.724
								41.15	42.67	1.52	0.351
								45.72	70.10	24.38	0.491
							including	68.58	70.10	1.52	2.804
								0.00	22.86	22.86	0.423
TF-3585	60.96	-70	205	800 W	765	536		47.24	57.91	10.67	2.166
							including	51.82	53.34	1.52	10.700
							including	54.86	57.91	3.05	3.704
								6.10	10.67	4.57	10.903
TF-3586	42.67	-70	205	740 W	732	536	including	6.10	9.14	3.05	16.122
								30.48	33.53	3.05	2.175
							including	30.48	32.00	1.52	3.005
								10.67	12.19	1.52	0.307
TF-3587	42.67	-90	0	760 W	725	536		39.62	41.15	1.52	1.684

Table provided by Alio Gold Inc.

#### 10.4.2 2014 In-fill RC Drilling on Phase 4 from Bench 650

A drilling program was initiated on Phase 4 with the same objectives as the previous program on benches 530 to 536. The drill program consisted of 27 RC holes totalling 3,547 m which were distributed from Section 280W to Section 740W on bench 650.

Table 10.2 summarizes the location and significant assays for this drilling. The table contains all of the mineral intersections on Phase 4 east, as this completes the overview of the results from the drilling during November, 2014. The results confirmed that the mineralization is in agreement with the existing block model and results of the July, 2013 resource estimation for that portion of the San Francisco deposit.

**Table 10.2**  
**Summary of the Location and Significant Assays for the RC Drilling on Phase 4 from Bench 650**

Drill Hole Number	Depth (m)	Angle (°)	Az (°)	Section Line	North Coordinate	Bench (Elev)	Mineral Drill Intersections				
								From (m)	To (m)	True Width (m)	Au (g/t)
TF-3597	121.92	70	205	440W	960	650		15.24	16.76	1.52	0.271
								50.29	51.82	1.52	0.401
								91.44	100.58	9.14	0.410
								106.68	109.73	3.05	0.442

Drill Hole Number	Depth (m)	Angle (°)	Az (°)	Section Line	North Coordinate	Bench (Elev)	Mineral Drill Intersections				
								From (m)	To (m)	True Width (m)	Au (g/t)
TF-3598	170.69	90	0	280W	900	650		18.29	24.38	6.10	0.201
								35.05	48.77	13.72	0.907
							including	38.10	39.62	1.52	2.133
								108.20	112.78	4.57	0.941
								126.49	131.06	4.57	0.235
							including	146.30	149.35	3.05	6.451
TF-3599	124.97	70	205	400W	960	650		21.34	22.86	1.52	0.217
								36.58	41.15	4.57	0.312
TF-3600	131.06	70	205	440W	910	650		1.52	22.86	21.34	0.736
							including	1.52	3.05	1.52	4.025
							including	13.72	15.24	1.52	3.177
								36.58	38.10	1.52	0.275
TF-3601	91.44	70	205	360W	950	650		88.39	97.54	9.14	0.332
								22.86	24.38	1.52	0.214
								56.39	67.06	10.67	1.506
TF-3602	70.10	80	205	320W	850	650	including	62.48	64.01	1.52	8.887
								54.86	56.39	1.52	0.265
TF-3603	109.73	70	205	360W	860	650		65.53	67.06	1.52	0.242
								9.14	10.67	1.52	0.225
TF-3604	91.44	90	0	340W	925	650		16.76	18.29	1.52	2.062
								91.44	94.49	3.05	0.204
								105.16	108.20	3.05	0.325
TF-3605	82.3	70	205	340W	900	650		19.81	24.38	4.57	0.364
								42.67	50.29	7.62	0.422
TF-3606	131.06	70	205	560W	1060	650		0.00	3.05	3.05	0.609
								21.34	27.43	6.10	0.464
								9.14	15.24	6.10	0.283
								27.43	28.96	1.52	0.564
								32.00	45.72	13.72	1.019
							including	33.53	38.10	4.57	2.953
								54.86	59.44	4.57	0.877
TF-3607	91.44	70	205	540W	1050	650		70.10	73.15	3.05	0.623
								88.39	89.92	1.52	0.202
								12.19	21.34	9.14	0.503
								24.38	28.96	4.57	0.688
TF-3608	100.58	70	205	380W	950	650		39.62	53.34	13.72	0.830
								79.25	80.77	1.52	0.281
								19.81	21.34	1.52	0.216
TF-3609	94.49	90	0	520W	1050	650		45.72	53.34	7.62	0.262
								77.72	79.25	1.52	0.544
								94.49	96.01	1.52	0.232
								0.00	1.52	1.52	0.294
								12.19	13.72	1.52	0.298
								18.29	47.24	28.96	3.529

Drill Hole Number	Depth (m)	Angle (°)	Az (°)	Section Line	North Coordinate	Bench (Elev)	Mineral Drill Intersections				
								From (m)	To (m)	True Width (m)	Au (g/t)
							including	25.91	27.43	1.52	3.149
							including	41.15	42.67	1.52	37.100
TF-3610	91.44	90	0	600W	1090	650		59.44	88.39	28.96	0.378
TF-3612	170.69	70	205	500W	1060	650		15.24	19.81	4.57	0.222
								24.38	25.91	1.52	0.212
								33.53	35.05	1.52	0.202
								39.62	45.72	6.10	0.269
								53.34	54.86	1.52	0.262
								57.91	59.44	1.52	0.251
								94.49	99.06	4.57	0.411
								114.30	115.82	1.52	0.276
								121.92	124.97	3.05	0.268
							167.64	170.69	3.05	0.314	
TF-3614	91.44	75	205	540W	1100	650		24.38	33.53	9.14	0.484
								50.29	53.34	3.05	0.268
								65.53	77.72	12.19	1.979
							including	68.58	70.10	1.52	4.234
							including	74.68	76.20	1.52	8.049
TF-3615	124.97	90	0	520W	1075	650		18.29	27.43	9.14	1.258
							including	22.86	25.91	3.05	3.422
								39.62	53.34	13.72	1.317
							including	47.24	48.77	1.52	5.302
							including	50.29	51.82	1.52	2.149
								59.44	60.96	1.52	0.525
								108.20	109.73	1.52	1.311
TF-3616	121.92	85	205	560W	1140	662		45.72	48.77	3.05	0.372
								74.68	80.77	6.10	0.654
								92.96	105.16	12.19	0.976
							including	97.54	99.06	1.52	4.255
TF-3617	152.4	90	0	680W	1125	650		10.67	12.19	1.52	0.326
								22.86	24.38	1.52	0.536
								79.25	83.82	4.57	1.441
							including	79.25	80.77	1.52	3.532
								88.39	89.92	1.52	0.429
								91.44	92.96	1.52	0.284
TF-3618	161.54	-70	205°	700W	1150	650		22.86	24.38	1.52	0.232
								28.96	32.00	3.05	0.442
								68.58	83.82	15.24	5.353
							including	71.63	73.15	1.52	51.600
								89.92	91.44	1.52	0.251
								123.44	129.54	6.10	0.446
								138.68	140.21	1.52	0.913
	155.45	161.54	6.10	0.681							
TF-3619	210.31	-70	205	740W	1140	650		77.72	80.77	3.05	0.264
								86.87	92.96	6.10	0.873
							including	89.92	91.44	1.52	2.281

Drill Hole Number	Depth (m)	Angle (°)	Az (°)	Section Line	North Coordinate	Bench (Elev)	Mineral Drill Intersections				
							From (m)	To (m)	True Width (m)	Au (g/t)	
								96.01	103.63	7.62	0.228
								129.54	132.59	3.05	0.192
								138.68	141.73	3.05	0.967
								160.02	161.54	1.52	0.992
								166.12	181.36	15.24	0.458
TF-3620	219.46	-80	205	680W	1100	650		7.62	9.14	1.52	0.258
								51.82	53.34	1.52	0.895
								57.91	62.48	4.57	0.947
								65.53	68.58	3.05	0.336
								77.72	82.30	4.57	0.357
								121.92	123.44	1.52	0.669
								129.54	134.11	4.57	0.207
								149.35	152.40	3.05	0.190
								173.74	178.31	4.57	0.366
								195.07	196.60	1.52	0.387
TF-3621	131.06	-75	205	740W	1100	650		202.69	204.22	1.52	1.744
								36.58	39.62	3.05	1.559
							including	36.58	38.10	1.52	2.713
								59.44	74.68	15.24	0.313
								83.82	86.87	3.05	1.105
								99.06	103.63	4.57	0.422
	109.73	112.78	3.05	0.865							

Table provided by Alio Gold Inc.

### 10.4.3 Exploration and In-fill Drilling along the South Wall of the San Francisco Pit, Phase 5

Two drilling programs were conducted along the south wall of the San Francisco pit, with both derived from the proposal to conduct underground mining on certain high-grade gold zones which were identified below the design pit shell.

The first program consisted of an RC drilling campaign totalling 4,376.92 m, distributed over 31 holes, to determine if there was sufficient mineralization to justify a pushback of the pit wall in a southerly direction in this area.

The holes were drilled from Section 460W to 1340 W, with the spacing dependent on the location of the previous drilling along the south wall. The significant results for this drilling program are summarized in Table 10.3.

In addition to the significant intersections encountered, there are a number of other mineralized intersections identified in the drill holes but they are either low-grade intersections or very narrow zones of high-grade.



**Table 10.3**  
**Summary of the Location and Significant Assays for the RC Drilling on Phase 5 between Sections 880W to 1160W**

Drill Hole Number	Depth (m)	Angle (°)	Az (°)	Section Line	North Coordinate	Bench (Elev)	Mineral Drill Intersections				
								From (m)	To (m)	True Width (m)	Au (g/t)
TF-3588	131.06	70	205	600 W	540	669		16.76	18.29	1.52	0.347
								39.62	41.15	1.52	0.323
								70.10	71.63	1.52	0.398
								73.15	74.68	1.52	0.268
								86.87	88.39	1.52	0.838
								112.78	114.30	1.52	0.225
								123.44	124.97	1.52	0.545
TF-3589	109.73	90	0	640 W	540	665		10.67	16.76	6.10	0.742
							including	12.19	13.72	1.52	3.688
								27.43	28.96	1.52	0.230
								57.91	60.96	3.05	0.865
TF-3590	131.06	90	0	680 W	540	661		1.52	7.62	6.10	0.645
								54.86	59.44	4.57	0.212
								65.53	67.06	1.52	0.206
TF-3591	170.69	90	0	560 W	550	674		22.86	25.91	3.05	0.432
								54.86	65.53	10.67	0.610
							including	54.86	56.39	1.52	2.724
TF-3592	152.4	90	0	700 W	540	660		62.48	64.01	1.52	0.554
								71.628	76.2	4.57	0.235
								79.25	80.77	1.52	0.417
TF-3593	192.02	90	0	720W	540	657		1.52	4.57	3.05	0.204
								18.29	22.86	4.57	0.223
								73.15	76.20	3.05	0.258
								88.39	99.06	10.67	0.728
							including	89.92	91.44	1.52	2.878
								105.16	106.68	1.52	0.807
TF-3594	140.21	80	205	460W	640	676		16.76	18.29	1.52	0.272
								45.72	59.44	13.72	7.999
							including	45.72	48.77	3.05	42.587
							including	53.34	54.86	1.52	2.104
								67.06	70.10	3.05	0.326
								96.01	100.58	4.57	0.317
TF-3595	182.88	75	25	460W	640	676		1.52	3.05	1.52	0.273
								6.10	9.14	3.05	0.293
								18.29	25.91	7.62	0.356
								89.92	108.20	18.29	0.599
								129.54	156.97	27.43	1.420
							including	129.54	131.06	1.52	2.274
							including	132.59	137.16	4.57	3.585
							including	150.88	153.92	3.05	2.684
	161.54	164.59	3.05	0.464							

Drill Hole Number	Depth (m)	Angle (°)	Az (°)	Section Line	North Coordinate	Bench (Elev)	Mineral Drill Intersections			
							From (m)	To (m)	True Width (m)	Au (g/t)
							173.74	176.78	3.05	0.748
TF-3596	140.208	90	0	740W	540	656	0.00	1.52	1.52	0.527
							12.19	13.72	1.52	0.233
							38.10	39.62	1.52	0.342
							71.63	73.15	1.52	0.943
							79.25	82.30	3.05	0.430
TF-3611	121.92	90	0	660W	540	663	4.57	6.10	1.52	1.099
							36.58	38.10	1.52	0.351
							45.72	48.77	3.05	0.250
							56.39	62.48	6.10	0.334
TF-3613	131.06	70	25	660W	540	662	13.72	15.24	1.52	0.316
							70.10	73.15	3.05	0.879
							79.25	88.39	9.14	0.377
							109.73	112.78	3.05	0.899
							117.35	120.40	3.05	0.894
							129.54	131.06	1.52	1.695
TF-3622	109.73	-70	205	1340W	620	662	19.81	21.34	1.52	0.331
							22.86	24.38	1.52	0.203
							30.48	33.53	3.05	0.288
							71.63	73.15	1.52	0.205
							86.87	89.92	3.05	0.320
TF-3623	128.02	-70	25	620W	540	668	99.06	102.11	3.05	0.418
							105.16	108.20	3.05	0.284
							126.49	128.02	1.52	0.276
TF-3624	121.92	-90	0	620W	540	668	38.10	39.62	1.52	0.330
							56.39	59.44	3.05	0.278
							73.15	76.20	3.05	0.247
TF-3625	121.92	-85	25	1300W	610	660	22.86	33.53	10.67	0.289
							59.44	62.48	3.05	0.871
							83.82	85.34	1.52	0.404
							112.78	114.30	1.52	0.551
TF-3626	185.93	-85 651.564	205 540N	780W	540	652	0.00	7.62	7.62	0.200
							53.34	64.01	10.67	0.321
							67.06	70.10	3.05	0.415
							73.15	76.20	3.05	0.218
							96.01	97.54	1.52	0.228
							115.82	118.87	3.05	0.250
							167.64	169.16	1.52	0.371
TF-3627	100.58	-90 655.65	0 600N	1260W	600	656	0.00	6.10	6.10	0.206
							24.38	25.91	1.52	0.231
							33.53	41.15	7.62	0.640
							44.20	45.72	1.52	0.229
							50.29	51.82	1.52	0.310
							60.96	64.01	3.05	0.275
							73.15	80.77	7.62	1.548

Drill Hole Number	Depth (m)	Angle (°)	Az (°)	Section Line	North Coordinate	Bench (Elev)	Mineral Drill Intersections				
								From (m)	To (m)	True Width (m)	Au (g/t)
TF-3631	152.4	-60 659.24	25 610N	1300W	610	660	including	73.15	74.68	1.52	3.804
								88.39	94.49	6.10	0.303
								19.81	21.34	1.52	0.316
								36.58	39.62	3.05	0.231
								80.77	85.34	4.57	0.298
								89.92	94.49	4.57	0.327
								100.58	103.63	3.05	0.214
TF-3632	170.69	-80 648.76	25 580N	1200W	580	650		112.78	115.82	3.05	0.265
								0.00	1.52	1.52	0.247
								27.43	30.48	3.05	0.438
								44.20	48.77	4.57	0.208
								71.63	73.15	1.52	0.202
								80.77	88.39	7.62	1.086
							including	85.34	86.87	1.52	2.490
TF-3634	170.69	-70 646.22	205 580N	1180W	580	650		131.06	134.11	3.05	1.017
								152.40	153.92	1.52	0.851
								3.05	6.10	3.05	0.303
								33.53	41.15	7.62	2.351
							including	33.53	36.58	3.05	4.648
								59.44	74.68	15.24	0.604
							including	59.44	60.96	1.52	2.067
TF-3636	100.58	-70 713.89	205 470N	600W	470	712		115.82	118.87	3.05	0.479
								169.16	170.69	1.52	0.227
								3.05	4.57	1.52	0.224
								18.29	27.43	9.14	0.205
TF-3637	152.4	-70 632.02	25 540N	1040W	540	632		36.58	38.10	1.52	0.590
								0.00	1.52	1.52	0.234
								4.57	7.62	3.05	0.384
								18.29	19.81	1.52	0.418
								38.10	44.20	6.10	0.759
							including	41.15	42.67	1.52	2.296
								68.58	70.10	1.52	0.230
								73.15	74.68	1.52	0.217
								85.34	86.87	1.52	0.448
TF-3638	140.21	-70 697.56	25 450N	840W	450	696		147.83	150.88	3.05	0.282
								35.05	36.58	1.52	0.569
								44.20	45.72	1.52	0.747
								88.39	89.92	1.52	0.240
								96.01	103.63	7.62	0.270
								126.49	129.54	3.05	0.295
TF-3639	100.58	-90 703.96	0 725N	320W	725	704		137.16	138.68	1.52	0.498
								1.52	4.57	3.05	0.466
								32.00	47.24	15.24	0.610
								65.53	67.06	1.52	0.357
	74.68	77.72	3.05	0.244							

Drill Hole Number	Depth (m)	Angle (°)	Az (°)	Section Line	North Coordinate	Bench (Elev)	Mineral Drill Intersections				
								From (m)	To (m)	True Width (m)	Au (g/t)
								82.30	85.34	3.05	1.394
							including	82.30	83.82	1.52	2.672
								91.44	94.49	3.05	3.703
							including	91.44	92.96	1.52	7.253
TF-3640	121.92	-90 692.84	0 450N	880W	450	692		18.29	19.81	1.52	0.205
								44.20	60.96	16.76	0.684
							including	56.39	57.91	1.52	3.449
								97.54	99.06	1.52	0.218
								109.73	114.30	4.57	0.268
								120.40	121.92	1.52	0.493
TF-3641	161.54	-70	205	340W	660	710		33.53	35.05	1.52	0.257
								94.49	96.01	1.52	0.626
								106.68	111.25	4.57	0.361
								129.54	132.59	3.05	0.515
								135.64	140.21	4.57	0.209
								146.30	147.83	1.52	0.591
TF-3642	192.02	-90	0	920W	440	690		50.29	70.10	19.81	0.368
								97.54	106.68	9.14	0.411
								114.30	118.87	4.57	0.698
								181.36	182.88	1.52	0.206
TF-3643	152.40	-90 649.52	0 540N	800W	540	650		60.96	73.15	12.19	0.243
								77.72	86.87	9.14	0.487
								91.44	97.54	6.10	0.232
								103.63	105.16	1.52	0.262
								115.82	117.35	1.52	0.793
								124.97	126.49	1.52	0.578
TF-3644	121.92	-70	205	580W	550	672		53.34	54.864	1.52	0.363
TF-3645	140.21	-90 713.86	0 470N	600 W	470	712		25.91	27.43	1.52	0.296
								38.1	41.148	3.05	0.209
								80.772	82.296	1.52	0.200
								106.68	108.204	1.52	0.375

Table provided by Alio Gold Inc.

The second program of drilling comprised core holes conducted to explore the continuity of the high-grade mineralized zones beneath the existing surface of the south wall and beneath the final pit design. The core program consisted of 20 holes totalling 2,185.12 m located between Sections 880W and 1160W, all of which were drilled from the southern ramp access to the pit.

Figure 10.15 is the location plan view for the core drilling done on the south wall in November, 2014.

**Figure 10.15**  
**Plan View of the November, 2014 Core Drilling Program on the South Wall of the San Francisco Pit**

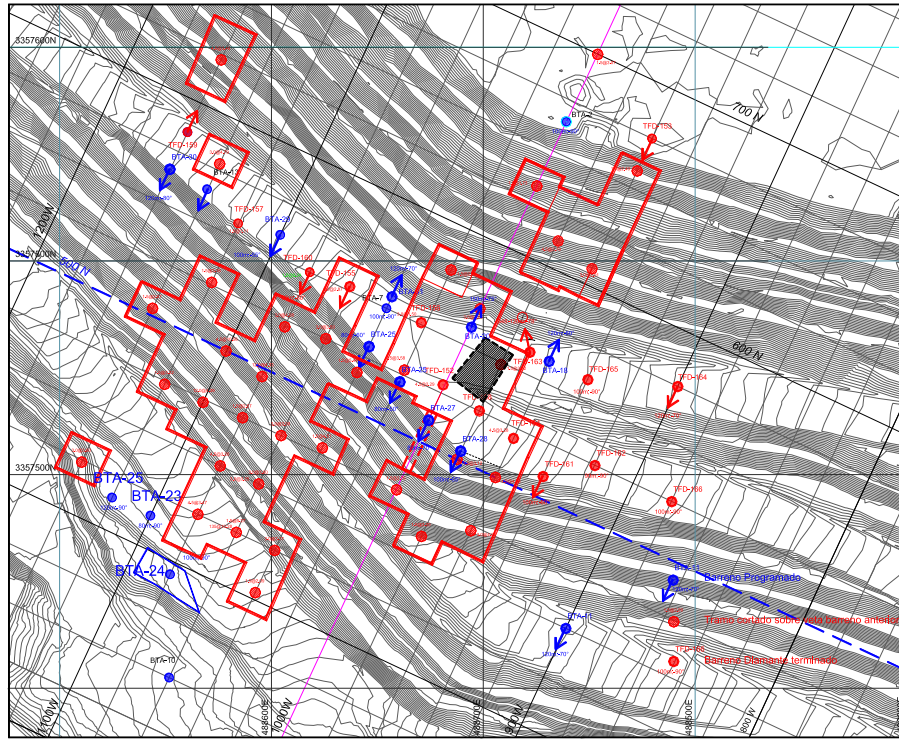


Figure provided by Alio Gold Inc. Figure dated February, 2016.

Table 10.4 summarizes the most significant gold intersection for this core drilling.

**Table 10.4**  
**Summary of the Location and Significant Assays for the Core Drilling on Phase 5 between Sections 880W to 1160W**

Drill Hole Number	Depth (m)	Angle (°)	Azimuth (°)	Elev (m.s.n.m)	Section Line	North Coordinate	Mineral Drill Intersections				
							From (m)	To (m)	True Width (m)	Au (g/t)	
TFD-152	101.00	-90	0	631.69	1000W	525	0.00	1.50	1.50	0.187	
							23.50	28.00	4.50	0.525	
							35.50	36.50	1.00	0.425	
							42.00	57.70	15.70	1.529	
							including	42.00	43.50	1.50	2.065
							including	46.50	48.00	1.50	5.677
TFD-153	61.80	-70	205	535.71	960 W	673	9.00	13.50	4.50	5.544	
							including	12.00	13.50	1.50	14.000
							16.50	19.50	3.00	0.432	
							25.70	28.30	2.60	1.066	
							45.90	50.40	4.50	0.902	
							including	52.70	59.00	6.30	0.818
including	57.05	57.55	0.50	2.396							

Drill Hole Number	Depth (m)	Angle (°)	Azimuth (°)	Elev (m.s.n.m)	Section Line	North Coordinate	Mineral Drill Intersections				
								From (m)	To (m)	True Width (m)	Au (g/t)
TFD-154	71.00	-90	0	635.21	960W	523		25.70	26.70	1.00	0.476
								33.50	36.50	3.00	0.362
								39.50	49.50	10.00	1.630
							including	41.00	45.50	4.50	3.278
								62.00	63.50	1.50	0.199
TFD-155	130.40	-85	205	633.03	1060W	559		24.00	27.00	3.00	0.554
								36.00	40.50	4.50	1.067
								43.50	53.50	10.00	1.003
							including	47.50	50.50	3.00	2.869
								76.50	79.50	3.00	0.704
TFD-156	101	-90	0	632.19	1020W	550		6.00	7.50	1.50	2.493
								28.50	31.50	3.00	0.759
								49.50	54.00	4.50	0.650
								60.00	65.00	5.00	0.645
								77.00	81.20	4.20	2.464
							including	78.50	80.00	1.50	6.668
TFD-157	151.5	-90	0	640.22	1120W	556		19.50	21.00	1.50	0.161
								36.00	37.50	1.50	0.194
								40.50	46.50	6.00	0.426
								48.50	51.00	2.50	3.413
							including	48.50	49.50	1.00	4.961
								54.00	55.50	1.50	2.860
								63.50	67.50	4.00	0.479
	144.00	147.00	3.00	0.472							
TFD-158	100.80	-90	0	632.80	980W	525		25.80	27.30	1.50	0.257
								31.80	43.80	12.00	1.480
							including	33.30	34.80	1.50	7.758
							including	37.80	39.30	1.50	2.055
								48.30	49.80	1.50	0.417
								69.30	70.80	1.50	0.295
	81.30	82.80	1.50	0.323							
TFD-159	130.80	-85	25	644.58	980W	525		13.00	21.00	8.00	0.590
								34.50	40.50	6.00	0.636
								48.00	54.00	6.00	0.249
								79.50	82.50	3.00	0.576
								85.50	87.00	1.50	0.480
								97.50	99.00	1.50	0.220
TFD-160	100.80	-80	205	635.32	1080W	550		0.00	9.00	9.00	2.655
							including	6.00	9.00	3.00	6.236
								46.50	48.00	1.50	1.114
								69.00	72.00	3.00	0.199
								99.00	100.80	1.80	0.251

Drill Hole Number	Depth (m)	Angle (°)	Azimuth (°)	Elev (m.s.n.m)	Section Line	North Coordinate	Mineral Drill Intersections			
							From (m)	To (m)	True Width (m)	Au (g/t)
TFD-161	100.80	-80	205	637.01	940W	510	25.80	27.30	1.50	0.452
							33.30	34.80	1.50	0.903
							39.30	40.80	1.50	0.370
							57.30	58.80	1.50	0.208
							75.30	85.50	10.20	0.231
							97.80	100.80	3.00	0.214

Table provided by Alio Gold Inc.

#### 10.4.4 2015, In-fill RC Drilling Below Phase 4 of the San Francisco Pit

In 2015, after a review of the block model, drill spacing and negative reconciliation on the upper benches (+600 m elevation) of Phase 4, which was approximately a 50 m push back of the north wall of Phase 3 within the San Francisco pit, a drilling program was conducted to test the continuity of the mineralization, as interpreted from the original drilling programs in this area.

The drilling program was based upon a review of the mineral zones as configured by the blast hole patterns for Phase 3, which was depleted in February, 2015. The blast hole patterns indicated that, in this area of the pit, the local mineralization dipped in the opposite direction to the general dip elsewhere in the pit.

As a consequence, a 2,135.12-m drilling program comprised of 21 holes was conducted to test the dip of the mineralization against the original interpretation for Phase 4. The drilling program confirmed that the dip of the mineralization was as originally outlined and that the mineral zone encountered in Phase 3 was an anomaly.

Table 10.5 summarizes the significant gold intersection for the RC drilling conducted on Phase 4.

**Table 10.5**  
Summary of the Location and Significant Assays for the RC Drilling Below Phase 4 of the San Francisco Pit

Drill Hole Number	Depth (m)	Angle (°)	Azimuth (°)	Section Line	Mine Phase	Bench (Elev)	Mineral Drill Intersections			
							From (m)	To (m)	True Width (m)	Au (g/t)
TF-3646	112.776	-50	205	860W	4B	600	76.20	94.49	18.29	0.818
TF-3647	115.824	-50	205	880W	4B	600	67.05	96.01	28.96	1.006
TF-3648	146.3	-50	205	900W	4B	600	30.48	146.30	115.82	0.832
TF-3649	134.11	-47	205	920W	4B	600	59.44	68.58	9.14	0.379
							94.49	120.39	25.90	0.389
TF-3650	70.1	-90	0	580W	4B	600	9.14	13.72	4.57	0.808
							27.43	33.53	6.10	0.751

Drill Hole Number	Depth (m)	Angle (°)	Azimuth (°)	Section Line	Mine Phase	Bench (Elev)	Mineral Drill Intersections			
							From (m)	To (m)	True Width (m)	Au (g/t)
							39.62	42.67	3.05	6.351
							64.01	68.58	4.57	0.689
TF-3651	97.54	-72	205	1080W	4B	600	0.00	76.02	76.02	0.606
							0.00	4.57	4.57	0.444
TF-3652	73.15	-73	205	1100W	4B	600	35.05	54.86	19.81	0.443
							62.48	67.06	4.57	0.345
TF-3653	103.63	-58	205	600W	4B	Ramp to Phase 3	1.52	24.38	22.86	0.345
							47.24	102.11	54.86	1.086
TF-3654	123.44	-47	205	620W	4B	Ramp to Phase 3	13.72	28.96	15.24	0.267
							41.15	50.29	9.14	1.941
							73.15	123.44	50.29	0.522
TF-3655	91.44	-62	205	640W	4B	Ramp to Phase 3	3.05	27.43	24.38	0.388
							71.63	91.44	19.81	0.946
TF-3656	60.96	-90	0	660W	4B	Ramp to Phase 3	0.00	15.24	15.24	0.501
							24.38	27.43	3.05	2.157
							48.77	51.82	3.05	0.668
TF-3657	91.44	-90	0	760W	4B	Ramp to Phase 3	0.00	24.38	24.38	0.441
							60.96	79.25	18.29	0.344
TF-3658	91.44	-65	205	720W	4B	Ramp to Phase 3	4.57	33.53	28.96	0.318
							44.20	67.06	22.86	0.447
TF-3659	100.58	-90	0	820W	4B	Ramp to Phase 3	0.00	53.34	53.34	0.737
							71.63	86.87	15.24	0.255
TF-3660	115.82	-50	205	940W	4B	600	54.86	92.96	38.10	0.535
TF-3661	67.06	-70	205	1000W	4B	600	54.86	62.48	7.62	0.757
TF-3662	85.34	-60	205	1060W	4B	600	21.34	64.01	42.67	0.305
TF-3663	128.16	-55	205	1040W	4B	600	60.96	120.40	59.44	0.622
TF-3664	100.58	-68	205	1000W	4B	600	62.48	92.96	30.48	0.520
							42.67	53.34	10.67	1.767
TF-3665	115.82	-60	205	980W	4B	600	80.77	97.54	16.76	0.432
TF-3666	109.72	-58	205	960W	4B	600	41.15	47.24	6.10	13.405

Table provided by Alio Gold Inc.

## 10.5 EXPLORATION DRILLING 2014 TO 2015 ON THE SAN FRANCISCO PROPERTY

From July to September, 2014, a total of 21,202.27 m of RC, core and RAB drilling was completed on the targets to the north of the San Francisco pit. This drilling included 3 RAB sections over 5 km in length, with RAB drilling on the La Mexicana-Vetatierra corridor, the 1B area and the La Vetatierra target. The 1B area and La Vetatierra targets were also drilled using both core and RC equipment. The objective of this drilling was to provide geological evidence for the discovery of a new gold deposit in the area closest to the existing mining operation, that could act as either a satellite pit or standalone operation.

Table 10.6 summarizes the number of drill holes and metres for each type of drilling conducted north of the San Francisco Pit.



**Table 10.6**  
**Summary of the Location, Type, Metres Drilled and Number of Drill Holes for the Programs North of the San Francisco Pit**

<b>Project</b>	<b>Drill Type</b>	<b>Total Metres</b>	<b>Number of Holes</b>
Sección 1 (3500W)	RAB	2,060.87	52
Sección 2 (4100W)	RAB	1,761.74	53
Sección 3 (4700 W)	RAB	1,725.17	55
1B	RC	8,040.40	57
1B Core	Core	758.7	3
Vetatierra	Core	2,311.3	6
Vetatierra	RC	1,197.86	4
La Mex-La Vet	RAB	3,133.34	69
La Playa	RC	213.36	2

Table provided by Alio Gold Inc.

### 10.5.1 RAB Drilling North of the San Francisco Mine

The objective of the RAB drilling was to gain a better understanding of the structural and geochemical controls of the gold mineralization within a 5 km by 2 km structural corridor identified previously by surface mapping, soil sampling and air-magnetic mapping as potentially hosting areas where the flat-lying gold-bearing structures may coalesce into a larger zone.

The RAB drilling program was comprised of 5,547 m distributed in three sections separated in width by 600 m, with drill collars spaced 100 m apart along Section lines 3500W, 4100W and 4700W. The targets tested in this program included low and high magnetic anomalies, gold soils anomalies, low angle shear zones and red colour anomalies on co-alluvial soils. The various mineralized targets tested with the RAB program were La Playa, El Diez, La Mexicana, 1B and La Vann. The average depth of the RAB holes was 35 m intersecting a thickness of alluvial soil varying from 6 to 76 m. An additional 3,133 m were drilled at the La Mexicana-La Vetatierra structural corridor with 69 RAB holes distributed south and northwest of La Mexicana, including holes south of the La Vetatierra. The entire program was contained within a 2,000 by 500 m corridor.

Figure 10.16 shows the location of the RAB drilling along Section lines 3500W, 4100W and 4700W in relation to the San Francisco pit and the northern exploration targets.

Where possible, the true width of the mineralization has been reported in this section. However, for areas where the orientation of the deposit or mineralization was still under investigation the tables represent the width of the mineralization intersected in the hole.

Of the 52 RAB drill holes collared on Section 3500W, 19 returned anomalous gold values. The results along Section line 3500W confirmed the potential extension to the west of the mineral intercepts in the 1B area explored with RC holes during 2008, which returned some significant gold assays and trace elements.

Of the 53 RAB drill holes collared on Section 4100W, 17 returned anomalous gold values while, of the 55 RAB drill holes collared on Section 4700W, 14 returned anomalous gold values.

**Figure 10.16**  
**Plan View of the RAB Drilling along Section Lines 3500W, 4100W and 4700W**

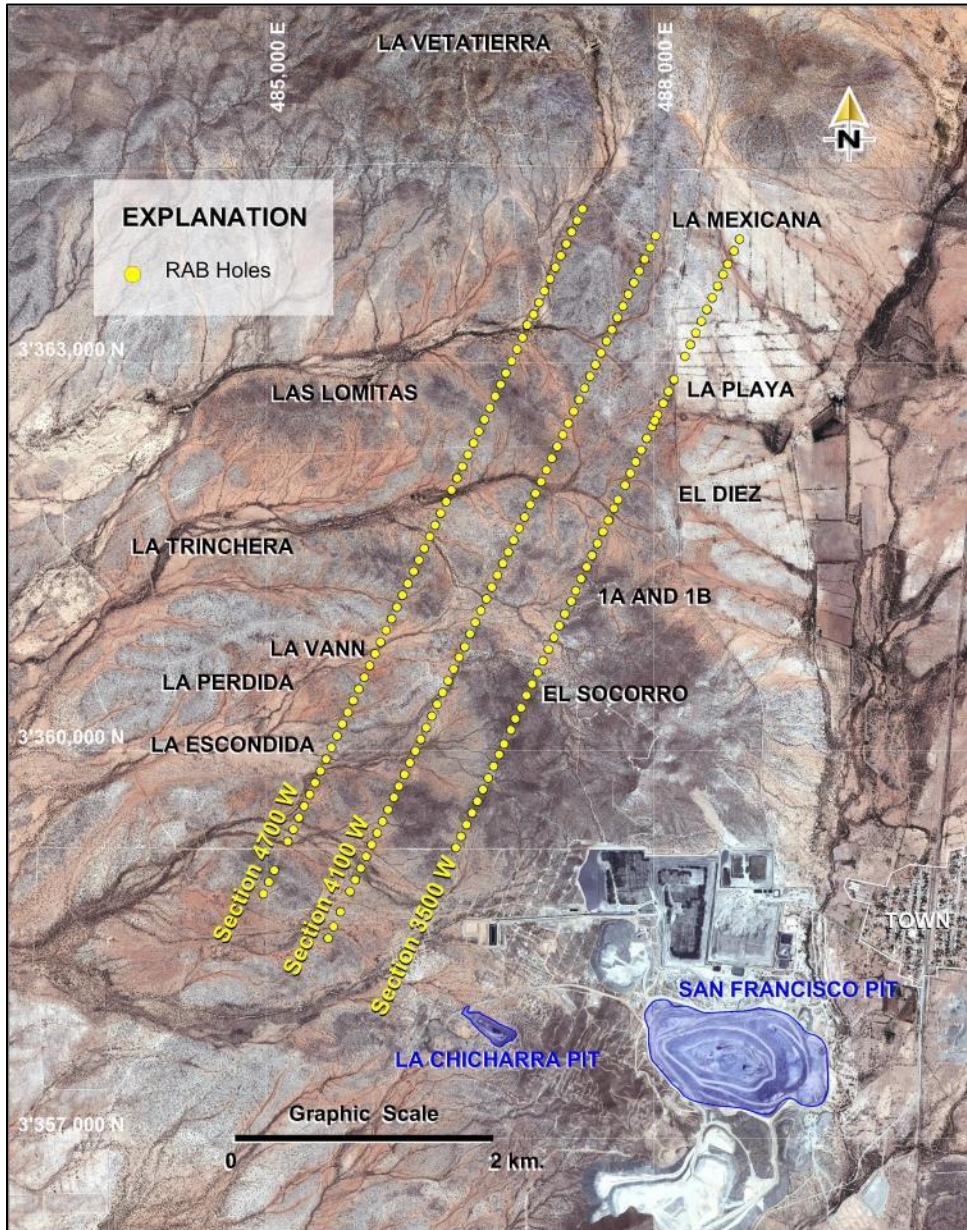


Figure provided by Alio Gold Inc. Figure dated February, 2016

Table 10.7, Table 10.8 and Table 10.9 summarize the most significant RAB drill intersections along Sections 3500W, 4100W and 4700W.

**Table 10.7**  
**Summary of the Most Significant RAB Drill Intersections along Section 3500W**

RAB Hole No.	Mineralized Intersection				
		From (m)	To (m)	Width (m)	Au (g/t)
R14-096		4.06	6.09	2.03	0.846
R14-102		18.29	24.38	6.10	0.353
R14-120		4.06	14.22	10.16	0.663
		22.35	30.48	8.13	0.222
R14-133		20.32	30.48	10.16	5.515
	including	20.32	22.35	2.03	25.900
R14-137		30.48	32.51	2.03	2.010
		50.80	58.93	8.13	0.813

Table provided by Alio Gold Inc.

**Table 10.8**  
**Summary of the Most Significant RAB Drill Intersections along Section 4100W**

RAB Hole No.	Mineralized Intersection			
	From (m)	To (m)	Width (m)	Au (g/t)
R14-148	12.19	16.26	4.06	0.455
R14-149	12.19	22.35	10.16	0.263
R14-154	16.25	24.38	8.13	1.426
R14-159	28.45	30.48	2.03	0.254
R14-160	14.22	18.29	4.07	3.499
R14-176	6.10	12.19	6.10	0.215

Table provided by Alio Gold Inc.

**Table 10.9**  
**Summary of the Significant RAB Drill Intersections along Section 4700W**

RAB Hole No.	Mineralized Intersection			
	From (m)	To (m)	Width (m)	Au (g/t)
R14-207	10.16	12.19	2.03	0.531
R14-211	8.13	16.26	8.13	2.500
R14-214	14.22	20.32	6.10	0.278

Table provided by Alio Gold Inc.

Based upon the results of the RAB holes drilled on the section lines, a number of areas were selected for RC follow up drilling, including those located across the projection of the mineralization to the west of the 1B area. The RC drilling focused on exploring the potential continuity of the mineral intersections along strike and down dip, since the mineral intersections are located between surface and a maximum vertical depth of 60 m for the RAB drilling.

## 10.5.2 La Mexicana – Vetatierra RAB Drilling

A total of 3,133.34 m were drilled within the low magnetic and gold soil geochemistry anomaly structural corridor between the La Mexicana Project and La Vetatierra Project. The La Mexicana Project was previously drilled in 2009 and yielded a series of high-grade quartz-tourmaline veins with grades of up to 47 g/t Au. The more recent drilling demonstrated that the area has the potential to host a bulk minable gold deposit but there is also the potential that it could become a high-grade vein style target due the encouraging gold assays results. Alio conducted various interpretations of the vein structures to determine if there is a single vein or a set of veins with high-grade gold values that may be traceable by core drill holes.

Table 10.10 summarizes the best mineral intersections for the RAB drilling in the corridor between the La Mexicana and La Vetatierra Projects

**Table 10.10**  
**Summary of the Significant RAB Drilling Results for the Area Between the La Mexicana and La Vetatierra Projects**

RAB Hole Number	Mineralized Intersections					
		From (m)	To (m)	Width (m)	Au (g/t)	Ag (g/t)
R14-258		6.10	8.13	2.03	0.484	3.5
		28.448	30.48	2.03	1.483	6
R14-260		8.13	14.22	6.10	10.00	43.33
	including	10.16	12.19	2.03	28.00	121
R14-265		14.22	16.26	2.03	1.551	14
R14-295		14.22	18.29	4.06	4.383	1.5
R14-300		30.48	32.51	2.03	1.446	<1
R14-310		14.22	16.26	2.03	1.774	<1
R14-311		32.51	34.54	2.03	3.349	3
R14-312		6.10	8.13	2.03	3.362	44

Table provided by Alio Gold Inc.

## 10.5.3 1B Area RC and Core Drilling in 2014

The 1B area is located 3.2 km north of the San Francisco pit. The area explored with RC drilling comprised a quadrangle of approximately 1,000 m by 300 m where geological mapping indicated a pair of shear zones containing gold mineralization at surface. These shear zones are spaced an average of 300 m apart, corresponding to the footwall and hangingwall of a wide shear zone, respectively. A first pass drilling program was initiated in order to form a better understanding of how the gold mineralization is related to the low angle highly oxidized, quartz vein shear zone hosted in granitic rocks.

A total of 8,040.40 m of RC drilling in 57 widely spaced holes were completed north of the main shear zone within an area covered by co-alluvial material, with the goal of following up on the gold mineralization intercepted by the RAB drill holes containing significant assay results close to surface. The gold mineralization intercepted by the drilling is hosted by highly

pyritic intervals related to the shear zone and to its hangingwall and footwall. The shear zone is hosted by granite, gabbro, and felsic and mafic gneiss.

Of the 57 RC holes drilled, 29 holes returned significant assays from the view point that this is an early stage exploration program. The significant RC holes are distributed from Section line 3500W towards the east to the 1B Area, along section lines spaced every 100 m.

Table 10.11 summarizes the significant mineral intersections encountered during the 2014 RC drilling program at the 1B Area.

**Table 10.11**  
**Summary of Significant 2014 RC Drilling Intersections in the 1B Area**

Drill Hole Number	Depth (m)	Angle (°)	Azimuth (°)	Section Line	Mineralized Intersections				
						From (m)	To (m)	Width (m)	Au (g/t)
1B14-001	201.168	205	-60	2900W		1.52	4.57	3.05	1.060
						27.432	38.1	10.67	<b>0.407</b>
						57.912	59.436	1.52	<b>0.121</b>
						185.93	188.98	3.05	0.206
1B14-002	201.168	205	-60	2900W		1.52	3.05	1.52	0.141
						76.20	77.72	1.52	0.100
						94.49	96.01	1.52	0.267
1B14-003	213.36	205	-60	2900W		50.29	53.34	3.05	0.183
						79.25	80.77	1.52	0.108
						96.01	100.58	4.57	0.367
						108.20	109.73	1.52	0.275
						112.78	115.82	3.05	2.020
						121.92	123.44	1.52	0.814
						137.16	138.68	1.52	0.169
1B14-004	204.216	205	-60	2900W		161.54	164.59	3.05	0.298
						170.688	187.452	16.76	0.588
					including	181.356	185.928	4.57	1.601
						193.548	198.12	4.57	0.173
1B14-005	219.216	205	-60	2800W		9.14	18.29	9.14	0.479
						30.48	51.82	21.34	0.519
					including	32.004	41.148	9.14	1.000
1B14-006	100.645	0	-90	3600W		6.10	7.62	1.53	1.995
						15.25	18.30	3.05	0.176
						24.40	25.92	1.53	0.113
						27.45	30.50	3.05	0.135
						36.60	41.17	4.58	0.158
						45.75	47.27	1.53	0.140
						51.85	54.90	3.05	1.244
1B14-007	100.65	0	-90	3600W		7.62	9.15	1.53	0.314
						64.05	73.20	9.15	0.202
						86.92	96.07	9.15	0.241
1B14-008	103.70	0	-90	3600W		6.10	13.72	7.63	0.378
						19.82	21.35	1.53	0.171
1B14-009	100.58	0	-90	3600W		0.00	1.52	1.52	0.203

Drill Hole Number	Depth (m)	Angle (°)	Azimuth (°)	Section Line	Mineralized Intersections				
						From (m)	To (m)	Width (m)	Au (g/t)
						12.19	21.33	9.14	0.314
						25.90	27.43	1.52	0.129
						88.39	96.01	7.62	0.306
1B14-010	100.65	0	-90	3600W		10.67	12.20	1.53	0.124
						21.35	25.92	4.58	0.322
						41.17	42.70	1.53	0.285
						45.75	48.80	3.05	0.142
						54.90	59.47	4.58	0.738
1B14-011	106.73	0	-90	3600W		1.52	3.05	1.52	0.454
						47.27	48.80	1.53	0.111
						57.95	59.47	1.53	0.145
						62.52	70.15	7.62	0.475
						77.77	82.35	4.58	0.409
1B14-012	100.65	0	-90	3500W		85.40	86.92	1.53	0.114
						9.15	13.72	4.58	0.162
						28.97	30.50	1.53	0.177
						36.60	38.12	1.53	0.109
						41.17	42.70	1.53	1.580
1B14-013	100.65	0	-90	3500W		24.40	33.55	9.15	2.660
					including	27.45	32.02	4.57	5.027
						48.80	53.37	4.58	0.134
						56.42	61.00	4.58	0.431
B14-014	100.584	0	-90	3500W		0.00	9.15	9.15	0.264
1B14-015	131.064	0	-90	3400W		21.33	22.86	1.52	1.745
1B14-016	100.58	0	-90	3400W		1.52	4.57	3.05	0.354
						83.87	85.40	1.52	0.204
						89.16	91.44	1.52	0.102
1B14-017	100.58	0	-90	3400W		1.52	4.57	3.05	0.354
						39.62	41.15	1.52	2.480
1B14-018	100.58	0	-90	3400W		10.67	13.72	3.05	0.224
						77.77	80.82	3.05	0.166
						96.07	97.60	1.53	0.381
1B14-019	106.68	0	-90	3400W		105.22	106.75	1.53	0.210
1B14-020	106.68	0	-90	3400W	NO MINERAL INTERCEPTS				
1B14-021	210.31	205	-60	2800W		134.11	137.16	3.05	0.618
						205.74	208.79	3.05	0.114
1B14-022	201.17	205	-60	2800W		88.39	91.44	3.05	1.694
						123.44	131.06	7.62	0.660
						134.11	135.64	1.52	0.209
1B14-023	225.55	205	-60	2800W		3.05	7.62	4.57	0.227
						32.00	33.53	1.52	0.203
						118.87	121.92	3.05	0.348
						124.97	126.49	1.52	0.595
1B14-024	201.17	205	-60	3000W	NO MINERAL INTERCEPTS				
1B14-025	219.45	205	-60	3100W		32.00	33.53	1.52	0.397
						132.588	135.636	3.05	<b>0.360</b>
1B14-026	100.58	0	-90	3400W		47.24	48.77	1.52	0.311
1B14-027	100.584	0	-90	3300W	NO MINERAL INTERCEPTS				

Drill Hole Number	Depth (m)	Angle (°)	Azimuth (°)	Section Line	Mineralized Intersections				
						From (m)	To (m)	Width (m)	Au (g/t)
1B14-028	112.77	0	-90	3300W		19.81	25.91	6.10	0.138
						54.86	79.25	24.38	0.265
					including	60.96	65.53	4.57	0.463
1B14-029	103.63	0	-90	3300W		0.00	4.57	4.57	0.156
						30.48	33.53	3.05	0.238
						38.10	44.20	6.10	0.493
1B14-030	106.68	0	-90	3300W		15.24	16.76	1.52	0.292
						47.24	48.77	1.52	0.133
1B14-031	201.168	205	-60	3000W		6.10	9.14	3.05	0.264
						80.77	82.30	1.52	0.644
1B14-032	210.32	205	-60	3000W		1.52	4.57	3.05	0.548
						41.15	44.20	3.05	0.183
						126.50	128.02	1.52	1.185
						138.68	143.26	4.57	0.772
					146.30	147.83	1.52	1.029	
1B14-033	201.17	205	-60	3000W		30.48	33.53	3.05	0.427
1B14-034	100.58	0	-90	3100W	NO MINERAL INTERCPTS				
1B14-035	109.78	0	-90	3100W		16.76	28.96	12.19	0.155
1B14-036	100.58	0	-90	3300W		4.57	7.62	3.05	0.226
						27.43	28.96	1.52	2.070
						59.44	73.15	13.72	2.538
1B14-037	100.58	0	-90	3200W		0.00	6.10	6.10	0.143
						12.19	16.76	4.57	0.170
1B14-038	106.68	0	-90	3200W		12.19	15.24	3.05	0.176
						32.00	33.53	1.52	0.203
1B14-039	103.63	0	-90	3200W		42.67	48.77	6.10	0.147
						56.38	57.91	1.53	0.341
						62.48	67.06	4.57	0.283
1B14-040	100.58	0	-90	3200W		86.87	94.49	7.62	0.186
1B14-041	100.58	0	-90	3100W		3.05	7.62	4.57	0.221
						33.53	35.05	1.52	0.135
						68.58	70.10	1.52	1.845
						74.68	76.20	1.52	0.114
						79.25	82.30	3.05	0.319
						86.87	89.92	3.05	0.267
1B14-042	103.632	0	-90	3100W		96.01	97.54	1.52	0.672
						25.91	27.43	1.52	0.118
						30.48	36.58	6.10	0.852
					74.68	76.20	1.52	0.177	
1B14-043	106.68	0	-90	3400W		36.58	39.62	3.05	0.206
1B14-044	100.58	0	-90	3200W		38.10	45.72	7.62	0.496
1B14-045	100.58	0	-90	3100W	NO MINERAL INTERCPTS				
1B14-046	100.58	0	-90	3100W	NO MINERAL INTERCPTS				
1B14-047		0	-90	3100W	NO MINERAL INTERCPTS				
1B14-048	106.68	0	-90	3200W		4.57	6.10	1.52	0.179
						24.38	25.91	1.52	0.139
						45.72	47.24	1.52	0.359
						60.96	62.48	1.52	0.421

Drill Hole Number	Depth (m)	Angle (°)	Azimuth (°)	Section Line	Mineralized Intersections				
					From (m)	To (m)	Width (m)	Au (g/t)	
					67.06	68.58	1.52	0.179	
1B14-049	100.584	205	-70	3200W	30.48	32.00	1.52	0.368	
					45.72	51.82	6.10	0.249	
					57.91	60.96	3.05	0.673	
					64.01	68.58	4.57	0.241	
					86.87	88.39	1.52	0.150	
					94.49	96.01	1.52	0.225	

Table provided by Alio Gold Inc.

In 2014, 3 core holes were drilled within the 1B area. The holes were collared with the objective of confirming the higher grades intercepted by the previous RC drill holes and to obtain a better understanding of the geological and structural controls for the mineralization.

Hole 1BD14-001 was collared on Section 3500W to probe the high-grade mineralization encountered by RAB and RC drilling. The mineralization was not intercepted by drilling and it is believed that mineralization is pinching out at depth.

Hole 1BD14-002 was collared on Section 3300W to test the low-grade mineralization encountered by hole 1B14-028. Its purpose was to test the hypothesis that there was the possibility of some loss of gold with RC drilling and that core drilling may result in a higher grade. The second objective was to intercept the possible feeder zone of the high-grade mineralization intercepted by drill hole 1B14-036. The grade of the mineralization intercepted was very similar in both holes, so there appears to be no gold lost in the RC drilling. The possible feeder zone was not located in the hole.

On Section 2800W, hole 1BD14-003 was collared 50 m north of the RC hole 1B14-005 to intercept the down dip projection of gold mineralization. This hole intercepted 11.10 m grading 0.627 g/t Au, which corresponds to the down dip projection of the mineralization intercepted by RC drill hole 1B14-005.

Table 10.12 summarizes the significant assay results from the three 2014 core holes within the 1B area.



**Table 10.12**  
**Summary of the Significant Assay Results for the Three Core Holes Drilled in the 1B Area**

Drill Hole Number	Depth (m)	Angle (°)	Azimuth (°)	Section Line	Mineralized Drill Intersections				
						From (m)	To (m)	Width (m)	Au (g/t)
1BD14-001	299	-70	205	3500W		6.75	11.00	4.25	0.163
						111.45	114.7	3.25	0.186
1BD14-002	263	-70	205	3300W		18.00	21.00	3.00	0.137
						49.50	74.00	24.50	0.218
						191.5	193	1.50	0.176
1BD14-003	196.7	-60	205	2800W		0.00	2.00	2.00	0.998
						15.20	16.70	1.50	0.112
						45.00	45.70	0.70	0.653
						48.50	50.00	1.50	0.231
						67.70	70.70	3.00	0.193
						74.60	85.70	11.10	0.627
					including	76.30	80.05	3.75	1.491

Table provided by Alio Gold Inc.

A closer-spaced drilling program, approximately 50 m by 25 m apart, within an area 200 m long by 100 m wide was scheduled to the east of the 1B area where the holes 1B14-005 and TF-048 intercepted gold mineralization close to surface. The objective of this second round of drilling was to determine if the mineralization could be of sufficient grade to potentially host a satellite open pit, heap leach deposit which could feed the San Francisco operation. The drill program was not completed due an in-pit drilling program at the San Francisco pit which was deemed to be a higher priority program.

However, 13 RC holes totalling 2,419.64 m were drilled in an area of 120 by 100 m to the north and on east side of the 1B14-005. The best gold intercepts were in drill hole 1B14-051 grading 2.025 g/t over 4.57 m; drill hole 1B14-057 grading 1.506 g/t Au over 9.14 m, including 4.160 g/t Au over 3.05 m, and 2.469 g/t Au over 4.57 m, including 7.102 g/t Au over 1.524 m; and in drill hole 1B14-068 with 1.553 g/t Au over 7.62 m, including 3.481 g/t Au over 3.05 m.

Figure 10.17 is a plan view of the RAB, RC and core drilling conducted in the 1B area.

**Figure 10.17**  
**Plan View of the RAB, RC and Core Drilling Conducted in the 1B Area**

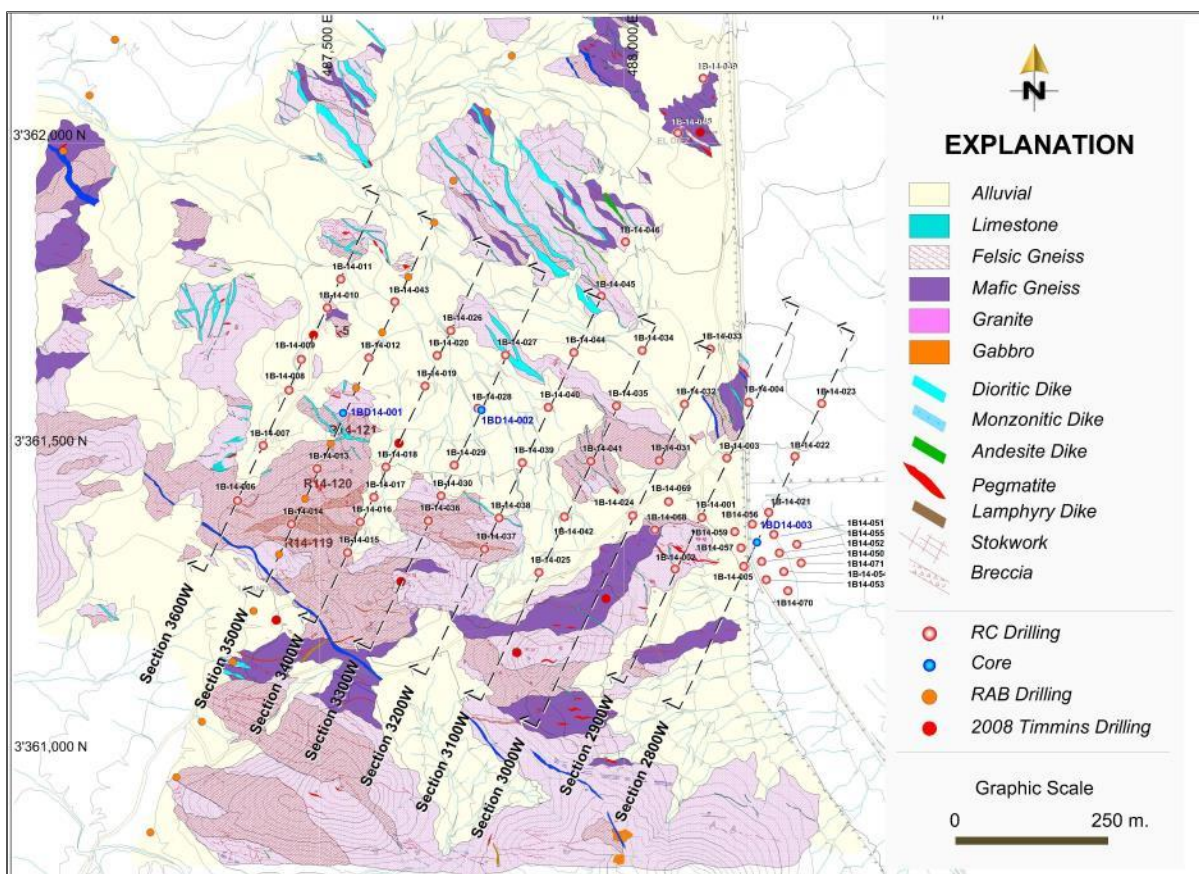


Figure provided by Alio Gold Inc. and dated February, 2016.

The drilling does not appear to have identified a bulk low-grade gold deposit that could be mined by open pit methods at the 1B area. However, some of the area is still open to testing and some high-grade structural zones are still open in the area as well.

Further work will be necessary to fully understand the nature and extent of the mineralization at the 1B area.

#### 10.5.4 Vetatierra Area

The Vetatierra Project is located approximately 8 km north of the San Francisco mine. The geology is dominated by detrital sediments of the El Represo Formation intruded by small stocks of fine grain diorite and diorite dikes. The diorite stock covers an area of 600 m by 200 m oriented to the northeast. The contacts between the sediments and diorite intrusions developed an alteration halo forming metamorphic rocks containing low-grade gold mineralization.

Core and RC drilling was conducted in an area 1.2 km by 0.3 km oriented to the northeast, to test the surface gold mineralization encountered within and around the dioritic stocks. The gold mineralization at La Vetatierra is related to quartz-tourmaline, quartz-tourmaline-pyrite and quartz-pyrite veins and veinlets. The initial rock chip samples collected returned significant gold values. Sample 4601 returned the highest gold value of 29.56 g/t Au, 27.1 g/t Ag and 0.35% Pb and sample 4857 yielded 1.0 g/t Au, 905.5 g/t Ag, 3.63% Pb. Chip channel sampling on trenches over the dioritic stock returned significant gold values, including 10 m grading 6.01 g/t Au and 4.63 g/t Ag, including 2 m of 26.61 g/t Au and 2.52 g/t Ag; and 44 m grading 0.39 g/t Au and 1.92 g/t Ag.

The first phase of the drilling program comprised 6 core holes totalling 2,311.3 m and 4 RC holes totalling 1,197.86 m strategically distributed along the dioritic stock and its alteration halo. The first core hole, VT14-001, intersected multiple mineralized intervals confirming the down dip projection of the surface gold values. However, both lower gold grades and narrower intervals were intersected, although the alteration in the diorite and the metasedimentary sequence looks impressive, with sericite, pyrite, magnetite, and quartz and quartz-tourmaline veins, among others, encountered. The most significant mineralized interval was contained within hole VT14-002 which graded 1.286 g/t Au over 33.85 m, including 1.879 g/t Au over 22.40 m or 3.260 g/t Au over 12.50 m.

Additional RC holes, VTRC14-001 and VTRC14-004, were collared 50 and 100 m apart to the southwest of hole VT14-002. Drill holes VTRC14-002 and VTRC14-003 were collared 50 m northeast of hole VT14-002 along the same section, to follow up the immediate down and up dip projection of the gold intersections detected by VT14-002. Holes VTRC14-001, 002 and 003 all intercepted the gold mineralization, although with different and more intermittent grades.

Judging from the section drilled at the La Vetatierra Project, the mineralization is most likely an open quartz tourmaline and quartz-pyrite stockwork hosted by the fine grain diorite stock. The interpretation of the mineralized zones is difficult and remains to be determined, although the main mineralized zones tend to be flat and gently dipping to the south.

Table 10.13 summarizes the significant core intersections from the 2014 drilling program at the Vetatierra Project.

**Table 10.13**  
**Summary of the Significant 2014 Core Intersections at the Vetatierra Program**

Drill Hole Number	Depth (m)	Angle (°)	Azimuth (°)	Section Line	Mineral Drill Intersections				
					From (m)	To (m)	Width (m)	Au (g/t)	Ag (g/t)
VT14-001	539.1	205	-60		16.50	21.00	4.50	0.199	1.996
					25	30	5.00	0.386	0.945
					44	44.5	0.50	0.595	2.280
					54	57	3.00	0.451	3.878
					76.5	78	1.50	0.329	1.770
					106.5	109	2.50	0.401	4.674
					114	114.5	0.50	0.154	3.830

Drill Hole Number	Depth (m)	Angle (°)	Azimuth (°)	Section Line	Mineral Drill Intersections				
					From (m)	To (m)	Width (m)	Au (g/t)	Ag (g/t)
					121.4	122.3	0.90	0.266	7.150
					132.8	139.5	6.70	0.750	2.691
					including 138	139.5	1.50	2.490	6.883
					163.55	168.75	5.20	0.394	4.395
					175.4	175.9	0.50	0.139	2.410
					180	183	3.00	0.330	7.900
					186.1	187.4	1.30	0.140	9.620
					191.8	196	4.20	0.112	2.152
					234	234.9	0.90	2.580	49.400
					255	256.5	1.50	0.220	3.090
					285.3	292.4	7.10	0.380	5.297
					303.1	305.35	2.25	0.947	19.230
					308.35	309.85	1.50	0.223	5.280
					312.85	318.35	5.50	0.189	1.807
					328	333.9	5.90	0.109	1.603
					348.5	350	1.50	0.671	10.650
					353	359	6.00	0.146	7.388
					369.8	370.75	0.95	0.215	4.000
					390.2	390.7	0.50	0.255	8.880
					397	397.5	0.50	1.395	1.530
					409.5	412.5	3.00	0.347	1.950
					438	438.8	0.80	1.075	13.900
					484.7	485.2	0.50	0.522	4.630
					534	535.5	1.50	0.666	1.390
					13.50	18.00	4.50	0.147	1.172
					21.00	25.50	4.50	0.614	0.600
					33.90	36.80	2.90	0.130	0.576
					58.15	58.90	0.75	0.544	3.340
					76.10	77.20	1.10	0.323	2.130
					92.50	94.50	2.00	0.119	1.180
					115.50	149.35	33.85	1.286	1.599
					including 115.50	137.90	22.40	1.879	1.960
					121.50	134.00	12.50	3.260	2.600
					155.20	158.85	3.65	0.140	1.691
					178.00	188.60	10.60	0.221	0.647
					184.50	185.15	0.65	1.575	1.920
					187.30	188.60	1.30	0.218	1.930
					198.40	207.75	9.35	0.218	11.050
					including 201.25	201.75	0.50	0.551	69.100
					230.40	242.30	11.90	0.479	1.929
					245.30	246.80	1.50	1.745	18.250
VT14-002	352.9	205	-60		37.50	39.00	1.50	1.485	0.390
					40.50	41.10	0.60	0.261	0.460
					75.20	78.00	2.80	0.126	9.580
VT14-003	340.4	205	-60		4.50	6.50	2.00	8.640	1.590
					15.55	16.65	1.10	0.105	1.800
VT14-004	414	205	-60		28.10	29.45	1.35	2.180	2.310
					35.75	36.95	1.20	0.126	0.270

Drill Hole Number	Depth (m)	Angle (°)	Azimuth (°)	Section Line	Mineral Drill Intersections				
					From (m)	To (m)	Width (m)	Au (g/t)	Ag (g/t)
					118.95	120.20	1.25	0.147	1.230
					132.65	134.15	1.50	0.284	2.000
					145.00	146.50	1.50	0.101	1.020
					161.30	162.40	1.10	0.465	1.730
					164.28	165.75	1.47	0.164	1.840
					167.15	168.50	1.35	0.153	0.400
					184.00	187.00	3.00	0.119	0.500
					211.50	213.00	1.50	0.111	0.800
					219.10	220.60	1.50	0.384	0.800
					223.50	225.00	1.50	0.160	0.500
					225.70	226.50	0.80	0.211	0.400
					232.80	233.60	0.80	0.110	1.800
					240.50	241.95	1.45	0.771	1.800
					266.00	267.50	1.50	0.100	1.100
					273.50	274.00	0.50	0.110	0.500
					277.00	278.50	1.50	0.263	0.300
					281.00	290.00	9.00	0.141	1.248
					299.00	299.50	0.50	0.498	2.400
					304.00	305.40	1.40	0.296	4.900
					310.30	311.00	0.70	0.602	0.500
					314.55	315.65	2.00	0.398	25.800
					323.85	325.50	1.65	0.645	18.600
					384.50	385.50	1.00	0.207	0.800
VT14-005	392.4	165	-60		9.00	10.20	1.20	0.122	0.400
					24.10	32.00	7.90	0.282	0.539
					40.10	41.60	1.50	0.103	1.200
					76.90	78.40	1.50	0.112	0.400
					86.85	90.95	4.10	0.538	0.654
					110.45	113.85	3.40	0.133	1.656
					136.60	138.25	1.65	1.141	1.400
					143.80	144.50	0.70	0.737	2.100
					153.50	155.00	1.50	6.126	0.400
					157.40	163.60	6.20	0.381	0.900
					162.00	163.60	1.60	1.274	3.578
					172.00	176.50	4.50	0.163	5.500
					215.10	216.60	1.50	1.280	2.800
					236.00	238.80	2.80	1.967	2.321
VT14-006	272.5	205	-60		8.25	9.10	0.85	0.218	5.200
					27.70	29.40	1.70	0.166	3.000
					60.50	62.50	2.00	0.260	1.200
					76.35	77.40	1.05	0.238	1.300
					89.80	95.45	5.65	0.291	7.800
					108.15	108.90	0.75	0.478	5.400
					123.05	124.65	1.60	0.112	0.700
					136.50	138.00	1.50	0.555	3.400
					171.00	172.50	1.50	0.725	10.400
					175.50	177.40	1.90	0.386	8.200

Table provided by Alio Gold Inc.

Table 10.14 summarizes the significant RC intersections from the 2014 drilling program at the Vetatierra Project.

**Table 10.14**  
**Summary of the Significant 2014 RC Intersections at the Vetatierra Program**

Drill Hole Number	Depth (m)	Angle (°)	Azimuth (°)	Section Line	RC Mineralized Interval				
						From (m)	To (m)	Width (m)	Au (g/t)
VTRC14-001	316.992	205	-60			10.67	12.19	1.52	0.304
						41.15	45.72	4.57	0.994
						50.29	51.82	1.52	0.223
						57.91	59.44	1.52	0.138
						73.15	77.72	4.57	0.122
						86.87	91.44	4.57	0.180
						94.49	97.54	3.05	1.163
						112.78	114.30	1.52	0.179
						118.87	129.54	10.67	0.164
						144.78	152.40	7.62	1.384
					including	149.35	150.88	1.52	6.129
						158.50	160.02	1.52	0.473
						163.07	167.64	4.57	0.248
						172.21	188.98	16.76	0.232
						195.07	199.64	4.57	0.112
						202.69	204.22	1.52	0.529
						208.79	213.36	4.57	0.184
	219.46	220.98	1.52	0.410					
	231.65	236.22	4.57	0.150					
	263.65	265.18	1.52	0.156					
VTRC14-002	326.136	205	-60			4.57	6.10	1.52	0.149
						18.29	19.81	1.52	0.224
						25.91	27.43	1.52	0.129
						39.62	41.15	1.52	0.117
						44.20	45.72	1.52	0.158
						50.29	53.34	3.05	3.854
					including	50.29	51.82	1.52	7.597
						57.91	73.15	15.24	0.126
						80.77	83.82	3.05	0.177
						88.39	91.44	3.05	0.141
						94.49	102.11	7.62	0.412
						106.68	108.20	1.52	0.181
						111.25	118.87	7.62	0.458
						123.44	132.59	9.14	0.945
						138.68	149.35	10.67	0.203
						163.07	164.59	1.52	0.161
						170.69	172.21	1.52	0.131
	224.03	227.08	3.05	1.564					
including	224.03	225.55	1.52	2.957					
	275.84	281.94	6.10	0.338					
	284.99	286.51	1.52	0.149					

Drill Hole Number	Depth (m)	Angle (°)	Azimuth (°)	Section Line	RC Mineralized Interval				
					From (m)	To (m)	Width (m)	Au (g/t)	
VTRC14-003	301.75	0	-90		3.05	7.62	4.57	0.106	
					24.38	25.91	1.52	0.200	
					32.00	33.53	1.52	0.105	
					38.10	41.15	3.05	0.684	
					47.24	48.77	1.52	0.221	
					59.44	94.49	35.05	0.331	
					including	59.44	71.63	12.19	0.211
					74.68	76.20	1.52	0.180	
					77.72	79.25	1.52	0.243	
					83.82	94.49	10.67	0.752	
					99.06	102.11	3.05	0.281	
					105.16	106.68	1.52	0.196	
					112.78	114.30	1.52	0.104	
					117.35	132.59	15.24	0.260	
					143.26	156.97	13.72	0.303	
					160.02	161.54	1.52	0.192	
					172.21	173.74	1.52	2.961	
					193.55	196.60	3.05	0.173	
					199.64	201.17	1.52	0.125	
					208.79	211.84	3.05	0.168	
					231.65	233.17	1.52	0.246	
					246.89	249.94	3.05	0.391	
256.03	257.56	1.52	0.136						
265.18	268.22	3.05	0.166						
277.37	280.42	3.05	0.300						
284.99	286.51	1.52	0.101						
294.13	301.75	7.62	0.420						
VTRC14-004	301.75	205	-60		21.34	24.38	3.05	0.159	
					53.34	54.86	1.52	0.114	
					56.39	60.96	4.57	0.114	
					77.72	79.25	1.52	0.186	
					94.49	96.01	1.52	0.139	
					100.58	103.63	3.05	0.429	
					114.30	117.35	3.05	0.173	
					128.02	132.59	4.57	0.368	
					141.73	143.26	1.52	0.109	
					149.35	150.88	1.52	0.443	
					155.45	160.02	4.57	0.483	
					195.07	201.17	6.10	1.096	
					217.93	219.46	1.52	0.107	
					227.08	228.60	1.52	0.102	
239.27	240.79	1.52	0.889						

Table provided by Alio Gold Inc.

Figure 10.18 is a plan view of the 2014 RC and core drilling and geology at the Vetatierra Project.

**Figure 10.18**  
**Plan View of Geology and the 2014 RC and Core Drilling at the Vetatierra Project**

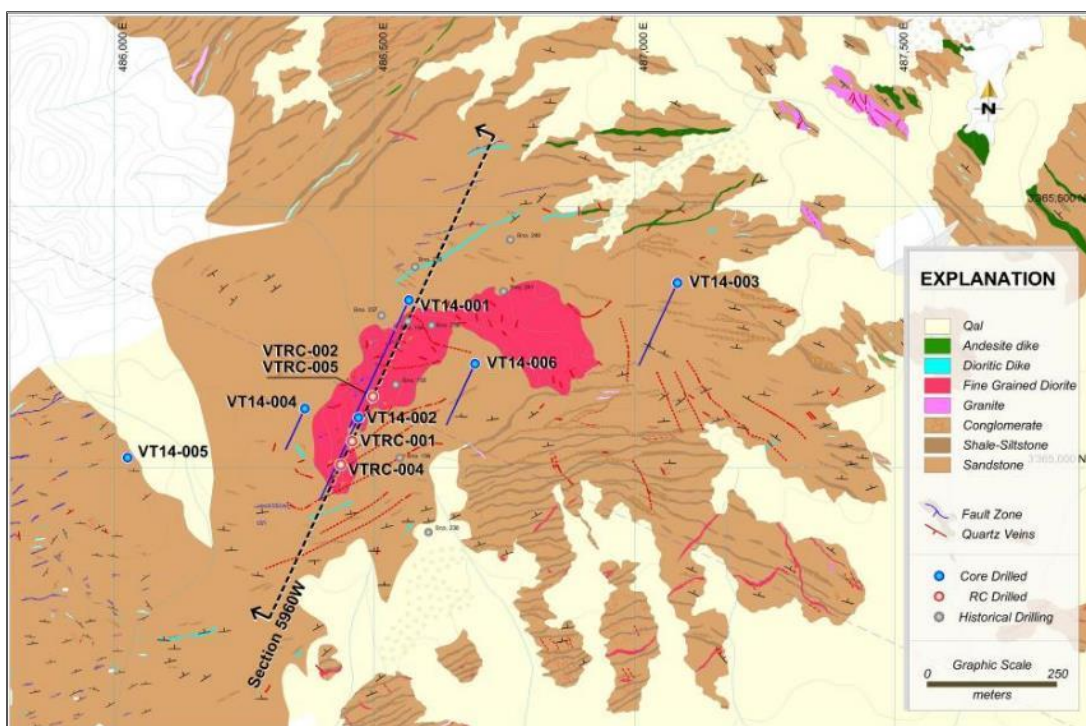


Figure provided by Alio Gold Inc. and dated February, 2016.

## 10.6 IN-FILL DRILLING JULY, 2016 TO MARCH, 2017 AT THE SAN FRANCISCO PROJECT

From July, 2016 to March, 2017, 13,877 m distributed in 101 holes of RC in-fill drilling were collared in 3 different zones within the current San Francisco mine operations. The holes were distributed as follows:

- San Francisco Phase 5: 10,456 m in 54 RC holes.
- La Chicharra satellite north and north west pit: 2,487 m in 32 RC holes.
- Las Barajitas Pits: 934 m in 15 RC holes.

An in-fill drill program was carried out on Phase 5 of the San Francisco pit with the objective of confirming and testing the continuity mineralization reported by the historical Geomaque drilling, and to reduce the drill spacing along the sections. Phase 5 is approximately a 70 m push back of the north wall of Phase 4 within the San Francisco pit.

The RC holes were systematically spaced on 20 m sections using the mine ore polygons as a reference, to understand the behaviour of the mineralization along its projection down-dip into Phase 5. The spacing of the previous drill holes, the amount of historical drilling on the sections and the possibility of increasing the reserves and reducing the waste in the mining phase were all taken into account when positioning the in-fill holes



The Las Barajitas drill program was conducted to in-fill the drilling for 2 small pit designs located southeast of the San Francisco pit. A total of 15 drill holes were collared to test the continuity of gold mineralization and reduce the drill spacing on the sections.

A total of 32 RC holes were drilled on the 2 satellite pits located north and northwest of the main La Chicharra pit. The in-fill drilling was conducted to reduce the drill spacing between the holes along the sections and to confirm the ore zone interpretations.

The July, 2016 to March, 2017 in-fill drill program confirmed the continuity of the gold mineralization in the 3 areas (San Francisco mine, La Chicharra and Las Barajitas pits). Mining has been undertaken in all three locations.

Table 10.15 summarizes the significant gold intersection for the RC drilling conducted on the San Francisco Phase 5, Las Barajitas and La Chicharra pits.

**Table 10.15**  
**Summary of the Location and Significant Assays for the RC Drilling between July, 2016 and March, 2017**

Drill Hole Number	Depth (m)	Angle (°)	Az (°)	Section Line	Mine Phase	Bench (Elev)	Mineral Drill Intersections			
							From (m)	To (m)	True Width (m)	Au (g/t)
TF-3668	263.652	-50	205	880W	Phase 5	632	131.06	138.68	7.62	1.580
							155.45	178.31	22.86	0.760
							211.84	233.17	21.34	0.401
TF-3669	263.652	-50	205	900W	Phase 5	632	205.74	237.74	32.00	2.238
							248.41	252.98	4.57	1.275
TF-3670	251.46	-50	205	920W	Phase 5	632	140.21	152.40	12.19	0.670
							193.55	225.55	32.00	0.756
TF-3671	262.128	-50.00	205	940W	Phase 5	632	70.10	82.30	12.19	1.011
							160.02	164.59	4.57	0.981
							222.50	231.65	9.14	0.534
TF-3673	195.07	-50	205	1000W	Phase 5	632	172.21	182.88	10.67	1.143
TF-3674	164.592	-45	205	1020W	Phase 5	632	25.91	30.48	4.57	1.454
							41.15	48.77	7.62	0.554
							144.78	149.35	4.57	0.941
							161.54	164.59	3.05	1.068
TF-3675	243.84	-50	205	1040W	Phase 5	632	73.15	82.30	9.14	1.456
							96.01	100.58	4.57	1.168
							138.68	144.78	6.10	0.971
							156.97	163.07	6.10	0.872
							181.36	188.98	7.62	1.275
							192.02	202.69	10.67	0.624
TF-3676	207.264	-60	205	1060W	Phase 5	632	233.17	239.27	6.10	1.229
							74.68	79.25	4.57	1.570
							118.87	147.83	28.96	0.909
TF-3677	207.264	-60	205	1080W	Phase 5	632	182.88	190.50	7.62	1.195
							97.54	112.78	15.24	0.612
							117.35	149.35	32.00	0.416
							188.98	207.26	18.29	0.895

Drill Hole Number	Depth (m)	Angle (°)	Az (°)	Section Line	Mine Phase	Bench (Elev)	Mineral Drill Intersections			
							From (m)	To (m)	True Width (m)	Au (g/t)
TF-3678	185.928	-50	205	1100W	Phase 5	632	102.11	109.73	7.62	0.687
							114.30	117.35	3.05	0.575
TF-3679	201.168	-45	205	1140W	Phase 5	632	54.86	59.44	4.57	1.943
							111.25	115.82	4.57	0.515
TF-3680	173.736	-85	205	980W	Phase 5	632	57.91	62.48	4.57	0.746
							143.26	167.64	24.38	0.736
TF-3682	121.92	-70	205	1220W	Phase 5	648	47.24	53.34	6.10	0.490
TF-3683	164.592	-55	205	960W	Phase 5	578	32.00	35.05	3.05	1.072
							86.87	92.96	6.10	0.882
TF-3684	182.88	-50	205	780W	Phase 5	578	62.48	70.10	7.62	0.524
							156.97	164.59	7.62	0.477
TF-3685	304.8	-70	205	780W	Phase 5	578	39.62	45.72	6.10	0.508
							67.06	79.25	12.19	0.472
							192.02	199.64	7.62	1.118
							205.74	213.36	7.62	1.214
							236.22	260.60	24.38	2.508
TF-3686	160.02	-55	205	760W	Phase 5	578	272.80	280.42	7.62	1.068
							67.06	74.68	7.62	0.332
TF-3687	252.984	-50	205	740W	Phase 5	578	92.96	102.11	9.14	0.409
							108.20	114.30	6.10	0.530
TF-3688	240.792	-70	205	740W	Phase 5	578	185.93	193.55	7.62	0.875
							224.03	240.79	16.76	0.485
TF-3689	252.984	-60	205	720W	Phase 5	578	57.91	67.06	9.14	0.845
							88.39	91.44	3.05	1.451
							121.92	143.26	21.34	0.588
							190.50	193.55	3.05	1.770
TF-3690	252.984	-45	205	720W	Phase 5	578	219.46	252.98	33.53	0.998
							56.39	60.96	4.57	2.804
							156.97	170.69	13.72	0.348
							216.41	222.50	6.10	2.036
TF-3691	252.984	-50	205	700W	Phase 5	578	228.60	236.22	7.62	1.610
							64.01	67.06	3.05	0.512
							149.35	163.07	13.72	0.529
							184.40	213.36	28.96	1.230
TF-3692	298.704	-50	205	680W	Phase 5	578	230.12	233.17	3.05	1.083
							240.79	243.84	3.05	1.003
							106.68	109.73	3.05	13.900
							137.16	140.21	3.05	1.764
							149.35	152.40	3.05	1.141
TF-3693	240.792	-45	205	660W	Phase 5	578	192.02	201.17	9.14	0.472
							208.79	216.41	7.62	1.143
							268.22	283.46	15.24	0.592
							0.00	3.05	3.05	0.966
TF-3693	240.792	-45	205	660W	Phase 5	578	143.26	149.35	6.10	2.313
							164.59	170.69	6.10	2.297
							202.69	210.31	7.62	1.270

Drill Hole Number	Depth (m)	Angle (°)	Az (°)	Section Line	Mine Phase	Bench (Elev)	Mineral Drill Intersections			
							From (m)	To (m)	True Width (m)	Au (g/t)
							213.36	216.41	3.05	0.621
							228.60	239.27	10.67	0.632
TF-3694	210.312	-45	205	620W	Phase 5	578	65.53	83.82	18.29	0.494
							103.63	106.68	3.05	1.400
							158.50	169.16	10.67	0.683
							192.02	205.74	13.72	1.085
TF-3695	201.168	-70	205	580W	Phase 5	Ramp	73.15	83.82	10.67	0.409
							115.82	120.40	4.57	1.065
							141.73	163.07	21.34	1.738
							179.83	201.17	21.34	1.720
TF-3696	207.264	-65	205	800 W	Phase 5	Ramp	22.86	44.20	21.34	0.770
							172.21	181.36	9.14	1.252
							185.93	202.69	16.76	0.504
TF-3697	201.168	-60	205	840 W	Phase 5	Ramp	65.53	76.20	10.67	0.587
							83.82	106.68	22.86	1.857
							144.78	155.45	10.67	0.448
							184.40	195.07	10.67	0.328
							10.67	16.76	6.10	0.298
TF-3698	152.4	-90	0	840 W	Phase 5	Ramp	27.43	39.62	12.19	0.852
							140.21	149.35	9.14	0.777
							39.62	42.67	3.05	4.177
TF-3699	231.648	-70	205	640 W	Phase 5	Ramp	51.82	57.91	6.10	0.619
							153.92	220.98	67.06	0.636
							32.00	35.05	3.05	0.282
TF-3700	192.024	-55	205	640 W	Phase 5	Ramp	38.10	62.48	24.38	0.667
							138.68	152.40	13.72	2.196
							156.97	163.07	6.10	0.555
							184.40	188.98	4.57	0.655
							41.15	54.86	13.72	1.714
TF-3701	152.4	-90	0	680 W	Phase 5	494	123.44	132.59	9.14	0.507
							24.38	32.00	7.62	0.703
TF-3702	103.632	-75	205	700 W	Phase 5	494	41.15	44.20	3.05	1.015
							48.77	60.96	12.19	0.313
							6.10	18.29	12.19	0.661
TF-3703	170.688	-90	0	740 W	Phase 5	494	36.58	39.62	3.05	1.679
							53.34	57.91	4.57	0.295
							71.63	77.72	6.10	2.911
							83.82	86.87	3.05	0.948
							27.43	41.15	13.72	0.750
TF-3704	225.552	-50	205	780 W	Phase 5	Ramp	96.01	99.06	3.05	0.576
							105.16	131.06	25.91	0.406
							138.68	143.26	4.57	0.598
							149.35	163.07	13.72	0.454
							167.64	170.69	3.05	2.858
							193.55	196.60	3.05	19.298
							32.00	39.62	7.62	0.479
TF-3705	225.552	-55	205	740 W	Phase 5	Ramp	62.48	65.53	3.05	3.462

Drill Hole Number	Depth (m)	Angle (°)	Az (°)	Section Line	Mine Phase	Bench (Elev)	Mineral Drill Intersections			
							From (m)	To (m)	True Width (m)	Au (g/t)
							111.25	115.82	4.57	0.428
							185.93	195.07	9.14	1.606
							0.00	9.14	9.14	0.507
TF-3706	201.168	-50	205	900 W	Phase 5	Ramp	27.43	44.20	16.76	0.344
							53.34	64.01	10.67	0.556
							74.68	89.92	15.24	0.419
							96.01	103.63	7.62	0.402
							175.26	179.83	4.57	1.032
							0.00	4.57	4.57	1.054
TF-3708	152.4	-55	205	880 W	Phase 5	494	30.48	53.34	22.86	0.410
							64.01	67.06	3.05	3.206
							112.78	123.44	10.67	0.600
							15.24	21.34	6.10	0.492
TF-3709	115.824	-60	205	920 W	Phase 5	494	56.39	62.48	6.10	1.165
							91.44	97.54	6.10	0.433
							86.87	92.96	6.10	0.387
TF-3710	103.632	-60	205	960 W	Phase 5	Ramp	10.67	25.91	15.24	0.612
TF-3712	219.456	-90	0	780 W	Phase 5	494	33.53	57.91	24.38	0.446
							88.39	96.01	7.62	5.342
							100.58	103.63	3.05	0.963
							109.73	115.82	6.10	1.091
							121.92	131.06	9.14	1.230
							143.26	146.30	3.05	4.324
							7.62	12.19	4.57	1.169
TF-3713	134.112	-45	205	940 W	Phase 5	Ramp	70.10	82.30	12.19	0.428
							4.57	12.19	7.62	0.694
TF-3714	80.772	-90	0	660 W	Phase 5	494	62.48	67.06	4.57	0.893
							73.15	80.77	7.62	0.719
							0.00	22.86	22.86	0.667
TF-3715	158.496	-60	205	920 W	Phase 5	Ramp	57.91	79.25	21.34	0.473
							96.01	109.73	13.72	1.195
							19.81	50.29	30.48	0.571
TF-3716	82.296	-60	205	1020 W	Phase 5	Ramp	44.20	60.96	16.76	0.412
TF-3717	121.92	-90	0	980 W	Phase 5	Ramp	99.06	103.63	4.57	0.802
							42.67	54.86	12.19	2.310
TF-3718	240.792	-55	205	860 W	Phase 5	578	70.10	94.49	24.38	0.711
							126.49	141.73	15.24	1.301
							176.78	187.45	10.67	0.726
							193.55	204.22	10.67	0.637
							213.36	222.50	9.14	0.497
							230.12	233.17	3.05	0.674
							70.10	80.77	10.67	0.388
TF-3719	182.88	-70	205	860 W	Phase 5	578	94.49	97.54	3.05	1.498
							114.30	129.54	15.24	0.516
							42.67	51.82	9.14	0.559
TF-3720	262.128	-70	205	760 W	Phase 5	578	77.72	83.82	6.10	1.782

Drill Hole Number	Depth (m)	Angle (°)	Az (°)	Section Line	Mine Phase	Bench (Elev)	Mineral Drill Intersections			
							From (m)	To (m)	True Width (m)	Au (g/t)
							185.93	201.17	15.24	2.695
							216.41	225.55	9.14	0.552
							243.84	262.13	18.29	0.762
							9.14	12.19	3.05	3.329
TF-3721	152.4	-45	205	800 W	Phase 5	488	48.77	53.34	4.57	0.362
							57.91	64.01	6.10	1.541
							89.92	103.63	13.72	1.122
TF-3722	201.168	-45	205	600 W	Phase 5	578	146.30	152.40	6.10	2.479
							158.50	184.40	25.91	1.391
							140.21	149.35	9.14	0.288
TF-3723	252.984	-60	205	980 W	Phase 5	632	173.74	176.78	3.05	0.455
							0.00	6.10	6.10	1.215
TF-3724	91.44	-90	0	120 W	Las Barajitas	701	19.81	25.91	6.10	0.321
							47.24	59.44	12.19	0.798
							27.43	30.48	3.05	0.528
TF-3725	67.056	-65	205	140 W	Las Barajitas	701	35.05	39.62	4.57	0.344
							42.67	45.72	3.05	0.717
							6.10	13.72	7.62	1.062
TF-3726	60.96	-65	205	100 W	Las Barajitas	701	27.43	30.48	3.05	0.855
							48.77	57.91	9.14	0.221
							7.62	10.67	3.05	0.868
TF-3727	54.864	-65	205	060 W	Las Barajitas	701	45.72	50.29	4.57	0.449
							6.10	21.34	15.24	0.777
TF-3728	60.96	-65	205	060 W	Las Barajitas	701	27.43	30.48	3.05	0.774
							21.34	32.00	10.67	0.513
TF-3729	73.152	-90	0	080 W	Las Barajitas	701	48.77	51.82	3.05	2.007
							54.86	60.96	6.10	0.461
							25.91	32.00	6.10	0.827
TF-3730	103.632	-65	205	100 W	Las Barajitas	701	92.96	102.11	9.14	0.890
							15.24	19.81	4.57	1.995
TF-3731	36.576	-90	0	080 W	Las Barajitas	701	33.53	41.15	7.62	0.275
TF-3732	67.056	-90	0	040 W	Las Barajitas	701	18.29	30.48	12.19	0.570
TF-3733	80.772	-55	205	040 W	Las Barajitas	701	15.24	19.81	4.57	1.112
TF-3734	60.96	-90	0	000	Las Barajitas	701	0.00	10.67	10.67	0.380
TF-3736	42.672	-90	0	120 W	Las Barajitas	701	36.58	41.15	4.57	4.211
							13.72	22.86	9.14	0.434
TF-3739	79.248	205	-70	3460 W	NW	692	25.91	35.05	9.14	2.252
							45.72	53.34	7.62	0.292
TF-3740	100.584	205	-70	3460 W	NW	692	91.44	94.49	3.05	0.276
							60.96	64.01	3.05	0.825
TF-3741	91.44	205	-70	3440 W	NW	692	12.19	15.24	3.05	0.387
TF-3742	76.2	205.00	-70	3420 W	NW	692	32.00	41.15	9.14	1.541

Drill Hole Number	Depth (m)	Angle (°)	Az (°)	Section Line	Mine Phase	Bench (Elev)	Mineral Drill Intersections			
							From (m)	To (m)	True Width (m)	Au (g/t)
TF-3743	91.44	205	-70	3420 W	NW	692	33.53	38.10	4.57	0.589
TF-3744	97.536	205	-70	3400 W	NW	692	35.05	38.10	3.05	0.600
TF-3745	79.248	205	-70	3500 W	NW	692	6.10	12.19	6.10	0.578
TF-3748	79.248	205	-70	3440 W	NW	692	73.15	79.25	6.10	0.243
TF-3749	91.44	205	-70	3440 W	NW	692	24.38	28.96	4.57	1.677
TF-3750	79.248	205	-70	3420 W	NW	692	1.52	4.57	3.05	0.301
TF-3753	67.056	205	-70	3480 W	NW	692	50.29	54.86	4.57	0.330
							3.05	6.10	3.05	0.282
TF-3754	54.864	205	-70	3400 W	NW	692	9.14	13.72	4.57	0.401
							9.14	12.19	3.05	0.342
TF-3756	82.296	205	-70	3380 W	NW	692	21.34	24.38	3.05	0.369
TF-3757	91.44	205	-70	3360 W	NW	692	35.05	50.29	15.24	0.310
							7.62	10.67	3.05	0.310
TF-3758	109.728	205	-70	3360 W	NW	692	16.76	21.34	4.57	0.275
							44.20	56.39	12.19	0.774
							27.43	32.00	4.57	0.606
TF-3759	82.296	205	-70	3340 W	NW	692	12.19	18.29	6.10	0.352
TF-3760	91.44	205	-70	3380 W	NW	692	24.38	36.58	12.19	0.653
							45.72	48.77	3.05	0.360
							4.57	7.62	3.05	3.229
TF-3761	79.248	205	-70	3460 W	NW	692	42.67	47.24	4.57	0.414
							10.67	13.72	3.05	0.296
TF-3763	79.248	205	-70	3440 W	NW	692	47.24	51.82	4.57	1.527
TF-3764	152.4	270	-55	3320 W	NW	692	73.15	82.30	9.14	0.383
							94.49	100.58	6.10	0.621
							64.01	67.06	3.05	0.304
TF-3765	73.152	205	-70	2500 W	NORTH	710	0.00	3.05	3.05	0.606
TF-3766	54.864	205	-70	2540 W	NORTH	710	41.15	47.24	6.10	2.138
							38.10	42.67	4.57	0.323
TF-3767	73.152	205	-70	2520 W	NORTH	710	25.91	33.53	7.62	1.799
TF-3769	42.672	205	-70	2600 W	NORTH	710				

Table provided by Alio Gold Inc. and dated May, 2017.

Figure 10.19 and Figure 10.20 show the locations of the July, 2016 to March, 2017 in-fill drilling in the areas of the San Francisco and La Chicharra pits, respectively.

**Figure 10.19**  
**Location of the July, 2016 to March, 2017 In-Fill Drilling Program in the Area of the San Francisco Pit**

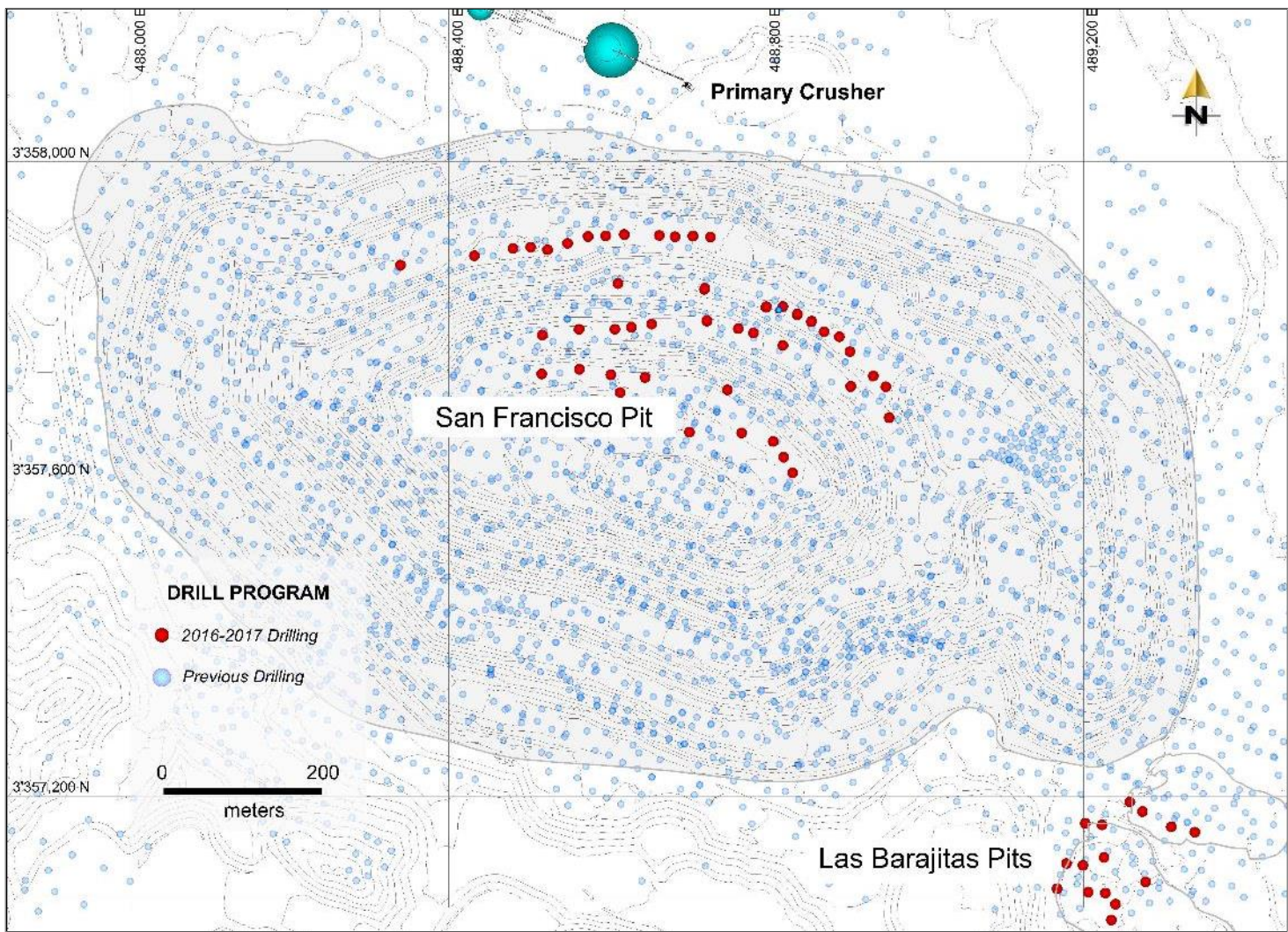


Figure provided by Alio Gold Inc. and dated May, 2017.

**Figure 10.20**  
Location of the July, 2016 to March, 2017 In-Fill Drilling Program in the Area of the La Chicharra Pit

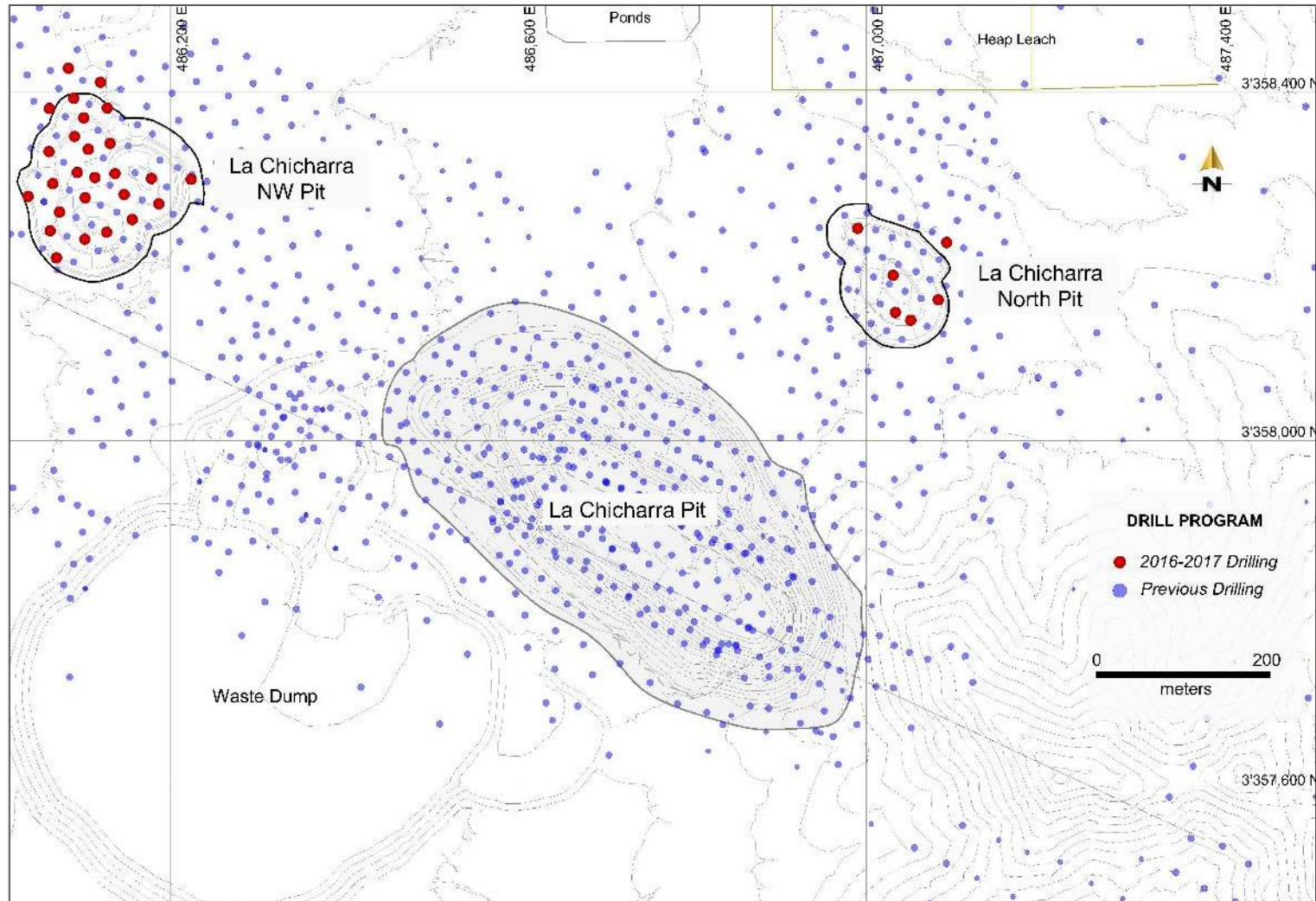


Figure provided by Alio Gold Inc. and dated May, 2017.



## 10.7 2017 IN-FILL DRILLING PROGRAM FOR THE SAN FRANCISCO MINE

An in-fill drilling program for extraction of Phases 7 and 8 of the mine plan was proposed in May, 2017, and a total of USD 2.3 million was approved for 31,200 m of RC drilling. The original proposal for this budget called for both in-fill and exploration drilling on the north side of the San Francisco pit, from the site of the primary crushers in the southeast and northwest directions. Once it was decided to include Phase 8 in the mine plan, in-fill drilling was needed to confirm the resources in this phase, in addition to confirming the resources contained in Phase 7.

In the period from August to December, 2017, 140 RC holes totalling 28,416.50 m were drilled within and at the periphery of the San Francisco pit (including Las Barajitas to the southeast of the San Francisco pit and in the Cementerio area at the bottom western extremity of the pit).

A total of 20,855 chip samples were generated during the drilling program. The chip samples were shipped to ALS Global Commodity for preparation in Hermosillo, Sonora, with the pulps sent to its laboratory in Vancouver, Canada, for gold assaying. All transportation and handling of samples from the mine site to the preparation laboratory in Hermosillo was conducted by ALS Global personnel. The sample stream included quality assurance and quality control (QA/QC) samples.

The main objective of the drilling was to confirm the continuity of the mineralization in Phase 6 of the mine plan. While the the drilling program was planned to be completed in 3 months using three drill rigs, circumstances related to mine operations, along with continuous changes to the mine plan, resulted in the drilling being delayed and completion of the program did not occur until the middle of December. Also some of drill holes in the original program were cancelled, leaving some zones in Phase 6 without vital information.

Taking advantage of the position of the drill pads, most of the drill holes in Phase 6 were continued at depth to explore and to partly confirm the projection at depth of the mineralization for Phase 7 and Phase 8. The assay results of the drilling for the Phase 6 basically confirmed the existing resources, as expected.

Table 10.16 summarizes the significant assays for the 2017 drilling program from August to December.

Figure 10.21 shows the locations of the holes drilled during the 2017 program on the San Francisco pit, including the Cementerio and Las Barajitas areas.

**Table 10.16**  
**Significant Assay Intercepts, August to December, 2017 Reverse Circulation Drill Program**

Drill Hole Number	Drill Hole Details						Mineralized Intervals				
	Depth (m)	Azimuth (°)	Angle (°)	Section Line	Mine Phase	Bench Elevation	From (m)	To (m)	Width (m)	Au (g/t)	
TF-3840	134.11	205	-50.00	380W	Phase 6	654.60	83.82	96.01	12.19	0.442	
TF-3841	207.26	205	-65.00	540W	Phase 6	638.01	71.62	89.92	18.30	1.204	
TF-3842	201.17	205	-70.00	480W	Phase 6	548.60	3.05	36.58	33.53	1.102	
TF-3844	231.65	205	-80.00	420W	Phase 6	651.03	64.01	79.25	15.24	1.902	
					Exploration		164.59	179.83	15.24	1.051	
					Exploration		198.12	227.08	28.96	0.800	
TF-3849	353.57	0	-90.00	420W	Phase 6	569.09	89.92	115.82	25.91	0.996	
					Exploration		211.84	230.12	18.29	1.722	
					Exploration		237.74	249.94	12.19	1.330	
					Exploration		256.03	275.84	19.81	0.641	
					Exploration		286.51	303.28	16.76	0.804	
					Exploration		309.37	313.94	4.57	3.687	
TF-3850	323.09	205	-70.00	400W	Exploration	598.75	210.31	249.94	39.62	0.698	
TF-3856	310.90	205	-75.00	480W	Exploration	588.08	120.40	147.83	27.43	0.745	
					Exploration		155.45	166.12	10.67	3.231	
					Exploration		230.12	286.51	56.39	1.012	
TF-3857	332.23	205	-73.00	560W	Exploration	691.33	155.45	172.21	16.76	0.578	
					Exploration		303.28	332.23	28.96	1.044	
TF-3858	262.13	205°	-67.00	460W	Phase 6	590.70	70.10	74.68	4.57	1.394	
					Phase 6		108.20	123.44	15.24	1.034	
					Phase 6		128.00	131.06	3.06	0.663	
					Phase 6		138.68	149.35	10.67	1.365	
					Exploration		216.41	228.60	12.19	0.305	
					Exploration		233.17	262.13	28.96	1.142	
TF-3859	167.64	205	-47.00	600W	Phase 6	703.36	62.48	71.63	9.14	0.819	
					Exploration		161.54	169.16	7.62	5.841	
					Exploration		173.74	178.31	4.57	0.416	
					Exploration		195.07	233.17	38.10	0.579	
TF-3861	292.61	205	-63.00	720W	Exploration	566.16	105.16	111.25	6.10	2.262	
					Exploration		164.59	199.64	35.05	0.910	
					Exploration		243.84	256.03	12.19	6.294	
					Exploration		including 246.89	248.41	1.52	43.100	
					Exploration		262.13	274.32	12.19	0.507	
					Exploration		286.51	292.61	6.10	0.286	
TF-3864	286.51	205	-63.00	620W	Exploration	565.83	124.97	135.64	10.67	1.685	
					Exploration		147.83	169.16	21.34	0.789	
					Exploration		175.26	201.17	25.91	0.736	
TF-3865	301.75	205	-70.00	500W	Phase 6	566.24	36.58	41.15	4.57	0.340	
					Exploration		131.06	134.11	3.05	1.330	
					Exploration		202.69	211.84	9.14	0.717	
TF-3866	286.51	205	-75.00	540W	Phase 6	566.09	27.43	36.58	9.14	0.521	
					Phase 8		100.58	106.68	6.10	0.468	
					Phase 8		128.02	137.16	9.14	0.494	
					Phase 8		141.73	152.40	10.67	0.787	
					Exploration		167.64	176.78	9.14	0.996	
					Exploration		182.88	192.02	9.14	0.953	
TF-3867	301.50	0	-90.00	560W	Phase 6	566.20	30.48	35.05	4.57	0.329	
					Phase 8		141.73	167.64	25.91	1.389	
					Exploration		178.31	196.60	18.29	0.630	
					Exploration		208.79	213.36	4.57	0.429	
TF-3868	140.21	0	-90.00	520W	Phase 6	566.50	22.86	27.43	4.57	1.611	
TF-3869	173.4	0	-90.00	460W	Phase 6	593.11	19.81	22.86	3.05	0.371	
					Phase 6		51.82	57.91	6.10	0.335	
					Phase 8		112.78	124.97	12.19	2.882	
					Phase 8		Including 120.40	123.44	3.05	6.500	

Drill Hole Number	Drill Hole Details						Mineralized Intervals				
	Depth (m)	Azimuth (°)	Angle (°)	Section Line	Mine Phase	Bench Elevation		From (m)	To (m)	Width (m)	Au (g/t)
TF-3870	353.57	0	-90.00	460W	Phase 6	590.39		9.14	18.29	9.14	0.239
					Phase 8			111.25	115.82	4.57	1.395
					Exploration			124.97	129.54	4.57	1.086
					Exploration			140.21	150.88	10.67	0.838
					Exploration			153.92	158.50	4.57	0.660
					Exploration			283.46	303.28	19.81	1.414
					Exploration		including	294.13	301.75	7.62	2.198
					Exploration			310.90	327.66	16.76	0.489
TF-3871	353.57	205	-80.00	440W	Phase 6	596.09		64.01	67.06	3.05	1.004
					Phase 8			77.72	83.82	6.10	0.701
					Exploration			155.45	163.07	7.62	1.252
					Exploration			198.12	228.60	30.48	0.636
					Exploration		including	198.12	204.22	6.10	1.109
					Exploration			301.75	304.80	3.05	0.349
					Exploration			307.85	312.42	4.57	0.296
					TF-3872		256.03	0	-90.00	480W	Phase 6
Exploration		128.02	134.11	6.10		0.296					
Exploration		143.26	152.40	9.14		0.845					
Exploration		170.69	173.74	3.05		0.245					
Exploration		176.78	187.45	10.67		0.749					
Exploration		202.69	207.26	4.57		0.702					
Exploration		254.51	256.03	1.52		1.170					
TF-3873	182.88	205	-55.00	880W		Phase 5					542.64
					Phase 5		25.91	30.48	4.57	0.622	
					Phase 5		38.10	41.15	3.05	1.156	
					Phase 5		47.24	48.77	1.52	6.530	
					Phase 5		59.44	109.73	50.29	0.917	
					Phase 5	including	73.15	79.25	6.10	1.683	
					Phase 5	including	83.82	86.87	3.05	1.395	
					Phase 5		112.78	115.82	3.05	0.488	
					Exploration		156.97	160.02	3.05	1.568	
					Exploration		175.26	178.31	3.05	1.568	
TF-3874	304.80	205	-70.00	540W	Phase 6	580.84		44.20	47.24	3.05	1.823
					Phase 8			115.82	132.59	16.76	0.840
					Phase 8			143.26	150.88	7.62	1.953
					Exploration			187.45	192.02	4.57	0.490
					Exploration			246.89	304.80	57.91	1.043
					Exploration		including	269.75	280.42	10.67	1.812
					Exploration		including	295.66	304.80	9.14	1.288
					TF-3875		195.07	205	-80.00	820W	Phase 5
Phase 5		22.86	27.43	4.57		4.049					
Phase 5	including	22.86	24.38	1.52		11.650					
Phase 5		30.48	33.53	3.05		0.564					
Phase 6		112.78	129.54	16.76		0.357					
Phase 6		134.11	147.83	13.72		1.594					
Phase 6	including	138.68	141.73	3.05		5.100					
Phase 8		150.88	152.40	1.52		2.010					
Phase 8		164.59	169.16	4.57		8.080					
Phase 8	including	164.59	166.12	1.52		22.700					
Phase 8		182.88	185.93	3.05		0.377					
Phase 8		193.55	195.07	1.52		0.650					
TF-3876	341.38	0	-90.00	560W		Phase 6					578.93
					Phase 8		118.87	121.92	3.05	0.530	
					Phase 8		126.49	129.54	3.05	0.835	
					Exploration		137.16	140.21	3.05	0.890	
					Exploration		196.60	199.64	3.05	0.772	
					Exploration		204.22	219.46	15.24	0.620	

Drill Hole Number	Drill Hole Details						Mineralized Intervals				
	Depth (m)	Azimuth (°)	Angle (°)	Section Line	Mine Phase	Bench Elevation		From (m)	To (m)	Width (m)	Au (g/t)
					Exploration			295.66	324.61	28.96	1.346
					Exploration		including	301.75	307.85	6.10	1.524
					Exploration		including	313.94	323.09	9.14	2.089
					Exploration			329.18	333.76	4.57	0.518
					Exploration			336.80	341.38	4.57	0.942
					Exploration		including	339.85	341.38	1.52	1.190
TF-3877	268.22	205	-75.00	660W	Phase 5	560.20		51.82	57.91	6.10	0.446
					Phase 6			83.82	94.49	10.67	0.397
					Phase 6			132.59	140.21	7.62	1.300
					Phase 6			163.07	167.64	4.57	3.768
					Phase 6			170.69	175.26	4.57	0.261
					Phase 6			181.36	185.93	4.57	0.447
					Phase 6			190.50	195.07	4.57	0.245
					Exploration			198.12	201.17	3.05	0.450
					Exploration			204.22	225.55	21.34	1.328
					Exploration		including	208.79	217.93	9.14	1.806
					Exploration			230.12	242.32	12.19	0.396
					Exploration			263.65	266.70	3.05	0.325
TF-3878	140.21	205	-70.00	580W	Phase 6	633.97		60.96	71.63	10.67	1.048
					Phase 6			134.11	137.16	3.05	1.876
TF-3879	371.86	0	-90.00	580W	Phase 6	577.51		4.57	7.62	3.05	0.346
					Phase 8			123.44	126.49	3.05	0.413
					Exploration			199.64	225.55	25.91	0.890
					Exploration		including	199.64	205.74	6.10	1.945
					Exploration			304.80	312.42	7.62	1.060
					Exploration			316.99	339.85	22.86	0.416
					Exploration			344.42	350.52	6.10	0.313
					Exploration		including	362.71	364.24	1.52	2.910
TF-3880	381.00	205	-70.00	520 W	Phase 6	639.86		36.58	39.62	3.05	1.430
					Phase 6			76.20	80.77	4.57	1.301
					Phase 6			96.01	105.16	9.14	1.070
					Exploration			187.45	190.50	3.05	0.459
					Exploration			204.22	208.79	4.57	0.414
					Exploration			213.36	216.41	3.05	1.017
					Exploration			219.46	224.03	4.57	0.503
					Exploration			227.08	262.13	35.05	0.852
					Exploration		including	242.32	251.46	9.14	1.931
					Exploration			265.18	269.75	4.57	0.377
					Exploration			277.37	283.46	6.10	1.343
					Exploration		including	281.94	283.46	1.52	4.010
					Exploration			341.38	365.76	24.38	0.800
					Exploration		including	349.00	353.57	4.57	1.320
TF-3883	335.28	205	-75.00	580 W	Phase 6	577.72		60.96	64.01	3.05	0.537
					Phase 6			91.44	94.49	3.05	1.045
					Phase 6			100.58	105.16	4.57	0.288
					Phase 8			109.73	118.87	9.14	0.534
					Phase 8			128.02	137.16	9.14	0.628
					Phase 8			141.73	146.30	4.57	0.357
					Exploration			173.74	179.83	6.10	0.378
					Exploration			182.88	188.98	6.10	0.464
					Exploration			231.65	233.17	1.52	1.830
					Exploration			237.74	245.36	7.62	0.576
					Exploration			248.41	268.22	19.81	0.413
					Exploration			272.80	289.56	16.76	0.324
					Exploration			300.23	306.32	6.10	0.439
					Exploration			309.37	315.47	6.10	0.313
TF-3884	381.00	0	-90.00	520 W	Phase 8	637.93		83.82	91.44	13.72	1.042
					Phase 8		including	88.39	97.54	9.14	3.220

Drill Hole Number	Drill Hole Details						Mineralized Intervals				
	Depth (m)	Azimuth (°)	Angle (°)	Section Line	Mine Phase	Bench Elevation		From (m)	To (m)	Width (m)	Au (g/t)
					Phase 8			105.16	111.25	6.10	0.338
					Exploration			167.64	172.21	4.57	1.187
					Exploration			220.98	227.08	6.10	0.294
					Exploration			275.84	284.99	9.14	0.704
					Exploration			280.42	283.46	3.05	1.455
					Exploration			303.28	310.90	7.62	0.626
					Exploration			326.14	330.71	4.57	0.883
					Exploration			335.28	347.47	12.19	0.833
					Exploration		including	336.80	339.85	3.05	1.893
					Exploration			353.57	365.76	12.19	0.422
TF-3886	207.26	205	-55.00	940 W	Phase 6	686.03		28.96	36.58	7.62	0.361
					Phase 8			105.16	108.20	3.05	1.266
					Phase 8			121.92	128.02	6.10	1.017
					Phase 8			124.97	126.49	1.52	2.500
					Phase 8			187.45	192.02	4.57	0.301
TF-3888	353.57	0	-90.00	600 W	Phase 6	575.62		9.14	12.19	3.05	1.773
					Phase 6			71.63	76.20	4.57	0.320
					Phase 8			108.20	118.87	10.67	0.395
					Exploration			175.26	178.31	3.05	0.571
					Exploration			199.64	205.74	6.10	0.269
					Exploration			214.88	228.60	13.72	1.100
					Exploration			243.84	249.94	6.10	0.482
					Exploration			257.56	262.13	4.57	1.909
					Exploration			281.94	289.56	7.62	1.042
					Exploration			283.46	286.51	3.05	1.475
TF-3889	243.84	205	-60.00	920 W	Phase 6	686.07		0.00	4.57	4.57	0.546
					Phase 6			38.10	41.15	3.05	0.234
					Phase 6			48.77	51.82	3.05	0.798
					Phase 8			179.83	185.93	6.10	0.270
					Phase 6			4.57	6.10	1.52	1.300
TF-3891	347.47	205	-75.00	860 W	Phase 6	685.67		18.29	24.38	6.10	0.992
					Phase 6		including	18.29	21.34	3.05	1.398
					Phase 6			28.96	32.00	3.05	0.455
					Phase 6			77.72	83.82	6.10	0.363
					Phase 8			106.68	108.20	1.52	1.670
					Phase 8			134.11	137.16	3.05	1.430
					Phase 8			161.54	164.59	3.05	0.883
					Phase 8			210.31	213.36	3.05	1.233
					Phase 8			224.03	225.55	1.52	1.155
					Exploration			236.22	239.27	3.05	0.317
					Exploration			242.32	252.98	10.67	0.584
					Exploration			257.56	271.27	13.72	1.108
					Exploration		including	262.13	266.70	4.57	2.403
					Exploration			295.66	298.70	3.05	0.297
TF-3893	316.99	205	-75.00	640 W	Phase 8	572.49		99.06	103.63	4.57	0.304
					Phase 8			108.20	111.25	3.05	0.366
					Exploration			227.08	231.65	4.57	0.491
					Exploration			236.22	246.89	10.67	0.555
					Exploration			260.60	266.70	6.10	0.411
					Exploration			289.56	292.61	3.05	0.882
TF-3895	304.80	205	-55.00	840 W	Phase 6	685.74		19.81	32.00	12.19	0.323
					Phase 6			118.87	121.92	3.05	0.312
					Phase 6			129.54	132.59	3.05	0.704
					Phase 8			169.16	172.21	3.05	2.388
					Phase 8			175.26	179.83	4.57	0.794

Drill Hole Number	Drill Hole Details						Mineralized Intervals				
	Depth (m)	Azimuth (°)	Angle (°)	Section Line	Mine Phase	Bench Elevation		From (m)	To (m)	Width (m)	Au (g/t)
					Phase 8			210.31	213.36	3.05	0.599
					Phase 8			233.17	236.22	3.05	0.843
					Phase 8			246.89	262.13	15.24	0.774
					Phase 8			288.04	295.66	7.62	0.937
					Phase 8			300.23	303.28	3.05	0.301
TF-3896	329.18	205	-70.00	640 W	Phase 6	572.51		0.00	4.57	4.57	3.027
					Phase 6			71.63	74.68	3.05	0.408
					Phase 6			88.39	106.68	18.29	0.947
					Phase 8			131.06	141.73	10.67	0.271
					Phase 8			153.92	173.74	19.81	0.439
					Exploration			182.88	193.55	10.67	4.491
					Exploration			227.08	231.65	4.57	0.420
					Exploration			234.70	249.94	15.24	0.738
					Exploration			271.27	281.94	10.67	0.330
TF-3899	353.57	205	-70.00	660 W	Phase 6	570.88		27.43	30.48	3.05	0.836
					Phase 6			89.92	91.44	1.52	3.290
					Phase 6			96.01	99.06	3.05	0.304
					Phase 8			123.44	126.49	3.05	0.681
					Phase 8			131.06	137.16	6.10	0.303
					Phase 8			149.35	150.88	1.52	1.120
					Exploration			176.78	199.64	22.86	0.623
					Exploration		including	188.98	195.07	6.10	5.505
					Exploration			208.79	214.88	6.10	0.466
					Exploration			234.70	274.32	39.62	0.775
					Exploration		including	259.08	263.65	4.57	1.628
TF-3900	329.18	205	-70.00	800 W	Phase 6	685.77		0.00	12.19	12.19	0.538
					Phase 8			141.73	147.83	6.10	0.706
					Exploration			193.55	199.64	6.10	0.338
					Exploration			202.69	220.98	18.29	0.593
TF-3903	310.90	205	-70.00	680 W	Phase 6	568.97		108.20	114.30	6.10	0.388
					Exploration			176.78	190.50	13.72	0.383
					Exploration			193.55	201.17	7.62	0.639
					Exploration			225.55	231.65	6.10	0.983
					Exploration			236.22	239.27	3.05	1.588
					Exploration			242.32	275.84	33.53	1.421
					Exploration		including	248.41	266.70	18.29	1.939
					Exploration			286.51	291.08	4.57	0.386
					Exploration			295.66	303.28	7.62	0.939
					Exploration		including	298.70	301.75	3.05	1.863
TF-3904	297.18	205	-80.00	700 W	Phase 6	566.90		65.53	79.25	13.72	0.912
					Phase 6			82.30	86.87	4.57	0.854
					Phase 6			91.44	94.49	3.05	0.302
					Phase 8			118.87	128.02	9.14	0.283
					Exploration			184.40	187.45	3.05	0.643
					Exploration			210.31	214.88	4.57	0.477
					Exploration			234.70	239.27	4.57	0.215
					Exploration			246.89	249.94	3.05	0.255
					Exploration			254.51	271.27	16.76	0.881
					Exploration		including	265.18	268.22	3.05	1.898
					Exploration			274.32	284.99	10.67	0.594
					Exploration			294.13	297.18	3.05	0.415
					TF-3905		190.50	205	-60.00	820 W	Phase 6
Phase 8		89.92	94.49	4.57		2.008					
Phase 8		121.92	126.49	4.57		0.359					
Phase 8		134.11	137.16	3.05		2.070					
Phase 8		140.21	146.30	6.10		0.305					
Phase 8		149.35	158.50	9.14		2.303					

Drill Hole Number	Drill Hole Details						Mineralized Intervals				
	Depth (m)	Azimuth (°)	Angle (°)	Section Line	Mine Phase	Bench Elevation		From (m)	To (m)	Width (m)	Au (g/t)
TF-3906	249.94	205	-85.00	720 W	Phase 8	566.09	including	149.35	155.45	6.10	3.155
					Phase 6			3.05	9.14	6.10	0.386
					Phase 8			73.15	86.87	13.72	0.707
					Exploration			118.87	123.44	4.57	0.887
					Exploration			146.30	153.92	7.62	0.540
TF-3921	89.92	205	-75.00	980 W	Exploration	535.91		51.82	56.39	4.57	0.422
					Exploration			59.44	62.48	3.05	0.627
					Exploration			79.25	89.92	10.67	1.376
TF-3922	237.74	0	-90.00	960 W	Phase 6	539.87		35.05	39.62	4.57	0.449
					Exploration			41.15	51.82	10.67	0.685
					Exploration			68.58	73.15	4.57	0.679
					Exploration			82.30	83.82	1.52	5.230
					Exploration			103.63	114.30	10.67	0.444
					Exploration			131.06	134.11	3.05	0.393
					Exploration			152.40	161.54	9.14	0.553
					Exploration			170.69	178.31	7.62	0.549
					Exploration			205.74	207.26	1.52	2.560
					Exploration			210.31	211.84	1.52	1.770
TF-3923	216.41	205	-70.00	460 W	Exploration	533.91		114.30	135.64	21.34	1.093
					Exploration		including	118.87	124.97	6.10	1.818
TF-3924	298.70	0	-90.00	560 W	Phase 8	583.49		111.25	124.97	13.72	2.417
					Phase 8		including	111.25	112.78	1.52	15.300
					Phase 8			128.02	132.59	4.57	0.749
					Exploration			181.36	185.93	4.57	0.359
					Exploration			188.98	192.02	4.57	0.403
					Exploration			245.36	252.98	6.10	0.408
TF-3925	128.02	205	-70.00	460 W	Phase 6	593.22		48.77	51.82	3.05	1.665
					Phase 6			85.34	86.87	1.52	0.568
TF-3926	382.52	205	-65.00	440 W	Exploration	648.48		213.36	220.98	7.62	0.671
					Exploration			251.46	256.03	3.05	0.557
					Exploration			272.80	286.51	13.72	2.414
					Exploration			289.56	292.61	3.05	1.086
					Exploration			297.18	301.75	4.57	0.455
					Exploration			313.94	323.09	9.14	0.613
					Exploration			329.18	353.57	24.38	0.617
					Exploration		including	341.38	349.00	7.62	1.320
					Phase 6			35.05	39.62	4.57	5.161
					Phase 6			57.91	62.48	4.57	0.966
TF-3927	182.88	0°	-90.00	540 W	Exploration			169.16	173.74	4.57	0.317
					Phase 6			10.67	13.72	3.05	1.777
					Phase 6			38.10	41.15	3.05	0.302
TF-3928	251.46	205°	-60.00	420 W	Exploration	599.59		138.68	143.26	4.57	0.704
					Exploration			163.07	169.16	6.10	0.473
					Exploration			198.12	220.98	22.86	0.763
					Exploration		including	210.31	214.88	4.57	2.012
					Exploration			227.08	230.12	3.05	0.326
					Phase 8			56.39	59.44	3.05	7.265
					Exploration			85.34	92.96	7.62	0.900
TF-3929	128.02	205	-70.00	360 W	Phase 6	603.55		19.81	22.86	3.05	0.375
					Exploration			44.20	47.24	3.05	0.284
					Exploration			94.49	97.54	3.05	0.601
					Exploration			111.25	115.82	4.57	0.319
TF-3930	120.40	0	-90.00	1020 W	Phase 6	531.14		42.67	45.72	3.05	0.641
					Phase 8			60.96	73.15	12.19	0.497
					Exploration			86.87	92.96	6.10	1.426
					Exploration			96.01	102.11	6.10	<b>0.651</b>

Drill Hole Number	Drill Hole Details						Mineralized Intervals				
	Depth (m)	Azimuth (°)	Angle (°)	Section Line	Mine Phase	Bench Elevation		From (m)	To (m)	Width (m)	Au (g/t)
TF-3932	120.40	0	-90.00	1020 W	Exploration	529.44		103.63	109.73	6.10	<b>1.274</b>
					Exploration		including	105.16	108.20	3.05	<b>1.968</b>
					Phase 6			28.96	32.00	3.05	<b>1.049</b>
					Exploration			62.48	67.06	4.57	0.410
					Exploration			112.78	115.82	3.05	<b>0.690</b>
TF-3933	188.98	205	-71.00	520 W	Phase 8	583.72		100.58	108.20	7.62	<b>1.087</b>
					Phase 8			152.40	156.97	4.57	0.453
					Exploration			182.88	188.98	6.10	<b>1.879</b>
TF-3934	152.40	205	-65.00	480 W	Phase 6	644.04		86.87	97.54	10.67	<b>0.701</b>
					Phase 6			105.16	114.30	9.14	<b>1.272</b>
TF-3936	280.42	235	-65.00	500 W	Phase 6	603.48		21.34	24.38	3.05	0.351
					Phase 6			74.68	86.87	12.19	<b>0.873</b>
					Phase 6			91.44	99.06	7.62	<b>0.996</b>
					Phase 6			115.82	124.97	9.14	0.260
					Exploration			176.78	199.64	22.86	<b>0.961</b>
					Exploration			233.17	240.79	7.62	0.482
					Exploration			249.94	252.98	3.05	0.434
TF-3937	371.86	205	-70.00	400 W	Phase 6	653.30		79.25	94.49	15.24	0.293
					Phase 6			103.63	111.25	7.62	<b>1.412</b>
					Phase 6			135.64	138.68	3.05	0.398
					Exploration			164.59	167.64	3.05	0.285
					Exploration			188.98	204.22	15.24	0.717
					Exploration			260.60	266.70	6.10	3.973
					Exploration			281.94	284.99	3.05	0.398
					Exploration			292.61	313.94	21.34	0.644
					Exploration			332.23	339.85	7.62	0.569
					Exploration			344.42	353.57	9.14	0.831
TF-3938	155.45	190°	-70.00	340 W	Phase 6	608.31		32.00	42.67	10.67	0.504
					Phase 8			57.91	62.48	4.57	1.099
					Phase 8			73.15	76.20	3.05	1.154
					Phase 8			80.77	99.06	18.29	0.543
					Exploration			102.11	105.16	3.05	0.282
					Exploration			117.35	120.40	3.05	1.203
					Exploration			123.44	132.59	9.14	1.750
					Exploration			149.35	155.45	6.10	1.013
TF-3939	100.58	205	-70.00	340 W	Phase 6	606.34		22.86	25.91	3.05	0.445
					Phase 8			53.34	57.91	4.57	2.373
					Phase 8			82.30	85.34	3.05	0.847
					Exploration			91.44	100.58	7.62	0.892
TF-3940	140.21	0	-90.00	440 W	Phase 6	602.96		12.19	15.24	3.05	0.241
					Phase 8			80.77	83.82	3.05	<b>0.695</b>
					Phase 8			102.11	121.92	19.81	<b>0.896</b>
TF-3942	451.10	205	-80.00	500 W	Phase 6	641.70		48.77	51.82	3.05	<b>0.563</b>
					Phase 8			109.73	114.30	4.57	<b>0.525</b>
					Phase 8			123.44	126.49	3.05	0.354
					Exploration			228.60	240.79	12.19	<b>0.633</b>
					Exploration			246.89	251.46	4.57	<b>0.569</b>
					Exploration			266.70	278.89	10.67	<b>0.804</b>
					Exploration			281.94	288.04	6.10	<b>1.747</b>
					Exploration			306.32	309.37	3.05	0.456
					Exploration			315.47	323.09	7.62	0.420
					Exploration			355.09	358.14	3.05	0.729
					Exploration			365.76	373.38	7.62	0.651
					Exploration			381.00	388.62	7.62	0.759
					Exploration			425.20	428.24	3.05	0.704
Exploration		443.48	451.10	7.62	0.833						
TF-3943	214.88	205	-55.00	580 W	Phase 5	535.86		21.34	28.96	7.62	2.128



Drill Hole Number	Drill Hole Details						Mineralized Intervals				
	Depth (m)	Azimuth (°)	Angle (°)	Section Line	Mine Phase	Bench Elevation	From (m)	To (m)	Width (m)	Au (g/t)	
					Phase 5		50.29	56.39	6.10	0.874	
					Phase 5		82.30	89.92	7.62	0.535	
					Phase 6		94.49	97.54	3.05	1.006	
					Exploration		184.40	187.45	3.05	0.385	
TF-3944	152.40	205	-75.00	560 W	Phase 8	535.58	73.15	79.25	6.10	0.429	
					Phase 8		82.30	94.49	12.19	0.653	
					Phase 8		97.54	118.87	21.34	0.659	
					Phase 8		126.49	129.54	3.05	0.683	
					Exploration		134.11	144.78	10.67	0.502	
					Exploration		149.35	152.40	3.05	0.450	
TF-3945	155.45	205	-55.00	560 W	Phase 5	535.59	0	10.67	10.67	1.788	
					Phase 8		112.78	123.44	10.67	1.377	
					Exploration		135.64	140.21	4.57	2.133	
					Exploration		152.40	155.45	3.05	1.629	
TF-3946	207.26	205	-70.00	520 W	Phase 8	535.76	74.676	79.25	4.57	2.556	
					Exploration		83.82	112.78	28.96	0.818	
TF-3947	251.46	0	-90.00	620 W	Phase 6	536.27	85.344	89.92	4.57	0.641	
					Phase 8		123.44	128.02	4.57	0.554	
					Exploration		134.11	140.21	6.10	0.565	
					Exploration		155.45	158.50	3.05	0.818	
					Exploration		176.78	190.50	13.72	0.398	
					Exploration		216.41	219.46	3.05	0.465	
					Exploration		231.65	237.74	6.10	0.533	
					Exploration		245.36	249.94	4.57	0.659	
TF-3948	274.32	205	-75.00	800 W	Phase 6	53.12	7.62	13.72	4.57	0.632	
					Phase 6		21.34	28.96	7.62	1.180	
					Phase 6		70.10	88.39	18.29	0.403	
					Phase 8		109.73	112.78	3.05	0.562	
					Exploration		161.54	167.64	6.10	0.780	
					Exploration		190.50	195.07	4.57	2.290	
					Exploration		224.03	233.17	9.14	1.167	
					Exploration		236.22	243.84	7.62	0.387	
					Exploration		271.27	274.32	3.05	0.481	
TF-3949	353.57	205	-53.00	780 W	Phase 6	701.37	4.572	9.14	4.57	0.921	
					Phase 6		12.19	15.24	3.05	0.511	
					Phase 6		19.81	22.86	3.05	0.452	
					Phase 6		35.05	38.10	3.05	0.318	
					Phase 8		173.74	176.78	3.05	0.436	
					Phase 8		204.22	207.26	3.05	1.600	
					Phase 8		219.46	242.32	22.86	0.455	
					Exploration		274.32	284.99	10.67	0.646	
					Exploration		288.04	291.08	3.05	0.712	
					Exploration		316.99	321.56	4.57	0.312	
					Exploration		327.66	332.23	4.57	0.383	
					TF-3950		161.54	205	-70.00	300 W	Exploration
Exploration	131.06	144.78	13.72	0.627							
TF-3951	251.46	0	-90.00	380 W	Phase 8	654.70	85.344	89.92	4.57	1.501	
					Exploration		118.87	124.97	6.10	0.480	
					Exploration		147.83	156.97	9.14	0.494	
					Exploration		160.02	179.83	19.81	0.780	
					Exploration		236.22	243.84	7.62	3.080	
TF-3952	201.17	205	-75.00	360 W	Phase 8	643.68	86.868	88.39	1.52	7.640	
					Phase 8		92.96	106.68	13.72	3.177	
					Phase 8		109.73	115.82	6.10	0.434	
					Exploration		196.60	201.17	4.57	0.976	
TF-3955	131.06	205	-60.00	340 W	Phase 6	643.77	16.764	21.34	4.57	0.801	
TF-3956	329.18	205	-80.00	420 W	Phase 6	603.08	68.58	73.15	4.57	0.711	
					Phase 8		80.77	89.92	9.14	0.681	

Drill Hole Number	Drill Hole Details						Mineralized Intervals				
	Depth (m)	Azimuth (°)	Angle (°)	Section Line	Mine Phase	Bench Elevation		From (m)	To (m)	Width (m)	Au (g/t)
					Exploration			161.54	166.12	4.57	0.283
					Exploration			181.36	190.50	9.14	0.379
					Exploration			193.55	198.12	4.57	<b>0.509</b>
					Exploration			210.31	239.27	28.96	<b>1.255</b>
					Exploration		including	228.60	237.74	9.14	<b>2.112</b>
					Exploration			243.84	252.98	9.14	<b>0.777</b>
					Exploration			256.03	265.18	9.14	<b>1.174</b>
					Exploration			269.75	272.80	3.05	0.416
					Exploration			301.75	304.80	3.05	0.320
					Exploration			310.90	315.47	4.57	0.428
TF-3957	123.44	205	-70.00	300 W	Phase 6	616.27		0	3.05	3.05	<b>0.735</b>
					Phase 6			19.81	21.34	1.52	<b>1.300</b>
					Exploration			109.73	111.25	1.52	<b>3.170</b>
					Exploration			121.92	123.44	1.52	<b>1.125</b>
TF-3958	347.47	205	-50.00	760 W	Phase 6	702.96		51.816	54.86	3.05	0.496
					Phase 6			225.55	228.60	3.05	0.359
					Phase 6			231.65	242.32	3.05	<b>0.676</b>
					Phase 8			275.84	284.99	3.05	0.436
TF-3959	82.30	205	-70.00	280 W	Phase 8	631.99		54.864	57.91	3.05	<b>0.635</b>
TF-3960	111.25	205	-70.00	280 W	Phase 8	621.14		1.524	4.57	3.05	0.452
					Phase 8			16.76	24.38	7.62	<b>0.672</b>
					Phase 8			91.44	92.96	1.52	<b>2.430</b>
					Phase 8			97.54	103.63	6.10	0.419
TF-3961	112.78	0	-90.00	260 W	Phase 8	620.58		3.048	6.10	3.05	0.235
					Phase 8			12.19	15.24	3.05	0.603
					Phase 8			68.58	71.63	3.05	0.584
					Exploration			96.01	97.54	1.52	4.240
					Exploration			105.16	109.73	4.57	1.560
					Phase 8			42.672	45.72	3.05	0.730
TF-3962	112.78	205	-65.00	340 W	Phase 8	657.67		73.15	83.82	10.67	0.291
					Phase 8			89.92	92.96	3.05	0.526
					Exploration			108.20	115.82	7.62	0.245
					Exploration			118.87	126.49	7.62	0.403
					Exploration			129.54	134.11	4.57	0.992
					Phase 8			4.572	7.62	4.57	0.567
TF-3963	161.54	205	-70.00	280 W	Phase 8	616.81		10.67	25.91	15.24	0.537
					Exploration			103.63	118.87	15.24	2.445
					Exploration			129.54	132.59	3.05	0.667
					Exploration			143.26	158.50	15.24	0.345
					Phase 8			103.632	114.30	10.67	0.687
TF-3964	298.70	205	-50.00	320 W	Phase 8	659.62		140.21	147.83	7.62	1.043
					Exploration			160.02	163.07	3.05	0.829
					Exploration			166.12	170.69	4.57	0.357
					Exploration			254.51	262.13	7.62	0.458
					Exploration			269.75	277.37	7.62	0.516
					Exploration			281.94	289.56	7.62	0.489
					Phase 8			0	1.52	1.52	1.375
TF-3965	100.58	205	-70.00	240 W	Phase 8	625.20		19.81	22.86	3.05	1.049
					Phase 8			91.44	97.54	6.10	0.386
					Phase 8			251.46	254.51	3.05	1.663
TF-3966	350.52	205	-64.00	660 W	Phase 8	706.14		259.08	260.60	1.52	1.280
					Exploration			268.22	272.80	4.57	0.333
					Exploration			304.80	312.42	7.62	1.055
					Exploration			333.76	341.38	7.62	0.852
					Exploration			112.776	115.82	3.05	1.495
TF-3967	272.32	205	-70.00	260 W	Exploration	661.68		128.02	134.11	6.10	0.450
					Exploration			185.93	192.02	6.10	3.817
					Exploration			185.93	187.45	1.52	8.180
					Exploration		including	185.93	187.45	1.52	8.180

Drill Hole Number	Drill Hole Details						Mineralized Intervals				
	Depth (m)	Azimuth (°)	Angle (°)	Section Line	Mine Phase	Bench Elevation	From (m)	To (m)	Width (m)	Au (g/t)	
					Exploration		207.26	211.84	4.57	0.912	
					Exploration		219.46	222.50	3.05	0.990	
					Exploration		225.55	231.65	6.10	0.547	
TF-3968	201.17	205	-70.00	240 W	Phase 8	623.67	35.052	38.10	3.05	1.085	
					Phase 8		65.53	70.10	4.57	0.600	
					Phase 8		82.30	91.44	9.14	0.902	
					Exploration		115.82	118.87	3.05	1.276	
					Exploration		164.59	167.64	3.05	0.318	
					Phase 6		0	6.10	6.10	0.238	
TF-3969	286.51	205	-53.00	540 W	Phase 8	704.97	225.55	231.65	6.10	0.645	
					Phase 8		251.46	252.98	1.52	1.030	
					Phase 8		67.056	74.68	7.62	0.300	
TF-3970	329.18	205	-70.00	320 W	Exploration	659.32	120.40	131.06	10.67	0.906	
					Exploration		182.88	187.45	4.57	0.408	
					Exploration		207.26	214.88	7.62	0.358	
					Exploration		275.84	281.94	6.10	<b>0.751</b>	
					Exploration		298.70	301.75	3.05	<b>0.628</b>	
					Exploration		320.04	326.14	6.10	<b>3.351</b>	
TF-3971	164.59	205	-70.00	300 W	Phase 8	661.18	13.716	18.29	4.57	<b>1.989</b>	
					Exploration		115.82	121.92	6.10	<b>0.833</b>	
					Exploration		140.21	143.26	3.05	0.238	
					Exploration		150.88	156.97	6.10	<b>0.750</b>	
TF-3973	100.58	205	-70.00	240 W	Exploration	627.26	83.82	88.39	4.57	<b>1.765</b>	
TF-3974	225.55	0	-90.00	120 W	Phase 8	684.28	0	7.62	7.62	<b>4.562</b>	
					Phase 8		33.528	42.67	9.14	0.450	
					Exploration		126.49	134.11	7.62	<b>1.222</b>	
					Exploration		146.30	149.35	3.05	0.236	
					Exploration		170.69	173.74	3.05	<b>1.285</b>	
TF-3975	231.65	205	-70.00	140 W	Phase 8	678.98	6.096	9.14	3.05	<b>0.585</b>	
					Phase 8		54.864	57.91	3.05	0.431	
					Phase 8		97.536	103.63	6.10	<b>0.579</b>	
TF-3976	85.34	205	-70.00	240 W	Phase 8	630.33	6.096	9.14	3.05	<b>1.203</b>	
					Phase 8		44.196	64.01	28.05	<b>1.041</b>	
TF-3977	109.73	205	-65.00	260 W	Exploration	634.90	94.488	97.54	3.05	0.317	
					Exploration		106.68	109.73	3.05	<b>0.875</b>	
TF-3978	274.32	205	-60.00	160 W	Phase 8	675.46	4.572	10.67	6.10	<b>0.516</b>	
					Phase 8		15.24	27.43	12.19	0.280	
					Phase 8		39.624	42.67	3.05	0.238	
					Phase 8		57.912	67.06	9.14	<b>0.754</b>	
					Phase 8		91.44	94.49	3.05	<b>0.515</b>	
					Exploration		149.35	152.40	3.05	0.464	
					Exploration		163.07	169.16	6.10	<b>0.507</b>	
					Exploration		184.40	188.98	4.57	<b>1.029</b>	
TF-3979	102.22	0	-90.00	840 W	Phase 5	630.33	6.096	10.67	4.57	0.280	
					Phase 5		16.764	19.81	3.05	<b>0.720</b>	
					Phase 5		32.004	38.10	6.10	<b>0.739</b>	
					Phase 5		60.96	64.01	3.05	<b>0.696</b>	
					Phase 6		76.2	79.25	3.05	0.355	
					Phase 6		96.012	100.58	4.57	0.205	
TF-3980	252.98	205	-70.00	760 W	Phase 5	524.04	3.048	6.10	3.05	<b>0.540</b>	
					Phase 5		32.004	33.53	1.52	<b>1.160</b>	
					Phase 5		56.388	62.48	6.10	<b>0.889</b>	
					Phase 5		80.772	83.82	3.05	0.329	
					Phase 5		89.916	94.49	4.57	0.255	
					Phase 6		144.78	164.59	19.81	0.467	
					Phase 6		173.736	179.83	6.10	<b>0.534</b>	
					Phase 8		188.976	192.02	3.05	<b>0.756</b>	
					Exploration		199.64	204.22	4.57	<b>1.050</b>	

Drill Hole Number	Drill Hole Details						Mineralized Intervals				
	Depth (m)	Azimuth (°)	Angle (°)	Section Line	Mine Phase	Bench Elevation	From (m)	To (m)	Width (m)	Au (g/t)	
TF-3981	121.92	205	-70.00	900 W	Exploration	524.28	217.93	231.65	13.72	0.949	
					Exploration		234.70	243.84	9.14	0.676	
					Exploration		249.94	252.98	3.05	0.617	
					Phase 5		1.524	24.38	22.86	0.914	
					Phase 6		28.956	36.58	7.62	1.676	
					Phase 6		45.72	59.44	13.72	1.887	
					Phase 6		80.772	82.30	1.52	1.175	
					Phase 6		85.344	88.39	3.05	0.938	

Table provided by Magna Gold Corp. March, 2020.

**Figure 10.21**  
RC Drill Program at the San Francisco Pit as of December, 2017, East-Southeast View

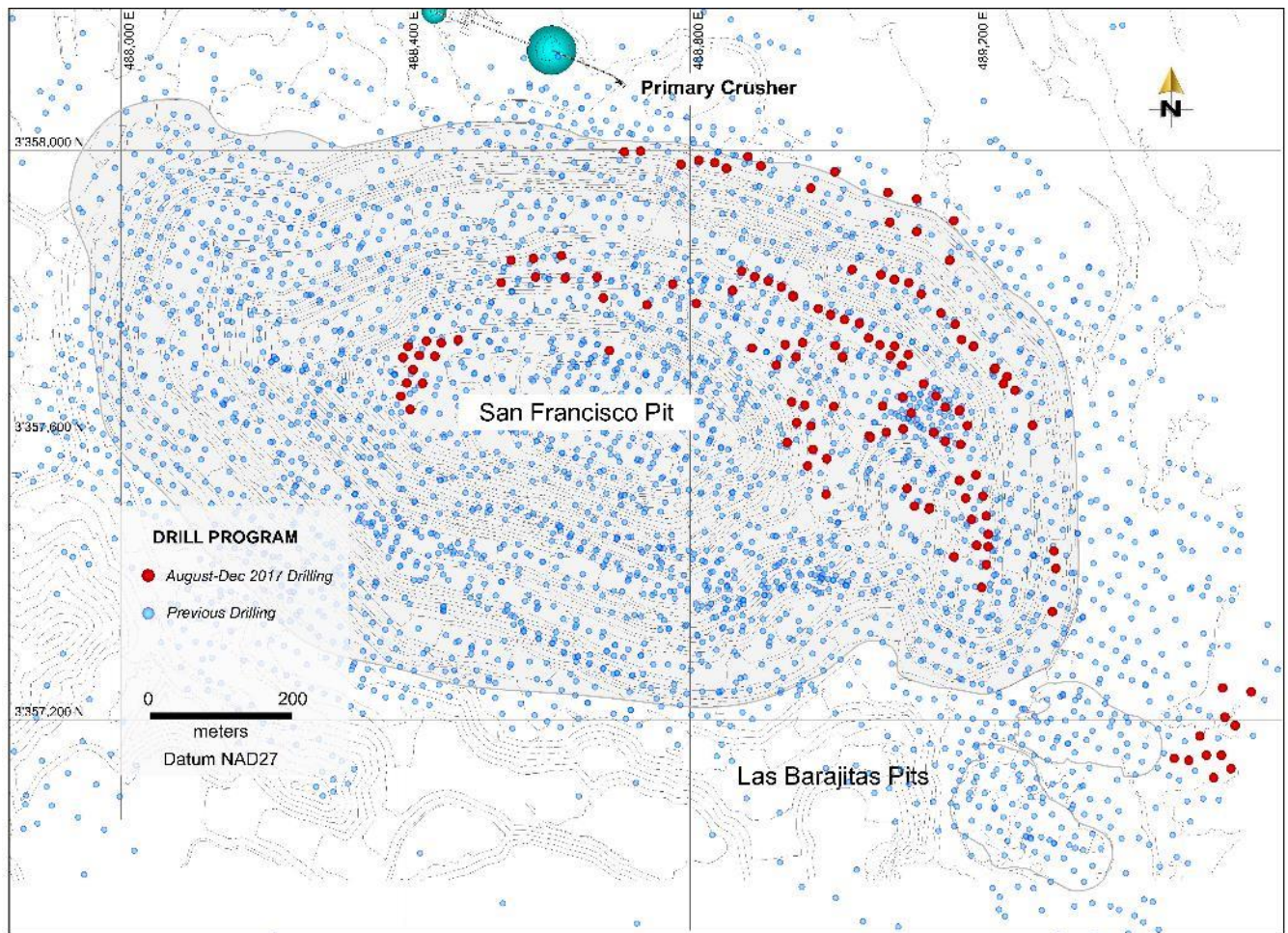


Figure supplied by Magna Gold Corp. March, 2020.

## 10.8 2018 IN-FILL DRILLING PROGRAM FOR THE SAN FRANCISCO MINE

From May to July 2018, 105 reverse circulation holes were drilled for a total of 7,154 m with an average depth of 68 m, as summarized by month in Table 10.17.

**Table 10.17**  
**Summary of the 2018 Monthly RC In-fill Drilling**

Month	Number of RC Holes Drilled	Number of Metres Drilled
May	66	3,415.28
June	27	2,247.90
July	12	1,490.48
<b>Total</b>	<b>105</b>	<b>7,153.66</b>

Table supplied by Magna Gold Corp, March, 2020.

All in-fill drill holes were conducted to better understand the nature of the mineralization within the existing mining Phases 5, 6, 7, 8 and 9. Figure 10.22 is a plan view of the 2018 drilling locations.

**Figure 10.22**  
**Plan View of the 2018 Drilling Program at the San Francisco Project**

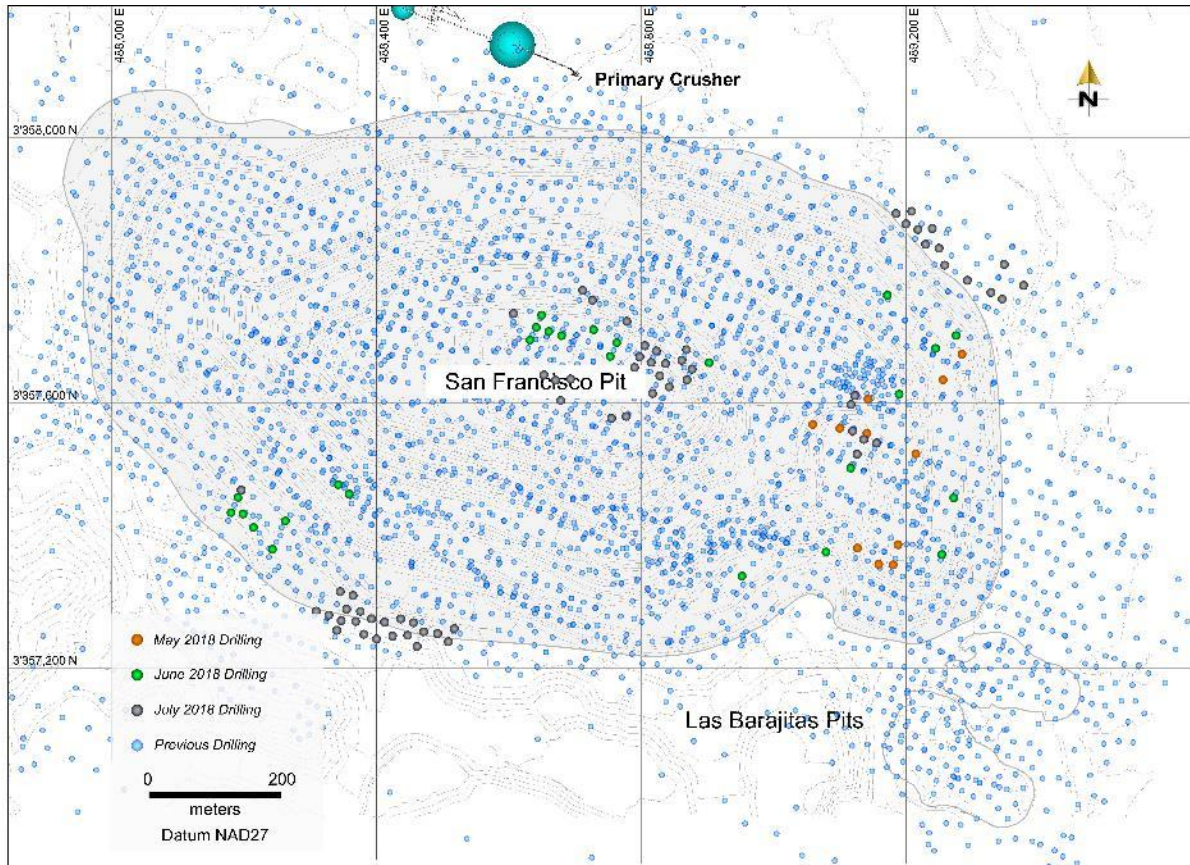


Figure supplied by Magna Gold Corp, March, 2020.

In Micon's opinion, further drilling will be necessary in order to achieve the objective of increasing the resource classification and in order to further define the deeper mineralization because, at depth within the pit, the drilling is more sparse.

Table 10.18 summarizes the significant assays for the 2018 drilling program from August to December.

**Table 10.18**  
**Significant Assay Intercepts, May to July, 2018 Reverse Circulation Drill Program**

Drill Hole Number	Drill Hole Details						Mineralization Interval			
	Depth (m)	Azimuth (°)	Angle (°)	Section Line	Mine Phase	Bench Elevation	From (m)	To (m)	True Width (m)	Au (g/t)
IF18-001	51.82	0	-90	820 W	Phase 5	470.21	0.00	16.76	16.76	0.273
							28.96	33.53	4.57	0.220
							41.15	47.24	6.10	0.258
IF18-002	51.82	0	-90	700 W	Phase 5	470.58	0.00	6.10	6.10	0.848
							33.53	51.82	18.29	0.439
IF18-003	51.82	0	-90	840 W	Phase 5	470.21	15.24	30.48	15.24	0.298
							48.77	51.82	3.05	0.983
IF18-004	30.48	0	-90	720 W	Phase 5	470.39	3.05	6.10	3.05	0.524
							10.67	16.76	6.10	0.425
IF18-005	30.48	0	-90	700 W	Phase 5	470.69	0.00	4.57	4.57	0.744
IF18-006	42.67	0	-90	800 W	Phase 7	709.41	4.57	9.14	4.57	0.383
IF18-007	51.82	0	-90	1000 W	Phase 7	710.26	42.67	48.77	6.10	0.510
IF18-008	51.82	0	-90	980 W	Phase 7	710.00	4.57	9.14	4.57	0.595
							15.24	24.38	9.14	0.305
							28.96	39.62	10.67	0.267
IF18-009	70.10	0	-90	980 W	Phase 7	709.77	0.00	7.62	7.62	0.237
							54.86	57.91	3.05	0.180
							62.48	70.10	7.62	0.220
IF18-010	60.96	0	-90	960 W	Phase 7	710.29	0.00	7.62	7.62	0.311
							27.43	32.00	4.57	0.838
							35.05	39.62	4.57	0.178
							41.15	60.96	19.81	0.262
IF18-011	51.82	0	-90	960 W	Phase 7	710.82	15.24	21.34	6.10	0.314
							28.96	35.05	6.10	0.218
IF18-012	51.82	0	-90	960 W	Phase 7	710.16	15.24	22.86	7.62	0.368
							32.00	48.77	16.76	0.555
IF18-013	42.67	0	-90	960 W	Phase 7	710.04	0.00	27.43	27.43	0.381
IF18-014	51.82	0	-90	940 W	Phase 7	710.31	12.19	19.81	7.62	0.445
IF18-015	42.67	0	-90	940 W	Phase 7	710.12	9.14	27.43	18.29	0.228
IF18-016	51.82	0	-90	920 W	Phase 7	709.60	30.48	38.10	7.62	0.267
							44.20	51.82	7.62	0.524
IF18-018	51.82	0	-90	900 W	Phase 7	709.63	18.29	24.38	6.10	0.500
							35.05	41.15	6.10	1.230
							45.72	48.77	3.05	0.185
IF18-019	42.67	0	-90	880 W	Phase 7	709.93	19.81	25.91	6.10	0.317
IF18-020	51.82	0	-90	840 W	Phase 7	710.04	7.62	12.19	4.57	0.235
IF18-022	30.48	0	-90	900 W	Phase 7	710.31	12.19	15.24	3.05	0.180

Drill Hole Number	Drill Hole Details						Mineralization Interval			
	Depth (m)	Azimuth (°)	Angle (°)	Section Line	Mine Phase	Bench Elevation	From (m)	To (m)	True Width (m)	Au (g/t)
							19.81	22.86	3.05	0.270
IF18-023	42.67	0	-90	880 W	Phase 7	709.82	15.24	18.29	3.05	0.340
							27.43	42.67	15.24	0.396
IF18-025	51.82	0	-90	840 W	Phase 7	710.30	7.62	13.72	6.10	0.150
							16.76	19.81	3.05	0.205
							25.91	32.00	6.10	0.166
IF18-026	51.82	0	-90	820 W	Phase 7	709.54	4.57	7.62	3.05	0.163
							27.43	30.48	3.05	0.145
							36.58	51.82	15.24	0.294
IF18-029	51.82	0	-90	360 W	Cong	700.86	0.00	36.58	36.58	0.126
IF18-030	30.48	0	-90	240 W	Cong	698.60	6.10	30.48	24.38	0.248
IF18-033	51.82	0	-90	440 W	Cong	702.45	0.00	42.67	42.67	0.263
IF18-034	51.82	0	-90	460 W	Cong	702.94	0.00	32.00	32.00	0.178
IF18-035	51.82	0	-90	400 W	Cong	702.75	6.10	9.14	3.05	0.125
							41.15	44.20	3.05	0.143
IF18-036	51.82	0	-90	400 W	Cong	701.43	0.00	51.82	51.82	0.198
IF18-037	51.82	0	-90	380 W	Cong	701.07	0.00	51.82	51.82	0.163
IF18-039	30.48	0	-90	280 W	Cong	699.38	0.00	22.86	22.86	0.156
IF18-042	106.68	0	-90	680 W	Phase 5	470.21	15.24	19.81	4.57	1.763
							22.86	28.96	6.10	0.520
							35.05	45.72	10.67	1.113
							73.15	77.72	4.57	0.348
IF18-043	121.92	0	-90	660 W	Phase 5	466.72	16.76	19.81	3.05	1.070
							22.86	27.43	4.57	1.140
							32.00	64.01	32.00	0.722
							71.63	82.30	10.67	1.303
							85.34	92.96	7.62	0.722
IF18-046	70.10	0	-90	660 W	Phase 5	464.81	97.54	108.20	10.67	0.514
							6.10	9.14	3.05	0.170
							41.15	45.72	4.57	0.227
IF18-047	30.48	0	-90	840 W	Phase 5	450.04	51.82	70.10	18.29	0.770
							12.19	18.29	6.10	0.253
IF18-048	30.48	0	-90	400 W	Phase 6	602.50	7.62	13.72	6.10	1.010
							16.76	22.86	6.10	0.828
IF18-050	30.48	0	-90	720 W	Phase 5	467.76	1.52	9.14	7.62	0.643
IF18-051	62.01	0	-90	700 W	Phase 5	469.53	59.44	64.01	4.57	1.328
IF18-052	39.62	0	-90	800 W	Phase 5	449.72	4.57	12.19	7.62	0.333
							19.81	30.48	10.67	0.265
IF18-054	100.58	0	-90	400 W	Phase 6	602.55	27.43	32.00	4.57	0.182
							48.77	70.10	21.34	0.209
							83.82	92.96	9.14	0.225
IF18-055	36.58	0	-90	920 W	Phase 5	470.10	3.05	18.29	15.24	0.236
IF18-057	51.82	0	-90	360 W	Phase 6	608.39	13.72	24.38	10.67	0.179
							36.58	50.29	13.72	0.417
IF18-058	51.82	0	-90	1180 W	Phase 7	704.35	38.10	42.67	4.57	0.557
							48.77	51.82	3.05	0.240
IF18-059	45.72	0	-90	680 W	Phase 5	464.59	7.62	18.29	10.67	0.647
							33.53	42.67	9.14	0.948

Drill Hole Number	Drill Hole Details						Mineralization Interval			
	Depth (m)	Azimuth (°)	Angle (°)	Section Line	Mine Phase	Bench Elevation	From (m)	To (m)	True Width (m)	Au (g/t)
IF18-060	70.10	0	-90	680 W	Phase 5	464.61	0.00	3.05	3.05	0.275
							9.14	32.00	22.86	0.258
							42.67	48.77	6.10	2.019
IF18-061	51.82	0	-90	720 W	Phase 5	464.54	3.05	6.10	3.05	0.358
							15.24	18.29	3.05	0.203
							21.34	51.82	30.48	0.471
IF18-068	91.44	0	-90	200 W	Phase 6	649.04	16.76	35.05	18.29	1.005
							44.20	47.24	3.05	0.985
							51.82	54.86	3.05	0.235
							65.53	73.15	7.62	1.040
							77.72	82.30	4.57	0.167
IF18-069	70.10	0	-90	840 W	Phase 5	463.51	0.00	7.62	7.62	0.169
							60.96	70.10	9.14	0.538
IF18-070	56.39	0	-90	860 W	Phase 5	463.81	0.00	25.91	25.91	0.464
IF18-071	69.96	205	-60	860 W	Phase 5	463.84	0.00	28.96	28.96	0.502
							41.15	47.24	6.10	0.328
							51.82	60.96	9.14	0.265
IF18-072	54.86	0	-90	860 W	Phase 5	464.22	0.00	16.76	16.76	0.287
							44.20	47.24	3.05	0.416
							51.82	54.86	3.05	0.154
IF18-073	45.72	0	-90	880 W	Phase 5	464.00	6.10	18.29	12.19	1.344
IF18-074	54.86	0	-90	880 W	Phase 5	463.74	1.52	24.38	22.86	0.457
IF18-075	60.96	0	-90	880 W	Phase 5	463.51	3.05	7.62	4.57	0.283
							24.38	28.96	4.57	1.295
							39.62	44.20	4.57	0.580
IF18-076	85.34	0	-90	1140 W	Phase 7	704.68	28.96	35.05	6.10	2.990
							62.48	67.06	4.57	1.100
							77.72	85.34	7.62	0.216
IF18-077	70.10	0	-90	760 W	Phase 5	457.99	0.00	28.96	28.96	0.456
							33.53	60.96	27.43	1.002
IF18-078	99.06	0	-90	760 W	Phase 5	458.17	0.00	21.34	21.34	0.423
							41.15	88.39	47.24	0.646
IF18-079	60.96	0	-90	800 W	Phase 5	457.89	0.00	13.72	13.72	0.803
							18.29	27.43	9.14	0.657
							57.91	60.96	3.05	0.785
IF18-080	80.77	205	-75	1160 W	Phase 7	704.64	42.67	60.96	18.29	1.347
IF18-081	85.34	0	-90	1180 W	Phase 7	704.05	42.67	65.53	22.86	1.315
							79.25	85.34	6.10	1.084
IF18-082	111.25	0	-90	360 W	Phase 6	608.26	0.00	6.10	6.10	0.195
							59.44	71.63	12.19	0.215
							83.82	99.06	15.24	0.316
							106.68	111.25	4.57	0.140
IF18-083	121.92	0	-90	420 W	Phase 6	650.75	79.25	99.06	19.81	1.139
							106.68	111.25	4.57	0.230
IF18-084	152.40	0	-90	320 W	Phase 6	659.47	105.16	111.25	6.10	0.169
							126.49	150.88	24.38	0.601
IF18-085	121.92	0	-90	340 W	Phase 6	606.46	7.62	10.67	3.05	0.291
							60.96	68.58	7.62	0.256



Drill Hole Number	Drill Hole Details						Mineralization Interval			
	Depth (m)	Azimuth (°)	Angle (°)	Section Line	Mine Phase	Bench Elevation	From (m)	To (m)	True Width (m)	Au (g/t)
							82.30	91.44	9.14	0.452
IF18-087	50.29	205	-60	340 W	Phase 6	637.48	22.86	36.58	13.72	0.178
IF18-088	111.25	0	-90	1100 W	Phase 7	698.83	50.29	94.49	44.20	1.441
IF18-089	85.34	0	-90	1180 W	Phase 7	704.29	45.72	53.34	7.62	1.228
							77.72	82.30	4.57	0.148
IF18-090	85.34	205	-75	1100 W	Phase 7	704.32	6.10	10.67	4.57	0.438
							67.06	71.63	4.57	0.217
IF18-091	150.88	0	-90	620 W	Phase 5	459.81	9.14	13.72	4.57	0.732
							24.38	28.96	4.57	0.192
							33.53	102.11	68.58	0.713
							108.20	128.02	19.81	0.395
IF18-092	96.01	205	-55	1050 W	Phase 7	632.49	0.00	10.67	10.67	0.170
							59.44	65.53	6.10	1.010
IF18-093	99.06	205	-55	1030 W	Phase 7	631.90	12.19	16.76	4.57	0.613
IF18-094	201.17	0	-90	380 W	Phase 6	604.90	42.67	62.48	19.81	0.270
							114.30	120.40	6.10	0.255
							141.73	163.07	21.34	0.515
							192.02	201.17	9.14	1.015
IF18-095	201.17	0	-90	400 W	Phase 6	602.57	129.54	149.35	19.81	0.486
							164.59	199.64	35.05	0.494
IF18-096	201.17	0	-90	360 W	Phase 6	608.49	41.15	51.82	10.67	0.741
							64.01	70.10	6.10	0.645
							96.01	99.06	3.05	0.355
							105.16	114.30	9.14	0.440
							132.59	140.21	7.62	0.511
							163.07	181.36	18.29	0.582
IF18-097	201.17	205	-80	440 W	Phase 6	602.66	44.20	50.29	6.10	0.731
							92.96	99.06	6.10	0.283
							123.44	128.02	4.57	0.157
							131.06	158.50	27.43	0.453
							163.07	172.21	9.14	0.667
							193.55	199.64	6.10	0.600
IF18-098	70.10	0	-90	260 W	Phase 6	632.45	13.72	19.81	6.10	0.175
							33.53	36.58	3.05	0.495
							39.62	44.20	4.57	0.163
IF18-099	120.40	0	-90	280 W	Phase 6	616.05	0.00	18.29	18.29	1.018
							27.43	36.58	9.14	0.432
							88.39	91.44	3.05	0.375
							108.20	120.40	12.19	0.376
IF18-100	150.88	205	-60	300 W	Phase 6	661.81	7.62	13.72	6.10	10.06
							41.15	44.20	3.05	0.720
							88.39	111.25	22.86	0.249
							132.59	147.83	15.24	0.374
IF18-101	51.82	0	-90	280 W	Phase 6	661.99	13.72	16.76	3.05	0.145
							24.38	27.43	3.05	0.340
							41.15	44.20	3.05	0.325

Drill Hole Number	Drill Hole Details					Mineralization Interval				
	Depth (m)	Azimuth (°)	Angle (°)	Section Line	Mine Phase	Bench Elevation	From (m)	To (m)	True Width (m)	Au (g/t)
IF18-102	82.30	0	-90	300 W	Phase 6	662.46	28.96	32.00	3.05	1.578
							41.15	44.20	3.05	0.088
							47.24	53.34	6.10	0.500
							56.39	60.96	4.57	0.470
							67.06	70.10	3.05	0.285
IF18-103	70.10	0	-90	240 W	Phase 6	633.09	12.19	16.76	4.57	0.550
							21.34	24.38	3.05	0.185
							28.96	36.58	7.62	0.593
							45.72	48.77	3.05	0.645
							53.34	57.91	4.57	0.870
IF18-104	70.10	0	-90	260 W	Phase 6	631.36	0.00	3.05	3.05	0.140
							22.86	25.91	3.05	0.173
							48.77	51.82	3.05	0.308
IF18-105	70.10	205	-60	300 W	Phase 6	632.18	22.86	25.91	3.05	0.542
							41.15	44.20	3.05	0.249

Table supplied by Magna Gold Corp. March, 2020.

## 10.9 MAGNA DRILLING PROGRAMS

Details of the drilling programs proposed by Magna are contained within Section 9 of this Technical Report. Magna's drilling programs cover the areas around both the San Francisco and La Chicharra pits to infill gaps in the prior drilling and also to test the down dip extension of the mineralization in both pits. Magna has proposed a program totalling 46,250 m distributed over 290 RC holes to cover the areas around both pits.

In addition to the program outlined above, Magna is scheduled to conduct a core drilling program on the south wall of the San Francisco pit which will further outline the repetitive high gold grade drill intercepts encountered in past drilling campaigns that appear to be related to the vein system located at the San Francisco and El Carmen areas. Magna's drill program for this area will be comprised of approximately 4,000 m in 38 short core holes.

At the the Vetatierra Project, Magna has proposed an initial 2,000 m drilling program to define the continuity of the mineral intercepts identified in by the previous drilling campaign, to explore the potential lateral extension of the gold mineralization and to gain a better understanding of the diorite geometry at depth.

At the La Pima Project, four targets have been delineated along the mineralized trend. Two of the targets, the PMT and WT, have high silver values upon which underground artisanal workings were developed in the early's 1990's. Access is open into the PMT workings but there is no access into the workings at WT which has similar features to PMT.

Magna is in the process of scheduling a core drilling program of 3,000 m distributed across different targets within the area of the La Pima Project.

## 10.10 MICON COMMENTS

During all previous site visits (2005 to 2017), Micon's QP reviewed and discussed the drilling programs with Alio personnel and believes that the programs have followed the best practices guidelines as outlined by the CIM for exploration. On numerous site visits during which drilling was being conducted, Micon did not observe any drilling sampling or recovery factors that could have materially impacted the accuracy and reliability of the drilling results obtained by the Alio. Micon's field observations of the drilling programs since 2005 all indicated that Alio conducted its drilling programs with industry best practices in mind.

The Magna personnel who will be overseeing its drilling programs for the San Francisco property are all former Alio employees who performed the same tasks. Therefore, Micon's QP believes that Magna's drilling programs will be conducted with the same regard to best practices as the programs conducted under Alio.

## **11.0 SAMPLE PREPARATION, ANALYSES AND SECURITY**

This Section has been extracted from the June 1, 2020, Technical Report completed by Micon for Magna and updated where applicable.

Although Magna personnel are familiar with the San Francisco mine and its mineral deposits, Magna has not yet conducted any sampling program at the San Francisco Project or on the property.

### **11.1 ALIO SAMPLE PREPARATION, ANALYSIS AND SECURITY PROGRAMS**

Alio, through its Mexican subsidiary, conducted its initial exploration drilling program on the Project in August and September, 2005, and instituted sampling procedures which have been discussed in the 2005, 2007, 2008, 2010, 2011, 2013 and 2016 Technical Reports that were filed on SEDAR. Only minor in-fill drilling has been conducted since the previous February, 2016, Technical Report was issued and this Section reproduces the sample preparation, analyses and security discussion contained in that report.

During the January, 2014 to December, 2015, drilling programs, Alio continued to use the sampling procedures, analyses and security protocols instituted for the previous reverse circulation and diamond drilling campaigns. Micon reviewed and extensively discussed the sampling procedures during the July, 2013 site visit and was satisfied that these procedures were accurately carried out and in accordance with the best practices in use by the mining industry. Micon also discussed the procedures during the February, 2016 site visit. Micon concludes that the results produced by the procedures were sufficiently reliable to form the basis for a mineral resource estimate.

Alio's January, 2014 to December, 2015 exploration drilling programs consisted of RAB, RC and core drilling. All drill holes were field logged and sampled as the holes were in progress. During the drilling, and each day that the drilling was completed, the information contained on the hand-written drilling logs (field logs) was transcribed into an Excel® spreadsheet. The Excel® spreadsheet contains the basic drill hole data, individual sample data and assay results, as well as the codes for the lithology, alteration and mineralization. This information was converted to an ASCII file to import it into the database which supports the resource estimates. Geological and mineralization interpretation was conducted based on cross-sections which were produced using an AutoCAD® software package.

The drilling completed in this period was based on an analysis of the results of the exploration programs of previous years, and followed up on previous targets or generally attempted to define the potential for secondary deposits north of the San Francisco pit.

### **11.2 REVERSE CIRCULATION DRILLING**

From the RC drilling, a portion of the material generated for each sample interval was retained in a plastic specimen tray created specifically. The samples in specimen trays constitute the

primary reference for the hole in much the same way as the core does for diamond drilling. The specimen tray was marked with the drill hole number and each compartment within the tray was marked with both the interval and number for the respective sequential sample it contained. Empty compartments were left for the locations where the blank and standard samples were inserted into the sequential sample stream and two compartments were identified for duplicate samples. Figure 11.1 shows some of the specimen trays for drill hole TF-1566.

**Figure 11.1**  
**Specimen Trays for Drill Hole TF-1566**



Due to the nature of RC drilling, only rock chip fragments are produced, and these range from a very fine grained powder up to coarse chips 2 cm in size. Since the stratigraphic contact between the different rock units cannot be identified exactly, the holes were sampled on equal 1.5 m (5 ft) intervals from the collar to the toe of the hole. The sample interval was chosen because it represented two samples per drill rod (3 m or 10 ft). In general, this is considered to be the standard sampling length within the industry.

Samples were taken in the overlying alluvium, as well as within the underlying rock units. The alluvium samples were subject to random assaying, whereas every sample originating from the underlying rock units was assayed. The recovery of the material during the drilling program was excellent, on the order of 90% to 95%, in both near surface sulphide-oxide and lower sulphide zones.

A common feature in the sampling process for RC drilling is that a unique sample tag was inserted into the sample bag with each sample, and each sample bag was marked with its individual sample number. The bags containing the blank and standard samples were added into the sequential numbering system prior to shipment of the samples to the preparation facility. Sample preparation and assaying were performed at the San Francisco mine. Approximately 15% of the samples assayed in the laboratory at the San Francisco mine were checked at an external laboratory. The principal external laboratory was the IPL-Inspectorate laboratory in Vancouver, B.C.

Samples identified as field duplicate samples during the RC drilling were split into two separate sequentially numbered samples during the sampling process at the drill.

### **11.3 CORE DRILLING**

For core drilling, control starts after a run has been completed and the rods are pulled out of the hole. Once the core is removed, it is placed in core boxes. This step in the procedure is completed by the contractor's personnel, under the supervision of an Alio geologist. Alio and the drill contractors follow generally accepted industry procedures for core placement in the core boxes.

Small wooden tags mark the distance drilled in metres at the end of each run, the depth from and to, and the length drilled and length recovered. The drill rods used by the contractors involved in the core drilling are measured in Imperial units, while the tags placed in the boxes are measured in metric units. The hole number and progressive box number are marked on each filled box by the drill helper and checked by the geologist. Once the core box is filled at the drill site, the box is covered with a lid to protect the core and the box is sent to the core logging facility for further processing.

For diamond drilling where core is produced, the exact stratigraphic contact between the various different rock units can be identified and these contacts were used as the primary basis for separation of the sample intervals. The maximum sample length within the stratigraphic unit was restricted to approximately 1.0 m or 2.0 m, with no minimum restriction. The maximum sample lengths were in accordance with accepted industry practice. In addition to the stratigraphic restrictions that limit the length of the core interval, the size of the sample may be restricted because of the content or type of mineralization encountered within the drill hole. In general, core recovery for the diamond drill holes at the San Francisco Project was better than 98% and no core loss due to poor drilling methods or procedures was experienced.

A unique sample tag was inserted into the sample bag with each sample and each sample bag was marked with its individual sample number. The bags containing the blank and standard samples were added into the sequential sample numbering system prior to being shipped to the assay preparation facilities of Inspectorate or ALS-Chemex. Both of these preparation facilities are located in Hermosillo, although ALS-Chemex sent samples to its facilities in Chihuahua and Zacatecas for preparation, if there was a large backlog of samples waiting to

be prepared. During the sampling process, some samples were identified as field duplicates and these were also inserted into the sample stream.

## 11.4 SAMPLE COLLECTION AND TRANSPORTATION

### 11.4.1 Reverse Circulation Drilling

The RC drill sampling was conducted by a team of two or three geological assistants, under the close supervision of the Alio staff geologists in charge of the on-site program. The staff geologists were responsible for the integrity of the samples from the time they were taken until they were delivered to the preparation facilities at the San Francisco mine. Figure 11.2 shows collection of a RC sample during the July, 2011 Micon site visit.

**Figure 11.2**  
**Reverse Circulation Sample Collection**



The RC cuttings collected at the drill site were discharged from the drill hole through a hose, into a cyclone where they were collected in a plastic pail. Sampling of the material generated during the RC drilling was conducted at the drill rig using a stainless steel riffle splitter if the material was dry and a rotary splitter situated below the cyclone if the material was wet. The cyclone and splitters were cleaned between samples and, in the case of wet samples, the cyclone and splitters were blown out using compressed air and also washed out between each sample using clean water. Using a 12.5 cm drill bit diameter and a sample length of 1.52 m, it

is estimated that the original sample weighed 48.3 kg, prior to making allowance for recovery. It is estimated that the average recovery was between 90% and 95%, which would indicate that the mass of the recovered sample varied between 42 and 45 kg.

The method of splitting the samples derived from the RC drilling was as follows:

1. If the sample was dry, the entire sample interval was collected in a bucket and then passed through the riffle splitter where a subsample of 21 to 23 kg was collected. The remaining 21 to 23 kg was rejected. The 21 to 23 kg subsample was subjected to a second split to obtain two samples of 10 to 12 kg (an original and a witness sample). The geologist or an assistant (under supervision) had previously marked the drill hole number and sample number on the plastic sample bags and inserted the sample tag into the sample bag for the original sample. Both bags were closed and sealed at the drill with plastic tie wraps and transported to the camp facilities.
2. If the sample was wet, it was discharged to a cyclone and then passed through a rotary cone splitter to divide the sample into two equal portions, one of which was automatically rejected. The other portion was collected and simultaneously split into two equal halves by means of a mechanism designed for this purpose and installed in the lower portion of the rotary splitter. The two samples were collected in fabrine (micropore) sample bags to allow retention of the solids and the slow dissipation of the drilling water through the pores in the bags, without sample loss. In all cases, a flocculent was used to settle the solids, including the fine portion, prior to tying the fabrine bag. The outside of each sample bag was marked with the sample's individual number which corresponded to the number on the sample tag which was inserted into the bag containing the original sample.

All samples from the RC drilling were prepared at the drill site by the Alio staff geologists and their assistants. Each time that a hole was completed, a truck was dispatched from the drill site to the preparation facilities of the Alio assay laboratory.

For check assays and their preparation, a truck was periodically dispatched to deliver samples to the Hermosillo assay preparation facility of IPL Laboratories and, from January, 2010, to IPL-Inspectorate. Sample bags containing the blank and standard samples were added into the sequential numbering system prior to shipment of samples to the preparation facilities, both at the San Francisco mine and in Hermosillo. Samples selected as duplicates were split into two separate sequentially numbered samples during the sampling process at the drill.

#### **11.4.2 RAB Drilling**

The procedures used for the RAB drilling are the same as those used for the RC drilling, with the exception of the length of the sample. In the case of the RAB drilling, the sample length was 2.032 m rather than 1.52 m used for RC drilling. This generated a larger sample weight per sample but did not impact the quality of the sample.



### **11.4.3 Core Drilling**

Geologic descriptions of the core samples, including nature of the sample, length of sample, lithology, alteration and mineralization, were captured on drill log forms. Samples were sealed in cloth bags with drawstring closures with the sample identification tags placed with each sample in the bag. A matching tag was retained in a sample book. Samples were stored on site in a locked warehouse at the exploration camp.

A truck was sent to each drill site to collect the core boxes at regular intervals during the day. The boxes were loaded into the truck and placed in a criss-cross pattern and then secured to the truck by ropes to prevent movement on the short drive back to the on-site core logging facilities.

Once the core boxes arrived at the logging facility, they were laid out in order, the lids were removed and the core washed to remove any grease and dirt which may have entered the boxes. The depth markers were checked by the geologist and the depth “from” and “to” for each box was noted on both the top and the bottom covers of each core box.

The geologist logging the core began by examining the core to ensure it was intact. During the core logging process, the geologist defined the sample contacts and designates the axis along which to cut the core. Special attention was paid to the mineralized zones to ensure that the sample splits were representative. The sample limits were marked on the core, as well as on the side of the core box, and the sample numbers were marked on the core box next to the sample limits. Afterwards, the sample limits were input into an Excel spreadsheet, which recorded the sample number and intervals.

Once the core had been logged and the samples marked, the core boxes were brought to the area where an electric diamond saw had been set up to cut the samples. At the sampling area, two core splitters and their helpers cut the core in half. Once the core had been sawn in half, one half of the core was placed into a plastic sample bag and the other half returned to the core box. The geologist or an assistant had previously marked the sample bags with the sample number and inserted the individual numbered sample tag into the plastic bag. A geologist supervised the core sawing to ensure that the quality of the sampling remains high and that no mistakes were introduced into the system due to sloppy practices. The boxes containing the remaining half core were stacked, with lower numbers at the bottom and the higher numbers at the top, and stored on site in a secure core storage facility.

### **11.4.4 General QA/QC Procedures**

As part of Alio’s QA/QC procedures, a set of samples comprised of a blank sample, a standard reference sample and a field duplicate sample were inserted randomly into the sample sequence. The insertion rate for the blanks, standards and duplicate samples was approximately one each in every 25 samples.

#### 11.4.4.1 Blank Samples

Since 2005, the blank samples used for the San Francisco drilling program have been obtained from three sources.

During the second semester of 2011, blank samples were used that had been prepared from a tonalite dike that outcrops on the southwestern extension of the San Francisco pit. The rock unit is younger than both the host rock of the gold mineralization and the mineralizing events in the region, at least as far as is known. A geologist working with Alio, and previously for both Geomaque and Fresnillo, considered the material in the dike to be barren and this was verified during the 2005 to 2010 drill programs. However, during the 2011 to 2013 program, anomalous gold values, including economic values, started to appear in this material and a detailed mapping program resulted in the discovery of xenoliths of mineralized rock within the dike. As a result, Alio made the immediate decision to use material from another source, which was selected based upon a regional geological reconnaissance. The regional reconnaissance resulted in the identification of a basalt-andesite occurrence in several areas within a 40 km perimeter around the San Francisco mine. Due to the accessibility of the Norma Project area to the northwest of the mine, a series of outcrops were chosen at the southern end of the Norma concession, from which several samples were taken and assayed by the San Francisco mine laboratory. The results of the assaying revealed gold values either below the detection limits or no gold.

While Alio was waiting for a new blank sample to be generated from its own material, it used blanks purchased from Proveedora de Laboratorios, SA de CV, based in Hermosillo. Alio purchased two types of blanks, a fine and coarse grain blank, with the first one used to check the assaying of the primary laboratory and the second to check the sample preparation in the Alio on-site facilities.

The procedure used to prepare the bags of blanks from the basalt-andesite was the same that the used by Alio for the tonalite. Alio collected 1 tonne lots of the material which were transported to the San Francisco mine, where the material was crushed to -1/8", followed by homogenization, and then split into 1 kilogram lots. During the drilling campaign, gold values were detected in a specific lot of blank samples. Alio then obtained the sample rejects from the Inspectorate laboratory and re-analyzed them in the San Francisco laboratory which confirmed the gold values, but noted that the material in the rejects was different from that in the blanks. From the position of the samples in the sampling sequence, and their position with respect to the gold values hosted in the metamorphic sequence cross-cut by the drilling, it was concluded that a mistake had been made in the numbering of the samples. The rest of the blank material was promptly rejected and a new 2-t sample was obtained and sent for preparation to the Sonora preparation laboratory, with Alio specifying the requirements for the preparation.

Figure 11.3 and Figure 11.4 show fragments of rock used for the blank samples and the bags once they had been prepared for insertion in the sampling sequence.

**Figure 11.3**  
**Fragment of Basalt used for Blank Sample**



Figure provided by Alio Gold Inc.

**Figure 11.4**  
**Blank Sample Bag ready to be Inserted into the Sample Sequence**



Figure provided by Alio Gold Inc.

#### 11.4.4.2 Standard Reference Materials

Certified standard reference materials (SRM's) were submitted with each sample shipment during the course of the drill programs. A total of 27 standard reference samples have been used since 2005, and these are summarized in the Table 11.1. Standard pulps, consisting of 70 to 100 g of material, were randomly inserted into each batch of 25 samples. The 27 standards include low, medium and high gold grades, in relation to the average grade of the known deposits in the area.

**Table 11.1**  
**Standard Reference Material Samples used During the Drilling Programs**

Standard	Accepted Gold Value		Lower Gold Limit (g/t)	Upper Gold Limit (g/t)	Source	Material
	g/t	+/-				
OXC-88	0.203	0.003	0.183	0.223	RockLabs	Basalt and feldspar with gold
OXC-102	0.207	0.002	0.192	0.222	RockLabs	Basalt and feldspar with gold
OXC-109	0.201	0.020	0.191	0.211	RockLabs	Basalt and feldspar with gold
OXD-87	0.417	0.004	0.391	0.443	RockLabs	Basalt and feldspar with gold
OXD-108	0.414	0.003	0.380	0.448	RockLabs	Basalt and feldspar with gold
OXE-86	0.613	0.007	0.571	0.655	RockLabs	Basalt and feldspar with gold
OXE-101	0.607	0.005	0.566	0.648	RockLabs	Basalt and feldspar with gold
OXE-106	0.606	0.004	0.576	0.636	RockLabs	Basalt and feldspar with gold
OXF-85	0.805	0.008	0.755	0.855	RockLabs	Feldspars and iron pyrite
OXF-100	0.804	0.006	0.764	0.844	RockLabs	Feldspars and iron pyrite
OXF-105	0.800	0.005	0.743	0.857	RockLabs	Feldspars and iron pyrite
OXG-83	1.002	0.009	0.948	1.056	RockLabs	Basalt and feldspar with gold
OXG-84	0.920	0.010	0.850	0.994	RockLabs	Basalt and feldspar with gold
OXG-99	0.932	0.006	0.860	1.004	RockLabs	Basalt and feldspar with gold
OXH-66	1.285	0.012	1.221	1.349	RockLabs	Basalt and feldspar with gold
OXH-82	1.278	0.010	1.224	1.332	RockLabs	Basalt and feldspar with gold
OXI-81	1.807	0.011	1.692	1.922	RockLabs	Basalt and feldspar with gold
OXH-97	1.278	0.009	1.214	1.342	RockLabs	Basalt and feldspar with gold
OXJ-95	2.337	0.018	2.220	2.454	RockLabs	Basalt and feldspar with gold
GS-2K	1.970	0.180	1.862	2.078	CDN Labs	Blank granitic ore and high gold ore
GS-2L	2.340	0.240	2.163	2.517	CDN Labs	Blank granitic ore and high gold ore
GS-P2A	0.229	0.030	0.198	0.260	CDN Labs	Ore of the Carlin style mineralization
GS-P3B	0.409	0.042	0.378	0.440	CDN Labs	Blank granitic ore and high gold ore
GS-P3C	0.263	0.020	0.237	0.289	CDN Labs	Blank granitic ore and high gold ore
GS-P7E	0.766	0.086	0.728	0.804	CDN Labs	Blank granitic ore and high gold ore
PGMS-18	0.5170	0.060	0.435	0.599	CDN Labs	Mix material from two ore deposits in the US
ME-15	1.386	0.102	1.284	1.488	CDN Labs	Ore from Minera San Javier, Mexico

Table provided by Alio Gold Inc.

#### 11.4.4.3 Duplicate Samples

For the RC drilling, the samples which were identified for duplication (field duplicates) were processed and split in the same way as the regular samples taken on either side of them. In the case of dry samples, the final 21 to 23 kg sample was subjected to a further split in the field, yielding two 10.5 to 11.5 kg samples. Wet samples were dried and then passed through the riffle splitter to obtain a second (duplicate) sample of approximately the same mass as the original. The duplicate samples were given sequential numbers and submitted as two separate samples for the purpose of assaying.

## 11.4.5 Preparation Laboratories

### 11.4.5.1 San Francisco Mine Preparation Facilities

For the 2010 to 2011 exploration drilling program, only a small number of samples were prepared and assayed by the San Francisco mine laboratory. In August, 2010, Alio decided to send all of the samples from the exploration program for preparation at an external laboratory. Alio did consider building a laboratory at the mine site to analyze the exploration assays, but the costs related to the laboratory, in order to meet the strictest QA/QC requirements, were prohibitive and it was decided to build only the preparation facilities, which were completed and ready to begin operations in November, 2012. This facility at the mine was only capable of preparing up to 350 to 400 pulps per day which, considering the quantity of samples generated by the exploration drilling, meant that a large proportion of the samples were sent to external laboratories for both preparation and assaying. Alio conducted an expansion of the preparation facility, so that it was able to prepare at least 700 samples per day of RC or core drilling.

The equipment in the preparation facilities includes:

- Two ovens for drying samples (Grieve TBH550E2 model).
- Two TBH-550 oven trucks.
- Sixteen nickel plated carbon steel shelves.
- One hundred SS rectangular sample pans (Model SC-50).
- Two Combo Boyd/RSD Boyd crushers with single split.
- Two VP-1989 ring and puck pulverizer, Bico 3 phase motor.

The procedure used at the San Francisco mine for the preparation of samples to be assayed for gold was as follows:

1. The samples received were inspected by the laboratory supervisor or an assigned deputy, to ensure that each was identified and that the original packing was not damaged. All of the samples were placed in the designated reception area.
2. On the registration form, the user entered the date and time, the work order number assigned by the laboratory, and record the origin of the sample, elements to be analyzed, requested assay method, sample type (rock fragments, soil, etc.) and priority of the sample. The registration form was filled out in duplicate.
3. Once reviewed, the form was then registered with the name and signature of the persons who submitted and received the samples.
4. All exploration and mine samples were weighed individually, with the weight recorded in the designated notebooks. The samples were then delivered to the sample preparation staff.

5. All samples received were dried in trays of an adequate size to ensure that they remain free of any contaminating material.
6. Using a permanent marker, each sample was labelled according to its original identification number. Each sample was poured into a corresponding tray, ensuring that 100% of the sample was contained within the tray, to avoid cross-contamination of samples. Inside each tray was an identification card that matches the original identification label.
7. Each tray containing a sample was placed in the oven.
8. Samples with a low moisture content were checked after 60 minutes to see if they had dried. Samples with high moisture content were checked after 3, 6, or 8 hours, at the discretion of the supervisor. Once the samples were completely dry, they were removed from the oven and placed on trolleys for transport.
9. The initial crushing was done in a jaw crusher, after it had been cleaned with compressed air. A first pass was conducted to reduce the size of the material to 85% passing a ¼ inch mesh. The material was then transferred to another tray that had already been labelled with the original sample number. Once the crushing was completed, the crusher and trays used in the process were cleaned using compressed air, and then the crusher was cleaned using fragments of monzonite dike. This material was monitored by the laboratory periodically to ensure that it was unmineralized.
10. A second crushing pass was performed using a roll crusher, in order to obtain a product of minus 10 mesh (2 mm).
11. The minus 10 mesh product was homogenized by rolling on a rectangular blanket, canvas or plastic liner. Once the sample homogenized, it was placed back into the tray to be split in a Jones riffle splitter.
12. Prior to splitting the sample, the splitter was checked to ensure that it was free of particles that could contaminate the sample. Compressed air was used where necessary to clean the splitter. The sample was then split, with one half being returned to the original sample bag and the other portion being split again.
13. The sample continued to be split between 3 to 8 times, until a sample of approximately 250 grams was obtained. This sample was then sent to the pulverizer.
14. Pulverizing was conducted such that 90% of the material was minus 150 mesh. The samples arrived at the pulverizing process in laminated Kraft envelopes, with each one identified according to the sample number and the work order. Once each sample had been pulverized, it was delivered to an external laboratory for assaying.

Equipment in the sample preparation facilities at the San Francisco mine is shown in Figure 11.5 and Figure 11.6.

**Figure 11.5**  
**Oven for Drying Samples in the Preparation Facilities**



Figure provided by Alio Gold Inc.

**Figure 11.6**  
**Combo Boyd/RSD Boyd Crusher with Single Split**



Figure provided by Alio Gold Inc.

#### 11.4.5.2 Sample Preparation and Analytical Protocols for Services Provided to Alio by Inspectorate

Samples from the San Francisco mine were picked up periodically by Inspectorate de Mexico, SA de CV. (Inspectorate), a subsidiary of Inspectorate America Corp. (also, Inspectorate).

These sample pickup trips were performed by Inspectorate's wholly owned trucks, driven by full time Inspectorate employees. Samples were picked up at the San Francisco mine.

Alio delivered the samples to Inspectorate personnel in rice sacks marked with the numbers corresponding to the samples in each sack. The samples inside the rice sack were contained in plastic bags marked with the sample number and including a numbered sample tag.

Alio provided proper documentation to Inspectorate's personnel regarding the samples being picked up, including a list of the samples delivered, the type of samples, the type of analysis requested and the elements for which assays are to be reported.

### **Sample Preparation Process for Reverse Circulation Samples**

Samples were driven to Inspectorate's sample preparation facilities in Hermosillo, Sonora, where they were subjected to the sample preparation process prior to shipment of a representative sub-sample to the analytical laboratories located in Richmond, B.C., Canada or Sparks, Nevada, USA.

### **Sample Sorting and Entering Data into the Laboratory Information Management System (LIMS)**

Once the samples were received at Inspectorate's sample preparation facilities, they were sorted in alpha-numerical or numerical order in the sample layout area. A registration form was completed providing details of the samples received.

When all the samples had been sorted and no extra, missing or duplicate samples were found, the sample registration was accepted by the supervisor and was taken to the administration office where the sample data were entered into the Laboratory Information Management System (LIMS).

### **Sample Drying**

Once the samples had been registered, each sample was taken out of its plastic bag and placed in a stainless steel drying pan which was then positioned in the wheeled drying racks. The drying racks were placed inside a high capacity drying oven where the samples were fully dried at 100°C.

### **Sample Crushing and Splitting**

Once the samples were fully dried, the wheeled racks were taken to the crushing area where the entire sample was crushed by a TM Engineering Terminator Jaw Crusher to 70% minus 10 mesh (2 mm).



A quality control check test was performed to ensure that the crushed sample met the specified size criteria. The test was performed on the first sample crushed at the beginning of a shift and then once every 40 samples thereafter.

Once a sample had been crushed, it was split using a Jones riffle splitter until a 250 g representative sub-sample was obtained.

### **Sample Pulverizing**

The entire 250 sub-sample was pulverized by using a Bico VP-1989 VP Pulverizer or LM2 Labtechnics Pulverizer, to 85% passing minus 200 mesh (75 microns).

A quality control check test was performed to ensure that the pulverized samples met the specified size criteria. This test was performed at the same frequency as the crushed sample sizing test.

The pulverized material was split to obtain a 100 g representative sample, which was sent to Inspectorate's analytical laboratory in Richmond, B.C. or Sparks, Nevada, where it was analyzed. The other 150 g split was saved in the warehouse for future checks or returned to the San Francisco mine.

Samples from the San Francisco Project were assayed for gold by fire assay, with atomic absorption finish, on a one assay-tonne sample. The lower and upper detection limits for this method are 5 and 10,000 ppb.

Inspectorate's Metals and Minerals Inspection and Laboratory Testing Services are certified by BSI Inc. (BSI) annually, in compliance with the ISO 9001:2008 Guidelines for Quality Management.

Inspectorate's internal QA/QC program is considered to meet normal industry standards for analytical laboratories.

#### **11.4.5.3 Sample Preparation and Analytical Protocols for Services Provided to Alio by ALS**

The following is taken and abbreviated from notes provided to Alio by ALS.

### **Logging Procedures**

All samples received at ALS Chemex are furnished with a bar code label attached to the original sample bag. The system will also accept client supplied bar coded labels that are attached to sampling bags in the field. The label is scanned and the weight of the sample is recorded together with additional information such as date, time, equipment used and operator name. The scanning procedure is used for each subsequent activity involving the sample from preparation to analysis, through to storage or disposal of the pulp or reject.

ALS logging (tracking) procedures are summarized in Table 11.2.

**Table 11.2**  
**ALS Method Code and Description for Alio Sample Preparation**

Method Code	Description
LOG-21	Log sample in tracking system (Samples received with bar code labels attached).
LOG-22	Log sample in tracking system (Samples received without bar code labels attached).

Table provided by ALS to Alio Gold Inc.

### Standard Sample Preparation: Dry, Crush, Split and Pulverize

The sample is logged in the tracking system, weighed, dried and finely crushed to better than 70% passing a 2 mm screen. A split of up to 250 g is taken and pulverized to better than 85% passing a 75 micron screen. ALS states that this method is appropriate for rock chip or core samples. Table 11.3 summarizes ALS methodology codes and descriptions for the preparation methods used for Alio samples.

**Table 11.3**  
**ALS Method Code and Description for Alio Sample Preparation**

Method Code	Description
LOG-22	Sample is logged in tracking system and a bar code label is attached.
CRU-31	Fine crushing of rock chip and drill samples to better than 70% of the sample passing 2 mm.
SPL-21	Split sample using riffle splitter.
PUL-31	A sample split of up to 250 g is pulverized to better than 85% of the sample passing 75 microns.

Table provided by ALS to Alio Gold Inc.

### Assay Methods

Au-AA23 & Au-AA24 Fire Assay Fusion, AAS Finish.

### Sample Decomposition

Fire Assay Fusion (FA-FUS01 & FA-FUS02).

### Analytical Method

Atomic Absorption Spectroscopy (AAS).

A prepared sample is fused with a mixture of lead oxide, sodium carbonate, borax, silica and other reagents as required, inquarted with 6 mg of gold-free silver and then cupelled to yield a precious metal bead.

The bead is digested in 0.5 mL dilute nitric acid in the microwave oven; 0.5 mL concentrated hydrochloric acid is then added and the bead is further digested in the microwave at a lower power setting. The digested solution is cooled, diluted to a total volume of 4 mL with de-

mineralized water, and analyzed by atomic absorption spectroscopy against matrix-matched standards.

Table 11.4 summarizes the ALS laboratory Au-AA23 and Au-AA24 Fire Assay Fusion, AAS Finish assay methods.

**Table 11.4**  
**Summary of the Au-AA23 and Au-AA24 Fire Assay Fusion, AAS Finish Assay Details**

Method Code	Element	Symbol	Units	Sample Weight (g)	Lower Limit	Upper Limit	Default Overlimit Method
Au-AA23	Gold	Au	ppm	30	0.005	10.0	Au-GRA21
Au-AA24	Gold	Au	ppm	50	0.005	10.0	Au-GRA22

Table provided by ALS to Alio Gold Inc.

Ag-GRA21, Ag-GRA22, Au-GRA21 and Au GRA22 Precious Metals Gravimetric Analysis Methods.

### Sample Decomposition

Fire Assay Fusion (FA FUSAG1, FA FUSAG2, FA FUSGV1 and FA-FUSGV2).

### Analytical Method

#### Gravimetric

A prepared sample is fused with a mixture of lead oxide, sodium carbonate, borax, silica and other reagents in order to produce a lead button. The lead button containing the precious metals is cupelled to remove the lead. The remaining gold and silver bead is parted in dilute nitric acid, annealed and weighed as gold. Silver, if requested, is then determined by the difference in weights.

Table 11.5 summarizes the ALS Ag-GRA21, Ag-GRA22, Au-GRA21 and Au GRA22 Precious Metals Gravimetric Analysis Methods.

**Table 11.5**  
**Summary of the ALS Ag-GRA21, Ag-GRA22, Au-GRA21 and Au GRA22 Precious Metals Gravimetric Analysis Methods**

Method Code	Element	Symbol	Units	Sample Weight (g)	Detection Limit	Upper Limit
Ag-GRA21	Silver	Ag	ppm	30	5	10,000
Ag-GRA22	Silver	Ag	ppm	50	5	10,000
Au-GRA21	Gold	Au	ppm	30	0.05	1,000
Au-GRA22	Gold	Au	ppm	50	0.05	1,000

Table provided by ALS to Alio Gold Inc.

## 11.5 QA/QC PROGRAM RESULTS

### 11.5.1 July, 2010 to June, 2011 QA/QC Program Results

#### 11.5.1.1 Check Sampling

A total of 416 sample pulps that were assayed at the Inspectorate facilities in Sparks or Richmond were sent to ALS-Chemex as a check against the assays obtained by Inspectorate. Samples for the check assaying program were selected randomly not only from the mineralized zones but also from the host rock on either side of the mineralized zone. All check samples selected had a grade above or equal to 0.10 ppm gold. This cut-off was established in order to approximate a true representation of the assays that were generating the resources in the block model and to avoid comparing assay results with a zero value or those with very low gold values.

In the first batch of check samples were 37 samples that had been assayed at the San Francisco mine laboratory since.

Table 11.6 indicates that the overall correlation factor between the ALS-Chemex results and the combined San Francisco mine and Inspectorate laboratory assays was sufficient to demonstrate that the original assays conducted by the San Francisco mine and Inspectorate laboratories can be relied upon.

**Table 11.6**  
**Comparison of the Original Assays with the ALS-Chemex Check Assays, 2010 to 2011 Drilling Program**

Description	Results
Number of Samples	416
Overall Laboratories (San Francisco mine + Inspectorate) Mean Grade	1.018
ALS-Chemex Mean Grade	1.041
Difference Between Means	-0.023
Mean Difference %	-2.20%
Correlation Factor	0.9484

Table provided by Alio Gold Inc.

#### 11.5.1.2 Standard Reference Sampling

A total of 1,512 SRM samples were submitted to Inspectorate for assaying and comparison with the thirteen SRM values used by Alio. The results are summarized in the Table 11.7.

RockLabs recommends using the standard deviation as the basis for setting control limits and establishing the value of two standard deviations to determine the upper and lower limits of acceptable results. In general, the Inspectorate assays of the SRM samples fell within acceptable limits.

#### 11.5.1.3 Blanks

Blank samples were inserted into the sample stream at an average of one for every 25 samples submitted to the laboratories used during the 2010 to 2011 exploration drill program. For the period from July, 2010 to June, 2011, a total of 1,956 blank samples were submitted for gold analysis, of which 189 were sent to the San Francisco mine laboratory and the rest, (1,726) were sent to the Inspectorate laboratories in Canada and the USA. Table 11.8 summarizes the results obtained for both laboratories.

A total of 42 out of the 1,915 blank samples (2.1%) returned gold values in excess of 0.1 ppm. These unexpectedly high assays prompted an investigation of the Alio and Inspectorate procedures to determine the cause. It was concluded that the samples were mislabelled, and that they were duplicate samples which contained the wrong sample tags. Alio then revised its sample identification procedures to minimize the risk of mislabelling.

Overall, the results for the blank sample analyses obtained by both laboratories were considered satisfactory.

#### 11.5.1.4 Duplicates

A total of 1,513 field duplicate samples were taken in order to verify and control the sampling procedures in the field and check the gold assays in the laboratory. Of these, 210 samples were sent to the mine laboratory and the remaining 1,303 samples were shipped to Inspectorate.

The duplicate samples were assigned consecutive numbers in the sample numbering sequence, so that the laboratory did not know it was receiving duplicates. These samples were submitted in the same shipment as their matching original samples but were not necessarily placed in the same furnace load as the original sample. The rate of the duplicate sampling was one duplicate for every 25 samples.

Table 11.9 summarizes the results of the comparison between the original and duplicate sample assays.

**Table 11.7**  
**Summary of Inspectorate Assaying versus the Standard Reference Material**

Standard Type	OXA-71	OXC-72	OXC-88	OXD-87	OXE-86	OXE-74	OXF-65	OXF-85	OXG-83	OXH-82	OXH-66	OXK-69	Total
Au grade ppl	0.085	0.205	0.203	0.417	0.613	0.615	0.805	0.805	1.002	1.278	1.285	3.583	
Concept	Statistics Parameters												
No of samples	230	108	135	162	35	79	117	67	151	32	191	21	1,328
Min	0.055	0.083	0.171	0.354	0.535	0.540	0.690	0.718	0.863	1.155	1.074	2.987	
Max	0.124	0.230	0.217	0.436	0.607	0.638	0.844	0.834	1.057	1.430	1.414	3.962	
Average inspect	0.0848	0.2003	0.1933	0.3950	0.5787	0.5817	0.7649	0.7752	0.9539	1.246	1.2169	3.4959	
Standard value	0.085	0.205	0.203	0.417	0.613	0.615	0.805	0.805	1.002	1.278	1.285	3.583	
Difference absolute	-0.0002	-0.005	-0.0097	-0.0220	-0.034	-0.033	-0.040	-0.030	-0.032	-0.032	-0.068	-0.087	
Difference %	-0.256%	-2.353%	-5.012%	-5.581%	-5.935%	-5.725%	-5.24%	-3.841%	-3.355%	-2.60%	-5.592%	-2.493%	-3.866%
Mediana	0.08	0.20	0.19	0.396	0.58	0.58	0.7650	0.78	0.96	1.24	1.217	3.53	
Variance	0.000	0.0003	0.0001	0.0002	0.0003	0.0003	0.001	0.0005	0.0014	0.0043	0.003	0.053	
Standard deviation	0.011	0.017	0.009	0.0134	0.019	0.018	0.029	0.022	0.037	0.065	0.050	0.231	

Table provided by Alio Gold Inc.

**Table 11.8**  
**San Francisco Gold Project, Summary of Blank Assay Data for the 2010 to 2011 Drill Program**

Details	Laboratory	
	San Francisco Mine	Inspectorate
Number of Samples	189	1,726
Minimum Gold Value	0.025	0.005
Maximum Gold Value	0.205	0.277
Mean grade (g/t gold)	0.031	0.021
Standard Deviation	0.0134	0.031
Variance	0.00018	0.00094
Samples Above 0.100 ppm gold	1	41
Percentage	0.53%	2.38%

Table provided by Alio Gold Inc.

**Table 11.9**  
**Summary of Results for the Duplicate Samples, July, 2010 to June, 2011 Drill Program**

Description	Laboratory				Entire Drilling Program	
	San Francisco Mine (g/t gold)		Inspectorate (g/t gold)		(g/t gold)	
	Original	Duplicate	Original	Duplicate	Original	Duplicate
Number of Pairs	210	210	1,303	1,303	1,513	1,513
Avg. Grade (g/t gold)	0.16	0.17	0.090	0.088	0.100	0.102
Maximum (g/t gold)	5.92	6.20	7.384	6.752	7.384	6.752
Minimum (g/t gold)	0.03	0.03	0.005	0.005	0.005	0.005
Difference Between Avg. Grades		0.01		-0.002		0.003
Difference %		8.04%		-1.69%		2.59%
Correlation Coefficient		0.9913		0.9321		0.9297

Table provided by Alio Gold Inc.

It was observed that 87% of the samples included in the duplicate assaying program were below or close to 0.1 g/t gold, which means that differences in assays were generally magnified because of the low gold content of the samples.

#### 11.5.1.5 General Comments Regarding the QA/QC Program

Alio subsequently stopped using its assay laboratory at the San Francisco mine to analyze samples and used it only for sample preparation. However, there were still some mine laboratory assays in the QA/QC program. The San Francisco mine laboratory continued to participate in a round-robin assay process through CANMET, which is the Materials Technology Laboratory at Natural Resources Canada, a branch of the Canadian Government.

In terms of overall averages, the blank and duplicate assay results were satisfactory for both the San Francisco mine and Inspectorate laboratories. The error in numbering between 42 blank samples and duplicate samples represents a breakdown in procedure which Alio recognized and corrected. The differences in the duplicate program were generally magnified by being below or close to 0.1 g/t gold due to the low gold content.

In general, Micon found no significant issues with the Alio July, 2010 to June 2011 QA/QC program results and concluded that the assays obtained could be used in a resource estimate for the mine.

#### 11.5.2 July, 2011 to June 2013 QA/QC Program Results

During the period between July, 2011 to June, 2013, over 327,000 m were drilled by core and reverse circulation, but primarily the latter. Throughout this period, the demand for services from assay laboratories remained strong and, due to the long turn-around periods for assay results, Alio used more than one external laboratory to meet its assaying requirements, which averaged more than 10,000 drill samples per month. The laboratories used for assaying were Inspectorate, ALS Minerals (ALS) and, occasionally, Skyline Assayers and Laboratories (Skyline). All of these laboratories are independent.

Skyline is accredited in accordance with the recognized International Standard ISO/IEC 17025:2005. This accreditation demonstrates technical competence for a defined scope and the operation of a laboratory quality management system.

#### 11.5.2.1 Check Sampling

A total of 852 sample pulps were selected for check assays, with Inspectorate and ALS being chosen as the primary laboratories. 357 of these sample pulps were assayed at the Inspectorate facilities and a further 495 sample pulps were assayed either by ALS, SGS or Inspectorate as check assays. Samples for the check assaying program were selected randomly, not only from the mineralized zones but also from the host rock on either side of the mineralized zone. All check samples selected had a grade of at least 0.10 ppm gold.

The 852 samples pulps were divided into three batches; two batches of sample pulps from the San Francisco pit drilling and a third batch from the La Chicharra and San Francisco drill programs. Table 11.10 summarizes the results of the check sample comparisons, for each of the three batches.

**Table 11.10**  
**Comparison of the Original Assays with the ALS-Chemex, Inspectorate and SGS Check Assays, 2011 to 2013 Drill Program**

Details	San Francisco Mine		Both Pits	All Primary Lab Assays vs All Check Assays one to one
	ALS vs Inspectorate	ALS vs SGS s	Inspectorate vs ALS	
Number of Samples	257	238	357	<b>852</b>
Mean Grade of ALS Minerals Assays	<b>0.850</b>	<b>1.801</b>	<b>1.122</b>	<b>1.266</b>
Mean Grade of the Inspectorate Assays	<b>0.806</b>		<b>1.112</b>	<b>1.210</b>
Mean Grade of the SGS Assays		<b>1.778</b>		<b>0.016</b>
Difference Between Means	0.044	0.023	-0.009	<b>1.303%</b>
Mean Difference	5.203%	1.294%	-0.833%	
Correlation Factor	0.9793	0.9534	0.9781	<b>0.9881</b>

Table provided by Alio Gold Inc.

Table 11.10 indicates that the overall correlation factors between the laboratories used by Alio for the San Francisco mine and La Chicharra check samples were sufficient to demonstrate that the original assays conducted by the laboratories can be relied upon.

#### 11.5.2.2 Standard Reference Material Samples

A total of 7,052 SRM samples were submitted to Inspectorate, ALS and Skyline for assaying and comparison with the 27 SRM samples used by Alio. Since there were assay results from three laboratories to be compared against SRMs, the numbers of SRM samples used of each standard and each assay supplier are summarized in Table 11.11.



**Table 11.11**  
**Summary of SRMs Used to Check Inspectorate, ALS and Skyline Assaying**

No.	Standard	Number of Samples for Each Lab for The San Francisco Pit			Number of Samples for Each Lab for The La Chicharra Pit			Total of Samples for the SRM		
		Insp	ALS	Skyline	Insp	ALS	Skyline	Insp	ALS	Skyline
1	OXH-82	17			25			42		
2	OXH-66	132			109	129		241	129	
3	OXG-99	102	59		130	35		232	94	
4	OXF-85	62			84	19		146	19	
5	OXE-86	137			10	97		147	97	
6	OXD-87	160		50	159	137	5	319	137	55
7	OXC-88	357			339			696		
8	OXI-95	128	189	35	126			254	189	35
9	OXH-97	142	343		114			256	343	
10	OXF-105	126	193		6			132	193	
11	OXE-101	120	75	58	343			463	75	
12	OXD-108	133	198		6			139	198	
13	OXC-102	133	130	54	285			418	130	
14	CDN-GS-P7E	15			60			75		
15	CDN-GS-2K	39			155			194		
16	OXG-83	127			0	105		127	105	
17	OXI-81	115			0	137		115	137	
18	OXG-84				26			26		
19	OXF-100		35	36	67			67	35	36
20	CDN-PGMS-18				37			37		
21	CDN-ME-15			17	65			65		17
22	CDN-GSP3C				61			61		
23	CDN-GS-P3B				97			97		
24	CDN-GS-P2A				112			112		
25	CDN-GS-2L				71			71		
26	OXE-106		192						192	
27	OXC-109		192						192	
<b>Gran Total</b>		<b>2,045</b>	<b>1,606</b>	<b>250</b>	<b>2,487</b>	<b>659</b>	<b>5</b>	<b>4,532</b>	<b>2,265</b>	<b>255</b>
										<b>7,052</b>

Both RockLabs and CDN Laboratories suggest a maximum value of two standard deviations to determine the upper and lower limits of acceptable results. In general, the Inspectorate assays of the SRM samples fell within acceptable limits, although the trend in the Inspectorate assays is that they were below the certified values in most cases. In general, the gold values obtained by Inspectorate were underestimated within a range that varies from 0.256% to 5.935%, and averages 3.742%.

Overall, Micon considers that the results are of sufficient quality to indicate that the assaying conducted by the various laboratories can be used as the basis of a resource estimate.

### 11.5.2.3 Blanks

During the 2011 to 2013 drilling campaign, 10,578 blank samples were inserted into the sample stream, at an average rate of one blank for every 25 samples. Of these, ten blanks were assayed at the San Francisco mine laboratory, with all returning assay of less than 0.03 g/t gold. The remaining 10,568 were distributed among Inspectorate, ALS and Skyline, yielding the results summarized in Table 11.12.

**Table 11.12**  
**San Francisco Gold Project, Summary of Blank Assay Data for the 2011 to 2013 Drill Program**

Details	Laboratory		
	ALS	Inspectorate	Skyline
Number of Samples	4,438	5,790	340
Minimum Gold Value	0.005	0.005	0.005
Maximum Gold Value	0.959	4.431	0.022
Mean grade (g/t gold)	0.05	0.048	0.007
Standard Deviation	0.1301	0.231	0.003
Variance	0.0169	0.05348	0.00001
Samples Above 0.100 g/t gold	83	119	0
Percentage	1.87%	2.06%	0%

Table provided by Alio Gold Inc.

A total of 119 out of a batch of 5,790 blank samples from the San Francisco Project, assayed by Inspectorate, returned gold values in excess of 0.1 ppm. These represent 2.2% of the total. The unexpected high assays prompted an investigation of the Alio and Inspectorate procedures, to determine the cause. It was concluded that all of the samples were from the rock material that was supposed to be barren, obtained from the vicinity of the Norma Project to the west-northwest of the San Francisco pit. Due to the anomalous gold results, the remaining samples of this material were rejected for use as blank samples.

Overall, the results for the blank sample analyses obtained by all laboratories are considered satisfactory.

### 11.5.2.4 Duplicates

A total of 6,796 field duplicate samples were taken, in order to verify and control the sampling procedures in the field and check the gold assays in the laboratories. The duplicate samples were assigned consecutive numbers in the sample numbering sequence, so that the laboratory did not know it was receiving duplicates. These samples were submitted in the same shipment as their matching original samples, but were not necessarily placed in the same furnace load as the original sample. The rate of the duplicate sampling was one duplicate for every 25 samples.

Table 11.13 summarizes the results of the comparison between the original and duplicate sample assays.

**Table 11.13**  
**Summary of Results for the Duplicate Samples, July, 2011 to June, 2013 Drill Program**

Description	Laboratory					
	ALS		Inspectorate		Skyline	
	Original	Duplicate	Original	Duplicate	Original	Duplicate
Number of pairs	2,473	2,473	4,032	4,032	291	291
Average Grade (g/t)	0.188	0.194	0.076	0.079	0.049	0.048
Maximum (g/t)	9.260	9.310	10.617	8.871	2.981	2.583
Minimum (g/t)	0.005	0.005	0.005	0.005	0.004	0.004
Difference between average grade (g/t)		-0.006		-0.002		0.001
Difference %		-3.33		-2.81		1.76
Correlation Coefficient		0.9463		0.9497		0.9834

Table provided by Alio Gold Inc.

Table 11.13 indicates that the results of the duplicate assaying at the laboratories are satisfactory, with a correlation factor ranging from 0.9463 for ALS to 0.9834 for Skyline. However, it was observed that the majority of the samples included in the duplicate assaying program were of low-grade and the differences in assays are generally magnified because of the low gold content of the samples.

#### 11.5.2.5 General Comments Regarding the QA/QC Program

In terms of overall averages, the blank and duplicate assay results were satisfactory for all laboratories used by Alio. The error noted by Alio, where some of the blank samples were found to be mineralized, was corrected and Alio obtained a different local material to be used as blank samples. Alio followed correct procedure in this regard.

Concerning the issue of the SRM samples potentially being underestimated, particularly by the Inspectorate laboratory, Micon acknowledges that lower grade samples will have any differences amplified. Micon considers that, in general, the assaying of the SRM samples is of sufficient quality that the original assays can be used for a mineral resource estimation.

### 11.6 RESULTS OF THE JANUARY, 2014 TO DECEMBER, 2015 QA/QC PROGRAM

Between January, 2014 and December, 2015, in addition to its regular QA/QC programs, Alio added a program of conducting screen metallic samples as part of its assay checks to deal with free gold that it observed at the Vetatierra Project.

#### 11.6.1 Screen Metallic Assaying

At the Vetatierra Project, part of the gold mineralization appears to be related to finely disseminated and coarse free gold on the quartz-tourmaline±pyrite. As a result, Alio believed it was necessary to conduct assay checks to identify any potential nugget effect in the assay data or if there was the possibility of losing gold during the drilling or RC/core sampling process. Figure 11.7 is a piece of core showing the location of visible gold found within it.

To better understand if there was coarse gold affecting the sample, five rejects samples from the RC drilling were analyzed as sample pairs for screen metallics at the Inspectorate laboratory and at the San Francisco mine laboratory. An additional five field duplicate samples of the same interval, as rejects samples (25% of the total sample), were analyzed by screen metallics.

**Figure 11.7**  
**Drill Hole VT14-005 Showing a Location with Visible Gold in the Core**



Photograph provided by Alio Gold Inc.

The assay results indicated that fine gold or clustering gold may occur at the Vetatierra Project, giving a variation in the assays results which was either positive or negative depending on whether or not free gold was present (Figure 11.8).

**Figure 11.8**  
**Summary and Graph Showing the Assays Results for the Five Samples**

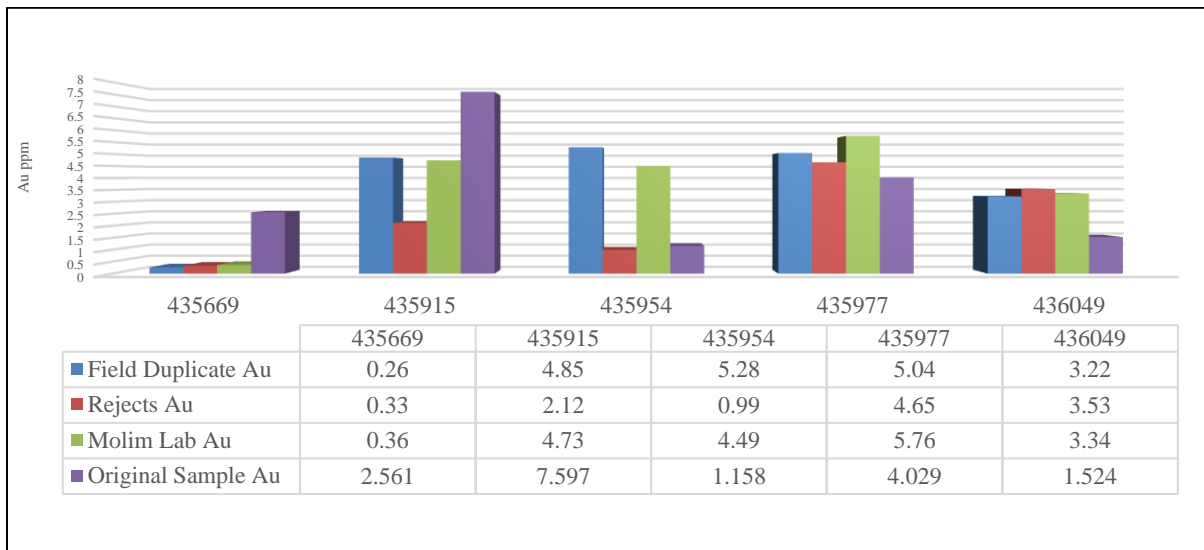


Table and graph provided by Alio Gold Inc.

Note that in the sample 435954 the assays results are higher in the original sample sent to the lab than the assay returned from screen metallics.

Five samples were analyzed as pairs at Inspectorate laboratory. Three of the samples produced results that were very similar to each other, but two of the samples had a strong variation in the gold results, suggesting that a nugget effect or loss of gold may be present. Table 11.14 shows the variation in the samples both in a tabular fashion and graphically

**Table 11.14**  
**Summary and Graph Showing the Gold Variation in the Five Pairs of Samples Rejects vs Field Duplicates**

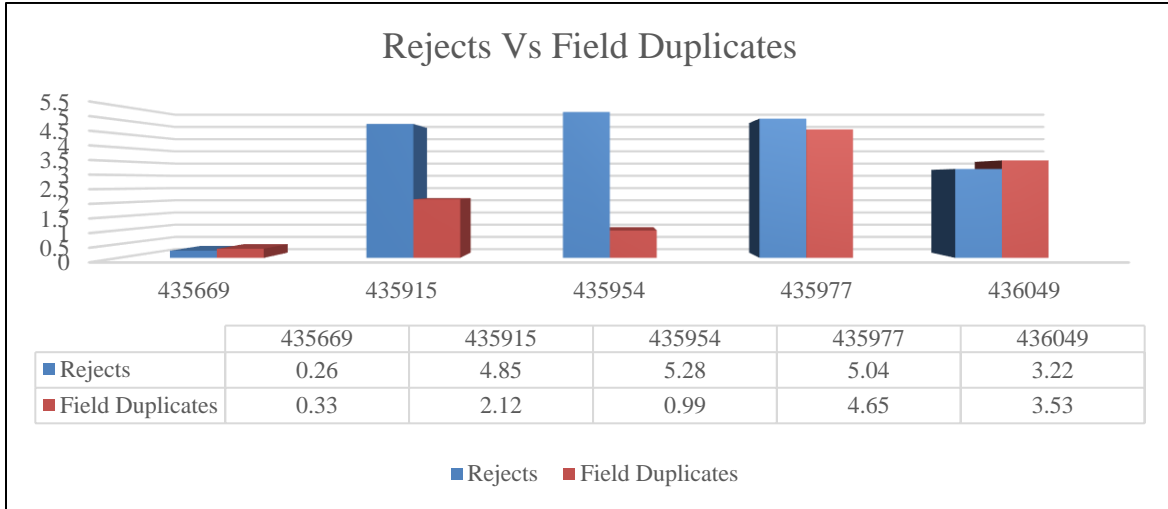


Table and graph provided by Alio Gold Inc.

Another 5 samples were analyzed to compare the gold assay results from the screen metallics and fire assays with the AA finish (original sample) and, once again, the results were very variable (either positive or negative), suggesting that a nugget effect due to very fine or clustering of gold may occur at the project (Figure 11.9).

**Figure 11.9**  
**Summary and Graph Showing the Gold Variation in the Samples Screen Metallics vs Fire Assays**

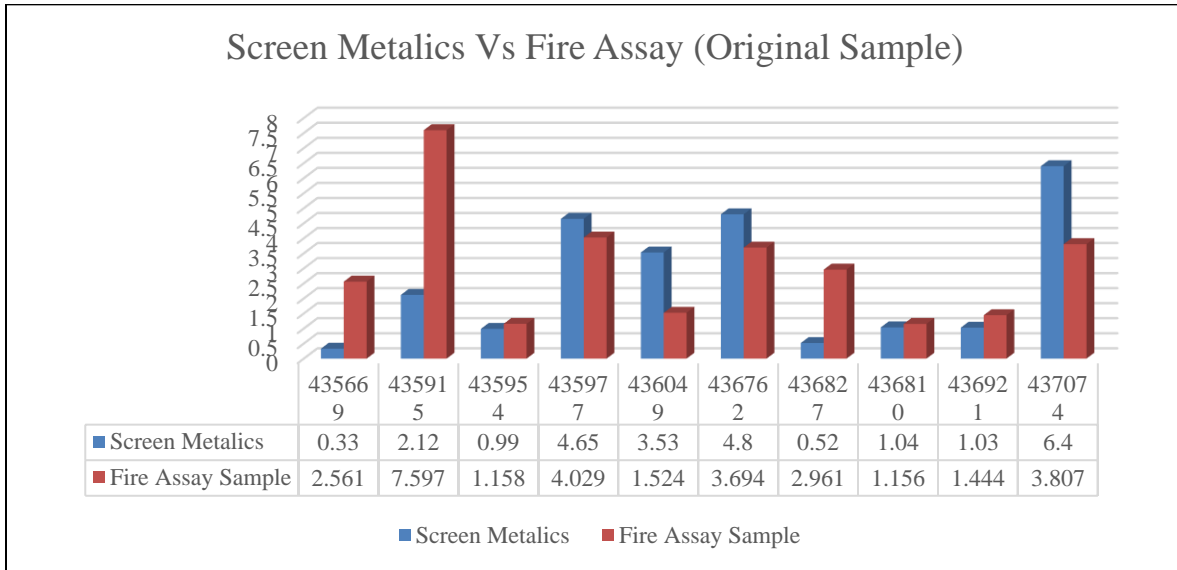


Table and graph provided by Alio Gold Inc.

## 11.7 RESULTS OF THE AUGUST, 2016 TO MARCH, 2017 QA/QC PROGRAM

During the period between August, 2016 to March, 2017, over 13,000 m were drilled by reverse circulation. Samples were primarily prepared at San Francisco mine. Samples were sent to Bureau Veritas Laboratory (Inspectorate) at Hermosillo, Sonora, and smaller number of samples were sent to ALS Minerals for check assays. At Inspectorate, 50 g pulps were analyzed by fire assay with an atomic absorption finish (FA430) and samples assaying greater than 10 g/t Au, then re-assayed with gravimetric finish (FA-430). ALS Minerals methodology was the same.

As part of Alio's QA/QC procedures, a set of samples comprised of a fine-blank sample, a standard reference sample and a field duplicate sample were inserted randomly into the sampling sequence. The insertion rate for the blanks, standards and duplicate samples was approximately one each in every 25 samples.

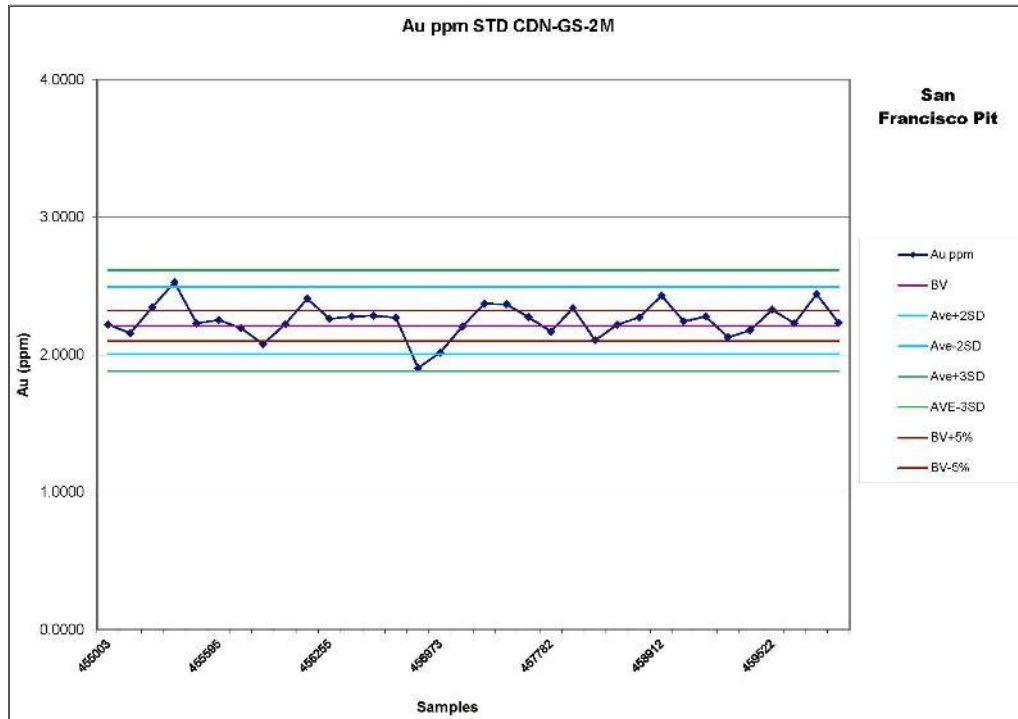
### 11.7.1 Standard Reference Material Samples

A total of 267 standard reference material samples were submitted to Bureau Veritas (Inspectorate) and ALS Minerals for assaying. Table 11.15 summarizes the number of each of the standard reference material samples sent to the two laboratories. The repeatability of standard assays is illustrated in Figure 11.10 through Figure 11.18.

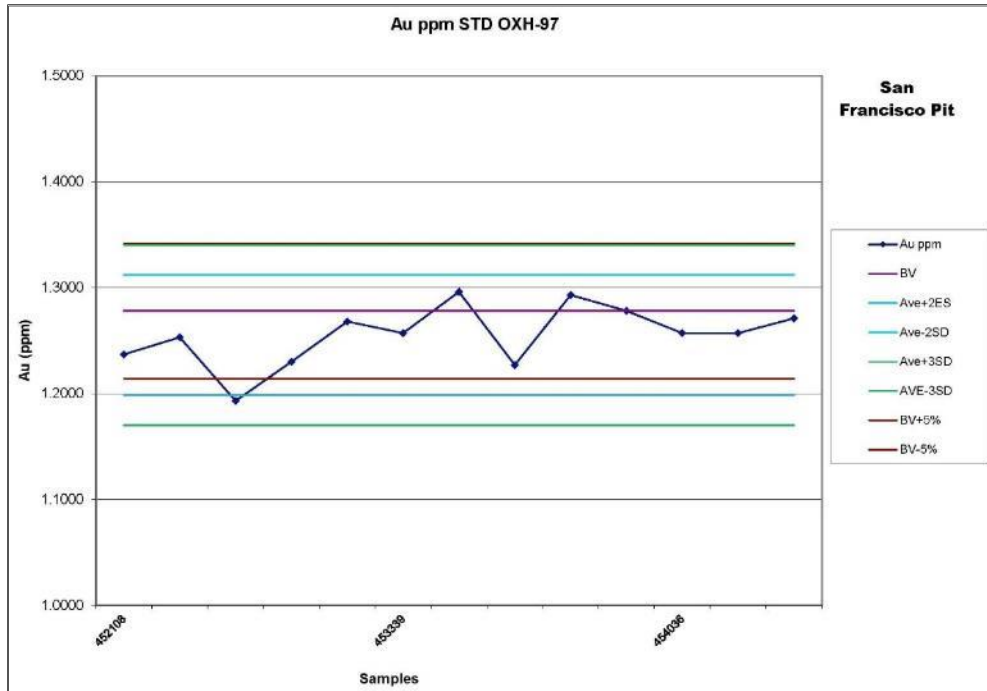
**Table 11.15**  
**Summary of Standard Material Reference Samples Used at Check Inspectorate and ALS Minerals**

Number	Standard	Standard of Samples for Each Laboratory for the San Francisco Pit	Standard of Samples for Each Laboratory for the N & NW La Chicharra Pit's
		Inspectorate	ALS Minerals
1	CDN-GS-2M	34	
2	CDN-GS-P7H	47	2
3	OXC-109	82	33
4	OXE-101	1	
5	OXF-105	18	
6	OXH-97	13	
7	OXJ-95	15	
8	OXD-108		22
<b>Grand Total</b>		<b>210</b>	<b>57</b>

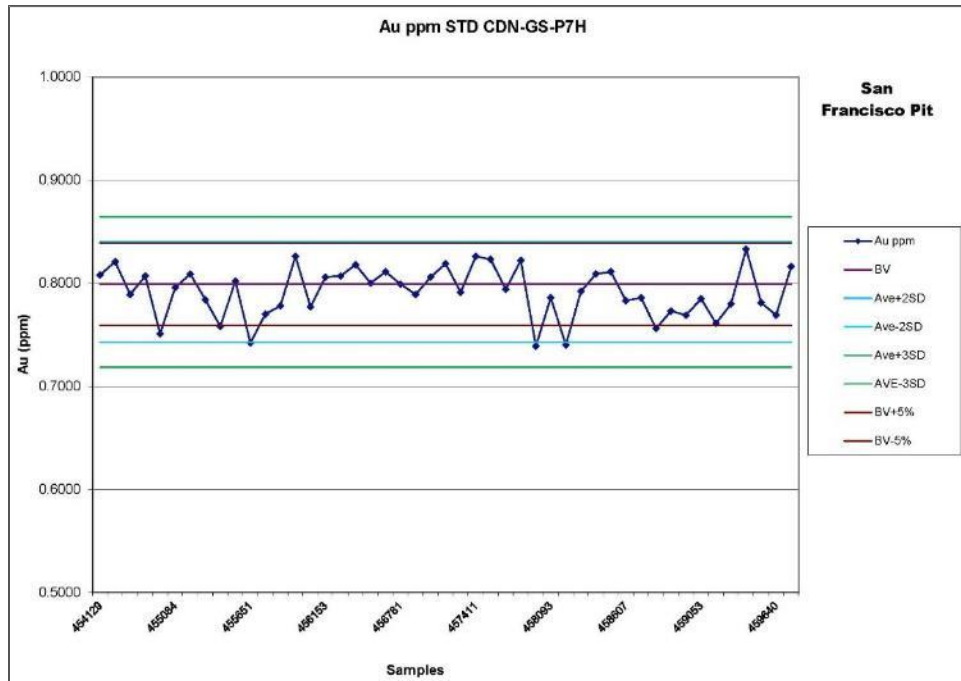
**Figure 11.10**  
**Precision Plot – Gold in Reference Standard CDN-GS-2M for the San Francisco Pit In-Fill Drilling**



**Figure 11.11**  
**Precision Plot – Gold in Reference Standard OXH-97 for the San Francisco Pit In-Fill Drilling**

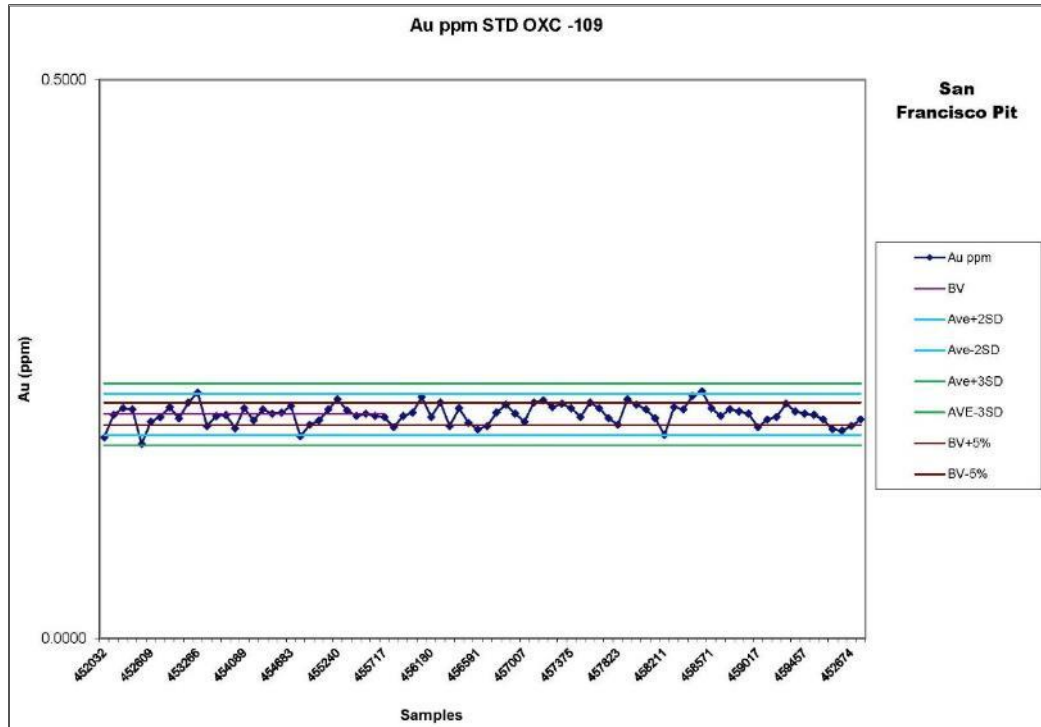


**Figure 11.12**  
**Precision Plot – Gold in Reference Standard CDN-GS-P7H for the San Francisco Pit In-Fill Drilling**

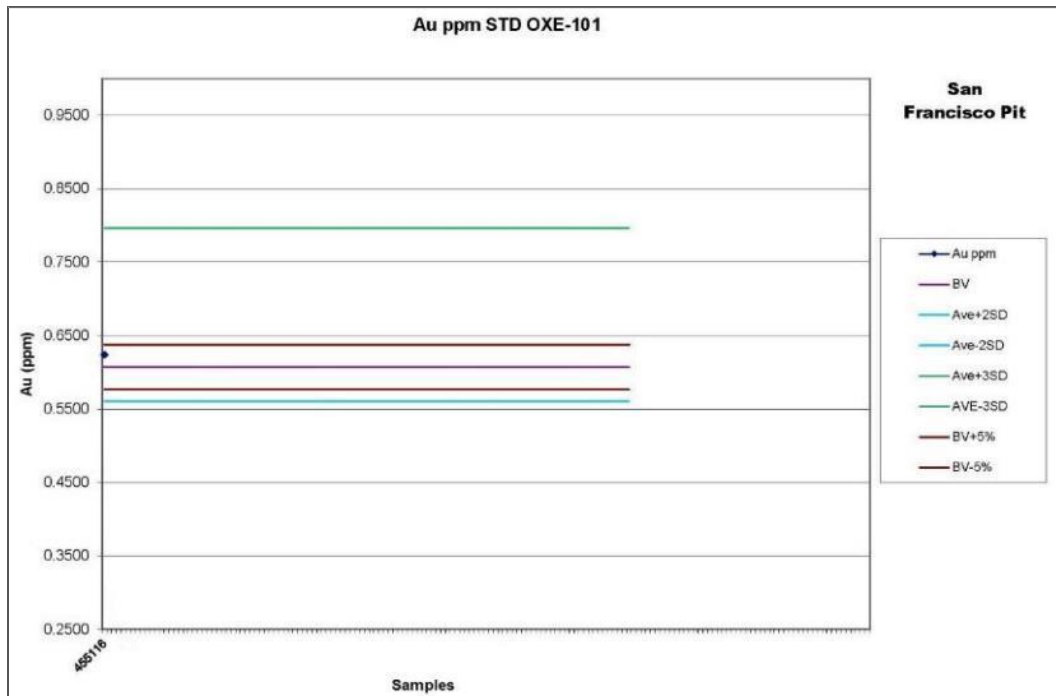




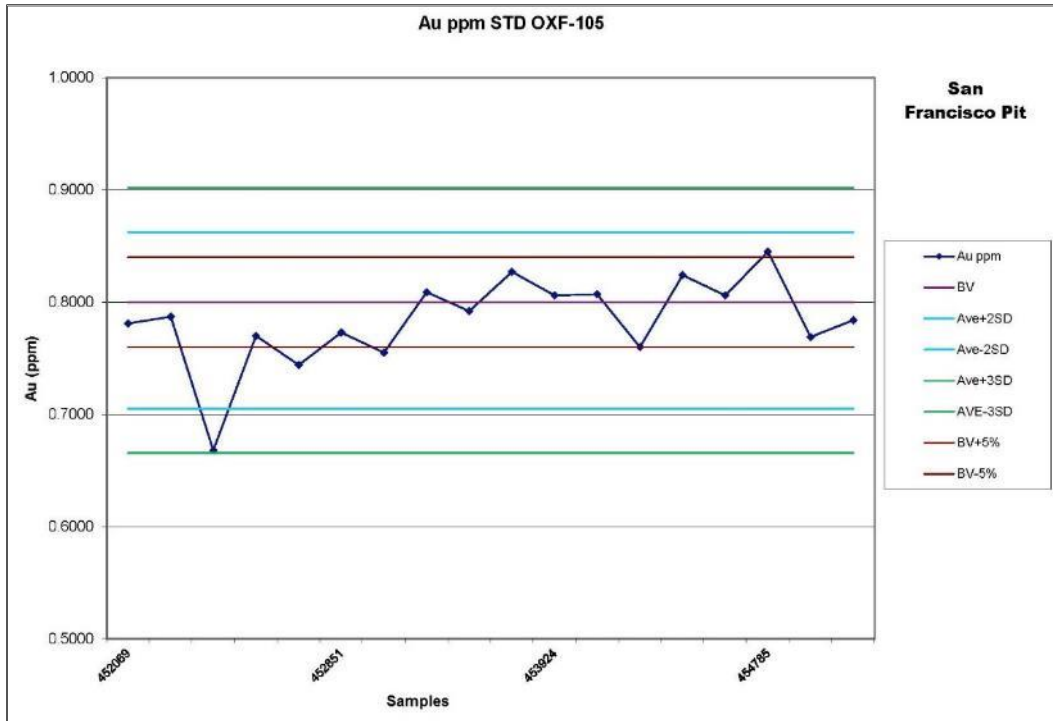
**Figure 11.13**  
Precision Plot – Gold in Reference Standard OXC-109 for the San Francisco Pit In-Fill Drilling



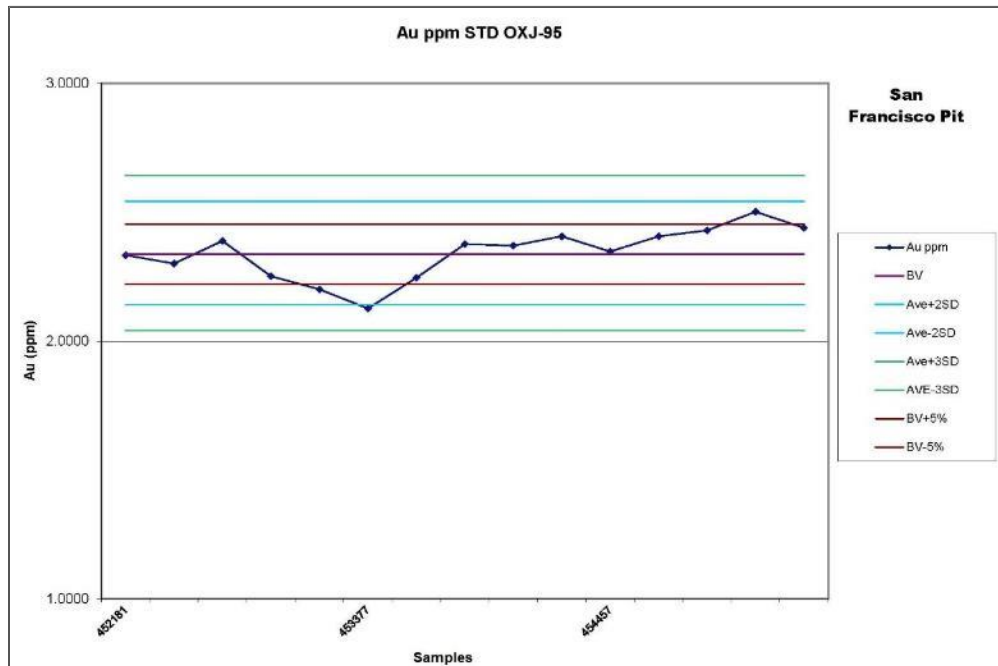
**Figure 11.14**  
Precision Plot – Gold in Reference Standard OXE-101 for the San Francisco Pit In-Fill Drilling



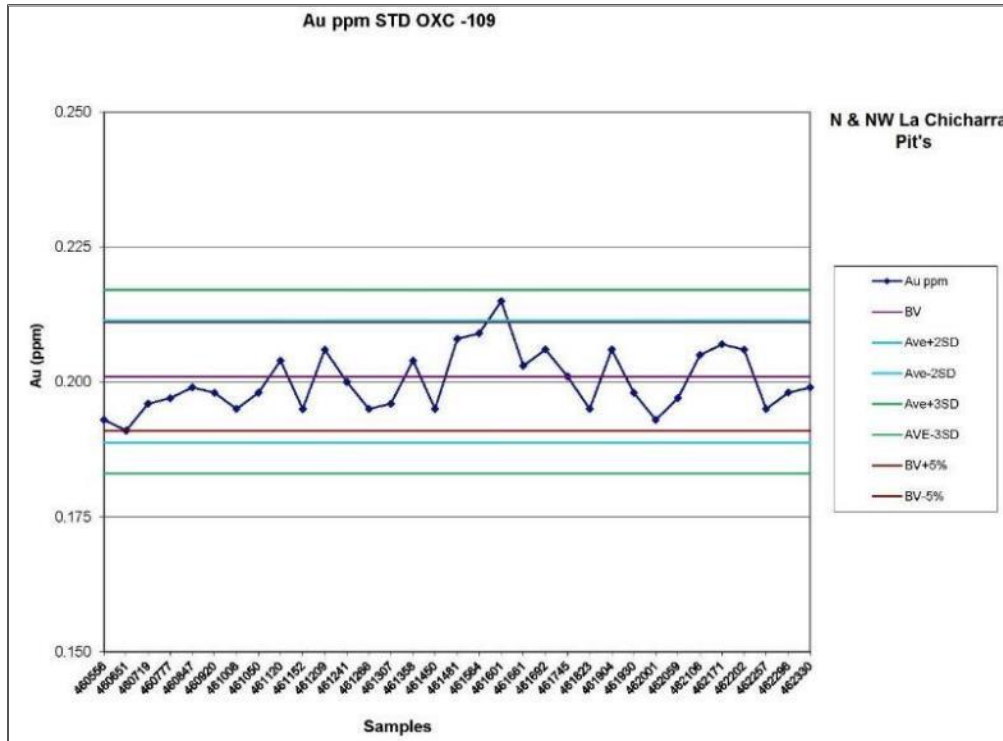
**Figure 11.15**  
Precision Plot – Gold in Reference Standard OXF-105 for the San Francisco Pit In-Fill Drilling



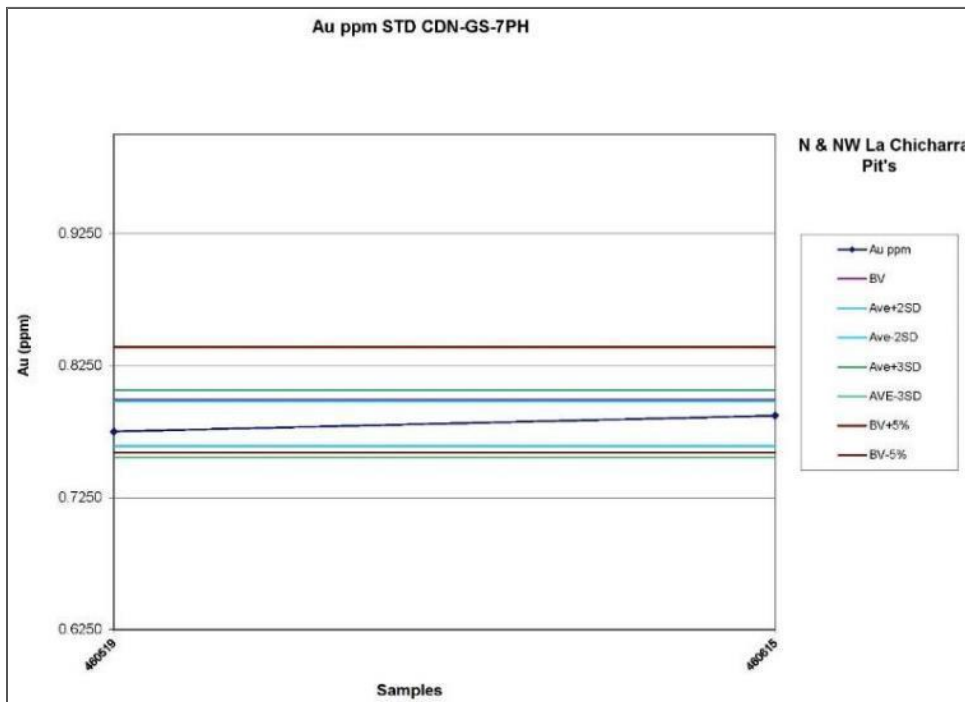
**Figure 11.16**  
Precision Plot – Gold in Reference Standard OXJ-95 for the San Francisco Pit In-Fill Drilling



**Figure 11.17**  
Precision Plot – Gold in Reference Standard OXC-109 for the N and NW La Chicharra Drilling



**Figure 11.18**  
Precision Plot – Gold in Reference Standard CDN-GS-7PH for the N and NW La Chicharra Drilling



Overall, the assay results of the standard samples are considered satisfactory.

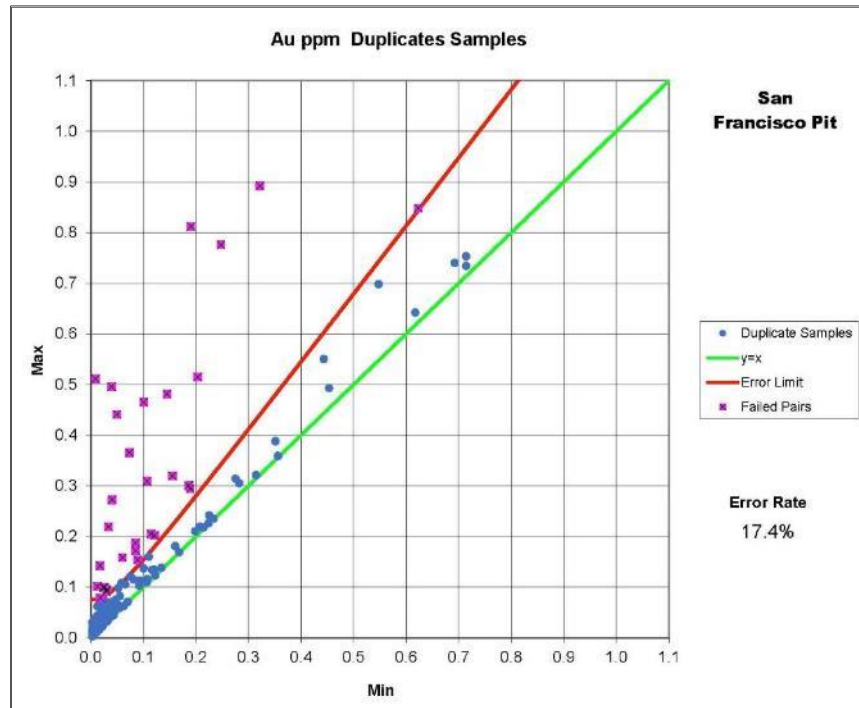
### 11.7.2 Duplicates

A total of 244 field duplicate samples were taken, in order to verify and control the sampling procedures in the field and check the gold assays in the laboratories. The rate of the duplicate sampling was one duplicate for every 25 samples.

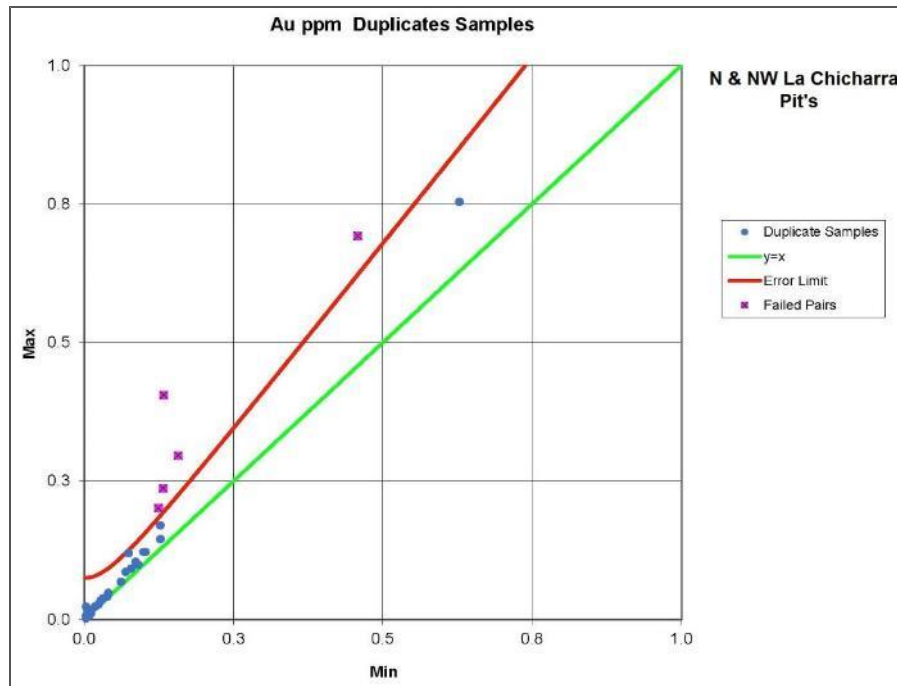
Figure 11.19 and Figure 11.20 show the results for the duplicate samples, plotted as relative error diagrams, for the San Francisco and for the north and northwest La Chicharra Pits, in the August, 2016 to March, 2017 drill program.

The failed pairs in Figure 11.19 and Figure 11.20 are clearly shown as those points above the error limit line. The appearance of higher failure rate in the San Francisco Pit duplicates versus the La Chicharra duplicates may be in part due to the larger amount of drilling in and around the San Francisco pit versus the La Chicharra pit.

**Figure 11.19**  
**Results for the Duplicate Samples Plotted as a Relative Error Diagram for the San Francisco Pit, August, 2016 to March, 2017 Drill Program**



**Figure 11.20**  
Results for the Duplicate Samples Plotted as a Relative Error Diagram for the North and Northwest La Chicharra Pits, August, 2016 to March, 2017 Drill Program

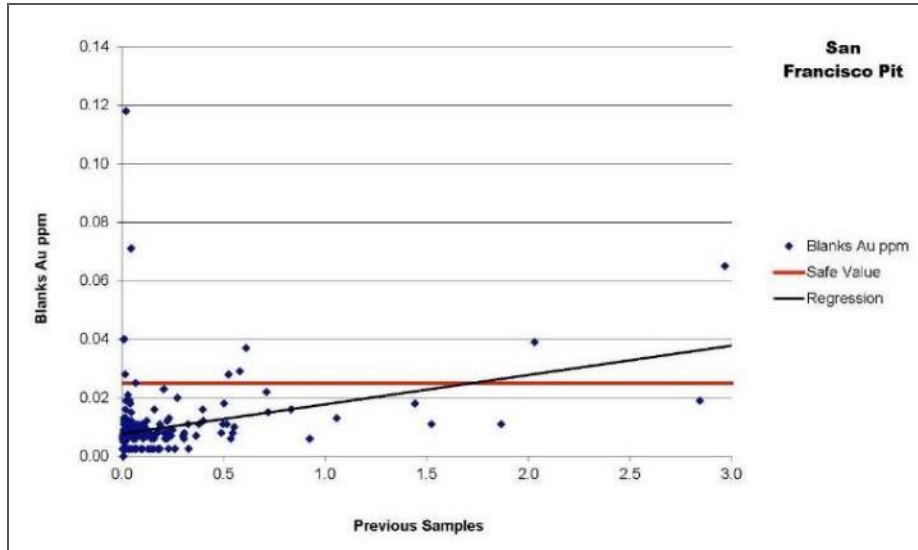


### 11.7.3 Blank Samples

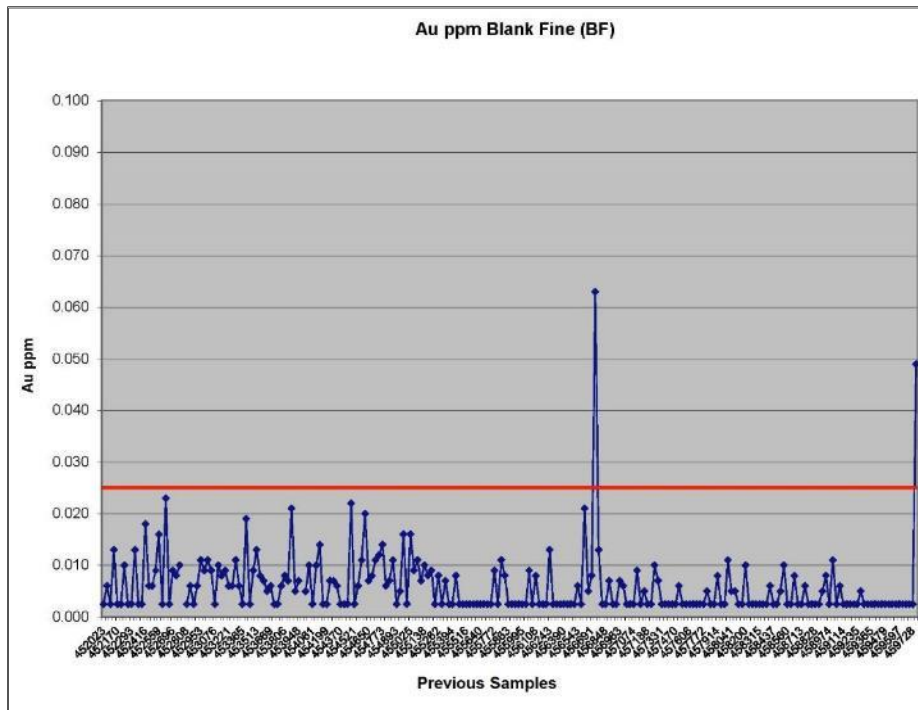
Blank samples were inserted into the sample stream at an average of one for every 25 samples submitted to the laboratories used during exploration drill program. The blank reference material was prepared by Alio from barren rock (basalt) acquired from the San Francisco property. For the period from August, 2016 to March, 2017, a total of 234 blank samples were submitted for gold analysis, of which 173 were sent to the Bureau Veritas and 61 were sent to the ALS Laboratories in Canada and the USA. Figure 11.21 through Figure 11.24 plot the results obtained for both laboratories.

Overall, the results for the blank sample analyses obtained by both laboratories are considered satisfactory.

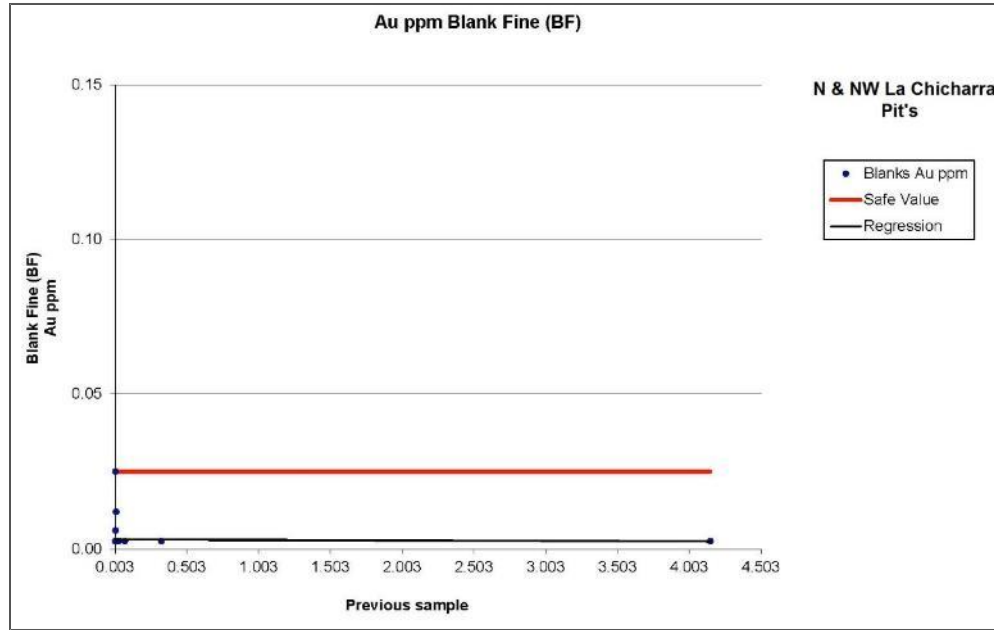
**Figure 11.21**  
Plot of Blank Assay Data from the Bureau Veritas Laboratory for the 2016 to 2017 Drill Program at San Francisco Pit



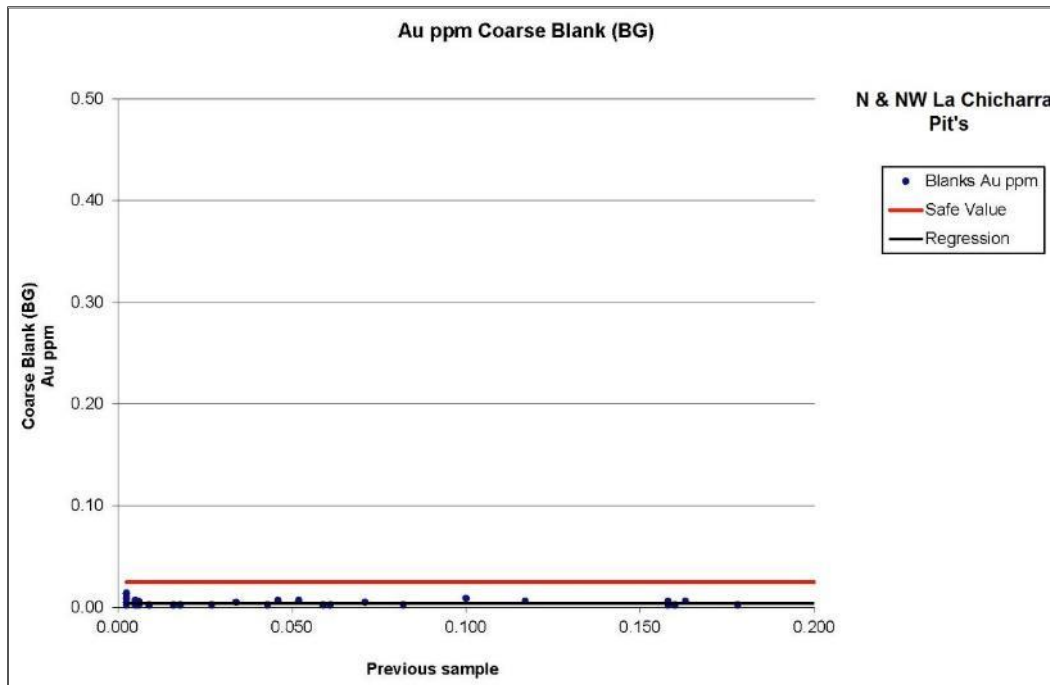
**Figure 11.22**  
Plot of Blank Assay Data from the ALS Minerals Laboratory for the 2016 to 2017 Drill Program at San Francisco Pit



**Figure 11.23**  
Plot of Blank Assay Data from the Bureau Veritas Laboratory for the 2016 to 2017 Drill Program at N & NW Chicharra Pit



**Figure 11.24**  
Plot of Blank Assay Data from the ALS Minerals Laboratory for the 2016 to 2017 Drill Program at N & NW Chicharra Pit



## **11.8 2017 AND 2018 DRILLING PROGRAM QA/QC**

### **11.8.1 August to December, 2017 Drilling Program QA/QC**

For the portion of the 2017 drilling program conducted between August and December, there were no changes to the QA/QC program. Thus, the previous information regarding the 2016-2017 QA/QC program at the San Francisco Project was still valid for the remainder of 2017.

### **11.8.2 2018 Drilling Program QA/QC**

For the 2018 drill campaign, all samples were assayed in the laboratory located at the San Francisco Project. Assaying at a mine's on-site laboratory is common throughout the world and these data are usually used for updating the project data unless major issues have been identified with the use of the on-site analysis.

All drill sample assays were performed using fire assays and cold cyanidation. A total of 5,027 samples were sent for analysis, of which, 333 were control samples with an insertion percentage of 6.6%.

The quality control protocol during in-fill drilling consisted of inserting blanks, duplicates and standards, alternated approximately every 12 samples. The QA/QC results of the control samples were reviewed and Alio believed that the validated information met the requirements to be entered into the San Francisco resource model. A total of 333 control samples were inserted, consisting of 60 fine blanks (18%), 63 coarse blanks (19%), 72 duplicates (22%), 138 standards (41%).

Three different standards from obtained from Rocklabs were used in the 2018 program. The Rocklabs standard reference samples used were:

- OXC-145 (0.212 g/t Au).
- OXD-144 (0.417 g/t Au).
- OXG-124 (0.918 g/t Au).

#### **11.8.2.1 OXC-145 Standard Reference Sample**

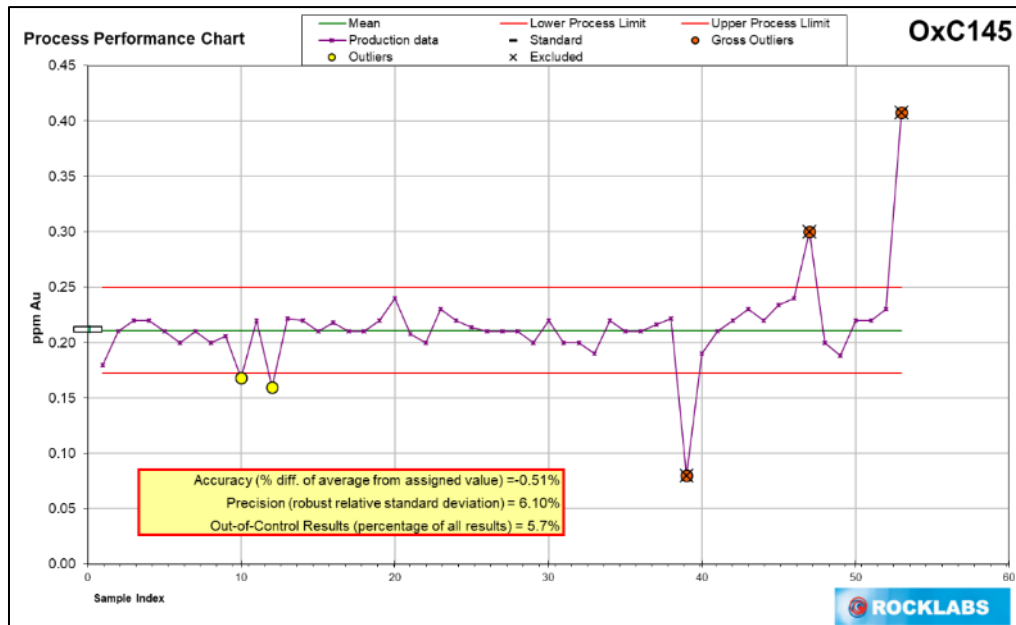
Three of the 53 OXC-145 reference samples were considered to be outliers, outside the maximum allowable limits of 3 standard deviations (SD). The three sample outliers represent 5.7% of the total number of samples analyzed. Table 11.16 summarizes the information for standard reference sample OXC-145. Figure 11.25 is a plot of the results for standard reference sample OXC-145.



**Table 11.16**  
Summary of the Analysis Information for Standard Reference Sample OXC-145

Analysis Table	All results	Gross Outliers Excluded	User Outliers Excluded	Comments
Number of results	53	50	50	
Average	0.2138	0.2109	0.2109	
Accuracy: (% Difference of Average from Assigned Value)	0.9%	-0.5%	-0.5%	
Precision: Relative Standard deviation (Robust)	10.1%	6.1%	6.1%	Industry Typical
Number of Outlying Results (Outside Process Limits)	0	3	3	
Percentage of Outlying Results ⇒			5.7%	Room for improvement

**Figure 11.25**  
Plot for the Analysis Information for Standard Reference Sample OXC-145



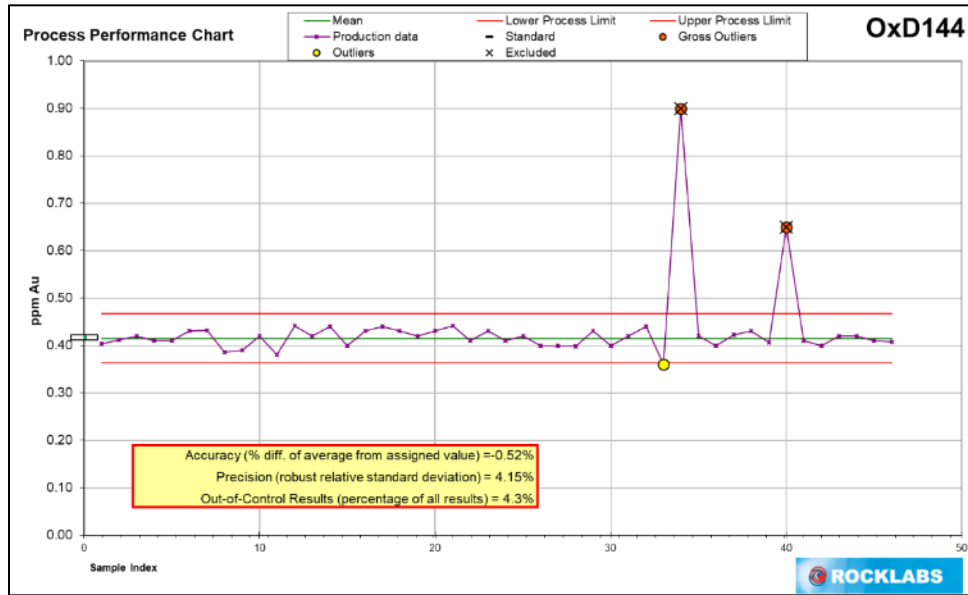
11.8.2.2 OXD-144 Standard Reference Sample

Two of the 46 OXD-144 reference samples are considered to be outliers, which represents 4.3% of the total samples analyzed. Table 11.17 summarizes the information for standard reference sample OXD-144. Figure 11.26 is a plot of the results for standard reference sample OXD-144.

**Table 11.17**  
Summary of the Analysis Information for Standard Reference Sample OXD-144

Analysis Table	All results	Gross Outliers Excluded	User Outliers Excluded	Comments
Number of results	46	44	44	
Average	0.4305	0.4148	0.4148	
Accuracy: (% Difference of Average from Assigned Value)	3.2%	-0.5%	-0.5%	
Precision: Relative Standard deviation (Robust)	10.5%	4.1%	4.1%	Good
Number of Outlying Results (Outside Process Limits)	0	2	2	
Percentage of Outlying Results ⇒			4.3%	Industry typical

**Figure 11.26**  
**Plot for the Analysis Information for Standard Reference Sample OXD-144**



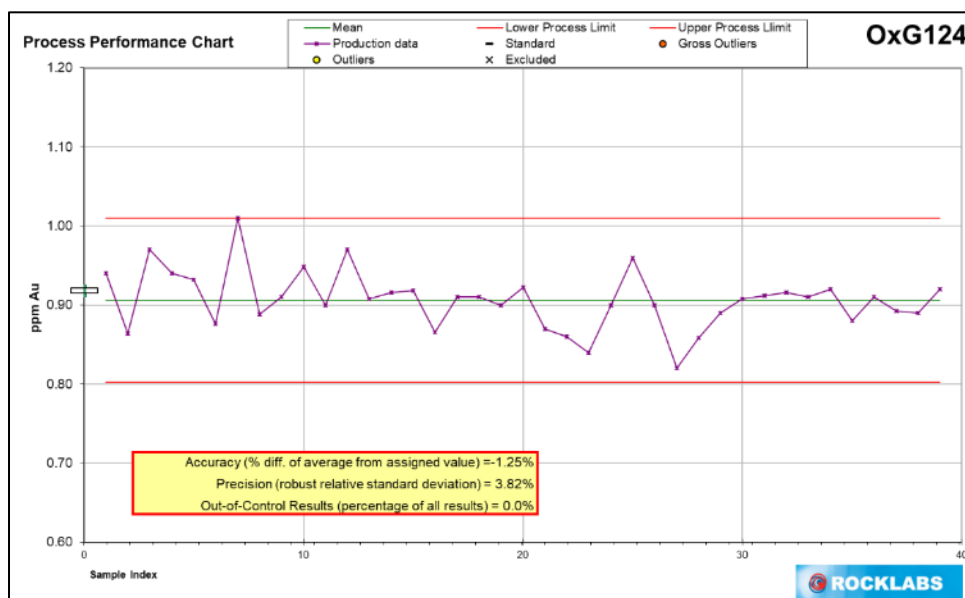
11.8.2.3 OXG-124 Standard Reference Sample

None of the OXG-124 standard reference samples analyzed fell outside of the allowable limits as set out for the standard. Table 11.18 summarizes the information for standard reference sample OXG-124. Figure 11.27 is a plot of the results for standard reference sample OXG-124.

**Table 11.18**  
**Summary of the Analysis Information for Standard Reference Sample OXG-124**

<b>Analysis Table</b>	<b>All results</b>	<b>Gross Outliers Excluded</b>	<b>User Outliers Excluded</b>	<b>Comments</b>
Number of results	39	39	39	
Average	0.9065	0.9065	0.9065	
Accuracy: (% Difference of Average from Assigned Value)	-1.3%	-1.3%	-1.3%	
Precision: Relative Standard deviation (Robust)	3.8%	3.8%	3.8%	Good
Number of Outlying Results (Outside Process Limits)	0	0	0	
Percentage of Outlying Results ⇒			0.0%	Good

**Figure 11.27**  
**Plot for the Analysis Information for Standard Reference Sample OXG-124**

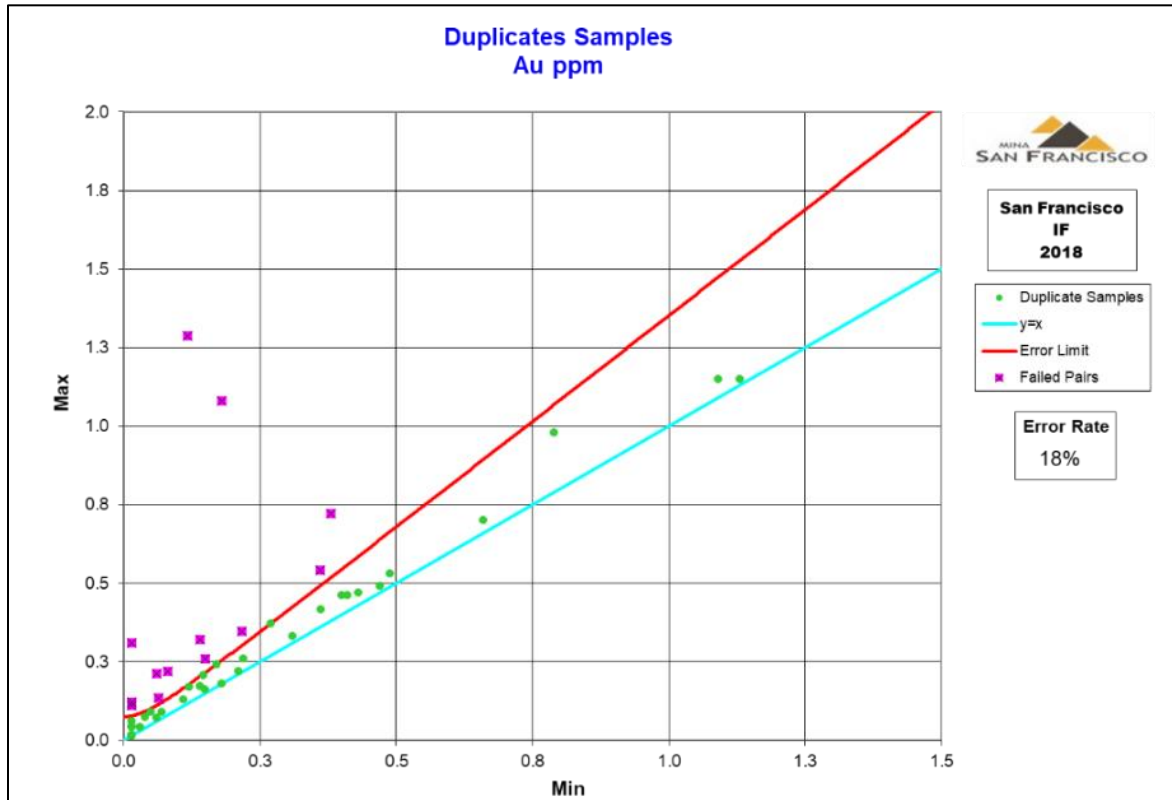


#### 11.8.2.4 Blanks and Duplicates

The San Francisco Project laboratory has a lower detection limit of 0.03 ppm Au for the fire assay. In the review of the blank assays, a lower limit detection equivalent was used that was five times the lower limit detection of the mine laboratory. Fine and coarse blanks were found to be within the allowed limits.

Coarse duplicates were analyzed based on a tolerance of 15%, and an error rate of 18% was observed. In total, 13 out of 72 samples exceeded the allowed margin. Figure 11.28 is a plot of the duplicate sample analysis for the 2018 drilling program.

Figure 11.28  
Plot of the Duplicate Sample Analysis for the 2018 Drilling Program



### 11.9 MICON COMMENTS

Micon considers that the QA/QC program that was in place as part of Alio's procedures was of sufficient quality to be considered as following the best practices guidelines as published by the CIM and that the results were suitable to be used as the basis of its mineral resource estimate for the Project.

Magna has indicated it will continue using the QA/QC program already in place at the San Francisco Project. From time to time, the certified standards will be updated as the older certified standards become unavailable, or as better analogous standards become available. As Magna begins to conduct regional exploration programs in the vicinity of the San Francisco Project, it will be refining its exploration QA/QC program as required.

## 12.0 DATA VERIFICATION

The Qualified Persons (QPs) responsible for the preparation of this report are:

- William J. Lewis, P.Geo. Senior Geologist with Micon.
- Richard M. Gowans, P.Eng., President and Principal Metallurgist with Micon.
- Christopher Jacobs, CEng, MIMMM., Vice-President and Mineral Economist with Micon.
- Nigel Fung, B.Sc.H, B.Eng., P.Eng., Vice-President and Senior Mining Engineer with Micon.
- Ing. Alan San Marin, MAusIMM(CP), Mineral Resource Specialist with Micon.
- Rodrigo Calles-Montijo, CPG, General Administrator and Principal Consultant with the firm Servicios Geológicos IMEx, S.C.

Mr. Lewis is responsible for the independent summary and review of the geology, exploration and QA/QC program, as well as the resources for the San Francisco Project, and the comments on the propriety of Magna's plans and budget for the next phase of exploration and in-fill drilling.

Various aspects of the San Francisco Project were reviewed by other QPs, with Mr. Gowans covering the metallurgical aspects, Mr. Jacobs reviewing the economics, Mr. Fung reviewing the mining aspects and Mr. San Martin undertaking the review of the block model and estimation of the mineral resource completed by Magna.

The most recent site visit was completed on May 29, 2020, by Mr. Rodrigo Calles-Montijo, CPG, who is an independent consultant and Certified Professional Geologist (CPG), as well as a member of the American Institute of Professional Geologists (AIPG). Mr. Calles-Montijo, based in Hermosillo, México, was contacted by Magna in order undertake the current site visit, as required by the NI 43-101 guidelines, and which was unable to be executed by representatives of Micon due to travel limitations created by the COVID-19 pandemic. Prior to the site visit, a Skype meeting was organized with the participation of William J. Lewis (Micon), Miguel Soto (Magna) and Mr. Calles-Montijo, in order to delineate the objectives during the site visit. Mr. Calles-Montijo visited the mine accompanied by Miguel Soto, Vice President of Exploration with Magna Gold Corp., and Jose Luis Soto, Operations Manager of the San Francisco mine.

Mr. Lewis conducted site visits in relation to all of the previous Technical Reports that Micon has written for the San Francisco Project. These reports spanned the original acquisition and early exploration through to, and including, the production phase of the Project. Site visits in conjunction with Technical Reports were conducted in 2005, 2007, 2008, 2009, 2010, 2011, 2013, 2016 (two visits) and 2017.

## **12.1 NOTES FROM PREVIOUS ALIO SITE VISITS**

Since 2005, Micon has prepared 11 previous Technical Reports on the San Francisco mine, all of which have been filed on SEDAR and are referenced in Section 28 of this report. The steps taken by Micon to verify the databases and material provided by Alio for the previous reports have been the same as described below.

### **12.2 2017 SITE VISIT**

A site visit was conducted between May 15 and 17, 2017, related to the publication of the 2017 Technical Report. In addition to the site visit to the San Francisco mine, a day was spent at the exploration offices in Hermosillo, reviewing data for the report. Discussions were also held with responsible Alio personnel.

Prior to the 2017 and 2016 site visits, the database and model were reviewed in Toronto. This allowed for any potential issues to be noted so that they could be discussed during the site visit. No issues were noted with the database and model during these reviews.

A number of discussions were held via Skype and phone conference calls between Micon personnel in Toronto and Alio personnel in Hermosillo regarding the database, block model and parameters for the mineral resource estimate, as well as other topics related to the audit and preparation of previous Technical Reports.

The QPs responsible for the preparation of the 2017 report were William J. Lewis, P.Geo., Alan J. San Martin, MAusIMM(CP)., Mani Verma, P.Eng., and Richard M. Gowans, P.Eng.

No independent samples were taken by Micon during the 2016 and 2017 site visits as the San Francisco Project was an operating mine and produced gold doré, verifying the existence of gold mineralization on the property.

### **12.3 2020 SITE VISIT**

The San Francisco mine was visited on May 29, 2020, by Mr. Rodrigo Calles-Montijo, CPG, an independent consultant and certified geologist with the AIPG.

The site visit included an overview of the relevant facilities, which included the San Francisco and La Chicharra open pits, the operative heap leach pads and the extraction plants.

Mining operations at the San Francisco and La Chicharra open pits had been in standby mode since December, 2018. General conditions in both open pits were observed to be adequate for a near-future re-start of mining operations. It was noted during the site visit that a general cleaning of the access ramps and stabilization of some sectors along the southern wall of the San Francisco open pit would be required. At the La Chicharra open pit, a new access ramp is programmed as part, of an updated mine plan by Magna. According to the verbal information

received from the representatives of Magna, the conditioning work in both open pits will take approximately 15 days, after which production from the pits could be resumed.

The crushing plant was observed during the site visit. The facility is currently not operating but has been maintained such that it can be brought back into operation with little difficulty.

At the time of the 2020 site visit, the heap leach pad was operating under residual leach conditions. Based on the comments from Magna representatives, it was expected that the residual leach process would be completed by the end of the 2020.

Two ADR plants for the pregnant leach solution are still currently operating. ADR Plant 2 was visited and it was observed that the recovery carbon column system is currently in operation. Currently, the final extraction has been completed in ADR Plant 2.

General infrastructure, such as offices, laboratory, workshops, etc., were observed to have been under adequate care and maintenance. The infrastructure appears to be in satisfactory condition, such that full operations could restart in a short period of time.

Figure 12.1 through Figure 12.6 are photographs of the San Francisco Project, taken by Mr. Calles-Montijo during the site visit conducted on May 29, 2020.

Subsequent to the 2020 site visit, Magna has restarted operations at the San Francisco Project. Material from the low-grade stockpiles, as well as the open pits, is being placed on the heap leach pads.

#### **12.4 MICON DATA VERIFICATION FOR MAGNA RESOURCES AND RESERVES**

Micon received the databases from Magna and conducted a thorough review of the resource and reserve estimates conducted by Magna, based on Alio historical databases. These databases were extensively reviewed by Alan San Marin and Nigel Fung to ensure that the data were appropriate to be used for Magna's mineral resource and reserve estimates, and that Magna's mine plans and schedule accurately reflected the mineral resources and reserves. A number of Skype and Zoom meetings were held with Magna personnel to ensure that all aspects of the estimates were reviewed, with changes instituted when necessary.

The metallurgical aspects and infrastructure for the Project were reviewed by Mr. Gowans and the economic model used by Magna was reviewed by Mr. Jacobs. Discussions were held with Magna personnel on all of these matters.

**Figure 12.1**  
**View of the San Francisco Pit Looking East**



Source: Rodrigo Calles-Montijo, 2020.

**Figure 12.2**  
**View of the La Chichara Pit Looking West-Northwest**



Source: Rodrigo Calles-Montijo, 2020.



**Figure 12.3**  
**View Looking Southeast Towards the San Francisco Pit**



Note: The remaining low-grade stock pile is shown in the middle left side of the picture.  
Source: Rodrigo Calles-Montijo, 2020.

**Figure 12.4**  
**View Looking Southwest Towards the La Chicharra Waste Pile and Pit in the Distance**



Note: Picture taken from one of the leach pads with a further leach pad in the centre left of the picture.  
Source: Rodrigo Calles-Montijo, 2020.

**Figure 12.5**  
**View of ADR Plant 2**



Source: Rodrigo Calles-Montijo, 2020.

**Figure 12.6**  
**Partial View of the Crushing Facility**



Source: Rodrigo Calles-Montijo, 2020.

## **12.5 GENERAL MICON COMMENTS**

In general, Micon's review of the material provided by Magna and its discussions with Magna personnel during various Skype and Zoom meetings found that the data provided were adequate for the purposes of preparing Technical Reports for the San Francisco Project.

Micon has conducted a number of prior data verification reviews of the San Francisco Property for the previous Technical Reports and, in each case, has found that the data provided were adequate to serve as the basis of the material contained within those reports.

Magna has acquired ASlio's databases and technical data, and these data have been used to support the work and studies that Magna has undertaken. Micon's QPs believe the data to be of sufficient quality to use in a Technical Report in support of Magna's Pre-feasibility to bring the Project back into operation.

### **13.0 MINERAL PROCESSING AND METALLURGICAL TESTING**

Since Magna became the owner of the property earlier this year there has been no significant metallurgical testwork. However, Alio periodically completed metallurgical testwork in order to optimize gold recoveries and to gain a better understanding of the mineralization as mining continued at the San Francisco Property.

The San Francisco Property has been in production as a conventional gold heap leach operation since 2010 and, to date, there have been no processing factors or deleterious elements identified that have had a material negative effect on economic extraction.

#### **13.1 2012 TESTWORK BY METCON**

In November, 2012, Alio announced the results from a bulk sample locked column leach testing program on representative mineralized samples from the San Francisco Project. This test program was completed at the METCON Research metallurgical laboratory in Tucson, Arizona.

The cyanide leach column test results indicated an average gold extraction after 127 days of 71.0%, based on a crush size of 80% of the particles passing (P<sub>80</sub>) 9.5 mm (3/8inch), and 77.1% extraction with a crush size of P<sub>80</sub> 6.3 mm (1/4inch). For La Chicharra samples, the average column test gold extractions for the same leaching period were 78.3% and 80.9%, based on crush sizes of P<sub>80</sub> 9.5 mm and P<sub>80</sub> 6.3 mm, respectively. No percolation issues were observed during the column leach tests.

Alio stated, in the November, 2012 press release, that it was encouraged by the results from the testing program but that it would continue to use a life-of-mine (LOM) gold recovery of 68.6% in its resource estimations, mine planning and economic analyses. Alio also stated that it believed that the results of the testing program indicated that there was potential to further improve its gold recoveries through optimization of the process.

##### **13.1.1 Discussion of the 2012 Test Results**

Six composite samples were tested in the 2012 metallurgical study; five from the San Francisco deposit and one from the La Chicharra deposit. The samples were classified by the following rock types:

- La Chicharra.
- San Francisco
  - SF – Granite.
  - SF – Basic gneiss.
  - SF – Gabbro.
  - SF – Pegmatite and schist.
  - SF – Acid gneiss.

Table 13.1 and Table 13.2 summarize the final gold extractions for these samples, based on P<sub>80</sub> crush sizes of 9.5 and mm 6.3 mm, respectively, and a leach time of 127 days. Two averages are presented in the tables, a simple arithmetic average and a weighted average based on the estimated LOM relative abundance of each rock type within the deposit. The samples were considered a good representation of each of the rock types and style of the mineralization within the deposit as a whole.

**Table 13.1**  
**Summary of Column Leach Test Results, Crush Size P<sub>80</sub> 9.5 mm, 127 Days Leach Time**

Sample Description	Relative Proportion of the Deposit (%)	Au Extraction (%)
SF - Granite	13.0	76.58
SF – Basic Gneiss	26.4	71.08
SF - Gabbro	18.9	63.79
SF – Pegmatite and Schist	12.7	74.38
SF – Acid Gneiss	29.1	71.40
<b>Sample average</b>	<b>100</b>	<b>71.45</b>
<b>Weighted average (based on LOM abundances)</b>	<b>100</b>	<b>71.00</b>
<b>La Chicharra</b>	<b>100</b>	<b>78.34</b>

Table provided by Alio Gold Inc.

**Table 13.2**  
**Summary of Column Leach Test Results, Crush Size P<sub>80</sub> 6.3 mm, 127 Days Leach Time**

Sample Description	Relative Proportion of the Deposit (%)	Au Extraction (%)
SF - Granite	13.0	87.89
SF – Basic Gneiss	26.4	74.37
SF - Gabbro	18.9	71.22
SF – Pegmatite and Schist	12.7	79.69
SF – Acid Gneiss	29.1	77.03
<b>Sample average</b>	<b>100</b>	<b>78.04</b>
<b>Weighted average (based on LOM abundances)</b>	<b>100</b>	<b>77.06</b>
<b>La Chicharra</b>	<b>100</b>	<b>80.89</b>

Table provided by Alio Gold Inc.

The leaching test parameters used for the column leach tests are summarized below:

- Sample sizes were approximately 180 kg for each column test.
- Lime was blended with the test charge. Lime addition was estimated from a 72 hr agitated cyanidation bottle roll test.
- The initial feed solution was prepared by adding reagent grade lime to Tucson tap water to obtain a solution pH of 11.00, followed by the addition of 1.0 gram of sodium cyanide per litre (g/L) of solution. The columns were irrigated at a flow rate of 10 L/h/m<sup>2</sup>.
- Column tests were conducted under a locked cycle type of leaching regime, by contacting the pregnant solution with activated carbon to remove gold and silver. The

loaded activated carbon in each column test was dried, weighed and saved in sealed and labeled plastic bags.

- The resulting barren solution was recycled as column feed solution after the addition of sodium cyanide and lime to maintain a cyanide solution strength of 1.0 g/L and a pH of between 10.5 to 11.0.

The regression analysis conducted on the pregnant solution assays showed that there is a good correlation between the original gold and silver assays and the duplicate assays.

### 13.2 ON-SITE INTERNAL TESTWORK

As the operator, Alio conducted internal column leach testing to obtain a better understanding of the metallurgical response of the mineralization types located on the San Francisco property, and to monitor and optimize gold leach recovery at the operation. Table 13.3 summarizes the 2015 results from these internal metallurgical column leach tests and Table 13.4 presents the preliminary column test results from a series of tests undertaken in 2017.

**Table 13.3**  
**Summary of the 2015 Internal Metallurgical Testwork**

ID Test	Sample ID	Column Height (m)	Presoak <sup>1</sup> (mg/L)	Solution Strength (ppm NaCN)	Au Grade (g/t)	Rock Size (<9.5 mm)	Days Leached	% Gold Recovery
<b>Regular Monthly Composites</b>								
January, 2015	1	3	1,000	350	0.500	85.61%	90	63.59%
January, 2015	1 A	3	2,000	350	0.500	85.61%	90	63.15%
February, 2015	2	3	1,000	350	0.480	83.95%	90	61.91%
February, 2015	2 A	3	2,000	350	0.480	83.95%	90	59.87%
March, 2015	3	3	1,000	350	0.520	81.94%	90	52.00%
March, 2015	3 A	3	2,000	350	0.564	85.71%	90	53.10%
April, 2015	4	3	2,000	350	0.510	85.18%	90	59.95%
April, 2015	4 A	3	2,000	250	0.520	86.33%	90	59.08%
April, 2015	4 B	3	2,000	350	0.510	100.00%	90	62.13%
April, 2015	4 C	3	2,000	250	0.510	100.00%	90	59.17%
May, 2015	5	3	2,000	350	0.530	85.18%	90	69.21%
May, 2015	5A	3	2,000	350	0.560	85.18%	90	68.72%
May, 2015	5B	3	2,000	350	0.510	85.18%	90	68.70%
June, 2015	6	3	2,000	350	0.450	88.01%	90	59.53%
June, 2015	6A	3	2,000	350	0.415	89.04%	90	59.86%
June, 2015	6B	3	2,000	350	0.480	88.31%	90	61.17%
July, 2015	7	3	2,000	500	0.502	86.99%	90	58.31%
July, 2015	7A	3	2,000	500	0.502	86.99%	90	56.92%
August, 2015	8	3	2,000	500	--	--	15	36.18%
August, 2015	8A	3	2,000	500	--	--	15	34.52%
September, 2015	9	3	2,000	500	0.480	86.78%	51	52.64%
September, 2015	9A	3	2,000	500	0.510	85.31%	51	54.28%
<b>Variable Rock Types</b>								
Old ore Phase 2	RPL-01	3	N/A	250	0.412	81.00%	90	20.55%
Old ore Phase 2	RPL-02	3	N/A	250	0.412	82.00%	90	20.46%
Underground ore	2 SUB 01	3	2,000	300	4.400	100.00%	90	64.92%

ID Test	Sample ID	Column Height (m)	Presoak <sup>1</sup> (mg/L)	Solution Strength (ppm NaCN)	Au Grade (g/t)	Rock Size (<9.5 mm)	Days Leached	% Gold Recovery
Underground ore	2 SUB 02	3	2,000	500	4.400	100.00%	90	64.71%
Underground ore	2 SUB 03	3	N/A	500	3.030	97.50%	90	69.35%
Underground ore	2 SUB 04	3	N/A	500	3.030	97.80%	90	66.74%
Metallurgical Research								
Oct-15, with O <sub>2</sub>	Col. A	2.5	N/A	400	0.370	86.25%	23	73.50%
Oct-15, without O <sub>2</sub>	Col. B	2.5	N/A	400	0.370	86.25%	23	68.78%
Old ore with O <sub>2</sub>	Col. C	2.5	N/A	400	0.200	85.26%	23	23.21%
Old ore without O <sub>2</sub>	Col. D	2.5	N/A	400	0.200	85.28%	23	19.37%

Table provided by Alio Gold Inc.

<sup>1</sup> Presoak, 7% solution by weight with 1 or 2 g/L sodium cyanide (NaCN) solution.

**Table 13.4**  
**Summary of the 2017 Internal Metallurgical Testwork**

ID Test	Assayed Head (g/t)	Calculated Head (g/t)	NaCN consumed (g/t)	Crush Size (P <sub>80</sub> mm)	Days Leached	Liquid/Solid Ratio	% Gold Recovery
Regular Monthly Composites							
December 2016 composite	0.51	0.47	250	7.97	80	2.27	61.72%
January 2017 composite	0.42	-	312	7.47	73	2.16	81.07%
February 2017 composite	0.39	-	372	8.29	62	1.95	76.32%
March 2017 composite	0.44	-	180	7.89	51	1.59	53.77%
April 2017 composite	0.39	-	54	7.76	19	0.49	53.63%
Variable Rock Types							
Low-grade stockpiled	0.25	0.26	200	7.26	58	1.64	63.55%
Low-grade stockpiled + solid peroxide	0.25	0.26	150	6.97	58	1.71	64.25%
Basic gneiss, SF	0.27	0.27	120	7.24	59	1.81	52.22%
Basic gneiss, LCH	0.49	0.45	164	7.10	59	1.75	69.82%
Gabbro, LCH	0.30	0.28	177	7.28	59	1.59	76.53%
Gabbro, SF <sup>*1</sup>	0.17	0.16	55	7.40	23	0.53	46.88%
Granite, SF	0.72	-	362	6.89	105	3.504	60.84%
Las Barajitas ore	0.66	-	54	6.70	12	0.26	61.31%
Metallurgical Research							
December 2016 composite + solid peroxide	0.51	0.47	185	7.97	80	2.31	62.86%
January 2017 composite + solid peroxide	0.42	-	258	7.47	73	2.02	84.44%
January 2017 composite (P <sub>90</sub> - 1/4")	0.42	-	342	4.49	73	1.64	81.38%
February 2017 composite + solid peroxide	0.38	-	144	8.29	41	1.15	73.36%
Electronic Initiator ENAEX	0.24	-	67	11.06	35	1.00	43.94%
Variable Grind Size (dated at March 23, 2017)							
OVERLAND P80 9.41 mm	0.41	-	95	9.41	33	1.04	44.92%

ID Test	Assayed Head (g/t)	Calculated Head (g/t)	NaCN consumed (g/t)	Crush Size (P <sub>80</sub> mm)	Days Leached	Liquid/Solid Ratio	% Gold Recovery
OVERLAND P80 7.87 mm	0.41	-	87	7.87	33	0.93	47.29%
OVERLAND P80 6.35 mm	0.39	-	131	6.35	33	1.07	49.23%

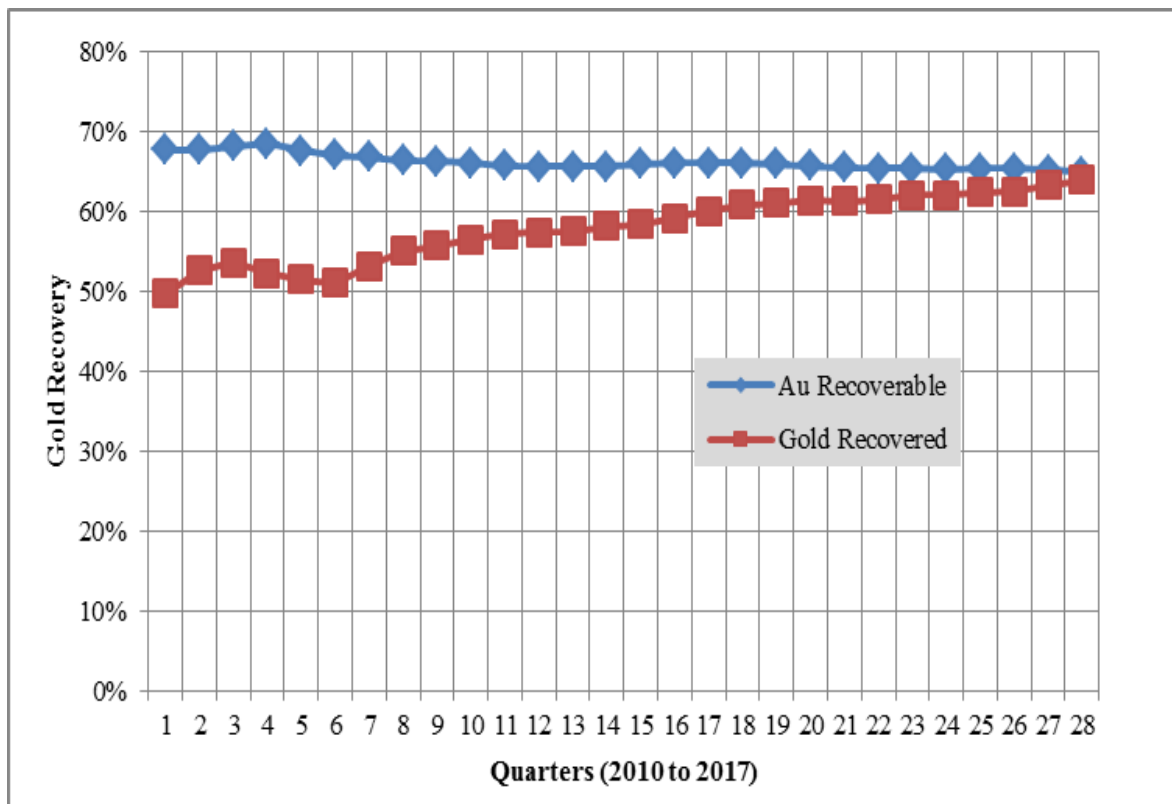
<sup>1</sup> Table provided by Alio Gold Inc.

<sup>2</sup> No Presoak

### 13.2.1 Discussion of Column Test Results

The regular monthly column test results show gold recoveries between 52% and 81% for tests operated for 60 day or more. These test results compare reasonably well with the typical plant gold recovery which, historically, has been approximately 65%. Figure 13.1 presents the cumulative reported recoverable and actual gold recoveries from 2010 to 2017.

**Figure 13.1**  
**Historical Cumulative Plant Gold Recoveries**



Of particular note are the relatively high recoveries achieved for the standard 2017 January and February composite tests, which were 81% and 76%, respectively.

The metallurgical test results presented above suggest that the addition of oxygen and/or peroxide improves the kinetics and the overall gold recovery. Also, preliminary results from recent tests comparing crush sizes have shown improved gold recoveries with finer crushing.



### 13.3 MICON COMMENTS/CONCLUSIONS

Micon understands that Magna will continue to use the information obtained from internal testing programs to improve the understanding of the various mineralization types and to optimize the current process to maximize recovery of gold from the San Francisco and La Chicharra deposits.

Magna's most recent LOM plan uses gold recovery curves that maximize after 150 day's leaching at 73% and 66% gold recovery for La Chicharra and San Francisco mineralization, respectively. This forecast is based on testwork and historical operating results.

## 14.0 MINERAL RESOURCE ESTIMATES

### 14.1 INTRODUCTION

The resource estimate completed by Magna and audited by Micon for this report, is compliant with the current CIM standards and definitions specified by NI 43-101, and supersedes all previous mineral resource estimates for the San Francisco and La Chicharra deposits. The effective date of the current mineral resource estimate is August 8, 2020.

Magna's current resource update for San Francisco and La Chicharra deposits includes 245 new drill holes totalling 35,570 m which were completed at the San Francisco mine between August, 2017 and July, 2018, all drilled on the San Francisco pit.

A gold price of USD 1,500 and adjusted mining costs were used for the mineral resource estimate, which resulted in a lower cut-off grade of gold.

The process of mineral resource estimation includes technical information which requires subsequent calculations or estimates to derive sub-totals, totals and weighted averages. Such calculations or estimations inherently involve a degree of rounding and consequently introduce a margin of error. Where these occur, Micon does not consider them to be material.

### 14.2 CIM MINERAL RESOURCE DEFINITIONS AND CLASSIFICATIONS

All resources and reserves presented in a Technical Report must follow the current CIM definitions and standards for mineral resources and reserves. The latest edition of the CIM definitions and standards was adopted by the CIM council on May 10, 2014, and includes the resource definitions reproduced below:

*“Mineral Resources are sub-divided, in order of increasing geological confidence, into Inferred, Indicated and Measured categories. An Inferred Mineral Resource has a lower level of confidence than that applied to an Indicated Mineral Resource. An Indicated Mineral Resource has a higher level of confidence than an Inferred Mineral Resource but has a lower level of confidence than a Measured Mineral Resource.”*

*“A Mineral Resource is a concentration or occurrence of solid material of economic interest in or on the Earth's crust in such form, grade or quality and quantity that there are reasonable prospects for eventual economic extraction.”*

*“The location, quantity, grade or quality, continuity and other geological characteristics of a Mineral Resource are known, estimated or interpreted from specific geological evidence and knowledge, including sampling.”*

*“Material of economic interest refers to diamonds, natural solid inorganic material, or natural solid fossilized organic material including base and precious metals, coal, and industrial minerals.”*

*“The term Mineral Resource covers mineralization and natural material of intrinsic economic interest which has been identified and estimated through exploration and sampling and within which Mineral Reserves may subsequently be defined by the consideration and application of Modifying Factors.”*

### **“Inferred Mineral Resource”**

*“An Inferred Mineral Resource is that part of a Mineral Resource for which quantity and grade or quality are estimated on the basis of limited geological evidence and sampling. Geological evidence is sufficient to imply but not verify geological and grade or quality continuity.”*

*“An Inferred Mineral Resource has a lower level of confidence than that applying to an Indicated Mineral Resource and must not be converted to a Mineral Reserve. It is reasonably expected that the majority of Inferred Mineral Resources could be upgraded to Indicated Mineral Resources with continued exploration.”*

*“An Inferred Mineral Resource is based on limited information and sampling gathered through appropriate sampling techniques from locations such as outcrops, trenches, pits, workings and drill holes. Inferred Mineral Resources must not be included in the economic analysis, production schedules, or estimated mine life in publicly disclosed Pre-Feasibility or Feasibility Studies, or in the Life-of-mine plans and cash flow models of developed mines. Inferred Mineral Resources can only be used in economic studies as provided under NI 43-101.”*

### **“Indicated Mineral Resource”**

*“An Indicated Mineral Resource is that part of a Mineral Resource for which quantity, grade or quality, densities, shape and physical characteristics are estimated with sufficient confidence to allow the application of Modifying Factors in sufficient detail to support mine planning and evaluation of the economic viability of the deposit.”*

*“Geological evidence is derived from adequately detailed and reliable exploration, sampling and testing and is sufficient to assume geological and grade or quality continuity between points of observation.”*

*“An Indicated Mineral Resource has a lower level of confidence than that applying to a Measured Mineral Resource and may only be converted to a Probable Mineral Reserve.”*

*“Mineralization may be classified as an Indicated Mineral Resource by the Qualified Person when the nature, quality, quantity and distribution of data are such as to allow confident interpretation of the geological framework and to reasonably assume the continuity of mineralization. The Qualified Person must recognize the importance of the Indicated Mineral Resource category to the advancement of the feasibility of the project. An Indicated Mineral Resource estimate is of sufficient quality to support a Pre-Feasibility Study which can serve as the basis for major development decisions.”*

### **“Measured Mineral Resource”**

*“A Measured Mineral Resource is that part of a Mineral Resource for which quantity, grade or quality, densities, shape, and physical characteristics are estimated with confidence sufficient to*

allow the application of Modifying Factors to support detailed mine planning and final evaluation of the economic viability of the deposit.”

“Geological evidence is derived from detailed and reliable exploration, sampling and testing and is sufficient to confirm geological and grade or quality continuity between points of observation.

A Measured Mineral Resource has a higher level of confidence than that applying to either an Indicated Mineral Resource or an Inferred Mineral Resource. It may be converted to a Proven Mineral Reserve or to a Probable Mineral Reserve.”

“Mineralization or other natural material of economic interest may be classified as a Measured Mineral Resource by the Qualified Person when the nature, quality, quantity and distribution of data are such that the tonnage and grade or quality of the mineralization can be estimated to within close limits and that variation from the estimate would not significantly affect potential economic viability of the deposit. This category requires a high level of confidence in, and understanding of, the geology and controls of the mineral deposit.”

### 14.3 CIM ESTIMATION OF MINERAL RESOURCES BEST PRACTICES GUIDELINES

Micon and its QPs have used the CIM Estimation of Mineral Resources and Mineral Reserves Best Practices Guidelines which were adopted by the CIM Council on November 29, 2019, in conducting the audit of the San Francisco Project. The November, 2019 guidelines supersede the 2003 CIM Best Practices Guidelines which were followed by Micon and its QPs when completing the previous resource estimations and audits.

### 14.4 AUGUST 8, 2020 MINERAL RESOURCE ESTIMATE STATEMENT

The mineral resources, as estimated by Magna, are presented in Table 14.1. This resource estimate includes the mineral reserve discussed in Section 15.

**Table 14.1**  
**Mineral Resource Estimate for the San Francisco and La Chicharra Deposits as of August 8, 2020**  
**(Inclusive of Mineral Reserves) (Gold Price of USD 1,500/Oz)**

Area	Cut-off (Au g/t)	Category	K tonnes	Au (g/t)	Gold (K oz)
San Francisco Mine OP	0.14	Measured	22,975	0.424	313
		Indicated	49,500	0.426	678
		<b>Measured &amp; Indicated</b>	<b>72,475</b>	<b>0.426</b>	<b>992</b>
		Inferred*	10,385	0.465	155
San Francisco UG	1.40	Measured	111	4.160	15
		Indicated	236	3.907	30
		<b>Measured &amp; Indicated</b>	<b>347</b>	<b>3.988</b>	<b>44</b>
La Chicharra Mine OP	0.12	Measured	11,589	0.502	187
		Indicated	15,289	0.42	206
		<b>Measured &amp; Indicated</b>	<b>26,878</b>	<b>0.455</b>	<b>393</b>
		Inferred*	989	0.488	16

Area	Cut-off (Au g/t)	Category	K tonnes	Au (g/t)	Gold (K oz)
Total Resources		Measured	34,675	0.462	515
		Indicated	65,025	0.437	914
		<b>Measured &amp; Indicated</b>	<b>99,700</b>	<b>0.446</b>	<b>1,430</b>
		Inferred*	11,374	0.467	171

\*Inferred resources in this table only include material within the limits of the USD 1,500/oz Au pit shell and do not include material outside the pits limit.

Micon is not aware of any environmental, permitting, legal, title, taxation, socio-economic, marketing or political issues which would adversely affect the mineral resources estimated above. However, mineral resources that are not mineral reserves do not have demonstrated economic viability. The mineral resource figures in Table 14.1 have been rounded to reflect that they are estimates and, therefore, the addition may not sum in the table.

Both the CIM and the Australasian Joint Ore Reserves Committee (JORC) codes state that mineral resources must meet the condition of “a reasonable prospect for eventual economic extraction.” Magna developed a Lerchs Grossman pit shell geometry at reasonable gold prices, costs and recovery assumptions, in order to satisfy this condition. The resource estimate presented in Table 14.1 is based on a pit shell designed at a gold price of USD 1,500 per ounce and additional cost and recovery parameters developed by Magna.

## 14.5 MINERAL RESOURCE ESTIMATION PROCEDURES

The resource block model is based on 5 m by 5 m by 6 m high blocks. The coordinate limits of the previous model were retained for this current work. The topography was updated to reflect the mined surface as of June 1, 2020. The undisturbed pre-mining topographic surfaces are also available in the model.

Unlike the earlier studies, in which the indicator kriging (IK) estimation method was used to define the mineral resources, a manual interpretation of the mineralized zones based on all of the drilling intersections now available in the database has been used to define the mineral resources.

This approach allows for more precise geological modelling and mineralization interpretation, which enables the planning of better drilling programs to explore the extent of the mineralization and also the preparation of better engineering designs regarding the ore and waste split in the pit. Overall, the method is similar to the previous method, except that the grade envelopes and geological domains are directly interpreted by geologists using the drilling information they have gathered.

### 14.5.1 Database

The database of the San Francisco and La Chicharra deposits consists of 4,570 drill holes with 434,708 sample intervals, mostly 1.5 m in length, of a total database of 640,782 m of drilling for the entire property, including exploration drilling outside the San Francisco and La

Chicharra pits. The current database includes 245 new holes drilled in 2017 and 2018, for 35,570 m of drilling. Figure 14.1 is a plan view of the San Francisco mine drill hole collar locations.

Approximately 13% of the sampling intervals are greater than or equal to 2 m length, about 84% of the intervals are between 1.5 and 2.0 m in length, and about 3% are less than 1.5 m in length. In the case of duplicate samples, the original sample was used in the database. Figure 14.2 shows a 3-D profile of the current topography and the drill holes, looking north.

**Figure 14.1**  
**Plan View of the Drill Hole Collars at the San Francisco Mine**

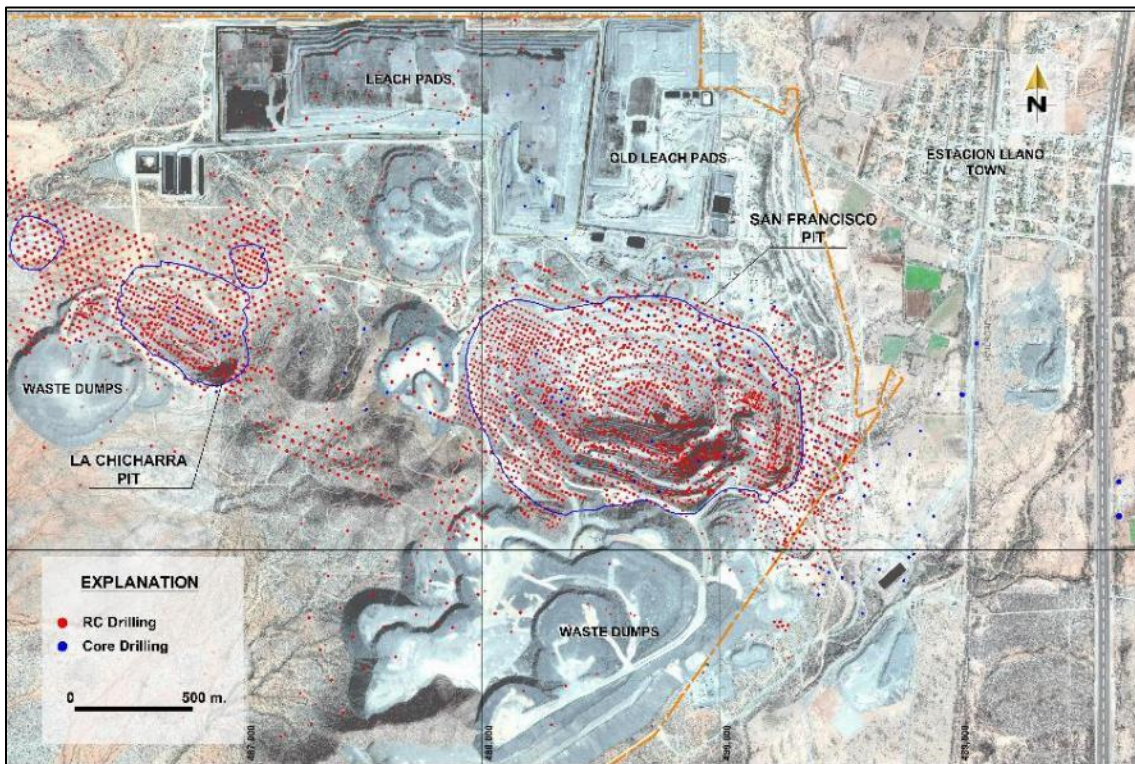


Figure provided by Magna and dated August, 2020.

**Figure 14.2**  
**3-D Profile of the Topography and the Drill Holes at the San Francisco and La Chicharra Pits (Looking North)**

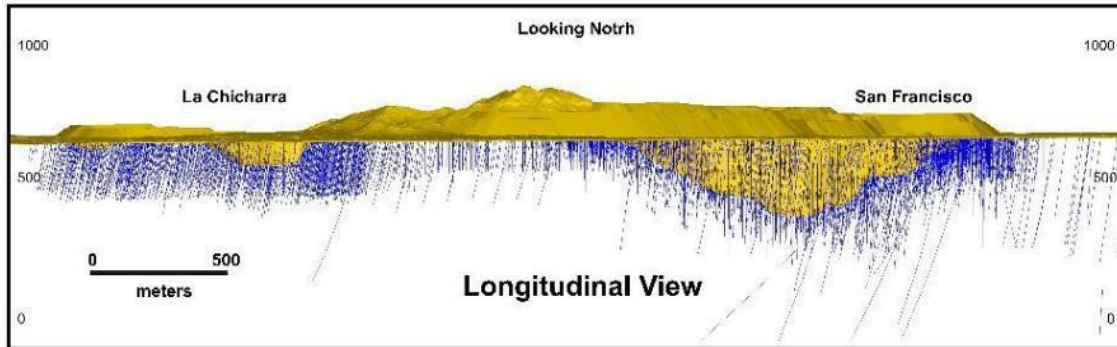


Figure provided by Magna and dated August, 2020.

High-grade outlier assays were capped at different gold grades, according to the domains. The capping values applied to each domain, and the number of composites capped, are summarized in Table 14.2 and Table 14.3.

**Table 14.2**  
**Applied Grade Capping on 3 m Composites for the San Francisco Resource Model (by Rock Type)**

Rock	Lithology Codes	Au g/t Capping	# Capped Composites	Max Au g/t Value
Diorite	2	3.00	10	5.063
Gneiss	4	10.00	47	62.179
Granite	5	10.00	32	86.600
Schist	6	8.00	11	16.547
Lamprophyre	8	2.00	18	8.2515
Pegmatite	10	NA	NA	NA
Gabbro	11	9.00	46	42.0554
Conglomerate	12	1.00	20	18.747

Table provided by Magna.

**Table 14.3**  
**Applied Grade Capping on 3 m Composites for the San Francisco Resource Model (by Resource Area)**

Domain	Codes	Au g/t Capping	# Capped Composites	Max Au g/t Value
North Pit	100	4.00	2	6.058
Chicharra Pit	200	4.00	3	23.518
Chicharra Pit	300	5.50	8	28.595
NW Pit	400	5.00	1	6.038
West Area	500	2.50	6	6.668

Table provided by Magna.

### 14.5.2 Compositing

The assay database was composited to 3-m regular down-hole lengths, which is half the block height of 6 m. Assays were length-weighted for each composite. The relatively short composite length was chosen to unsmooth the resultant block grade distribution and provide a better match between the interpolated block grades and the underlying assay data.

### 14.5.3 Block Model

The block model is based on regular 5 m by 5 m by 6 m blocks and covers an area of 2,560 m by 2,100 m in plan, and 456 m vertically. Table 14.4 gives the model coordinate limits and dimensions. Figure 14.3 is a 3-D view of the topography and interpreted mineral constraints at the San Francisco and La Chicharra deposits. For the La Chicharra deposit, two temporary block models were prepared for pit optimization purposes. These models are located within the extent of the main La Chicharra block model limits.

**Table 14.4**  
**3-D Block Model Limits and Dimensions**

Area	Coordinates	Minimum	Maximum	Block Size	Number
San Francisco Pit	Easting	487500	490060	5 m	512 columns
	Northing	3356500	3358600	5 m	420 rows
	Elevation	158	854	6 m	116 levels
	No Rotation				
La Chicharra Pit	Easting	485000	487500	5 m	500 columns
	Northing	3357500	3359000	5 m	300 rows
	Elevation	302	812	6 m	85 levels
	No Rotation				

Table provided by Magna.

**Figure 14.3**  
**3-D View of the Topography and Interpreted Mineralized Constraints at the San Francisco and La Chicharra Deposits**

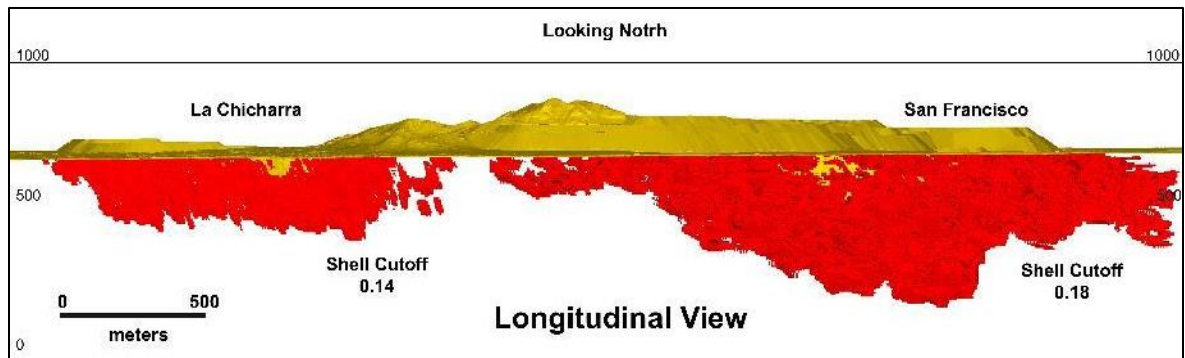


Figure provided by Magna.



#### 14.5.4 Mineralized Outlines

For the current resource estimate, the mineralized grade shells were constrained using 3-D solids interpreted by geologists, based on the mineralized intercepts intersected by the drill holes. Micon considers this approach to be superior because it allows for appropriate interpretive geological control within the model.

#### 14.5.5 Block Model Rock Domains

Magna has continued to use the rock domain interpretation developed for previous resource estimates. As much more data are available for the current estimate, the geological domains were interpreted in more detail by a senior geologist in the field. Table 14.5 summarizes the rock domains, with the corresponding codes and specific gravities.

**Table 14.5**  
**Rock Domain Code and Specific Gravity**

Rock Name	Rock Code	Specific Gravity
Diorite	2	2.72
Gneiss, Felsic	4	2.75
Granite	5	2.76
Schist	6	2.75
Gneiss, Mafic	7	2.75
Lamprophrite dike	8	2.76
Pegmatite	10	2.85
Gabbro	11	2.81
Conglomerate	12	2.0

Table provided by Magna Gold Corp.

Bench polygons for each rock type were derived from this interpretation and imported into the block model. Blocks were coded based on 12 m bench polygons, projecting 6 m above and 6 m below the bench, in accordance with the principal rock type present in each block.

Composites were assigned the rock type of the block in which they were located. This was necessary since a portion of the drilling, particularly much of the Geomaque drilling, does not have a logged rock type.

#### 14.5.6 Specific Gravity

A total of 68 specific gravity determinations were made, covering all rock domains. Results range from a high of 2.84 to a low of 2.61, with an arithmetic mean of 2.76. The specific gravity for each rock type, as used in the resource estimate, is summarized in Table 14.5.

## 14.5.7 Grade Interpolation

All blocks in the model were interpolated using the Ordinary Kriging method. The parameters were derived from the variographic analysis and applied to the different domains and zones accordingly.

The applied search parameters used for the grade interpolation for the San Francisco and La Chicharra pits are summarized in Table 14.6 and Table 14.7, respectively.

**Table 14.6**  
**Applied Search Parameters for Ordinary Kriging Grade Interpolation for the San Francisco Pit**

Rock Code(s)	Pass	Az (°)	Plunge (°)	Dip (°)	Variogram Parameters		Searching Parameters					
					Nugget	Sill	Range Major Axis (m)	Range Minor Axis (m)	Range Vertical Axis (m)	Min. Samples	Max. Samples	Max Samples per Hole
2	1	120	0	-55	0.3	0.65	50	50	7.5	6	12	2
4	1	40	0	0	0.3	0.7	30	30	9	6	12	2
5	1	110	0	-35	0.2	0.8	40	40	8.5	6	12	2
6	1	110	0	-45	0.22	0.78	45	45	7	6	12	2
8	1	135	0	-40	0.143	0.87	60	40	10	6	12	2
11	1	100	0	-20	0.3	0.74	50	50	7	6	12	2
12	1	55	0	0	0.015	0.727	30	24	7.8	6	12	2
2	2	120	0	-55	0.3	0.65	100	100	15	6	18	2
4	2	40	0	0	0.3	0.7	60	60	18	6	18	2
5	2	110	0	-35	0.2	0.8	80	80	17	6	18	2
6	2	110	0	-45	0.22	0.78	90	90	14	6	18	2
8	2	135	0	-40	0.143	0.87	120	80	20	6	18	2
11	2	100	0	-20	0.3	0.74	100	100	14	6	18	2
12	2	55	0	0	0.015	0.727	60	48	15.6	6	18	2
2	3	120	0	-55	0.3	0.65	200	200	30	2	10	2
4	3	40	0	0	0.3	0.7	120	120	36	2	10	2
5	3	110	0	-35	0.2	0.8	160	160	34	2	10	2
6	3	110	0	-45	0.22	0.78	180	180	28	2	10	2
8	3	135	0	-40	0.143	0.87	240	160	40	2	10	2
11	3	100	0	-20	0.3	0.74	200	200	28	2	10	2
12	3	55	0	0	0.015	0.727	120	96	31.2	2	10	2

**Table 14.7**  
**Applied Search Parameters for Ordinary Kriging Grade Interpolation for the La Chicharra Pit**

Rock Code(s)	Pass	Az (°)	Plunge (°)	Dip (°)	Variogram Parameters		Searching Parameters					
					Nugget	Sill	Range Major Axis (m)	Range Minor Axis (m)	Range Vertical Axis (m)	Min. Samples	Max. Samples	Max Samples per Hole
100	1	150	0	-45	0.1	0.97	25	19	4	5	10	2
200	1	140	0	-55	0.08	1.256	25	25	8	5	10	2
300	1	130	0	-25	0.125	0.895	45	45	10	5	10	2
400	1	100	0	-30	0.05	0.95	30	30	4	5	10	2
500	1	140	0	-30	0.055	1.39	60	60	6	5	10	2
100	2	150	0	-45	0.1	0.97	50	38	4	5	10	2
200	2	140	0	-55	0.08	1.256	37.5	33	10	5	10	2
300	2	130	0	-25	0.125	0.895	65	60	13	5	10	2
400	2	100	0	-30	0.05	0.95	45	45	6	5	10	2
500	2	140	0	-30	0.055	1.39	90	90	8	5	10	2
100	3	150	0	-45	0.1	0.97	75	57	6	3	8	2

Rock Code(s)	Pass	Az (°)	Plunge (°)	Dip (°)	Variogram Parameters		Searching Parameters					
					Nugget	Sill	Range Major Axis (m)	Range Minor Axis (m)	Range Vertical Axis (m)	Min. Samples	Max. Samples	Max Samples per Hole
200	3	140	0	-55	0.08	1.256	50	41	13	2	7	2
300	3	130	0	-25	0.125	0.895	90	75	16	2	7	2
400	3	100	0	-30	0.05	0.95	60	60	8	3	8	2
500	3	140	0	-30	0.055	1.39	120	120	10	2	7	2

For the current resource update in the San Francisco deposit, the interpolation process was relaxed to allow multiple domains to inform blocks on each interpolation run, because the remaining resources are predominantly gabbro (Rock Code 11).

#### 14.5.8 Mineral Resource Classification

Mineralized zones in the San Francisco and La Chicharra deposits have been classified as a mineral resource according to the CIM definitions. The mineralized zones display good geologic continuity, as demonstrated by the drill results.

The categorization criteria applied to the resource estimate are as follows:

- Blocks within 20 m of a sample are considered measured, based upon a pass finding 3 drill holes with a maximum of 2 samples per hole.
- Blocks between 20 m and 40 m from a sample are considered indicated, based upon a pass finding 2 drill holes with a maximum of 2 samples per hole.
- Any blocks further than 40 m from a sample are considered inferred.

#### 14.5.9 Block Model Validation

The block model was validated using three methods:

1. Statically – The gold grades of the 3-m composites grouped by domain were compared against the grades of the interpolated blocks. That comparison summarized in Table 14.8, indicates reasonable agreement.

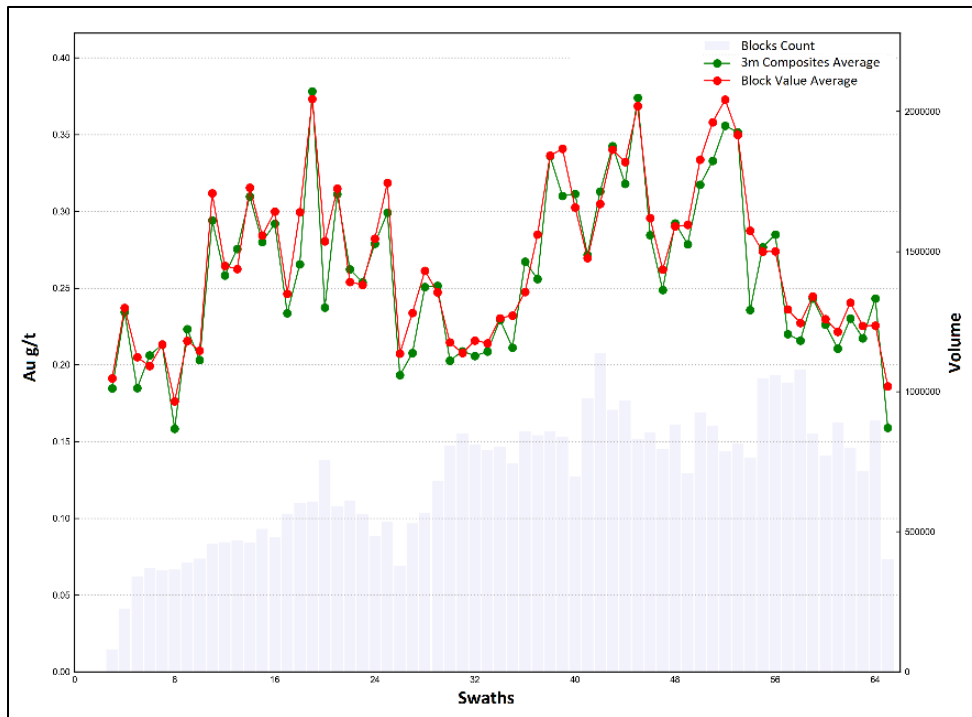
**Table 14.8**  
**San Francisco and La Chicharra 3 m Composites vs. Block Model Averages**

Zone/Domain	San Francisco Model			
	Composites		Blocks	
	Count	Au g/t	Count	Au g/t
2	793	0.24	32,486	0.23
4	19,373	0.31	599,865	0.31
5	4,964	0.43	117,874	0.42
8	175	0.25	7,967	0.20
11	12,369	0.29	740,485	0.26
12	1,025	0.17	66,465	0.16
<b>Global</b>	<b>38,699</b>	<b>0.32</b>	<b>1,565,142</b>	<b>0.29</b>

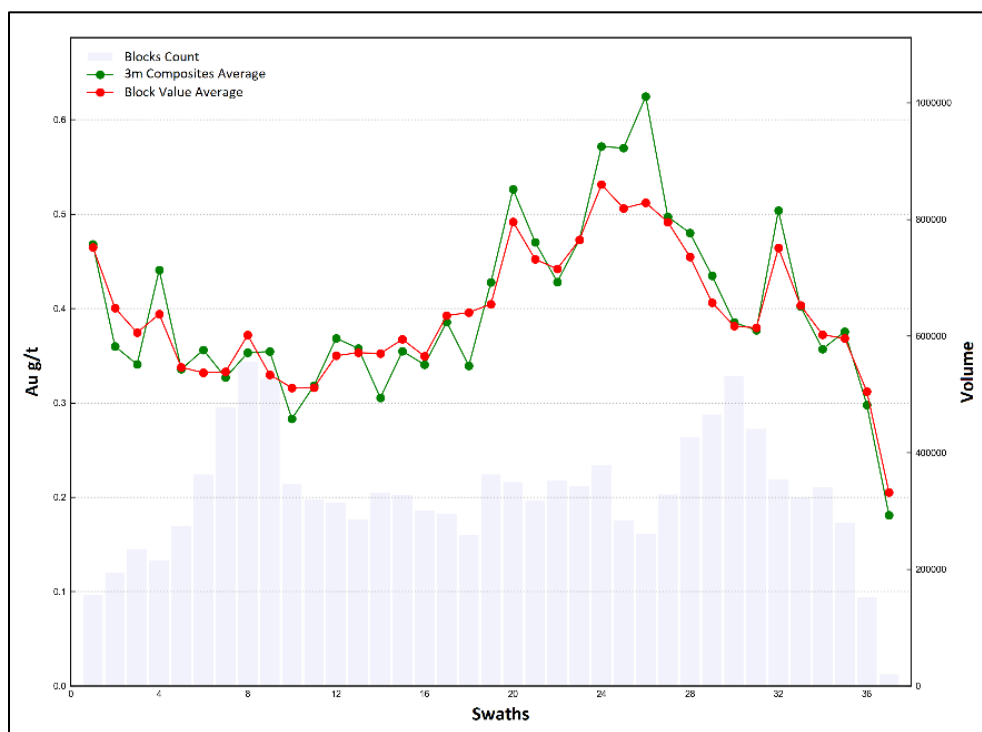
La Chicharra Model				
Zone/Domain	Composites		Blocks	
	Count	Au g/t	Count	Au g/t
100	414	0.46	12,984	0.41
200	1,043	0.38	39,398	0.36
300	4,869	0.47	108,770	0.44
400	2,524	0.35	80,404	0.36
500	205	0.43	9,581	0.35
<b>Global</b>	<b>9,055</b>	<b>0.43</b>	<b>251,137</b>	<b>0.40</b>

2. Trend Analysis – The interpolated block grades and the average grades of the 3-m composites were compared in swath plots at 50-m intervals in the east-west direction. The results, shown in Figures 14.4 and 14.5, show reasonable agreement.

**Figure 14.4**  
**San Francisco Block Model Swath Plot**



**Figure 14.5**  
**La Chicharra Block Model Swath Plot**



3. Visually – Using Leapfrog Geo, Micon visually examined vertical sections, comparing the drill hole trace samples against the block model grade distribution, to ensure that the original sample grades and the block grades agree and that they are reasonably related in space.

All three validation procedures gave satisfactory results, sufficient to conclude that the block model can be used with confidence for the estimation of resources and reserves.

#### **14.5.10 Resource Pit Optimization and Economic Parameters**

Once Micon had audited and accepted the Magna block models, Magna proceeded to run a pit optimization program in order to estimate the resources. The gold price used for estimating resources was USD 1,500 per ounce. This procedure was used to satisfy the criterion that resources must have reasonable prospects of eventual economic extraction.

The parameters used in the pit optimization are summarized in Table 14.8. They are the parameters determined by Micon and Magna, taking into account the actual costs obtained from the operation.

Pit bench heights were set at 6 m (the block height used in the model) and slope angles were based on inter-ramp angles recommended by Golder Associates in its December, 1996, report, adjusted to allow for haul roads of 25 m width.

**Table 14.8**  
**Pit Optimization Parameters for the August 8, 2020 Resource Estimate for the San Francisco and La Chicharra deposits**

Area	Costs			
	Description	Units	Amount	
San Francisco Model	Waste mining cost OP	USD/t	2.20	
	Ore mining cost OP	USD/t	2.20	
	Process cost	USD/t	4.15	
	G & A cost	USD/t	0.41	
	Gold price	USD/oz	1,500	
	<b>Rock Densities and Recoveries</b>			
		<b>Name/code</b>	<b>Density</b>	<b>Recovery %</b>
		Diorite (2)	2.72	54.50
		Gneiss (4)	2.75	71.10
		Granite (5)	2.76	76.00
		Schist (6)	2.75	74.40
		Lamprophite Dike (8)	2.76	54.50
		Pegmatite (10)	2.85	74.40
		Gabbro (11)	2.81	63.80
		Conglomerate (12)	2.00	64.50
	General Recovery		64.00	
La Chicharra Model	<b>Costs</b>			
		<b>Description</b>	<b>Units</b>	<b>Amount</b>
		Waste mining cost	USD/t	1.79
		Ore mining cost	USD/t	1.79
		Process cost	USD/t	4.15
		G & A cost	USD/t	0.41
		Gold price	USD/oz	1,500
		<b>Rock Densities and Recoveries</b>		
		<b>Name/code</b>	<b>Density</b>	<b>Recovery %</b>
		All Rock (100-500)	2.9	78.00
	General Recovery		78.00	

Table provided by Magna Gold Corp.

As can be seen from Table 14.8, not only do the various rock codes have a different density, but the metallurgical recovery varies with the rock code as well. Currently the San Francisco mine plan will be predominantly processing the gabbro (11) and gneiss (4).

Previous drilling programs have outlined a number of lenses of higher-grade mineralization beneath the south-wall of the San Francisco pit. Alio investigated these lenses and developed a drift on one of them in 2015-2016 with the objective of mining this material using underground cut and fill methods. Alio later shelved the idea of conducting underground mining in favour of conducting a pit pushback in this area. Magna has revived the underground scenario for mining the higher grade lenses. The parameters used for estimating the underground resources in the southern wall of the San Francisco pit are summarized in Table 14.9.

**Table 14.9**  
**Underground Parameters for the August 8, 2020 Resource Estimate for the San Francisco UG Lenses**

Area	Costs		
	Description	Units	Amount
San Francisco Underground Model	Waste mining cost UG	USD/t	36.50
	Ore mining cost UG	USD/t	36.50
	Process cost (crushing and leach)	USD/t	4.00
	G & A cost	USD/t	0.50
	Contingency	USD/t	2.00
	Gold price	USD/oz	1,500
	Rock Densities and Recoveries		
	Name/code	Density	Recovery %
	All Rock	2.90	64.00
	General Recovery		64.00

Table provided by Magna Gold Corp.

#### 14.5.10.1 Mineral Resource Statement

The pit shell adopted for constraining resources was estimated at a gold price of USD 1,500/oz Au, using the economic parameters summarized in Table 14.8, the drilling database as of 2018 and the topographic surface as June 1, 2020. The mineral resource, as estimated by Magna and audited by Micon, has been presented previously in Table 14.1. This resource estimate includes the mineral reserve described subsequently, and has an effective date of August 8, 2020.

Micon recommends that Magna use the August 8, 2020 mineral resource estimate contained in Table 14.1 as the stated mineral resource estimate for the San Francisco Project (San Francisco and La Chicharra deposits), as this estimate recognizes the use of 0.14 g/t gold and 0.12 g/t gold, respectively, as the open pit cut-off grades, at which the mineralization would meet the criterion of potential economic extraction.

## 15.0 MINERAL RESERVE ESTIMATES

### 15.1 INTRODUCTION

Having established a simple ultimate pit shell from the resource pit optimization analysis, Magna designed an open pit, with haul roads 25 m wide, and prepared a production schedule for the extraction of the measured and indicated mineral resources contained within the pit.

The reserve estimate completed by Magna as of August 8, 2020 and audited by Micon, is compliant with the current CIM standards and definitions specified by NI 43-101, and supersedes all previous reserve estimates for the San Francisco mine. In addition, Magna has carried out a reserve estimate for its second deposit, La Chicharra, which has also been audited by Micon and is presented in this report.

While the vast majority of the ore in the San Francisco pit will be mined by open pit methods, a small high-grade area is planned to be mined by underground cut and fill during the second half of 2020. The development required for the underground mining was being undertaken during the writing of this report.

### 15.2 CIM MINERAL RESERVE DEFINITIONS AND CLASSIFICATIONS

The latest edition of the CIM definitions and standards was adopted by the CIM council on May 10, 2014, and includes the definition of modifying factors that allow resources to become reserves. The reserve definitions are reproduced below.

#### **Modifying Factors**

*“Modifying Factors are considerations used to convert Mineral Resources to Mineral Reserves. These include, but are not restricted to, mining, processing, metallurgical, infrastructure, economic, marketing, legal, environmental, social and governmental factors.”*

#### **Mineral Reserve**

*“Mineral Reserves are sub-divided in order of increasing confidence into Probable Mineral Reserves and Proven Mineral Reserves. A Probable Mineral Reserve has a lower level of confidence than a Proven Mineral Reserve.”*

*“A Mineral Reserve is the economically mineable part of a Measured and/or Indicated Mineral Resource. It includes diluting materials and allowances for losses, which may occur when the material is mined or extracted and is defined by studies at Pre-Feasibility or Feasibility level as appropriate that include application of Modifying Factors. Such studies demonstrate that, at the time of reporting, extraction could reasonably be justified.”*

*“The reference point at which Mineral Reserves are defined, usually the point where the ore is delivered to the processing plant, must be stated. It is important that, in all situations where the reference point is different, such as for a saleable product, a clarifying statement is included to ensure that the reader is fully informed as to what is being reported.”*



*“The public disclosure of a Mineral Reserve must be demonstrated by a Pre-Feasibility Study or Feasibility Study.”*

**“Probable Mineral Reserve”**

*“A Probable Mineral Reserve is the economically mineable part of an Indicated, and in some circumstances, a Measured Mineral Resource. The confidence in the Modifying Factors applying to a Probable Mineral Reserve is lower than that applying to a Proven Mineral Reserve.”*

*“The Qualified Person(s) may elect, to convert Measured Mineral Resources to Probable Mineral Reserves if the confidence in the Modifying Factors is lower than that applied to a Proven Mineral Reserve. Probable Mineral Reserve estimates must be demonstrated to be economic, at the time of reporting, by at least a Pre-Feasibility Study.”*

**“Proven Mineral Reserve”**

*“A Proven Mineral Reserve is the economically mineable part of a Measured Mineral Resource. A Proven Mineral Reserve implies a high degree of confidence in the Modifying Factors.”*

*“Application of the Proven Mineral Reserve category implies that the Qualified Person has the highest degree of confidence in the estimate with the consequent expectation in the minds of the readers of the report. The term should be restricted to that part of the deposit where production planning is taking place and for which any variation in the estimate would not significantly affect the potential economic viability of the deposit. Proven Mineral Reserve estimates must be demonstrated to be economic, at the time of reporting, by at least a Pre-Feasibility Study. Within the CIM Definition standards the term Proved Mineral Reserve is an equivalent term to a Proven Mineral Reserve.”*

**15.3 MINERAL RESERVE ANALYSIS**

**15.3.1 Reserve Pit Optimization and Economic Analysis**

Once Micon had audited and accepted the resource estimates, Magna proceeded to run a pit optimization program in order to estimate the reserves. The gold price used for estimating the reserves at the San Francisco mine was USD 1,350 per ounce.

The parameters used in the pit optimization for the estimation of reserves are the same as those described previously in connection with the estimation of resources.

**15.4 MINING RECOVERY AND DILUTION**

Mining recovery has been estimated at 98% for both the San Francisco and La Chicharra deposits. Micon agrees with this estimate, as it is based on actual experience at the mine.

The average dilution for the San Francisco pit is 6.3% and is accounted for outside the block model. The La Chicharra deposit uses a dilution factor within the model and is estimated to vary between 4.0% and 6.0 %.

## 15.5 AUGUST 8, 2020 MINERAL RESERVE ESTIMATE STATEMENT

Table 15.1 presents the reserves estimated within the pit design outline, including mine recovery and dilution factors.

**Table 15.1**  
Mineral Reserves within the San Francisco and La Chicharra Pit Design (August 8, 2020) after Mining Recovery and Dilution

Mining Method	Area	Classification	K tonnes	Gold (g/t)	Contained Gold (K oz)
Surface	San Francisco	Proven	15,063	0.492	238,
		Probable	22,783	0.496	364
		<b>Total</b>	<b>37,846</b>	<b>0.494</b>	<b>602</b>
Underground		Proven	91	4.186	12
		Probable	20	3.657	2
		<b>Total</b>	<b>111</b>	<b>4.089</b>	<b>15</b>
Surface	La Chicharra	Proven	5,904	0.503	96
		Probable	2,986	0.419	40
		<b>Total</b>	<b>8,890</b>	<b>0.475</b>	<b>136</b>
All	Total Mining	Proven	21,058	0.511	346
		Probable	25,789	0.490	406
		<b>Total</b>	<b>46,847</b>	<b>0.499</b>	<b>752</b>
	San Francisco Mine	Low-grade Stockpile	782	0.256	6
<b>Total Surface + Underground + Stockpile</b>			<b>47,629</b>	<b>0.495</b>	<b>758</b>

The proven and probable reserves in Table 15.1 have been derived from the measured and indicated mineral resources summarized in Table 14.1 and account for mining recovery and dilution. The figures in Table 15.1 have been rounded to reflect that they are estimates.

The mineral reserve estimate has been reviewed and audited by Micon. It is Micon's opinion that the August 8, 2020, mineral reserve estimate has been prepared in accordance with the CIM standards and definitions for mineral reserve estimates and that Magna can use this estimate as a basis for further mine planning and operational optimization at the Project.

## 15.6 RECONCILIATION

Since production mining has only restarted, no current production reconciliation has been performed.

The most recent reconciliation of the model to the mine production was conducted in March, 2017. The reconciliation focused on improving the geological model, as well as auditing the production records from the mine and leach pads. The overall percent difference between the resource model and the material sent to the leach pads was 3% which, in Micon's opinion, is a very good reconciliation result.

Going forward, Micon recommends that annual reserve reviews should be maintained.

## 16.0 MINING METHODS

Mining at the San Francisco and La Chicharra Pits is conducted by a contractor, using open pit mining methods. At the San Francisco Pit, a small underground mine will be exploited during the second half of 2020 in order to accelerate cash flow by targeting some higher-grade mineralization in the block model.

### 16.1 MINING PRODUCTION TO DATE

The San Francisco mine most recently resumed commercial production in June, 2020.

Alio drew material from the stockpiles intermittently from 2014. Routine processing of the stockpile material began at the end of 2018, when production from the open pits ceased, and continued through to December, 2019. At the beginning of 2020, operations were solely focused on recovery of the residual inventory ounces from the heap leach piles.

In June, 2020, Magna began to reprocess the low-grade stockpile, as well as begin re-starting mining from the La Chicharra and San Francisco pits.

Historical production from the San Francisco Project is summarized in Table 6.2 (1996 to 2002) and Tables 6.3 and 6.4 (2010 to 2019), within Section 6.3 of this Technical Report. Table 16.1 summarizes production from January, 2019 to the end of July, 2020, by quarter. Table 16.2 summarizes the material shipped from the stockpile to the heap leach pads by Alio and Magna from January, 2019 to the end of July, 2020, by quarter.

### 16.2 OPEN PIT MINE DESIGN

#### 16.2.1 Geotechnical Studies and Slope Design Criteria

The previous owners of the property, Geomaque de Mexico, retained Golder Associates (Golder) to conduct a geotechnical study on the San Francisco pit in December, 1996. Golder's scope of work was to carry out site investigations, testing and analysis to develop slope angle recommendations for the pit design.

The recommended overall slope angles ranged from 37° for single 6 m benches along the northeast facing slopes, to a maximum of 56° for double-benching in schist units. Golder presented a table of recommended inter-ramp slope angles and catch bench widths to achieve the recommended overall slope angles.

The pit designs for the San Francisco and La Chicharra pits were reviewed by Micon's QP, and pit wall angles measured to compare with the recommended maximum angles. The pit wall angles were found not to exceed recommended inter-ramp angles, nor overall pit wall angles.

**Table 16.1**  
**San Francisco Project, Annual Production from January, 2019 to the End of July, 2020\* (by Quarter)**

Year	Quarter	Total Ore Extracted (dry tonnes)	Avg Grade Extracted (g/t Gold)	Total Gold Extracted (oz Au)	ROM extracted (dry tonnes)	Average Grade ROM Extracted (g/t Gold)	Waste Mined (dry tonnes)	Strip Ratio (w:o)	Processed Ore (dry tonnes)	Avg Processed Grade (g/t Gold)	Gold Placed on Leach Pad (oz Au)	Gold Sold (oz Au)	Days in Quarter	Average Ore Mined (tonnes/day)	Average Ore Processed (tonnes/day)	Total Mined (tonnes/day)
2019	January - March	0	0.000	0	0	0.000	0	0.00	1,619,443	0.274	14,290	10,876	90	0	17,994	0
	April - June	0	0.000	0	0	0.000	0	0.00	1,744,165	0.274	15,349	10,204	91	0	19,167	0
	July - September	0	0.000	0	0	0.000	0	0.00	1,607,925	0.248	12,809	8,167	92	0	17,477	0
	October - December	0	0.000	0	0	0.000	0	0.00	1,183,727	0.228	8,665	7,097	92	0	12,867	0
2020	January - March	0	0.000	0	0	0.000	0	0.00	0	0.000	0	5,225	91	0	0	0
	April - June	80,080	0.438	1,128	0	0.000	270,286	3.38	106,160	0.387	1,320	6,881	91	880	1,167	3,850
	July - September	183,435	0.352	2,078	0	0.000	1,197,060	6.53	320,080	0.281	2,897	1,989	31	5,917	10,325	44,532
	October - December															
<b>Total</b>		<b>263,515</b>	<b>0.378</b>	<b>3,205</b>	<b>0</b>	<b>0.000</b>	<b>1,467,345</b>	<b>5.57</b>	<b>6,581,500</b>	<b>0.261</b>	<b>55,330</b>	<b>50,439</b>	<b>578</b>	<b>2,160</b>	<b>18,573</b>	<b>14,187</b>

Table supplied by Magna in August, 2020.

**NOTES:**

- Magna restarted production by processing ore from the low-grade stockpile and restarting mining at the La Chicharra pit.
- Alio's management team decided to process ROM ore by the end of 2017. The record of this ore is not reflected in the above table. Approximately 1.8 Mt were processed in this manner.
- From Q4, 2018 till Q4, 2019, the low-grade ore stockpiled was processed and placed on pads.
- Total Ore Extracted columns take into account the low-grade ore sent to stockpile.
- Total Processed Ore columns include the low-grade ore rehandled and processed. These figures do not reflect the ROM ore extracted and placed over pads.

**Table 16.2**  
**San Francisco Project, Annual Ore Stockpiled and Processed from January, 2019 to the End of July, 2020\* (by Quarter)**

Year	Quarter	Low-Grade Stockpile (Dry Tonnes)	Average Grade (g/t Gold)	Gold Oz Stockpiled	Low-Grade Processed (Dry tonnes)	Average Grade (g/t Gold)	Ounces LG Processed (oz Au)
2019	January - March	0	0.000	0	1,619,443	0.218	11,335
	April - June	0	0.000	0	1,744,165	0.217	12,157
	July - September	0	0.000	0	1,607,925	0.214	11,040
	October - December	0	0.000	0	1,183,727	0.212	8,073
2020	January - March	0	0.000	0	0	0.000	0
	April - June	0	0.000	0	26,080	0.230	193
	July - September	0	0.000	0	127,010	0.230	939
	October - December						
	<b>TOTAL</b>	<b>0</b>	<b>0.000</b>	<b>0</b>	<b>6,308,350</b>	<b>0.216</b>	<b>43,738</b>

Table supplied by Magna in August, 2020.

Examples of the slope wall angles on the north and south walls of the San Francisco Pit are illustrated in Figure 16.1. Examples of the slope wall angles on the south and southeast walls of the La Chicharra Pit are illustrated in Figure 16.2.

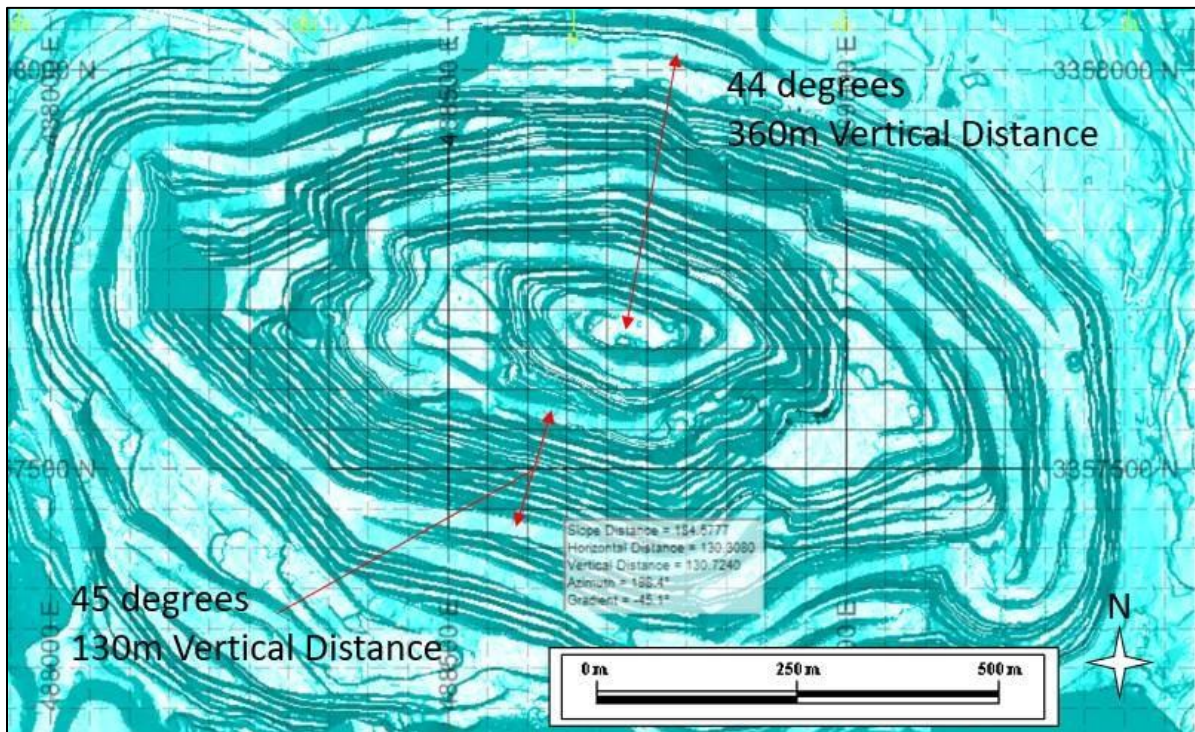
In July, 2012, Alio received the results of a new geotechnical analysis of the pit that it had commissioned from Call & Nicholas, Inc. (CNI).

The purpose of the study conducted by CNI was:

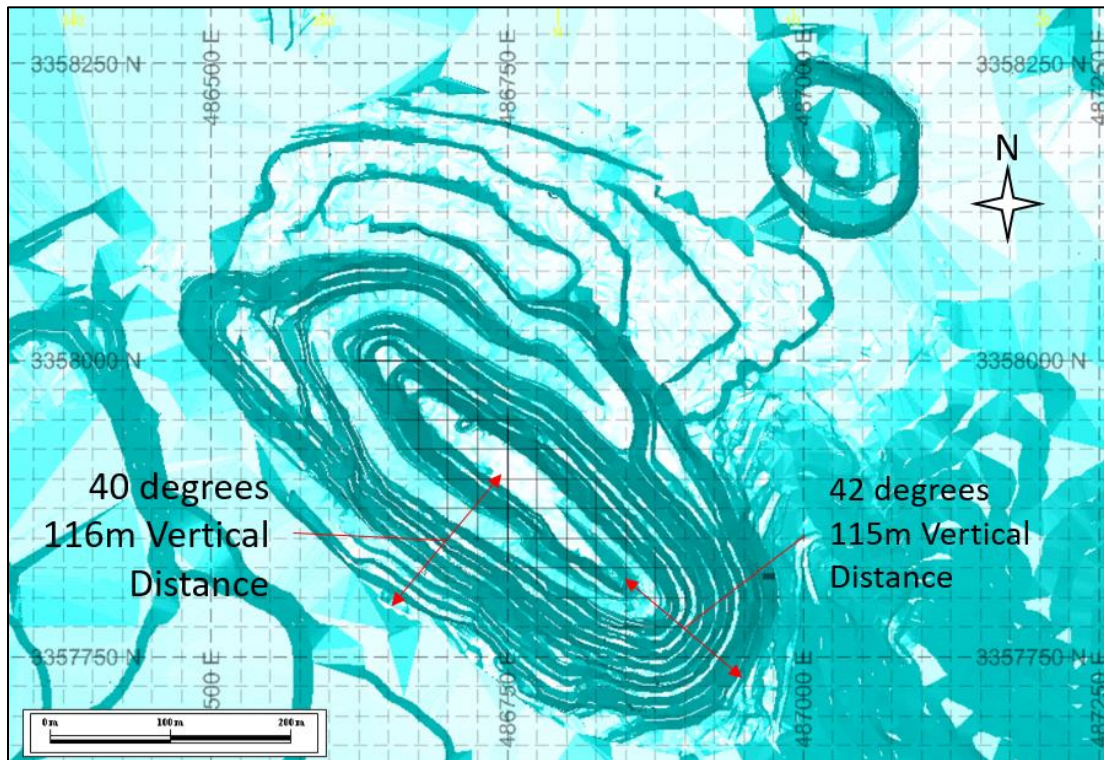
1. To determine optimum inter-ramp slope angles and bench design parameters for the final San Francisco pit design.
2. To identify and analyze any potential major instability that would represent a significant cost or interference to the mine operations.
3. To provide recommendations for slope management over the life of the mine.

Stability analyses included bench scale Backbreak analysis, from which the expected distribution of bench face angles and reliability schedules were developed. The Backbreak analysis relied on a cell-mapping program conducted along existing pit benches. Average and minimum bench face angles for individual cells were recorded concurrently with the mapping. The bench face angle database confirmed the pit wall geometries that are currently being achieved at San Francisco. Discrete faults with lengths in excess of 40 m were analyzed to determine their potential for forming viable failure geometries along final pit walls.

**Figure 16.1**  
**Pit Wall Angle Measurements: San Francisco Pit**



**Figure 16.2**  
**Pit Wall Angle Measurements: La Chicharra Pit**



The inter-ramp slope angles were determined for static seismic conditions. The impact of an earthquake on rock slope stability is considered minimal. The reported slope angles are also based on depressurized pit slopes.

Micon's QP has reviewed Magna's pit designs and notes that they continue to respect CNI's recommendations.

#### 16.2.1.1 Impact of Groundwater on Slope Stability

CNI's recommended slope angles assume adequately drained (depressurized) slopes. The Backbreak analysis assumed depressurized conditions on mine benches, and inter-ramp stability analyses were performed for both saturated and depressurized conditions.

Preliminary observations suggest that the final pit walls may be relatively free-draining, precluding the development of any excessive pore pressure buildup. It appears that draining will occur mostly through major faults and the more fractured ground surrounding these faults. This assumption should be confirmed once data are available from the piezometer monitoring and from the water seepage record for the pit wall, as the pit deepens.

Micon and its QP recommend that a horizontal drainage hole program is used to ensure there is minimal water pressure behind the pit walls.

### 16.2.2 2016 Southwall Stability

In December, 2016, the south wall at the San Francisco pit was affected by a transversal failure which could potentially compromise the mining operations in the area.

In March, 2017, Alio started a monitoring program with the assistance of Ground Pro, in order to determinate, in real time, what is occurring in the area of the failure and the extent of the deformation occurring after blast events and rainfall, to identify and determine the extent of the potential risk to the mining operations within the San Francisco pit.

As of the date of this report, monitoring shows no further movement in the area of the December, 2016 transversal failure.

### 16.2.3 Hydrological Considerations

During its earlier 2017 site inspection, Micon observed that the existing pit walls were generally dry, with a few minor seepages along shear zones.

At the end of 2010, a hydrogeological study was conducted by Investigación y Desarrollo de Acuíferos y Ambiente (IDEAS) around the pit, to evaluate the hydrological regime in this area. A number of piezometers were installed to monitor the water flow surrounding the pit (Figure 16.3).

As of August, 2020 there was no report of water infiltration at either the San Francisco or the La Chicharra open pits.

**Figure 16.3**  
**Piezometer (PFP-01A) Installed to Monitor Water Flow Surrounding the Pit**



Photograph taken during the August, 2013 Micon Site Visit.

#### **16.2.4 Phased Pit Designs**

Before Magna recommenced mining within the San Francisco and La Chicharra pits, pit designs were revised to comprise four mining phases designed by Magna. Magna's four mining phases are designated as six, seven, eight and nine, with subphases identified as 6b, 6c, 7a, 7b,8, 9a and 9b.

The Magna designs were used for re-starting operations, in order to achieve a favourable distribution of waste tonnage during the mine life and enhance the availability of heap leach feed.

The reserves for the La Chicharra pit have also now been incorporated into the formal mine plan. Drilling has delineated additional resources and a pit design has been developed based on the USD 1,350/oz gold optimized pit shell.

Figure 16.4 to Figure 16.12 illustrate the evolution of the San Francisco and La Chicharra pits on a year-by-year basis from 2020 to 2028, as per the combined LOM production schedule. Figure 16.13 and Figure 16.14 show the final pit designs for the San Francisco and La Chicharra pits. Figure 16.15 to Figure 16.17 show the current San Francisco pit, as well as the planned growth profile through to 2023. Figure 16.18 to Figure 16.20 show the same growth profile for the La Chicharra pit.

#### **16.2.5 Waste Rock Management**

Existing waste rock dumps are located to the south of the San Francisco open pit, close to the pit rim and cannot be extended to the north. They are also limited to the east by a property boundary and to the west by the natural hills. Accordingly, the existing dumps will be extended further south, where adequate space does exist.

Previously, with the expansion of the reserves, additional waste dump volume was required and a site located northwest of the San Francisco pit was identified that would contain the majority of waste rock produced during the mine life.

The quantity of waste to be generated in the current LOM plan is 90.6 Mt for the San Francisco pit and 28.3 t for the LaChicharra pit, for a combined 119 Mt of waste (approximately 44 Mm<sup>3</sup> in situ). Waste generated from the underground operations is expected to remain as backfill in the cut and fill operation.

Considering a swell factor of 50%, this waste will require a storage volume of approximately 66 million cubic metres. This volume is expected to be provided through the current dumps and the expansion of waste dumps areas identified by condemnation drilling prior to 2017.

The La Chicharra waste dumps are located to the south-southwest of the pit and there is currently room to expand these to the west and south.



Figure 16.4  
Plan View of the La Chicharra and San Francisco Pits: End of Year 2020

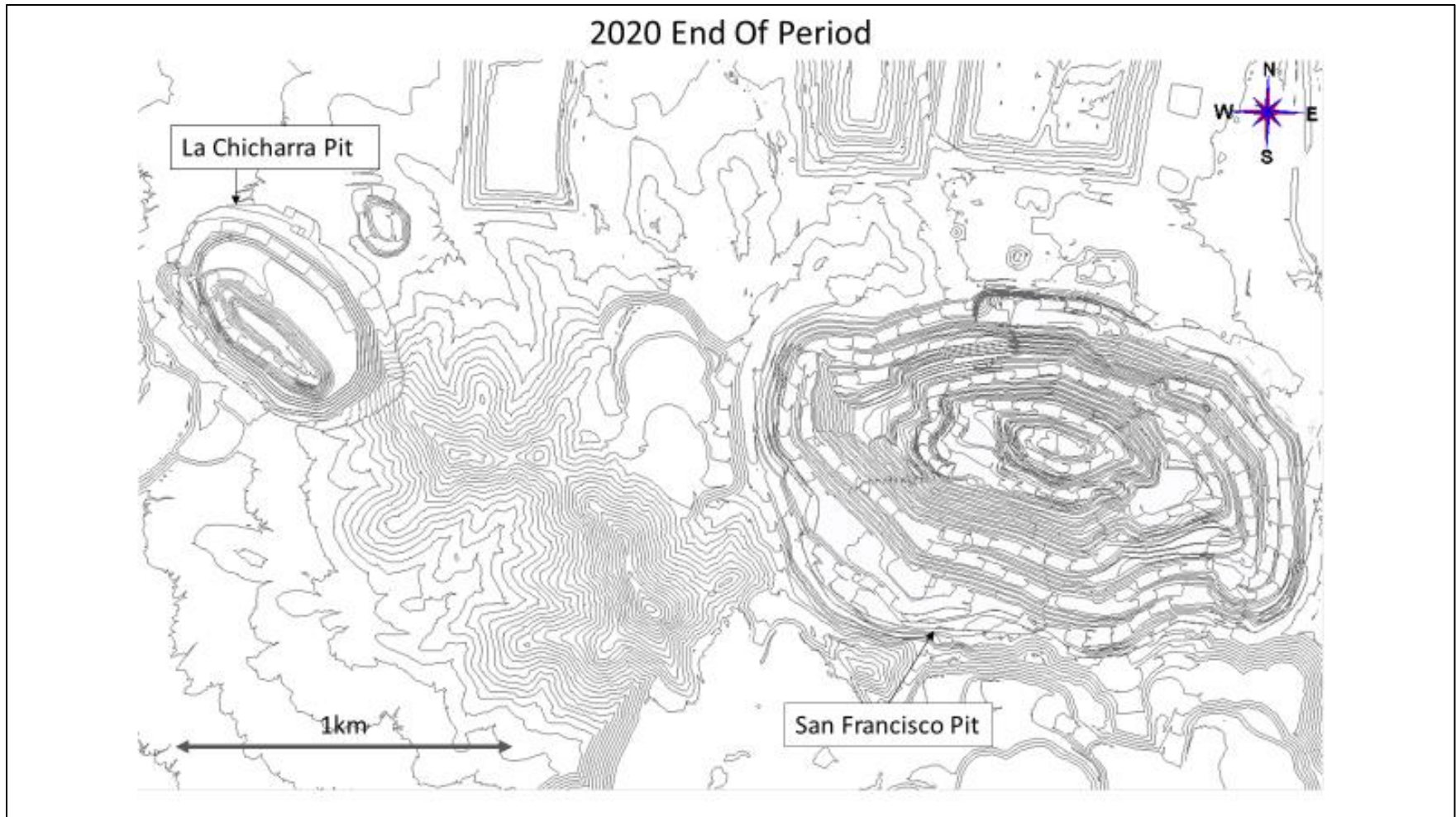


Figure provided by Magna and dated August, 2020.

Figure 16.5  
Plan View of the La Chicharra and San Francisco Pits: End of Year 2021

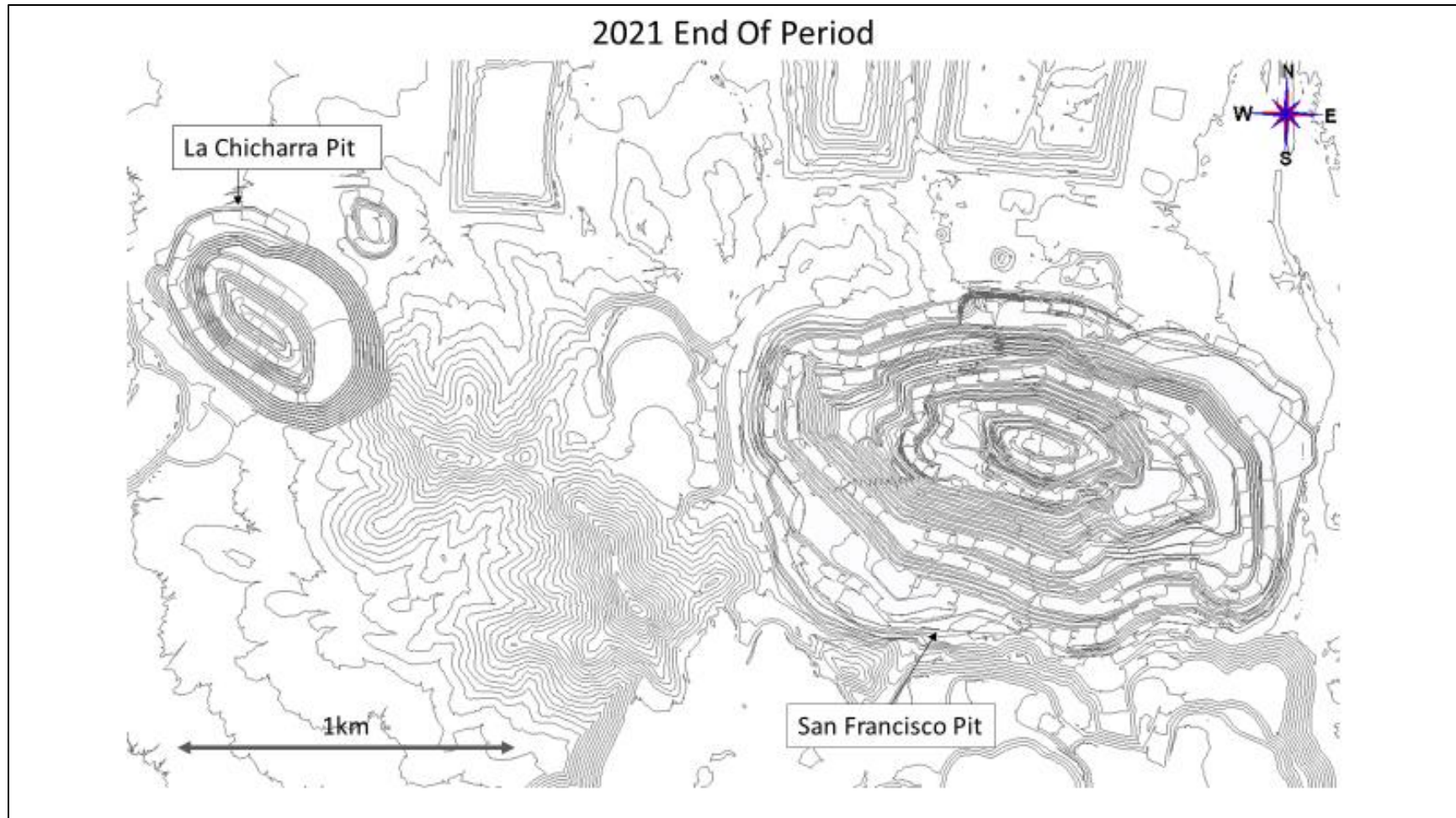


Figure provided by Magna and dated August, 2020.

Figure 16.6  
Plan View of the La Chicharra and San Francisco Pits: End of Year 2022

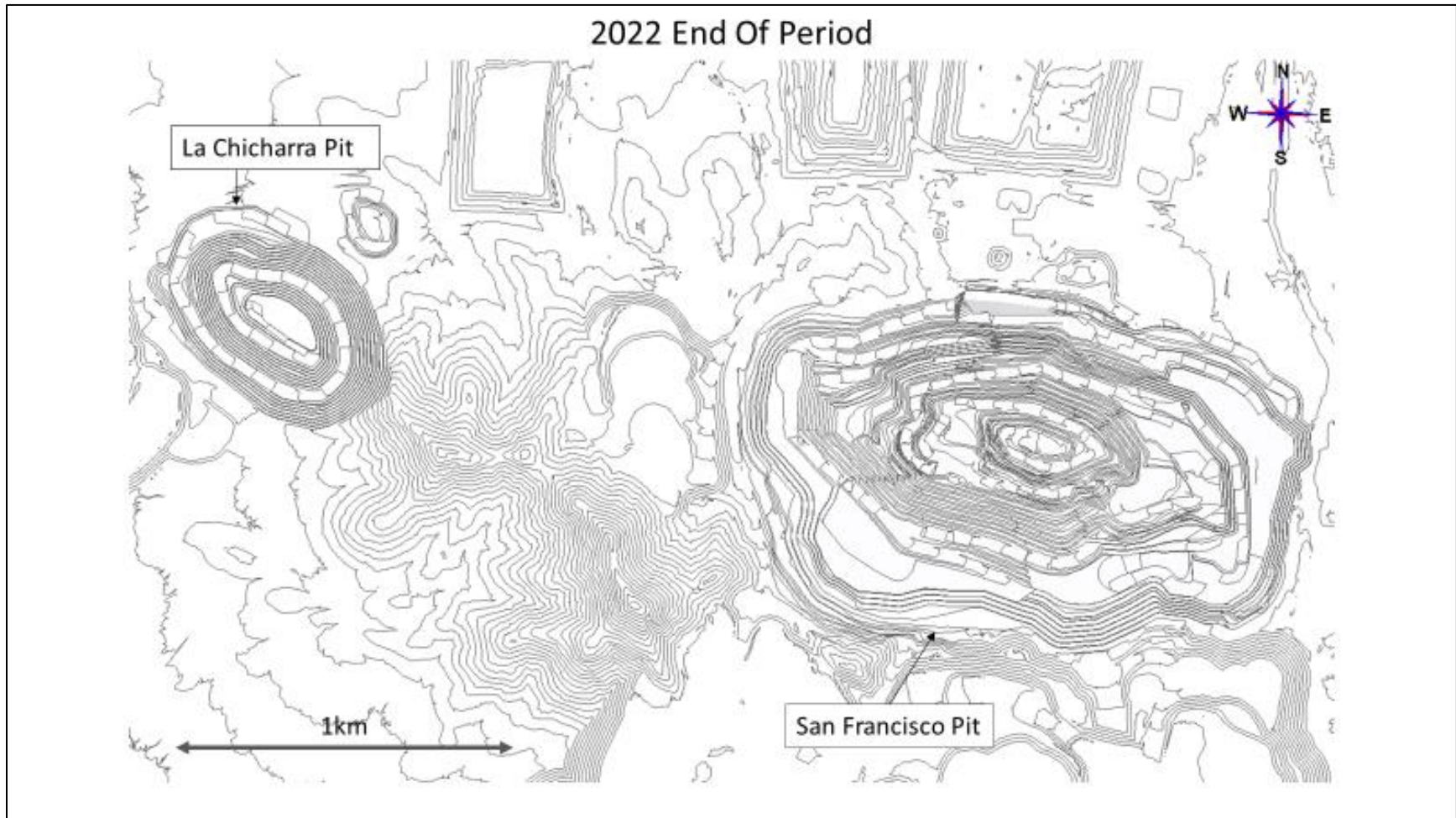
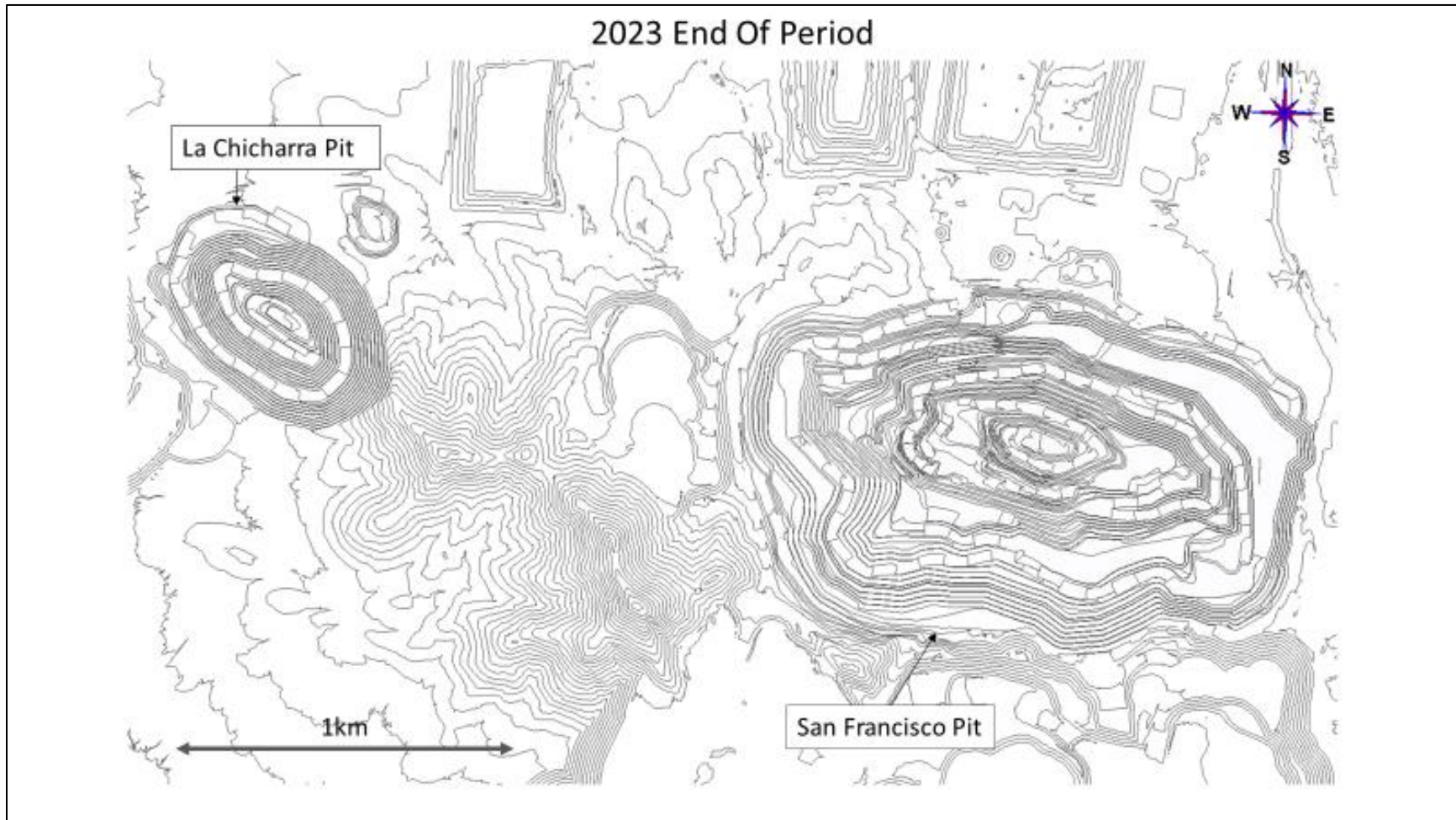


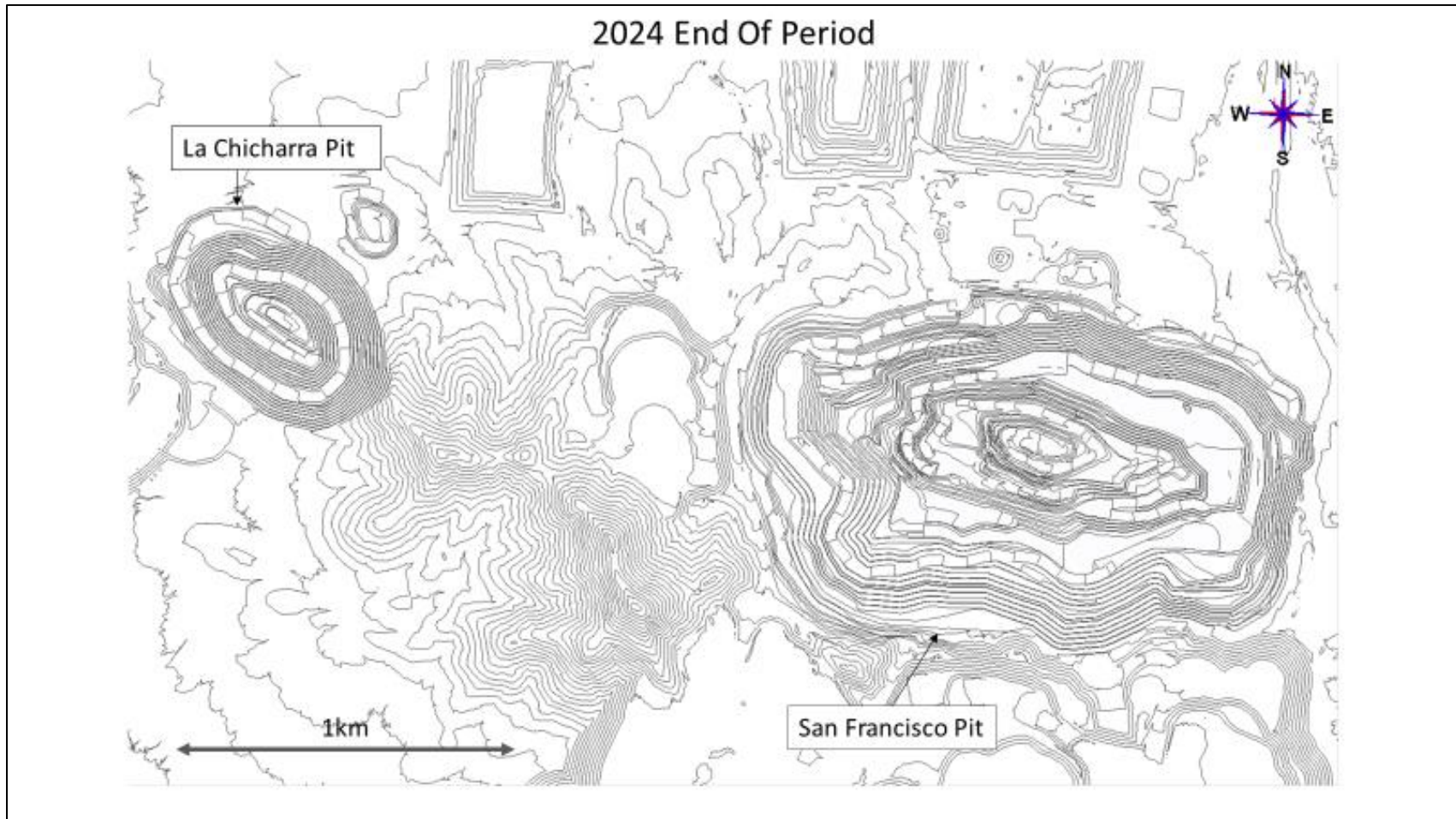
Figure provided by Magna and dated August, 2020.

Figure 16.7  
Plan View of the La Chicharra\* and San Francisco Pits: End of Year 2023



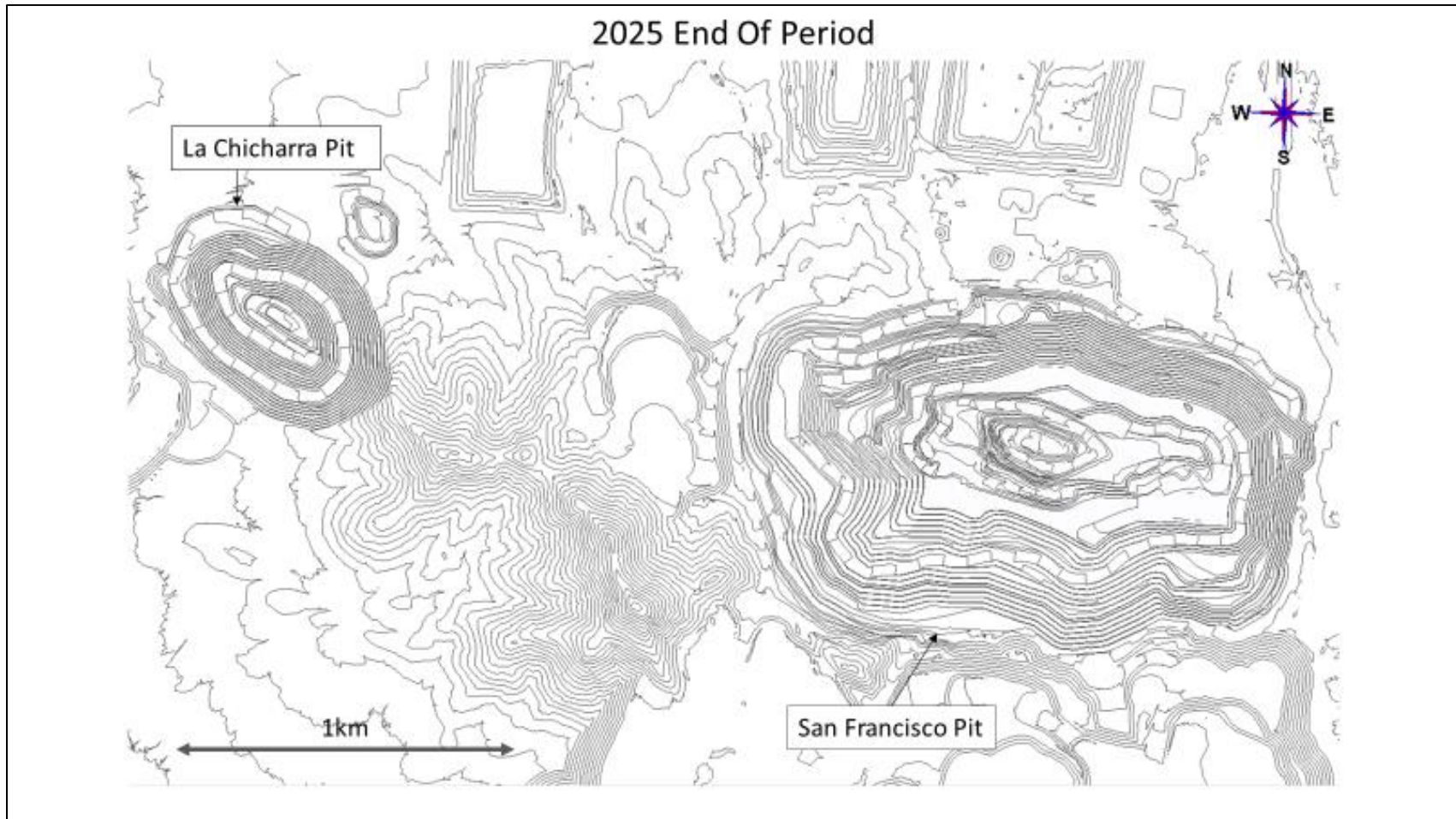
\*La Chicharra Pit is completed by the end of 2023.  
Figure provided by Magna and dated August, 2020.

Figure 16.8  
Plan View of the La Chicharra\* and San Francisco Pits: End of Year 2024



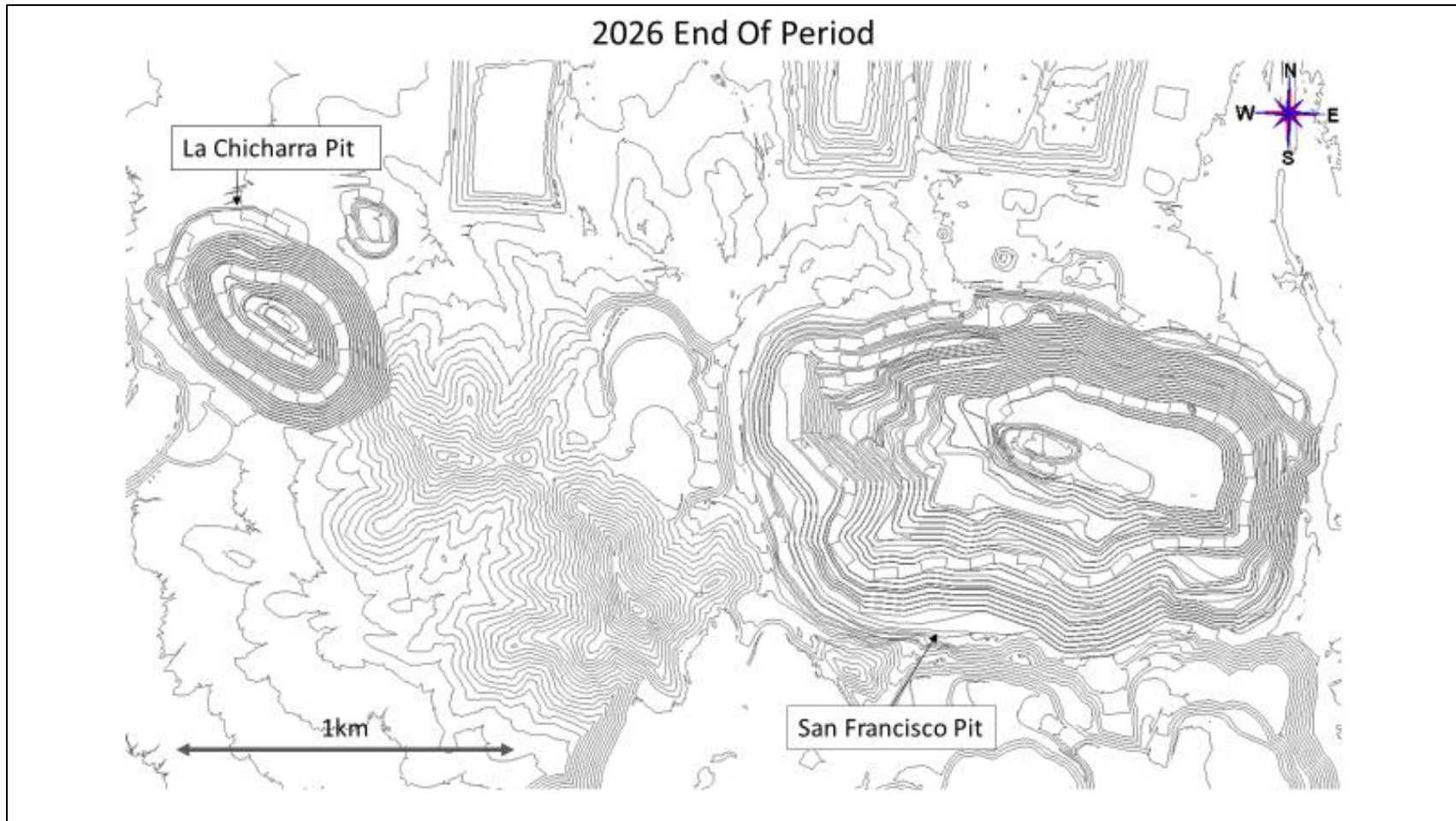
\*La Chicharra Pit is completed by the end of 2023.  
Figure provided by Magna and dated August, 2020.

Figure 16.9  
Plan View of the La Chicharra\* and San Francisco Pits: End of Year 2025



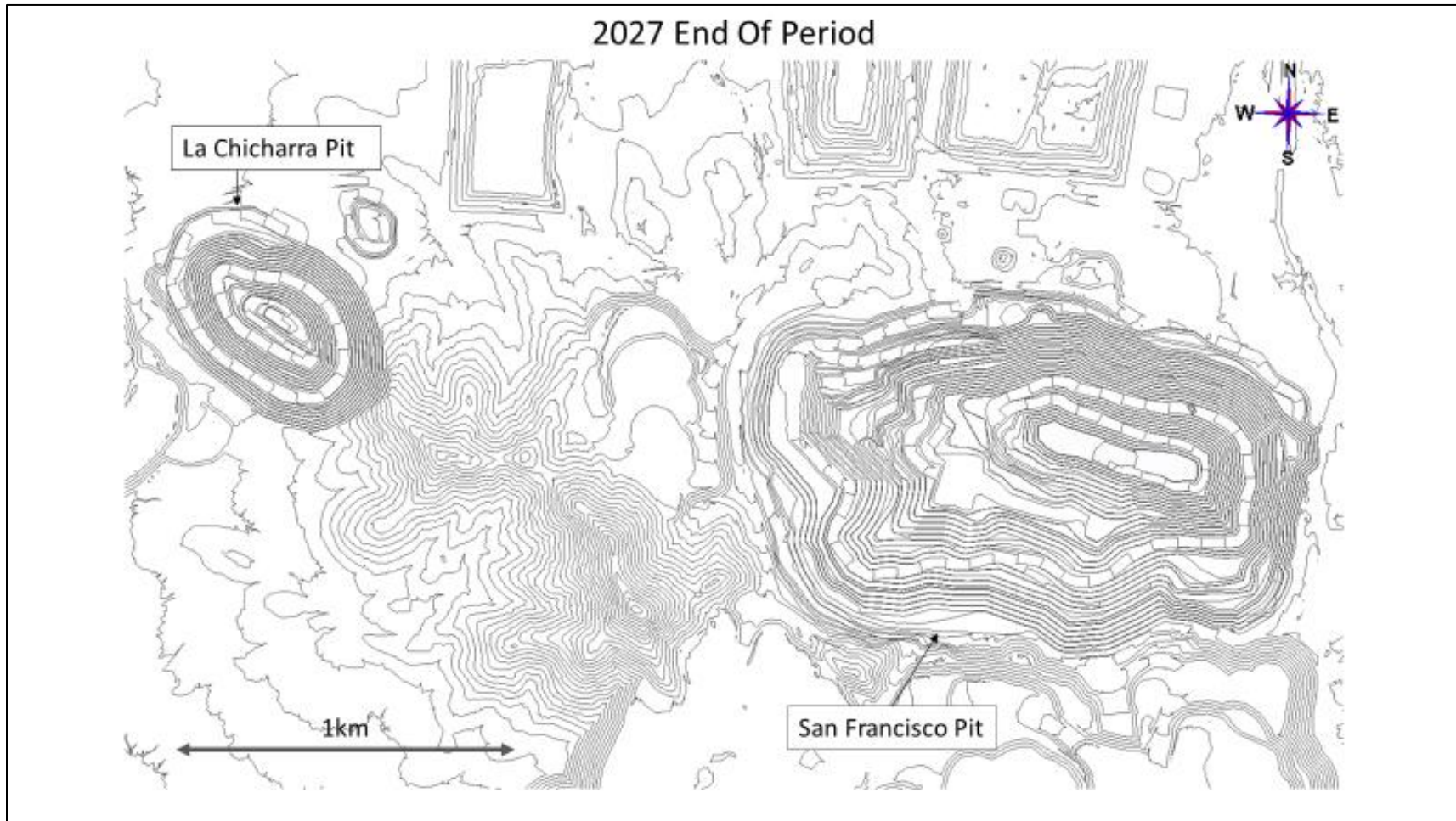
\*La Chicharra Pit is completed by the end of 2023.  
Figure provided by Magna and dated August, 2020.

**Figure 16.10**  
**Plan View of the La Chicharra\* and San Francisco Pits: End of Year 2026**



\*La Chicharra Pit is completed by the end of 2023.  
Figure provided by Magna and dated August, 2020.

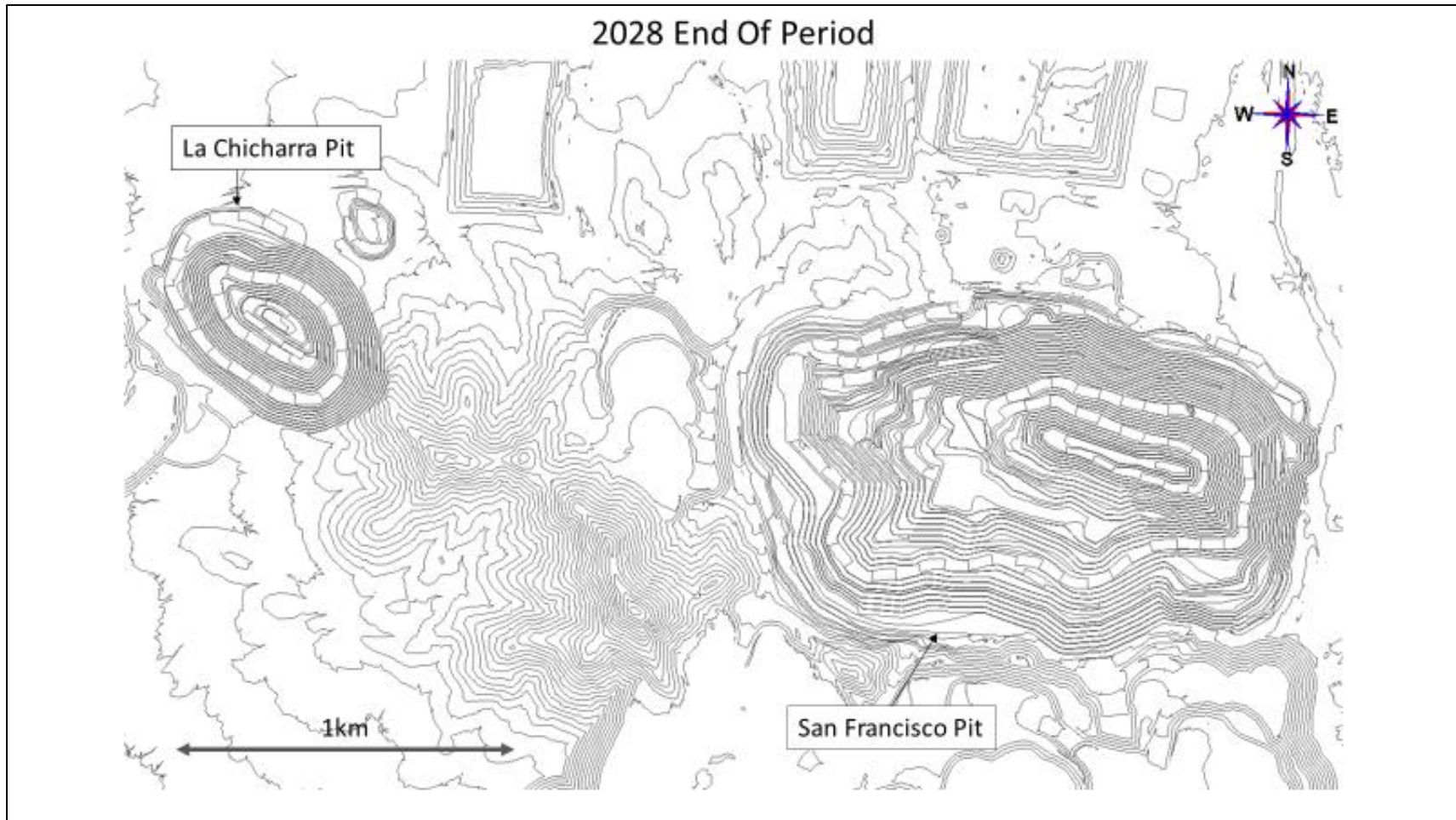
**Figure 16.11**  
**Plan View of the La Chicharra\* and San Francisco Pits: End of Year 2027**



\*La Chicharra Pit is completed by the end of 2023.  
Figure provided by Magna and dated August, 2020.



Figure 16.12  
Plan View of the La Chicharra\* and San Francisco Pits: End of Year 2028



\*La Chicharra Pit is completed by the end of 2023.  
Figure provided by Magna and dated August, 2020.

**Figure 16.13**  
**Final Design for the San Francisco Pit (2028)**

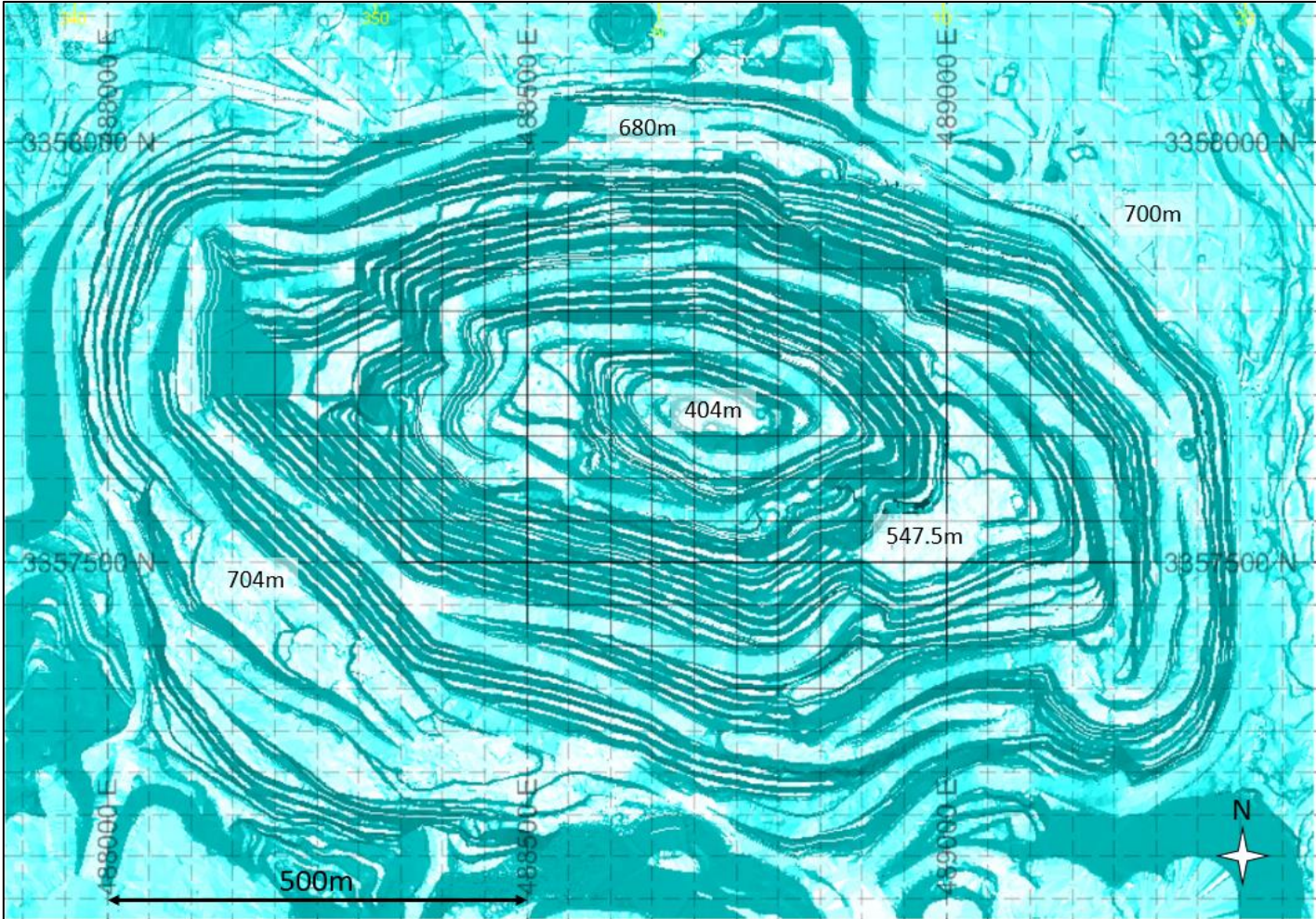


Figure provided by Magna and dated August, 2020.

Figure 16.14  
Final design for the La Chicharra Pit (2023)

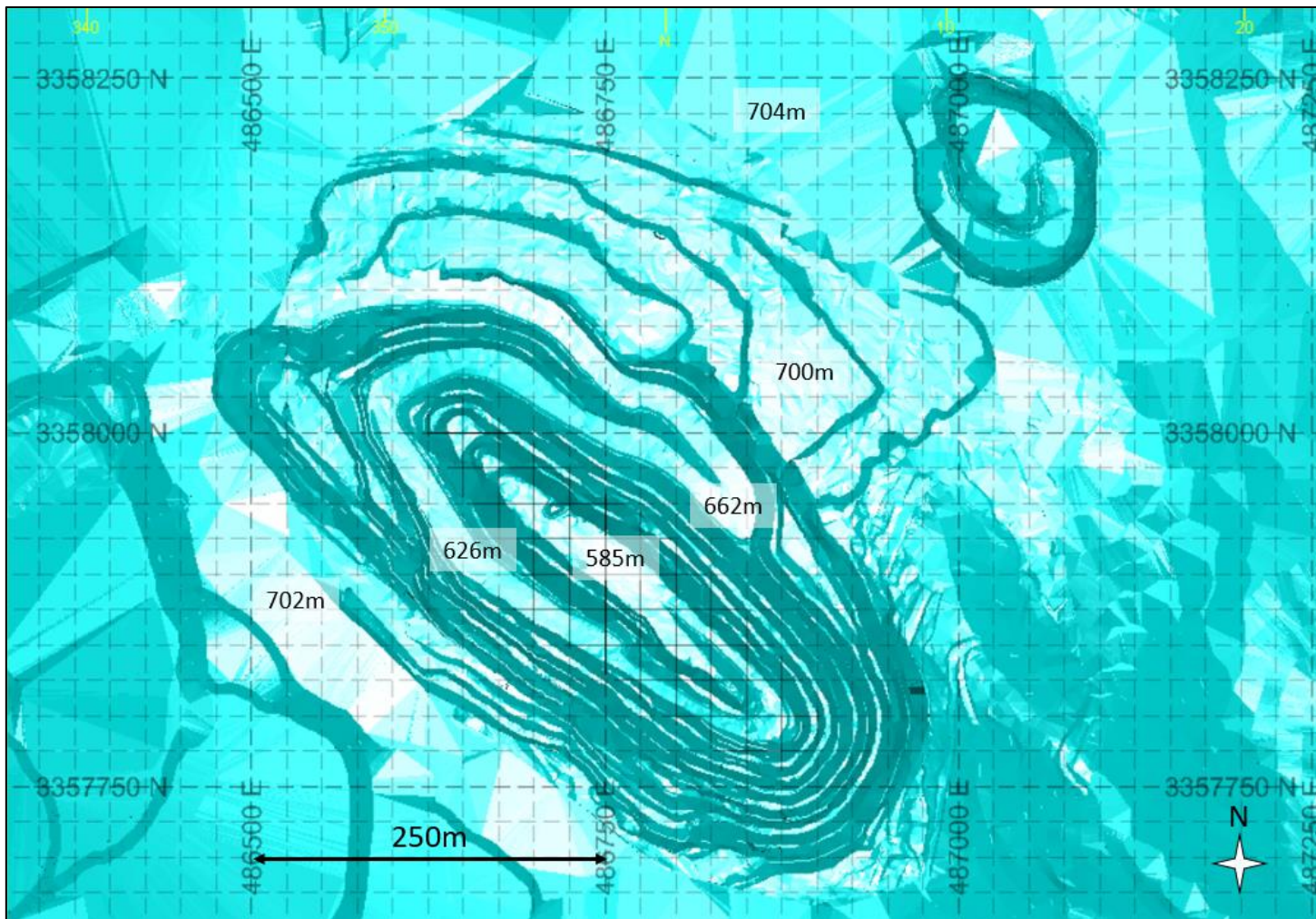


Figure provided by Magna and dated August, 2020.

**Figure 16.15**  
**Plan View of the Current San Francisco Pit Showing the Location of the Longitudinal and Cross-Sections Demonstrating the Growth of the Pit Since 2009 with the Projected Growth to 2028**

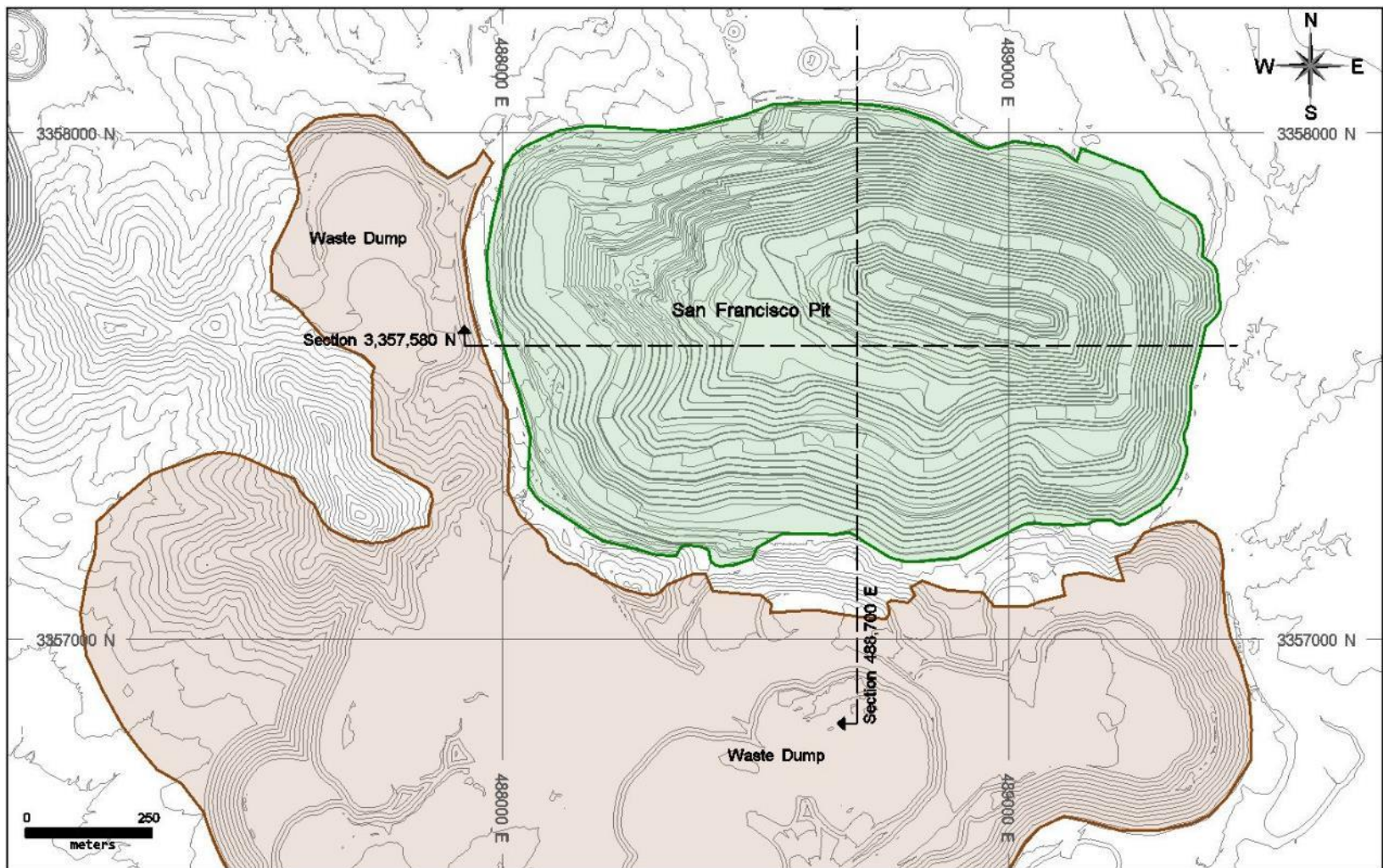


Figure provided by Magna and dated August, 2020.

**Figure 16.16**  
**Longitudinal Section (3357580 North) Demonstrating the Growth of the San Francisco Pit Since 2009 with the Projected Growth to 2028**

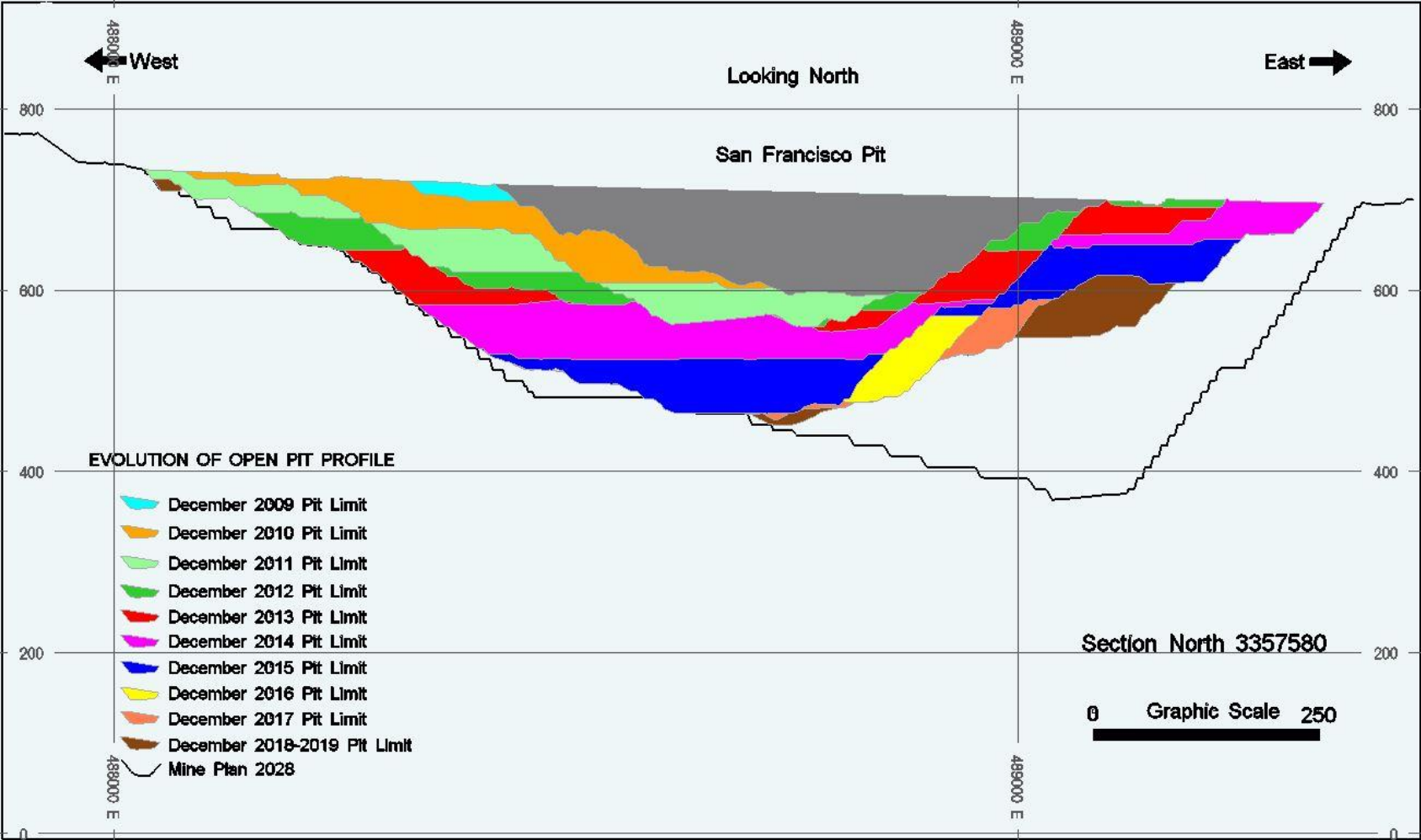


Figure provided by Magna and dated August, 2020.

**Figure 16.17**  
**Cross-Section (488700 East) Demonstrating the Growth of the San Francisco Pit Since 2009 with the Projected Growth to 2028**

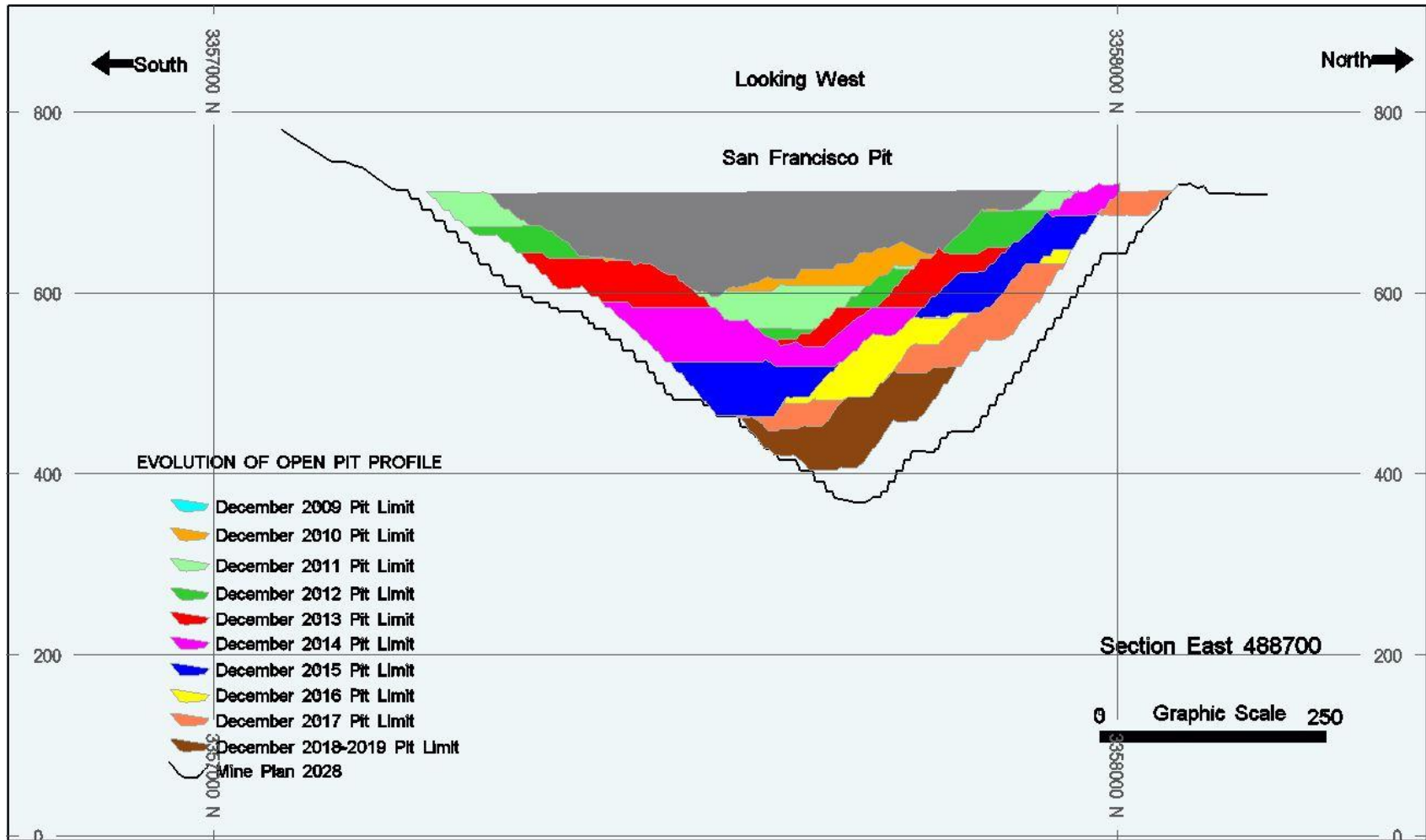


Figure provided by Magna and dated August, 2020.

**Figure 16.18**  
**Plan View of the Current La Chicharra Pit Showing the Location of the Longitudinal and Cross-Sections Demonstrating the Growth of the Pit Since 2009 with the Projected Growth to 2023**

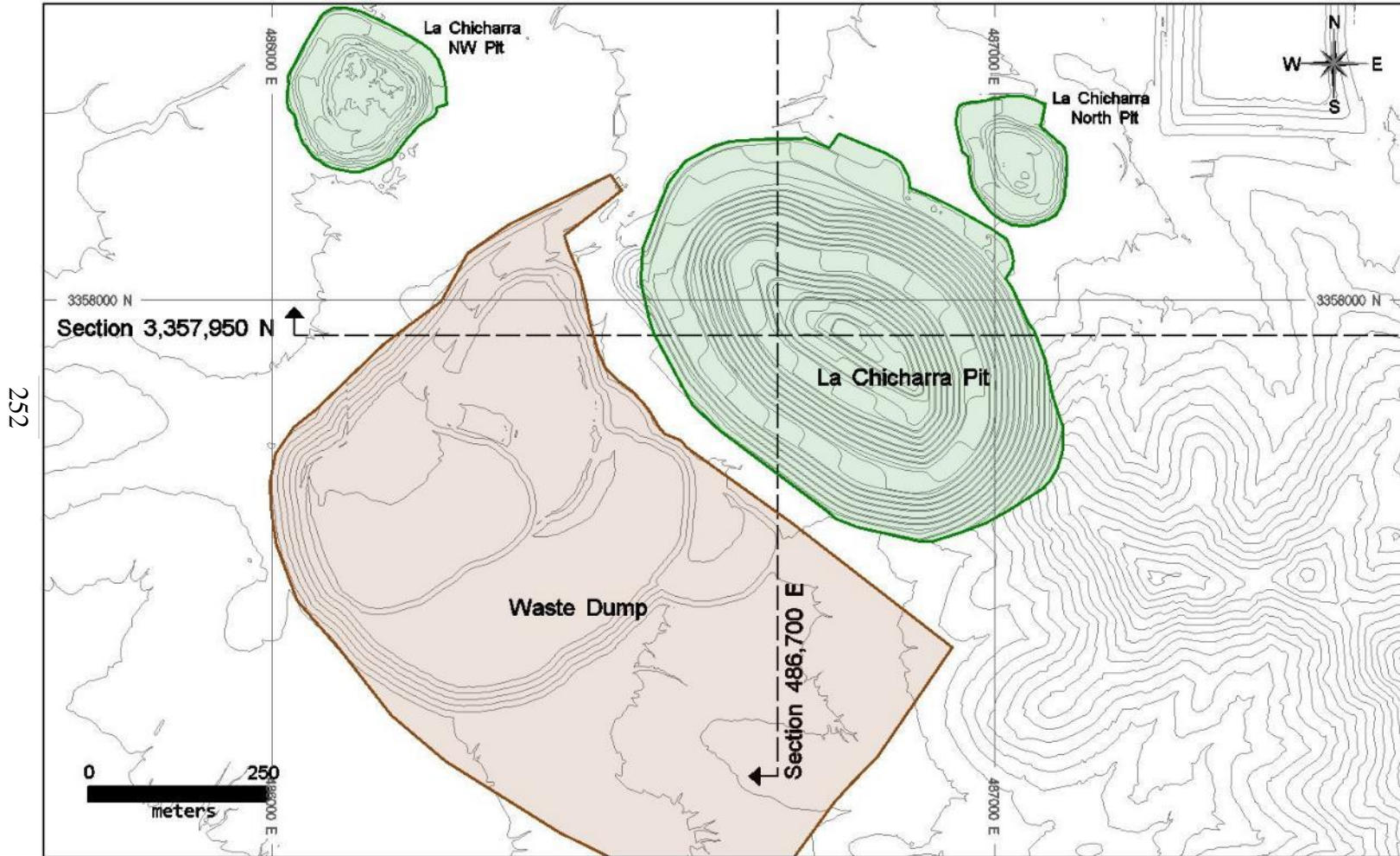


Figure provided by Magna and dated August, 2020.

Figure 16.19  
Longitudinal Section (3,357,950 North) Demonstrating the Growth of the La Chicharra Pit Since 2009 with the Projected Growth to 2023

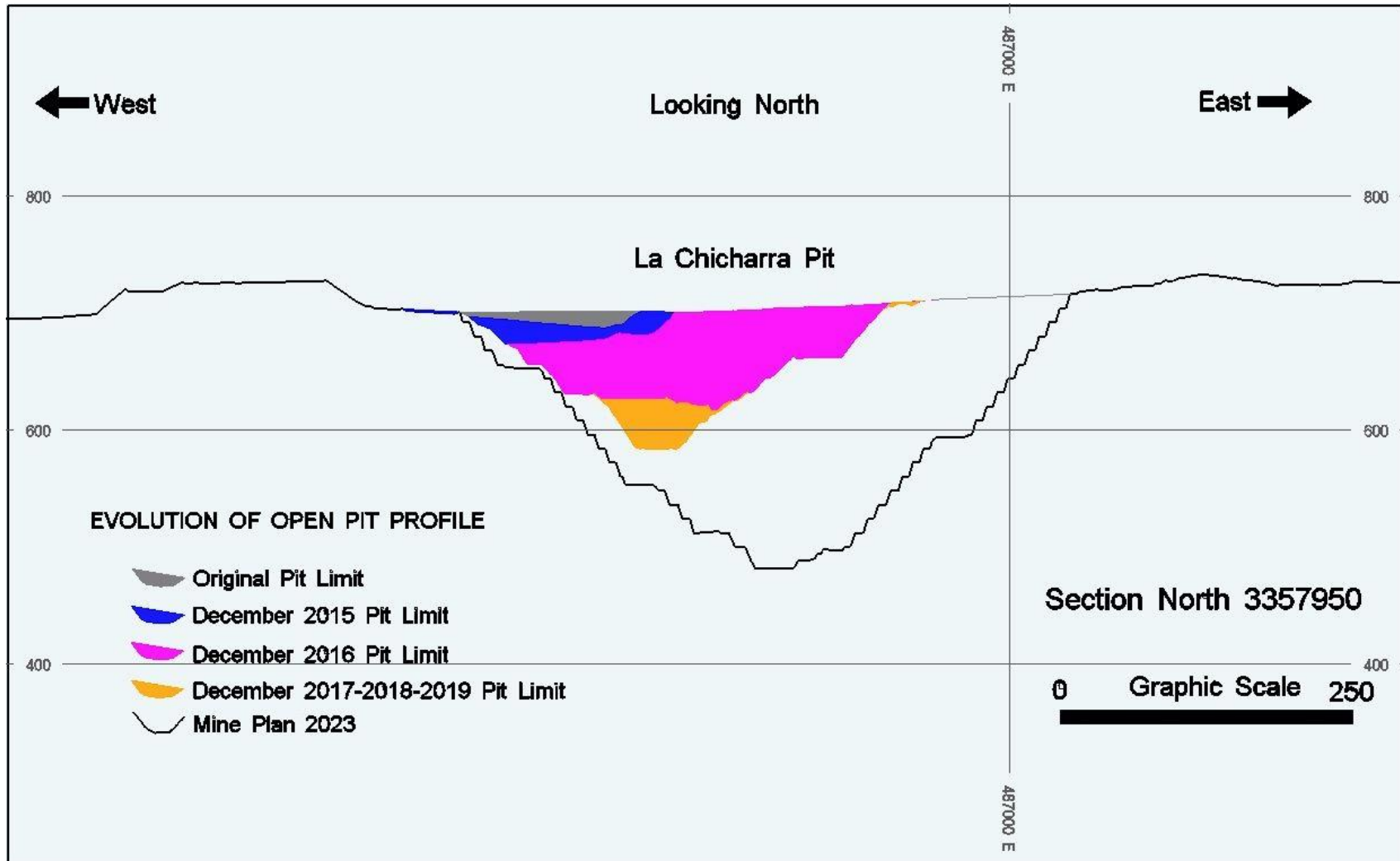


Figure provided by Magna and dated August, 2020.



**Figure 16.20**  
**Cross-Section (488,700 East) Demonstrating the Growth of the La Chicharra Pit Since 2009 with the Projected Growth to 2023**

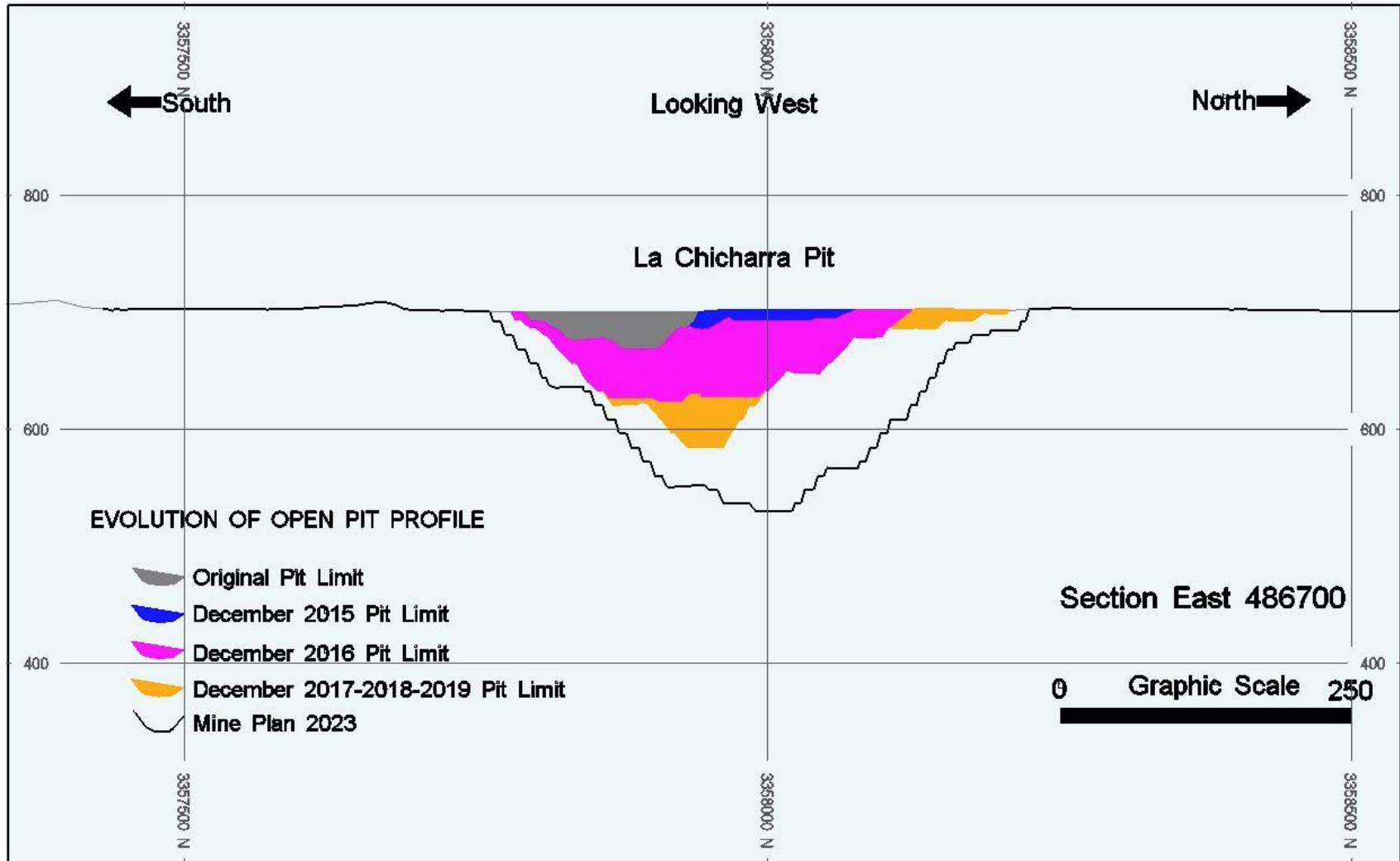


Figure provided by Magna and dated August, 2020.

### 16.3 OPEN PIT MINE OPERATIONS

All mining activities to date have been conducted by the contractor, Peal Mexico, S.A. de C.V., of Navojoa, Mexico. The contractor is obliged to supply and maintain the appropriate principal and auxiliary mining equipment and personnel required to produce the tonnage mandated by Alio, in accordance with the mining plan. Table 16.3 is summary of the contractor’s mining equipment in place when the open pits were in operation.

Alio provided contract supervision, geology, engineering and planning and survey services, using its own employees.

Further discussions related to the mining contract are included in Section 19.0.

**Table 16.3**  
**Contractor’s Mining Equipment List when the Open Pits were in Operation to the End of 2018**

Type	Brand	Model	Active	Repair or Maintenance	Total
Trucks	KOMATSU	HD785-7	2	1	3
	CATERPILLAR	777F	5	6	11
	CATERPILLAR	777G	7	0	7
	CATERPILLAR	773D	2	0	2
Shovel	KOMATSU	PC2000	3	2	5
Loader	CATERPILLAR	993K	1	1	2
	CATERPILLAR	938G	1	0	1
Motor Grader	CATERPILLAR	16M	1	0	1
Dozer	CATERPILLAR	D10T	1	0	1
	CATERPILLAR	D8T	2	0	2
Wheel Dozer	CATERPILLAR	834	1	0	1
Drilling	ATLAS COPCO	DML45	2	0	2
	ATLAS COPCO	DM45	5	5	10
<b>Total</b>			<b>33</b>	<b>15</b>	<b>48</b>

Table provided by Magna in July, 2020.

Figure 16.21 illustrates the relationship between the open-pits, waste piles, stockpiles and heap leach pads at the San Francisco Project.

### 16.4 UNDERGROUND DESIGN AND OPERATIONS

#### 16.4.1 Underground Design

Alio previously conducted an investigation into whether or not it would be economical to conduct limited underground mining beneath the southern pit wall of the San Francisco pit. In 2015, Alio conducted limited underground drifting to expose the mineralized high-grade lenses outlined in preliminary drilling. In September, 2015, Alio ceased the underground drifting, after exposing the mineralization along two lenses. Alio ultimately decided not to conduct the

underground mining and to mine this area via a pushback of the pit wall, as was noted in Micon’s 2017 Technical Report on the San Francisco Project.

In Magna’s current mine plan, the high-grade ore lenses previously identified to be mined via an open pit pushback of the pit will now be mined using an underground cut and fill mining method, during the 2020 calendar year. The remainder of the ore in the pushback will be mined as part of the Phase 7B of the mine production plan at the San Francisco pit.

**Figure 16.21**  
**Relationship between the San Francisco and La Chicharra Pits, Leach Pads, Waste Piles and Other Infrastructure 2017-Present**

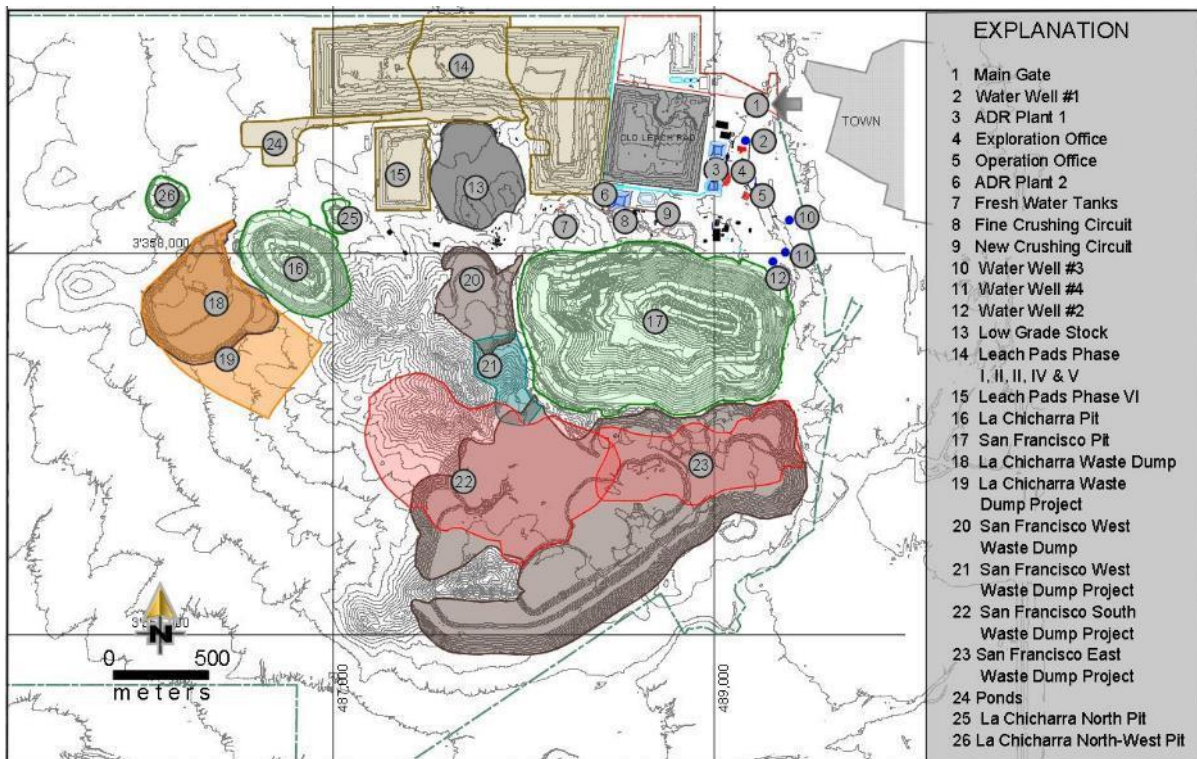


Figure provided by Magna and dated August, 2020

## 16.4.2 Underground Operations

The underground mining project is scheduled to mine 110,503 t of ore with an average grade of 4.09 g/t Au, containing 14,529 ounces Au in situ, in Table 16.4.

The underground development and mining will occur during the second half of 2020. The underground mine will be accessed through three portals installed in the pit wall at the 640 m, 632 m and 604 m elevations. The 632 m portal and development of that level was conducted in 2015.

**Table 16.4**  
**2020 Underground Mining Schedule**

Underground Schedule	Month, 2020					Totals
	August	September	October	November	December	
Diluted Tonnes	9,736	23,044	29,814	29,469	18,439	110,503
Diluted Grade	3.57	3.77	4.09	4.16	4.65	4.09
Ounces	1,118	2,793	3,920	3,942	2,757	14,529

The plan view of the underground development workings and sequence are illustrated in Figure 16.22, while a section view of the development and stopes is presented in Figure 16.23.

**Figure 16.22**  
**Plan View of the Underground Development Workings with Timing**

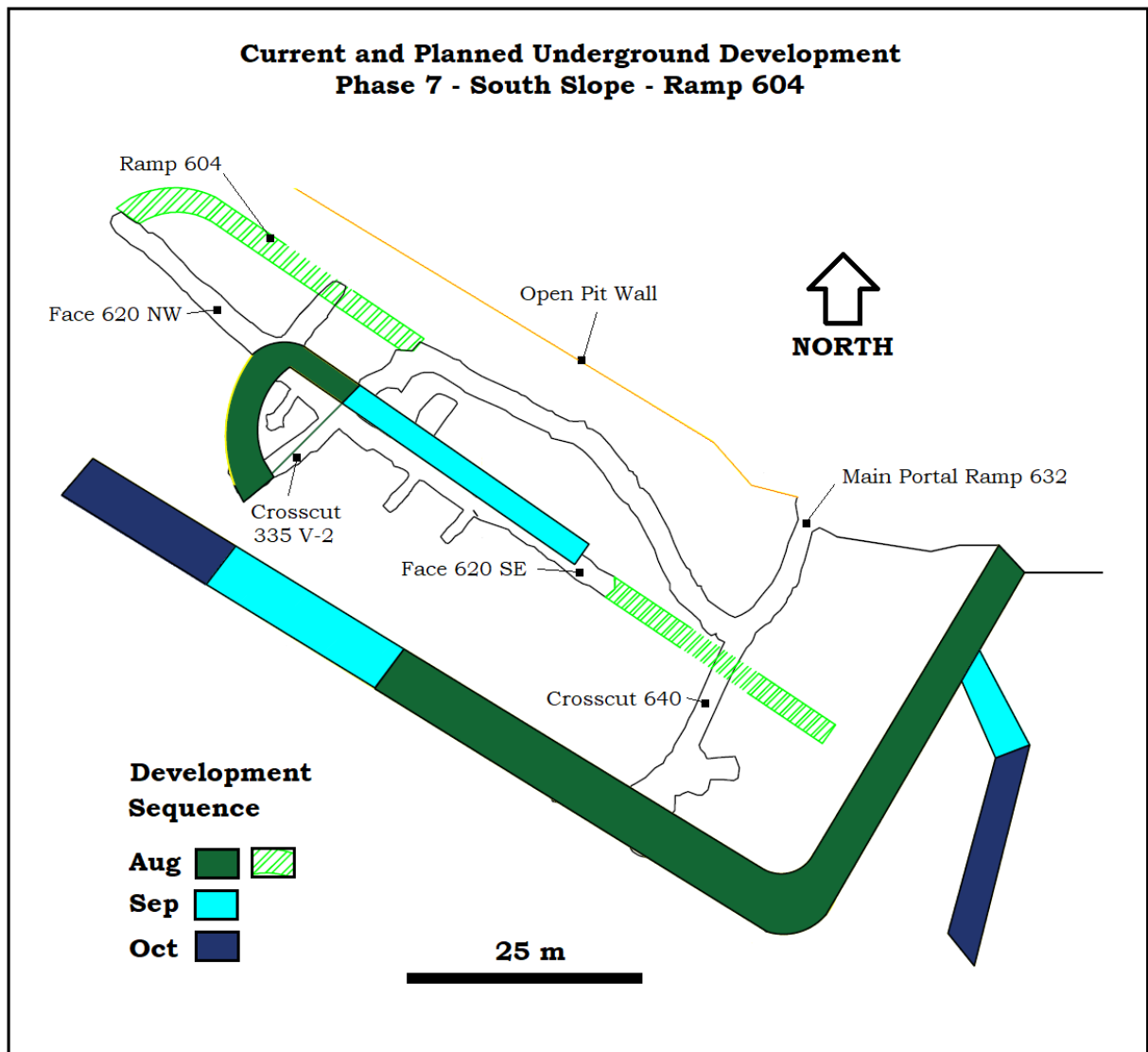


Figure provided by Magna and dated August, 2020.

Figure 16.23  
Section View of the Underground Development Workings and Stopes with Timing

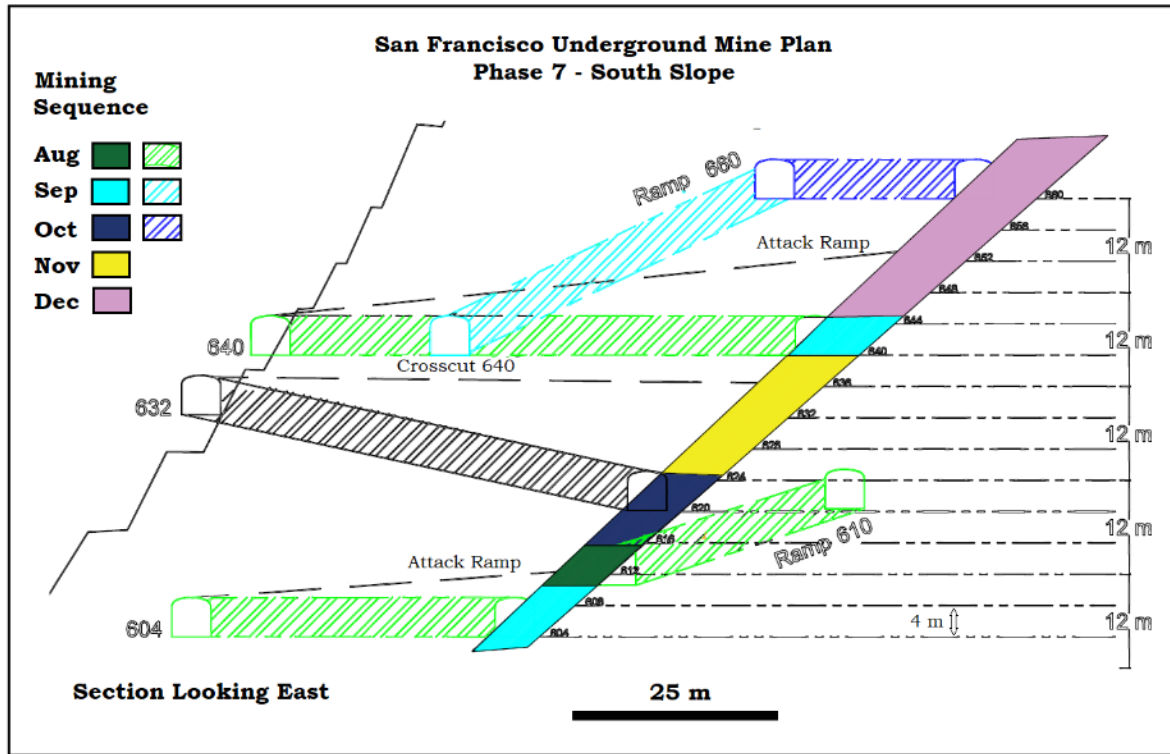


Figure provided by Magna and dated August, 2020.

## 16.5 PRODUCTION SCHEDULE

The LOM production schedule for the San Francisco and La Chicharra pits, including underground mining, is summarized in Table 16.5.

**Table 16.5  
Combined San Francisco and La Chicharra Pits and Underground LOM Production Schedule**

<b>La Chicharra Pit</b>	<b>Units</b>	<b>2020</b>	<b>2021</b>	<b>2022</b>	<b>2023</b>	<b>2024</b>	<b>2025</b>	<b>2026</b>	<b>2027</b>	<b>2028</b>	<b>Grand Total</b>
Ore	diluted tonnes	616,783	4,613,162	3,189,670	470,356	0	0	0	0	0	8,889,972
Gold grade	diluted g/t	0.283	0.286	0.448	0.426	0	0	0	0	0	0.475
Gold contained	oz	5,618	67,876	54,051	8,215	0	0	0	0	0	135,762
Waste	tonnes	6,435,302	15,661,944	6,043,201	165,641	0	0	0	0	0	28,306,088
Total tonnes	tonnes	7,052,086	20,275,106	9,232,871	635,998	0	0	0	0	0	37,196,060
Strip Ratio	W:O	10.43365	3.39505622	1.89461626	0.35216065	0	0	0	0	0	3.18
<b>San Francisco Pit</b>	<b>Units</b>	<b>2020</b>	<b>2021</b>	<b>2022</b>	<b>2023</b>	<b>2024</b>	<b>2025</b>	<b>2026</b>	<b>2027</b>	<b>2028</b>	<b>Grand Total</b>
Ore	diluted tonnes	271,977	1,334,866	3,003,257	5,490,843	5,625,166	7,004,925	7,038,030	7,043,118	1,034,193	37,846,375
Gold grade	diluted g/t	0.373	0.382	0.428	0.515	0.493	0.493	0.465	0.551	0.593	0.494
Gold contained	oz	3,261	16,415	41,312	90,907	89,145	110,920	105,130	124,865	19,707	601,662
Waste	tonnes	420,822	5,026,670	17,826,781	18,861,024	17,860,091	15,207,777	10,717,742	4,485,598	186,009	90,592,514
Total tonnes	tonnes	692,799	6,361,536	20,830,039	24,351,867	23,485,257	22,212,702	17,755,772	11,528,717	1,220,201	128,438,889
Strip Ratio	W:O	1.55	3.77	5.94	3.43	3.18	2.17	1.52	0.64	0.18	2.39
<b>San Francisco Underground</b>	<b>Units</b>	<b>2020</b>	<b>2021</b>	<b>2022</b>	<b>2023</b>	<b>2024</b>	<b>2025</b>	<b>2026</b>	<b>2027</b>	<b>2028</b>	<b>Grand Total</b>
Ore	diluted tonnes	110,503	0	0	0	0	0	0	0	0	110,503
Gold grade	diluted g/t	4.089	0	0	0	0	0	0	0	0	4.089
Gold contained	Oz	14,529	0	0	0	0	0	0	0	0	14,529
Waste	tonnes	0	0	0	0	0	0	0	0	0	0
Total tonnes	tonnes	110,503	0	0	0	0	0	0	0	0	110,503
Strip Ratio	W:O	0	0	0	0	0	0	0	0	0	0
<b>Stockpile</b>	<b>Units</b>	<b>2020</b>	<b>2021</b>	<b>2022</b>	<b>2023</b>	<b>2024</b>	<b>2025</b>	<b>2026</b>	<b>2027</b>	<b>2028</b>	<b>Grand Total</b>
Ore tonnes	tonnes	782,048	0	0	0	0	0	0	0	0	782,048
Gold grade	grade	0.256	0	0	0	0	0	0	0	0	0.256
Gold contained	oz	6,437	0	0	0	0	0	0	0	0	6,437
<b>Total Mined</b>	<b>Units</b>	<b>2020</b>	<b>2021</b>	<b>2022</b>	<b>2023</b>	<b>2024</b>	<b>2025</b>	<b>2026</b>	<b>2027</b>	<b>2028</b>	<b>Grand Total</b>
Ore	diluted tonnes	1,781,311	5,948,028	6,192,927	5,961,199	5,625,166	7,004,925	7,038,030	7,043,118	1,034,193	47,628,898
Gold grade	diluted g/t	0.521	0.441	0.479	0.517	0.493	0.493	0.465	0.551	0.593	0.495
Gold contained	oz	29,845	84,291	95,363	99,122	89,145	110,920	105,130	124,865	19,707	758,390
Waste	tonnes	6,856,124	20,688,614	23,869,982	19,026,665	17,860,091	15,207,777	10,717,742	4,485,598	186,009	118,898,602
Total tonnes	tonnes	8,637,436	26,636,642	30,062,909	24,987,865	23,485,257	22,212,702	17,755,772	11,528,716	1,220,202	166,527,500
Strip Ratio	W:O	3.85	3.48	3.85	3.19	3.18	2.17	1.52	0.64	0.18	2.50
Daily ore throughput	t/d	4,880	16,296	16,967	16,332	15,411	19,192	19,282	19,296	2,833	16,875
Total daily moved	t/d	23,664	72,977	82,364	68,460	64,343	60,857	48,646	31,586	3,343	57,758
<b>Crusher Plan</b>	<b>Units</b>	<b>2020</b>	<b>2021</b>	<b>2022</b>	<b>2023</b>	<b>2024</b>	<b>2025</b>	<b>2026</b>	<b>2027</b>	<b>2028</b>	<b>Grand Total</b>
Total ore	tonnes	1,781,311	5,948,028	6,192,927	5,961,199	5,625,166	7,004,925	7,038,030	7,043,118	1,034,193	47,628,898
Gold grade	g/t	0.521	0.441	0.479	0.517	0.493	0.493	0.465	0.551	0.593	0.495
Gold Oz	oz	29,845	84,291	95,364	99,122	89,145	110,920	105,130	124,865	19,707	758,390
T/D crushed	avg. t/d	4,880	16,296	16,967	16,332	15,411	19,192	19,282	19,296	2,833	16,875

## 17.0 RECOVERY METHODS

The information for this Section was extracted from the June 1, 2020, Technical Report, with updated information to cover the period since that report was written.

Magna re-commenced mining and processing at the Project in June, 2020, with the processing operating procedures the same or similar to those undertaken previously by Alio.

### 17.1 PROCESSING DESCRIPTION

The process used at the mine comprises multi-stage crushing and screening to 100% passing 9.5 mm, conveying and stacking of crushed material onto a heap leach pad, cyanide heap leaching and gold recovery from the pregnant solution using carbon columns, Zadra type elution, electrowinning and smelting to produce a doré product containing over 90% precious metals.

#### 17.1.1 Crushing and Conveying

Mined ore is crushed using two crushing and screening circuits. Crushing circuit 1 is designed to deliver 16,000 t/d of crushed material to the leach pads, but typically operates at 15,000 t/d. The second, newer circuit can process an additional 7,000 t/d for a total current crushing operating rate of 22,000 t/d.

Flowsheets for the two crushing circuits are shown in Figure 17.1 and Figure 17.2.

Circuit 1 includes one jaw crusher, a 6,000 t capacity coarse ore stockpile, two secondary crushers, three tertiary crushers, multi-deck vibrating screens, vibrating feeders and conveyors.

Circuit 2 comprises one jaw crusher, two secondary crushers, three tertiary crushers, screens and conveyors.

The minus 9.5 mm undersize product from the screens is delivered to the leach pad using overland conveyors.

#### 17.1.2 Leaching

Product from the crushing plants is transported to the leach pad on overland conveyors and deposited on the pad with a stacker, forming 8 m to 12 m high lifts. A bulldozer is used to level the surface of each lift. The irrigation pipelines are then installed to distribute the leach solution over the entire surface of the lift. The design primary leach time is reported to be 180 days although, in practice, this can be extended when leaching a lift placed on top of a previous lift.

**Figure 17.1**  
**Crushing Circuit 1 Flowsheet (100% passing 9.5 mm)**

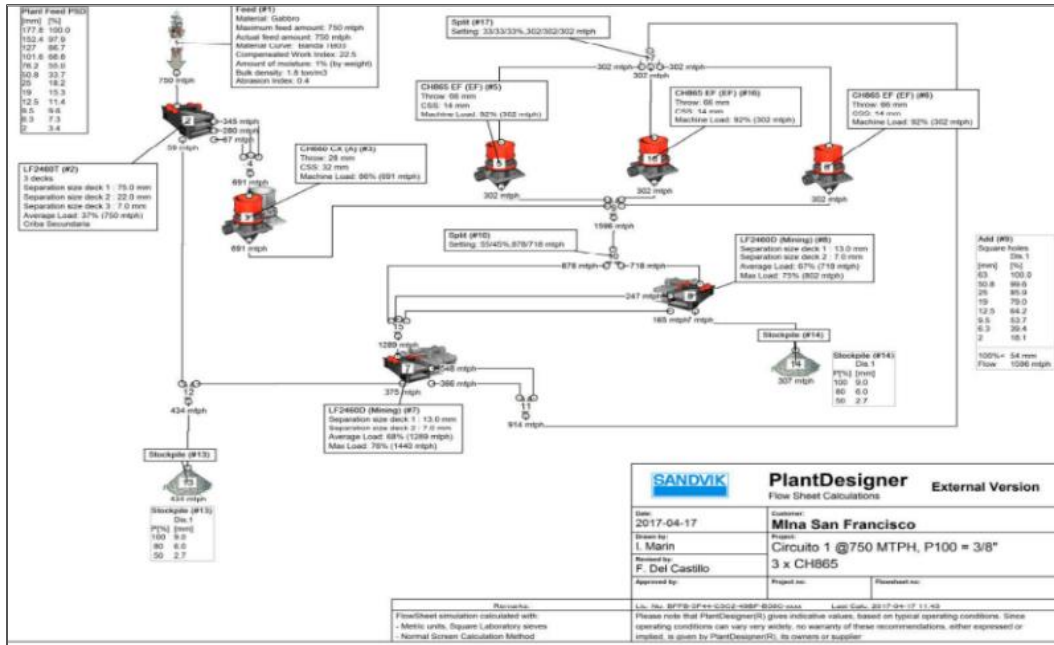


Figure provided by Alio Gold Inc. and dated May, 2017.

**Figure 17.2**  
**Crushing Circuit 2 Flowsheet (100% passing 9.5 mm)**

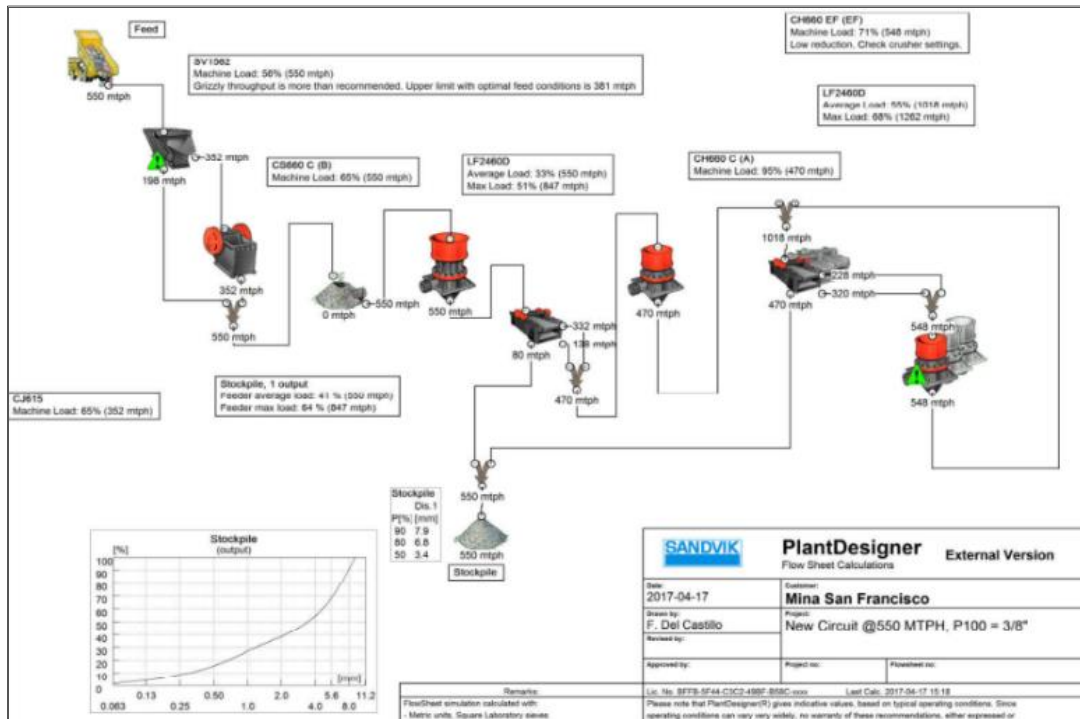


Figure provided by Alio Gold Inc. and dated May, 2017



The leach pad has been constructed over the years as 6 different phases, based on the permits granted by the Mexican Environmental Agency (PROFEPA, Procuraduría Federal de Protección al Ambiente) Table 17.1 summarizes the leach pad phases, based upon the permits acquired.

**Table 17.1**  
**Summary of the Leach Pad Phases Based Upon the Permits Acquired for the San Francisco Mine**

# Phase	Duration	Area	Nominal Capacity	Capacity to date	Status
1 & 2	Nov. 2009 to Nov. 2013	36 ha	26 Mt	25 Mt	Released
3	Nov. 2013 to Aug. 2015	25 ha	18 Mt	18 Mt	On Irrigation
4	Aug. 2015 to Oct. 2016	16 ha	12 Mt	12 Mt	On Irrigation
5	Oct. 2016 to June 2017	12 ha	9 Mt	7 Mt	On Irrigation
6	June 2017 to Oct. 2020	17 ha	12 Mt	5 Mt	Depositing Ore
<b>Total</b>			<b>77 Mt</b>	<b>67 Mt</b>	

Table provided by Magna in August, 2020.

The leach solution fed to the heap consists of 0.05% sodium cyanide, with lime addition to obtain a pH of between 10.5 to 11. The solution percolates to the bottom of the lift and flows to the channel that carries the solution to the pregnant solution storage pond, from which it is pumped to the adsorption, desorption and recovery (ADR) plants.

Barren solution exiting the two ADR plants flows to the barren solution storage pond, where fresh water and sodium cyanide are added before being pumped back to the leach pad.

The heap leach solution flowsheet and the second ADR plant flowsheet are presented in Figure 17.3 and Figure 17.4.

### 17.1.3 Adsorption/Desorption/Recovery Plants

Pregnant leach solution is fed to two ADR plants. The first adsorption plant consists of 2 parallel lines of carbon columns, each with 5 tanks in series, through which the carbon is advanced counter-currently to the solution flow. One line of columns contains approximately 2.0 t of carbon and the other 2.5 t. Gold is adsorbed on the carbon to a concentration of approximately 5,000 g/t. Desorption of the carbon is achieved in a Zadra type elution circuit. Gold is recovered by an electrowinning circuit comprising stainless steel electrodes in a stainless steel electrolytic cell.

Installation of a new line of carbon columns (second ADR plant) with 5 tanks each containing approximately 6 t of carbon, and a design flow of 3,500 USGM (805 m<sup>3</sup>/h), was completed in August, 2011, to increase the production capacity.

A new stripping circuit with a capacity of 5.5 t of carbon was added to the process in March, 2017.

In March, 2017, a process was initiated to separately deliver the drainage solution from old leach pads (Phases 1 and 2) to an intermediate solution pond, and to continually recirculate this solution until it is enriched enough to be sent to the ADR circuit (minimum average solution grade of 0.13 ppm Au). Additional equipment and piping was added in order to process the 8,000 m<sup>3</sup>/d of solution from the old leach pads.

An additional carbon tank with a capacity of 6 t of activated carbon was added for capturing the gold from the old leach pads.

**Figure 17.3**  
**Heap Leach Circuit Showing the Solution Balance**

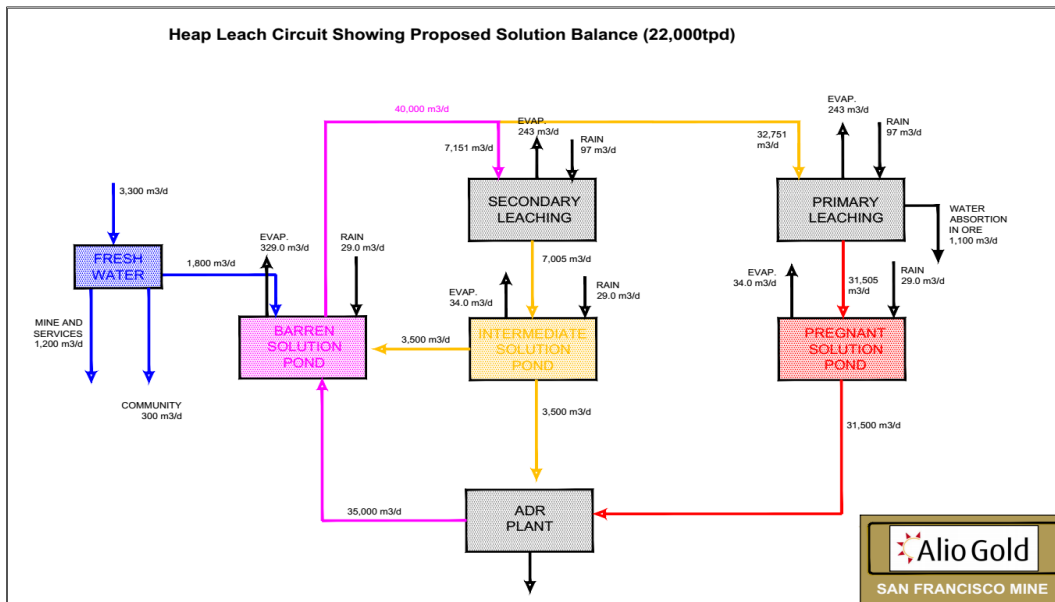


Figure provided by Alio Gold Inc. and dated May, 2017.

**Figure 17.4**  
**Overall Gold Recovery Circuit (ADR) Flowsheet**

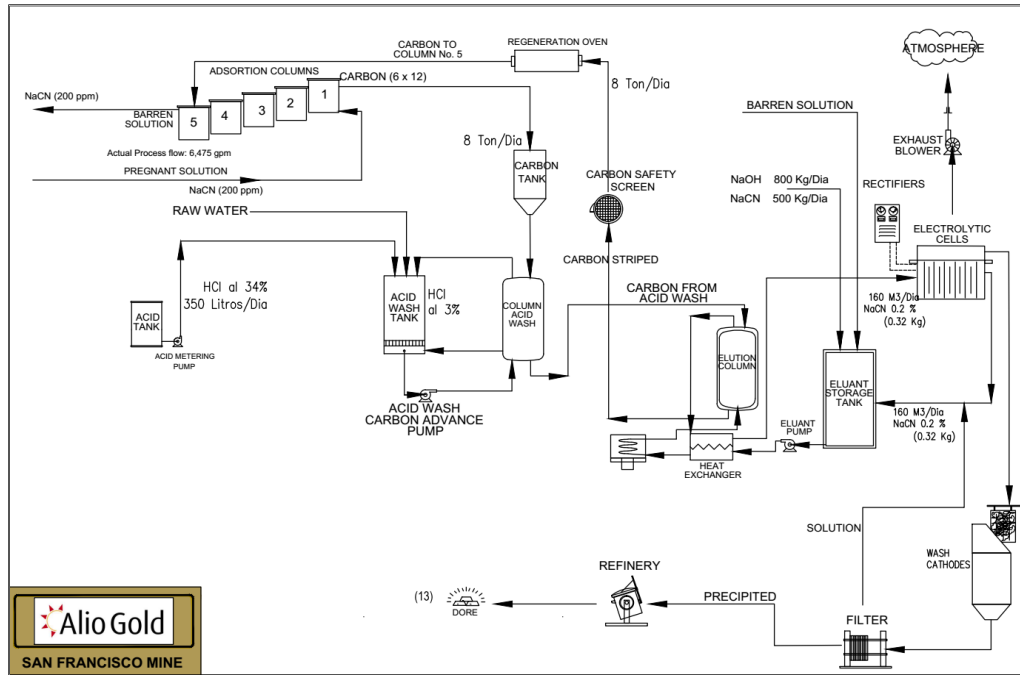


Figure provided by Alio Gold Inc. and dated May, 2017.

Figure 17.5 is a view of the second ADR plant taken during the May, 2017 Micon site visit.

**Figure 17.5**  
**View of the Second ADR Plant**



Photograph taken during the May, 2017 Micon site visit.

### 17.1.4 Process Plant Layout

Figure 17.6 is a plan view of the crushing circuit. Figure 17.7 is a view of the crushing circuit from the San Francisco pit lookout, and Figure 17.8 is a photograph of the heap leach pads, as viewed from the road to the La Chicharra pit, with Phase 6 under construction in the foreground during the 2017 Micon site visit.

**Figure 17.6**  
**Plan View of the Current Crushing Facilities<sup>1</sup>**

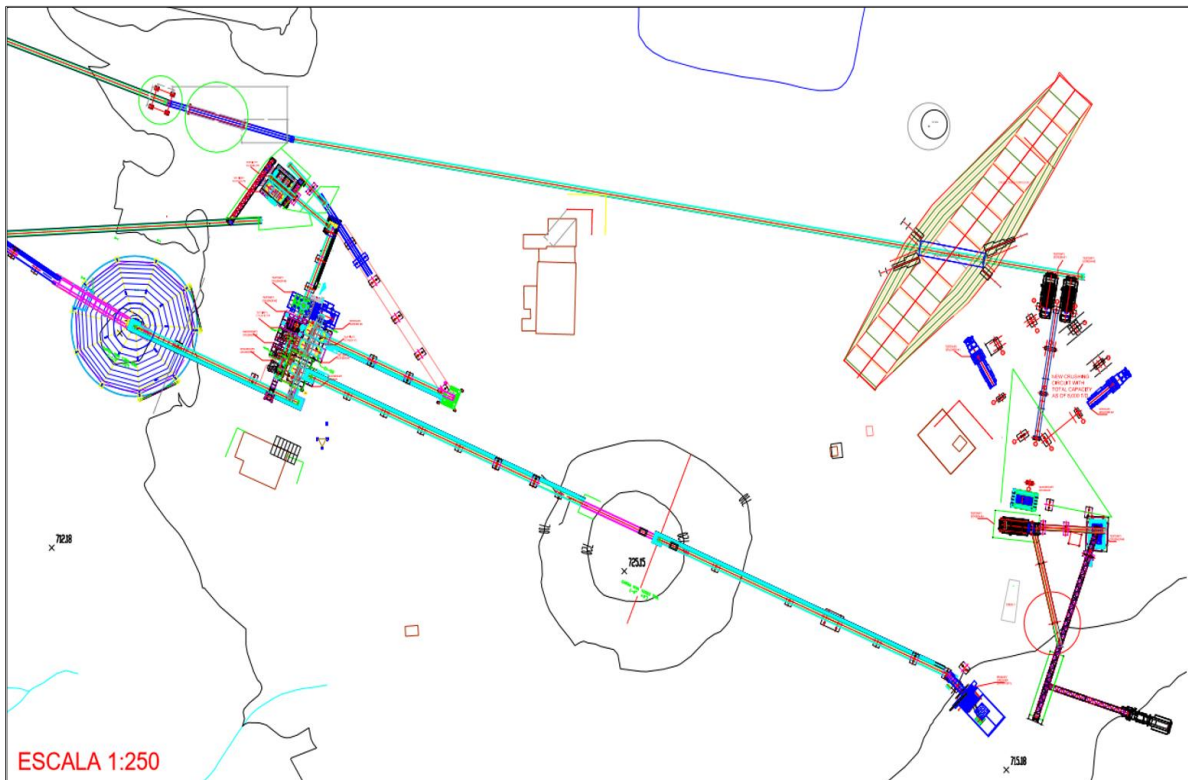


Figure provided by Alio Gold Inc. and dated February, 2016.  
Note 1: Drawing not to scale and North direction is toward the top of the figure.

**Figure 17.7**  
**View of the Crushing Facilities and Heap Leach Pads as Seen from the Lookout at the San Francisco Pit (Zoom Lens)**



Panoramic zoom lens photograph taken during the May, 2017 Micon site visit.

**Figure 17.8**  
**Heap Leach Pads as Viewed from the Road to the La Chicharra Pit with Phase 6 Under Construction in the Foreground (May, 2017)**



Panoramic photograph taken during the May, 2017 Micon site visit.

### 17.1.5 Manpower

The process plant manpower during normal operating conditions is summarized in Table 17.2.

**Table 17.2**  
**Manpower at the San Francisco Mine Process Plant and Associated Facilities**

Department	Description	Quantity
ADR plant	Superintendent / Supervisor	4
	Hourly personnel	28
Leach	Superintendent / Supervisor	2
	Hourly personnel	14
Crushing	Superintendent / Supervisor	9
	Hourly personnel	36
Laboratory	Superintendent / Supervisor	9
	Hourly personnel	23
<b>Total</b>		<b>125</b>

Table provided by Magna in July, 2020

While the operation was in the residual leach stage, earlier in 2020, the normal operating manpower noted in Table 17.2 was greatly reduced. Magna has now resumed normal operations.

### 17.1.6 Consumables and Maintenance

The typical average usage rates and costs of process reagents are summarized in Table 17.3.

**Table 17.3**  
**San Francisco Process Reagents (Consumables) Usage Rates and Costs**

Reagents	Consumption (Unit/tonne)	Annual Cons (Unit/year)	Unit Cost (USD)	Annual Cost (USD)
Antiscalant	0.018 L	147,391 L	\$2.30	338,835
Sodium Cyanide	0.462 kg	3,708 t	\$2.45	9,085,944
Caustic Soda	0.141 kg	1,136 t	\$0.46	525,342
Lime	2.500 kg	20,075 t	\$0.17	3,365,309
Carbon	0.010 kg	80 t	\$4.50	358,303
Hydrochloric Acid	0.016 kg	126 t	\$0.31	38,595
Propane	0.097 L	782,175 L	\$0.48	371,697
<b>Total cost</b>				<b>14,084,025</b>
<b>Total cost per tonne</b>				<b>\$1.75</b>

Table provided by Magna, July, 2020.

## 17.2 SCHEDULE OF GOLD PRODUCTION

The planned annual schedule of gold production is summarized in Table 17.4.

**Table 17.4  
Annual Gold Production**

<b>Crusher Plan</b>	<b>Units</b>	<b>2020</b>	<b>2021</b>	<b>2022</b>	<b>2023</b>	<b>2024</b>	<b>2025</b>	<b>2026</b>	<b>2027</b>	<b>2028</b>	<b>Grand Total</b>
Total ore	kt	1,781	5,948	6,193	5,961	5,625	7,005	7,038	7,043	1,034	47,629
Gold grade	g/t	0.52	0.44	0.48	0.52	0.49	0.49	0.47	0.55	0.59	0.50
Gold Oz	oz	29,845	84,291	95,364	99,122	89,145	110,920	105,130	124,865	19,707	758,390
Residual Gold leached	oz	9,559	4,736	0	0	0	0	0	0	0	14,295
Newly-Mined Gold Leached	oz	15,010	61,531	62,640	68,125	58,336	71,892	70,066	82,564	22,189	512,354
Total Gold Production	oz	24,569	66,267	62,640	68,125	58,336	71,892	70,066	82,564	22,189	526,649
Recovery ex newly-mined ore	% cumulative	50%	67%	66%	67%	67%	66%	66%	66%	68%	68%

## 18.0 PROJECT INFRASTRUCTURE

### 18.1 ADMINISTRATION, ENGINEERING AND EXISTING INFRASTRUCTURE

Figure 18.1 shows the existing San Francisco mine site layout, with the pits, leach pads, waste storage expansion, the low-grade ore stockpile and the area around the La Chicharra pit.

**Figure 18.1**  
**2016 General Site Layout**

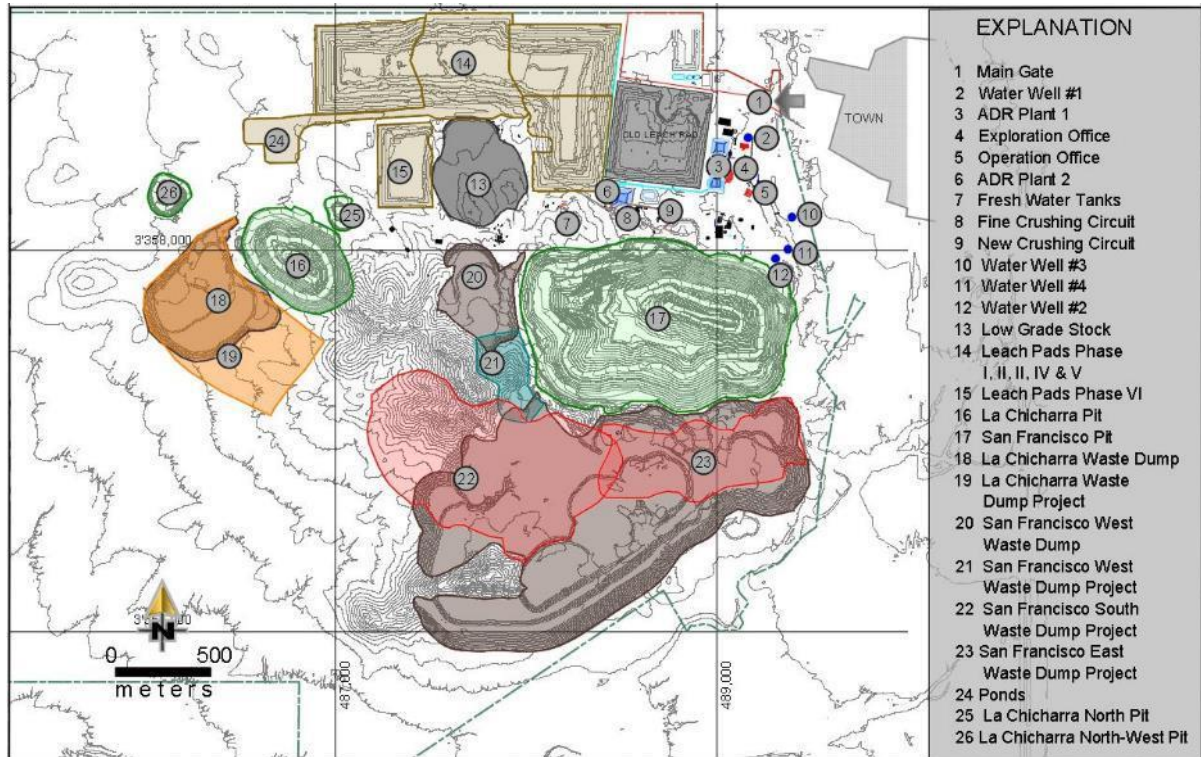


Figure provided by Magna and dated August, 2020.

#### 18.1.1 Manpower Organization

The total manpower at the San Francisco mine is shown in Table 18.1, excluding the mine contract personnel and with both open pits in production. The numbers reflect the current operations which are in the process of restarting after having been in the residual leach stage since the beginning of 2020. Magna began sending ore to the leach pads on June 16, 2020, with full production occurring on June 18, 2020.



**Table 18.1  
Total Manpower for the San Francisco Mine**

Department	Description	Quantity
ADR Plant	Superintendent/Supervisor	4
	Hourly Personnel	28
Leach	Superintendent/Supervisor	2
	Hourly Personnel	14
Crushing (incl. Mec Maint.)	Superintendent/Supervisor	9
	Hourly Personnel	36
Warehouse	Supervisor	1
	Hourly Personnel	3
Exploration	Superintendent/Supervisor	0
	Hourly Personnel	0
Direction	General Manager	1
	Superintendent/Supervisor	3
Geology	Superintendent/Supervisor	3
	Hourly Personnel	9
Mine	Superintendent/Supervisor	3
	Hourly Personnel	1
Engineering	Superintendent/Supervisor	3
	Hourly Personnel	3
Laboratory	Superintendent/Supervisor	9
	Hourly Personnel	23
Metallurgy	Superintendent/Supervisor	3
	Hourly Personnel	6
Electrical Maintenance	Superintendent/Supervisor	4
	Hourly Personnel	8
Administrative/Accounting	Superintendent	1
	Supervisor/Assistant	4
Purchasing	Superintendent	1
	Supervisor/Assistant	2
Human Resources	Superintendent/Supervisor	1
	Hourly Personnel	5
Safety and Environment	Superintendent/Supervisor	9
	Hourly Personnel	2
<b>TOTAL</b>		<b>246</b>

Table provided by Magna July, 2020.

### 18.1.2 Offices, Workshops and Stores

Office space is provided in a structure of approximately 450 m<sup>2</sup>, located southeast of the ADR plant. The building has adequate working space for the on-site mine administration and also provides basic catering and ablution facilities.

A vehicle workshop, south of the ADR plant and north of the open pit, occupies more than 660 m<sup>2</sup> and is available for maintenance of the off-road haul trucks, excavators and ancillary vehicles used in the open pit mining operation.

A general warehouse of approximately 200 m<sup>2</sup>, located north of the ADR plant, accommodates process reagents and mechanical spares. Bulk lime for the heap leach process is stored in a silo near the crushing plant.

A new building was completed in December, 2010, to house the exploration offices. This office space is approximately 150 m<sup>2</sup>, and provides adequate working space and basic ablution facilities. It is located east of the original ADR plant.

A 1,500 m<sup>2</sup> core and sample storage facility (Figure 18.2, Figure 18.3 and Figure 18.4), north of the ADR plant, was completed in 2013. This facility provides permanent and secure storage for both the diamond drill core and pulp samples, as well as hosting the new sample preparation facilities for the exploration department. The rear half of the building is currently being used as a secure storage facility for reagents used in the ADR plants.

A 1,500 m<sup>2</sup> general warehouse expansion, located north of the ADR plant, was completed in January, 2014. The facility accommodates mechanical spares and other consumables.

**Figure 18.2**  
**Exploration Sample Storage and Preparation Facility**



Photograph taken during 2017 Micon site visit.

**Figure 18.3**  
**Core Stored in the Exploration Sample Storage and Preparation Facility**



Photograph taken during 2017 Micon site visit.

**Figure 18.4**  
**Pulp Samples Stored in the Exploration Sample Storage and Preparation Facility**



Photograph taken during 2017 Micon site visit.

### 18.1.3 Electrical Power Supply

Electrical power is delivered through a 33 kV overhead line from the utility company, Comisión Federal de Electricidad (CFE). From the main metering point, the power is distributed to the crushing and screening plant and other site infrastructure at 480/220/110 V. However, power for the new crushing circuit is supplied by diesel generators with approximately 2 MW of capacity. At the crushing and screening plant, separate transformers feed the principal equipment. Installed transformer capacity is summarized in Table 18.2.

**Table 18.2**  
**Summary of the Installed Transformer Capacity**

Area of Transformer	KVA
Primary Crushing (Gyratory Crusher)	1,000
Fine Crushing Circuit	3,000
New Crushing Circuit	1,500
Overland & grasshoppers conveyors	5,500
Leach solution ponds	1,500
Pumping Substation	2,500
ADR Plant	1,000
Assay & Met Laboratory	300
Exploration Assay Laboratory	500
Main office	75
Exploration office	45
Water well #1	75
Water well #2	45
Water well #3	150
Water well #4	225
Overall lighting	50
Mining contractor office	75
Mining contractor workshop	75
Mechanical maintenance workshop	75
Washer truck area	75
Geology warehouse	75
Liquid cyanide facility	30
Maintenance contractor office (Inpromine)	150
Main warehouse	15
<b>Total</b>	<b>18,035</b>

Table provided by Magna, July, 2020.

The electrical power supply is sufficient for the full production rate of 22,000 t/d of ore, with some spare capacity.

### 18.1.4 Water Supply

At full production capacity, the demand of fresh water is 3,296 m<sup>3</sup>/d, of which 1,841 m<sup>3</sup>/d are for the leach area and ADR plants, 988 m<sup>3</sup>/d for the irrigation of the roads inside both pits, 136 m<sup>3</sup>/d for crushing and offices, 58 m<sup>3</sup>/d for the mining contractor office and workshop and 273 m<sup>3</sup>/d for the irrigation of community roads.

Comisión Nacional del Agua (CONAGUA) has authorized 4 concession titles to exploit and use national water for a grand total of 1,900,000 m<sup>3</sup>/year. Alio has built and commissioned 4 water wells, with the following capacities:

- Water well #1: 300,000 m<sup>3</sup>/year.
- Water well #2: 300,000 m<sup>3</sup>/year.
- Water well #3: 400,000 m<sup>3</sup>/year.
- Water well #4: 900,000 m<sup>3</sup>/year.

All fresh water is conducted through pipelines and distributed to each point of usage, as shown in Figure 18.5.

**Figure 18.5**  
**Fresh Water Distribution Network at the San Francisco Mine**

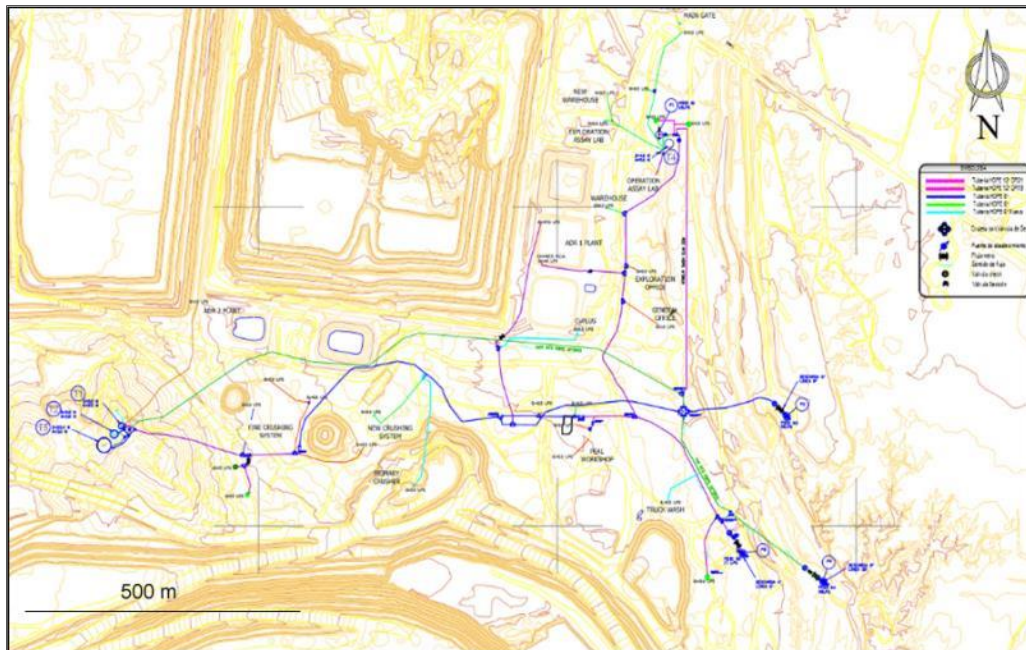


Figure from previous 2017 Micon Technical Report dated September, 2016.

A new water tank and a pressure pump were installed to comply with regulation NOM-002-STPS of the Secretaría del Trabajo y Previsión Social (STPS) regarding the prevention of and protection against fire in the workplace, which states that water pressure for fire control should be at least 7 kg/cm<sup>2</sup>.

## 19.0 MARKET STUDIES AND CONTRACTS

The gold doré produced at the San Francisco mine is further refined and readily sold on the world market at prices that are usually fixed by the London Metal Exchange (LME)

### 19.1 MARKET AND MARKET STUDIES

Gold is a metal that is traded on world markets, with benchmark prices generally based on the London market (London fix). Gold has two principal uses: product fabrication and bullion investment. Fabricated gold has a wide variety of end uses, including jewellery (the largest fabrication use), electronics, dentistry, industrial and decorative uses, medals, medallions and official coins. Gold bullion is held primarily as a store of value and as a safeguard against the depreciation of paper assets denominated in fiat currencies. Due to the size of the bullion market and the above-ground inventory of bullion, Magna's activities will not influence gold prices.

Table 19.1 summarizes the high and low average annual London PM gold and silver price per ounce from 2000 to August 7, 2020.

**Table 19.1**  
**Average Annual High and Low London PM Fix for Gold and Silver from 2000 to March 20, 2020**  
**(prices expressed in USD/oz)**

Year	Gold Price (USD)			Silver Price (USD)		
	High	Low	Cumulative Average	High	Low	Cumulative Average
2000	312.70	263.80	279.11	5.45	4.57	4.95
2001	278.85	255.95	271.04	4.82	4.07	4.37
2002	349.30	277.75	309.73	4.85	4.20	4.60
2003	416.25	319.90	363.38	5.96	4.37	4.88
2004	454.20	375.00	409.72	7.83	5.49	6.67
2005	536.50	411.10	444.74	9.23	6.39	7.32
2006	725.00	524.75	603.46	14.94	8.83	11.55
2007	841.10	608.30	695.39	15.82	11.67	13.38
2008	1,011.25	712.50	871.96	20.92	8.88	14.99
2009	1,212.50	810.0	972.35	10.51	19.18	14.67
2010	1,421.00	1,058.00	1,224.53	15.14	28.55	20.19
2011	1,895.00	1,319.00	1,571.52	26.68	48.70	35.12
2012	1,791.75	1,540.00	1,668.98	37.23	26.67	31.15
2013	1,693.75	1,192.00	1,411.23	31.11	18.61	23.79
2014	1,385.00	1,142.00	1,266.40	22.05	15.28	19.08
2015	1,295.75	1,049.40	1,160.06	18.23	13.71	15.68
2016	1,366.25	1,077.00	1,250.74	20.71	13.58	17.14
2017	1,346.25	1,151.00	1,257.12	18.21	15.22	17.04
2018	1,354.95	1,178.40	1,268.49	17.52	13.97	15.71
2019	1,546.10	1,269.60	1,392.60	19.31	14.38	16.21
2020*	2,067.15	1,474.25	1,687.30	28.33	12.01	17.53

Source: www.kitco.com, London PM Fix – USD.

\* Data for 2020 is as of August 7, 2020.

## 19.2 MINING CONTRACTS

The mining contract details are reflective of the contract as of the May 25, 2017, Technical Report. According to Magna personnel the current mining and refining contracts are reflective of the contracts that were in place during Micon's site visit for the 2017 report. Magna further reports that it has settled the dispute regarding details contained within the contract with the mining contractor and that the previous Alio contractor has been retained to conduct its mining activities.

### 19.2.1 Contractor Requirements

Under the mining contract dated September 19, 2009, as amended on March 18, 2011, November 1, 2012, April 1, 2013, March 21, 2014, and in February and March, 2015, the contractor's performance of mining operations at the San Francisco mine includes drilling and blasting, loading and transportation of waste rock and ore, pit drainage, building slopes and roads as needed, scaling of pit walls to design limits, maintenance of equipment, and providing safe and orderly working conditions.

Until the end of 2017, the base contract rate for mining was USD 1.59/t for the first 2.5 Mt mined in a given month, with reduced rates for the incremental tonnage mined in excess of 2.5 Mt, as summarized in Table 19.2. As part of Alio's negotiations with the mining contractor to reduce the operating costs, it has been agreed that there will be a base rate of USD 1.59/t for the San Francisco pit and USD 1.30/t for the La Chicharra pit. Magna has negotiated the same rates as those Alio was paying.

**Table 19.2**  
**Contract Mining Rates**

<b>Tonnage Range (Mt/y)</b>	<b>Base Rate (USD/t)</b>	<b>Incremental Rate (USD/t)</b>
Monthly tonnage San Francisco pit	1.59	-
Monthly tonnage La Chicharra pit	1.30	-

Other terms of the mining contract include:

- The assumed powder factor is 0.200 kg of ANFO per tonne of rock blasted. The base cost per tonne of material blasted (including items such as explosives, supplies and accessories, drill service for blasting etc.), is USD 0.19/t.
- The drill pattern is 4.5 m by 5.0 m, using 6.5-inch diameter blast hole drills.
- The base cost of diesel fuel is USD 0.52 per litre.
- Design rock densities are ore 2.66 t/m<sup>3</sup> and waste 2.77 t/m<sup>3</sup>.
- The work schedule is based on two shifts of 12 hours per day, 360 days per year.

## **19.2.2 Owner Mining Requirements**

Mine engineering and design services are provided by Magna. These services include:

- Obtaining of all permits and licences for mining.
- Mine design and planning, grade control and surveying services.
- Supply of electric power, water and telecommunications.
- Security services, safety plans and personnel and first aid stations.

## **19.2.3 Magna Discussions with the Mining Contractor**

Magna has informed Micon that it has signed a letter of intent to resolve the issues surrounding the ongoing legal process initiated by the mining contractor Peal against, Alio and that the dispute has now been settled.

## **19.3 REFINING AND SALES CONTRACTS**

### **19.3.1 Refining Agreement**

Magna's subsidiary Molimentales has entered into an agreement with Asahi Refining USA Inc. (Asahi) to refine the gold and silver doré bars produced at the San Francisco mine, at Asahi's Salt Lake City refinery in Utah, USA.

Some of the terms and conditions in the contract are as follows:

- Shipments will consist of no less than 75 kg of material, in the form of doré bars weighing approximately 10 to 25 kg.
- Each shipment will have full and complete documentation to permit importation into the United States.
- The refiner will credit the following percentages of the final agreed assayed gold and silver content of the refined material in each shipment:
  - 99.925% of the assayed gold content.
  - 99.00% of the assayed silver content.
- Delivery of the gold and silver components of the recoverable metals from each shipment will be made 5 working days after receipt of the material by the refiner, subject to the assay results being within the splitting limits as set forth in the agreement.
- Treatment charges are USD 0.40 per troy ounce of material received.
- If Magna elects to take an early settlement of the account, Asahi will levy a fee which is calculated according to the terms of the agreement.
- Asahi may charge additional fees for refining or may reject any material containing in excess of the maximum limits of deleterious elements, as defined by the contract.



The first refining agreement between Molimentales and Asahi commenced on December 28, 2009 and remained in effect until December 31, 2011. It was renewed in 2012 and the term was extended until December 31, 2013. Thereafter, the agreement has been automatically renewed for 12 months at a time. The current agreement was signed on December 12, 2016, covering the period from January 1, 2017 to December 31, 2017. That agreement was extended and Magna has indicated it has continued the contract with Asahi.

### **19.3.2 Master Purchase Contract and Bill of Sale and Trading Agreement**

On June 23, 2010, Molimentales entered into a contract and sale agreement with Auramet Trading, LLC (Auramet), under which it agreed to sell the gold and silver output from the San Francisco mine to Auramet.

On June 23, 2010, Molimentales also entered into a trading agreement with Auramet, which set forth the terms and conditions that govern non-exchange traded, over-the-counter, spot, forward and option transactions, on a deliverable and non-deliverable basis, involving various metals, energy products and currencies. The trading agreement is part of the Master Purchase Contract and Bill of Sale agreement with Auramet.

### **19.3.3 Blasting Services**

Molimentales had an agreement, valid until October 31, 2017, with DUFIL, S.A. de C.V. (Dufil), to handle the explosives from the warehouse to the pit, to prepare the ANFO, to design the blasting grids and to load the explosives into the holes. The agreement was extended into 2018. Magna has indicated it has entered into an agreement with Dufil, as part of the reopening of the San Francisco mine.

## **20.0 ENVIRONMENTAL STUDIES, PERMITTING AND SOCIAL OR COMMUNITY IMPACT**

The information for this Section was extracted from the May 25, 2017, Technical Report. There have been no material changes since the May, 2017 Technical Report was published.

### **20.1 DETAILS FROM THE MAY 25, 2017 TECHNICAL REPORT**

#### **20.1.1 Environmental Considerations**

On March 2, 2012, Molimentales submitted a request to the Secretary for the authorization of an additional land use of 70.00 ha for the Chicharra pit, 160.00 ha for a new waste dump, 100.00 ha for the new leach pads, 8.54 ha for a new crushing circuit and 9.18 ha for a new area in the ADR plant, for the increase in production capacity to 25,000 t/d. The Secretary conditionally authorized the additional land on May 02, 2012.

On July 22, 2013, Molimentales submitted a Technical Justification Study for the Change of Use of Land (Estudio Técnico Justificativo para el Cambio de Uso de Suelo) to the Secretary to grant authorization for 334.75 ha of new land use areas, based upon the inventory of the natural resources to be affected, and an environmental evaluation of the new areas. The Secretary authorized the additional land on October 16, 2013. At that time, the whole mine site was covered by the authorization.

Modifications to the Environmental Licence (Licencia Ambiental Única), initially authorized on March 17, 2010, were submitted on August 25, 2014, to request the authorization of the Secretary of Environment and Natural Resources to include new equipment and increased production capacity for the operating licence, new inventory and registration of emissions to the atmosphere, new inventory and registration of hazardous waste generation and, also to register modifications to the blasting program. The Secretary conditionally authorized the modifications on October 6, 2014.

Alío continues to comply with conditions established by the Secretary of Environment and Natural Resources for all of the previous and newly authorized environmental permits. These conditions include programs for the recovery and relocation of flora, reforestation, recovery and relocation of fauna, monitoring of surface water quality, monitoring of air quality, and hazardous waste management.

Molimentales was certified in April, 2015 as a “Clean Industry”, which is granted by the Federal Attorney of Environmental Protection (PROFEPA). The certification was granted after an environmental audit process at the San Francisco mine and it was valid for 2 years.

Magna expects that renewal of the “Clean Industry” certification will be obtained by the fourth quarter of 2020.

### 20.1.2 Community and Social Considerations

Alio has been an active participant in, and supporter of, a number of community activities in Estación Llano and the surrounding communities. These activities ranged from assisting with health issues, education, athletics, cultural, social service and public works. Between July, 2013 and April 1, 2017, Alio spent approximately USD 989,000 (54.50 million pesos) on community activities

Alio assisted the community with health-related activities, such as donations of medicine and medical supplies for the local health day and to the local health centre.

Alio sponsored medical seminars, where it provided medical consultations by specialists and medicine free of charge to the local communities. In addition, Alio assisted with a number of other health related activities such as:

- Awareness Program “Fight Against Breast Cancer”.
- Agreement with the Fire Department of Santa Ana for transfers for patients in the community.
- Management for the certification of the community canteens that are provided by the Secretariat of Health.
- Food assistance to the intern from the medical community, Estación Llano.
- A program to assist people with hearing devices, under which Alio provided hearing devices to 10 people in the community.

Alio has assisted educational activities in the community with donations of graduation gifts, cistern construction, school bus repairs and the purchase of trees for the purpose of reforestation in the community. In addition, Alio:

- Continued with the maintenance support for the infrastructure of the kindergarten at Estación Llano; air conditioners for Estación Llano, Ejido El Claro and Santa Ana schools were also provided.
- Equipped a chemistry laboratory in a high school in Santa Ana.
- In coordination with the municipality of Santa Ana, paid for the construction of a roof in a primary school.
- Donated and installed equipment in the Ejido El Claro community for it to be able to have internet service.
- Contributed to equipment for a bus for the Ministry of Education and Culture, for the transportation of students.
- Financed material for the construction of a perimeter fence around the high school in Estación Llano.

- Contributed to universities for the purchase of equipment for the Schools of Geology and Mines.
- Paid for advisers to develop high school open and basic education (ISEA).
- Assisted the local adult community, in coordination with the national employment service and the University of Sonora, in training 25 persons from the community for self-employment.

Alio assisted the community with financial contributions towards the purchase of athletic equipment and team uniforms, travel expenses for local teams, payment of instructor's fees for summer camps in martial arts, music, art, sports and swimming lessons.

Alio supported cultural activities, such as funding for Mother's Day, the Christmas festivities and party for the children of Estación Llano, support for the children's or student's day at the local schools, a water campaign conducted by the city's water agency and payment of teachers for the summer camp.

Financial assistance of social services included donation of a vehicle and mechanical service for the local Estación Llano police officer, funding training for the Fire Department of the Municipality of Santa Ana in the handling of hazardous materials, sponsoring training of a person for the prevention of drugs and alcoholism program, and ambulance support.

Public works support included the donation of electrical cables for the local community's water well, playground repair, construction of cattle fencing and payment for road safety signs. Alio also contributed to public works by undertaking the following:

- Support for drinking water services, by assisting with the necessary replacement of the engines and pumps for wells that provide water to the communities of Estación Llano, Ejido San Diego and Benjamin Hill.
- Supporting access to the communal lands by arranging for the construction of roads.
- Building a local municipal canteen for Estación Llano.
- Working with the city of Santa Ana for the approval of a drainage project, to benefit Estación Llano.
- Conducting the rehabilitation and renovation of the ballpark "Francisco Celaya and Jesus Bracamontes" of Estación Llano.

In addition to the above activities, Alio:

- Made donations and dispensations of Christmas presents and other materials to benefit the municipalities of Santa Ana, Benjamin Hill and Magdalena.
- Provided dispensations to the public canteens of Benjamin Hill.
- Donated groceries to an orphanage located in Imuris, Sonora.
- Made a donation in accordance with an existing agreement with the State DIF.

- Assisted in the organization of festivities in Estación Llano.
- Implemented watering of the streets with greater traffic, to reduce dust contamination.

In 2016, due to its efforts in the area of corporate social responsibility, Alio was awarded for the fifth time with the Company emblem “Socially Responsible” (ESR<sup>®</sup>), which is granted by the Mexican Centre of the Philanthropy (CEMEFI) and the Alliance for Managerial Social Responsibility in Mexico. This recognition is awarded on an annual basis and recognizes companies that are leaders in setting social responsibility standards.

Alio also received several other awards, such as:

- In June, 2016, Alio obtained the “Mexico Without Child Labour” award granted by the Ministry of Labour (STPS), This award is given to companies that demonstrate the implementation of policies to prevent and eradicate child labour.
- In December, 2016, Alio obtained the “Inclusive Company” award which is granted by the Ministry of Labour to companies that demonstrate the implementation of policies designed to enhance the employment of members of minority groups.
- Also, in December, 2016, Alio obtained the renewal of the “Family Responsible Company” distinction, which is granted every two years by the ministry of Labour.

## **20.2 MAGNA ENVIRONMENTAL, SOCIAL AND COMMUNITY ACTIVITIES**

Magna is in the process of restarting operations at the San Francisco mine which will be of immediate benefit to the local community of Estacion Llano, as well as the other regional communities. Magna is planning to continue the social and community activities, as well as maintaining and improving upon the environmental standards that were undertaken by Alio.

The current Magna management is familiar with the San Francisco Project through their time working previously for Alio. Micon and its QP believe that this will be beneficial in understanding the needs and concerns of the local and regional communities as the mining restarts and as exploration programs are conducted on other parts of the property.

Magna will conduct such reclamation and rehabilitation as may be necessary on those portions of the San Francisco Project where mining activities have been completed during the operational phase of the mine. This will mitigate any residual closure liability such that, at the end of the mine life, all remaining costs may be covered by the scrap value of the plant and other infrastructure.

## 21.0 CAPITAL AND OPERATING COSTS

Magna has estimated the forecast capital and operating costs for the Project, and Micon has reviewed those forecasts for reasonableness. The basis for Magna's assessment of the capital and operating costs is described in more detail below. All estimates are expressed in second quarter 2020 United States dollars, without escalation. The expected accuracy of the estimates is  $\pm 20\%$ .

### 21.1 CAPITAL COSTS

Given that the mine, processing plant and infrastructure at San Francisco mine are already established, there is no significant capital investment required in order to bring the Project back in operation.

Provision is made for additional heap leach pad area to be built in seven annual phases, at a unit cost rate of \$0.30/t heaped capacity. In addition, a provision is made for replacement or refurbishment of existing equipment, in the sum of \$100,000 per month over the LOM period. During the first 4 months after startup, this allowance is increased to a total of \$0.75 million.

Total capital costs are forecast as shown in Table 21.1

**Table 21.1**  
Capital Cost Summary

Area	Initial (Yr.1) Capital (\$M)	Sustaining (Yrs 2-8) Capital (\$M)	LOM Total Capital (\$M)
Leach Pad extensions	1.86	11.65	13.51
Equipment replacement	1.55	8.10	9.65
<b>Total</b>	<b>3.41</b>	<b>19.75</b>	<b>23.16</b>

### 21.2 OPERATING COSTS

Estimated cash operating costs over the life of the project are summarized in Table 21.2.

**Table 21.2**  
Summary of Life-of-Mine Operating Costs

Area	Life-of-Mine Cost (\$ 000)	Unit Cost \$/t ore milled	Unit Cost \$/oz Gold
Mining	353.79	\$7.43	672
Processing	211.93	\$4.45	402
General & Administrative	27.68	\$0.58	53
Selling costs	1.32	\$0.03	3
<b>Cash Operating Costs</b>	<b>594.72</b>	<b>\$12.49</b>	<b>1,129</b>
Royalties and Mining Tax	16.28	\$0.34	31
<b>Total Cash Cost</b>	<b>611.00</b>	<b>\$12.83</b>	<b>1,160</b>

### **21.2.1 Mine Operating Costs**

Open pit mining costs are based on contracted rates for drill, blast, load and haul.

For the San Francisco pit, a unit rate of \$1.59/t applies for material hauled for a distance of up to 2,800 m. Thereafter, over-haul charges of \$0.18/t.km are imposed. Additional provision is made in the cost estimate for usage of diesel fuel, and for explosives and accessories, as well as mine technical and supervisory staff. The LOM average unit cost is \$2.18 per tonne mined.

For La Chicharra pit, a unit rate of \$1.30/t applies for material hauled for a distance of up to 1,100 m. Thereafter, over-haul charges of \$0.18/t.km are imposed. Additional provision is made in the cost estimate for usage of diesel fuel, and for explosives and accessories. The LOM average unit cost is \$1.82 per tonne mined.

During year 1, approximately 110,500 t are scheduled to be mined from underground. The established open pit contractor will also undertake this work, for which a provision of \$40/t has been made. This estimate is based on unit rates agreed with the contractor and including indirect costs.

Rehandling of approximately 782,000 tonnes of stockpiled material to the crusher during the first six months of operation is also provided for, in the amount of \$1.06/t rehandled.

### **21.2.2 Processing Operating Costs**

Operating costs for crushing, heaping and leaching of ore, and operation of the ADR plant for production of gold/silver doré bars, is estimated at an average of \$4.34/t treated at steady state. The amount includes provision for the leaching of residual gold from the heap during the first 19 months from restarting of operations.

The average operating cost of \$4.34/t of ore is broken down as follows; crushing: \$1.72/t, leaching: \$1.92/t, ADR plant: \$0.40/t, assay laboratory: USD 0.24/t and metallurgy: \$0.07/t.

### **21.2.3 General and Administration Costs**

General and administrative costs are treated as a fixed cost item at \$3.5 million per year.

### **21.2.4 Selling Costs**

Selling costs for doré bars are estimated at \$2.50/oz payable gold.

## 22.0 ECONOMIC ANALYSIS

### 22.1 CAUTIONARY STATEMENT

The results of the economic analyses discussed in this section represent forward-looking information as defined under Canadian securities law. The results depend on inputs that are subject to a number of known and unknown risks, uncertainties and other factors that may cause actual results to differ materially from those presented here.

Information that is forward-looking includes:

- Mineral Resource and Mineral Reserve estimates;
- Assumed commodity prices and exchange rates;
- The proposed mine production plan;
- Projected mining and process recovery rates;
- Assumptions as to mining dilution;
- Capital and operating cost estimates and working capital requirements;
- Assumptions as to closure costs and closure requirements;
- Assumptions as to environmental, permitting and social considerations and risks.

Risks associated with to the forward-looking information include:

- Changes to costs of production from what is assumed;
- Unrecognized environmental risks;
- Unanticipated reclamation expenses;
- Unexpected variations in quantity of mineralized material, grade or recovery rates;
- Geotechnical or hydrogeological considerations differing from what was assumed;
- Failure of mining methods to operate as anticipated;
- Failure of plant, equipment or processes to operate as anticipated;
- Changes to assumptions as to the availability and cost of electrical power and process reagents;
- Ability to maintain the social licence to operate;
- Accidents, labour disputes and other risks of the mining industry;
- Changes to interest rates;
- Changes to tax rates and availability of allowances for depreciation and amortization.



## **22.2 BASIS OF EVALUATION**

Micon has prepared its assessment of the Project on the basis of a discounted cash flow model, from which Net Present Value (NPV) can be determined. Assessments of NPV are generally accepted within the mining industry as representing the economic value of a project, after allowing for the cost of capital invested.

The objective of the study was to determine the viability of the proposed restart of the San Francisco mine, heap-leaching facility and ADR plant. In order to do this, the cash flow arising from the base case has been forecast, enabling a computation of the NPV to be made. The sensitivity of this NPV to changes in the base case assumptions is then examined.

## **22.3 MACRO-ECONOMIC ASSUMPTIONS**

### **22.3.1 Exchange Rate and Inflation**

All results are expressed in United States dollars. Cost estimates and other inputs to the cash flow model for the Project have been prepared using constant, second quarter 2020 money terms, i.e., without provision for escalation or inflation.

### **22.3.2 Weighted Average Cost of Capital**

In order to find the NPV of the cash flows forecast for the Project, an appropriate discount factor must be applied which represents the weighted average cost of capital (WACC) imposed on the Project by the capital markets. The cash flow projections used for the evaluation have been prepared on an all-equity basis. This being the case, WACC is equal to the market cost of equity.

In this case, Micon has selected an annual discount rate of 5%/year for its base case, and has tested the sensitivity of the Project to changes in this rate.

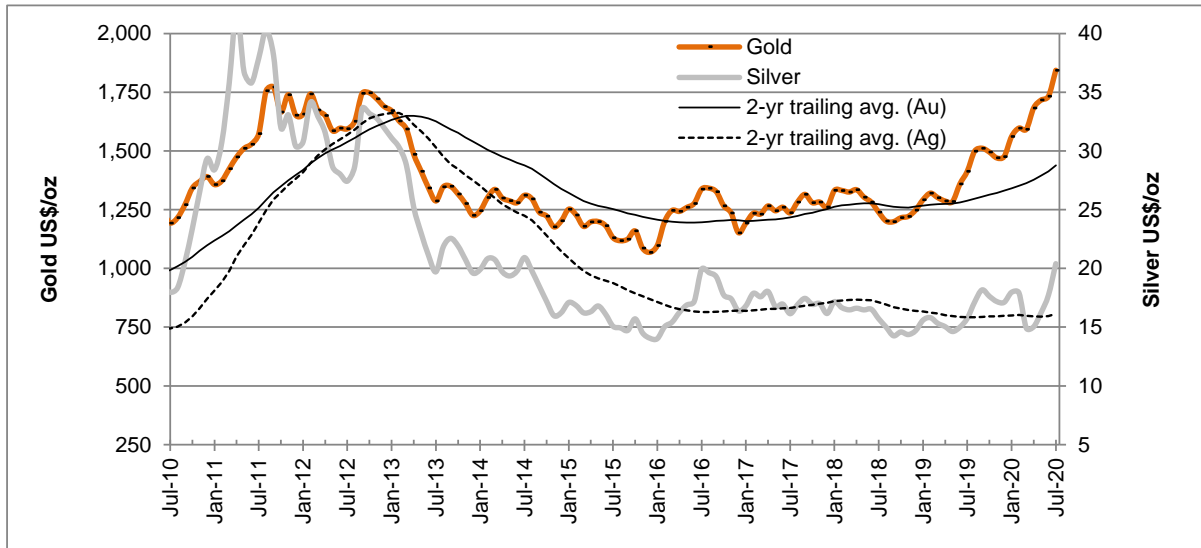
### **22.3.3 Expected Metal Prices**

Project revenues will be generated from the sale of gold/silver doré bars. However, for the purpose of this evaluation, only the value of the gold content has been considered.

The Project has been evaluated using a constant gold price of \$1,450/oz. While below current market levels, the forecast gold price approximates the average achieved over the past 24 months.

Figure 22.1 presents monthly average prices for gold and silver over the past ten years, and shows the upward trend in the average price over the past two years.

**Figure 22.1  
Ten Year Price History**



#### 22.3.4 Taxation Regime

Mexican federal corporate income and mining taxes have been allowed for.

A tax credit of \$3.60 million is taken into consideration to off-set income tax payable at the rate of 30%. Capital depreciation allowances of approximately \$17.50 million are also taken into account over the LOM period.

#### 22.3.5 Royalty

State royalty on gold sales of 0.5%, as well as a royalty of 1.0% to previous owners of the property, have been provided for in the cash flow model.

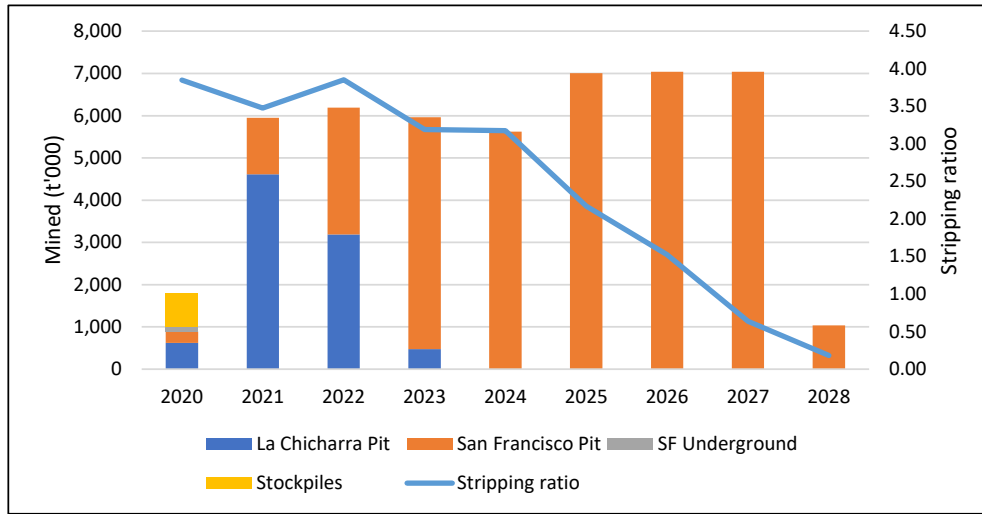
### 22.4 TECHNICAL ASSUMPTIONS

The technical parameters, production forecasts and estimates described earlier in this report are reflected in the base case cash flow model. These inputs to the model are summarized below.

#### 22.4.1 Mine Production Schedule

Figure 22.2 shows the annual tonnages of ore placed on the leach pad from each source, together with the overall waste stripping ratio.

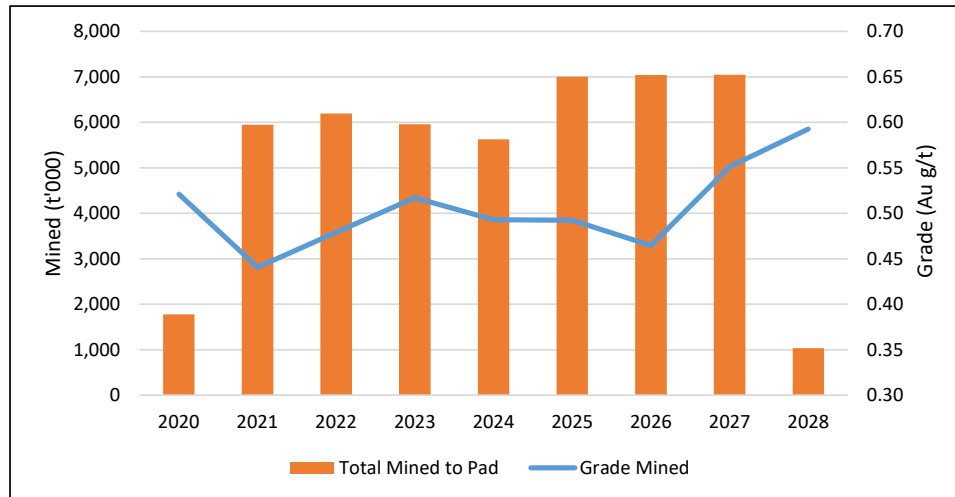
**Figure 22.2**  
**Mining Production Schedule**



### 22.4.2 Processing Schedule

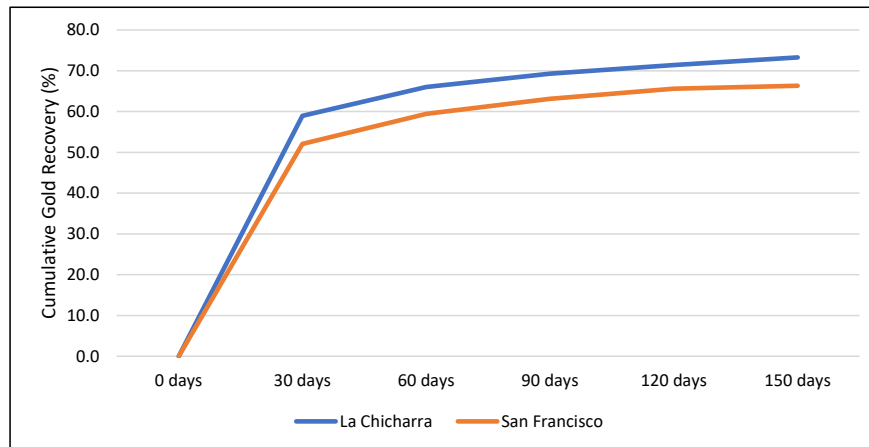
The annual tonnage and average grade of material placed on the leach pad is shown in Figure 22.3.

**Figure 22.3**  
**LOM Grade Profile**



The processing and gold production schedule takes into account the respective leach kinetics and ultimate gold recovery from La Chicharra and San Francisco material. In order to account for any delay in bringing mined material under leach, processing is assumed to start at the beginning of the following month, with gold being recovered from that material over the following five months, as shown in Figure 22.4

**Figure 22.4**  
**La Chicharra and San Francisco Heap Leach Profiles**



### 22.4.3 Project Cash Flow

The LOM base case project cash flow is presented in Table 22.1. Annual cash flows are set out in Table 22.2 and summarized in Figure 22.5.

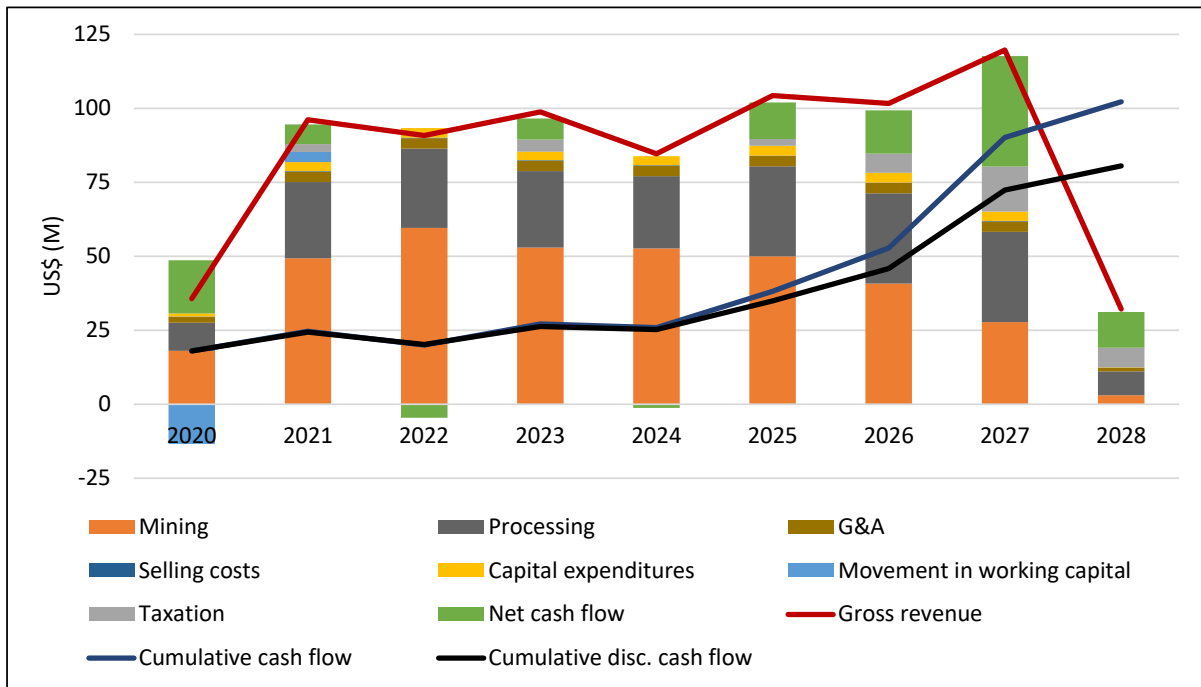
**Table 22.1**  
**Life-of-Mine Cash Flow Summary**

	LOM Total \$'000	USD/t Treated	USD/oz Au
<b>Gross Revenue</b>	<b>763.64</b>	<b>\$16.03</b>	<b>1,450</b>
Mining costs	353.79	\$7.43	672
Processing costs	211.93	\$4.45	402
General & administrative costs	27.68	\$0.58	53
Selling expenses	1.32	\$0.03	3
<b>Cash operating cost</b>	<b>594.72</b>	<b>\$12.49</b>	<b>1,129</b>
Royalties & mining tax	16.28	\$0.34	31
<b>Total Cash Cost</b>	<b>611.00</b>	<b>\$12.83</b>	<b>1,160</b>
Net profit before tax	152.64	\$3.20	290
Taxation	37.24	\$0.78	71
<b>Net profit after tax</b>	<b>115.40</b>	<b>\$2.42</b>	<b>219</b>
Capital expenditure	23.16	\$0.49	44
Movement in working capital	(9.95)	(\$0.21)	(19)
<b>Net Cash flow after tax</b>	<b>102.20</b>	<b>\$2.15</b>	<b>194</b>
Cash Operating Cost per ounce			1,129
Total Cash Cost per ounce			1,160
All-in Sustaining Cost per ounce			1,204

**Table 22.2**  
**Base Case Life-of-Mine Annual Cash Flow**

Period	LOM Total	2020	2021	2022	2023	2024	2025	2026	2027	2028
Gold Sales (koz)	526.65	24.57	66.27	62.64	68.13	58.34	71.89	70.07	82.56	22.19
Gross revenue (USD '000)	763.64	35.63	96.09	90.83	98.78	84.59	104.24	101.60	119.72	32.17
Mining	353.79	17.99	49.28	59.53	52.93	52.66	49.97	40.70	27.69	3.04
Processing	211.93	9.56	25.80	26.86	25.86	24.40	30.38	30.53	30.55	7.99
G&A	27.68	2.01	3.50	3.50	3.50	3.50	3.50	3.50	3.50	1.17
Selling costs	1.32	0.06	0.17	0.16	0.17	0.15	0.18	0.18	0.21	0.06
Cash Operating Costs	594.72	29.62	78.75	90.05	82.46	80.71	84.03	74.91	61.95	12.25
Royalties & Mining Tax	16.28	0.40	1.52	2.19	2.24	2.14	2.27	2.34	2.11	1.08
Total Cash Costs (USD'000)	611.00	30.02	80.27	92.24	84.70	82.85	86.30	77.24	64.05	13.33
Net Profit before tax	152.64	5.60	15.82	(1.41)	14.08	1.74	17.95	24.35	55.66	18.84
Taxation	37.24	0.00	2.63	0.00	4.12	0.00	2.29	6.39	15.21	6.60
Net Profit after tax	115.40	5.60	13.19	(1.41)	9.97	1.74	15.65	17.96	40.46	12.24
Capital expenditures	23.16	1.05	3.06	3.22	2.83	3.06	3.31	3.31	3.10	0.20
Movement in working capital	(9.95)	(13.40)	3.45	0.00	0.00	0.00	0.00	0.00	0.00	0.00
Net cash flow	102.20	17.95	6.68	(4.63)	7.14	(1.33)	12.34	14.65	37.36	12.04
Cumulative cash flow		17.95	24.63	20.00	27.14	25.81	38.15	52.80	90.16	102.20
Discounted cash flow at 5%	80.49	17.95	6.36	(4.20)	6.16	(1.09)	9.67	10.93	26.55	8.15
Cumulative disc. cash flow		17.95	24.32	20.12	26.28	25.19	34.86	45.79	72.34	80.49
<b>Net Present Value (USD'000)</b>	<b>80.49</b>									
<b>Internal Rate of Return</b>	<b>n/a</b>	<i>NB - there must be a negative cash flow to enable IRR to be calculated</i>								
Cash Operating Cost(\$ per ounce)	1,129	1,206	1,188	1,438	1,210	1,384	1,169	1,069	750	552
Total Cash Cost (\$ per ounce)	1,160	1,222	1,211	1,472	1,243	1,420	1,200	1,102	776	601
All-in Sustaining Cost (\$ per ounce)	1,204	1,265	1,257	1,524	1,285	1,473	1,246	1,150	813	610

**Figure 22.5**  
**Life-of-Mine Cash Flows**



Working capital shows a net negative balance over the LOM because it includes cash, available as a contingency at the restart, which should later be released from the operation.

The after-tax cash flows, discounted at the rate of 5% per year, evaluate to a net present value (NPV<sub>5</sub>) of \$80.5 million. Owing to the absence of an initial negative cash flow, it is not possible to calculate an internal rate of return or payback period for the project.

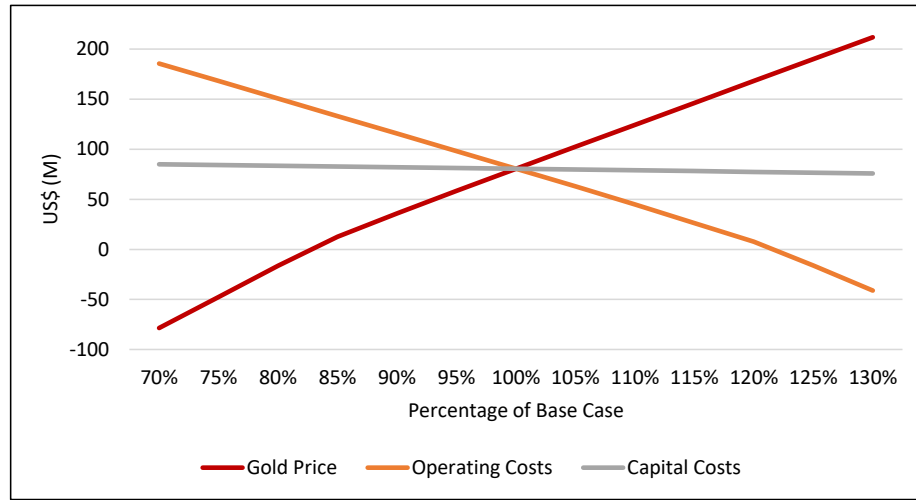
## 22.5 SENSITIVITY STUDY AND RISK ANALYSIS

### 22.5.1 Metal Price and Exchange Rate Assumptions

Micon tested the sensitivity of the after-tax NPV<sub>5</sub> to changes in metal price, operating costs and capital investment for a range of 30% above and below base case values. The impact on Project NPV<sub>5</sub> to changes in other revenue drivers such as gold grade of material treated and the percentage recovery of gold from processing is equivalent to gold price changes of the same magnitude, so these factors can be considered as equivalent to the price sensitivity.

Figure 22.6 shows the results of changes in each factor separately. The chart demonstrates that the project is most sensitive to gold price, with a reduction of 17.5% giving rise to NPV<sub>5</sub> of close to zero. The project is slightly less sensitive to operating costs, with an increase of more than 21% required to reduce NPV<sub>5</sub> to near-zero. Unsurprisingly, given the relatively small capital costs required to restart the mine, NPV<sub>5</sub> is reduced by less than \$5 million for an increase of 30% in capital cost.

**Figure 22.6**  
**Sensitivity to Capital, Operating Costs and Gold Price**



Separately, Micon also tested the sensitivity of the Project NPV<sub>5</sub> for specific gold prices above and below the base case price of \$1,450/oz. Table 22.3 shows the results of this exercise, which demonstrates that a \$50/oz change in the gold price results in a change of approximately \$15 million in NPV<sub>5</sub>.

**Table 22.3**  
**Sensitivity of NPV<sub>5</sub> to Gold Price**

Gold Price (USD/oz)	NPV <sub>5</sub> (USDM)
1,200	1.45
1,250	18.65
1,300	34.52
1,350	50.23
1,400	65.39
<b>1,450</b>	80.49
1,500	95.58
1,550	110.66
1,600	125.69
1,650	140.71
1,700	155.73
1,750	170.75
1,800	185.76
1,850	200.78
1,900	215.79
1,950	230.79
2,000	245.79

In August, 2020 gold prices reached a high of more than \$2,050/oz, and the average price for the month was above \$1,950/oz.

## 22.6 CONCLUSION

Micon concludes that, based on the forecast production, capital and operating costs presented in this study, the Project demonstrates an all-in sustaining cost (AISC) of \$1,204/oz, and that reopening the San Francisco mine represent a viable project at gold prices above \$1,250/oz.



### 23.0 ADJACENT PROPERTIES

The information for this Section was extracted from the May 25, 2017, Technical Report. There have been no material changes to this Section since the publication of the May 25, 2017 Technical Report.

The San Francisco property exists within the Sierra Madre Occidental metallogenic province and is known to host a number of separate zones or showings of anomalous gold mineralization. There are other metallic mineral deposits in the area, but very little information is available on those properties. There are no immediately adjacent properties which directly affect the interpretation and evaluation of the mineralization or anomalies found at San Francisco. However, the 1995 San Francisco Property Reserve and Resource document by Mine Development Associates of Reno, Nevada, listed a number of exploration possibilities in the immediate area of the mine that are not on the San Francisco property.

Among the targets which remain is the bedrock area surrounding the Arroyo La Perra, a placer deposit located approximately 2 km northwest of the San Francisco pit. The 1995 report mentions that seven holes had been drilled in bedrock to that point and that one of the holes intersected 8 m of 1.6 g/t gold at 42.5 m down-hole, while another intersected 18 m of 0.422 g/t gold at 4 m down-hole. Other targets mentioned with fair to good exploration potential for the discovery of significant gold deposits were La Desconocida, Casa de Piedras Oeste and La Trinchera, all of which are located between 2 km to 5 km northwest of the San Francisco pit.

Micon has not verified the information regarding the adjacent mineral deposits and showings described above that are outside the immediate area of the San Francisco and La Chicharra pits. The information contained in this section of the report, which was provided by Alio, is not necessarily indicative of the mineralization at the San Francisco Project.

## **24.0 OTHER RELEVANT DATA AND INFORMATION**

All relevant data and information regarding the San Francisco Project are included in other sections of this Technical Report.

Micon is not aware of any other data that would make a material difference to the quality of this Technical Report or make it more understandable, or without which the report would be incomplete or misleading.

## 25.0 INTERPRETATION AND CONCLUSIONS

### 25.1 OVERVIEW

Magna has acquired the San Francisco Project and is in the process of restarting the mining operations. As part of its restart Magna has been re-evaluating the previous operations and exploration activities.

The current Magna management personnel are familiar with both the previous operations and exploration potential as they were former employees of Timmins/Alio, the previous operator. The San Francisco operation will benefit from their knowledge.

### 25.2 MINERAL RESOURCES, MINERAL RESERVES AND PRODUCTION SCHEDULE

Using the drilling and assay database acquired from Alio, Magna has estimated the remaining mineral resources and mineral reserves at the San Francisco property, as follows:

- San Francisco mine, open pit resources:
  - Measured and Indicated: 72.5 million tonnes at an average grade of 0.426 grams of gold per tonne, containing 992,000 ounces of gold.
  - Inferred: 10.4 million tonnes at an average grade of 0.465 grams of gold per tonne, containing 155,000 ounces of gold.
- San Francisco mine, underground resources:
  - Measured and Indicated: 347,000 tonnes at an average grade of 3.988 grams of gold per tonne, containing 44,000 ounces of gold.
- La Chicharra, open pit resources:
  - Measured and Indicated: 27 million tonnes at an average grade of 0.455 grams of gold per tonne, containing 393,000 ounces of gold.
  - Inferred: 0.99 million tonnes at an average grade of 0.488 grams of gold per tonne, containing 16,000 ounces of gold.
- Total resources:
  - Measured and Indicated: 100 million tonnes at an average grade of 0.446 grams of gold per tonne, containing 1.43 million ounces of gold.
  - Inferred: 11.4 million tonnes at an average grade of 0.467 grams of gold per tonne, containing 171,000 ounces of gold.

Micon is not aware of any environmental, permitting, legal, title, taxation, socio-economic, marketing or political issues which would adversely affect the mineral resources estimated above. However, mineral resources that are not mineral reserves do not have demonstrated economic viability.

The mineral resource have been rounded to reflect that they are estimates and, therefore, the addition may not sum in the table.

Based on the above resources and mine designs at a pre-feasibility study level of detail, Magna has restimated the remaining proven and probable reserves at the San Francisco Property to be as follows:

- San Francisco mine, open pit reserves: 38 million tonnes at an average grade of 0.494 grams of gold per tonne, containing 602,000 ounces of gold.
- San Francisco mine, underground reserves: 111,000 tonnes at an average grade of 4.089 grams of gold per tonne, containing 15,000 ounces of gold.
- La Chicharra, open pit reserves: 8.9 million tonnes at an average grade of 0.475 grams of gold per tonne, containing 136,000 ounces of gold.
- Total reserves: 46.8 million tonnes at an average grade of 0.499 grams of gold per tonne, containing 752,000 ounces of gold.

Magna has scheduled these reserves to be mined and heap leached over a period of approximately eight years. At an average heap leach recovery of 66% for material mined from San Francisco and 73% for material mined from La Chicharra, total life-of-mine gold production is estimated at approximately 530,000 ounces of gold.

Micon has audited Magna's resource and reserve estimates and considers them to have been prepared in accordance with the CIM standards and definitions for mineral resources and reserves. Micon has also reviewed with care Magna's mine design and mine and heap leach production schedules and considers them to be at a level of detail appropriate for a pre feasibility study.

## **25.3 PROJECT ECONOMICS**

### **25.3.1 Capital and Operating Costs**

Magna has prepared estimates of life-of-mine capital expenditures and operating costs, in constant US dollars of second quarter 2020 value. Micon has reviewed these estimates and considers them appropriate for a pre-feasibility study, with an assessed level of accuracy of  $\pm 20\%$ .

Given that mining is being undertaken by a contractor, future capital expenditures will be limited principally to leach pad expansions and the replacement of certain equipment. Life-of-mine capital expenditures are estimated at approximately USD 23 million.

Operating costs, as summarized in Table 25.1, are estimated at USD 12.83 per tonne of ore mined. Cash operating costs are estimated at USD 1,129 per ounce of gold produced, and total cash costs are estimated at USD 1,160/oz. All-in sustaining costs are estimated at \$1,204 per ounce of gold.

**Table 25.1**  
**Summary of Life-of-Mine Operating Costs**

Area	Life-of-Mine Cost (\$ 000)	Unit Cost \$/t ore milled	Unit Cost \$/oz Gold
Mining	353.79	\$7.43	672
Processing	211.93	\$4.45	402
General & Administrative	27.68	\$0.58	53
Selling costs	1.32	\$0.03	3
Cash Operating Costs	594.72	\$12.49	1,129
Royalties and Mining Tax	16.28	\$0.34	31
<b>Total Cash Cost</b>	<b>611.00</b>	<b>\$12.83</b>	<b>1,160</b>

### 25.3.2 Economic Analysis

Micon has evaluated the overall economics of the San Francisco Project by conventional discounted cash flow techniques, using a gold price of USD 1,450 per ounce and a discount rate of 5% per year. As summarized in Table 25.2, the Project is estimated to yield an after-tax net present value of USD 80.5 million.

Sensitivity analysis shows that project economics are most sensitive to variations in the factors that affect revenue. A combined adverse change in gold price, mined grade and metallurgical recovery would reduce revenue by 17.5% would result in the net present value at a discount rate of 5% per year falling to close to zero.

### 25.3.3 Economic Conclusion

Micon concludes that, based on the forecast production, capital and operating costs presented in this study, the Project demonstrates an all-in sustaining cost of \$1,204/oz, and that reopening the San Francisco mine represents a viable project at gold prices above \$1,250/oz.

**Table 25.2**  
**Base Case Life-of-Mine Annual Cash Flow**

Period	LOM Total	2020	2021	2022	2023	2024	2025	2026	2027	2028
Gold Sales (koz)	526.65	24.57	66.27	62.64	68.13	58.34	71.89	70.07	82.56	22.19
Gross revenue (USD '000)	763.64	35.63	96.09	90.83	98.78	84.59	104.24	101.60	119.72	32.17
Mining	353.79	17.99	49.28	59.53	52.93	52.66	49.97	40.70	27.69	3.04
Processing	211.93	9.56	25.80	26.86	25.86	24.40	30.38	30.53	30.55	7.99
G&A	27.68	2.01	3.50	3.50	3.50	3.50	3.50	3.50	3.50	1.17
Selling costs	1.32	0.06	0.17	0.16	0.17	0.15	0.18	0.18	0.21	0.06
Cash Operating Costs	594.72	29.62	78.75	90.05	82.46	80.71	84.03	74.91	61.95	12.25
Royalties & Mining Tax	16.28	0.40	1.52	2.19	2.24	2.14	2.27	2.34	2.11	1.08
Total Cash Costs (USD'000)	611.00	30.02	80.27	92.24	84.70	82.85	86.30	77.24	64.05	13.33
Net Profit before tax	152.64	5.60	15.82	(1.41)	14.08	1.74	17.95	24.35	55.66	18.84
Taxation	37.24	0.00	2.63	0.00	4.12	0.00	2.29	6.39	15.21	6.60
Net Profit after tax	115.40	5.60	13.19	(1.41)	9.97	1.74	15.65	17.96	40.46	12.24
Capital expenditures	23.16	1.05	3.06	3.22	2.83	3.06	3.31	3.31	3.10	0.20
Movement in working capital	(9.95)	(13.40)	3.45	0.00	0.00	0.00	0.00	0.00	0.00	0.00
Net cash flow	102.20	17.95	6.68	(4.63)	7.14	(1.33)	12.34	14.65	37.36	12.04
Cumulative cash flow		17.95	24.63	20.00	27.14	25.81	38.15	52.80	90.16	102.20
Discounted cash flow at 5%	80.49	17.95	6.36	(4.20)	6.16	(1.09)	9.67	10.93	26.55	8.15
Cumulative disc. cash flow		17.95	24.32	20.12	26.28	25.19	34.86	45.79	72.34	80.49
<b>Net Present Value (USD'000)</b>	<b>80.49</b>									
<b>Internal Rate of Return</b>	<b>n/a</b>	<i>NB - there must be a negative cash flow to enable IRR to be calculated</i>								
Cash Operating Cost(\$ per ounce)	1,129	1,206	1,188	1,438	1,210	1,384	1,169	1,069	750	552
Total Cash Cost (\$ per ounce)	1,160	1,222	1,211	1,472	1,243	1,420	1,200	1,102	776	601
All-in Sustaining Cost (\$ per ounce)	1,204	1,265	1,257	1,524	1,285	1,473	1,246	1,150	813	610

## 26.0 RECOMMENDATIONS

Magna has completed its acquisition of the San Francisco Project from Alio. Magna has begun to re-establish mining at the San Francisco Project by starting to process the remaining low-grade stockpile material, as well as restarting mining operations at the La Chicharra pit. Magna is planning to mine the higher grade material in the south wall of the San Francisco pit using underground mining methods.

### 26.1 MAGNA EXPLORATION BUDGETS

In addition to bringing the mining operations back into production Magna is also in the process of outlining and budgeting exploration activities in three areas of the San Francisco property as follows:

1. San Francisco mine (San Francisco and La Chicharra Pits).
2. Vetatierra Project.
3. La Pima Project.

#### 26.1.1 San Francisco Mine (San Francisco and La Chicharra Pits) 2020-2021 Exploration Program

In order to ensure the continuity of the operations within the San Francisco and La Chicharra pits, Magna has designed a reverse circulation drill program comprised of both infill and exploration holes at specific sites in and around both pits. The program is based on the down dip projections of the mineralized zones, using the accumulated data gathered from the years of exploration and operational drilling and mining of the San Francisco mine, and a gold price of USD 1,350/oz of gold. Based on these data, a drill program was designed to test the extension of the mineralization and/or the connection between different mineralized intercepts within the perimeter of the down dip interpretation, as well as focusing on connecting smaller neighbouring mineralized areas. A program of infill drilling has also been outlined in and around the crushing circuit, to examine the feasibility of relocating the circuit and thereby potentially allowing the mining of the mineral resources currently located under it.

This drill program consists of a total of 46,250 m distributed in 290 RC drill holes.

In addition to the program outlined above, Magna is scheduled to conduct a core drill program on the south wall of the San Francisco pit, specifically on Phase 7A of the mine plan. The drill program is targeted to further outline the repetitive high gold grade drill intercepts encountered in past drilling campaigns which appear to be related to the vein system located at the San Francisco and El Carmen areas of the Project. This vein system was the origin of the mining at the San Francisco Project, when small scale underground mine workings were developed along high gold grade material during the early 1940s.

The Magna drill program will be comprised of approximately 4,000 m in 38 short core holes.

Table 26.1 summarizes the estimated budget for the 2020-2021 infill and exploration drilling programs at the San Francisco Project.

**Table 26.1**  
**Estimated Budget for the 2020-2021 Infill and Exploration Drilling Programs at the San Francisco Project**

Description	Unit	Unit Cost (USD)	No. Units	Total Cost (USD)
<b>Geology and exploration</b>				
Project management	Month	12,000	12	144,000
Geologist (salaries and consulting fees)	Month	30,000	12	360,000
Field hands	Month	9,000	12	108,000
Camp, foods and accommodation	Month	2,500	12	30,000
Exploration expenses and supplies	Lump	5,000	2	10,000
Reverse circulation drilling	Metre	46,250	55	2,543,750
Core drilling	Metre	4,000	90	360,000
Assaying for gold (external, prep and assay)	Samples	41,875	11	460,625
Geochemical assays (multielements)				-
Engineering and feasibility	Lump	50,000	1	50,000
Metallurgical testwork	Lump	50,000	1	50,000
Drafting, reporting, reproduction, maps	Lump	2,500	12	30,000
Hardware and software (maintenance and new one)	Lump	30,000	1	30,000
Logistic exploration support	Lump	2,000	12	24,000
Vehicle renting	3	6,000	12	72,000
Gasoline and maintenance	Lump	2,100	12	25,200
Travel expenses				-
Safety equipment	Lump	900	12	10,800
Social security and labour related taxes	Estimated	612,000	10%	61,200
<b>Total exploration and administration</b>				<b>4,369,575</b>

Table provided by Magna, August, 2020.

### 26.1.2 Vetatierra Project 2020 Exploration Program

In 2014, Alio carried out a geological exploration program comprised of mapping, sampling of rock chips in trenches and finally a drill program of 5 core holes and 4 reverse circulation holes drilled along a single line coincident with the best gold values obtained from the existing outcrops and from other holes on the site where sampling identified interesting gold values. The most important mineralized intersection occurred in drill hole VT14-002, with an interval of 33.85 m grading 1.28 g/t Au, including 22.40 m of 1.87 g/t Au and 12.50 m of 3.26 g/t Au. The 2014 drilling suggests that the majority of the mineralization is hosted in a diorite stock which is very poorly exposed.

Magna has proposed an initial 2,000 m drilling program to define the continuity of the mineral intercepts from the previous campaign, to explore the potential lateral extension of the gold mineralization detected during the previous drilling program and to gain a better understanding of the diorite geometry at depth.

Table 26.2 summarizes the budget for the 2020 exploration program at the Vetatierra Project.



**Table 26.2**  
**Estimated Budget for the 2020 Exploration Program at the Vetatierra Project**

Description	Unit	Unit Cost (USD)	No. Units	Total Cost (USD)
<b>Geology and exploration</b>				
Project management	Month	5,000	3	15,000
Geologist (salaries and consulting fees)	Month	25,000	3	75,000
Field hands	Month	9,000	3	27,000
Camp, foods and accommodation	Month	2,500	3	7,500
Exploration expenses and supplies	Lump	5,000	1	5,000
Reverse circulation drilling	Metre	2,000	55	110,000
Core drilling		-		-
Assaying for gold (external, prep and assay)	Samples	1,667	18	30,000
Geochemical assays (multielements)		1,667	12	20,004
Geophysical supervising (IP-R, CSAMT)	Lump	50,000	1	50,000
Drafting, reporting, reproduction, maps	Month	900	3	2,700
Logistic exploration support				-
Vehicle renting	Vehicle	4,000	3	12,000
Gasoline and maintenance	Lump	2,100	3	6,300
Safety equipment	Lump	900	3	2,700
Social security and labour related taxes	Lump	115,000	0	11,500
<b>Total exploration and administration</b>				<b>374,704</b>

Table provided by Magna, August, 2020.

### 26.1.3 La Pima Project 2020 Exploration Program

The mineralization at the La Pima Project is related to structurally controlled hydrothermal Ba-Ca-Ag-Pb-Zn breccias, replacements and in-filling fractures with over a 2.5 km strike length which are hosted in fossiliferous limestones of the Cretaceous age. Artisanal mines and diggings have been developed within the limestone up to a depth of 60 m.

Along the mineralized trend four targets have been delineated, with two of them, Pima mine target (PMT) and West target (WT), having high silver values.

Magna has proposed conducting additional exploration at the La Pima Project that includes a geophysical survey using either IP-R or CSAMT and a core drilling program. The geophysical survey will initially consist of two lines to obtain response features of the host rock at depth and the continuity of the main structures. Depending on the initial results, additional lines could be required to assist with designing the drill plan.

Magna is in the process of scheduling a core drilling program of 3,000 m distributed across different targets within the Project area.

Table 26.3 summarizes the budget for the 2020 exploration program at the La Pima Project.

**Table 26.3**  
**Estimated Budget for the 2020 Exploration Program at the La Pima Project**

Description	Unit	Unit Cost (USD)	No. Units	Total Cost (USD)
<b>Geology and exploration</b>				
Project management	Month	5,000	4	20,000
Geologist (salaries and consulting fees)	Month	25,000	4	100,000
Field hands	Month	9,000	4	36,000
Camp, foods and accommodation	Month	2,500	4	10,000
Exploration expenses and supplies	Lump	2,500	1	2,500
Reverse circulation drilling	Metre	-		-
Core drilling	Metre	3,000	90	270,000
Assaying for silver and multielements (external, prep and assay)	Samples	3,000	16	48,000
Geochemical assays (multielements)				-
Geophysical supervising (IP-R, CSAMT)	Lump	60,000	1	60,000
Drafting, reporting, reproduction, maps	Month	900	4	3,600
Logistic exploration support				-
Vehicle renting	Vehicle	4,000	4	16,000
Gasoline and maintenance	Lump	2,100	4	8,400
Safety equipment	Lump	900	4	3,600
Social security and labour related taxes	Lump	272,500	0	27,250
<b>Total exploration and administration</b>				<b>605,350</b>

Table provided by Magna, August, 2020.

Table 26.4 summarizes total expenditures for Magna's exploration programs for 2020 and 2021 for the three focus areas on the San Francisco property.

**Table 26.4**  
**Total Estimated Exploration Expenditures for Magna's Three Focus Areas on the San Francisco Property**

Year	Area	Expenditures (USD)
2020 - 2021	San Francisco Mine (San Francisco and La Chicharra Pits)	4,369,575
2020	Vetatierra Project	374,704
2020	La Pima Project	605,350
<b>Total</b>		<b>5,349,629</b>

Table provided by Magna, August, 2020.

Micon has reviewed the exploration budgets proposed by Magna for each of the three areas on the San Francisco property and recommends that Magna proceed with the budget as proposed, subject to funding and other operational changes that may arise.

Given the prospective nature of the property, it is Micon's opinion, and that of its QP, that the San Francisco Project and surrounding property merits further exploration with the objective of identifying additional mineralized zones with the potential to extend Project life.

## 26.2 FURTHER RECOMMENDATIONS

Micon agrees with the general direction of Magna's exploration and development program for the property and makes the following additional recommendations:

1. Magna should improve the mineralization wireframes for San Francisco and La Chicharra from being a series of extruded flat polygons to full 3D wireframes which would better define the mineralization boundaries.
2. Magna should do the assay compositing for both San Francisco and La Chicharra within the mineralization wireframes intercepts, instead of compositing the entire hole from collar to toe; this will potentially lead to higher average grades and improve the interpolation results.
3. Magna should continue the practice of ongoing column leach testwork on-site, using samples that represent future planned mining areas and potential new mineral resources identified during exploration. The data gleaned from this work will improve the understanding of the various mineralization types and help optimize the recovery of gold.

## 27.0 DATE AND SIGNATURE PAGES

MICON INTERNATIONAL LIMITED

*“William J. Lewis” {signed and sealed as of the report date}*

William J. Lewis, P.Geo.  
Senior Geologist

Report Date: August 28, 2020  
Effective Date: August 8, 2020

*“Richard Gowans” {signed and sealed as of the report date}*

Richard M. Gowans, P.Eng.  
President and Principal Metallurgist

Report Date: August 28, 2020  
Effective Date: August 8, 2020

*“Nigel Fung” {signed and sealed as of the report date}*

Nigel Fung, B.Sc.H, B.Eng., P.Eng.  
Vice President and Senior Mining Engineer

Report Date: August 28, 2020  
Effective Date: August 8, 2020

*“Christopher Jacobs” {signed and sealed as of the report date}*

Christopher Jacobs, CEng, MIMMM  
Vice President and Mining Economist

Report Date: August 28, 2020  
Effective Date: August 8, 2020

“Alan San Martin

Ing. Alan San Martin, MAusIMM(CP)  
Mineral Resource Specialist

Report Date: August 28, 2020  
Effective Date: August 8, 2020

SERVICIOS GEOLÓGICOS IMEX, S.C.

*“Rodrigo Calles-Montijo” {signed and sealed as of the report date}*

Rodrigo Calles-Montijo, CPG.  
General Administrator and Principal Consultant

Report Date: August 28, 2020  
Effective Date: August 8, 2020

## 28.0 REFERENCES

### 28.1 TECHNICAL REPORTS, PAPERS AND OTHER SOURCES

Alio Gold Inc., (November 9, 2017), Press Release: Alio Gold Provides Third Quarter 2017 Update.

Alio Gold Inc., (January 30, 2018), Press Release: Alio Gold Provides 2018 Guidance For San Francisco Mine.

Alio Gold Inc., (April 11, 2018), Press Release: Alio Gold Provides First Quarter 2018 Production From San Francisco With Management and Transaction Updates.

Alio Gold Inc., (May 9, 2018), Press Release: Alio Gold Reports First Quarter 2018 Results.

Alio Gold Inc., (August 10, 2018), Press Release: Alio Gold Reports Second Quarter 2018 Results.

Alio Gold Inc., (November 08, 2018), Press Release: Alio Gold Reports Third Quarter 2018 Results.

Alio Gold Inc., (January 15, 2019), Press Release: Alio Gold Provides 2018 Gold Production.

Alio Gold Inc., (February 12, 2019), Press Release: Alio Gold Files Technical Report and Provides San Francisco Update.

Alio Gold Inc., (March 13, 2019), Press Release: Alio Gold Reports Fourth Quarter and Full-Year 2018 Results.

Alio Gold Inc., (May 08, 2019), Press Release: Alio Gold Reports First Quarter 2019 Results.

Alio Gold Inc., (November 06, 2019), Press Release: Alio Gold Reports Third Quarter 2019 Results.

Alio Gold Inc., (March 06 08, 2020), Press Release: Alio Gold Announces Sale of San Francisco Mine.

Anderson, T.H., and Silver, L.T., (1979), The role of the Mojave-Sonora Megashear in the Tectonic Evolution of Northern Sonora, in Clark, K.F. et al., editors, Geology and Mineral Resources of Northern Sierra Madre Occidental, Mexico, Guidebook for the 1992 Field Conference, El Paso Geological Society, 479 p.

Call & Nicholas Inc., (2012), Geotechnical Evaluation for the San Francisco Final Pit Plan Prepared for Molimentales del Noroeste S.A. de C.V., 304 p.

Calmus, T. et al., (1992), Geology of Estación Liano (Sonora): A New Proterozoic Basement and the San Francisco Gold Deposit, in Clark, K.F. et al., editors, Geology and Mineral Resources of Northern Sierra Madre Occidental, Mexico, Guidebook for the 1992 Field Conference, El Paso Geological Society, 479 p.

De Jong, K., et al., (1988), Eastward Thrusting, Southwestward Folding and Backsliding in the Sierra La Vibora, Sonora, Mexico: Geology, V. 16.

Defiance Mining Corporation, (2004), Annual Report 2003, 30 p.

Foo, B, (2015), Memorandum, San Francisco Underground Mining Preliminary Review, 3 p.

Geomaque Explorations Ltd, (2001), Annual Report 2000, 19 p.

Geomaque Explorations Ltd, (2002), Annual Report 2001, 26 p.

Geomaque Explorations Ltd, (2003), Annual Information Form for the Year Ended December 31, 2002, 68 p.

Geomaque of Mexico, S.A. de C.V., (1994), Presentation by Geomaque de Mexico, S.A. de C.V. for the evaluation of Environmental Impact Report, General Category, for the Geological-Mining Project Named "San Francisco" Mining Project.

Golder and Associates, (1996), Final Pit Wall Stability Evaluation, San Francisco Mine Project Draft Report prepared for Geomaque De Mexico, 39 p.

Hester, M., (2007), San Francisco Mineral Resource, Memo prepared for Timmins Gold Corporation by Independent Mining Consultants Inc., 11 p.

Independent Mining Consultants Inc., (1997), San Francisco Project, Movable Reserves and Geological Resources as of April 30, 1997 prepared for Geomaque Exploration Ltd., 42 p.

Jacques-Ayala, C., et al., (1991), The Interpreted Trace of the Mojave-Sonora Megashear in Northwest Sonora-A Laramide Thrust Front and Middle Tertiary Detachment Zone: Primer Congreso Mexicano Mineralogía, Conv. Evolución Geológica de México, Memoria.

Lewis, W.J., (2005), Technical Report on the San Francisco Mine Property, Estación Llano, Sonora, Mexico, 68 p.

Lewis, W.J. and Hester, M.G. (2007), NI 43-101 Technical Report and Resource Estimate for the San Francisco Gold Property, Estación Llano, Sonora, Mexico, www.sedar.com 140 p.

Lewis, W.J. et al., (2008), NI 43-101 Technical Report on the Preliminary Feasibility Study for the San Francisco Gold Property, Estación Llano, Sonora, Mexico, 207 p.

Lewis, W.J. et al., (2009), NI 43-101 Technical Report on the Preliminary Feasibility Study for the San Francisco Gold Property, Estación Llano, Sonora, Mexico, Amended 2008 Technical Report, 205 p.

Lewis, W.J. et al., (2010), NI 43-101 Technical Report Updated Resources and Reserves and Mine Plan for the San Francisco Gold Mine, Sonora, Mexico, 217 p. Report Amended 2011.

Lewis, W.J. et al., (2011), NI 43-101 F1 Technical Report Updated Resources and Reserves and Mine Plan for the San Francisco Gold Mine, Sonora, Mexico, 300 p.

Lewis, W.J. et al., (2013), NI 43-101 F1 Technical Report Updated Resources and Reserves and Mine Plan for the San Francisco Gold Project, Sonora, Mexico, 330 p.

Lewis, W.J. et al., (February, 2016), NI 43-101 F1 Technical Report Updated Resources and Reserves and Mine Plan for the San Francisco Gold Project, Sonora, Mexico, 215 p.

Lewis, W.J. et al., (September, 2016 and amended November, 2016), NI 43-101 F1 Technical Report Updated Resources and Reserves and Mine Plan for the San Francisco Gold Project, Sonora, Mexico, 264 p.

Lewis, W.J. et al., (May 25, 2017), NI 43-101 F1 Technical Report Updated Resources and Reserves and Mine Plan for the San Francisco Gold Project, Sonora, Mexico, 261 p.

Lewis, W.J., Gowans, R.M., and Calles-Montijo, R., (June, 2020), NI 43-101 F1 Technical Report for the San Francisco Gold Project, Sonora, Mexico, 277 p.

Luna, R. and Gastelum, G., (1992), Geology of the San Francisco Project Estación Llano, Sonora in Clark, K.F. et al., editors, Geology and Mineral Resources of Northern Sierra Madre Occidental, Mexico, Guidebook for the 1992 Field Conference, El Paso Geological Society, 479 p.

Magna Gold Corp., (March 6, 2020), Press Release: Magna Gold Corp. Announces Acquisition of the San Francisco Mine and Private Placement.

Magna Gold Corp., (April 24 2020), Press Release: Magna Gold Corp. Provides Update on Acquisition of the San Francisco Mine and Private Placement.

Magna Gold Corp., (May 6, 2020), Press Release: Magna Gold Corp. Closes Acquisition of the San Francisco Mine and Private Placement.

Magna Gold Corp., (June 16 2020), Press Release: Magna Gold Corp. Provides Corporate Update.

Magna Gold Corp., (July 9, 2020), Press Release: Magna Gold Corp. Provides Operating Update.  
Micon International Limited, (2012), Technical Memorandum, San Francisco Mine Reconciliation of Reserves, 16 p. plus appendices.



Medina, Miguel Rangel, (2013), Estudio de Evaluación Hidrogeológica en el Área de Nuevos Patios de Lixiviación, de La Mina San Francisco, Estacion Llano, Sonora, 46 p.

Medina, Miguel Rangel, (2012), Informe Mensual Noviembre "Construcción de Piezómetros en el Área de la Mina San Francisco, Municipio de Santa Ana, Sonora", 74 p.

Medina, Miguel Rangel, (2013), Informe Final "Memorias de la Construcción de Piezómetros en el Área de la Mina San Francisco, Municipio de Santa Ana, Sonora" (Nov-Dic/2012), 45 p.

Medina, Miguel Rangel, (2013), Memorias "Construcción de Piezómetros en el Área de la Mina San Francisco, Municipio de Santa Ana, Sonora" (Nov-Dic/2012), 127 p.

Perez Segura, E., (1992), The Au-Te Mineralogy of the San Francisco Deposit, Sonora, Mexico, in Clark, K.F. et al., editors, Geology and Mineral Resources of Northern Sierra Madre Occidental, Mexico, Guidebook for the 1992 Field Conference, El Paso Geological Society, 479 p.

Prenn, N.B., et al., (1995), San Francisco Property Resource and Reserve Sonora, Mexico prepared by Mine Development Associates for Geomaque Exploration Ltd., 46 p.

Salas, G.P., et al, (1991), Economic Geology, Mexico, Volume P-3 of the Geology of North America, in The Decade of North American Geology Project series by The Geological Society of America, Inc., 438 p.

Silberman, M., (1992), Characteristics and Complex History of Gold-Bearing Quartz veins along the Mojave-Sonora Megashear Zone, northern Sonora, Mexico, in Clark, K.F. et al., editors, Geology and Mineral Resources of Northern Sierra Madre Occidental, Mexico, Guidebook for the 1992 Field Conference, El Paso Geological Society, 479 p.

Silver, L.T., and Anderson, T.H., (1974), Possible Left-lateral Early to Middle Mesozoic Disruption of the Southwestern North American Craton Margin, in Geological Society of America, Abstracts with Programs, v. 6, 955 p.

Sol & Adobe Ingenieros Asociado S.A. de C.V. (2006) San Francisco Scoping Study, 9-1 to 9 7 p.

Telluris Consulting Ltd., (2009), Structural Review of the San Francisco Deposit, Sonora Mexico, Prepared for Timmins Gold Corp. Molimentales del Noroeste S.A. de C.V., 35 p.

Timmins Gold Corp., (January, 2011), Exploration Report, 209 p.

Timmins Gold Corp., (January-February, 2012) Exploration report, 229.

Timmins Gold Corp., (January, 2013), Report of Exploration, 212 p.

Timmins Gold Corp., (May, 2011), Press Release: Timmins Gold sells 65,784 ounces of gold during first year of commercial operations at the San Francisco Mine.

Timmins Gold Corp., (September, 2011), Press Release: Timmins Gold Corp Announces Updated Reserve and Resource Estimates for the San Francisco Gold Project.

Timmins Gold Corp., (October, 2011), Press Release: Timmins Gold Reports Second Quarter Production Results.

Timmins Gold Corp., (November, 2011), Press Release: Timmins Gold to commence Trading on NYSE Amex on November 4, 2011.

Timmins Gold Corp., (January, 2012), Press Release: Timmins Gold reports record production of 21,524 gold ounces in final quarter of 2011.

Timmins Gold Corp., (March, 2012), Press Release: Timmins Gold Corp Announces Updated Resource Estimate for the San Francisco Gold Project.

Timmins Gold Corp., (April, 2012), Press Release: Timmins Gold Reports Record Gold Production of 21,532 Ounces of Gold and Record Gold Recovery Ratio of 69% during Q1 2012.

Timmins Gold Corp., (July, 2012), Press Release: Timmins Gold reports record production of 23,203 ounces of gold and 14,453 ounce of silver during Q2 2012.

Timmins Gold Corp., (October, 2012), Press Release: Timmins Gold reports record production of 25,153 ounces of gold and 13,857 ounce of silver during Q3 2012.

Timmins Gold Corp., (January, 2013), Press Release: Timmins Gold reports record production of 94,444 ounces of gold for 2012.

Timmins Gold Corp., (April, 2013), Press Release: Timmins Gold reports record production of 28,328 ounces of gold for the first quarter of 2013.

Timmins Gold Corp., (April, 2013), Press Release: Timmins Gold intersects 72 metres of 1.6 gpt gold, 15 metres of 4.2 gpt gold and 14 metres of 3.2 gpt gold at San Francisco Pit.

Timmins Gold Corp., (July, 2013), Press Release: Timmins Gold reports production of 28,024 gold ounces for the second quarter of 2013.

Timmins Gold Corp., (October, 2013), Press Release: Timmins Gold reports record production of 29,139 gold ounces for the third quarter of 2013.

Timmins Gold Corp., (November, 2013), Press Release: Timmins Gold Announces Updated Reserve and Resource Estimates for the San Francisco Gold Mine.

Timmins Gold Corp., (November, 2013), Press Release: Updated Mine Plan for the San Francisco Mine.

Timmins Gold Corp., (December, 2013), Press Release: Timmins Files Updated NI 43-101 Technical Report for its San Francisco Gold Mine.

Timmins Gold Corp., (January, 2014), Press Release: Timmins Gold surpasses guidance with record production of 120,900 AuEq ozs in 2013 and 34,563 ozs for the fourth quarter of 2013.

Timmins Gold Corp., (April, 2014), Press Release: Timmins Gold reports record production of 35,684 AuEq\* ounces for the first quarter of 2014.

Timmins Gold Corp., (May, 2014), Press Release: Timmins announces USD5 million 2014 exploration program focusing on three high potential targets.

Timmins Gold Corp., (July, 2014), Press Release: Timmins Gold reports production of 32,932 gold ounces for the second quarter of 2014.

Timmins Gold Corp., (October, 2014), Press Release: Timmins Gold reports production of 27,013 gold equivalent ounces for the third quarter of 2014.

Timmins Gold Corp., (December, 2014), Press Release: Timmins Gold to Purchase Caballo Blanco Gold Project.

Timmins Gold Corp., (December, 2014), Press Release: Timmins Gold completes acquisition of Caballo Blanco Gold Project.

Timmins Gold Corp., (January, 2015), Press Release: Timmins Gold reports record production of 121,573 AuEq ozs in 2014 and 25,304 AuEq ozs for the fourth quarter of 2014.

Timmins Gold Corp., (February, 2015), Press Release: Timmins Gold Identifies Potential Satellite Deposits North of San Francisco Mine Drills 33.85 m of 1.29 g/t Au and 10.2 m of 5.52 g/t Au.

Timmins Gold Corp., (February, 2015), Press Release: Timmins Gold Corp. Identifies High-grade Mineralization Adjacent to San Francisco Mine; Drills 14 metres of 8.0 g/t gold and 29 metres of 3.5 g/t gold.

Timmins Gold Corp., (February, 2015), Press Release: Timmins Gold to Combine with Newstrike Capital to Create an Emerging, Mexican-Focused Intermediate Gold Producer.

Timmins Gold Corp., (April, 2015), Press Release: Timmins Gold reports production of 24,374 AuEq ounces for the first quarter of 2015.

Timmins Gold Corp., (May, 2015), Press Release: Timmins Gold Completes Acquisition of Newstrike Capital.

Timmins Gold Corp., (July, 2015), Press Release: Timmins Gold Commences Underground Pilot Phase at its San Francisco Mine.

Timmins Gold Corp., (March, 2016), Press Release: Timmins Gold Updates San Francisco Technical Report.

Timmins Gold Corp., (August, 2016), Press Release: Timmins Gold Extends Operations at San Francisco Gold Mine into 2023.

Timmins Gold Corp., (Undated), Exploration Drilling Update on San Francisco Property, Internal Letter Report, unpaginated 19 p.

Timmins Gold Corp., (Undated), In-fill Drilling at San Francisco Gold Mine 2014 – 2015, Exploracion on the San Francisco Mine, Internal Letter Report, unpaginated 18 p.

Timmins Gold Corp., (2005), Promotional Information Brochure, 2 p.

Timmins Gold Corp., (2005), San Francisco Gold Mine, Sonora Mexico, May, 2005, Power Point Presentation, 13 p.

Tosdal, R.M., Haxel, G.B., and Wright, J.E., (1989), Jurassic Geology of the Sonoran Desert Region, Southern Arizona, Southeastern California and Northwestern Sonora: Construction of a Continental-Margin Magmatic Arc, in J.P. Jenny, and S.H. Reynolds (editors), Geological Evolution of Arizona, Tucson, Arizona Geological Society Digest.

Vargas, J.C., et al, (1994), Geological – Mining Monograph of the State of Sonora, M-8E, published by the Consejo de Recursos Minerales, 220 p.

Zonge Engineering and Research Organization Inc., (2007), Processing and Interpretation of High Resolution Aeromagnetic and Radiometric Data for the San Francisco and Pima Project Areas, Sonora, Mexico, for Timmins Gold Corporation, 19 p.

## **28.2 INTERNET SOURCES**

Alio Gold Inc., [www.aliogold.com](http://www.aliogold.com), (2017 to 2020) Press Releases.

Kitco website, [www.kitco.com](http://www.kitco.com),

Magna Gold Corp., [www.magnagoldcorp.com](http://www.magnagoldcorp.com), (2018 to 2020) Press Releases

SEDAR website, [www.sedar.com](http://www.sedar.com)

Timmins Gold Corp., website [www.timminsgold.com](http://www.timminsgold.com), (2005 to 2016) Press Releases.

## 29.0 CERTIFICATES OF AUTHORS

## CERTIFICATE OF AUTHOR

### William J. Lewis

As the co-author of this report for Magna Gold Corp. entitled “NI 43-101 F1 Technical Report Pre-Feasibility Study for the San Francisco Gold Project, Sonora, Mexico” dated August 28, 2020 with an effective date of August 8, 2020, I, William J. Lewis do hereby certify that:

1. I am employed by, and carried out this assignment for, Micon International Limited, Suite 900, 390 Bay Street, Toronto, Ontario M5H 2Y2, tel. (416) 362-5135, fax (416) 362-5763, e-mail [wlewis@micon-international.com](mailto:wlewis@micon-international.com);
2. This certificate applies to the Technical Report titled “NI 43-101 F1 Technical Report Pre-Feasibility Study for the San Francisco Gold Project in Sonora, Mexico” dated August 28, 2020 with an effective date of August 8, 2020;
3. I hold the following academic qualifications:  
B.Sc. (Geology) University of British Columbia 1985
4. I am a registered Professional Geoscientist with the Association of Professional Engineers and Geoscientists of Manitoba (membership # 20480); as well, I am a member in good standing of several other technical associations and societies, including:
  - Association of Professional Engineers and Geoscientists of British Columbia (Membership # 20333)
  - Association of Professional Engineers, Geologists and Geophysicists of the Northwest Territories (Membership # 1450)
  - Professional Association of Geoscientists of Ontario (Membership # 1522)
  - The Canadian Institute of Mining, Metallurgy and Petroleum (Member # 94758)
5. I have worked as a geologist in the minerals industry for 35 years;
6. I am familiar with NI 43-101 and, by reason of education, experience and professional registration, I fulfill the requirements of a Qualified Person as defined in NI 43-101. My work experience includes 4 years as an exploration geologist looking for gold and base metal deposits, more than 11 years as a mine geologist in underground mines estimating mineral resources and reserves and 20 years as a surficial geologist and consulting geologist on precious and base metals and industrial minerals;
7. I have read NI 43-101 and this Technical Report has been prepared in compliance with the instrument;
8. I visited the San Francisco mine project on numerous previous occasions since 2005 and most recently between May 15 and 17, 2017 to review the resource/reserve estimates and in-fill drilling programs on the property and discuss the ongoing QA/QC program for the previous Technical Report for Magna Gold Corp.
9. I have written or co-authored previous Technical Reports for the mineral property that is the subject of this Technical Report;
10. I am independent Magna Gold Corp. and its subsidiaries according to the definition described in NI 43-101 and the Companion Policy 43-101 CP;
11. I am responsible for Sections 1.1 to 1.7.1, 2 to 12.2, 12.5, 14.1 to 14.4, 18, 19, 20, 23, 24, 25.1, 25.2.1, 26, and 28 of this Technical Report;
12. As of the date of this certificate, to the best of my knowledge, information and belief, the Technical Report contains all scientific and technical information that is required to be disclosed to make this technical report not misleading;

Report Dated this 28th day of August, 2020 with an effective date of August 8, 2020.

*“William J. Lewis” {signed and sealed as of the report date}*

William J. Lewis, B.Sc., P.Geo.

**CERTIFICATE OF AUTHOR**  
**Richard M. Gowans**

As the co-author of this report for Magna Gold Corp. entitled “NI 43-101 F1 Technical Report Pre-Feasibility Study for the San Francisco Gold Project, Sonora, Mexico” dated August 28, 2020 with an effective date of August 8, 2020, I, Richard Gowans do hereby certify that:

1. I am employed by, and carried out this assignment for, Micon International Limited, Suite 900, 390 Bay Street, Toronto, Ontario M5H 2Y2, tel. (416) 362-5135, fax (416) 362-5763, e-mail [rgowans@micon-international.com](mailto:rgowans@micon-international.com).
2. I hold the following academic qualifications:  
B.Sc. (Hons) Minerals Engineering, The University of Birmingham, U.K. 1980.
3. I am a registered Professional Engineer of Ontario (membership number 90529389); as well, I am a member in good standing of the Canadian Institute of Mining, Metallurgy and Petroleum.
4. I am familiar with NI 43-101 and by reason of education, experience and professional registration, fulfill the requirements of a Qualified Person as defined in NI 43-101. My work experience includes over 30 years of the management of technical studies and design of numerous metallurgical testwork programs and metallurgical processing plants.
5. I have read NI 43-101 and this Technical Report has been prepared in compliance with the instrument.
6. I have not visited the mine site.
7. I have participated in the preparation of a number of prior Technical Reports on the San Francisco property.
8. I am independent of Magna Gold Corp. and its related entities, as defined in Section 1.5 of NI 43-101.
9. I am responsible for Sections 1.9, 13, 17 and 25.3.2 of this Technical Report.
10. As of the date of this certificate, to the best of my knowledge, information and belief, the Technical Report contains all scientific and technical information that is required to be disclosed to make this technical report not misleading.

Report Dated this 28th day of August, 2020 with an effective date of August 8, 2020

*“Richard Gowans” {signed and sealed as of the report date}*

Richard Gowans P.Eng.

**CERTIFICATE OF QUALIFIED PERSON**  
**Nigel Fung, B.Sc.H., B.Eng., P.Eng.**

As the co-author of this report for Magna Gold Corp. entitled “NI 43-101 F1 Technical Report Pre-Feasibility Study for the San Francisco Gold Project, Sonora, Mexico” dated August 28, 2020 with an effective date of August 8, 2020, I, Nigel Fung, do hereby certify that:

1. I am employed as a Geostatistician by, and carried out this assignment for, Micon International Limited, 900 – 390 Bay Street, Toronto, Ontario M5H 2Y2. tel. (416) 362-5135, email: [nfung@micon-international.com](mailto:nfung@micon-international.com).
2. I hold the following academic qualifications:
  - Bachelor of Mining Engineering, McGill University, Montreal, Quebec, Canada, 2001.
  - Bachelor of Science, Honours in Biology, University of Toronto, Toronto, Ontario, Canada, 1993.
3. I am a registered Professional Engineer of Ontario (License #100173276); as well, I am a member in good standing of the Canadian Institute of Mining, Metallurgy and Petroleum (member #107148).
4. Also, I am a professional member in good standing of:
  - Ontario Society of Professional Engineers, ID# 12226235
  - Society of Mining Engineers, #4185435
5. I am familiar with NI 43-101 and by reason of education, experience and professional registration, fulfill the requirements of a Qualified Person as defined in NI 43-101. My work experience includes over 20 years directing long-term mine planning, permitting and implementation of innovation projects and coordinated mine feasibility studies in Canada and Mexico. as well as having an excellent understanding of the mining fleet requirements for efficient and cost-effective open pit operation with a major manufacturer of open pit mining equipment..
6. I have not visited the Property that is the subject of this report.
7. I am responsible for Sections 1.8, 15, 16 and 25.3.1 of this Technical Report.
8. I am independent of Magna Gold Corp. and its related entities, as defined in Section 1.5 of NI 43-101.
9. I have read NI 43-101 and the Sections of this report for which I am responsible have been prepared in compliance with the instrument.
10. As of the date of this certificate to the best of my knowledge, information and belief, the sections of this Technical Report for which I am responsible contain all scientific and technical information that is required to be disclosed to make this report not misleading.

Report Dated this 28th day of August, 2020 with an effective date of August 8, 2020.

*“Nigel Fung” {signed and sealed}*

Nigel Fung, B.Sc.H., B.Eng., P.Eng.



## **CERTIFICATE OF QUALIFIED PERSON** **Christopher Jacobs, CEng, MIMMM**

As the co-author of this report for Magna Gold Corp. entitled “NI 43-101 F1 Technical Report Pre-Feasibility Study for the San Francisco Gold Project, Sonora, Mexico” dated August 28, 2020 with an effective date of August 8, 2020, I, Christopher Jacobs, do hereby certify that:

1. I am employed as a Vice President and Mining Economist by, and carried out this assignment for, Micon International Limited, 900 – 390 Bay Street, Toronto, Ontario M5H 2Y2. tel. (416) 362-5135, email: [cjacobs@micon-international.com](mailto:cjacobs@micon-international.com).
2. I hold the following academic qualifications:
  - B.Sc. (Hons) Geochemistry, University of Reading, 1980;
  - M.B.A., Gordon Institute of Business Science, University of Pretoria, 2004.
3. I am a Chartered Engineer registered with the Engineering Council of the U.K. (registration number 369178).
4. Also, I am a professional member in good standing of: The Institute of Materials, Minerals and Mining; and The Canadian Institute of Mining, Metallurgy and Petroleum (Member).
5. I am familiar with NI 43-101 and by reason of education, experience and professional registration, fulfill the requirements of a Qualified Person as defined in NI 43-101. I have worked in the minerals industry for more than 35 years; my work experience includes 10 years as an exploration and mining geologist on gold, platinum, copper/nickel and chromite deposits; 10 years as a technical/operations manager in both open-pit and underground mines; 3 years as strategic (mine) planning manager and the remainder as an independent consultant when I have worked on a variety of deposits including gold and base metals.
6. I previously visited the Property that is the subject of this report on September 25-28, 2007.
7. I am responsible for Sections 1.10, 21, 22 and 25.4 of this Technical Report.
8. I am independent of Magna Gold Corp. and its related entities, as defined in Section 1.5 of NI 43-101.
9. I have read NI 43-101 and the Sections of this report for which I am responsible have been prepared in compliance with the instrument.
10. As of the date of this certificate to the best of my knowledge, information and belief, the sections of this Technical Report for which I am responsible contain all scientific and technical information that is required to be disclosed to make this report not misleading.

Report Dated this 28th day of August, 2020 with an effective date of August 8, 2020.

*“Christopher Jacobs” {signed and sealed}*

Christopher Jacobs, CEng, MIMMM

**CERTIFICATE OF QUALIFIED PERSON**  
**Ing. Alan J. San Martin, MAusIMM(CP)**

As the co-author of this report for Magna Gold Corp. entitled “NI 43-101 F1 Technical Report Pre-Feasibility Study for the San Francisco Gold Project, Sonora, Mexico” dated August 28, 2020 with an effective date of August 8, 2020, I, Alan J. San Martin, do hereby certify that:

1. I am employed by, and carried out this assignment for, Micon International Limited, whose address is 900 – 390 Bay Street, Toronto, Ontario M5H 2Y2. tel: (416) 362-5135, e-mail [asanmartin@micon-international.com](mailto:asanmartin@micon-international.com).
2. I hold a Bachelor Degree in Mining Engineering (equivalent to B.Sc.) from the National University of Piura, Peru, 1999;
3. I am a member in good standing of the following professional entities:
  - a) The Australasian Institute of Mining and Metallurgy (AusIMM), Membership #301778
  - b) Canadian Institute of Mining, Metallurgy and Petroleum, Member ID 151724
  - c) Colegio de Ingenieros del Perú (CIP), Membership # 79184
4. I have been working as a mining engineer and geoscientist in the mineral industry for over 20 years;
5. I am familiar with the current NI 43-101 and, by reason of education, experience and professional registration as Chartered Professional, MAusIMM(CP), I fulfill the requirements of a Qualified Person as defined in NI 43-101. My work experience includes 5 years as Mining Engineer in exploration (Peru), 4 years as Resource Modeller in exploration (Ecuador) and 10 years as Mineral Resource Specialist and mining consultant in Canada;
6. I have read NI 43-101 and Form 43-101F1 and the portions of this Technical Report for which I am responsible have been prepared in compliance with that instrument and form.
7. I have not visited the property that is the subject of the Technical Report.
8. I have co-authored previous Micon reports for the property that is the subject of the Technical Report.
9. I am independent of Magna Gold Corp. and its related entities, as defined in Section 1.5 of NI 43-101.
10. I am responsible for Sections 12.4 and 14.5 of this Technical Report.
11. As of the date of this certificate, to the best of my knowledge, information and belief, the Technical Report contains all scientific and technical information that is required to be disclosed to make this technical report not misleading.

Report Dated this 28th day of August, 2020 with an effective date of August 8, 2020.

*“Alan J. San Martin” {signed and sealed}*

Ing. Alan J. San Martin, MAusIMM(CP)

## **CERTIFICATE OF AUTHOR** **Rodrigo Calles-Montijo**

As the co-author of this report for Magna Gold Corp. entitled “NI 43-101 F1 Technical Report Pre-Feasibility Study for the San Francisco Gold Project, Sonora, Mexico” dated August 28, 2020 with an effective date of August 8, 2020, I, Rodrigo Calles-Montijo do hereby certify that:

1. I am General Administrator and Principal Consultant of the firm Servicios Geológicos IMEx, S.C, located at Blvd. Morelos No. 639, Locales 13 y 14, Hermosillo, Sonora, Mexico, C.P. 83148, Email: rodrigo.calles@sgimex.mx;
2. This certificate applies to the Technical Report titled “NI 43-101 F1 Technical Report Pre-Feasibility Study for the San Francisco Gold Project, Sonora, Mexico” dated August 28, 2020 with an effective date of August 8, 2020”.
3. I hold the following academic qualifications:  
B.Sc. (Geologist Engineer) Autonomous University of Chihuahua 1986  
M.Sc. (Economic Geology) University of Sonora 1999
4. I am a Certified Professional Geologist in a good standing with American Institute of Professional Geologist with certificate number 11567 and member of the Association of Mining Engineers, Metallurgist and Geologist of Mexico, A.C., Membership 556;
5. I have 35 years of experience in exploration and evaluation of mineral deposits, including metallic and non-metallic deposits in several countries around the world; I have experience in evaluation of diverse types of gold deposits, including placer, skarn and disseminated deposits
6. I am familiar with NI 43-101 and, by reason of education, experience and professional registration, I fulfill the requirements of a Qualified Person as defined in NI 43-101. My work experience includes 20 years as an exploration geologist looking for base metal and industrial mineral deposits and more than 11 years as consulting geologist on precious, base metals and industrial minerals and operative mines;
7. I have read NI 43-101 and this Technical Report has been prepared in compliance with the instrument;
8. I visited the San Francisco mine project on several previous occasions since 2015 and most recently in May 29, 2020 to asses current mine infrastructure conditons.
9. I am independent Magna Gold Corp. and its subsidiaries according to the definition described in NI 43-101 and the Companion Policy 43-101 CP;
10. I am responsible for the site visit as described in Section 12.3 of this Technical Report;
11. As of the date of this certificate, to the best of my knowledge, information and belief, the Technical Report contains all scientific and technical information that is required to be disclosed to make this technical report not misleading;

Report Dated this 28th day of August, 2020 with an effective date of August 8, 2020.

*“Rodrigo Calles-Montijo” {signed and sealed as of the report date}*

Rodrigo Calles-Montijo, M.Sc., CPG.

## **APPENDIX I**

### **GLOSSARY OF MINING AND OTHER RELATED TERMS**

## GLOSSARY AND DEFINED TERMS

---

The following is a glossary of certain mining terms that may be used in this Technical Report.

### A

Ag	Symbol for the element silver.
Alio or ALO	Alio Gold Inc., including, unless the context otherwise requires, the Company's subsidiaries.
Assay	A chemical test performed on a sample of ores or minerals to determine the amount of valuable metals contained.
Au	Symbol for the element gold.

### B

Base metal	Any non-precious metal (e.g. copper, lead, zinc, nickel, etc.).
Bulk mining	Any large-scale, mechanized method of mining involving many thousands of tonnes of ore being brought to surface per day.
Bulk sample	A large sample of mineralized rock, frequently hundreds of tonnes, selected in such a manner as to be representative of the potential orebody being sampled. The sample is usually used to determine metallurgical characteristics.
Bullion	Precious metal formed into bars or ingots.
By-product	A secondary metal or mineral product recovered in the milling process.

### C

Channel sample	A sample composed of pieces of vein or mineral deposit that have been cut out of a small trench or channel, usually about 10 cm wide and 2 cm deep.
Chip sample	A method of sampling a rock exposure whereby a regular series of small chips of rock is broken off along a line across the face.
CIM Standards	The CIM Definition Standards on Mineral Resources and Mineral Reserves adopted by CIM Council from time to time. The most recent update adopted by the CIM Council is effective as of May 10, 2014.
CIM	The Canadian Institute of Mining, Metallurgy and Petroleum.
Concentrate	A fine, powdery product of the milling process containing a high percentage of valuable metal.

Contact	A geological term used to describe the line or plane along which two different rock formations meet.
Core	The long cylindrical piece of rock, about an inch in diameter, brought to surface by diamond drilling.
Core sample	One or several pieces of whole or split parts of core selected as a sample for analysis or assay.
Cross-cut	A horizontal opening driven from a shaft and (or near) right angles to the strike of a vein or other orebody. The term is also used to signify that a drill hole is crossing the mineralization at or near right angles to it.
Cut-off grade	The lowest grade of mineralized rock that qualifies as ore grade in a given deposit, and is also used as the lowest grade below which the mineralized rock currently cannot be profitably exploited. Cut-off grades vary between deposits depending upon the amenability of ore to gold extraction and upon costs of production.

## **D**

Dacite	The extrusive (volcanic) equivalent of quartz diorite.
Deposit	An informal term for an accumulation of mineralization or other valuable earth material of any origin.
Development/In-fill drilling	Drilling to establish accurate estimates of mineral resources or reserves usually in an operating mine or advanced project.
Dilution	Rock that is, by necessity, removed along with the ore in the mining process, subsequently lowering the grade of the ore.
Diorite	An intrusive igneous rock composed chiefly of sodic plagioclase, hornblende, biotite or pyroxene.
Dip	The angle at which a vein, structure or rock bed is inclined from the horizontal as measured at right angles to the strike.
Doré	A semi refined alloy containing sufficient precious metal to make recovery profitable. Crude precious metal bars, ingots or comparable masses produced at a mine which are then sold or shipped to a refinery for further processing.

## **E**

Epithermal	Hydrothermal mineral deposit formed within one kilometre of the earth's surface, in the temperature range of 50 to 200°C.
Epithermal deposit	

A mineral deposit consisting of veins and replacement bodies, usually in volcanic or sedimentary rocks, containing precious metals or, more rarely, base metals.

Exploration      Prospecting, sampling, mapping, diamond drilling and other work involved in searching for ore.

## **F**

Face              The end of a drift, cross-cut or stope in which work is taking place.

Fault             A break in the Earth's crust caused by tectonic forces which have moved the rock on one side with respect to the other.

Flotation        A milling process in which valuable mineral particles are induced to become attached to bubbles and float as others sink.

Fold              Any bending or wrinkling of rock strata.

Footwall         The rock on the underside of a vein or mineralized structure or deposit.

Fracture         A break in the rock, the opening of which allows mineral-bearing solutions to enter. A "cross-fracture" is a minor break extending at more-or-less right angles to the direction of the principal fractures.

## **G**

g/t                Abbreviation for gram(s) per metric tonne.

g/t                Abbreviation for gram(s) per tonne.

Grade            Term used to indicate the concentration of an economically desirable mineral or element in its host rock as a function of its relative mass. With gold, this term may be expressed as grams per tonne (g/t) or ounces per tonne (opt).

Gram             One gram is equal to 0.0321507 troy ounces.

## **H**

Hanging wall    The rock on the upper side of a vein or mineral deposit.

Heap Leaching   A process used for the recovery of copper, uranium, and precious metals from weathered low-grade ore. The crushed material is laid on a slightly sloping, impervious pad and uniformly leached by the percolation of the leach liquor trickling through the beds by gravity to ponds. The metals are recovered by conventional methods from the solution.

High-grade      Rich mineralization or ore. As a verb, it refers to selective mining of the best ore in a deposit.

Host rock        The rock surrounding an ore deposit.

**Hydrothermal** Processes associated with heated or superheated water, especially mineralization or alteration.

## **I**

### **Indicated Mineral Resource**

An Indicated Mineral Resource is that part of a Mineral Resource for which quantity, grade or quality, densities, shape and physical characteristics are estimated with sufficient confidence to allow the application of Modifying Factors in sufficient detail to support mine planning and evaluation of the economic viability of the deposit. Geological evidence is derived from adequately detailed and reliable exploration, sampling and testing and is sufficient to assume geological and grade or quality continuity between points of observation. An Indicated Mineral Resource has a lower level of confidence than that applying to a Measured Mineral Resource and may only be converted to a Probable Mineral Reserve.

### **Inferred Mineral Resource**

An Inferred Mineral Resource is that part of a Mineral Resource for which quantity and grade or quality are estimated on the basis of limited geological evidence and sampling. Geological evidence is sufficient to imply but not verify geological and grade or quality continuity. An Inferred Mineral Resource has a lower level of confidence than that applying to an Indicated Mineral Resource and must not be converted to a Mineral Reserve. It is reasonably expected that the majority of Inferred Mineral Resources could be upgraded to Indicated Mineral Resources with continued exploration.

**Intrusive** A body of igneous rock formed by the consolidation of magma intruded into other

## **K**

**km** Abbreviation for kilometre(s). One kilometre is equal to 0.62 miles.

## **L**

**Leaching** The separation, selective removal or dissolving-out of soluble constituents from a rock or ore body by the natural actions of percolating solutions.

**Level** The horizontal openings on a working horizon in a mine; it is customary to work mines from a shaft, establishing levels at regular intervals, generally about 50 m or more apart.

**Limestone** A bedded, sedimentary deposit consisting chiefly of calcium carbonate.

## **M**

**m** Abbreviation for metre(s). One metre is equal to 3.28 feet.



**Magna** Magna Gold Corp., including, unless the context otherwise requires, the Company's subsidiaries.

**Marble** A metamorphic rock derived from the recrystallization of limestone under intense heat and pressure.

#### Measured Mineral Resource

A Measured Mineral Resource is that part of a Mineral Resource for which quantity, grade or quality, densities, shape, and physical characteristics are estimated with confidence sufficient to allow the application of Modifying Factors to support detailed mine planning and final evaluation of the economic viability of the deposit. Geological evidence is derived from detailed and reliable exploration, sampling and testing and is sufficient to confirm geological and grade or quality continuity between points of observation. A Measured Mineral Resource has a higher level of confidence than that applying to either an Indicated Mineral Resource or an Inferred Mineral Resource. It may be converted to a Proven Mineral Reserve or to a Probable Mineral Reserve.

**Metallurgy** The science and art of separating metals and metallic minerals from their ores by mechanical and chemical processes.

**Metamorphic** Affected by physical, chemical, and structural processes imposed by depth in the earth's crust.

**Mill** A plant in which ore is treated and metals are recovered or prepared for smelting; also a revolving drum used for the grinding of ores in preparation for treatment.

**Mine** An excavation beneath the surface of the ground from which mineral matter of value is extracted.

**Mineral** A naturally occurring homogeneous substance having definite physical properties and chemical composition and, if formed under favourable conditions, a definite crystal form.

#### Mineral Claim/Concession

That portion of public mineral lands which a party has staked or marked out in accordance with federal or state mining laws to acquire the right to explore for and exploit the minerals under the surface.

**Mineralization** The process or processes by which mineral or minerals are introduced into a rock, resulting in a valuable or potentially valuable deposit.

#### Mineral Resource

A Mineral Resource is a concentration or occurrence of solid material of economic interest in or on the Earth's crust in such form, grade or quality and quantity that there are reasonable prospects for eventual economic extraction. The location, quantity, grade or quality, continuity and other geological characteristics of a Mineral Resource are known, estimated or

interpreted from specific geological evidence and knowledge, including sampling. Material of economic interest refers to diamonds, natural solid inorganic material, or natural solid fossilized organic material including base and precious metals, coal, and industrial minerals. The term mineral resource used in this report is a Canadian mining term as defined in accordance with NI 43-101 – Standards of Disclosure for Mineral Projects under the guidelines set out in the Canadian Institute of Mining, Metallurgy and Petroleum (the CIM), Standards on Mineral Resource and Mineral Reserves Definitions and guidelines adopted by the CIM Council on December 11, 2005 and recently updated as of May 10, 2014 (the CIM Standards).

#### Mineral Reserve

A Mineral Reserve is the economically mineable part of a Measured and/or Indicated Mineral Resource. It includes diluting materials and allowances for losses, which may occur when the material is mined or extracted and is defined by studies at Pre-Feasibility or Feasibility level as appropriate that include application of Modifying Factors. Such studies demonstrate that, at the time of reporting, extraction could reasonably be justified. The reference point at which Mineral Reserves are defined, usually the point where the ore is delivered to the processing plant, must be stated. It is important that, in all situations where the reference point is different, such as for a saleable product, a clarifying statement is included to ensure that the reader is fully informed as to what is being reported. The public disclosure of a Mineral Reserve must be demonstrated by a Pre-Feasibility Study or Feasibility Study.

#### N

##### Net Smelter Return

A payment made by a producer of metals based on the value of the gross metal production from the property, less deduction of certain limited costs including smelting, refining, transportation and insurance costs.

##### NI 43-101

National Instrument 43-101 is a national instrument for the Standards of Disclosure for Mineral Projects within Canada. The Instrument is a codified set of rules and guidelines for reporting and displaying information related to mineral properties owned by, or explored by, companies which report these results on stock exchanges within Canada. This includes foreign-owned mining entities who trade on stock exchanges overseen by the Canadian Securities Administrators (CSA), even if they only trade on Over The Counter (OTC) derivatives or other instrumented securities. The NI 43-101 rules and guidelines were updated as of June 30, 2011.

## O

Open Pit/Cut	A form of mining operation designed to extract minerals that lie near the surface. Waste or overburden is first removed, and the mineral is broken and loaded for processing. The mining of metalliferous ores by surface-mining methods is commonly designated as open-pit mining as distinguished from strip mining of coal and the quarrying of other non-metallic materials, such as limestone and building stone.
Outcrop	An exposure of rock or mineral deposit that can be seen on surface, that is, not covered by soil or water.
Oxidation	A chemical reaction caused by exposure to oxygen that results in a change in the chemical composition of a mineral.
Ounce	A measure of weight in gold and other precious metals, correctly troy ounces, which weigh 31.2 grams as distinct from an imperial ounce which weigh 28.4 grams.
oz	Abbreviation for ounce.

## P

Plant	A building or group of buildings in which a process or function is carried out; at a mine site it will include warehouses, hoisting equipment, compressors, maintenance shops, offices and the mill or concentrator.
Probable Reserve	<p>A Probable Mineral Reserve is the economically mineable part of an Indicated, and in some circumstances, a Measured Mineral Resource. The confidence in the Modifying Factors applying to a Probable Mineral Reserve is lower than that applying to a Proven Mineral Reserve.</p>
Proven Reserve	<p>A Proven Mineral Reserve is the economically mineable part of a Measured Mineral Resource. A Proven Mineral Reserve implies a high degree of confidence in the Modifying Factors.</p>
Pyrite	A common, pale-bronze or brass-yellow, mineral composed of iron and sulphur. Pyrite has a brilliant metallic luster and has been mistaken for gold. Pyrite is the most wide-spread and abundant of the sulfide minerals and occurs in all kinds of rocks.

## Q

Qualified Person Conforms to that definition under NI 43-101 for an individual: (a) to be an engineer or geoscientist with a university degree, or equivalent accreditation, in an area of geoscience, or engineering, related to mineral exploration or mining; (b) has at least five years' experience in mineral exploration, mine development or operation or mineral project assessment, or any combination of these, that is relevant to his or her professional degree or area of practice; (c) to have experience relevant to the subject matter of the mineral project and the technical report; (d) is in good standing with a professional association; and (e) in the case of a professional association in a foreign jurisdiction, has a membership designation that (i) requires attainment of a position of responsibility in their profession that requires the exercise of independent judgement; and (ii) requires (A.) a favourable confidential peer evaluation of nthe individual's character, professional judgement, experience, and ethical fitness; or (B.) a recommendation for membership by at least two peers, and demonstrated prominence or expertise in the field of mineral exploration or mining.

## R

Reclamation      The restoration of a site after mining or exploration activity is completed.

## S

Shoot              A concentration of mineral values; that part of a vein or zone carrying values of ore grade.

Stockpile         Broken ore heaped on surface, pending treatment or shipment.

Strike             The direction, or bearing from true north, of a vein or rock formation measure on a horizontal surface.

Stringer          A narrow vein or irregular filament of a mineral or minerals traversing a rock mass.

Sulphides         A group of minerals which contains sulphur and other metallic elements such as copper and zinc. Gold and silver are usually associated with sulphide enrichment in mineral deposits.

## T

Tonne             A metric ton of 1,000 kilograms (2,205 pounds).

## V

**Vein** A fissure, fault or crack in a rock filled by minerals that have travelled upwards from some deep source.

## **W**

**Wall rocks** Rock units on either side of an orebody. The hanging wall and footwall rocks of a mineral deposit or orebody.

**Waste** Unmineralized, or sometimes mineralized, rock that is not minable at a profit.

**Working(s)** May be a shaft, quarry, level, open-cut, open pit, or stope etc. Usually noted in the plural.

## **Z**

**Zone** An area of distinct mineralization.

**APPENDIX II**

**TITLE OPINION  
MINING CONCESSIONS SAN FRANCISCO PROJECT**



Av. Nuevo León No. 22 Piso 4  
Col. Hipódromo  
06100 Ciudad de México  
Tel. (52-55) 5207 2800

August 12, 2020

**MINERA MAGNA, S.A. DE C.V.**  
Blvd. Paseo de las Quintas No. 123  
Cataviñas Residencial  
83247, Hermosillo, Sonora.

At'n. Ing. Francisco Arturo Bonillas Zepeda  
Chief Executive Officer

**Re: Title Opinion mining concessions San Francisco Project.**

Dear Sirs and Mesdames:

Pursuant to your request, we are providing you with our opinion regarding title and related matters to the mining concessions, that cover the mining claims described herein-below (the "**Concessions**"), which are located in the Municipalities of Benjamin Hill, Santa Ana, and Trincheras, State of Sonora, Mexico, and upon which Molimentales del Noroeste, S.A. de C.V. ("**Molimentales**") has an interest and rights.

The information provided with respect to the Concessions is based on a search done for that purpose, during the second week of August, 2020, at the General Bureau of Mines ("**GBM**") and the Public Registry of Mining (the "**Registry**") within the Ministry of Economy.

**I) The Concessions.**

**Molimentales** is duly recorded in the Registry as the legal and beneficial holder of the Concessions, covering the mining claims listed below comprising the "**San Francisco Project**", in

which Molimentales is entitled to carry out the exploration, exploitation and beneficiation (e.g. treatment, first hand smelting and refining of mineral products) of minerals or substances regulated by the Mining Law:<sup>1</sup>

No.	Name of Mining Claim	Original Title Effective Date	Title Certificate Number	Surface Area (Ha.)
1	La Mexicana	April 29, 1991	191137	10.0000
2	Llano III	December 19, 1991	197202	500.0000
3	Llano II	December 19, 1991	197203	500.0000
4	San Francisco	February 11, 1994	198971	48.0000
5	San Francisco Dos	August 3, 1999	209618	315.6709
6	San Francisco Cuatro	February 25, 2003	219301	5,189.7042
7	Llano IV	August 31, 2004	222787	500.0000
8	Llano V	August 31, 2004	222788	500.0000
9	Timmins II Fracc. Sur	March 14, 2006	228260	20,370.0604
10	Timmins	January 24, 2006	226519	337.0770
11	Timmins III F-1	May 26, 2006	227237	346.0004
12	Timmins III F-2	May 26, 2006	227238	54.2835
13	Dulce	November 22, 2006	228428	150.0000
14	Dulce I	March 29, 2012	240007	4,325.7416
15	Pima Reducción	March 14, 2006	244788	4,977.0000
16	Norma Reducción	March 28, 2007	244787	4,989.0250
17	Patricia	March 27, 2007	229241	3,539.4141
18	Los Carlos	June 9, 2006	227334	9.0000
19	Los Carlos 2	March 5, 2002	215707	93.3800
20	Los Carlos 3	September 6, 2005	225423	177.6907
21	TMC	November 16, 2018	246752	463.3072

The following data was also obtained at the Registry:

<sup>1</sup> Articles 2, 3 and 10 of the Mining Law.



a) **"La Mexicana" title 191137**

- i. Location: Municipality of Santa Ana, State of Sonora, Mexico;
- ii. Original concessionaire: Agustin Albelais Varela, as recorded on April 29, 1991, under Entry 397, at Pages 100, Volume 262 of the Mining Concessions Book of the Registry;
- iii. Present concessionaire: **Molimentales**, as recorded on September 30, 2011, under Entry 46, at Pages 27, Volume 31 of the Mining Acts, Contracts and Agreements Book of the Registry;
- iv. Royalties: None;
- v. Liens: **Timmins Pledge** (as defined below);
- vi. Effective period: April 29, 1991 through April 28, 2041; and
- vii. Status: In force.

b) **"Llano III" title 197202**

- i. Location: Municipality of Benjamin Hill, State of Sonora, Mexico;
- ii. Original concessionaire: Bertin Arthur Field Longtin, as recorded on August 23, 1993, under Entry 342 at Pages 171, Volume 273 of the Mining Concessions Book of the Registry;
- iii. Present concessionaire: **Molimentales**, as recorded on October 12, 2007, under Entry 113, at Pages 62, Volume 22 of the Mining Acts, Contracts and Agreements Book of the Registry;
- iv. Royalties: None;
- v. Effective period: December 19, 1991 through December 18, 2041;
- vi. Liens:
  - **Los Algodones Seizure** (as defined below); and
  - **Peal Seizure** (as defined below).
- vii. Status: In force.

c) "Llano II" title 197203

- i. Location: Municipality of Benjamin Hill, State of Sonora, Mexico;
- ii. Original concessionaire: Bertin Arthur Field Longtin, as recorded on August 27, 1993, under Entry 343, at Pages 172, Volume 273 of the Mining Concessions Book of the Registry;
- iii. Present concessionaire: **Molimentales**, as recorded on October 12, 2007, under Entry 113, at Pages 62, Volume 22 of the Mining Acts, Contracts and Agreements Book of the Registry;
- iv. Liens:
  - **Los Algodones Seizure**; and
  - **Peal Seizure**.
- v. Royalties: None;
- vi. Effective period: December 19, 1991 through December 18, 2041; and
- vii. Status: In force.

d) "San Francisco" title 198971

- i. Location: Municipality of Santa Ana, State of Sonora, Mexico;
- ii. Original concessionaire: Cia. Minera Fresnillo, S.A. de C.V., as recorded on February 11, 1994, under Entry 311, at Pages 156, Volume 278 of the Mining Concessions Book of the Registry;
- iii. Present concessionaire: **Molimentales**, as recorded on October 12, 2007, under Entry 113, at Pages 62, Volume 22 of the Mining Acts, Contracts and Agreements Book of the Registry;
- iv. Liens:
  - **Los Algodones Seizure**; and
  - **Peal Seizure**.
- v. Royalties: None;

- vi. Effective period: February 11, 1994 through February 10, 2044.
  - vii. Status: In force.
- e) **“San Francisco Dos” title 209618**
- i. Location: Municipality of Santa Ana, State of Sonora, Mexico;
  - ii. Original concessionaire: Geomaque de Mexico, S.A. de C.V., as recorded on August 3, 1999, under Entry 158, at Pages 79, Volume 308 of the Mining Concessions Book of the Registry;
  - iii. Present concessionaire: **Molimentales**, as recorded on October 12, 2007, under Entry 113, at Pages 62, Volume 22 of the Mining Acts, Contracts and Agreements Book of the Registry;
  - iv. Liens:
    - **Los Algodones Seizure;** and
    - **Peal Seizure.**
  - v. Royalties: None;
  - vi. Effective period: August 3, 1999 through August 2, 2049; and
  - vii. Status: In force.
- f) **“San Francisco Cuatro” title 219301**
- i. Location: Municipality of Santa Ana, State of Sonora, Mexico;
  - ii. Original concessionaire: Geomaque de Mexico, S.A. de C.V., as recorded on February 25, 2003, under Entry 121, at Pages 61, Volume 335 of the Mining Concessions Book of the Registry;
  - iii. Present concessionaire: **Molimentales**, as recorded on May 30, 2008, under Entry 113, Volume 22 of the Mining Acts, Contracts and Agreements Book of the Registry;
  - iv. Liens:
    - **Los Algodones Seizure;** and
    - **Peal Seizure.**
  - v. Royalties: None;

- vi. Effective period: February 25, 2003 through February 24, 2053; and
- vii. Status: In force.

g) **"Llano IV" title 222787**

- i. Location: Municipality of Santa Ana, State of Sonora, Mexico;
- ii. Original concessionaire: Auteq Mexicana, S.A. de C.V., as recorded on August 31, 2004, under Entry 7, at Pages 4, Volume 345 of the Mining Concessions Book of the Registry;
- iii. Present concessionaire: **Molimentales**, as recorded on July 13, 2007, under Entry 258, at Pages 149, Volume 21 of the Mining Acts, Contracts and Agreements Book of the Registry;
- iv. Liens:
  - **Los Algodones Seizure;** and
  - **Peal Seizure.**
- v. Royalties: None;
- vi. Effective period: August 31, 2004 through August 30, 2054; and
- vii. Status: In force.

h) **"Llano V" title 222788**

- i. Location: Municipality Santa Ana, of State of Sonora, Mexico;
- ii. Original concessionaire: Auteq Mexicana, S.A. de C.V., as recorded on August 31, 2004, under Entry 8, at Pages 4, Volume 345 of the Mining Concessions Book of the Registry;
- iii. Present concessionaire: **Molimentales**, as recorded on July 13, 2007, under Entry 258, at Pages 149, Volume 21 of the Mining Acts, Contracts and Agreements Book of the Registry;
- iv. Liens:
  - **Los Algodones Seizure;** and

- **Peal Seizure.**

- v. Royalties: None;
- vi. Effective period: August 31, 2004 through August 30, 2054; and
- vii. Status: In force.

i) **“Timmins II Fracc. Sur” title 228260**

- i. Location: Municipality of Santa Ana, State of Sonora, Mexico;
- ii. Original concessionaire: Timmins Goldcorp Mexico, S.A. de C.V., as recorded on October 17, 2006, under Entry 80, at Pages 40, Volume 360 of the Mining Concessions Book of the Registry;
- iii. Present concessionaire: **Molimentales**, as recorded on April 10, 2015, under Entry 148, at Pages 157, Volume 37 of the Mining Acts, Contracts and Agreements Book of the Registry;

- iv. Liens:

- **Timmins Pledge.**

- v. Royalties. None;
- vi. Effective period: March 14, 2006 through March 13, 2056; and
- vii. Status: In force.

j) **“Timmins” title 226519**

- i. Location: Municipality of Santa Ana, State of Sonora, Mexico;
- ii. Original concessionaire: Timmins Goldcorp Mexico, S.A. de C.V., as recorded on January 24, 2006, under Entry 139, at Pages 70, Volume 355 of the Mining Concessions Book of the Registry;
- iii. Present concessionaire: **Molimentales**, as recorded on October 31, 2013, under Entry 296, at Pages 174, Volume 34 of the Mining Acts, Contracts and Agreements Book of the Registry;
- iv. Liens:

- **Timmins Pledge.**
- v. Royalties: None;
- vi. Effective period: January 24, 2006 through January 23, 2056; and
- vii. Status: In force.

k) **"Timmins III F-1" title 227237**

- i. Location: Municipality of Santa Ana, State of Sonora, Mexico;
- ii. Original concessionaire: Timmins Goldcorp Mexico, S.A. de C.V., as recorded on May 26, 2006, under Entry 137, at Pages 69, Volume 357 of the Mining Concessions Book of the Registry;
- iii. Present concessionaire: **Molimentales**, as recorded on October 31, 2013, under Entry 296, at Pages 174, Volume 34 of the Mining Acts, Contracts and Agreements Book of the Registry;

iv. Liens:

- **Timmins Pledge.**
- v. Royalties: None;
- vi. Effective period: May 26, 2006 through May 25, 2056; and
- vii. Status: In force.

l) **"Timmins III F-2" title 227238**

- i. Location: Municipality of Santa Ana, State of Sonora, Mexico;
- ii. Original concessionaire: Timmins Goldcorp Mexico, S.A. de C.V., as recorded on May 26, 2006, under Entry 138, at Pages 69, Volume 357 of the Mining Concessions Book of the Registry;
- iii. Present concessionaire: **Molimentales**, as recorded on October 31, 2013, under Entry 296, at Pages 174, Volume 34 of the Mining Acts, Contracts and Agreements Book of the Registry;

- iv. Liens:
  - **Timmins Pledge.**
- v. Royalties: None;
- vi. Effective period: May 26, 2006 through May 25, 2056; and
- vii. Status: In force.

m) **"Dulce" title 228428**

- i. Location: Municipality of Santa Ana, State of Sonora, Mexico;
- ii. Original concessionaire: Joel Eulogio Rodriguez Barraza, as recorded on November 22, 2006, under Entry 248, at Pages 124, Volume 360 of the Mining Concessions Book of the Registry;
- iii. Present concessionaire: **Molimentales**, as recorded on June 12, 2015, under Entry 49, at Pages 27, Volume 38 of the Mining Acts, Contracts and Agreements Book of the Registry;
- iv. Liens:
  - **Timmins Pledge.**
- v. Royalties: This concession was acquired by Molimentales through Transfer Agreement entered into with Joel Eulogio Rodríguez Barraza (original concessionaire and assignor), whereby Molimentales should pay to the assignor a NSR Royalty of 1.5% (one point five percent).
- vi. Effective period: November 22, 2006 through November 21, 2056; and
- vii. Status: In force.

n) **"Dulce I" title 240007**

- i. Location: Municipality of Santa Ana, State of Sonora, Mexico;
- ii. Original concessionaire: Timmins Goldcorp Mexico, S.A. de C.V., as recorded on March 29, 2012, under Entry 307, at Pages 154, Volume 392 of the Mining Concessions Book of the Registry;

- iii. Present concessionaire: **Molimentales**, as recorded on October 31, 2013, under Entry 296, at Pages 174, Volume 34 of the Mining Acts, Contracts and Agreements Book of the Registry;
  - iv. Liens:
    - **Timmins Pledge.**
  - v. Royalties: None;
  - vi. Effective period: March 29, 2012 through March 28, 2062; and
  - vii. Status: In force.
- o) **"Pima Reducción" title 244788**
- i. Location: Municipalities of Santa Ana and Trincheras, State of Sonora, Mexico;
  - ii. Original concessionaire: Timmins Goldcorp Mexico, S.A. de C.V., as recorded on October 17, 2006, under Entry 81, at Pages 41, Volume 360 of the Mining Concessions Book of the Registry;
  - iii. Present concessionaire: **Molimentales**, as recorded on April 10, 2015, under Entry 148, at Pages 157, Volume 37 of the Mining Concessions Book of the Registry;
  - iv. Liens:
    - **Timmins Pledge.**
  - v. Royalties: None;
  - vi. Effective period: March 14, 2006 through March 13, 2056; and
  - vii. Status: In force.
- p) **"Norma Reducción" title 244787**
- i. Location: Municipality of Trincheras, State of Sonora, Mexico;
  - ii. Original concessionaire: Timmins Goldcorp Mexico, S.A. de C.V., as recorded on March 28, 2007, under Entry 357, at Pages 179, Volume 362 of the Mining Concessions Book of the Registry;
  - iii. Present concessionaire: **Molimentales**, as recorded on October 31, 2013, under Entry 296, at Pages 174, Volume 34 of the Mining Concessions Book of the Registry;



- iv. Liens:
  - **Timmins Pledge.**
- v. Royalties: None;
- vi. Effective period: March 28, 2007 through March 27, 2057; and
- vii. Status: In force.

q) **"Patricia" title 229241**

- i. Location: Municipality of Trincheras, State of Sonora, Mexico.
- ii. Original concessionaire: Timmins Goldcorp Mexico, S.A. de C.V., as recorded on March 27, 2007, under Entry 341, at Pages 171, Volume 362 of the Mining Concessions Book of the Registry;
- iii. Present concessionaire: **Molimentales**, as recorded on October 31, 2013, under Entry 296, at Pages 174, Volume 34 or the Mining Acts, Contracts and Agreements Book of the Registry;
- iv. Liens:
  - **Timmins Pledge.**
- v. Royalties: None;
- vi. Effective period: March 27, 2007 through March 26, 2057; and
- vii. Status: In force.

r) **Los Carlos title 227334**

- i. Location: Municipality of Trincheras, State of Sonora, Mexico;
- ii. Original concessionaires: Carlos Alberto Valenzuela Cruz (50%) and Francisco Javier Quijada Peralta (50%) as recorded on June 9, 2006, under Entry 234, at Pages 117, Volume 357 of the Mining Concessions Book of the Registry;
- iii. Present concessionaire: **Molimentales** (100%), as recorded on June 12, 2015, under Entry 50, at Pages 28, Volume 38 or the Mining Acts, Contracts and Agreements Book of the Registry;

- iv. Liens:
  - **Timmins Pledge.**
- v. Royalties: None;
- vi. Effective period: June 9, 2006 through June 8, 2056; and
- vii. Status: In force.

s) **Los Carlos 2 title 215707**

- i. Location: Municipality of Trincheras, State of Sonora, Mexico;
- ii. Original concessionaire: Carlos Alberto Valenzuela Cruz, as recorded on March 5, 2002, under Entry 127, at Pages 64, Volume 325 of the Mining Concessions Book of the Registry;
- iii. Present concessionaire: **Molimentales**, as recorded on June 12, 2015, under Entry 50, at Pages 28, Volume 38 or the Mining Acts, Contracts and Agreements Book of the Registry
- iv. Liens:
  - **Timmins Pledge.**
- v. Royalties: None;
- vi. Effective period: March 5, 2002 through March 4, 2052; and
- vii. Status: In force.

t) **Los Carlos 3 title 225423**

- i. Location: Municipality of Trincheras, State of Sonora, Mexico;
- ii. Original concessionaires: Carlos Alberto Valenzuela Cruz (50%) and Francisco Javier Quijada Peralta (50%) as recorded September 6, 2005, under Entry 123, at Pages 62, Volume 352 of the Mining Concessions Book of the Registry;
- iii. Present concessionaire: **Molimentales** (100%), as recorded on June 12, 2015, under Entry 50, at Pages 28, Volume 38 or the Mining Acts, Contracts and Agreements Book of the Registry;

- iv. Liens:
  - **Timmins Pledge.**
- v. Royalties: None;
- vi. Effective period: September 6, 2005 through September 5, 2055; and
- vii. Status: In force

u) **TMC title 246752**

- i. Location: Municipality of Santa Ana, State of Sonora, Mexico;
- ii. Original concessionaire: **Molimentales** as recorded November 16, 2018, under Entry 212, at Pages 106, Volume 411 of the Mining Concessions Book of the Registry;
- iii. Liens: None;
- iv. Royalties: None;
- v. Effective period: November 16, 2018 through November 15, 2068; and
- vi. Status: In force

**2) Liens.**

- i) The Registry keeps the entry of a Non-possessory pledge by unilateral declaration dated August 1, 2018, in favor of Timmins Goldcorp Mexico, S.A. de C.V. ("**Timmins**"), recorded on April 29, 2019, under Entry 104, Volume 42, of the Mining Acts, Contracts and Agreements Book of the Registry, ("**Timmins Pledge**");

Except for seven Concessions (namely, "San Francisco", "San Francisco Dos", "San Francisco Cuatro", "Llano II", "Llano III", "Llano IV" and "Llano V") the Timmins Pledge affects the remaining twenty-one Concessions.

The Timmins Pledge is cancelled in terms of the Termination Pledge Agreement dated May 7, 2020 entered into by and between Molimentales and Timmins, in process to be recorded before the Registry, on dated July 29, 2020.

- ii) The Registry keeps the entry of a cautionary embargo requested by Inmobiliaria y Hotelera Los Algodones, S.A. de C.V. ("**Algodones**") affecting seven Concessions

(namely, "San Francisco", "San Francisco Dos", "San Francisco Cuatro", "Llano II", "Llano III", "Llano IV" and "Llano V") ("Los Algodones Seizure")<sup>2</sup>.

With respect to the Los Algodones Seizure, we assume that Algodones filed an executive mercantile lawsuit against Molimentales claiming the remaining balance of the sale price of the five Concessions named "San Francisco", "San Francisco Dos", "San Francisco Cuatro", "Llano II" and "Llano III" sold by Geomaque de Mexico, S.A. de C.V. to Molimentales for the amount of US\$1,725,000.

Molimentales was ordered to pay the amount of the promissory note, being US\$1,725,000 plus court costs in the amount of US\$127,000. The judgement was appealed and the appeal court confirmed the judgement. Therefore, an amparo complaint was filed and the court ordered that Molimentales' arguments be reviewed. The first judgement was again confirmed and a new amparo complaint was filed, which is still under review.

Regarding the above-mentioned proceedings, the court ordered the Algodones Seizure and in this regard, we are of the opinion that:

- a) The Los Algodones Seizure guarantees, under a certain ranking, Algodones' rights to receive payment of the amounts claimed from Molimentales in the commercial proceedings;
  - b) As a result of the Los Algodones Seizure, Molimentales has restrictions on the disposition of the affected Concessions (e.g. their transfer, reduction of surface area and withdrawal);
  - c) To achieve free and clear title to each affected property: a') In the event of a final judgement contrary to Molimentales, the latter would have to pay Algodones the amounts claimed in the commercial proceedings; or b') the parties would have to enter into a settlement agreement in such proceedings to resolve their disputes; and
  - d) The non-compliance by Molimentales with any contractual arrangements or the terms of its business activities is not a cause of cancellation or loss of the affected Concessions.
- iii)** The Registry keeps the entry of a cautionary embargo requested by Peal de México, S.A. de C.V. ("**Peal**") affecting seven Concessions (namely, "San Francisco", "San Francisco Dos", "San Francisco Cuatro", "Llano II", "Llano III", "Llano IV" and

<sup>2</sup> Cautionary seizure ordered by the Fourth Mercantile Judge based in Hermosillo, State of Sonora, Mexico, recorded on March 15, 2013 under Entry 113, at Page 62, Volume 22 of the Mining Acts, Contracts and Agreements Book of the Registry.

"Llano V") ("Peal Zeizure")<sup>3</sup>, which we assume is related to the arbitration proceedings (the "Arbitration") followed by Peal against Molimentales, for alleged breaches of the so-called "Commercial Work Agreement based on unit prices" (*Contrato Mercantil, de obra determinada en base a precios unitarios*), entered into by and between Molimentales and Peal on September 17, 2009.

In the Arbitration, Peal has claimed the payment of: **a')** US\$7,371, 548.00) for certain outstanding service invoices; **b')** US \$ 21,295,151.35 for conventional penalty and demobilization costs; and **c')** legal interest at the annual rate of 6%.

The Arbitration has been followed in Hermosillo, State of Sonora, Mexico. Molimentales has asserted its arguments against Peal's claims and, as of the date hereof, the parties are reviewing the Terms of Reference draft proposed by the Arbitration Court.

In relation to the Peal Seizure, we are of the opinion that:

- a) The Peal Seizure guarantees, under a certain ranking, Peal's rights to receive payment of the amounts claimed from Molimentales in the Arbitration;
- b) As the parties in the Arbitration process reached a settlement agreement, the Arbitration Court will issue the award based on the agreement celebrated by the parties, award that we are expecting to receive in the following days;
- c) With the award the arbitration process will be over and being that Peal withdraw the seizure order or that Molimentales ask the Judge to dismiss the seizure, the seizure is going to be over; and
- d) The non-compliance by Molimentales with any contractual arrangements or the terms of its business activities is not a cause of cancellation or loss of the affected Concessions.

### 3) **Mining Obligations.**

**Classification.** The obligations which the holders of concessions must comply in order to maintain their concessions in full force and effect, pursuant to the Mexican Mining Law and its Regulations and the Federal Fees Law are as follows:

- i) **Assessment of Work Report.** During the month of May of each year, the holder must file with the GBM, the Work Assessment Reports made on each concession or group

<sup>3</sup> Cautionary seizure recorded on July 4, 2019 under Entry 185, Volume 35, of the Mining Acts, Contracts and Agreements Book of the Registry.

of concessions for the immediately preceding calendar year. The Regulations to the Mining Law establish the tables containing the minimum investment amounts that must be made on a concession. The amount will be updated annually in accordance with the variation of the Consumer Price Index;

As a result of our search done at the GBM, we found that Molimentales filed the exploitation work assessment reports with respect to the Concessions, for the latest five years. This evidences fulfilment of the obligation to which this subparagraph i) refers.

- ii) **Mining Duties.** During the months of January and July of each year, the holders must pay the mining duties for the areas that pertain to each concession (on a per hectare basis), and they must file before the GBM evidence of mining duties payments during the months of February and August of each year, respectively.

As a result of our research done at the GBM, we found that Molimentales filed evidence of mining duties payments for the latest five fiscal years and for the second biannual period ending 31 December 2020. This confirms fulfilment of the obligation to which this subparagraph ii) refers.

- iii) **Production Report.** During the first 30 working days of each year, the concession holders must file before the GBM, using the authorized forms and applications, the ore Production Reports including accurate information on the minerals and production obtained on each concession or group of concessions for the immediately preceding calendar year for statistical purposes.

Regarding the Production Reports, at of the date hereof pursuant to the Mining Legislation and its Regulations, the Concessions are in good standing.

#### 4) **Opinion.**

Based on our research done at the GBM and the Registry, we are of the opinion that:

- 4.1 Molimentales is registered with the Registry<sup>4</sup> as a company duly incorporated pursuant to the mining legislation of Mexico, and since it: (a) has a corporate purpose that provides, among other things, the exploration or exploitation of minerals or substances subject to the application of the Mining Law; (b) has its legal domicile within Mexico; and (c) has participation by foreign investors that complies with the

<sup>4</sup> Under minute number 158, Volume XXXIX, of the Companies Book of the Registry, dated January 12, 2007.

provisions of the Foreign Investment Law, it is our opinion that Molimentales is legally qualified to hold the Concessions.<sup>5</sup>

**4.2** Having found that Molimentales filed the Exploitation Work Assessment Reports with respect to the Concessions on time, for the latest five fiscal years, the Concessions are up to date on fulfilment of the obligation to which paragraph 3) i) above refers.

**4.3** Having found that Molimentales filed before the GBM evidence of the mining duties payments for the latest five fiscal years and covering the second biannual period ending 31 December 2020, the Concessions are up to date on fulfilment of the obligation to which paragraph 3) ii) above refers.

Other than mining duties and other regulatory requirements described hereto, pursuant to the applicable provisions of the Mexican mining legislation, there are no outstanding obligations that need to be fulfilled presently in order to maintain the legal ownership of the Concessions.

**4.4** Having found that Molimentales filed Production Reports with respect to the Concessions on time, for the latest five fiscal years, the Concessions are up to date on fulfilment of the obligation to which paragraph 3) iii) above refers.

**4.5** Based on our research done at the GBM, it is our opinion that the Concessions are in good standing, and except for: **i)** the Algodones Seizure; **ii)** Peal Seizure in process to be cancelled; **iii)** the Timmins Pledge in process to be cancelled; and **iv)** the Dulce Royalty, the Concessions are free of any liens or encumbrances, and currently valid for purposes of exploitation of the properties covered by their certificates issued by the GBM, pursuant to the Mexican mining legislation; and

**4.6** The Los Algodones Seizure guarantee, under a certain ranking, the rights of each creditor to receive payment of the amounts claimed from Molimentales in the legal procedures mentioned in Section 2 above.

As a result of the Los Algodones Seizure, Molimentales has restrictions on the disposition of the affected Concessions (e.g. their transfer, reduction of surface area and withdrawal).

To achieve free and clear title to each affected property: **i)** In the event of a judgement or an award contrary to Molimentales, respectively, the latter would have to pay the amounts claimed by Algodones, respectively, in the legal procedures mentioned in

<sup>5</sup> Pursuant to Article 11 of the Mining Law

section 2 above; or **ii**) the parties would have to enter into a settlement agreement in such procedures to resolve their disputes.

The non-compliance by Molimentales with any contractual arrangements or the terms of its business activities is not a cause of cancellation or loss of the affected Concessions.

We, DBR Abogados, S.C., are a law firm qualified to practice law in Mexico. We express no opinion as to any laws other than the federal laws of Mexico and we have assumed that there is nothing in any other law that affects our opinion, which is delivered, based upon applicable law as of the date hereof. In particular, we have made no independent investigation of the laws of Canada or any jurisdiction thereof as a basis for the opinions stated herein and do not express or imply any opinion on or based on the criteria or standards provided for in such laws. We express no opinions as to any matters (including change of law or other circumstances) arising subsequent to the date hereof.

In order to provide this opinion, we have assumed: **(i)** the authenticity of all of the documents provided, **(ii)** the genuineness of all of the signatures in the documents, **(iii)** the validity and authenticity of all of the seals affixed thereto, and **(iv)** the veracity of all of the representations made and information provided in all of those documents.

This opinion is solely for the benefit of the **Minera Magna**, and contains no prohibitions on its use for the purposes required for the review; no other entity or person shall be entitled to rely on its contents without the express written consent of DBR Abogados, S.C.

Should you have any questions regarding this opinion, please do not hesitate to call on us.

Yours truly,

**DBR Abogados, S.C.**



**Alejandro Hernández Muñoz**





**APPENDIX III**

**VIEWS OF THE SAN FRANCISCO AND LA CHICHARRA PITS  
FROM 2008 TP 2020**

**AND**

**DIAGRAMS SHOWING THE YEARLY GROWTH OF THE PITS  
FROM 2009 TO 2019**

Figure A to Figure E are views of the San Francisco pit during the site visits in 2008, 2010, 2011, 2013, 2016, 2017 and 2020. Figure F to Figure K are views of the La Chicharra pit during the site visits in 2010, 2016, and 2017. In order to demonstrate the yearly growth of the San Francisco pit since Alio resumed mining in 2009 and the extent of mining up to 2019, a plan view of the current pit (Figure L) outlining the locations of a longitudinal section (Figure M), and a cross-section (Figure N) of the pit, are provided to show the annual pit limits in these areas. The yearly growth of and the extent of the mining up to 2019 for the La Chicharra pit is demonstrated in Figure O (plan view), Figure P (longitudinal section) and Figure Q (cross-section).

**Figure A**  
**San Francisco Pit in 2008 (Looking West-Southwest)**



Photograph taken from the March, 2008, Micon Technical Report.

**Figure B**  
**San Francisco Pit in 2008 (Looking South towards the Waste Dumps)**



Photograph taken from the March, 2008, Micon Technical Report.

**Figure C**  
**RC Rigs Northwest of the San Francisco Pit during the 2010 Drill Program (Looking Southeast)**



Figure provided by Timmins Goldcorp Mexico, S.A. de C.V. for the November, 2010, Micon Technical Report

**Figure D**  
**View of the San Francisco Pit in July, 2011**  
**(Looking West-Southwest)**



Photograph taken during the July, 2011 Micon site visit. Incorrectly labelled (Looking West-Northwest) in prior reports.

**Figure E**  
**View of the San Francisco Pit in August, 2013**  
**(Looking East-Northeast)**



Photograph taken during the August, 2013 Micon site visit.

**Figure F**  
**View of the San Francisco Pit in February, 2016 (Looking East-Northeast)**



Photograph taken during the February, 2016 Micon site visit.

**Figure G**  
**View of the San Francisco Pit in May, 2017 (Looking East-Northeast)**



Photograph taken during the May, 2017 Micon site visit.

**Figure H**  
**View of the San Francisco Pit as of February, 2020 (Looking East)**



Figure supplied by Magna Gold Corp. in March, 2020.

**Figure I**  
**La Chicharra Pit Looking Southeast showing the Regional Geological Lineament**

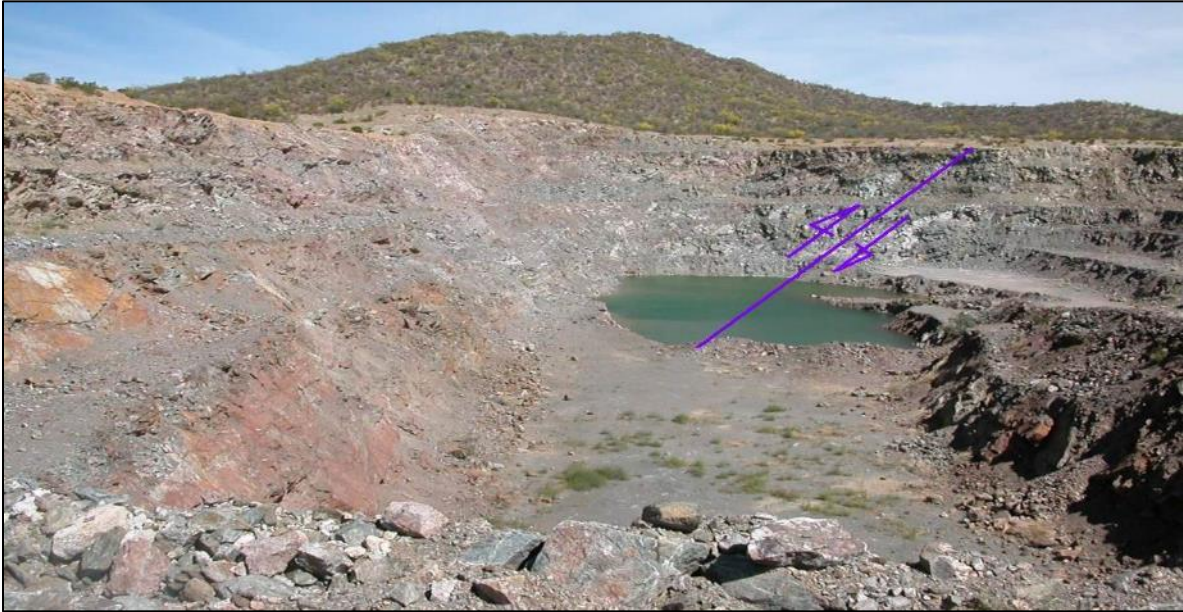


Figure taken from the November, 2010 Micon Technical Report, originally incorrectly reported as looking Southwest

**Figure J**  
**View of the La Chicharra Pit in February, 2016 (Looking to the East)**



Photograph taken during the February, 2016 Micon site visit.



**Figure K**  
**View of the La Chicharra Pit in May, 2017 (Looking to the West Northwest)**



Photograph taken during the May, 2017 Micon site visit.

**Figure L**  
**Plan View of the San Francisco Pit Showing the Location of the Longitudinal and Cross-Sections Demonstrating the Growth of the Pit Since 2009**

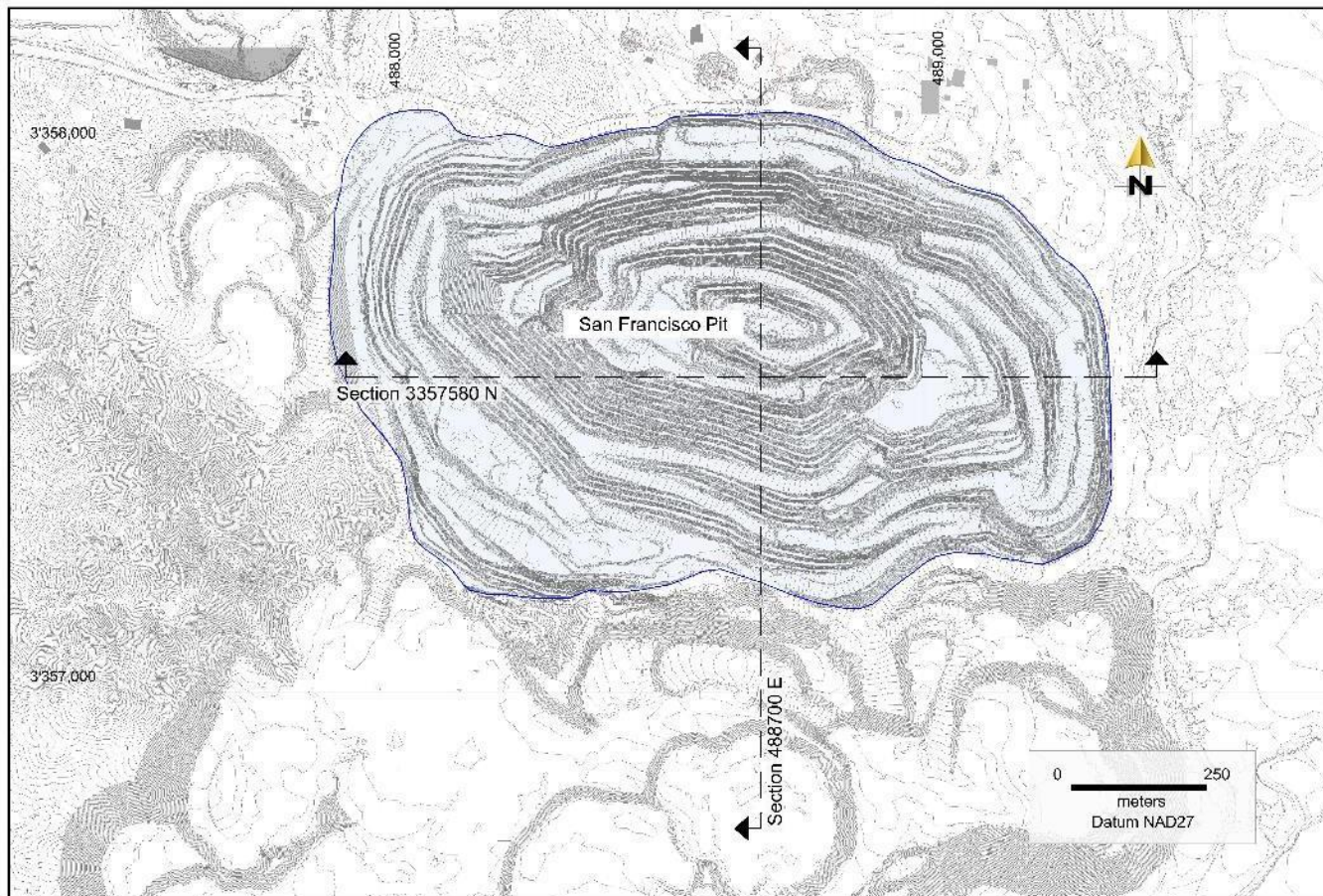


Figure provided by Magna Gold Corp. dated March, 2020.

**Figure M**  
**Longitudinal Section (3357580 North) Demonstrating the Growth of the San Francisco Pit Since 2009**

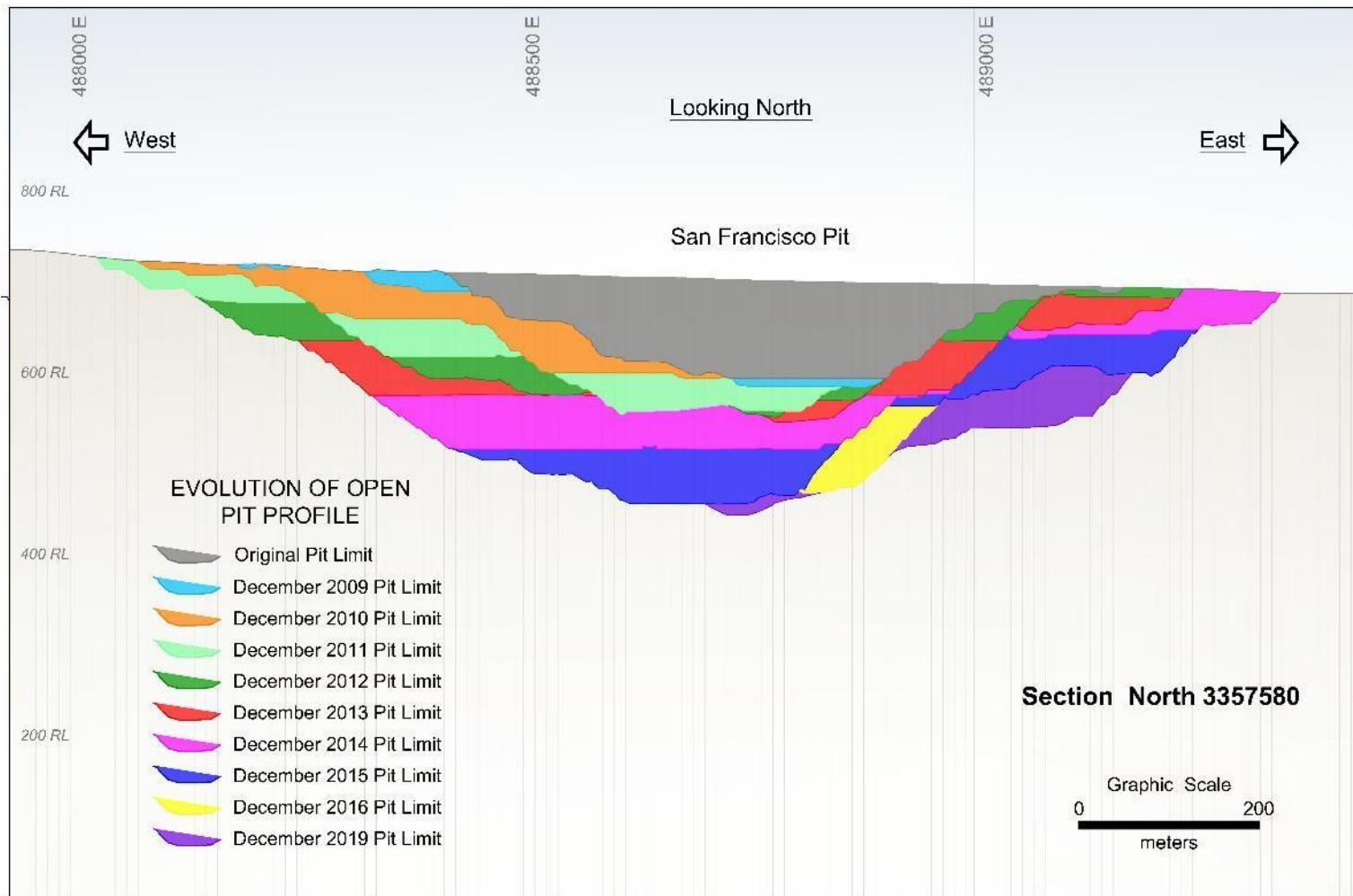


Figure provided by Magna Gold Corp. dated March, 2020.

**Figure N**  
**Cross-Section (488700 East) Demonstrating the Growth of the San Francisco Pit Since 2009**

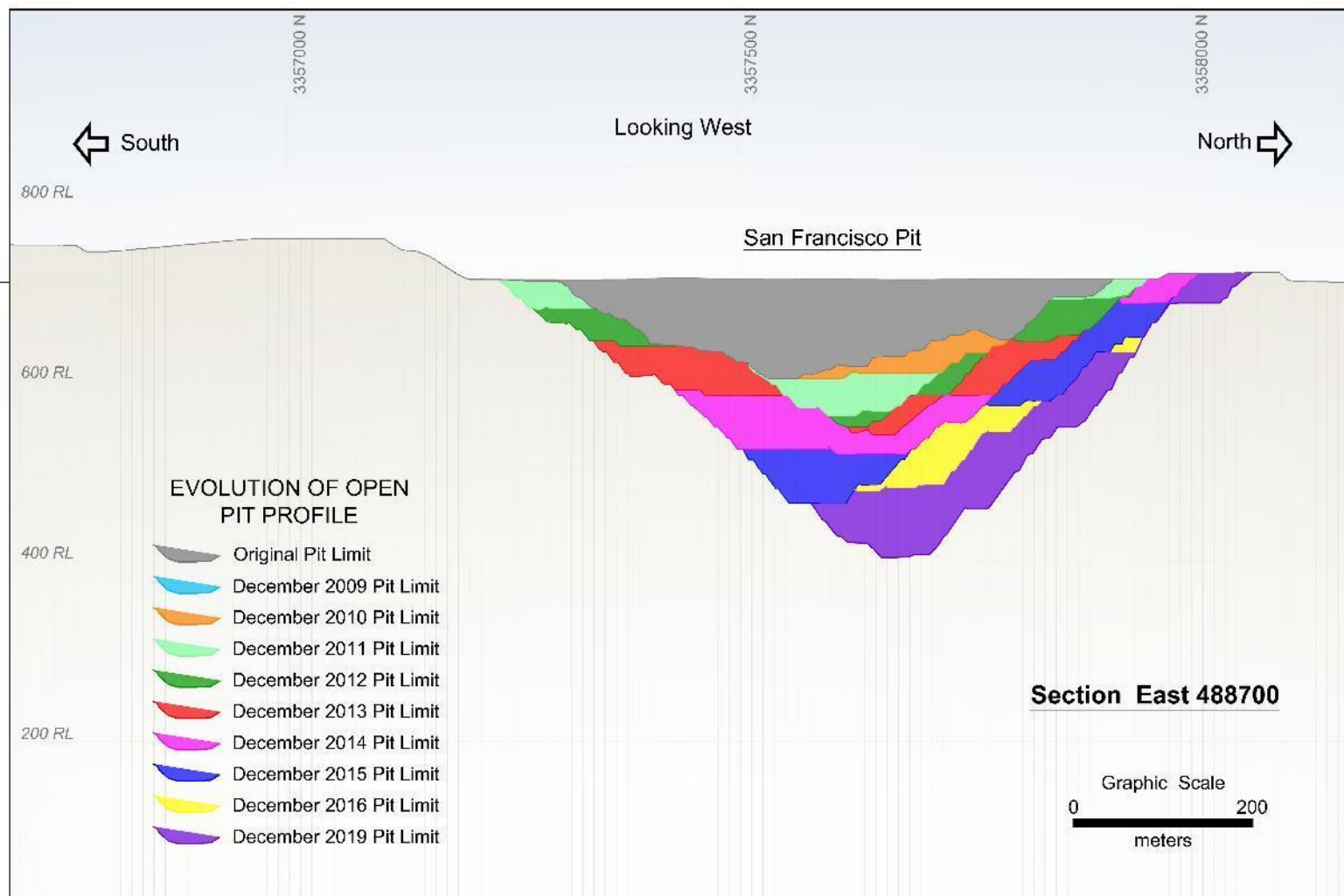


Figure provided by Magna Gold Corp. dated March, 2020.

**Figure O**  
**Plan View of the La Chicharra Pit Showing the Location of the Longitudinal and Cross-Sections Demonstrating the Growth of the Pit Since 2009**

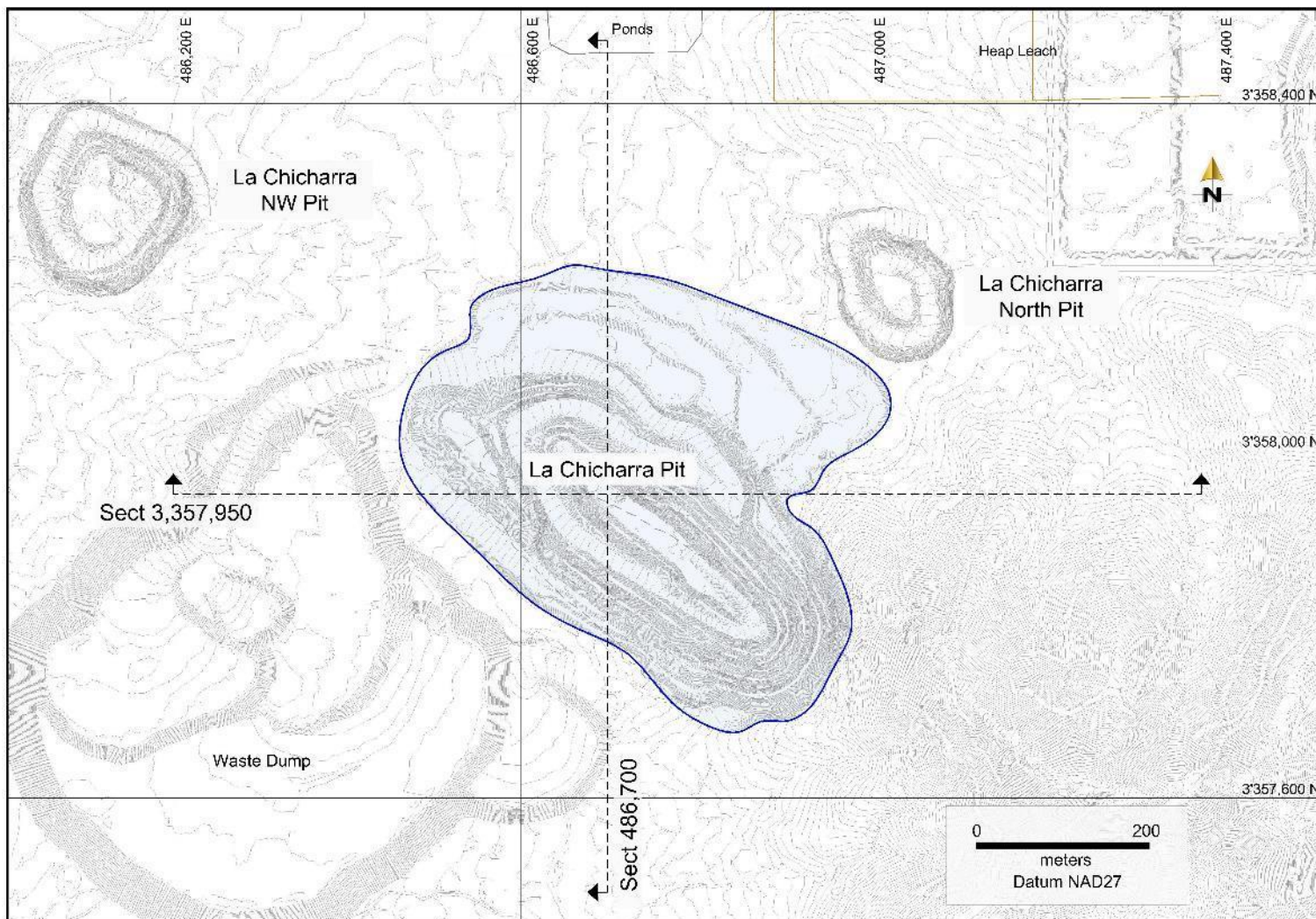


Figure provided by Magna Gold Corp. dated March, 2020.

**Figure P**  
**Longitudinal Section (3357950 North) Demonstrating the Growth of the La Chicharra Pit Since 2009**

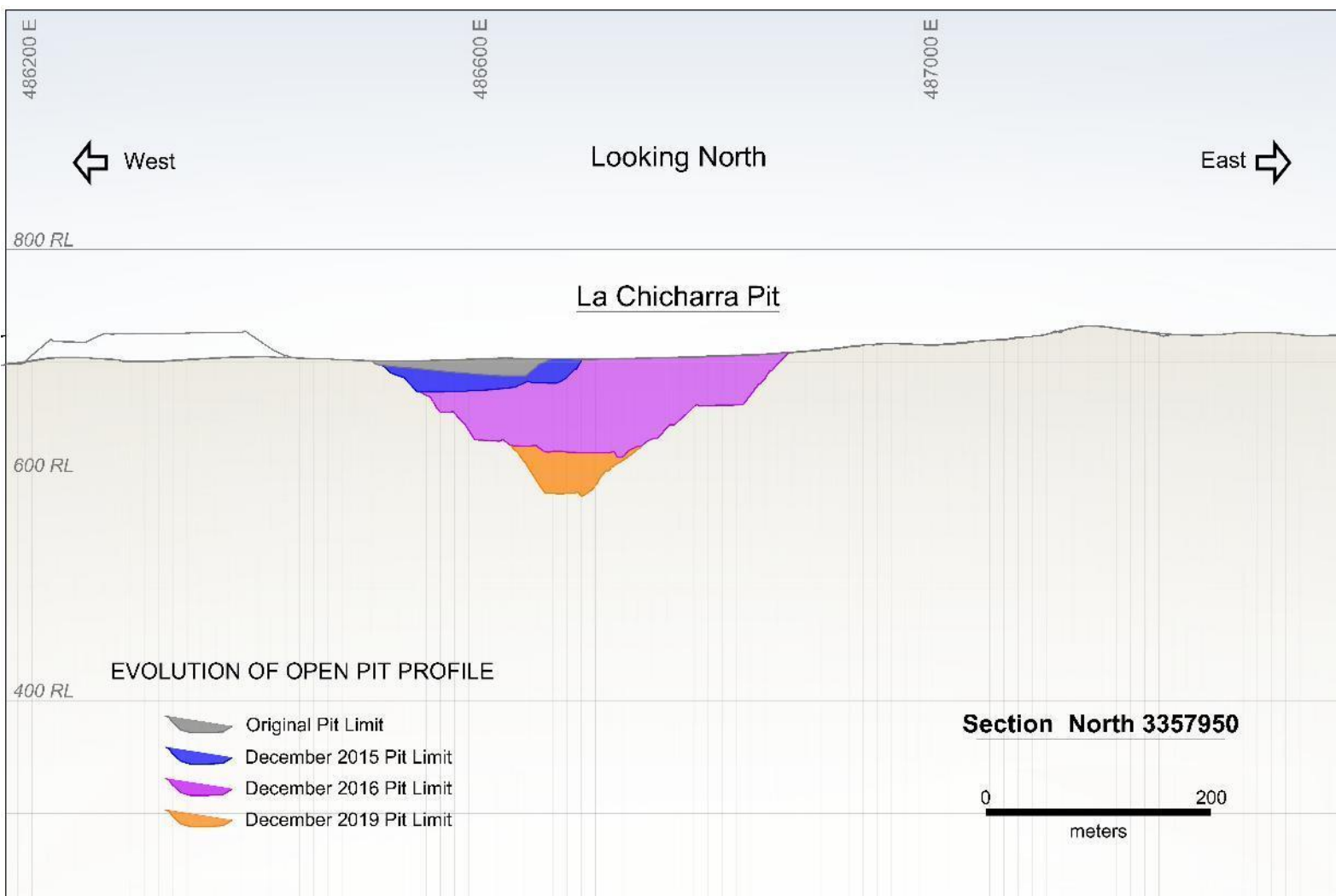


Figure provided by Magna Gold Corp. dated March, 2020.

**Figure Q**  
**Cross-Section (488700 East) Demonstrating the Growth of the La Chicharra Pit Since 2009**

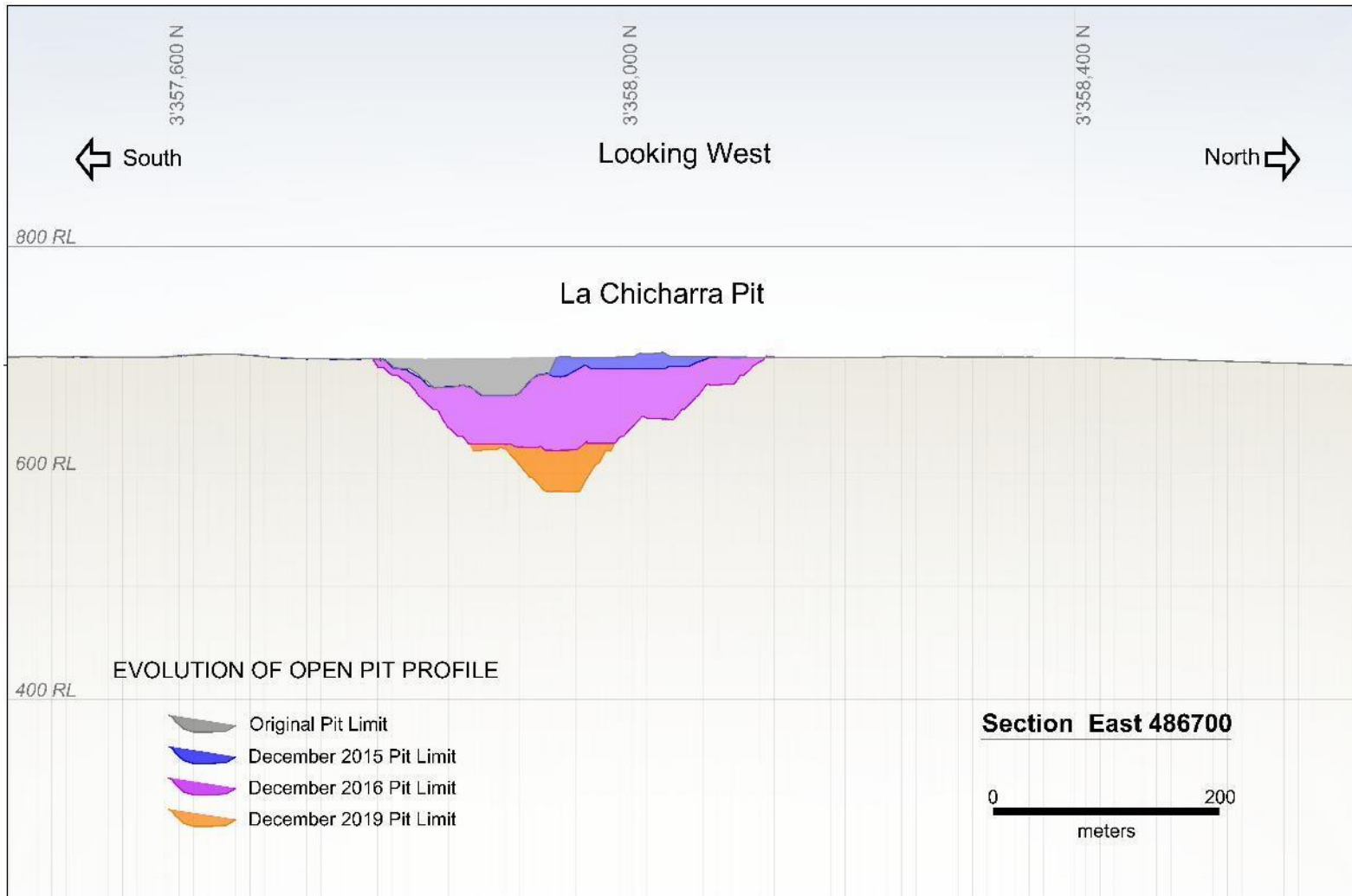


Figure provided by Magna Gold Corp. dated March, 2020.

## **APPENDIX IV**

### **EXTRACTS FROM ALIO GOLD 2017 TO 2020 PRESS RELEASES REGARDING THE SAN FRANCISCO PROJECT**



Some Relevant Extracts from Previous Press Releases Related to San Francisco Operations by Alio

**November 9, 2017 Press Release** “*Alio Gold Provides Third Quarter 2017 Update*”

*“The Revitalization Plan announced during the second quarter which includes a significant pre-stripping campaign, modifying the crusher and upgrading the power infrastructure continued to advance during the third quarter. The pre-stripping campaign envisions moving approximately 22 million tonnes of waste from the San Francisco Main pit and the La Chicharra pit over the next 20 months. Pre-stripping of Phase 6 of the San Francisco Main pit commenced in July 2017 and a second contractor mobilized a team in October, 2017 to undertake pre-stripping Phase 2 of the La Chicharra pit. During the quarter, significant stripping to fully access Phase 5 occurred that will be the primary ore source for Q4 and the first half of 2018. The main ore zone in Phase 5 was not accessed until the first week in November, approximately 3 months behind plan.”*

*“The crusher improvement project is advancing with the decision to add a high pressure grinding role (‘HPGR’) to the circuit. The scope of the project has been determined and a purchase order to initiate the logistics for the fabrication of the HPGR was signed. It is expected that the HPGR would be fully operational in late 2018. The crushing circuit modifications are expected to improve gold recovery and increase reliability.”*

*“The update to the power infrastructure is underway and the power substation has been ordered and is scheduled to be at site by the end of Q2 2018. The detailed engineering and permitting is also underway. The power upgrade will eliminate the use of diesel generated power at the mine site, reducing operating costs.”*

While the equipment for the new power substation is on site, Magna has noted that Alio did not complete the installation of the substation.

**January 30, 2018 Press Release** “*Alio Gold Provides 2018 Guidance For San Francisco mine*”

*“In 2017 we undertook a significant waste stripping campaign to open up the main pit. As a result, we now have increased mining flexibility and the ability to deliver consistent ore feed to the leach pads.”*

*“Additionally, we have implemented a dual cut-off strategy in the mining operations. The strategy involves trucking lower grade run-of-mine ore to old heap leach pads while higher cut-off grade material will be fed to the crusher. Subsequently, the waste stripping expansionary capital contemplated in the revitalization plan will now be included within AISC.”*

Figure R shows the leach pads with the run-of-mine (ROM) material being placed.

**Figure R**  
**Leach Pads with ROM Material Being Placed on the Pads**



Figure supplied by Magna Gold Corp. March, 2020.

**April 11, 2018 Press Release “Alio Gold Provides First Quarter 2018 Production From San Francisco With Management and Transaction Updates”**

*“We anticipated the first quarter to be our lowest production quarter of the year as we implemented our dual cut-off strategy at San Francisco. With the run of mine ore only placed under leach towards the end of January, we did not see ounces draining from the pad until March,” said Greg McCunn, Chief Executive Officer. “Further, we still have not yet seen the impact of increased cut-off grade to the crusher feed and the average grade fed to the crusher of 0.42 g/t gold was below expectations. As our operating processes with this relatively new strategy improve, we maintain our full-year guidance of between 90,000 and 100,000 ounces of gold at all-in sustaining costs of between \$1,000 and \$1,100 per ounce.”*

**May 9, 2018 Press Release “Alio Gold Reports First Quarter 2018 Results”**

*“The Mine produced 17,624 gold ounces and 8,997 silver ounces compared to 26,048 gold ounces and 11,899 silver ounces during Q1 2017. The decrease was a result of lower grade. Mining was primarily from the upper level of Phase 5 of the San Francisco pit which has slower leach kinetics, in addition the impact of the increased cut-off grade to the crusher feed has not yet materialized and the average grade fed to the crusher of 0.42 g/t gold was below expectations. Under-*

*reconciliation and higher than anticipated dilution was seen during Q1 which is primarily as a result of being at the perimeter of the main ore body and is anticipated to reverse when the active benches mined are in the heart of the ore-body in the second quarter. The blasting improvement strategy which has been underway since December 2017 will continue to be monitored closely over the next two quarters to ensure it is not contributing to the under-reconciliation and dilution within the mine plan.”*

**August 10, 2018 Press Release “Alio Gold Reports Second Quarter 2018 Results”**

*“At the San Francisco mine we are negotiating with our mining contractor to slow down the waste stripping on Phases 6 and 7 and reduce the mining rate to focus on generating cash flow in the current gold price environment.”*

*“The dual cut-off strategy deployed in January 2018 to increase the grade of crusher feed ore has not been successful as crusher feed grade in Q2 2018 was 0.46 g/t compared to a plan of 0.59 g/t. The underperformance of gold grade is due to higher than expected levels of dilution which may partly be attributable to increased blast movement due to finer blasting, as well as to ore control modeling. In May 2018, an updated resource model was prepared for San Francisco as well as refined ore control modelling techniques. In June and July 2018, crusher feed is tracking closely to grades predicted by the new ore control model. The Company has initiated a full technical review of the pit operations at San Francisco and expects to refine its operations over the remainder of the year.”*

*“While the technical review is underway, the Company has developed an interim mine plan which reduces capital stripping and focuses mining on more profitable ounces to maintain cash neutral operations. The interim mine plan is subject to negotiations with the mining contractor. As a result of the reduced capital stripping, access to ore will be limited during the second half of the year and production guidance of 90,000 to 100,000 ounces of gold for 2018 will not be met.”*

*“The Mineral Reserve estimate at San Francisco from April 1, 2017 was updated as of July 1, 2018 utilizing the latest available information, including mining depletion over the period and in-fill and grade-control drilling carried out as part of the mining operations during the period. Mining depletion of Mineral Reserves was partly offset by expansion of the reserves in Phases 6 through 9 of the San Francisco Pit.”*

**November 08, 2018 Press Release “Alio Gold Reports Third Quarter 2018 Results”**

*“In July 2017, the Company initiated a significant push-back of the main San Francisco pit. Approximately 50% of the waste stripping campaign that was envisioned to be required in the May 2017 technical report was completed as at September 30, 2018. The final stages of the push-back require mining Phases 6, 7*

*and 8 of the San Francisco pit in order to access the main ore body in Phase 9. Mineralization in Phases 6, 7 and 8 occur in more narrow, discontinuous zones which are more difficult to mine without dilution of the ore with the associated waste.”*

*“A full technical review of the mining operations commenced in September 2018 and has identified a number of opportunities to reduce mining dilution, including:*

- Optimizing the mine planning to align dig plans with the geological structure;*
- Splitting mining of ore benches; and,*
- Monitoring movement during blasting.”*

*“While the technical review is underway, the Company developed an interim mine plan which was agreed to by the mining contractor on a temporary basis until the end of December, 2018 with an option to extend until the end of February 2019. The Company is investigating a number of mine planning options for 2019 which include:*

- Increasing mining rates back to 90,000 to 100,000 tonnes per day if dilution can be effectively controlled in order to complete the pit push-back by the end of 2019;*
- Reducing mining rates in the San Francisco pit and deferring stripping until an improved gold price environment;*
- Bringing forward mining operations in the La Chicharra pit; or*
- Suspending mining temporarily while continuing leaching and processing low-grade ore from stockpiles.”*

#### **January 15, 2019 Press Release “Alio Gold Provides 2018 Gold Production”**

*“At San Francisco fourth quarter gold production was 10,292 ounces and full year production was 53,990 ounces. Following a full technical review of the operations that commenced in September, 2018 progress was made on reducing the dilution that was occurring in the more narrow, discontinuous zones of Phases 6, 7 and 8 of the San Francisco pit. Further engineering work is ongoing to optimize the life-of-mine plan, in particular to bring forward the satellite La Chicharra pit. While this work is ongoing, the mine has begun processing low-grade stockpile material through the crushing circuit and has stopped mining in the San Francisco pit. There are sufficient stockpiles to operate at full capacity throughout 2019 (as at July 1, 2018, the low-grade stockpile consisted of approximately 7.2 million tonnes of 0.26 g/t gold material (60,200 contained ounces). Gold production at San Francisco is expected to remain consistent with current production levels for at least the first half of 2019.”*

**February 12, 2019 Press Release** *“Alio Gold Files Technical Report and Provides San Francisco Update”*

*“At San Francisco, the previously announced processing of low-grade stockpile material through the crushing circuit is working well. In January, approximately 528,770 tonnes of stockpile grading 0.306 g/t gold were stacked on the leach pads. Gold production for the month of January was consistent with Q4 production at approximately 3,890 ounces<sup>1</sup>. There are sufficient stockpiles to operate at this capacity throughout 2019 and the Company is continuing to develop an engineered plan for recommencing mining activities.”*

*“As part of the engineered plan and consistent with the Company’s need to minimize costs at San Francisco, negotiations with the mining contractor, Peal Mexico SA de CV (“Peal”), continued in January with the objective of obtaining a cost structure that was more in-line with benchmark mining costs for the region. Peal has notified the Company that it is seeking to terminate the contract and seeking compensation for amounts owing under the contract as well as additional amounts for cancellation of the contract that the Company believes have no basis. Peal continues to operate on the San Francisco site, moving low-grade stockpile material, and the Company is continuing to discuss these matters with the contractor. In the event that discussions do not resolve the matter, the Company will vigorously defend its position.”*

**March 13, 2019 Press Release** *“Alio Gold Reports Fourth Quarter and Full-Year 2018 Results”*

*“A full technical review of the mining operations that commenced in September 2018 identified a number of opportunities to reduce mining dilution. These included:*

- *Optimizing the mine planning to align dig plans with the geological structure;*
- *Split mining of ore benches; and*
- *Monitoring movement during blasting.”*

*“However, the San Francisco pit did not meet planned ore production rates at an acceptable strip ratio in the upper levels of the planned pit laybacks. As a result, in January, 2019 the Company made the decision to stop active mining in the San Francisco pit and only process low-grade stockpile material through the crushers while investigating a number of mine planning options. These options were investigated and included:*

- *Resume mining at 90,000 to 100,000 tonnes per day with ore feed from both the San Francisco and La Chicharra pits;*
- *Possible enhancements to the comminution circuit to improve gold recovery; and*

- *Rationalizing and optimizing the ore yield with mining rates.”*

*“While these options were economic the Company does not have the ability to fund the capital required for the various options. As a result the decision has been made to continue leaching and processing low-grade ore from the stockpiles until the end of the year at which time the stockpiles are expected to be depleted. Following the depletion of the stockpiles the operation will go into residual leach.”*

**May 08, 2019 Press Release “Alio Gold Reports First Quarter 2019 Results”**

*“In January, 2019, the Company made the decision to stop active mining in the San Francisco pit and focus on processing the low-grade stockpile, as a result of the San Francisco pit not meeting planned ore production rates at an acceptable strip ratio in the upper levels of the planned pit laybacks. The Company investigated a number of mine planning options to potentially restart active mining however, while the options were economic the Company does not have the ability to fund the capital required for the various options. As a result the decision was made to continue leaching and processing low-grade ore from the stockpiles until the end of the year at which time the stockpiles are expected to be depleted. Following the depletion of the stockpiles the operation will go into residual leach.”*

**November 06, 2019 Press Release “Alio Gold Reports Third Quarter 2019 Results”**

*“During the quarter, operations at the San Francisco mine continued with processing of low-grade stock piles resulting in the placement of 12,809 ounces onto the pad. The Company anticipates the low-grade stock will be exhausted during Q4 2019 after which crushing will cease and operations will solely focus on recovery of the residual inventory ounces.”*

*“Cash flow from operations from the quarter were used to service dated accounts payable.”*

*“The Company is currently exploring value-maximizing alternatives for the operation.”*

Figure S shows the site of the low-grade stockpile (in the foreground) and the remaining material in it as of March, 2020.

**Figure S**  
**Site of the Low-grade Stockpile (In the Foreground) and the Remaining Material on it as of March, 2020**



Figure supplied by Magna Gold Corp. March, 2020.

**March 06, 2020 Press Release “*Alio Gold Announces Sale of San Francisco Mine*”**

*“Alio Gold Inc. (TSX, NYSE AMERICAN: ALO) (“Alio Gold” or the “Company”), announces that it has entered into a definitive share purchase agreement (the “Agreement”) to sell its wholly-owned subsidiary, Molimentales del Noroeste S.A. de C.V. (“Molimentales”), which owns a 100% interest in the San Francisco mine (“San Francisco” or the “Mine”) and the surrounding mineral concessions to Magna Gold Corp. (TSXV: MGR, OTCQB: MGLQF) (“Magna”) (the “Transaction”). Under the terms of the Agreement, Alio Gold will receive 9,740,000 shares of Magna upon closing of the Transaction, representing approximately 19.9% of the issued and outstanding shares of Magna, and an additional \$5 million in cash within twelve months of closing of the Transaction. Alio Gold and Magna expect the Transaction to close in March, 2020.”*