

# **NI 43-101 Technical Report Preliminary Economic Assessment on Pegmatite Dyke #5 Lithium-Tantalum Deposit Sirmac Property, Québec**

**For Vision Lithium Inc.**



**Respectfully submitted to:**  
Vision Lithium Inc.

**By:**  
Claude Duplessis, P.Eng.  
Daniel Dufort, P.Eng.  
GoldMinds Geoservices Inc.

**Date:**  
March 23<sup>rd</sup> 2023

**DATE AND SIGNATURE PAGE**

The effective date of the Report on the Sirmac Property, Canada, is February 21<sup>th</sup>, 2023.

Prepared by:



23/3/2023

---

Claude Duplessis, P. Eng.

Date

Prepared by:

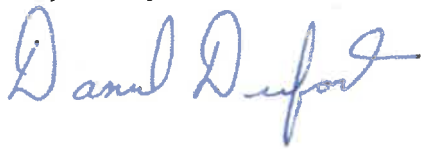

March 23, 2023

---

Daniel Dufort, P. Eng.

Date

# 1 SUMMARY

## 1.1. General

GoldMinds Geoservices Inc. (hereafter “GMG”) was retained by Vision Lithium Inc. (“Vision Lithium”) to carry out a Preliminary Economic Assessment (PEA) compliant with National Instrument 43-101 of the #5 Pegmatite lithium deposit on the Sirmac Property located in the Eeyou Itschee / James Bay region, Québec.

**The project calls for a direct shipping of mineralized material without beneficiation. The base case is EXW Chibougamau while there is an alternative scenario with mineralized material shipped to the port of Saguenay, the FOB Saguenay scenario.**

The report was prepared under the direct supervision of the qualified person Claude Duplessis P.Eng., and co-author Daniel Dufour Eng. M. Duplessis, Ms. Marquis Eng. and Olivier Morency-Brousseau from GMG visited the site on October 26th and 27th, 2022. During the site visit, independent sampling work was conducted on the #5 Pegmatite Dyke. Daniel Dufort Sr. Mining engineer QP did not visit the site.

This report uses the work done by previous QP on the project, their work has been reviewed, validated, verified and extracts from their reports are used and can be relied upon. Jean-Philippe Paiement, M.Sc., P.Geo., Guy Desharnais, Ph.D., P.Geo. and Jonathan Gagné, Eng., MBA, of the mineral resources report of 2014.

Report cover picture, C.Duplessis QP of GoldMinds during site visit on Dyke #5 in October 2022.

## 1.2. Property Description and Ownership

The Sirmac Property is located in the Eeyou Itschee / James Bay region (NTS 32J11 mapset), in the northwest region of the province of Québec.

The property comprises 2 blocks of claims (148 claims and 7 claims) covering a total of 7,670.25 hectares. The claims are 100% owned by Vision Lithium and are registered on GESTIM (Gestion des titres miniers).

## 1.3. History

The Sirmac property was first worked by Shaw G. from the Geological Survey of Canada who mapped the Lac Assinica sector in 1942. The first company to conduct exploration work was Sirmac Mines Limited in 1959. The property has since been worked by 8 companies over the past 62 years.

Preliminary metallurgical testing (1992) done by Lab Chrysotile highlighted a possible recovery of 77% of a 6.87% Li<sub>2</sub>O concentrate by flotation. In 1994, Wrightbar Mines completed a resource estimation (non NI 43-101 compliant) which resulted in the report of 318 324 tonnes at an average grade of 2.04% Li<sub>2</sub>O.

#### **1.4. Geological Setting, Mineralization, and Deposit Type**

The Sirmac property is located in the northeast portion of the Superior Geological Province, in the middle of the Canadian Shield. The Sirmac property is underlain by the Frotet-Evans volcano-sedimentary belt. In the Assinica Lake region, the belt comprises 2 major groups: 1) the Assinica Group at the base and 2) the Broadback Group overlying the Assinica. The Assinica Group mainly comprises massive and tholeiitic pillow basalt flows. The Broadback sedimentary package comprises sandstones, polymictic conglomerates and mudrocks. The Frotet-Evans belt is metamorphosed to the upper greenschist facies. In this region, the volcano-sedimentary belt is folded in an E-W trending synformal structure. The Frotet-Evans belt is enclosed by a granitic-gneissic complex and has been intruded by post-tectonic granodiorite and tonalites plutons.

The mineralization of economic interest at the Sirmac site is found in spodumene-bearing rare metal pegmatite dykes and sill complexes. Spodumene is a lithium-bearing mineral, which contains 8% Li<sub>2</sub>O when pure. The pegmatite also contains minor amounts of niobium and tantalum. The following figure present core of Sirmac.



**Figure 9 – Spodumene bearing pegmatite example in drill core (left) and meta-sediments host rock (right).**

The Sirmac pegmatite is a rare-element LCT granitic pegmatite. The mineralized bodies comprise mainly sills and some feeder dykes are also presumed. The spodumene-rich pegmatites display typical zoning to varying degrees – an albite wall zone at the contacts followed by an intermediate zone containing mostly feldspar, quartz, mica and spodumene, followed by a spodumene-quartz-rich core zone. Many core zones are present and the mineralogy is the same which occurs as large crystals of spodumene (up to 30 cm) contained in a quartz-feldspar matrix, sometimes with accessory minerals like tourmaline and apatite. The presence of beryl was also observed in the margin of some core zone and triphylite (lithium phosphate) was observed in different zones. The core zones do not have a consistent orientation, which means that different phases of intrusion and crystallization could have happened. The host rock is mainly metamorphosed sedimentary rocks. This unit may have a role in the structural control of the pegmatite, but insufficient stratigraphic or structural work was done on this unit.

### **1.5. Exploration and Drilling**

The Sirmac deposit has a long exploration background with exploration work conducted by many companies. Most recently, exploration programs were conducted by Vision Lithium in 2018 and 2022. In 2018, an UGPR (Ultra ground-penetrative radar) survey and a Time-Domain Resistivity/Induced Polarization survey were performed. In addition, a two-phase prospecting campaign aiming to extend the

#5 Dyke zone and the East Zone of the property, stripping work and drilling were conducted under the supervision of MRB & Associates.

In the summer of 2022, 28 drillholes were drilled in NQ size core by Forage Hébert Inc., totalling 3,256.30m of core. A total of 575 half-core samples and 11 control samples, including standard, blank, and duplicate samples, were sent to ALS Global in Val-d'Or. The assay data were collected for 510.15m of core, representing approximately 15.6% of the core drilled during that program.

### **1.6. Sample Security and Data Verification**

During the 2018 and 2022 programs, a rigorous QA/QC program was established by MRB & Associates and repeated by Vision Lithium. This procedure includes the systematic addition of blanks and three (3) different grades of certified reference material (CRM) standard. A total of 61 blank samples were inserted and 62 standards were included (29 Oreas 147, 27 Oreas 148, and 6 Oreas 149) as part of the QA/QC program. The sampling preparation was performed under the supervision of MRB & Associates geologist in 2018.

In accordance with National Instrument 43-101 guidelines, Claude Duplessis P. Eng., from GoldMinds Geoservices, visited the property on October 26<sup>th</sup> & 27<sup>th</sup>, 2022. He was accompanied by Maude Marquis Eng., and Olivier Morency-Brousseau, GoldMinds employees. During the site visit, independent sampling work was conducted on Dyke #5 for data verification of results associated with channels from the 2012 work program.

On a subsequent visit dated November 9<sup>th</sup>, 2022, Ms Maude Marquis Eng. visited the MNG core handling, logging and assay preparation installations in Val d'Or, Qc where the core of the 2022 drilling campaign executed by Vision Lithium is currently stored. Further independent samples were collected from holes SIR-22-12 and SIR-22-21. Remote Visio-conference was used between Maude Marquis and Claude Duplessis for review and sampling of the core.

The data verification was done on four (4) elements: 1. Validation of the GeoticLog© database and relations between each table (collars, deviations, lithologies and assays); 2. Block model validation in the light of the new information currently available; 3. QAQC data analysis; and 4. Independent control sampling.

### **1.7. Mineral Processing and Metallurgical Testing of 2019**

Vision Lithium Inc. contacted SGS Mineral Services in May 2018 with a request for a flowsheet development study on the Sirmac Deposit, located in Quebec. Previous metallurgical work suggested that this deposit would be amenable to the production of high-grade spodumene concentrate by dense media separation (DMS).

The objectives of this program were to confirm the results of the previous testwork, to develop a preliminary flowsheet for lithium processing, to provide the expected mass balance for the integrated DMS + flotation operation, and to better understand the metallurgical variability in the deposit. Furthermore, it was desired to know the lithium extraction from both DMS concentrate as well as flotation concentrate.

Two outcrop samples and three variability samples from Sirmac Deposit were used for the testwork program.

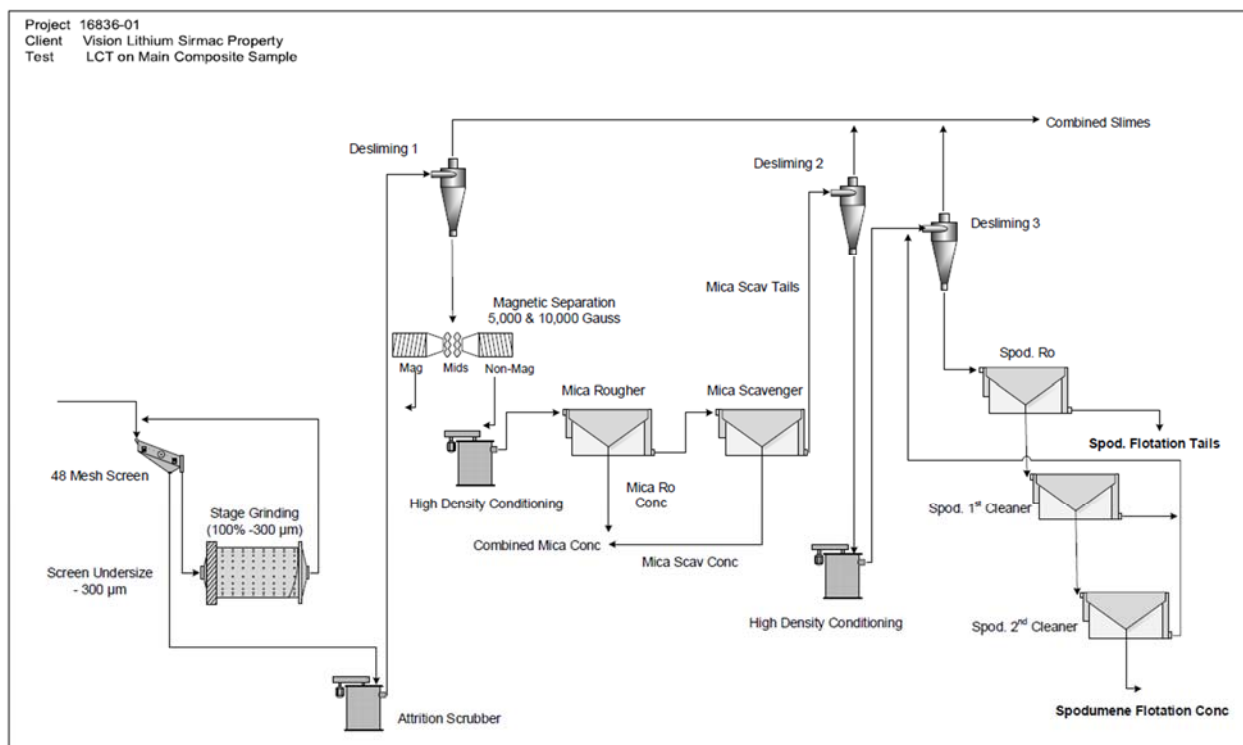

**Figure 44 – Final Developed DMS + Flotation Flowsheet for Main Outcrop Composite (Part 2 – Flotation).**

The following conclusions can be drawn from the results of the testwork completed on samples from Vision Lithium’s Sirmac Property:

- The lithium grade of the Main Outcrop Composite was 1.76% Li<sub>2</sub>O and the lithium grades of the variability samples ranged from 0.47% to 2.71% Li<sub>2</sub>O.
- The iron content of the samples was generally low (0.4-0.5% Fe<sub>2</sub>O<sub>3</sub>), with the exception of Var 1. The high iron content of Var 1 (2.70% Fe<sub>2</sub>O<sub>3</sub>) indicated the presence of a large proportion of iron bearing waste material. This was confirmed by semi-quantitative XRD analysis, which showed higher mica, fluorapatite and amphibole/pyroxene contents in Var 1 compared to the other variability samples.
- The feed material for flotation (DMS middlings and -850 μm slimes) was characterized as moderately soft, with BWI of 12.8 kWh/t.
- The potential for excellent lithium beneficiation by DMS was indicated in HLS tests on the two composites.
- This was confirmed in DMS testing with the Main Composite feed material. A three-pass DMS test at SG of 2.65 rejected most of the silicate gangue minerals to tailings and produced a middling product, while a DMS test at SG 2.90 produced high-grade spodumene concentrate that met the final product quality target (32% lithium recovery in ~9% of the feed mass, at a concentrate grade of 6.34% Li<sub>2</sub>O).
- This DMS concentrate grade was very similar to the predictions based on the results of the HLS test on the Main Outcrop Composite. However, the mass of DMS concentrate (and therefore lithium recovery to the DMS concentrate) was significantly lower than predicted by the HLS test.
- An additional 64% of the lithium reported to the DMS middlings plus the 850 μm screen undersize product, which once combined represented the feed to flotation. This product represented 58% of the feed mass and graded 1.92% Li<sub>2</sub>O, which was similar to whole ore head grade of 1.75% Li<sub>2</sub>O. Incorporation of DMS in the flowsheet therefore reduces the amount of material feeding the flotation plant by almost 50%.
- QEMSCAN analysis of the Main Outcrop Composite feed to flotation indicated that spodumene accounted for ~98% of the lithium in the sample, and that >83% of the spodumene was free or liberated in the -300 μm fraction. Based on this data and conventional mechanical flotation cell limitations, a grind size of 300 μm was selected for flotation testwork.



- Batch flotation tests on the Main Outcrop Composite feed to flotation all yielded excellent flotation performance and indicated that Custofloat 7080E demonstrated slightly better performance than FA-2 and FA-2/TP-A100 mix collectors. The final cleaner concentrate produced in the best batch test result graded 6.30% Li<sub>2</sub>O and recovered 88.6% of the lithium.
- The results of the batch flotation tests on the three variability were not as good as the tests on the Main Outcrop **Composite. Var 2 and Var 3 produced on-specifications spodumene concentrates (>6% Li<sub>2</sub>O), but with lower lithium recovery (75-80%),** while the desired Li<sub>2</sub>O grade could not be produced in the test with Var 1. This was likely due to the significant amount of iron-bearing waste and apatite in the Var 1 sample.
- The single locked-cycle flotation test that was conducted on a sample of the Main Outcrop Composite yielded excellent results. **The projected spodumene recovery to the final concentrate was 88%, at a concentrate grade of 6.16% Li<sub>2</sub>O** and 0.82% Fe<sub>2</sub>O<sub>3</sub>.
- **The predicted performance of the overall DMS + flotation flowsheet is very positive, with a projected recovery of 88.3% lithium at a combined concentrate grade of 6.23% Li<sub>2</sub>O.** The ~12% lithium loss in this flowsheet are distributed as follows: 7% to the DMS tailings, 2.5% to the float tails, 1.6% to the magnetic concentrate and 1.6% to the mica concentrate.
- A downstream flowsheet incorporating high temperature (1050° C) phase transformation of α-spodumene to β-spodumene, followed by acid baking and water leaching of the β-spodumene, extracted 98-99% of the lithium into an aqueous solution.
- The objective of the high temperature roasting step is to convert the inert α-spodumene mineral into the leachable β-spodumene form. XRD results confirmed that the conversion conducted at 1050°C for one hour in the muffle furnace was complete. About 40 minutes retention was sufficient for complete conversion, but this has not been optimized.
- The purpose of acid baking and water leaching was to first convert lithium in β-spodumene to solid lithium sulphate, and then to leach the lithium sulphate from the solid phase into an aqueous solution. It was shown that the thorough mixing of the roasted spodumene with sulphuric acid in the mixer before baking, blending the calcine during acid baking at temperatures between 210°C and 240°C, and high intensity mixing during the water leach increased the lithium recovery from

~90% to ~98%. Lithium extraction was better when water leaching was performed at room temperatures or lower temperatures.

## **1.8. Mineral Resource Estimates**

*Part of this section have been retrieved from the NI 43-101 Technical Report on Mineral Resource Estimation of the Pegmatite #5 Lithium-Tantalum Deposit completed by SGS Canada – Geostat, and written by G. Desharnais, Ph.D., P.Geol., J.-P. Paiement, M.Sc., P.Geol., and J. Gagné, Eng., for Nemaska Lithium Inc. (2014). The information gathered by SGS Canada – Geostat in 2014 after verification & validation were used for the new estimation with updated economic variables as the Authors are of the opinion that the additional data collected in 2018 and 2022 confirm the model or, in some cases, do not concern the dyke studied here, the Dyke #5. The data has been verified in its form, grades, interpretation as well as interpolation parameters and classification and the block model is considered current. as there is no material change in that aspect. GoldMinds QP endorses the work done by SGS Qualified Persons.*

The database contains 73 diamond drill holes from 2012 totalling 3,379 meters. Because of their unsure positions, not all collars were identified in the field the 53 historic drill holes were left out of the estimating process but used for modelling purposes. The 2,269 assays results include hole name, from, to, sample number and assay values for Li % (2012 DDH), Li<sub>2</sub>O % (historic and 2012 DDH) and Ta ppm.

### **1.8.1. Mineral Resources 2023 – Pit design constraints**

Considering the blocks limited to the optimized pit shell and a cut-off grade of 0.50 % Li<sub>2</sub>O, the mineral resources of the Sirmac deposit are 192,000 tonnes of measured resources at 1.38 %Li<sub>2</sub>O, 81,000 tonnes of indicated resources at 1.39 %Li<sub>2</sub>O and 49,000 tonnes of inferred resources at 1.05 %Li<sub>2</sub>O. The Ta values are given from the block values inside the lithium mineralized solids and have yet to demonstrate extractability and economic potential.

**These mineral resources do not represent mineral reserves since they have not shown economic viability and include inferred material.**

**Table 16: Mineral Resources for the Sirmac Project with Li<sub>2</sub>O Cut-off Grade of 0.50% (2023)**

Cut-Off Grade Li <sub>2</sub> O %	Category	Tonnage t	Average Grade Li %	Average Grade Li <sub>2</sub> O %	Average Grade TaO <sub>5</sub> %
0.50	Measured	192,000	0.639	1.375	0.0074
0.50	Indicated	81,000	0.647	1.393	0.0081
0.50	Inferred	49,000	0.487	1.049	0.0062

## 1.9. Mining and Recovery Methods

The proposed mining project would see the extraction of 321,000 metric tonnes of mineralized material and 873,000 metric tonnes of waste during a 4-year period.

The quarry operations method proposed for the project is a simple drill, blast, muck and ship method. The work would be done 6 months per year from May to October. The waste rock will be drilled, blasted and stockpiled on a designated area on the property. The mineralized material will be drilled on a tight pattern and blasted. It will be stockpiled on the property and transported by trucks on a regular basis to a pad in Chibougamau close to the railway head.

As the mineralized material is to be sold as a Direct Shipping similar to (DSO) iron projects, the recovery will depend on the company and plant which will process the material.

Nonetheless, Section 13 (Mineral Processing and Metallurgical Testing) shows the testing to be positive and should be suitable for existing processing plants without limitation. The testing shows the Sirmac #5 pegmatite dyke is suitable to produce a spodumene concentrate grading 6% Li<sub>2</sub>O and above. SGS testworks show achievable recovery of 88% with concentrate grade above 6%.

## 1.10. Economic Analysis

### 1.10.1. Cautionary statement

The results of the economic analyses discussed in this section represent forward-looking information as defined under Canadian securities law. The results depend on inputs that are subject to a number of known

and unknown risks, uncertainties and other factors that may cause actual results to differ materially from those presented in the report. Information that is forward-looking includes:

- Mineral Resource estimates;
- Assumed commodity prices and exchange rates;
- Proposed mine production plans;
- Projected recovery rates;
- Sustaining and operating cost estimates;
- Assumptions as to environmental, permitting and social risks.
- Changes to costs of production from what is assumed;
- Unexpected variations in quantity of mineralised material, grade, or recovery rates;
- Geotechnical and hydrogeological considerations during mining being different from what was assumed and was experienced in the past;
- Failure of plant, equipment, or processes to operate as anticipated;
- Accidents, labour disputes and other risks of the mining industry like: First Nation Claims, delays in permitting.

### **1.10.2. Highlights of the Vision Lithium PEA Study**

The economic analysis for the overall project is summarized in the following table. The economic analysis for the overall project is summarized in the following table. The overall internal rate of return (IRR) before-tax is 839.5% with a NPV 5% of 183.6M\$. The after-tax IRR is 483.7%, and the payback (after-tax) is one year for the Qc base case. The NPV 5% after-tax is 104.8M\$.

#### Highlights of the Vision Lithium PEA Study:

- A project life of 4 years with the current resources;
- Project Internal Rate of Return of 483.7% after-tax base case EXW – Ex Works<sup>1</sup> Chibougamau;
- Project base case before-tax Net Present Value of CAN\$184M (discounted at 5%), and after-tax Net Present Value of CAN\$105M (discounted at 5%);
- Production starts at 100,000 metric tonnes of pegmatite (bearing spodumene minerals) for year 1, 2 and 3 and 21,000 metric tonnes for year 4.
- Total operating costs of CAN \$142.40 per metric tonne of mineralized pegmatite Li<sub>2</sub>O (averaged over the expected life of the quarry);
- Capex (direct and indirect costs) and sustaining capital requirements of CAN \$3.125M, where initial capex (direct) requirement is CAN \$2.925M;
- The Vision Lithium PEA was prepared as a surface extraction of mineralized material fresh rock.

---

<sup>1</sup> **EXW – Ex Works**

The seller only needs to have the goods ready for pickup. It is the buyer's job to load them onto the vehicle and take care of the rest of the transport. Once the goods are out of the seller's premises, they are no longer his concern.

### 1.11. Conclusions and Recommendations

NI 43-101 compliant Mineral Resources have been estimated for the Sirmac deposit and limited to an optimized pit shell and pit design constrain. The Mineral Resource comprises 192,000t of measured resources at 1.38 %Li<sub>2</sub>O, 81,000t of indicated resources at 1.39 %Li<sub>2</sub>O, and 49,000t of inferred resources at 1.05 %Li<sub>2</sub>O. Those values are obtained using a cut-off grade of 0.50% Li<sub>2</sub>O.

The project has good grade and positive metallurgy, moreover the material is mostly above ground and uphill away from creeks and lakes which makes it a favorable environment for rapid development.

GoldMinds suggests to proceed with all required permits for the extraction of a 50,000t bulk sample with high grade (1.82%Li<sub>2</sub>O) in sector 1 while preparing a PFS to obtain permits and a mining lease.

Vision Lithium should update the model after the bulk sample and add some drilling if required to fine tune the modelling to better define the mineralized dykes.

<b>WORK</b>	<b>Purpose</b>	<b>Budget Estimation</b>
<b>Bulk sample Reclamation plan</b>	Develop the property and test contractors and costs studies	\$CAD150,000
<b>PFS &amp; Mining Lease</b>	After Bulk refine model overall tonnage	\$CAD 250,000

The above amount are in the cash flow under Owner's cost and contingency costs.

## Table of Contents

1	Summary .....	3
1.1.	General .....	3
1.2.	Property Description and Ownership .....	3
1.3.	History .....	3
1.4.	Geological Setting, Mineralization, and Deposit Type .....	4
1.5.	Exploration and Drilling .....	5
1.6.	Sample Security and Data Verification .....	6
1.7.	Mineral Processing and Metallurgical Testing of 2019 .....	6
1.8.	Mineral Resource Estimates.....	10
1.9.	Mining and Recovery Methods.....	11
1.10.	Economic Analysis .....	11
1.11.	Conclusions and Recommendations.....	14
2	Introduction .....	20
2.1.	Terms of reference – Scope of Work.....	20
2.2.	Source of information .....	20
2.3.	Personal inspection of the Property by the qualified person.....	21
2.4.	Units and currency .....	22
3	Reliance on Other Experts.....	24
4	Property Description and Location .....	25
4.1.	Property description .....	25
4.2.	Ownership .....	25
5	Accessibility, Climate, Local Resources, Infrastructure and Physiography .....	28
5.1.	Access .....	28
5.2.	Climate .....	28
5.3.	Local Resources.....	28
5.4.	Infrastructure.....	28
5.5.	Geographical features.....	28
6	History.....	32
7	Geological Setting and Mineralization .....	36
7.1.	Regional Geology .....	36
7.2.	Local Geology .....	36
7.3.	Mineralization .....	40
8	Deposit Type.....	42
8.1.	Origin and Features of Rare Metal Pegmatites.....	42
8.2.	Stacked Sill Structure .....	43
8.3.	Syntectonic Mobile Zone Feeder Dykes.....	43
8.4.	The Sirmac Pegmatites .....	43
9	Exploration.....	46
9.1.	2018 Exploration work by Vision Lithium.....	46
10	Drilling .....	49
10.1.	Overview.....	49
10.2.	2018 Drilling work .....	49
10.3.	2022 Drilling work .....	51
11	Sample Preparation, Analyses and Security.....	54
11.1.	Sample preparation, analyses and security for the 2012 exploration campaign .....	54

11.2.	Sample preparation, analyses and security for the 2018 and 2022 exploration campaigns .....	57
12	Data Verification .....	62
12.1.	Database validation.....	62
12.2.	Block model validation .....	62
12.3.	QAQC verification.....	67
12.4.	Independent Control Sampling (by Desharnais <i>et al.</i> , 2014).....	72
12.5.	Independent Verification Sampling of 2022 .....	74
12.6.	Data Quality Conclusion – Author’s opinion on the adequacy of the data.....	79
13	Mineral processing and metallurgical testing .....	80
13.1.	2013 – Report from SGS Mineral Services Lakefield .....	80
13.2.	2019 – Report from SGS Mineral Services Lakefield .....	88
14	Mineral Resource Estimates .....	101
14.1.	Mineral Resource Estimates of 2013 .....	101
14.1.	Mineral Resource Estimates of 2023 .....	121
15	Mineral Reserve Estimate .....	125
16	Mining Methods .....	126
16.1.	Open Pit Quarry .....	126
16.2.	Quarry Operation Planning.....	127
17	Recovery Methods.....	130
18	Project Infrastructure.....	131
18.1.	Location.....	131
18.2.	Quarry Site .....	131
18.3.	Chibougamau Site .....	133
19	Market Studies and Contracts .....	135
20	Environmental Studies, Permitting and Social or Community Impact .....	137
20.1.	Background.....	137
20.2.	Regulatory Context and Permitting.....	137
20.3.	Environmental Studies.....	139
20.4.	Social Context.....	143
20.5.	Closure Plan.....	144
21	Capital and Operating Costs.....	145
21.1.	Capital cost estimate .....	145
22	Economic Analysis .....	151
22.1.	Cautionary statement.....	151
22.2.	Financial Model Parameters .....	151
22.3.	Economic Analysis .....	152
22.4.	Sensitivity Analysis for Vision Lithium project.....	158
22.5.	Important Caution Regarding the Economic Analysis.....	158
23	Adjacent Properties.....	159
23.1.	Sirmac Property adjacent claims .....	159
23.2.	Other relevant information about adjacent properties.....	159
24	Other Relevant Data and Information .....	161
25	Interpretation and Conclusion.....	162
26	Recommendations .....	163
27	References.....	164



## LIST OF FIGURES

Figure 1 – Location map of the Sirmac Property.....	26
Figure 2 – Claim map of the Sirmac Property.....	27
Figure 3 – Broadback camp core storing racks (in 2014). .....	29
Figure 4 – MNG Services’ core racks at their Val-d’Or facility (2022).....	30
Figure 5 – Typical landscape on the Sirmac Property #5 dyke (2022).....	31
Figure 6 – Regional Geological Map. (source: SGS Geostat, 2014, based on the MERN).....	38
Figure 7 – Local Geologic Map with Claim footprint. The Sirmac Property is shown in a blue outline (source: SGS Geostat, 2014, based on the MERN). .....	39
Figure 8 – Typical element zonation in Pegmatite intrusions (Selway <i>et al.</i> , 2005). .....	41
Figure 9 – Spodumene bearing pegmatite example in drill core (left) and meta-sediments host rock (right). .....	41
Figure 10 – Exploration Mapping in the vicinity of #5 dyke (SGS Geostat, 2014).....	44
Figure 11 – General cross section interpretation from Pearse (2010). .....	45
Figure 12 – Prospecting Sample Location (Doyon, 2019). .....	47
Figure 13 – Dyke #5 2018 diamond drillholes locations (Doyon, 2019). .....	50
Figure 14 – East Zone 2018 diamond drillhole locations (Doyon, 2019). .....	51
Figure 15 – Example of monument left at the 2022 drillhole locations.(picture GMG QP site visit)..	52
Figure 16 – Layout with the locations of the drillholes, grab samples, and channels from the 2018 (yellow), and 2022 program’s (light green). .....	53
Figure 17 - Distribution of standards (Li %) used during the 2018 and 2022 exploration work – OREAS 147. Certified average presented by the dashed red line; 1 SD low and high covered by the blue corridor. ....	59
Figure 18 - Distribution of standards (Li %) used during the 2018 and 2022 exploration work – OREAS 148. Certified average presented by the dashed red line; 1 SD low and high covered by the blue corridor. ....	60
Figure 19 – Distribution of standards (Li %) used during the 2018 and 2022 exploration work – OREAS 149. Certified average presented by the dashed red line; 1 SD low and high covered by the blue corridor. ....	60
Figure 20 – Distribution of blank samples used during the 2018 and 2022 exploration work (rock carbonate gravel).....	61
Figure 21 – Plan view of the Dyke #5 according to SGS Geostat interpretation, with section orientations identified by orange stripes (Genesis©).....	63
Figure 22 – Section view of Dyke #5 with recent hole SIR-18-26-Twin (on S-04.00).....	64
Figure 23 – Section view of Dyke #5 with recent hole SIR-18-02 (on S+03.00).....	64
Figure 24 – Section view of Dyke #5 with recent hole SIR-18-03 (on S+05.00).....	65
Figure 25 – Section view of Dyke #5 with recent hole SIR-18-20 (on S+06.00).....	65
Figure 26 – Section view of Dyke #5 with recent hole SIR-18-04 (on S+07.00).....	66
Figure 27 – Section view of Dyke #5 with recent hole SIR-18-05 (on S+12.00).....	66
Figure 28 – Analytical results for Li standard material (Desharnais <i>et al.</i> , 2014).....	68
Figure 29 – Analytical results for Ta standard material (Desharnais <i>et al.</i> , 2014). .....	69
Figure 30: Analytical results for Li and Ta duplicates (Desharnais <i>et al.</i> , 2014). .....	70
Figure 31: Blank analytical results (Desharnais <i>et al.</i> , 2014). .....	71
Figure 32: Comparison between Original assay values and Check sampling values (Desharnais <i>et al.</i> , 2014).....	74

Figure 33 – ALS’s assays distribution of Li (%) and Ta (ppm) for Vision Lithium and GMG’s samples. .... 77

Figure 34 – The *p*-value distribution of ALS sets of values (Li)..... 78

Figure 35: Outcrop composite Bond Rod Mill Work Index comparison to SGS Database..... 81

Figure 36: Outcrop composite Bond Ball Mill Work Index comparison to SGS Database ..... 82

Figure 37: HLS test flowsheet performed on the drill cores..... 84

Figure 38: Preliminary flowsheet ..... 86

Figure 39: BWI of the Main Composite Flotation Feed Compared to the SGS Database (SGS, 2019). 89

Figure 40 – Comparison of Lithium Department in the HLS Test and the DMS Test (Main Composite). .... 91

Figure 41 – Optimized Batch Flotation Test Flowsheet (SGS, 2019). .... 92

Figure 42 – Locked-Cycle Test Flowsheet (SGS, 2019)..... 94

Figure 43 – Final Developed DMS + Flotation Flowsheet for Main Outcrop Composite (Part 1 – DMS; SGS, 2019)..... 96

Figure 44 – Final Developed DMS + Flotation Flowsheet for Main Outcrop Composite (Part 2 – Flotation)..... 97

Figure 45 – Map view showing the positions of the cross sections..... 102

Figure 46 – Topographic surface relative to drill hole collars (blue dots) with 3D view inset..... 103

Figure 47 – Overburden surface relative to drill holes with 3D view inset. .... 104

Figure 48 – Schematic interpretation from Pearse, 2010..... 105

Figure 49 – Li (%) and Ta (%) statistical relationship..... 106

Figure 50 – Examples of lithological interpretation on sections. .... 107

Figure 51 – Isometric and longitudinal views of the mineralized envelopes..... 108

Figure 52 – Histogram distribution for original assays and composites..... 109

Figure 53 – Histogram distribution comparing composites from the sills and feeder dykes..... 110

Figure 54 – Color coded block corresponding to mineralized envelopes..... 112

Figure 55 – Interpolated block model..... 114

Figure 56 – Statistical distribution of assays, composites and interpolation blocks..... 115

Figure 57 – Blocks corresponding to the first interpolation pass (upper), measured resources envelope (middle and lower)..... 116

Figure 58 – Blocks corresponding to the first interpolation pass (upper), indicated resources envelop (middle and lower)..... 117

Figure 59 – Histogram distribution of tonnage and block grades..... 118

Figure 60 – Pit outline and resource block model ..... 120

Figure 61 – Plan view of the Property Dyke #5 with the pit outlines 2023..... 122

Figure 62 – Section view of the pit design..... 126

Figure 63 - Site surface plan..... 129

Figure 64 – Site surface plan with access road..... 134

Figure 65: Lithium Carbonate price variation from 2018 to 2023 in CNY/T ..... 136

Figure 66 – Sirmac Property and Adjacent Claims. .... 160

## LIST OF TABLES

Table 1: List of abbreviations .....	22
Table 2: Summary of the historic work and reports on Sirmac Property.....	32
Table 3: Drilling and channel sampling executed by Vision Lithium in 2018 and 2022 in the Sirmac Property.....	49
Table 4: Average grades of analytical standards.....	56
Table 5: Summary of the statistics of the control sampling program (Desharnais <i>et al.</i> , 2014) .....	73
Table 6: Assays from the original sampling and independent resampling of channels and drillholes at Sirmac Property. ....	75
Table 7: Summary of the statistics of the control sampling program of 2022.....	76
Table 8: Bond Ball Mill Grindability Test Results (SGS, 2019) .....	89
Table 9: Lithologies Summary.....	104
Table 10: Block model geometry parameters.....	111
Table 11: Search Ellipse parameters .....	113
Table 12: Interpolation parameters .....	113
Table 13: Economic assumptions for pit optimization (Desharnais <i>et al.</i> , 2014).....	119
Table 14: Mineral Resources for the Sirmac Project with Li <sub>2</sub> O Cut off Grade of 0.50% (2013) .....	121
Table 15: 2023 assumptions for pit design .....	122
Table 16: Mineral Resources for the Sirmac Project with Li <sub>2</sub> O Cut-off Grade of 0.50% (2023).....	123
Table 17: Stripping ratio for the optimized pits.....	124
Table 18: Fauna and Flora Species at Risk Potentially Present in the Project Area .....	142
Table 19: Capital costs.....	146
Table 20: Operating costs.....	149
Table 21: Project Base Case Economic Parameters and Assumptions.....	152
Table 22: Vision Lithium Project Cash Flow Summary –Base Case Qc* EXW Chibougamau .....	152
Table 23: Vision Lithium Project Cash Flow Summary – Mine to Port scenario FOB Saguenay.....	153
Table 24: Operating costs detailed EXW Chibougamau .....	153
Table 25: Operating costs detailed FOB Port Saguenay .....	153
Table 26: Total Capital costs for Vision Lithium project.....	154
Table 27: Base Case Cash Flow — EXW Chibougamau -Québec.....	156
Table 28: Cash Flow Scenario FOB Port Saguenay .....	157
Table 29: Sensitivity table on %NPV calculation base case .....	158
Table 30: Sensitivity table on selling price per tonne after tax Base case .....	158
Table 31: Mineral Resources for the Sirmac Project with Li <sub>2</sub> O Cut off Grade of 0.50% (2023) .....	162

## **2 INTRODUCTION**

### **2.1. Terms of reference – Scope of Work**

GoldMinds Geoservices Inc. (hereafter “GMG”) was retained by Vision Lithium Inc. (“Vision Lithium”) to carry out a Preliminary Economic Assessment (PEA) compliant with National Instrument 43-101 for the #5 Pegmatite lithium deposit on the Sirmac Property located in the Eeyou Itschee / James Bay region, Québec.

This report presents a technical review of the geology and the mineralization. The Technical Report contains descriptions of the following elements, without limitation: the previous exploration work, including the geological work carried out by Nemaska in 2012 and the programs performed by Vision Lithium in 2018 and 2022, a field and core shack visit, an independent check sample program and a presentation of the estimation of mineral resources carried out by SGS Canada - Geostat in 2014 revised and validated in 2022.

The report was prepared under the direct supervision of the QP (Qualified Person) Claude Duplessis P.Eng., and co-author Daniel Dufour Eng. M. Duplessis, Ms. Marquis Eng. and Olivier Morency-Brousseau from GMG visited the site on October 26<sup>th</sup> and 27<sup>th</sup>, 2022. Daniel Dufort Sr. Mining engineer and QP did not visit the site.

This report uses the work done by previous QPs on the project. Their work has been verified and extracts from their report are used and can be relied upon. Jean-Philippe Paiement, M.Sc., P.Geo., Guy Desharnais, Ph.D., P.Geo. and Jonathan Gagné, Eng., MBA, of the mineral resources report of 2014.

### **2.2. Source of information**

The information herein is mostly derived from information used in the geological report, information provided in the NI 43-101 Technical Report on Mineral Resource Estimation of the Pegmatite #5 Lithium-Tantalum Deposit completed by SGS Canada – Geostat for Nemaska Lithium Inc. in 2014.

In addition, recent exploration data and maps were provided by Vision Lithium personnel on the 2018 and 2022 campaigns have been integrated. Data includes assays from core samples assayed at ALS Laboratory in Val-d’Or. Previous reports were also retrieved from the spatial reference geomining information system of the Ministère de l’Énergie et des Ressources naturelles (MERN), e-SIGEOM (SIGEOM, 2022).

### **2.3. Personal inspection of the Property by the qualified person**

In accordance with the National Instrument 43-101 guidelines, Claude Duplessis P. Eng. QP, from GoldMinds Geoservices, visited the property on October 26th & 27th, 2022. He was accompanied by Ms. Maude Marquis Eng., and Olivier Morency-Brousseau, both GoldMinds employees.

During the site visit, independent sampling work was conducted on the Dyke #5. The sampling procedure and methodology is described further in this section of the report.

Independent sampling of witness core was performed by Ms. Maude Marquis Eng. under Claude Duplessis P.Eng supervision (visio-conference) on 2022 drillholes during a visit of the temporary core shack on November 8<sup>th</sup>, 2022. At that time, ¼ core samples were taken for assaying at ALS Laboratory in Val-d'Or.

The site visit of 2022 is still current as no material change on exploration work has occurred since the QP set foot on the Property.

## 2.4. Units and currency

All measurements in this report are presented in “International System of Units” (SI) metric units, including metric tonne (tonne or t) or gram (g) for weight, metre (m) or kilometre (km) for distance, hectare (ha) for the area, and cubic metre (m<sup>3</sup>) for volume.

All currency amounts are Canadian Dollars (CAN\$/CAD) unless otherwise stated. Abbreviations used in this report are listed in Table 1. The coordinates are presented using the Universal Transverse Mercator (UTM) projected coordinate system in the North American Datum of 1983 (zone 18).

**Table 1: List of abbreviations**

cm	Centimetres
FA	Fire Assay
g	Grams
Ga	Billion years
GMG	GoldMinds Geoservices Inc.
g/t	Gram per metric tonne
ha	Hectares
ICP-MS	Inductively coupled plasma mass spectrometry
ICP-OES	Inductively coupled plasma optical emission spectrometry
kg	Kilograms
km	Kilometres
µm	Micrometres
Li	Lithium (chemical element)
Li <sub>2</sub> O	Lithium oxide (chemical compound)
m	Metres
m <sup>3</sup>	Cubic metres
Ma	Million years
Moz	Million ounces
Mt	Mega tonne
mm	Millimetres
NAD	North America Datum
NQ	Drill core size (4.8 cm in diameter)
NSR	Net Smelter Return
NTS	National Topographic System
Oz	Troy ounce
Oz/t	Troy ounce per short ton
Pb	Lead (chemical element)
ppb	Parts per billion
ppm	Parts per million
SG	Specific Gravity
SM	Screen Metallic
Ta	Tantalum (chemical element)

Ta <sub>2</sub> O <sub>5</sub>	Tantalum oxide (chemical compound)
tonne or t	Metric tonne
tpd	Tonnes per day
t/m <sup>3</sup>	Tonne per cubic metre
UTM	Universal Transverse Mercator
%	Percent sign
°	Degree
°C	Degree Celsius
°F	Degree Fahrenheit

### **3 RELIANCE ON OTHER EXPERTS**

In order to complete information on the Sirmac Property, the authors relied on certain external information that has been reviewed to the best of their knowledge. The authors of this technical report are not qualified to comment on issues related to legal agreements, royalties, permitting, taxation and environmental matters.

Since the present Technical Report addresses information already clearly defined in the NI 43-101 Technical Report on Mineral Resource Estimation of 2014 concerning the property, paragraphs have been retrieved from the NI 43-101 Technical Report on Mineral Resource Estimation of the Pegmatite #5 Lithium-Tantalum Deposit completed by SGS Canada – Geostat, and written by G. Desharnais, Ph.D., P.Geo, J.-P. Paiement, M.Sc., P.Geo, and J. Gagné, Eng., for Nemaska Lithium Inc. (2014). For several sections of the present report, it contains all relevant information that adds value to the understanding of the property's potential.

Information, procedures and clarification were also provided by Vision Lithium geologist and professionals, and were used in the redaction of the present report. Data transferred by Vision Lithium was revised and validated before being used in the resource estimation process.

Metallurgical test work done by SGS Lakefield Laboratories (Massoud Aghamirian PhD) and their report detailed in the 2014 NI 43-101 Technical Report are used in section 13 (Mineral Processing and Metallurgical Testing) of the current report. The metallurgical test work program of 2019 is also reported in section 13.



## **4 PROPERTY DESCRIPTION AND LOCATION**

### **4.1. Property description**

The Sirmac Property is located in the Eeyou Istchee / James Bay region (NTS 32J11 mapset), in the northwest region of the province of Québec. The property center point is 466 100 m E / 5 607 500 m N (UTM Nad83, zone 18). The property is approximately 115 km northwest of the town of Chibougamau and 170 km southeast of the community of Nemaska. The Sirmac property is accessible by the Route du Nord (Northern Road) that starts in Chibougamau.

The property comprises 2 blocks of claims (148 claims and 7 claims) covering a total of 7,670.25 hectares). The list of the individual claims is provided in Appendix I. The Property is partially within the limits of the Assinica Wildlife Reserve, managed by the Cree Nation of Oujé-Bougoumou (Nibiischii Corporation, 2021).

### **4.2. Ownership**

The claims are 100% owned by Vision Lithium and are registered on GESTIM (Gestion des titres miniers), a web platform administered by the Ministère des Ressources naturelles et des Forêts (MRNF). Mineral claims were consulted and verified in the Quebec government's title management system; they are registered under the number 97586. The titles are in good standing at the time of writing this Technical Report.

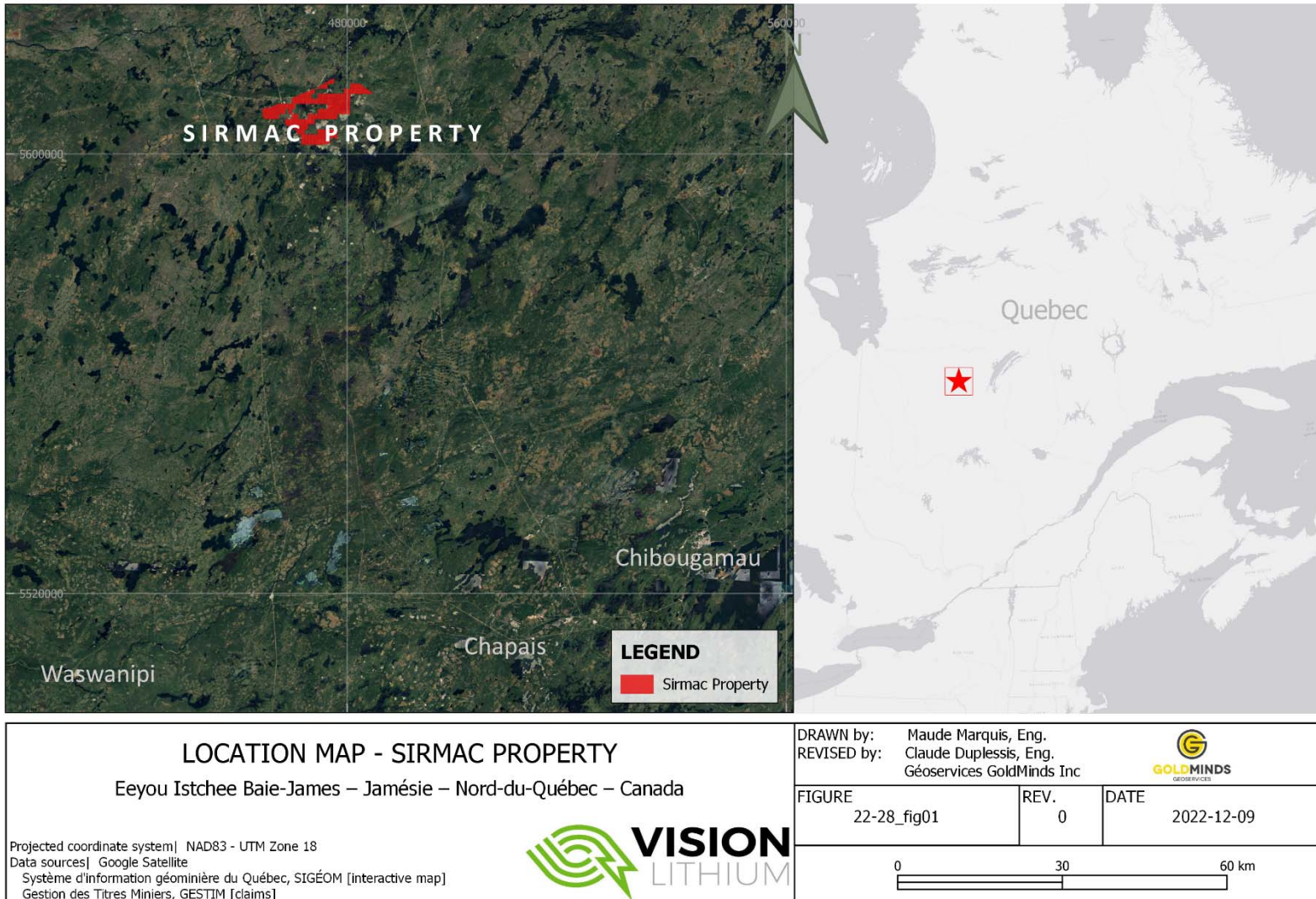

Figure 1 – Location map of the Sirmac Property.



<h3 style="margin: 0;">SIRMAC PROPERTY</h3> <p style="margin: 0;">Eyeyou Istchee Baie-James – Jamésie – Nord-du-Québec – Canada</p>			<p>DRAWN by: Maude Marquis, Eng.          REVISED by: Claude Duplessis, Eng.          Géoservices GoldMinds Inc</p>																									
<p>Projected coordinate system  NAD83 - UTM Zone 18          Data sources  Esri Satellite          Système d'information géomineière du Québec, SIGÉOM [interactive map]          Gestion des Titres Miniers, GESTIM [claims]</p>			<table border="1" style="width: 100%; border-collapse: collapse;"> <thead> <tr> <th style="width: 30%;">FIGURE</th> <th style="width: 20%;">REV.</th> <th style="width: 50%;">DATE</th> </tr> </thead> <tbody> <tr> <td style="text-align: center;">22-28_fig02</td> <td style="text-align: center;">0</td> <td style="text-align: center;">2022-12-13</td> </tr> </tbody> </table>	FIGURE	REV.	DATE	22-28_fig02	0	2022-12-13																			
FIGURE	REV.	DATE																										
22-28_fig02	0	2022-12-13																										
<table style="width: 100%; border-collapse: collapse;"> <tr> <td style="width: 10%; text-align: center;">0</td> <td style="width: 10%; text-align: center;">1</td> <td style="width: 10%; text-align: center;">2</td> <td style="width: 10%; text-align: center;">3</td> <td style="width: 10%; text-align: center;">4</td> <td style="width: 10%; text-align: center;">5</td> <td style="width: 10%; text-align: center;">6</td> <td style="width: 10%; text-align: center;">7</td> <td style="width: 10%; text-align: center;">8 km</td> </tr> <tr> <td colspan="9" style="text-align: center;"> </td> </tr> </table>			0	1	2	3	4	5	6	7	8 km										<table border="1" style="width: 100%; border-collapse: collapse;"> <thead> <tr> <th style="width: 30%;">FIGURE</th> <th style="width: 20%;">REV.</th> <th style="width: 50%;">DATE</th> </tr> </thead> <tbody> <tr> <td style="text-align: center;">22-28_fig02</td> <td style="text-align: center;">0</td> <td style="text-align: center;">2022-12-13</td> </tr> </tbody> </table>		FIGURE	REV.	DATE	22-28_fig02	0	2022-12-13
0	1	2	3	4	5	6	7	8 km																				
FIGURE	REV.	DATE																										
22-28_fig02	0	2022-12-13																										

Figure 2 – Claim map of the Sirmac Property.

## **5 ACCESSIBILITY, CLIMATE, LOCAL RESOURCES, INFRASTRUCTURE AND PHYSIOGRAPHY**

### **5.1. Access**

The property is accessible via the Northern Road from Chibougamau. This road is a well maintained gravel road open throughout the year and accessible to heavy transport trucks. The property is located 32 kilometers down a secondary forestry road (No.850/R1044) used for heavy logging truck transportation which can be accessed at kilometer 128 off the North Road. A SOPFEU camp is located 20km as the crow flies west of the property. The #5 dyke is easily accessible using recent network of Logging gravel roads and ATV trails. A power line is located at the eastern edge of the property.

### **5.2. Climate**

The region has a typical mid-north climate with -20°C average temperature in January and 17°C average temperature in July. The soil freezes from early November to late April. The annual precipitation averages 640 mm of rain from March to November and 350 cm of snow from September to May.

### **5.3. Local Resources**

Local resources are limited to the nearest towns of Chibougamau and Chapais, which have a long history of mining and exploration. Sufficient industry services exist and are well developed in Chibougamau. Chibougamau also provides an experienced population pool.

### **5.4. Infrastructure**

The Nemaska 2012 drill core storage racks are located at the Broadback forestry camp (Figure 3). A major power line is located about 2 km to the east of the deposit and the Broadback forestry camp is located a few km west of the property border. The nearest town of Chibougamau (around 2½ hour drive) can provide logistics, food supply and lodging. In addition, temporary core storage racks with some of the core from the 2018 campaign are located on the property north of the main pegmatite.

### **5.5. Geographical features**

The geographic features found on the property reflect the typical features of the superior geological province. The landscape is dominated by glaciation features and low rolling hills (Figure 5). Eskers are found and oriented NNE-SSW and depressions are generally marked by swampy areas.



**Figure 3 – Broadback camp core storing racks (in 2014).**

The core from the 2022 exploration campaign has been transported to a temporary storage facility in Val D'Or.



Figure 4 – MNG Services' core racks at their Val-d'Or facility (2022).



**Figure 5 – Typical landscape on the Sirmac Property #5 dyke (2022).**

The picture above is taken from the top hill looking north where we can see Sirmac Lake.

## 6 HISTORY

The Sirmac property was first worked by Shaw G. from the Geological Survey of Canada who mapped the Lac Assinica sector in 1942. The first company to conduct exploration work was Sirmac Mines Limited in 1959. The property was then worked by 8 companies over the next 62 years. All work conducted on the property is summarized in Table 2.

**Table 2: Summary of the historic work and reports on Sirmac Property**

YEAR	REFERENCE			WORK DESCRIPTION
	SIGEOM Document Number	Company	Author	
1942	-	Geological Survey of Canada	Shaw G.	Geological Map of the Assinica Lake sector.
1959	GM 09428	Sirmac Mines Ltd.	Radisics, G.M.	Geological mapping following the discovery of the spodumene bearing pegmatite.
1960	GM 10551	Sirmac Mines Ltd.	Radisics, G.M.	Regional and detailed geological mapping of #5 and #7 dykes. Trenches and rock analysis.
1960	GM 11470	Sirmac Mines Ltd.	WRIGHT, C.M.	Mineralogical studies on pegmatite rock samples .
1966	RP 550	Ministry of Natural Resources, Quebec	Gillet, L.B.	1:63 360 Geological map of Lake Assinica region.
1969	GM 24590	Yorbeau Mines	Masterman, P.C.	15 DDH totaling 1041m in order to delineate the #5 Dyke (Done in 1961 by Cominco).
1976	GM 34169	Société de développement de la Baie-James (SDBJ)	Otis, M.	Lake sediment Geochemistry.
1976	GM 34172	SDBJ		Lake sediment Geochemistry.
1978	GM 33998	SDBJ	Bertrand, C.	Geological site visit and localization of the past work.
1981	DP 83-17	Ministry of Energy & Natural Resources, Quebec	Geophysics Survey	Input EM survey in the Broadback region.
1986	-	Geological Survey of Canada	Lefebvre et al.	Regional Magnetic Survey.



YEAR	REFERENCE			WORK DESCRIPTION
	SIGEOM Document Number	Company	Author	
1992	GM 52050	Lab Chrysotile	Cotnoir, D.	Preliminary Metalurgical work by flotation (6.87% Li <sub>2</sub> O conc. with 77% recuperation).
1994	DV 93-13	Ministry of Energy & Natural Resources, Quebec	Sial Geosciences	Processing of the prior geophysics survey in the Lake Assinica region.
1994	GM 53768	Geospex Sciences for Corporation Lithos	Bureau, S.	Sirmac Project reserves evaluation at 206 966 tones at 1.56% Li <sub>2</sub> O from surface to 40m vertical depth.
1994	GM 53769	Corporation Lithos	Boily, M.	Geological Report on the mining potential of lithium and other rare metals such as cesium and tantalum.
1994	GM 53770	Corporation Lithos	Boily, M.	Mineralogical studies indicating that dyke #5 is of the rare metal enriched pegmatite suite.
1994	GM 53771	Wrightbar Mines	Lamarche, L.	38 DDH and compilation reporting reserves of 318 324 tones at 2.04% Li <sub>2</sub> O.†
1995	MB 95-40X	Ministry of Energy & Natural Resources, Quebec	-	Re-analysis of the lake sediment of the Assinica Lake region.
1996	GM 55628	Geosig	Simoneau, P. and Granger, B.	MaxMin electromagnetic survey. Delineation of nine good conductors and one less evident conductor.
1996	GM 55629	Val d'Or Sagax	Potvin, H.	Ground magnetic and VLF surveys and delineation of four sectors of interest.
1997	GM 55627	Corporation Lithos	Tourigny, G.	Prospecting and mapping on the Assinica property (Sirmac is a part of it). Potential of a massive base metal sulphide deposit and gold vein mineralization.
1997	GM 55630	Corporation Lithos	Imbeau, G.	17 DDH in order to determinate the presence of a base metal sulphide deposit west of the Lucky Strike volcanic structure.
1997	RG 96-11	Ministry of Energy & Natural Resources, Quebec	Brisson et al.	1:50 000 geological mapping of the 32J11 map set

YEAR	REFERENCE			WORK DESCRIPTION
	SIGEOM Document Number	Company	Author	
2008	GM 63472	Everton Resources Inc.	L'Heureux, M.	Field reconnaissance to located historic trenches and boulder sampling campaign.
2010	CGSIGEOM-32J	Ministry of Energy & Natural Resources, Quebec		Government of Quebec Geology Map of Lac Assinica area (NTS 32J/11)
2011	GM 65953	Nemaska Lithium	Richard, L-P. et al.	2011 Geological mapping and lithogeochemical sampling program on Sirmac Lithium Property.
2013	GM 67675	Nemaska Lithium	Richard, L-P. and Michaud, M.L.	2013 Geological mapping and lithogeochemical sampling program on Sirmac Lithium Property.
2013	GM 68109	Nemaska Lithium	Richard, L-P. and Michaud, M.L.	Comprehensive report on major 2012 exploration program (73 drill-holes) on Sirmac Lithium Property.
2018	GM 72790	ABE Resrouces Inc.	St-Hilaire, C. (Geo Data Solutions GDS Inc.)	High resolution helicopter borne magnetic survey to test if discrimination of very low iron content pegmatite would be possible against sedimentary and basaltic rocks.
2018	GM 72793	ABE Resources Inc.	Langton, J. (MRB & Associates)	NI 43-101 Technical Report on the Sirmac Lithium Property.
2019	GM 72794	Vision Lithium Inc.	Doyon, V. (MRD & Associates)	Assessment report on 2018 exploration work comprising diamond-drilling, stripping, sampling, prospecting, geophysics and digital 3D modelling of the Sirmac Lithium Property.

† Historical resource estimation, not compliant with the NI 43-101 standards of disclosure for mineral projects.

Preliminary metallurgical testing (1992) done by Lab Chrysotile highlighted a possible recovery of 77% of a 6.87% Li<sub>2</sub>O concentrate by flotation. In 1994, Wrightbar Mines completed a resource estimation (non NI 43-101 compliant) which resulted in the report of 318 324 tonnes at an average grade of 2.04% Li<sub>2</sub>O. A qualified person has not done sufficient work to classify the historical estimate as current mineral resources. The issuer is not treating the historical estimate as current mineral resources; the resources estimate described in this report supersedes it.

In 2010, Nemaska undertook its first work on the Sirmac property. In October 2010, a few days of work were done in order to do some prospecting, geological mapping and sampling (26 samples) on the #5 dyke. In May and June 2011, prospecting work, mapping and sampling was undertaken on the property in order to locate other structures similar to the #5 dyke. Following the results from 2010 and 2011 work, a trenching, channelling and drilling campaign was conducted on the property in 2012, which led to a mineral resource estimation and Technical Report done by SGS in 2014.

## 7 GEOLOGICAL SETTING AND MINERALIZATION

### 7.1. Regional Geology

The Sirmac property is located in the northeast portion of the Superior Geological Province, in the middle of the Canadian Shield. The Superior Province extends from Manitoba to Quebec and is comprised of mainly Archaean age lithologic units. The main metamorphic facies is greenschist but areas close to intrusions can reach the amphibolite, sometimes granulite facies. In Quebec, the eastern part of the Superior Province can be divided into 9 sub-provinces from south to north (Figure 6): Pontiac, Abitibi, Opatica, Nemiscau, Opinaca, La Grande, Ashuanipi, Bienville and Minto (Hocq, 1994). The region covered in this report is situated in the Opatica sub-province.

### 7.2. Local Geology

The geology of the Sirmac property was described by Boily (1994), Brisson et al. (1997) and Pearse (2010).

The Sirmac property is underlain by the Frotet-Evans volcano-sedimentary belt. In the Assinica Lake region, the belt comprises 2 major groups: 1) the Assinica Group at the base and 2) the Broadback Group overlying the Assinica. The Assinica Group mainly comprises massive and tholeiitic pillow basalt flows. The Broadback sedimentary package comprises sandstones, polymictic conglomerates and mudrocks. The Frotet-Evans belt is metamorphosed to the upper greenschist facies. In this region, the volcano-sedimentary belt is folded in an E-W syncline, which is displayed by E-W foliation with a steep dip towards the west. The Frotet-Evans belt is enclosed by a granitic-gneissic complex and has been intruded by post-tectonic granodiorite and tonalites plutons.

At the property level, four main types of rocks are found. The dominant lithology consists of quartz-biotite-hornblende schist that corresponds to metamorphosed detrital sedimentary rocks of the Broadback Group. A few interbeds of amphibolitized mafic sills or flows are also present on the property. The property is located on the South limb of the regional syncline and the foliation in these rocks is generally E-W with a shallow dip.

The southeast portion of the property is intruded by a hornblende-bearing syenite pluton that outcrops sporadically. The schist and syenite intrusion are cut by numerous small scale (1 cm to 5 cm) quartz-feldspar dykes. More than 12 granitic pegmatite intrusions have been recognized on the property. All the pegmatites crosscut the schist and mafic volcanic. They typically have a NNW-SSE (315° - 350°) orientation and range in width from 1 m to 100 m. The dykes are sub-vertical and show multi stage sills as well. The

contacts with the host rock are sharp with contact metamorphism and numerous schist xenoliths at the border.

The Sirmac dyke swarm was interpreted by Pearse (2010) to be an extension of the compressive structure that hosts the Moblan Lithium rich pegmatites (Perilya, 2011), 40 km east of the Sirmac property.

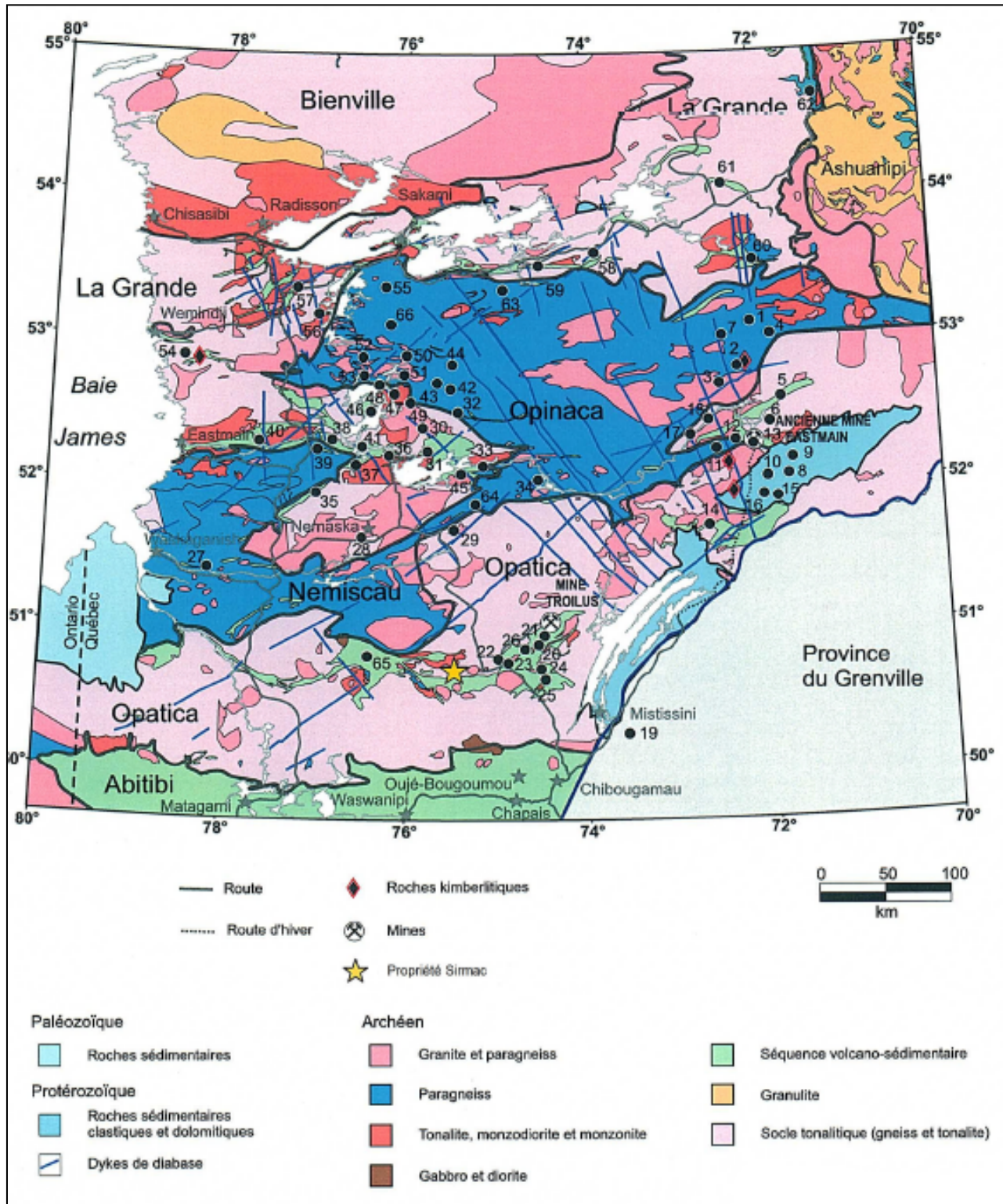

Figure 6 – Regional Geological Map. (source: SGS Geostat, 2014, based on the MERN).

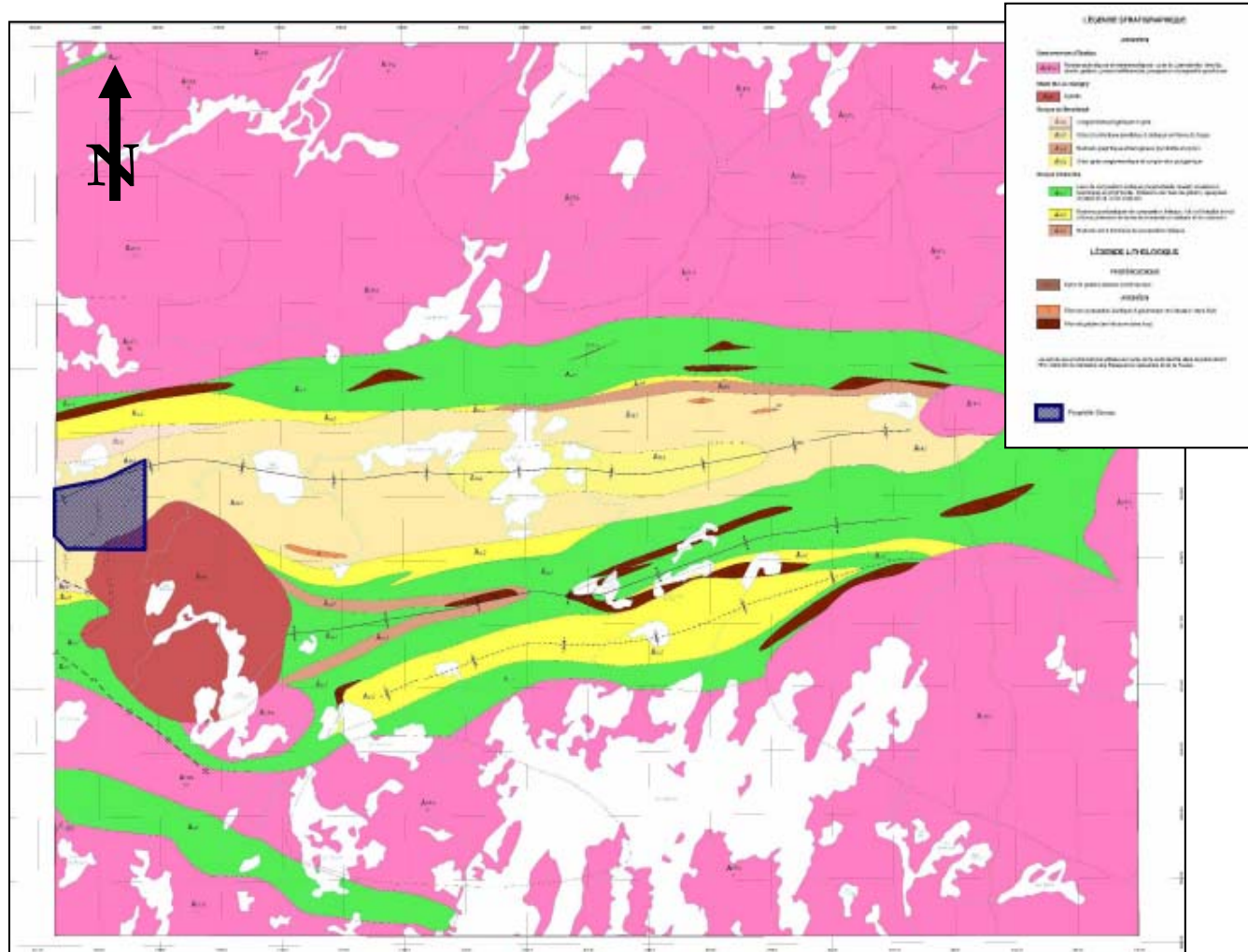

Figure 7 – Local Geologic Map with Claim footprint. The Sirmac Property is shown in a blue outline (source: SGS Geostat, 2014, based on the MERN).

### 7.3. Mineralization

The regional prospecting done in the region over the years highlighted a potential for precious and base metal deposits. Cu, Zn, and Au lithochemical anomalies are found in the region, which is consistent with the volcano-sedimentary setting of this particular region.

The mineralization of economic interest at the Sirmac site is found in spodumene-bearing rare metal bearing pegmatite dykes and sill complexes. Spodumene is a lithium-bearing mineral, which contains 8%  $\text{Li}_2\text{O}$  when pure. Spodumene also contains minor amounts of niobium and tantalum. Assays for spodumene normally range between 7.6% - 8.0%  $\text{Li}_2\text{O}$  depending on the degree of replacement by  $\text{Na}_2\text{O}$ . Typically, the Sirmac pegmatite sampled from drill core averages 1.01%  $\text{Li}_2\text{O}$  with values up to 3.94%  $\text{Li}_2\text{O}$ . Later during exploration work, at the metallurgical testing stage, tantalum values were detected for the mineralized pegmatite. The values range between 0.1 ppm and 862 ppm  $\text{Ta}_2\text{O}_5$ . These values suggest the presence of tantalite mineralization in the Sirmac pegmatites, but have yet to be demonstrated by mineralogical studies.

Rare metal bearing pegmatites are normally found in moderately metamorphosed terranes near vast granitic plutons, a possible parental source for the pegmatitic magmas. Pegmatites are associated with granitic intrusions and are generally zoned around these intrusive centers. Pegmatites tend to be more enriched in volatile elements further away from the intrusive centers. Pegmatites are thought to be derived from primary crystallization of highly differentiated volatile enriched granitic magmas. The host rocks of the intrusion also play a significant role in the final composition of the pegmatites due to the incorporation of host rock in the magma during the intrusive process.

Pegmatite complexes can vary from a few meters to a hundred meters in length with the same variation in widths. Typically, pegmatite intrusions are zoned and show the following structures from the exterior to the interior: 1) the rim zone is usually very narrow and fine-grained; 2) the wall zone is normally composed of quartz, feldspar and muscovite and marks the apparition of larger crystals typical of pegmatites; 3) the intermediate zone, when present, comprises a more complex mineralogy with varying amounts of economical minerals such as micas, beryl (Be), spodumene(Li), amblygonite(Li), lepidolite(Li-Rb), colombite-tantalite (Nb-Ta) and cassiterite(Sn). Crystals in this zone can extend up to metric lengths and 4) the central zone is mainly composed of quartz in pods or automorph crystals.



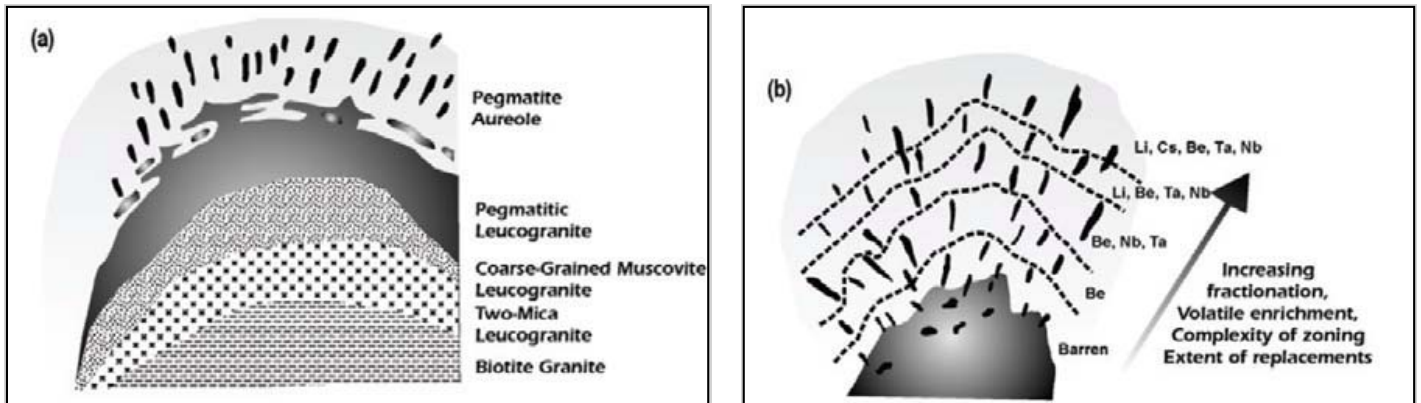

Figure 8 – Typical element zonation in Pegmatite intrusions (Selway *et al.*, 2005).



Figure 9 – Spodumene bearing pegmatite example in drill core (left) and meta-sediments host rock (right).

## **8 DEPOSIT TYPE**

### **8.1. Origin and Features of Rare Metal Pegmatites**

The Sirmac deposit is a rare-metal bearing Pegmatite complex. Emplacement of rare metal pegmatites is the last phase of the crystallization of a parent granite pluton. High pressure residual fluids, with abundant water, silica, alumina, alkalis, and rich in rare elements and other volatiles from the crystallization of a pluton at modest depth, concentrate in the cupola or upper domed contact of the granite as it crystallizes. Under increasing pressure, this fluid dilates fractures in overlying rocks, thereby providing feeder channels for emplacement of pegmatites. Progressive crystallization of the main rock-forming minerals out of the fluid enriches the final fluids in rare metals and the process culminates in the formation of rare metal pegmatites sills. A variety of types occur depending on the abundance and type of rare metals associated with the pluton and the physico-chemical conditions affecting the sequence of emplacement events.

Pegmatite petrologists classify the different types and subtypes by combinations of the following criteria:

- Mineralogical-geochemical signatures;
- Internal structure/zonation;
- Pressure-temperature conditions of crystallization.

The criteria are related to the degree of fractionation, which arise from the chemical, temperature and pressure evolution of the pegmatite fluids over time and distance from the parent granite. The complex rare element pegmatites generally evolve as follows: at depth under high-pressure and temperature conditions, simple granite pegmatites of quartz, feldspar and mica crystallize in fractures above and within the solidified granite pluton. Above this level, columbo-tantalite minerals appear starting with high niobium compositions and progressing to higher tantalum/niobium ratios where the complex pegmatites appear with lithium, cesium, and rubidium bearing minerals (Figure 8). Variations may appear, in which petalite is the dominant lithium mineral, often along pollucite, lepidolite, etc. Alternatively, spodumene dominates in a classification known as Albite-Spodumene pegmatite. Tantalum may occur in a variety of minerals and cassiterite may also be present. A final, mariolitic or greisen phase at low pressure-temperature, may be present with lepidolite, quartz, tantalum-rich minerals, tin, topaz, etc.

Three characteristics of the geological setting for rare metal pegmatites are common:

- Emplacement in concordant stacked sills
- Presence of a compressed, near-vertical, syntectonic mobile zone that is the locus of pegmatite intrusion
- Host rocks most commonly are dominantly mafic volcanics often with intercalated metasediments and gabbroic rocks.

## **8.2. Stacked Sill Structure**

Although a field of rare metal pegmatites is commonly termed a dyke swarm, the major economic ones are most commonly emplaced in concordant, shallow to medium dipping sills with one or more steeply dipping feeder dykes. The mechanism for emplacement of the rare metal pegmatite sills is as follows: stratification in volcanic-metasedimentary gabbroic piles provides planes of weakness along contacts that facilitate entry of magmas, and hydraulic dilation by late-stage pressurized rare metal bearing fluid. The layering also provides a barrier or cap for the volatile fluids from which the final rare metal pegmatites crystallize. Zoning in the pegmatite results from a continuation of crystallization of the rock forming minerals from the cooler contacts inward in the dilated space-albite at the contact, dominantly K-feldspar with quartz-mica next, spodumene quartz with some feldspars and mica, and finally, a core of quartz (in the albite-spodumene type). This simple zoning is often made more complex by two or more pulses of intrusion, albitisation and other replacement reactions.

## **8.3. Syntectonic Mobile Zone Feeder Dykes**

The feeder dykes are near vertical and represent the conduit from depth connecting the pluton to the final rare metal pegmatite bodies. In most cases, shearing at the contacts of the dyke and mylonitisation and/or plastic deformation of the feeder pegmatite identifies this as a deeper, syntectonic mobile zone. In extreme cases, the feeder pegmatite may be stretched and result in the formation of boudinage structures (as occurs at the Moblan Lake “Southwest Dyke” in northern Quebec). The feeder dykes tend to be intermediate in composition in the fractionation chain.

## **8.4. The Sirmac Pegmatites**

The Sirmac pegmatite is a rare-element granitic pegmatite. The ore bodies comprise mainly sills and some feeder dykes are also present. The spodumene-rich pegmatites display typical zoning to varying degrees – an albite wall zone at the contacts followed by an intermediate zone containing mostly feldspar, quartz,

mica and spodumene, followed by a spodumene-quartz-rich core zone. Many core zones are present and the mineralogy is the same which occurs as large crystals of spodumene (up to 30 cm) contained in a quartz-feldspar matrix, sometimes with accessory minerals like tourmaline and apatite. The presence of beryl was also observed in the margin of some core zone and triphylite (lithium phosphate) was observed in different zones. The core zones do not have a consistent orientation, which means that different phases of intrusion and crystallisation could have happened. The host rock is mainly metamorphic sedimentary rocks. This unit may have a role in the structural control of the pegmatite, but insufficient stratigraphic or structural work was done on this unit.

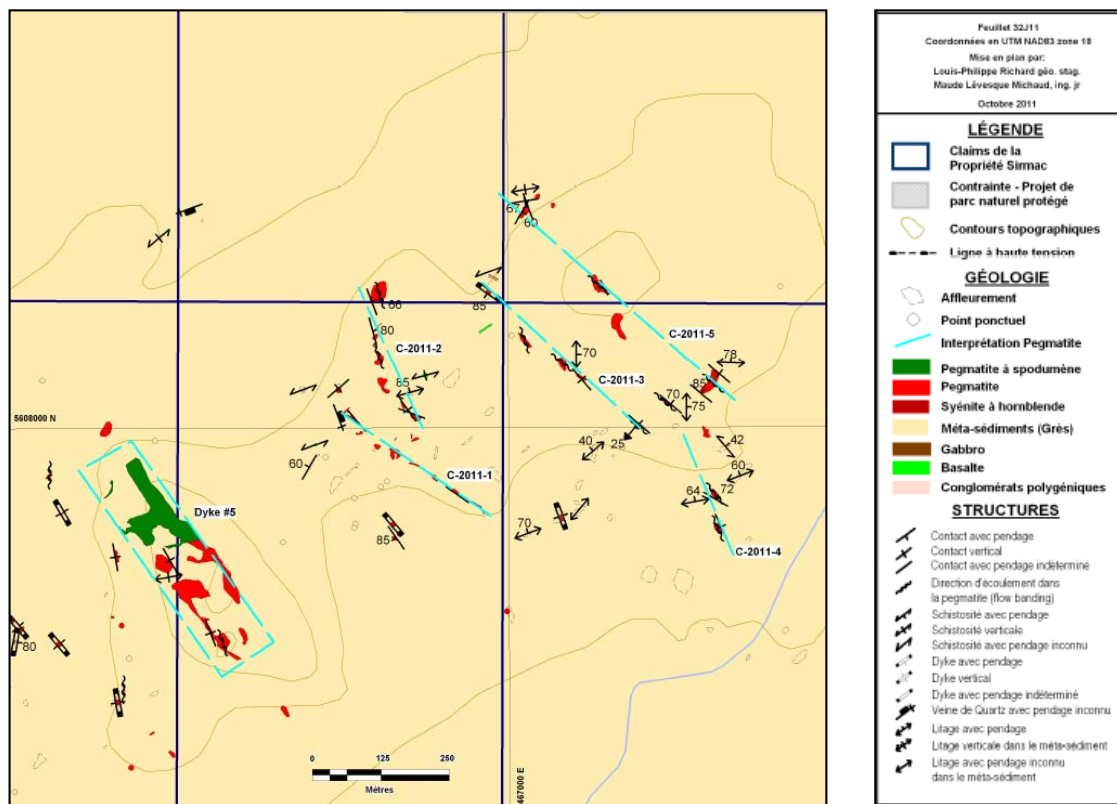

Figure 10 – Exploration Mapping in the vicinity of #5 dyke (SGS Geostat, 2014).

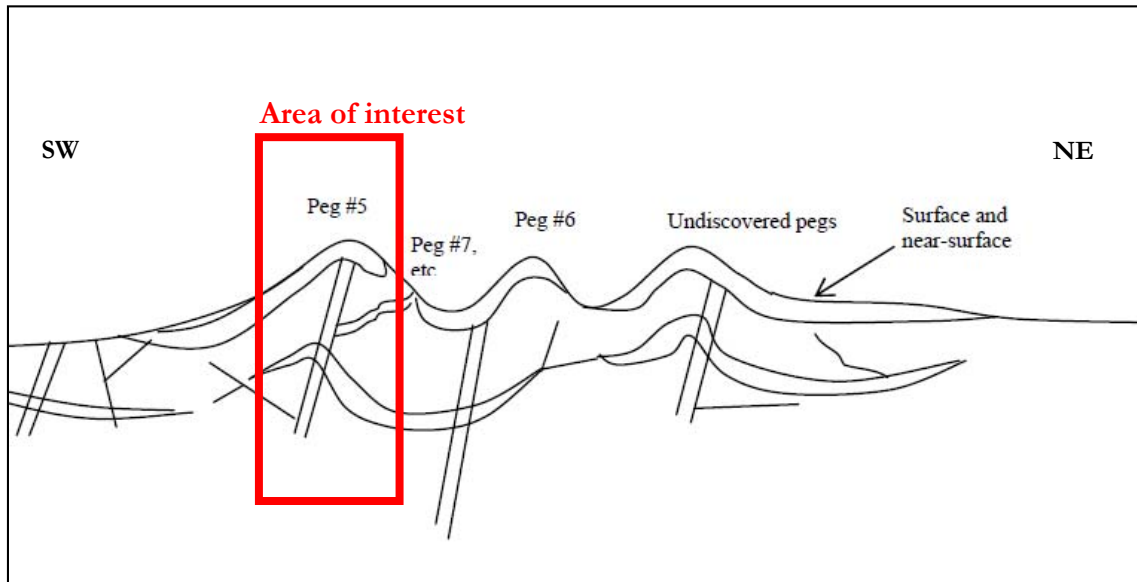

Figure 11 – General cross section interpretation from Pearse (2010).

## **9 EXPLORATION**

The Sirmac deposit has a rich exploration background with exploration work conducted by many companies (see section 6). This work included prospecting, mapping, geophysical surveys and 2 drilling campaigns (1959 and 1994).

Nemaska acquired the initial claim block in 2010. The first exploration work was completed in the fall of the same year and consisted in a single day of sampling and prospecting, mostly concentrated on #5 dyke.

In 2011, a month-long exploration campaign focussed on the discovery of potential extensions of #5 dyke. Work included prospecting, mapping and sampling. Several barren pegmatite dyke outcrops were located but no major mineralized structures were discovered.

In the summer of 2012, drilling and trenching were undertaken on the Sirmac property. The main outcrop area of #5 dyke was stripped and 10 channels were cut in the rock at a 25 m spacing totalling 364 meters. 19 other trenches were also done over the property with different location and spacing; these trenches represent a total strike length of 378 meters. Over the same period, 73 NQ size diamond drill holes were drilled on the property, for a total length of 3,379 m. The #5 area was drilled at a 25 m section spacing and 12.5 m away from the trenches.

### **9.1. 2018 Exploration work by Vision Lithium**

*The information contained in the 2018 Assessment Report by MRB & Associates (2019) are presented in the following paragraphs. It contains all relevant information that adds value to the understanding of the evolution of the exploration on the Property.*

There has been some work done on the property in 2018, starting with an “Ultra ground-penetrative radar” (UltraGPR) that was carried out by Caracle Creek International Consulting Inc. where a total of a little over 13 line-km covered the #5 Dyke area. The data collected was then interpreted by International Groundradar Consulting Inc. That work was done in April.

In June 2018, a Time-Domain Resistivity/Induced Polarization survey was completed by Abitibi Geophysics using their OreVision® IP array. The goal of this survey was to define the depth of the #5 Dyke complex. However, a large resistive anomaly was associated with high-chargeability values. That anomaly was named S-05.

A prospecting campaign was performed on the Property in summer 2018. It was split in two phases, from June 10<sup>th</sup> to 19<sup>th</sup>, and from Sept. 13<sup>th</sup> to 17<sup>th</sup>. The goal of this prospecting campaign was to extend the #5 Dyke zone and the East Zone. All outcrops encountered was measured, described and sampled. In the end, 39 samples were taken and sent to ALS Global Inc. laboratories in Val d’Or.

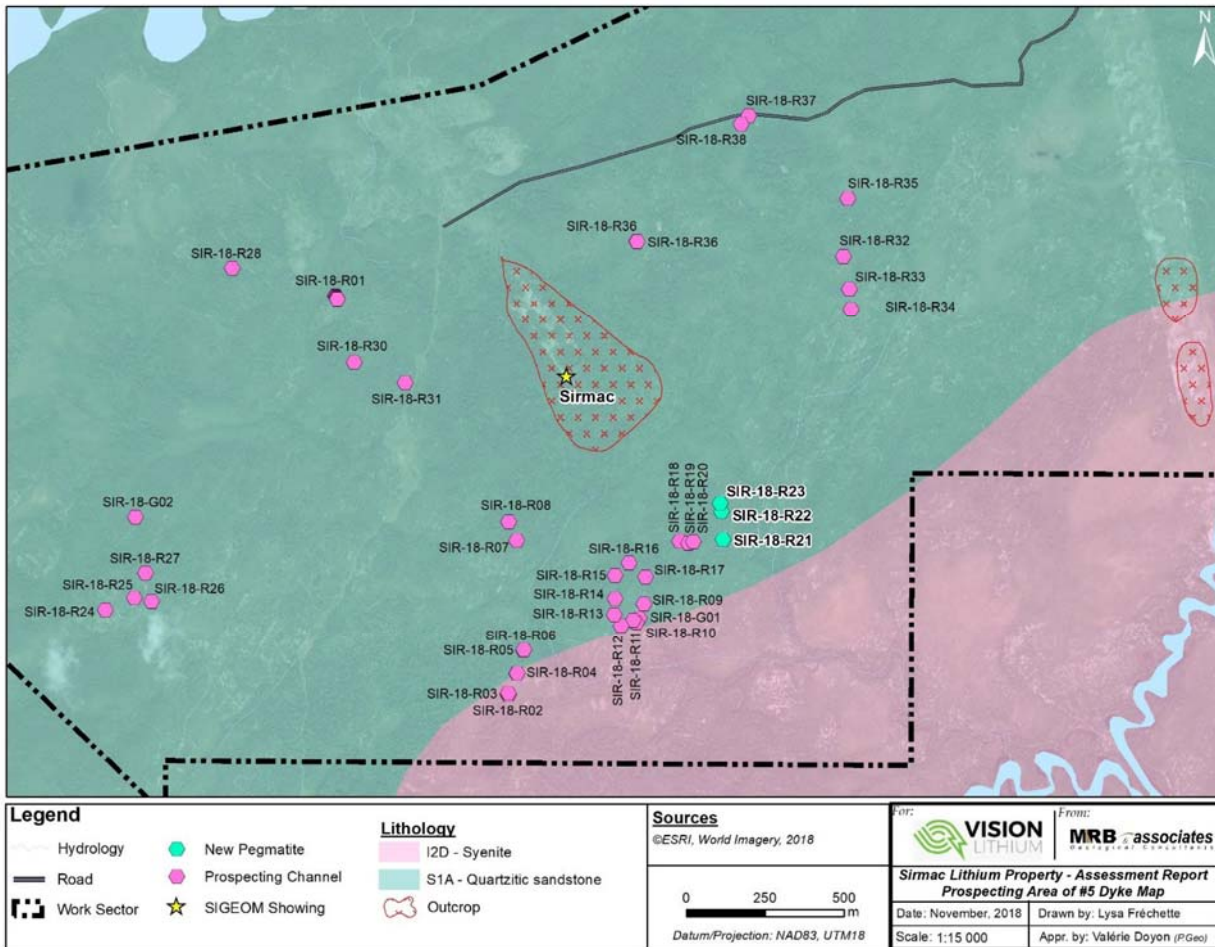

**Figure 12 – Prospecting Sample Location (Doyon, 2019).**

In July 2018, a campaign was conducted through 7 days consisting of stripping some of the East Zone and channeling it. 5 channels were made and sampled. Groupe Ungava, who is responsible for the stripping in July, returned in August to strip some additional areas. In September, it was decided to return to the East Zone to do more channeling, which took 6 days and allowed to cut 22 more channels in the rock. A total of 27 channels totaling 185m was cut which gave 147 channel samples along with 16 QAQC samples. The channeling and sampling work was done by GL Géoservices.

Note that all the groundwork and exploration performed on the Property in 2018 was supervised by MRB & Associates.

A 3D model of the #5 Dyke zone was done in order to better understand the difference between the unmineralized and mineralized pegmatite. It demonstrated that both pegmatites dip was between 45 and 55 degrees and that the two types joined together at 395m below the surface.

On August 4th, 2022, Geo Data Solutions GDS Inc. received a contract to execute a digitally recorded, high sensitivity helicopter-borne magnetic and gamma-ray spectrometric survey. This survey was 3353 line-km long and was carried from August 27th to September 6th. The data collected from this survey was then analysed by Camille St-Hilaire Geophysics Inc.



## 10 DRILLING

### 10.1. Overview

In 2018 and 2022, Vision Lithium completed 27 and 28 drillholes on the Property, respectively. In addition to the 2018 drilling campaign, data on two (2) grab samples and 39 channels were collected. A summary of the work engaged is presented in the following table.

**Table 3: Drilling and channel sampling executed by Vision Lithium in 2018 and 2022 in the Sirmac Property.**

	Year	Qty	Length (m)
<i>DDH</i>	2018	27	1,596.00
<i>Channels</i>	2018	39	41.80
<i>Grab samples</i>	2018	2	0.80
<i>DDH</i>	2022	28	3,256.30

### 10.2. 2018 Drilling work

From April to May 2018, 27 drill-holes were made for a total of 1,596m by Chibougamau Diamond Drilling Inc. A total of 353 half-core samples and 46 control samples were sent to ALS Global in Val d'Or. Five (5) of the 27 holes were twins in order to check the old values of the original holes drilled 6 years prior. One of the drill-holes was probed using a portable XRF in the start of June to try to differentiate spodumene bearing pegmatite to sterile pegmatite. The machine used was a Vanta™ handheld portable XRF analyzer and a Model RS-230 scintillometer.

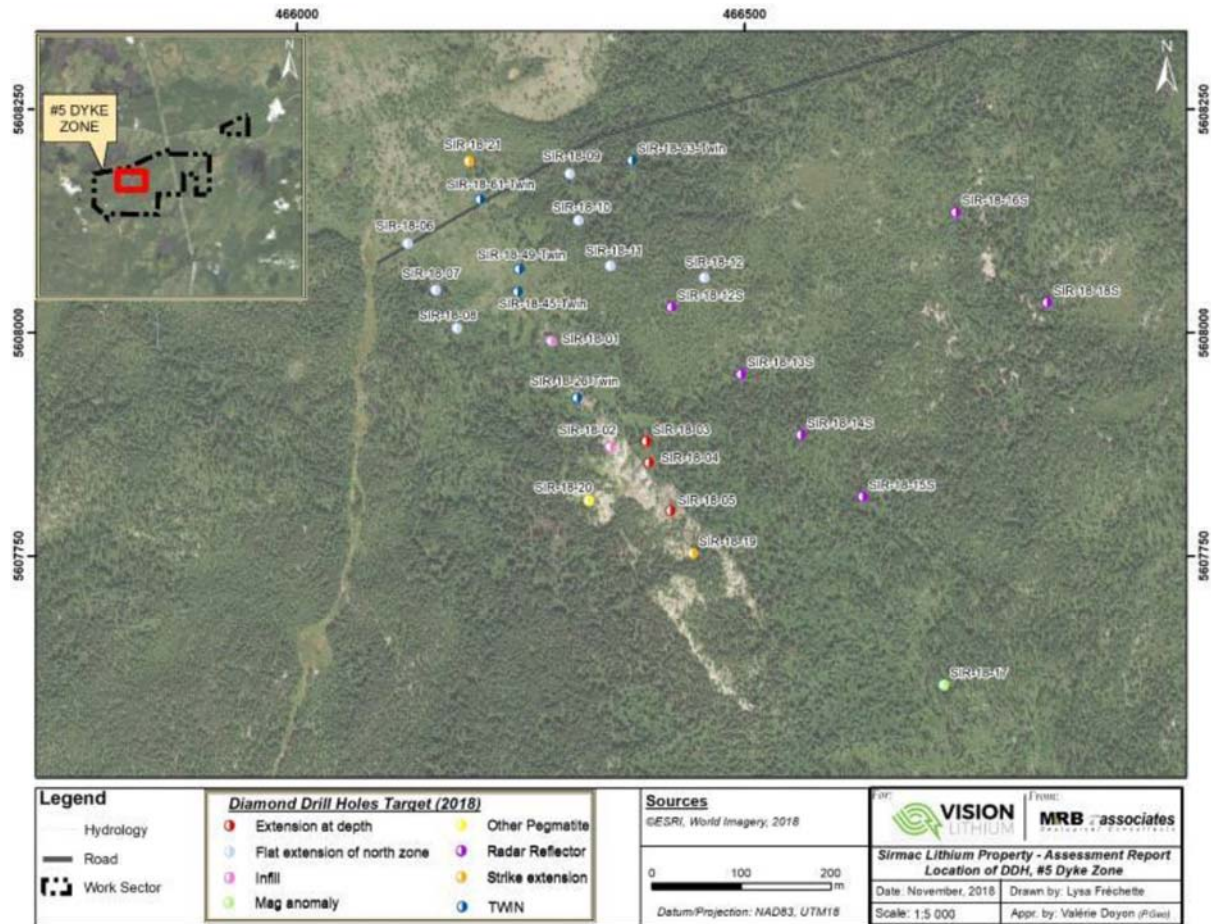

Figure 13 – Dyke #5 2018 diamond drillholes locations (Doyon, 2019).

A drilling campaign followed the stripping and channeling campaign in August 2018. Five (5) holes were drilled in order to help determine the depth and the geometry of the pegmatite intrusions. The holes were spotted using a handheld GPS and core was logged by the MRB & associates. A total of 483m of core was drilled, which gave 108 samples of half-core samples that were sent to the laboratory along with 12 control samples.

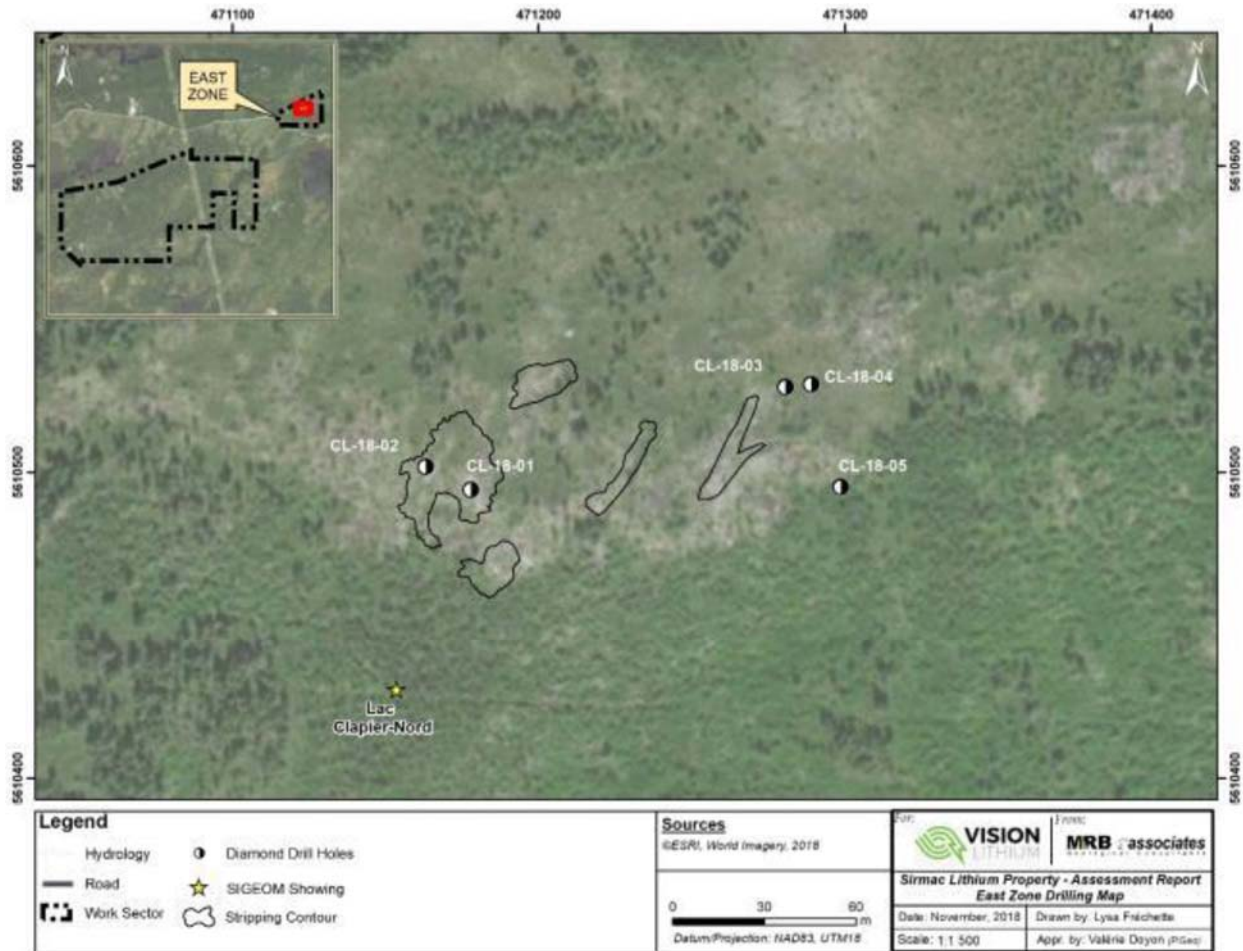

Figure 14 – East Zone 2018 diamond drillhole locations (Doyon, 2019).

### 10.3. 2022 Drilling work

In the summer of 2022, 28 drillholes were drilled in NQ size core by Forage Hébert Inc., totalling 3,256.30m of core. A total of 575 half-core samples and 11 control samples, including standard, blank, and duplicate samples, were sent to ALS Global in Val-d'Or. The assay data were collected for 510.15m of core, representing approximately 15.6% of the core drilled during that program.

On the site of every hole of 2022, the casing is in place and a wooden stick with the collar indications is still visible.



**Figure 15 – Example of monument left at the 2022 drillhole locations.(picture GMG QP site visit)**

The following figure presents drill holes locations and samples in addition to satellite image background where the recent logging roads are visible.

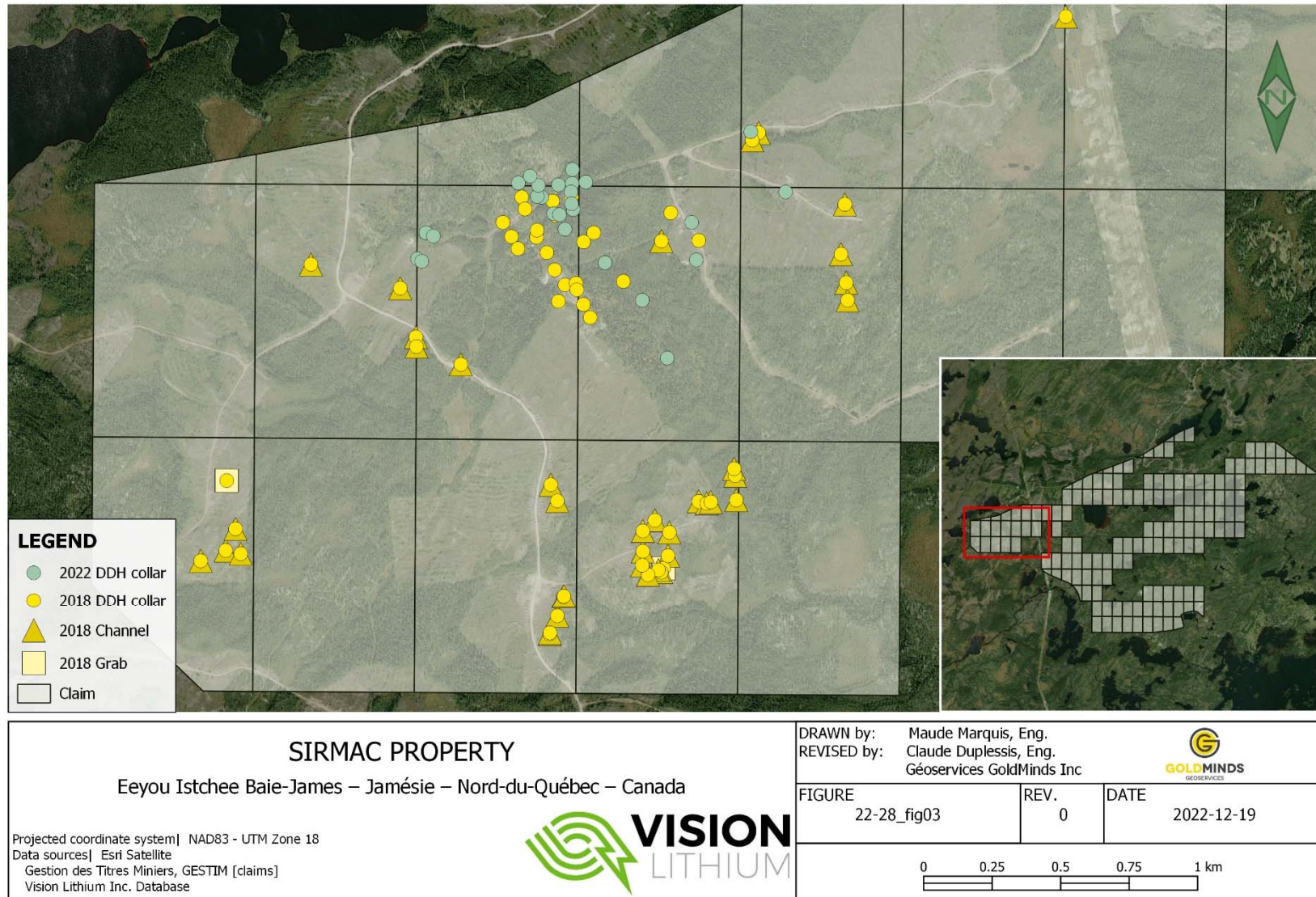

Figure 16 – Layout with the locations of the drillholes, grab samples, and channels from the 2018 (yellow), and 2022 program’s (light green).

## **11 SAMPLE PREPARATION, ANALYSES AND SECURITY**

*Information presented in sub-section 11.1 have been retrieved from the NI 43-101 Technical Report on Mineral Resource Estimation of the Pegmatite #5 Lithium-Tantalum Deposit completed by SGS Canada – Geostat, and written by G. Desharnais, Ph.D., P.Geo, J.-P. Paiement, M.Sc., P.Geo, and J. Gagné, Eng., for Nemaska Lithium Inc. (2014). According to the above-mentioned report, paragraphs are derived from Nemaska’s sampling procedures.*

*The subsequent sub-section 11.2 is in relation to the sampling procedure and various data collection made by Vision Lithium in 2018 and 2022.*

### **11.1. Sample preparation, analyses and security for the 2012 exploration campaign**

#### **11.1.1. Sample Preparation and Analyses**

Drill core samples are marked for sampling by Nemaska’s geologists during the logging process and are then separated in half cores along the hole using a mechanical rock splitter. Samples are then bagged and stored onsite before shipping to the Laboratories. Channel samples were taken with a portable rock saw and the pre-marked intervals were individually bagged, tagged and stored prior to shipping. Sample numbers from the field tags are entered in the database by the geologists.

Channel and drill core samples collected during the 2012 exploration program were transported directly by Nemaska representatives to the ALS Chemex laboratory (here after “ALS”) in Val-d’Or. All samples underwent the same sample preparation and analyses.

The submitted samples were prepared under the protocol PREP-31 (ALS code). By this protocol, each sample is logged in the tracking system and weighed. Drying is done to samples having excess moisture. Sample material is finely crushed to at least 70% passing a 2 mm screen (9 mesh). A split of up to 250 g is taken and pulverized to at least 85% passing a 75 microns screen (200 mesh).

The analytical protocol used was Li-OG63 (ALS code), an ore grade lithium four-acid digestion with Inductively Coupled Plasma – Atomic Emission Spectrometry (ICP-AES). This analytical method uses 4 g of pulverized material and returns a lower detection limit of 0,005% Li. Tantalum was later analyzed in the pulp rejects of the core samples at ALS using ME-MS81 protocol for rare earth and trace elements. The results are reported in ppm with a lower detection limit of 0.1 ppm and an upper detection limit of 2500 ppm.

Some drill core samples were also analyzed by protocols ME-MS41 and Au-TL43 (ALS code). These methods were used to detect metals and gold concentrations in core samples where metal mineralization was identified (mostly arsenopyrite). The ME-MS41 is an ultra-trace level method (51 elements) using Inductively Coupled Plasma – Atomic Emission Spectrometry (ICP-AES) and Inductively Coupled Plasma – Mass Spectrometry (ICP-MS). A pulverized sample (0.5 g) is digested with aqua regia in a graphite heating block. After being cooled, the solution is diluted with deionizing water, mixed and analyzed by ICP-AES. Results are reviewed for high concentrations of silver, bismuth, mercury, molybdenum and tungsten and diluted accordingly. For the remaining elements, samples are analyzed by ICP-MS and analytical results are corrected for inter-element spectral interferences. The Au-TL43 is a method using ICP-MS or Atomic Absorption Spectrometry (AAS). A pulverized sample (25 g) is digested in a solution of 3 parts hydrochloric acid and 1-part nitric acid (aqua regia). Nascent chlorine and nitrosyl chloride are generated from this acid mixture and they dissolve free gold and gold compounds. The dissolved gold is complexed and extracted with Kerosene/DBS and determined by graphite furnace AAS.

Following the discovery of tantalum mineralization during metallurgical testing (see section 13), all the drill core pulp samples were sent back to ALS laboratory for Ta<sub>2</sub>O<sub>5</sub> analysis.

Upon reception of the numerical assay results by e-mail from the laboratory, the assay values are imported into the database and assay certificates are archived.

#### ***11.1.2. Quality Assurance and Quality Control Program***

On top of the laboratory quality assurance quality control (QA/QC) routinely implemented by ALS, Nemaska developed an internal QA/QC protocol involving insertion on a systematic basis of analytical standards, blanks and sample duplicates with the samples shipped to the laboratory. The QA/QC verification is done by the author in the following section. In the event of QA/QC failure from control samples during exploration phases of the project, all the samples associated with the assay certificate are re-analyzed from the witness pulps. No limits are established and the QA/QC control is done by the geologist on a judgmental basis.

#### **Analytical Standards**

Two different standards were used for the internal Li QA/QC program: a “LOW” standard, which is a low grade lithium material and a “HIGH” standard, which is a high grade lithium material. Both standards are custom made reference materials coming from drill core of the Whabouchi project, another lithium project developed by Nemaska in a spodumene-bearing pegmatite. Standard materials were prepared by TJCM laboratory in Chibougamau using its own preparation protocol. Each standard sample was weighed by

Nemaska representatives to approximately 30 g. Concentrations of lithium were determined with the analyses of each material three times in two different laboratories (SGS Minerals and ALS Chemex). Both laboratories showed relatively consistent results with a good correlation between the two labs. The average values are presented in following table.

**Table 4: Average grades of analytical standards**

Analytical Standard	Grade (% Li)	Grade (% Li <sub>2</sub> O)
LOW	0.46	1.0
HIGH	0.78	1.7

For each 100 samples, two “HIGH” and one “LOW” standard were inserted, for a total of 39 “HIGH” and 21 “LOW” standards. This represents a percentage of 3.4% of the total samples analyzed.

Upon re-analyzing pulp rejects for Ta, Nemaska used two other standards for the Ta QA/QC program: a low grade Ta standard from Oreas with reported values for rare earth element but not for Ta. This standard was evaluated using the rare earth elements reported by the laboratory and consistency of Ta results was also verified. A second, high grade standard was also used. This standard is prepared by the CCRMP-CANMET especially for Ta projects. The nominal value is this standard is 2360ppm ± 50ppm.

#### **Analytical Blanks**

Nemaska used silica blank for its internal QA/QC program. This silica material came from a silica mine in Charlevoix (SITEC). Blanks were inserted every 20 samples. A total of 78 blanks were analyzed (4.5% of total samples).

#### **Samples Duplicates**

Sample duplicates were inserted every 20 samples as part of Nemaska internal QA/QC program. Duplicates are made from a quarter NQ core from the corresponding sample, or a representative channel sample cut parallel to the main channel. A total of 79 duplicates were inserted, for a percentage of 4.5% of total samples.



## **11.2. Sample preparation, analyses and security for the 2018 and 2022 exploration campaigns**

### ***11.2.1. Sample Preparation and Analyses***

The sampling approach was established by Vision Lithium. Core logging and sampling was performed by MRB & Associates geologist following procedures further described herein.

At reception, all core boxes were progressively opened and placed in order on the logging tables. All meterage wood blocks were verified to control core box numbers and any possible mistakes made during drilling procedures.

Logging procedures included a mineral description of geological units and sub-units in terms of color, grain size, alteration, accessory minerals and fracture descriptions. These descriptive data were entered in a database and compiled by drillhole. Pictures of the core boxes were taken, one showing dry cores and a second damp cores. Once the geology is described, the geologist marks the beginning and the end of the samples directly onto the core.

Sample length of 0.4 to 1.7 meters were selected for intervals with clear signs of minerals, with an average sample length of 1.5 meters.

Numbered sample tags were placed at the beginning of each sample, together with distinctive arrows on the core marking the beginning and end intervals. The tag numbers are integrated in the database.

All drill-core samples were cut in half using the wet cutting saw for rock at MNG Services' facilities in Val-d'Or. One half of the cores was retained and placed back in the core box, respecting the original orientation and position. Sample tags were stapled to the bottom of the box at the beginning of each sample interval, so that each sample could be relocated following future handling, transportation and storage.

As for the channel samples, those were collected using a portable rock saw and the pre-marked intervals were bagged, tagged and shipped to the ALS Global Laboratory in Val-d'Or.

Sample submittal forms were included in emails informing the laboratory of the date and method of expedition of every shipment made regarding these samples. Shipped samples were received in good standing.

### **11.2.2. Quality Assurance and Quality Control Program**

A rigorous QA/QC program was established by the Vision Lithium. This procedure includes the systematic addition of blanks and three (3) different grades of certified reference material (CRM) standard. The sampling preparation described here was performed under the supervision of MRB & Associates geologist. Since all assays were analyzed at an independent and certified laboratory, no duplicates were sent to another laboratory.

#### **Analytical Standards**

A total of 61 blank samples were inserted and 62 standards were included (29 Oreas 147, 27 Oreas 148, and 6 Oreas 149) as part of the QA/QC program.

The standards Oreas 147 were prepared by OREAS from a blend of spodumene-rich pegmatite ore and granodiorite with minor additions of Sn oxide ore and Nb concentrate. The pegmatite is from Greenbushes Mines, the Sn oxide from Doradilla Project in north central NSW, and the Nb concentrate is sourced from Anglo American Brasil Catalão's niobium mine in Goiás in Brazil. Bags contain lithium oxide grading 0.488%  $\text{Li}_2\text{O} \pm 0.023\%$  and lithium grading 0.227%  $\text{Li} \pm 0.011\%$ , both assayed by peroxide fusion ICP. In between the intervals planned by the geologist, the standards were bagged in translucent bags identified by their own sample tags.

The standards Oreas 148 were prepared by OREAS with the same blend as Oreas 147, but different grades. Bags contain lithium oxide grading 1.03%  $\text{Li}_2\text{O} \pm 0.023\%$  and lithium grading 0.476%  $\text{Li} \pm 0.011\%$ , both assayed by peroxide fusion ICP.

The standards Oreas 149 were prepared by OREAS with the same blend as the other CRM from the same Li ore group. Bags contain lithium oxide grading 2.21%  $\text{Li}_2\text{O} \pm 0.064\%$  and lithium grading 1.03%  $\text{Li} \pm 0.030\%$ , both assayed by peroxide fusion ICP.

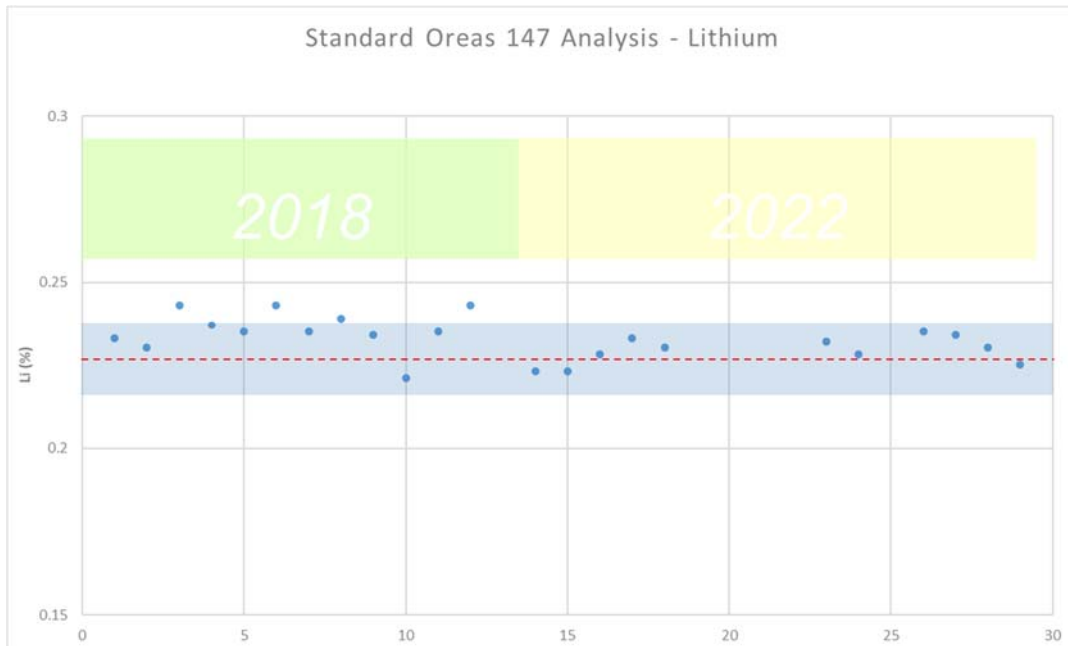

**Figure 17 - Distribution of standards (Li %) used during the 2018 and 2022 exploration work – OREAS 147. Certified average presented by the dashed red line; 1 SD low and high covered by the blue corridor.**

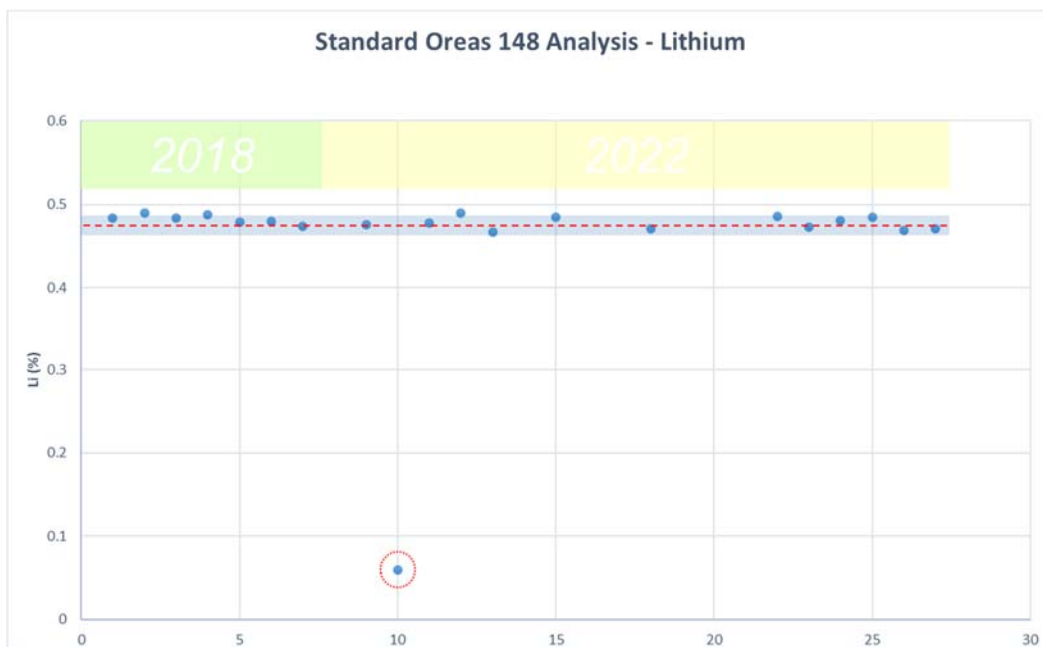

**Figure 18 - Distribution of standards (Li %) used during the 2018 and 2022 exploration work – OREAS 148. Certified average presented by the dashed red line; 1 SD low and high covered by the blue corridor.**

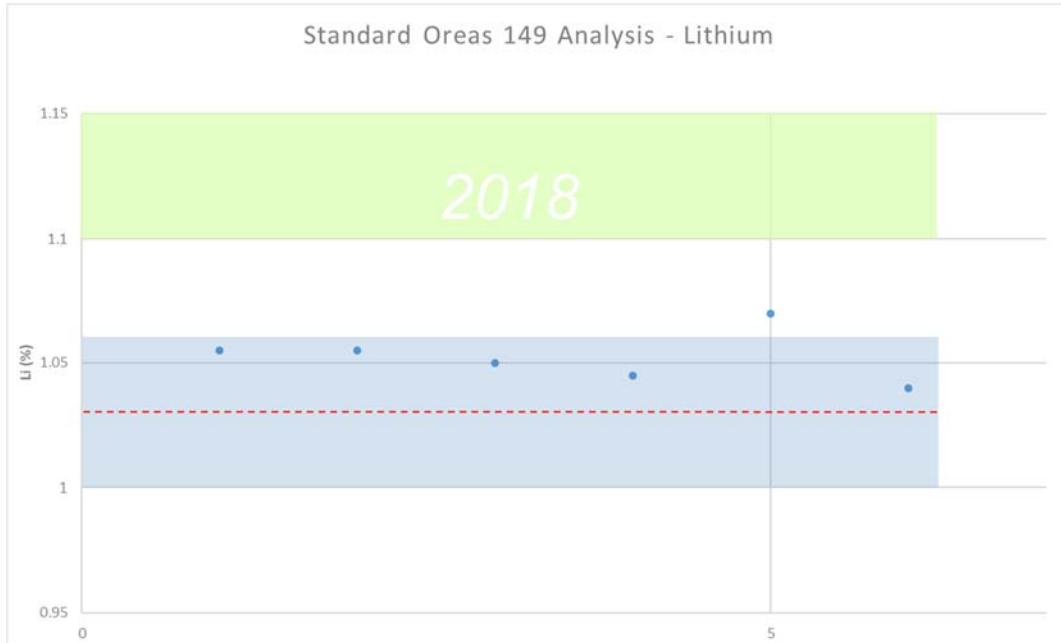

**Figure 19 – Distribution of standards (Li %) used during the 2018 and 2022 exploration work – OREAS 149. Certified average presented by the dashed red line; 1 SD low and high covered by the blue corridor.**

The results of assay showed that there was an anomalous value grading 0.059 % Li within the batch of Oreas 148 of 2022. Our hypothesis is that this standard was interchanged with a blank during the packing process.

For the standard Oreas 147, four (4) assay results are slightly above the average value certified by the producer, but none of them exceeded second standard deviation. Same goes for three (3) results of Oreas 148 and one (1) result associated with a standard Oreas 149.

### **Analytical Blanks**

The material used for the custom-made blank was garden rock carbonate gravel. From the 2018 and 2022 programs, none of the assay returned anomalous value, as show on

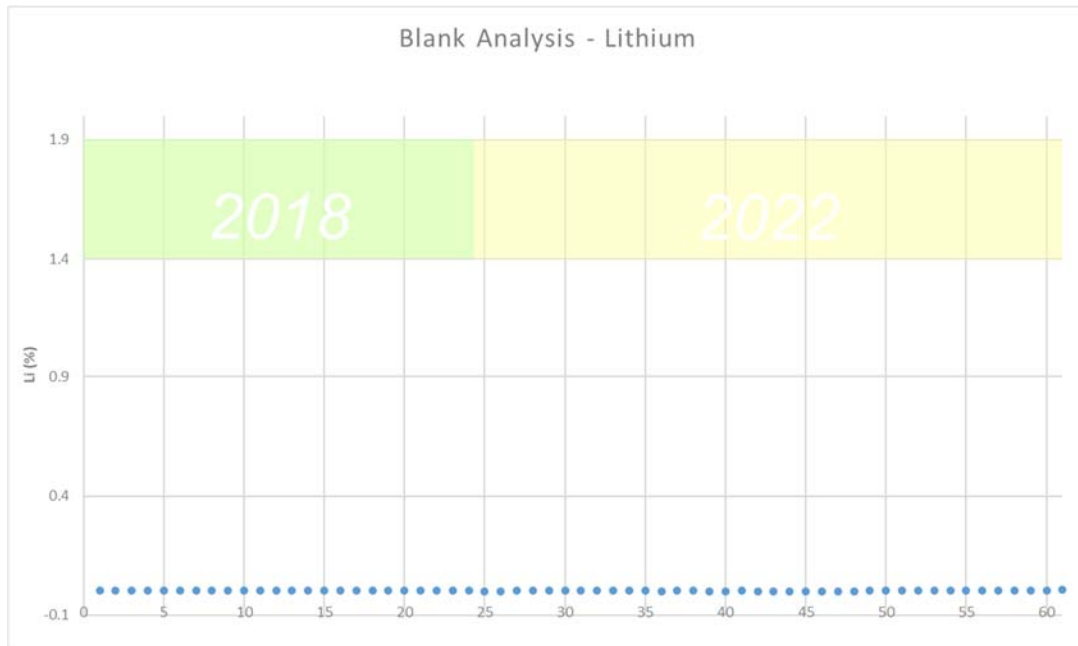

**Figure 20 – Distribution of blank samples used during the 2018 and 2022 exploration work (rock carbonate gravel).**

## **12 DATA VERIFICATION**

In accordance with the National Instrument 43-101 guidelines, Claude Duplessis P. Eng., from GoldMinds Geoservices, visited the property on October 26<sup>th</sup> & 27<sup>th</sup>, 2022. The latter was accompanied by Maude Marquis Eng., and Olivier Morency-Brousseau, GoldMinds employees. During the site visit, independent sampling work was conducted on the Dyke 00+05 and Dyke #5 for data verification of results associated with channels of the 2012 work program.

On a subsequent visit dated November 9<sup>th</sup>, 2022, Mrs Maude Marquis visited the MNG installations were the core of the 2022 drilling campaign executed by Vision Lithium are currently temporarily stored. Further independent samples were collected from holes SIR-22-12 and SIR-22-21. Remote Visio-conference was used between Maude Marquis and Claude Duplessis for review and sampling of the core.

The data verification was done on four (4) elements: 1. Validation of the GeoticLog© database and relations between each table (collars, deviations, lithologies and assays); 2. Block model validation in the light of the new information currently available; 3. QAQC data analysis; and 4. Independent control sampling.

### **12.1. Database validation**

The database transferred to GoldMinds for validation purposes was created by Vision Lithium using Geotic©. The database contains info regarding 181 drillholes (28 from 2022, 27 from 2018, 73 from 2012, and 53 historic holes), 68 channels, and 2 grab samples. This represents a total of 1,660 deviation measurements, 3,250 assays (522 historic results) and 1,165 lithology records.

No major issues were found in the database other than small corrections made to the elevation of the collars of several new 2018 and 2022 drillholes and channels so that their traces follow the topography more accurately.

### **12.2. Block model validation**

Modelling and block interpolation was done by SGS Geostat in 2014 using Genesis© software, developed by SGS Canada Inc. Pit optimization was done using Gem's Whittle module and Lerchs-Grossmann algorithm.

The diamond drilling campaign of 2018 comprised 27 NQ-calibre holes aiming to replicate five (5) 2012 historic holes, drill infill holes to confirm continuity of the mineralization, and test the down-dip and northward extend of the Dyke 00+05 (Doyon, 2019). The campaign of 2022 would test extensions even further east. The new data from 2018 and 2022 were initially incorporated in the Genesis© model from the Geotoc© database to validate if their location and the corresponding assays could significantly impact the resource estimation of 2014. Thus, justifying an update of the estimate. The following figures are sections extracted from Genesis© and showing the #5 Dyke with the geological interpretation made by SGS Geostat in 2014, the 2014 in-pit block model and the hole traces, including the more recent drillholes.

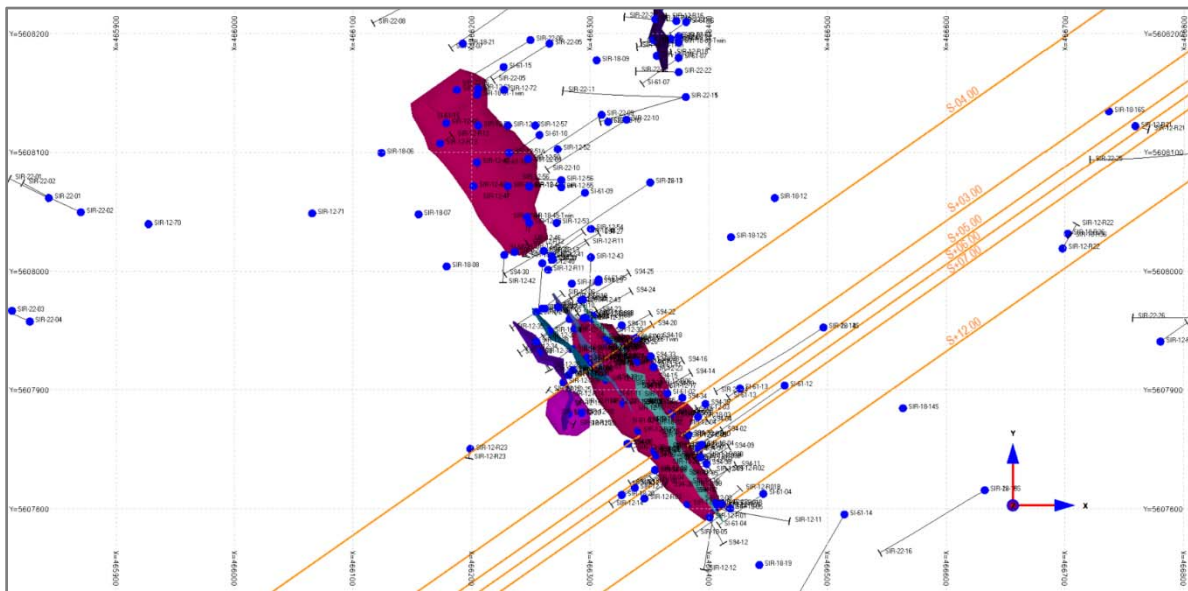

**Figure 21 – Plan view of the Dyke #5 according to SGS Geostat interpretation, with section orientations identified by orange stripes (Genesis©).**

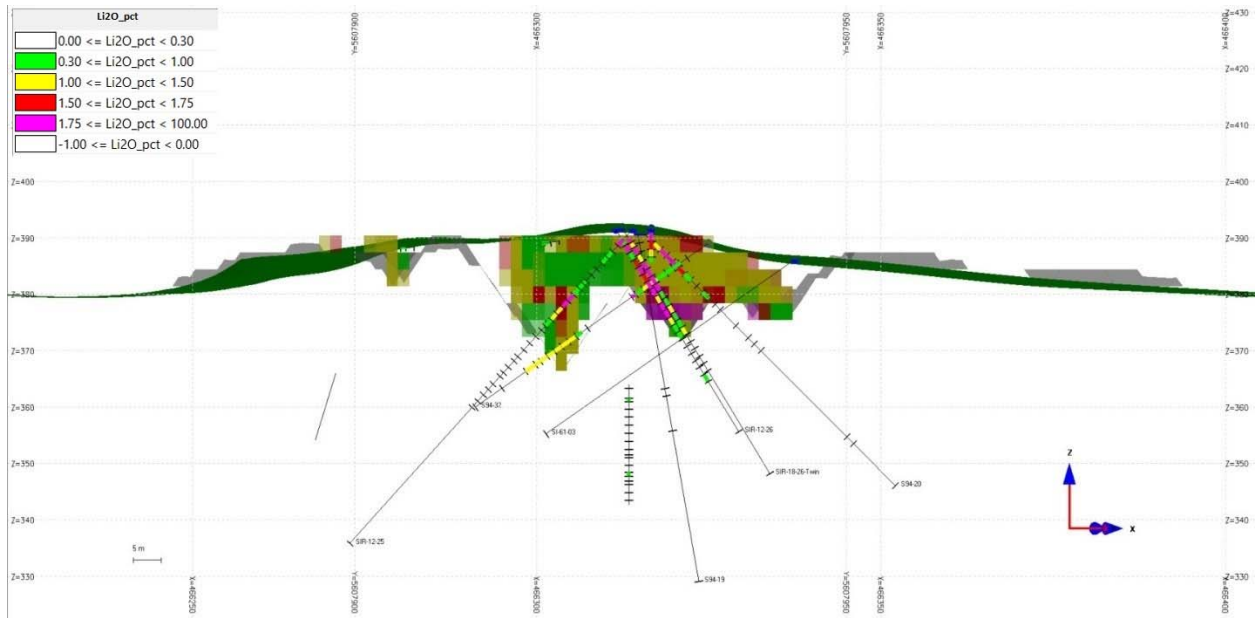

Figure 22 – Section view of Dyke #5 with recent hole SIR-18-26-Twin (on S-04.00).

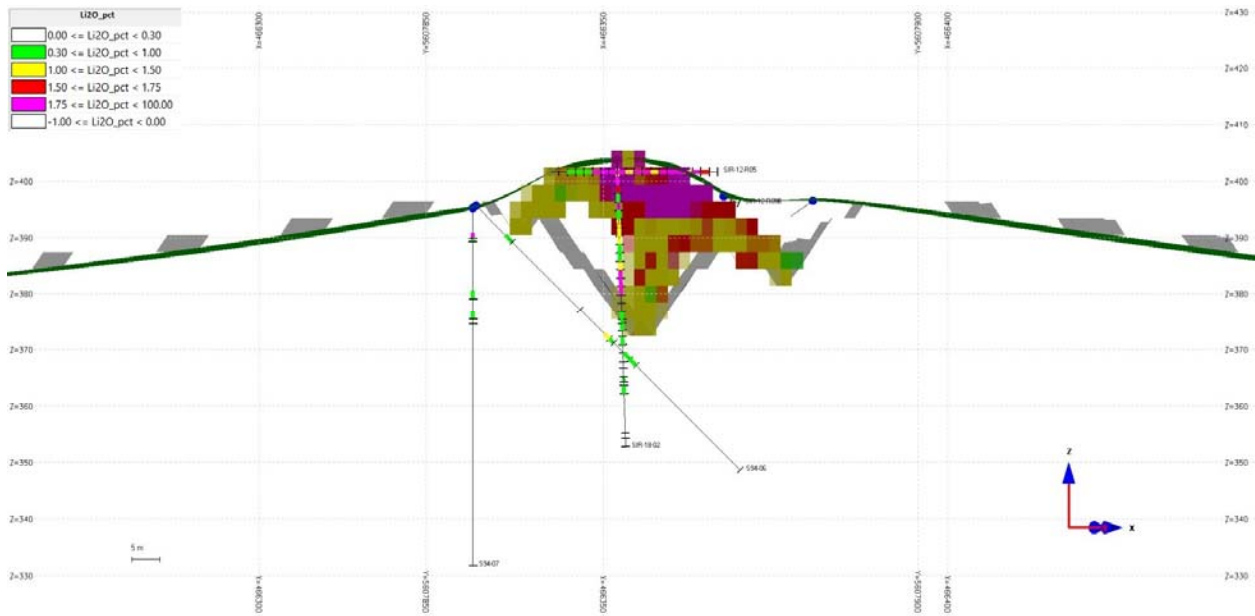

Figure 23 – Section view of Dyke #5 with recent hole SIR-18-02 (on S+03.00).



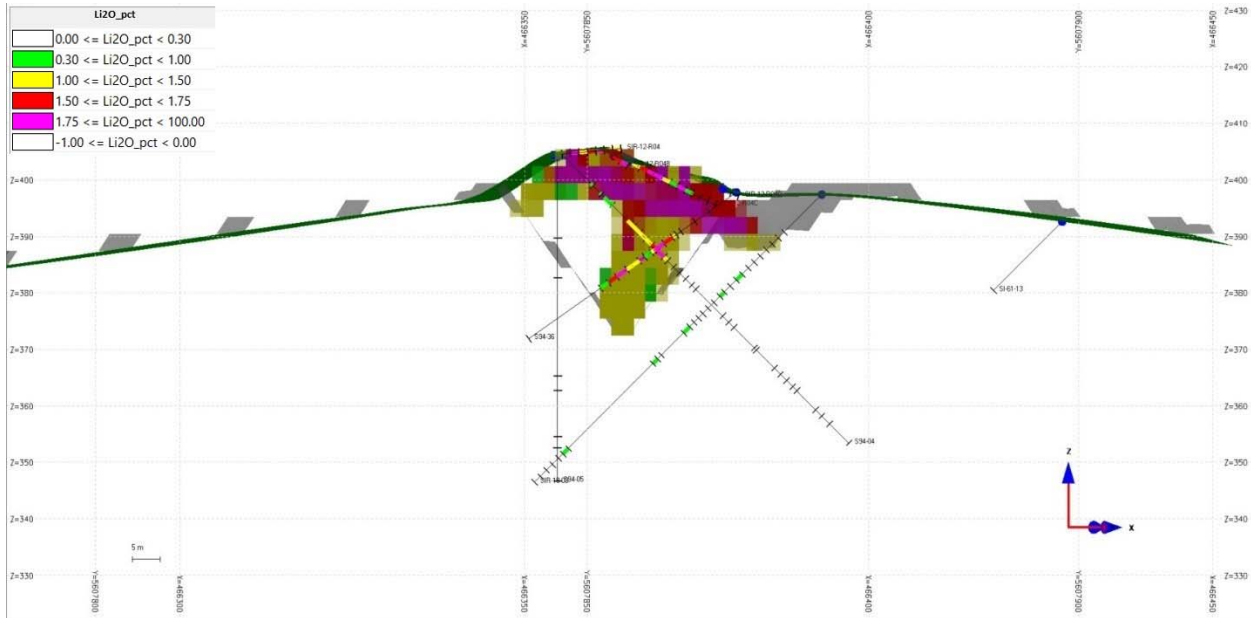

Figure 24 – Section view of Dyke #5 with recent hole SIR-18-03 (on S+05.00).

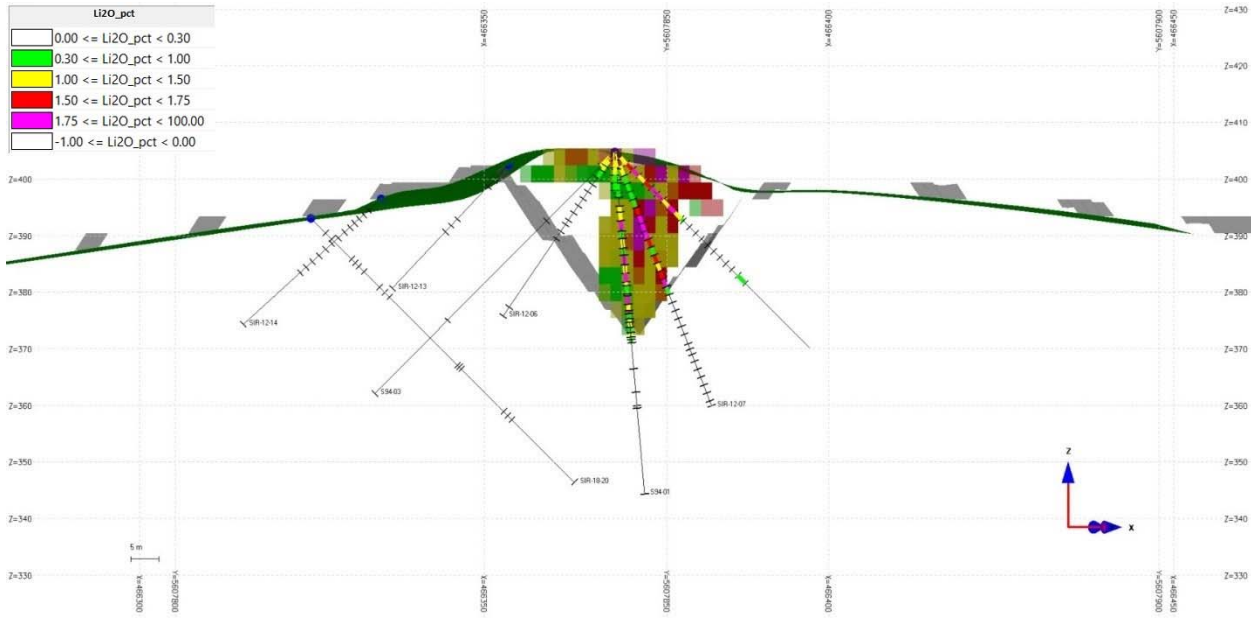
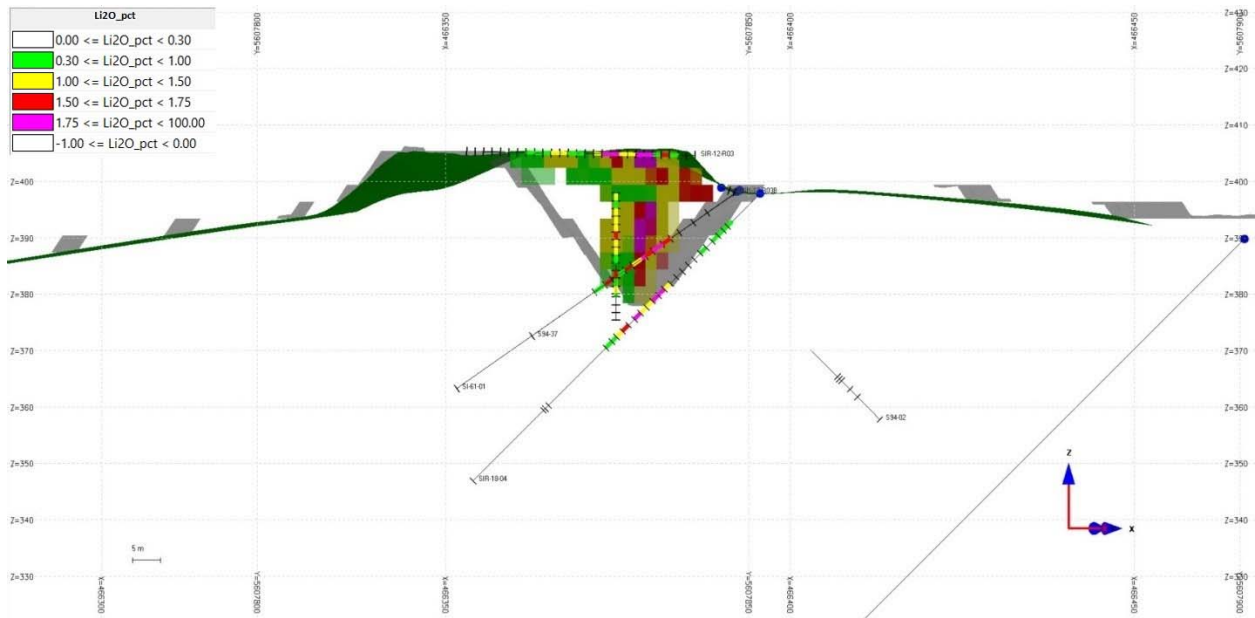
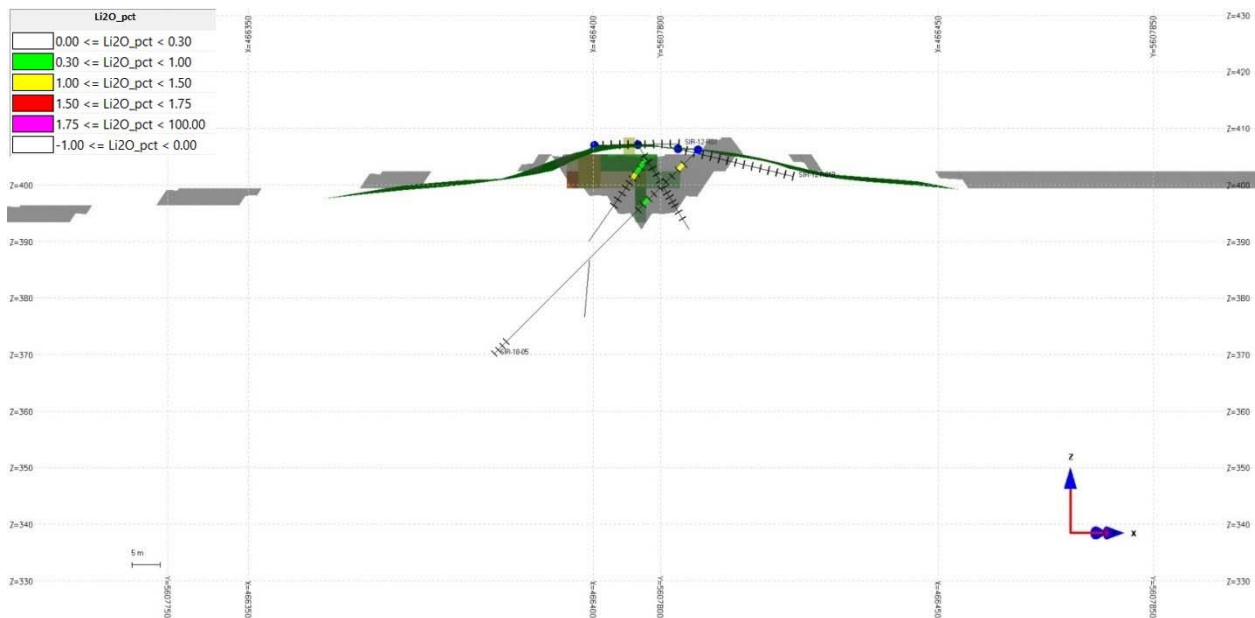

Figure 25 – Section view of Dyke #5 with recent hole SIR-18-20 (on S+06.00).



**Figure 26 – Section view of Dyke #5 with recent hole SIR-18-04 (on S+07.00).**



**Figure 27 – Section view of Dyke #5 with recent hole SIR-18-05 (on S+12.00).**

When looking at the section S+03.00 on Figure 23, drillhole SIR-18-02 confirms the mineralization. The envelope of the feeder and the block model could eventually be affected by the assays of that specific hole, by slightly expanding the structure to the southwest. The Authors believe that the current model remains adequate. The same point view is held despite the grades at depth under the structure on section S+07.00. For the purpose of the present Technical Report and since no other drillhole justify some significant

modifications of the current model, the latter developed by SGS Geostat in 2014 is used herein. The block interpolation results reflect the grades of the mineralisation intersected in the drill holes. The QP does not see material change which could affect the existing verified estimates and endorses the block model data as current.

### 12.3. QAQC verification

*This sub-section is retrieved from the NI 43-101 Technical Report on Mineral Resource Estimation of the Pegmatite #5 Lithium-Tantalum Deposit completed by SGS Canada – Geostat, and written by G. Desharnais, Ph.D., P.Geo, J.-P. Paiement, M.Sc., P.Geo, and J. Gagné, Eng., for Nemaska Lithium Inc. (2014). It comments the database used for the resource estimation of 2014. Additional information regarding the verification of the data collected in 2018 and 2022 are presented afterwards.*

The database received by SGS Geostat contained assay results for 1,747 samples. Added to the total assays, there are 60 standards (3.4 % of the samples), 79 duplicates (4.5 % of the samples) and 78 blanks (4.5 % of the samples).

Validation was conducted for the two different Li standard material used during the sampling program: 1) low lithium grade standard (Li-LG) and high lithium grade standard (Li-HG). The low grade standard has an expected value of 0.46 % Li and the mean values of all the assayed Li-LG samples is 0.46 % Li. On the 21 assay results for Li-LG, 9 results are higher than the expected value compared to 12 results lower than the expected value (Figure 28). The high grade standard has an expected value of 0.78 % Li and the assayed values returned an average mean result of 0.76 % Li, in which 38 of the 39 assay values returned values higher than the expected value (Figure 28). This could be problematic, but for the moment it is still under the 10 % difference mark. Only 1 sample (L941025) shows a problematic assay value, but has been identified by Nemaska as a labelling mistake (Figure 28).

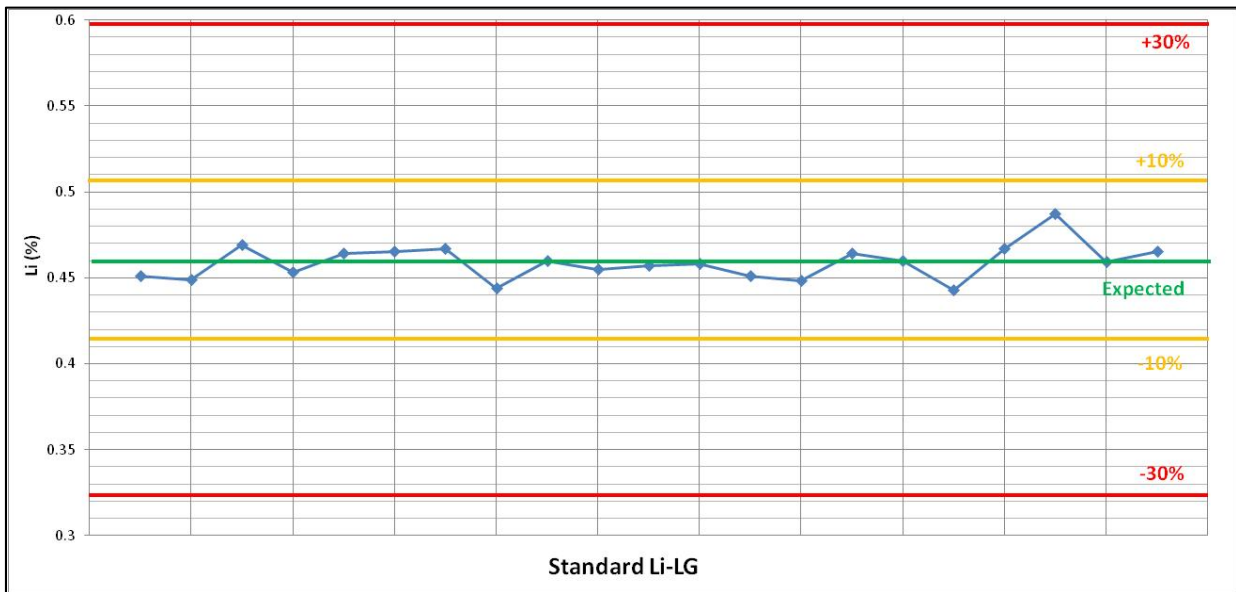
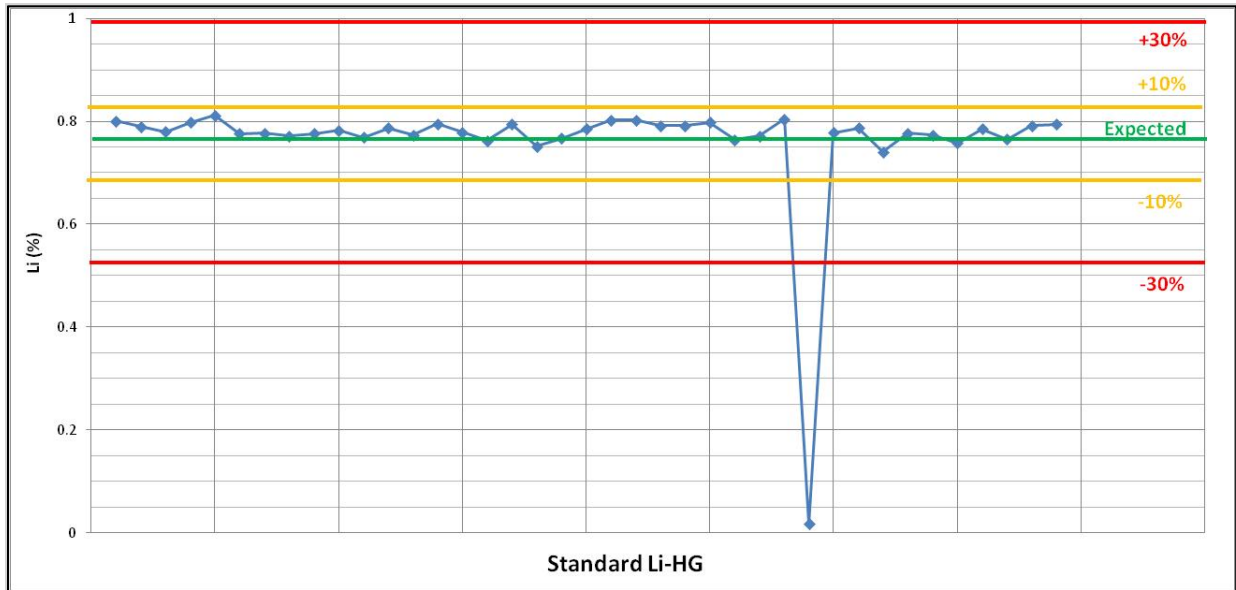
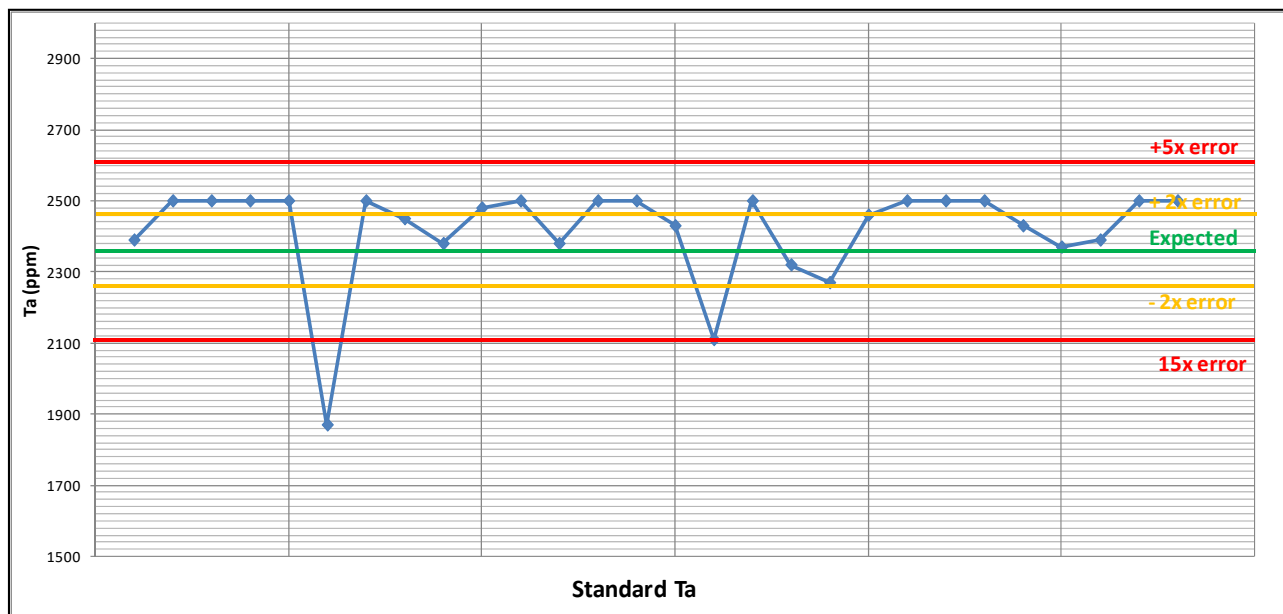

Figure 28 – Analytical results for Li standard material (Desharnais *et al.*, 2014).

For the Ta standard, the exercise was only possible on the high grade Ta standard from CCRMP-CANMET because it is the only one that has a reported value for Ta. The standard has an expected value of 2360 ppm Ta and the mean value of all the assayed Ta samples is 2419 ppm Ta. On the 28 assay results for this given standard, 24 results are higher than the expected value (Figure 29). There seems to be a bias with the assay values systematically higher than the given value for this standard, but most of the results still plot inside the 5x error critical limit (5x 50ppm) given by CCRMP-CANMET. Only two critical errors were spotted on the standard assays for samples L941625 and L940475.



**Figure 29 – Analytical results for Ta standard material (Desharnais *et al.*, 2014).**

Duplicate core samples were taken of 4.5 % of the samples. The average value of the original samples is 0.28 % Li and the average value of the duplicate samples is 0.30 % Li. Using the sign test, no systematic bias were found (result = 0.58 with an acceptability range of 0.39 to 0.61). The average difference (%) mean between original and duplicate values is 43.00 % (Figure 30) for Li analysis. The Ta duplicate taken from the re-assaying of the pulps also accounts for 4.5% of the total sample quantity (n=1258). The average for the initial analysis is 44.17ppm Ta and the average value of the duplicates is 45.19ppm Ta. No systematic errors were found in this series of duplicate samples using the sign test. The mean % of difference between the original and duplicate value is 2.34% (Figure 30).

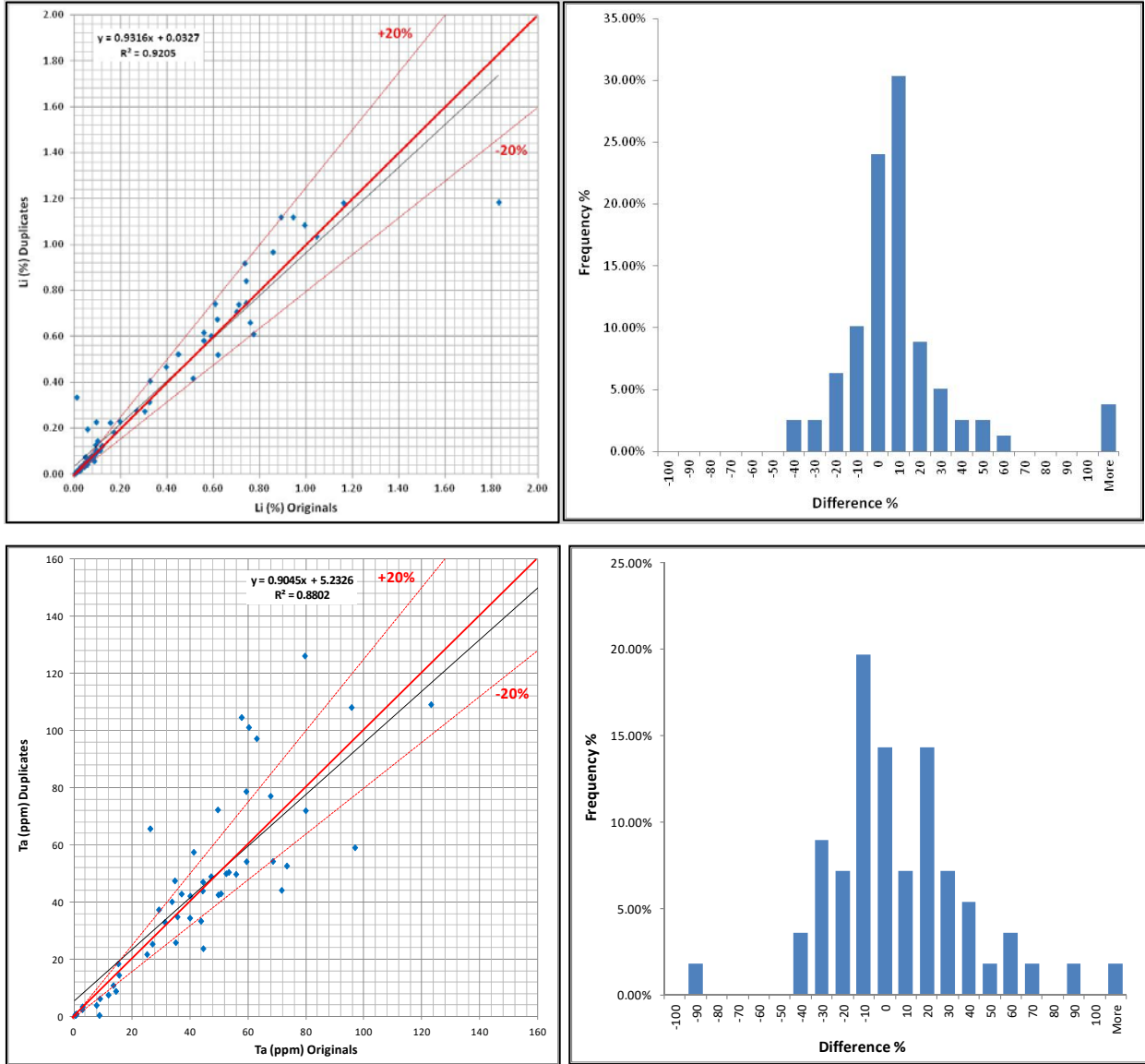

Figure 30: Analytical results for Li and Ta duplicates (Desharnais *et al.*, 2014).

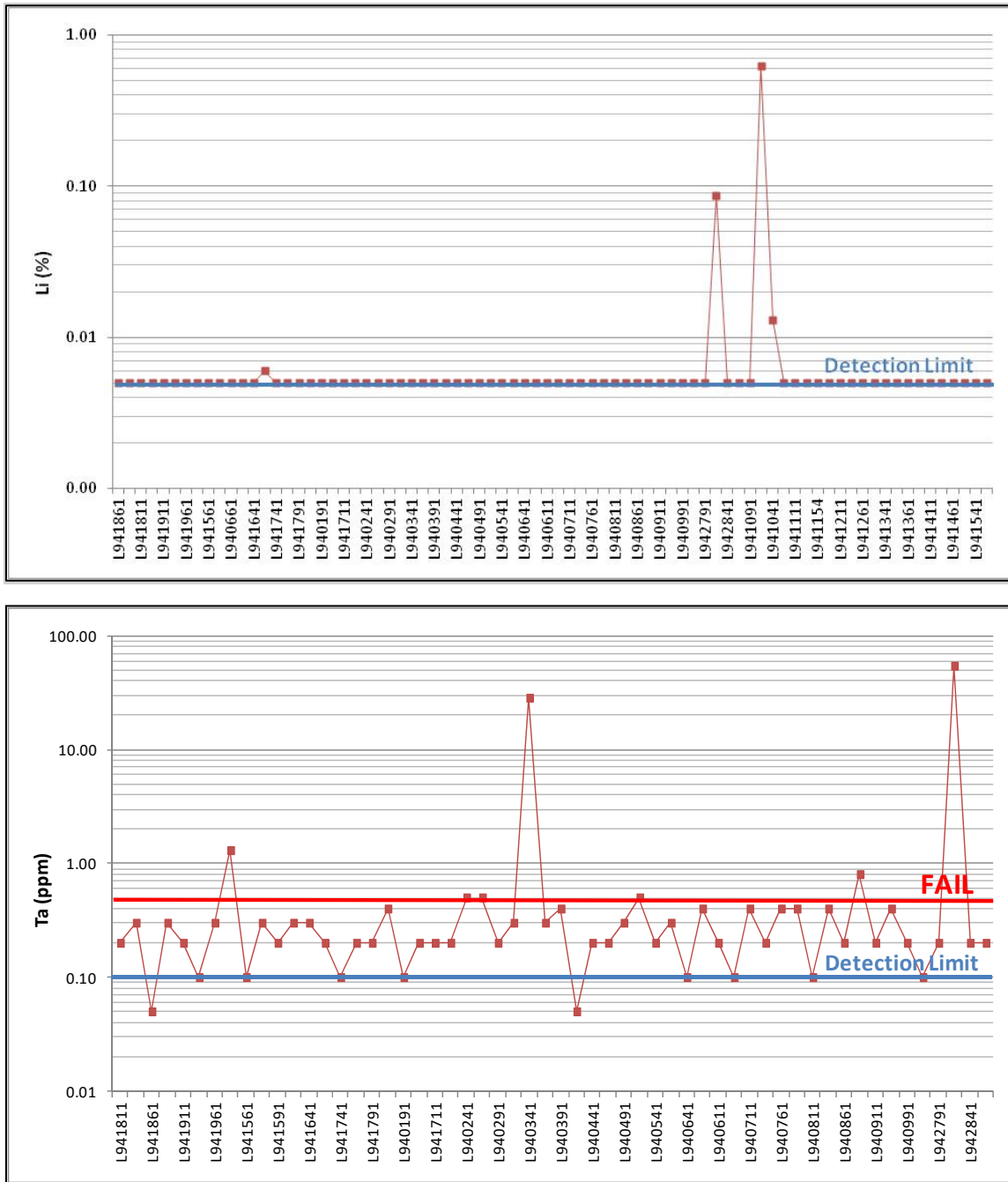

Figure 31: Blank analytical results (Desharnais et al., 2014).

Blank samples, corresponding to waste material, were inserted in the sampling procedure. The mean value of the assay results for the blanks is 0.01 % Li, which is 2 times higher than the laboratory detection limit set at 0.005% Li. This is not significant because mineralized material has a mean value of 1.26 % Li, which is 126 times higher. Only 4 samples on 78 ran an assay value higher than the detection limit: L941661, L942811, L941011 and L941041. Ta mean value for the blank material is 0.23ppm when not taking in account the 2 critical errors found in this population (L942811 at 54ppm and L940341 at 28.3ppm).

#### **12.4. Independent Control Sampling (by Desharnais *et al.*, 2014)**

During the site visit (2013), 31 independent control samples were taken by the authors. The samples were sent to SGS Lakefield Laboratory to be assayed for comparison of the Li % and Li<sub>2</sub>O % results. The samples taken were the remaining witness ½ cores from the exploration sampling program and a tag was left in the boxes where the samples were taken.

In the taken samples, one of them was a duplicate from Nemaska and one duplicate was also made by SGS Geostat, hence the sample check data has 33 entries. The mean of the original assay values is 0.68 % Li and the mean of the check assay results is 0.69 % Li (Table 5). The sign test did not show any systematic bias in the assays (result = 0.45 with acceptability range of 0.33 to 0.67). Furthermore, 45 % of the samples return a value lower than the originals and 55 % of the samples return a value higher than the originals. The mean difference (%) between the two sets of data is -10 % (Figure 32).



**Table 5: Summary of the statistics of the control sampling program (Desharnais *et al.*, 2014)**

ELEMENT	COUNT	Original > Duplicate		Original ≤ Duplicate	
		Count	%	Count	%
Li (%)	33	15	45%	18	55%

Data Set	Mean	Minimum	Maximum	Mode	Stand. Error
Nemaska	0.68	0.06	1.81	0.94	0.08
SGS	0.69	0.04	1.84	0.24	0.08

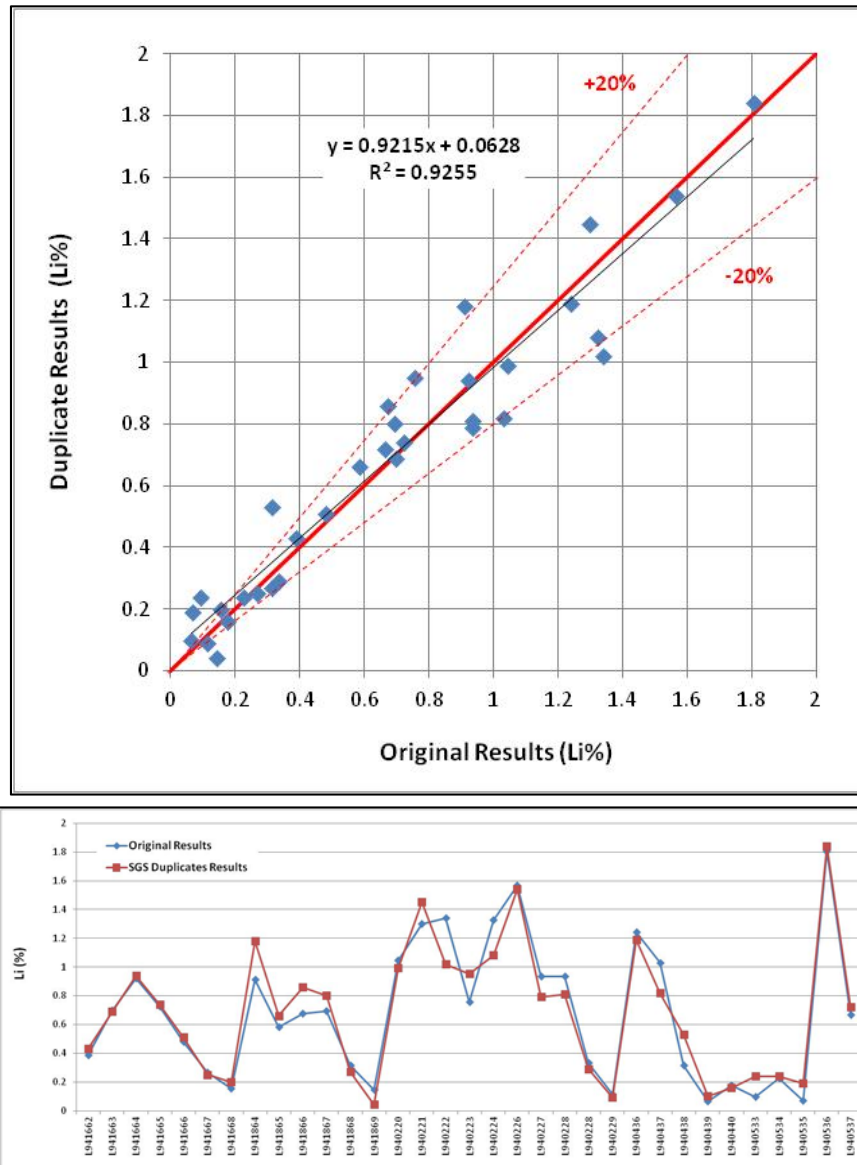

Figure 32: Comparison between Original assay values and Check sampling values (Desharnais *et al.*, 2014).

### 12.5. Independent Verification Sampling of 2022

The geological data was collected and verified by Mr. Claude Duplessis P.Eng. and work was conducted under his supervision. The authors reviewed the work and measures taken and those were considered adequate by the industry standards.

The latest exploration program of 2022 was established for a better understanding of the extension of the pegmatites. The independent sampling was performed in two parts. At first, Mr. Duplessis and his team

took four (4) channel samples during their site visit at the end of October 2022. These samples are duplicates of channels cut in 2012 and they were sent to ALS Laboratory in Val-d’Or from GMG’s office in Quebec on November 11<sup>th</sup>.

On November 9<sup>th</sup>, GMG’s engineer Maude Marquis collected independent samples of holes SIR-22-12 and SIR-22-21 during a visit of the MNG Services Inc.’s installations in Val-d’Or. The remaining core samples of the 2022 campaign were previously split into quarters (¼) by MNG’s employee using a pneumatic core saw. A total of five (5) samples, were packed and brought back to ALS Laboratory in Val-d’Or by Ms Marquis.

In total, nine (9) independent samples were taken from both channels (2012) and drillholes (2022). At ALS, twelve (12) elements were analyzed by the laboratory; a package for ore grade lithium (ME-ICP82b), and a second package by lithium borate fusion and ICP-MS finish for Ce, La, Nb, Rb, Sn, Sr, Ta, Th, U, W, Y, and Zr (ME-MS85).

Table 6 presents the assay results from the ALS Laboratory of Val-d’Or for samples submitted by Vision Lithium and independent samples submitted by GoldMinds in 2022. Figure 33, presents the variation of the assay results between the two applicants for Lithium (%) and Tantalum (ppm).

**Table 6: Assays from the original sampling and independent resampling of channels and drillholes at Sirmac Property.**

Hole Name	From	To	Length	V. Lithium's sample #	GMG's sample #	Li	Li*		Li2O	Li2O	Ta2O5	Ta	Ta*
			(m)			(%)	(%)		(%)	(%)	(ppm)	(ppm)	(ppm)
SIR-22-12	67.4	67.9	0.5	F552191	A0431735	0.3580	0.7260	0.3680	0.77	1.57	88.65	72.6	68.3
SIR-22-12	67.9	68.5	0.6	F552192	A0431736	1.7850	1.9060	0.1210	3.84	4.12	15.39	12.6	7.0
SIR-22-12	68.5	69.1	0.6	F552194	A0431737	1.6300	1.2160	0.4140	3.51	2.63	7.08	5.8	4.2
SIR-22-21	24	25	1	F552293	A0431733	0.0450	0.0390	0.0060	0.10	0.08	68.02	55.7	50.1
SIR-22-21	25	26	1	F552294	A0431734	0.1530	0.0350	0.1180	0.33	0.08	57.64	47.2	40.1
SIR-12-R17	3.5	5	1.5	L941363	21887	0.3650	0.1850	0.1800	0.79	0.40	-	-	
SIR-12-R17	5	6.5		L941364	21888	0.6830	0.6430	0.0400	1.47	1.39	-	-	
SIR-12-R07	13.5	15	1.5	L941193	21889	0.8530	0.8570	0.0040	1.84	1.85	-	-	
SIR-12-R07	12	13.5	1.5	L941192	21890	1.0200	0.7500	0.2700	2.20	1.62	-	-	

\*results associated with GMG’s independent sampling

The 2022 independent sampling program includes 9 samples, 5 are core samples from diamond drillholes of the campaign of 2022 and 4 are duplicates of channels sampling initially executed in 2012. The mean of

the original assay values is 0.77 % Li and the mean of the independent results is 0.71 % Li (Table 7). Out of the 9 samples, 67 % of the samples return a value lower than the originals and 33 % of the samples return a value higher than the originals.

**Table 7: Summary of the statistics of the control sampling program of 2022**

Element	Count	Original > Independent sample		Original </= Independent sample	
		Count	%	Count	%
Li %	9	6	67	3	33

Data Set	Mean value	Minimum	Maximum	Stand. Deviation
Vision Lithium	0.77	0.05	1.79	0.62
GoldMinds	0.71	0.04	1.91	0.60

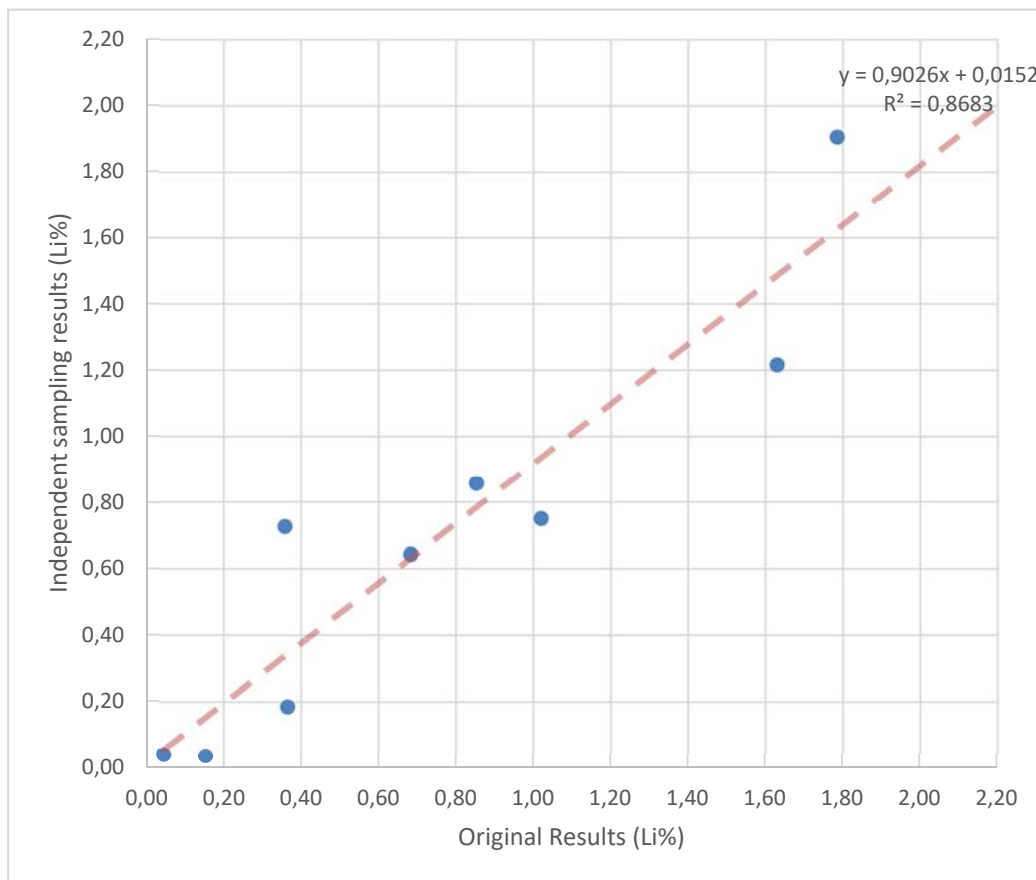

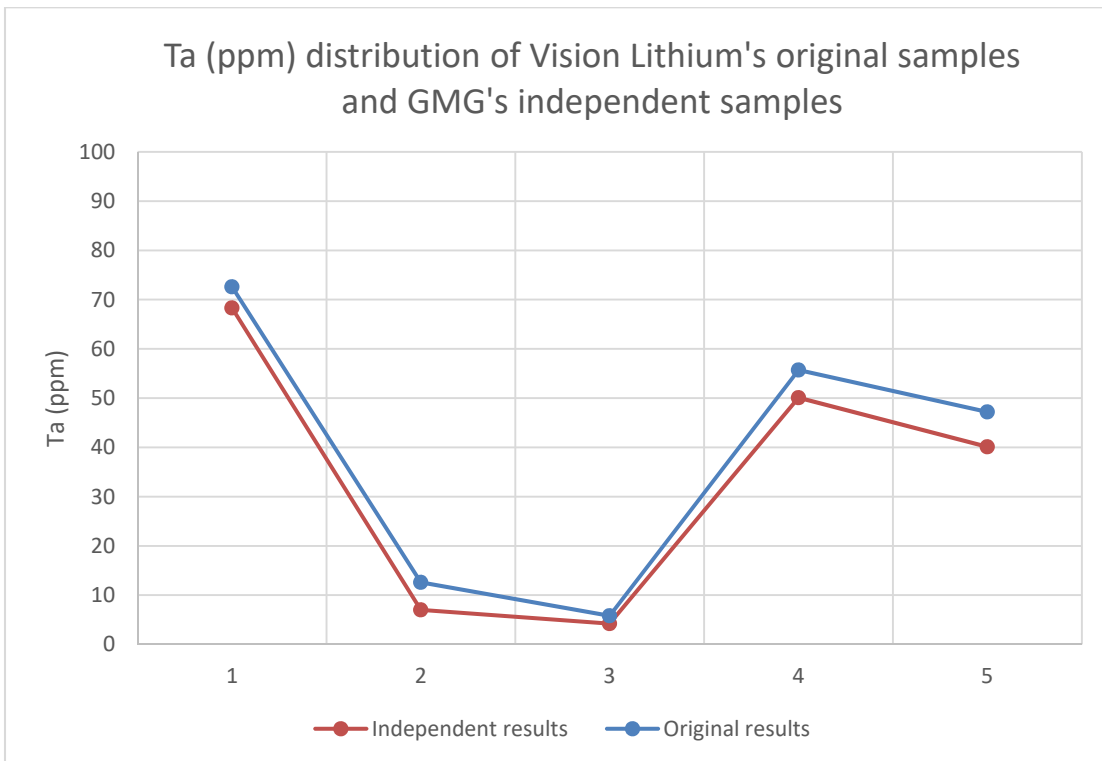
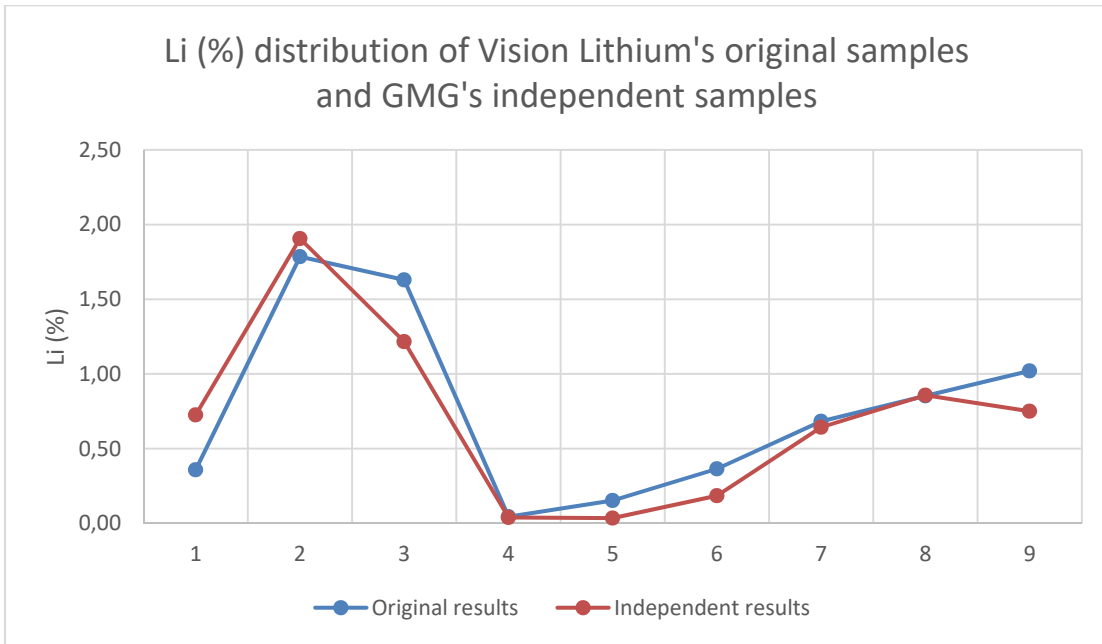
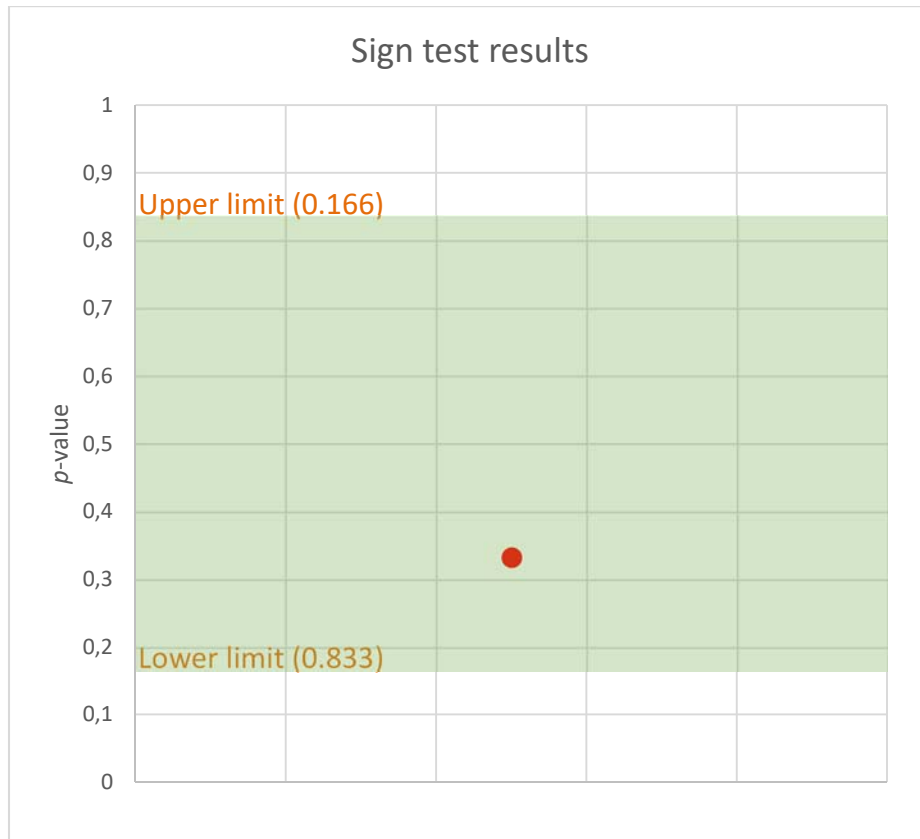

Figure 33 – ALS's assays distribution of Li (%) and Ta (ppm) for Vision Lithium and GMG's samples.

The sign test (t-test for non-parametric independent population) has been used to test the null hypothesis ( $H_0$ ): the assays from ALS Lab performed in 2022 on Vision Lithium’s samples aren’t significantly different from the assays requested by the authors, hence there is no significant difference between the two value sets. The alternative hypothesis ( $H_1$ ), if proven, states that there is a difference between the two value sets. Meaning that the control sample results differ from the initial results.



**Figure 34 – The  $p$ -value distribution of ALS sets of values (Li).**

As shown in Figure 34, the  $p$ -value of the test is 0.33; number set in between the limits of 0.16 to 0.83. In conclusion, there is no significant bias between the results of the two laboratories and the small differences are not considered representative.

### 12.5.1. Security

Quality assurance and quality control programs are typically set in place to ensure the reliability and faithfulness of the exploration data. Analytical control measures typically involve internal and external laboratory control measures implemented to continuously monitor the precision and accuracy of the

sampling, preparation, and analysis. They are also important to prevent sample mix-up and to monitor the voluntary or inadvertent contamination of samples.

The authors did not visit ALS Laboratory in Val-d'Or, however, it has a good reputation, assays are controlled with our QA/QC and the work has been done professionally. On their side, ALS developed their own quality system & laboratory information management system (LIMS) and all operations are monitored to ensure precision, accuracy in the results and reliability of the information they are providing. Their geochemistry sites operate under a Global Quality Manual that, according to ALS, complies with the requirements of the ISO/IEC 17025: 2025 *General Requirements for the Competence of Testing and Calibration Laboratories* for his in-house methods. Furthermore, the laboratory is independent of Vision Lithium Inc. and GoldMinds Geoservices Inc. The authors believe that the sampling preparation, security, and analytical procedures are consistent with generally accepted industry best practices.

The authors believe that the sample preparation, security, and analytical procedures were adequate and well suited for the purpose of this Technical Report.

#### **12.6. Data Quality Conclusion – Author's opinion on the adequacy of the data**

In light of the data received from GMG's independent sampling by ALS Laboratory, Mr. Duplessis is of the opinion that the 2022 data collected and transmitted by Vision Lithium are reliable. No biases were identified in the assaying process; standards, duplicates, blanks and independent control samples all show acceptable variations. Thereby, the adequacy of the database is confirmed for the purpose of this Technical Report.

## 13 MINERAL PROCESSING AND METALLURGICAL TESTING

### 13.1. 2013 – Report from SGS Mineral Services Lakefield

In February 2012, Nemaska Lithium Inc requested a bench scale testing program on a Sirmac deposit sample. The main objectives of this testwork program were initially identified as:

To produce a premium ceramic grade spodumene concentrate  $>7.2\%$   $\text{Li}_2\text{O}$  with  $\text{Fe}_2\text{O}_3 <0.1\%$ ,

To produce a concentrate grading  $>6.4\%$   $\text{Li}_2\text{O}$  with  $\text{Fe}_2\text{O}_3 <0.2\%$  and

To produce glass grade concentrate  $>4.8\%$   $\text{Li}_2\text{O}$  with  $\text{Fe}_2\text{O}_3 <0.15\%$ .

If none of these was achievable, the objective of the project would be shifted toward producing lithium concentrate for lithium extraction. It was also desired to recover Nb/Ta minerals and triphylite (a rare lithium phosphate mineral).

One outcrop sample and two drill core samples were tested. Mineralogical analysis conducted on the outcrop sample revealed that the material consisted mainly of albite (31.0%), quartz (23.8%), spodumene, (20.8%), microcline (17.9%), muscovite (4.5%), and biotite (1.1%). Through the initial chemical and XRD analyses, triphylite was not detected in the sample. Through microprobe analysis and direct analysis on some spodumene grains, it was found that the iron content of spodumene grains was about 0.4%  $\text{Fe}_2\text{O}_3$  or higher. Thus, based on the iron analyses, it was concluded that none of the above objectives can be met due to the high iron content of spodumene in spodumene crystal structure as solid solution. Achieving high grade concentrate (7.0%  $\text{Li}_2\text{O}$  or higher) was possible through this testwork on all samples.

#### 13.1.1. Mineralogical Analysis

A subsample from the head outcrop composite was submitted for XRD determination and the semiquantitative head composition. Roughly 20.8% of the outcrop sample was composed of spodumene. The following conclusions can be made from XRD analysis:

The sole Li mineral identified was spodumene. There was no petalite identified in the samples. If petalite is present, it would be in trace quantities.



The sample consisted of major amounts of albite (31.0 %), quartz (23.8 %), microcline (17.9 %), spodumene (20.8 %) and muscovite (4.5 %).

As expected, triphylite in this sample was not detected.

Through the initial chemical and XRD analyses, triphylite was not detected in the sample. Through microprobe analysis and direct analysis on some spodumene grains, it was found that the iron content of spodumene grains was about 0.4 % Fe<sub>2</sub>O<sub>3</sub> or higher. Thus, based on the iron analyses, it was concluded that none of the above objectives can be met due to the high iron content of spodumene in spodumene crystal structure as solid solution. Achieving high grade concentrate (7.0 % Li<sub>2</sub>O or higher) was possible through this testwork on all samples.

### 13.1.2. Bond Mill Work Index

The outcrop sample was submitted for Bond rod mill work index (RWI) determination as per the standard procedure using a product D100 size of -1180 µm. A Bond rod mill work index (RWI) of 11.0 kWh/t (metric) was obtained for this sample. The results are compared to the SGS database in Figure 39. The sample is characterized as soft in RWI terms with a percentile of 16 %.

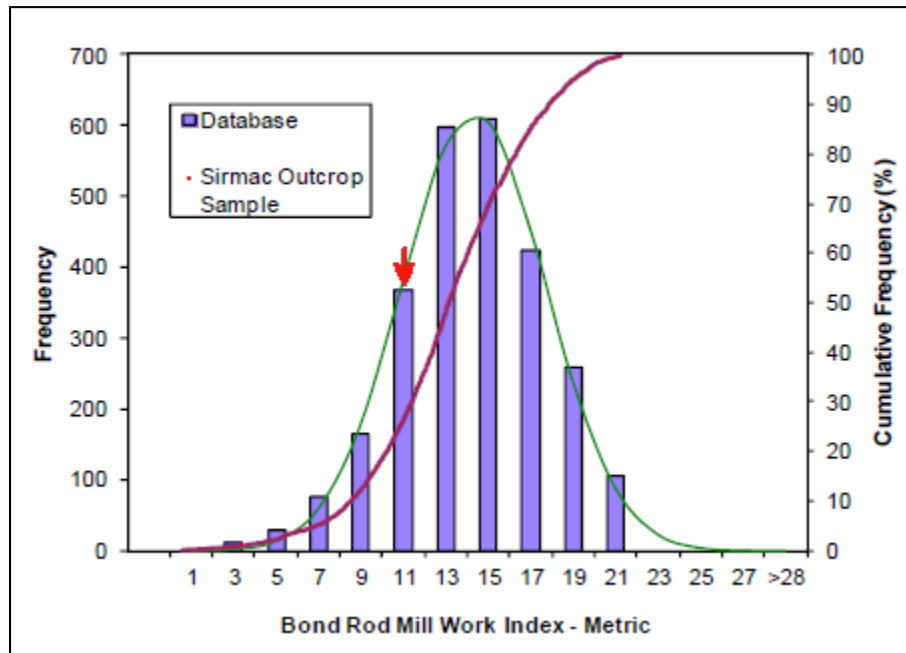
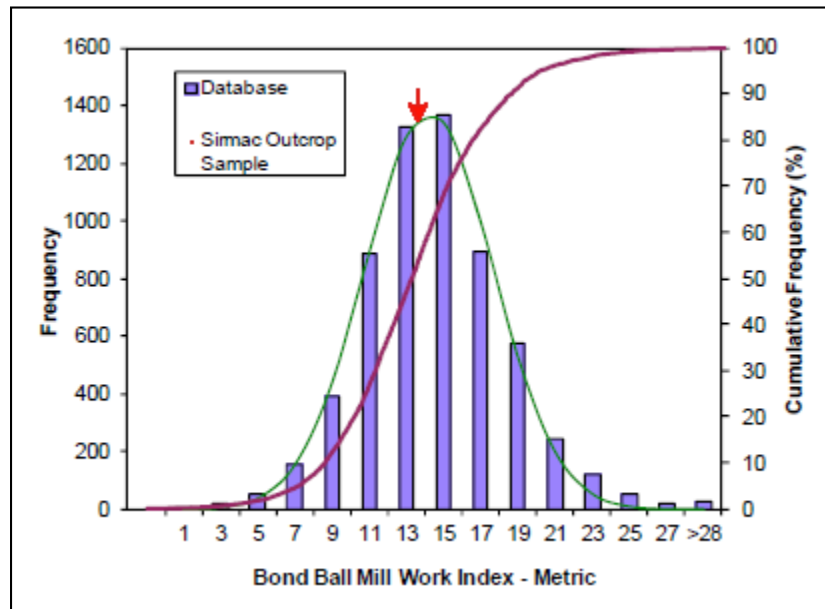

Figure 35: Outcrop composite Bond Rod Mill Work Index comparison to SGS Database

A sample from the outcrop composite was submitted for Bond ball mill work index (BWI) determination as per the standard procedure using a product D100 size of -300 µm. A ball mill work index (BWI) of 13.6 kWh/t (metric) was obtained for the head composite. Results are compared to the SGS database in Figure 36. The sample was found to be of medium hardness with a percentile of 42 %.



**Figure 36: Outcrop composite Bond Ball Mill Work Index comparison to SGS Database**

### 13.1.3. Heavy Liquid Separation Test Results

The optimum results in the heavy liquid tests were obtained after crushing the head sample to -1/4" to produce a lithium concentrate with a grade of 6.33 % Li<sub>2</sub>O and a lithium recovery of 73.1 %. The lowest Li recovery, 68.1 %, was achieved after primary crushing to -1/2". This is most likely due to the lower spodumene liberation from silicate gangue in this case in comparison to finer crushing size in the other tests. On the other hand, crushing to -6 mesh did not provide the maximum lithium recovery due to the generation of larger amounts of undersize (-0.5 mm) fraction, which cannot be processed in the DMS operation. In the first two tests, lithium recovery can be further improved by re-crushing the middling product (float product with SG cut point of 2.90) may be further improved.

The results clearly indicate that achieving high grade concentrates, >6 % Li<sub>2</sub>O, with good Li recovery, about 60-70 %, by using DMS is most likely possible. This remains, however, to be investigated through a DMS pilot plant.

Other heavy liquid tests were conducted on drill cores SR/12-49 and SR/12-01. The test flowsheet is shown in Figure 37. The primary separation was conducted on -1/4" charges with two heavy liquids to reject silicate gangue into a float product at an SG cup point of 2.70 g/cm<sup>3</sup> and to generate a primary lithium concentrate into a sink product at an SG cup point of 2.95 g/cm<sup>3</sup>. The middling product, float 2.95 g/cm<sup>3</sup>, was further crushed to -6 mesh. The crushed material was then passed through a second set of heavy liquids with the same SG as in the primary circuit. The objective was to identify if finer crushing would significantly increase deportment of lithium to the spodumene concentrate. The following conclusions were made from these results:

- Total mass rejects as a silicate gangue were 46.2 % with a lithium loss of 1.95 % for drill core 12-01 and 58.2 % with lithium loss of 3.64 % for drill core 12-49;
- It was possible to produce acceptable spodumene concentrates (combined 1<sup>st</sup> and 2<sup>nd</sup> pass) with grades of 6.08 % and 6.36 % Li<sub>2</sub>O and lithium recoveries of 75.2 % and 73.0 % from drill core 12-01 and 12-49, respectively.
- The increase in lithium recovery after secondary crushing was 2.67 % for drill core 12-01 and 6.45 % for drill core 12-49
- The middling float product from the 2<sup>nd</sup> pass and the undersize fraction from both passes (-0.5 mm fraction) are to be combined and further processed by flotation. These flotation feeds from drill core 12-01 and 12-49 contained about 22.8 % and 23.4 % of the lithium at a lithium grade of 1.76 % Li<sub>2</sub>O and 1.41 % Li<sub>2</sub>O in 27.6 % and 24.7 % of the global feed mass, respectively.

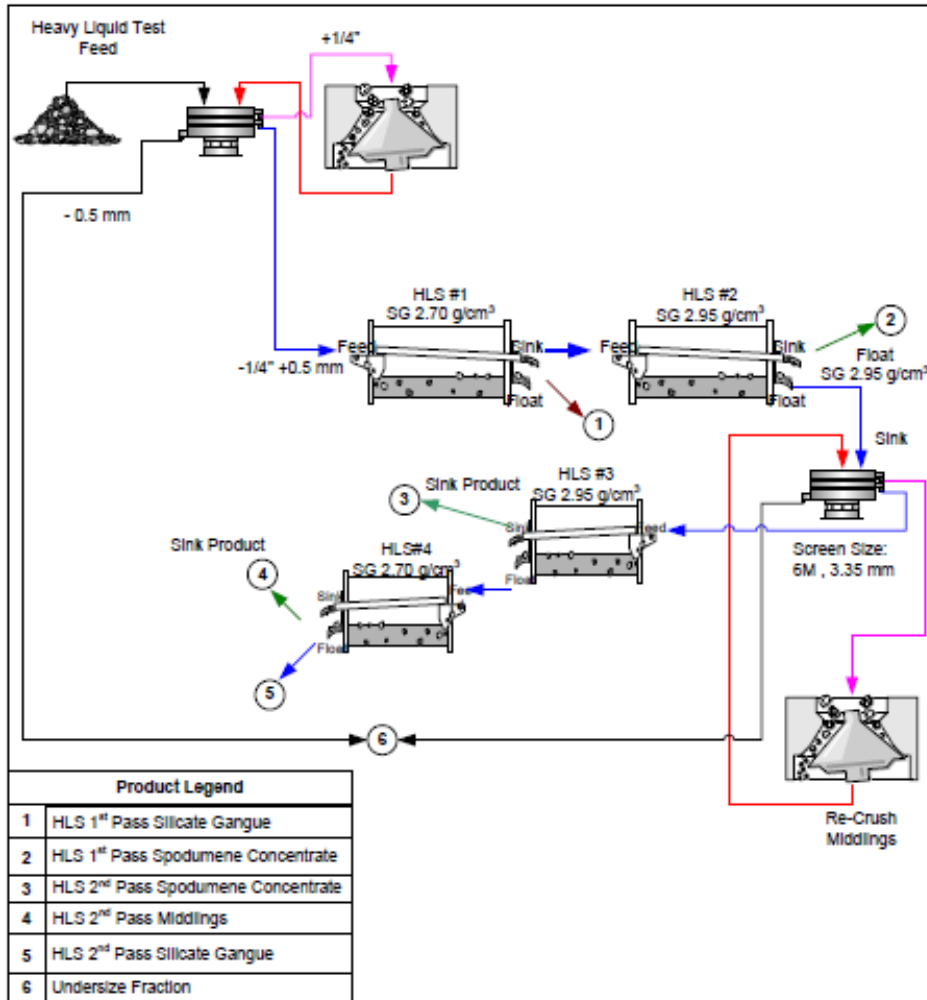

Figure 37: HLS test flowsheet performed on the drill cores

#### 13.1.4. Preliminary Spodumene Flotation Flowsheet

A preliminary flotation flowsheet has been developed and presented in Figure 37. In this flowsheet, DMS is used to produce coarse spodumene concentrate. The middling from the coarse 1<sup>st</sup> pass (-1/4") is to be further crushed to 6 mesh and repassed through DMS to separate liberated spodumene. Flotation is conducted on the undersize fraction of the DMS circuit and the DMS middling product after grinding to a K<sub>80</sub> of about 200 µm. The ground material is dewatered before entering the scrubber. The pulp density in the scrubber should ideally be 50 % to 60 %. The flotation feed is scrubbed for 10 minutes at pH 11 adjusted with NaOH and in the presence of D618 at 250 g/t. After desliming, the flotation feed is conditioned at 60% pulp density with FA-2 collector for 5 minutes. Collector dosage is 700 g/t. Pulp pH (8.5) in the conditioner is to be adjusted with soda ash. Rougher flotation is fairly fast and it is expected to be completed within 3

minutes. Two cleaners are expected to be sufficient in order to generate the target concentrate grade (>6.0 Li<sub>2</sub>O). The 1<sup>st</sup> cleaner tails might be rejected to the final tailings (if the grade is low and similar to test F8) or return to the dewatering cyclone. The final spodumene concentrate is washed with sulfuric acid to break the froth and improve magnetic separation efficiency. A magnetic intensity of about 15000 Gauss should be sufficient.

### **13.1.5. Mineral Processing Conclusions**

The following conclusions are drawn from this project:

The sole Li mineral identified was spodumene according to XRD analysis performed on the outcrop sample. The outcrop sample consisted of major amounts of albite (31 %), quartz (23.8 %), spodumene (20.3 %), microcline (17.9 %), muscovite (4.5 %) and biotite (1.1 %). Triphylite has not been detected in the outcrop sample. There is, however, a possibility that either triphylite or apatite exist in the sample in a minor amount.

Microprobe analysis indicates that on average FeO content of spodumene was about 0.34 %. The remaining other impurities of the spodumene grains were MnO at 0.11 % and Na<sub>2</sub>O at 0.1 %. The iron content of the spodumene grains was higher than the acceptable limits in the ceramic industry.

A Bond rod mill work index (RWI) of 11.0 kWh/t (metric) was obtained for the outcrop sample. A ball mill work index (BWI) of 13.6 kWh/t (metric) was obtained for the outcrop sample at a D<sub>100</sub> of -300 µm.

Heavy liquid test results from outcrop and drill core samples were positive. From these tests, it was concluded that DMS would be a viable option to produce a high grade concentrate (>6 %) with expected Li recovery of above 60 % if the sample provided is representative of the deposit. DMS feed size should be - ¼” and the middling product should be crushed to 6 mesh and repassed to improve lithium recovery. It is expected to reject about 50 % of the original mass as silicate gangue with a lithium loss of less than 5 %. About 25 % of the mass with a Li<sub>2</sub>O grade slightly lower than the head grade, composed of undersize fractions and middling product, could go to the flotation plant for further lithium recovery.

Stage-grinding with a closing size of 48 mesh (300 µm) was sufficient to optimize the flotation performance.

Mica pre-flotation was not necessary according to the flotation test results obtained from the drill core samples. If mica flotation is to be conducted on future tests, Armac T and Aero 3030C are most likely the preferred choices.

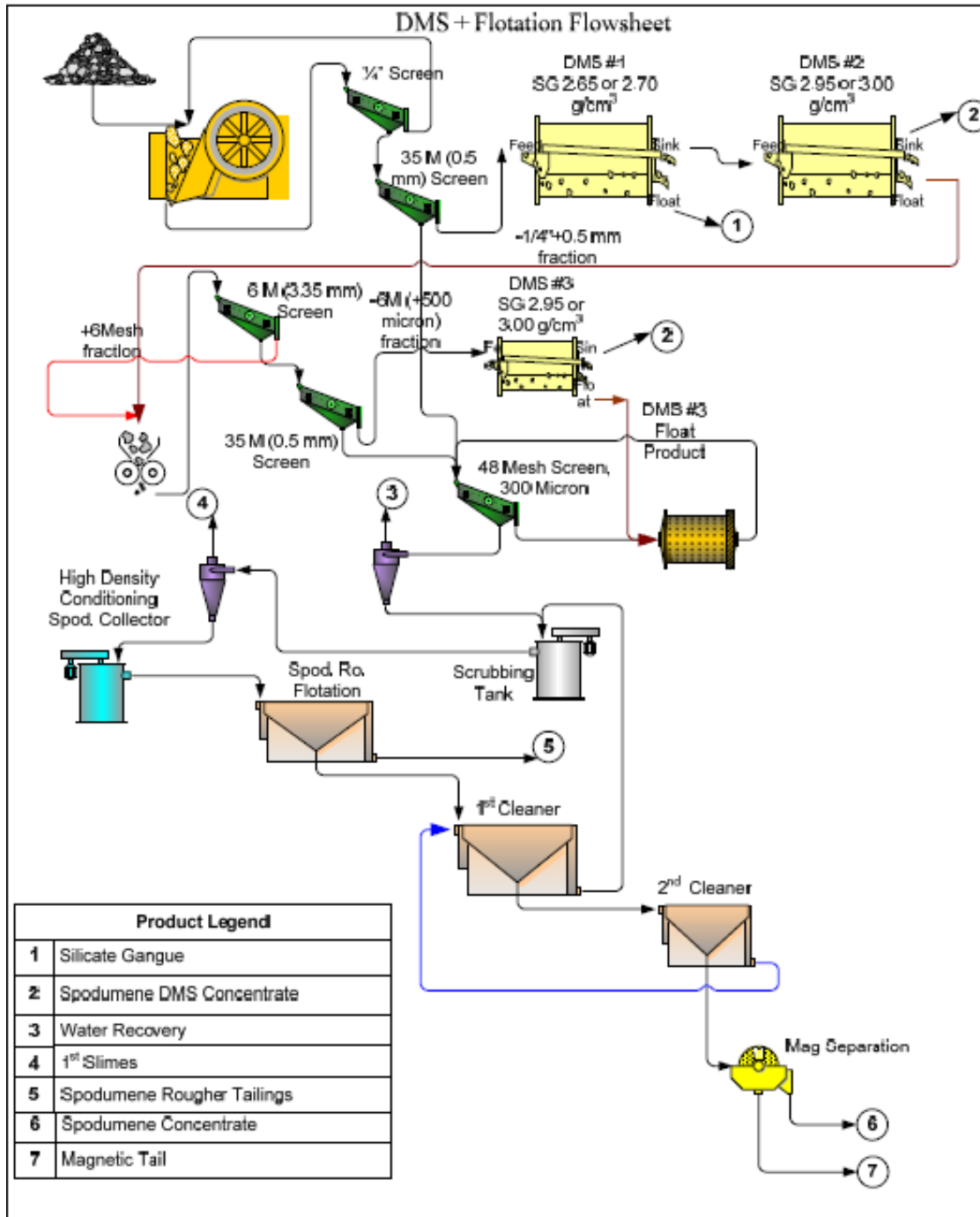

**Figure 38: Preliminary flowsheet**

Removal of slimes was completed after a scrubbing stage. Lignin sulfonate and NaOH additions in the scrubbing stage were beneficial in terms of slime dispersion and separation. Lignin sulfonate (D618) was added to the scrubber at 250 g/t and pH was adjusted to 11.0 with NaOH.

Soda ash was used as the pH regulator in spodumene flotation. Pulp pH was kept at around 8 during the rougher and cleaner flotation stages.

FA-2 was a suitable collector for spodumene flotation at a dosage of 700 g/t in the rougher flotation, and 50 g/t in the 1<sup>st</sup> cleaner. A hydroxamate collector, Aero 6493, which was also tested, provided good results on the outcrop sample. The cost of this collector, however, is significantly higher than FA-2. Thus, majority of the testwork was concentrated on the FA-2 collector.

Collectors Aero 704 and FS-2 also provided good results, but no better than the results achieved with FS-2.

A flotation concentrate grading 6.34 % Li<sub>2</sub>O at a lithium recovery of 92.4 % was achieved on the combined drill cores after one cleaner in batch flotation. About 0.8 % of the lithium reported to the slimes and 2.3 % to the rougher tailings. The grinding fineness (K80) of the rougher tailings was 202 µm.

#### ***13.1.6. Mineral Processing Recommendations***

Performing further HLS and flotation tests on a master composite papered from a large number of drill cores;

Performing variability HLS and flotation tests on drill core samples from different zones;

Performing further testwork to evaluate if mica flotation is necessary on the representative drill core composite sample;

Performing testwork on the undersize fraction (-0.5 mm) and HLS middling;

Studying the effect of in-situ mine water on flotation performance;

Performing rougher kinetics tests and locked cycle tests to evaluate the effect of recycling streams;

Performing a grinding variability program on samples with different head grades and from different locations in the ore body to identify the effect of lithium head grade and sample mineralogy on overall grindability and flotation performance;

DMS pilot scale testing to confirm the results from HLS tests.

### **13.2. 2019 – Report from SGS Mineral Services Lakefield**

Vision Lithium Inc. contacted SGS Mineral Services in May 2018 with a request for a flowsheet development study on the Sirmac Deposit, located in Quebec. Previous metallurgical work suggested that this deposit would be amenable to the production of high-grade spodumene concentrate by dense media separation (DMS).

The objectives of this program were to confirm the results of the previous testwork, to develop a preliminary flowsheet for lithium processing, to provide the expected mass balance for the integrated DMS + flotation operation, and to better understand the metallurgical variability in the deposit. Furthermore, it was desired to know the lithium extraction from both DMS concentrate as well as flotation concentrate.

Two outcrop samples and three variability samples from Sirmac Deposit were used for the testwork program.

#### ***13.2.1. Mineralogical Analysis***

Representative subsamples from each variability sample (Var 1, Var 2, and Var 3) were submitted for semi-quantitative XRD analysis.

Spodumene was the main lithium-bearing mineral detected in all three variability samples. Consistent with the assay results, Var 3 contained the highest amount of spodumene (33.7%) and Var 1 contained the lowest amount of spodumene (5.6%).

Var 2 and Var 3 contained similar mineral types, though with varied quantities of individual minerals: Var 2 had major amounts of quartz and albite, moderate amount of microcline, and minor to trace amounts of muscovite and magnesian calcite; Var 3 had a major amount of quartz, moderate amount of albite, and minor to trace amounts of microcline, muscovite, and calcite magnesian.

The major gangue minerals in Var 1 were similar to those in the other two samples, with major amounts of quartz and albite and minor amount of microcline. However, Var 1 contained moderate muscovite and minor to trace amounts of several other gangue minerals, such as biotite, pargasite (amphibole), fluorapatite, chamosite (chlorite) and magnetite. The complex mineralogy of Var 1, particularly the significant amount of mica and apatite present, may cause difficulty in flotation testing.



**13.2.2. Bond Ball Mill Work Index**

A Bond Ball Mill Grindability test was performed at 48 mesh of grind on a sample of the Main Composite Flotation Feed, which comprised products from the DMS test. The test results are summarized in Table 8, and compared to the SGS database in Figure 39. The sample was categorized as moderately soft, with a BWI of 12.8 kWh/t.

**Table 8: Bond Ball Mill Grindability Test Results (SGS, 2019)**

Sample Name	Mesh of Grind	F <sub>80</sub> (µm)	P <sub>80</sub> (µm)	Gram per Revolution	Work Index (kWh/t)	Hardness Percentile
Flot Feed	48	2,469	237	2.75	12.8	34

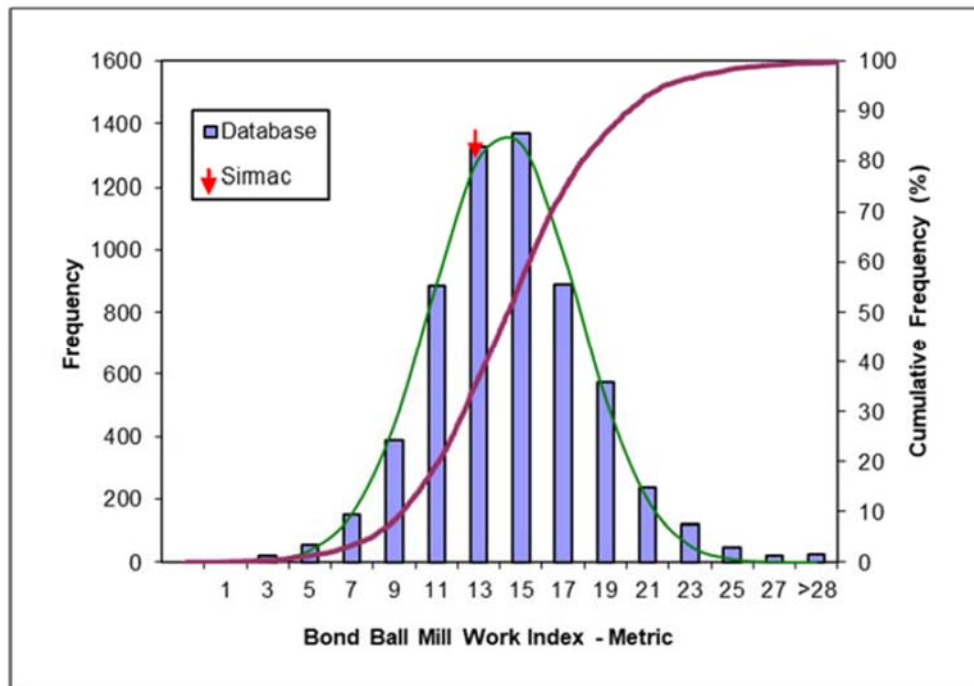

**Figure 39: BWI of the Main Composite Flotation Feed Compared to the SGS Database (SGS, 2019).**

**13.2.3. Dry Magnetic Separation Testing**

The low-grade sample (Var Sample 1) contained a significant quantity of iron silicate minerals, which were presumably present owing to the high amount of waste material in this sample. These iron silicate minerals

have a similar density to spodumene and are recovered by fatty acid collectors. Therefore, a large portion of these minerals normally report to the lithium concentrate and dilute the concentrate grade. It was decided to reject as much waste material in Variability Sample 1 as possible, by dry magnetic separation at a magnetic intensity of 10,000 Gauss.

Considering the stage performance of magnetic separation only in the combined -6.3 + 0.5 mm fraction, a significant proportion of the mass (28.9%) and lithium (21.3%) reported to the magnetic concentrate. This high lithium loss was presumably due mainly to spodumene entrainment. The iron content was reduced significantly, from 2.26% Fe<sub>2</sub>O<sub>3</sub> in the feed to the magnetic separator to 0.30% Fe<sub>2</sub>O<sub>3</sub> in the non-magnetic product.

#### **13.2.4. Heavy Liquid Separation (HLS) Testing**

Heavy liquid separation tests were conducted on the coarse fractions (-6.3 mm + 0.5 mm) of each of the three variability samples. On-spec (>6% Li<sub>2</sub>O) lithium concentrates were generated in each of these three tests. Lithium recovery to the on-spec concentrate was very high (77.5%) in the Var Sample 3 HLS test and high (53.6%) in the Var Sample 2 HLS test. As expected, lithium recovery was lowest (25.8%) in the concentrate generated in the Var Sample 1 HLS test, due to the low head grade (0.47% Li<sub>2</sub>O) and the large amount of waste in the sample. The waste likely contains iron silicate minerals which tend to report to the spodumene concentrate due to their high density and need to be rejected ahead of HLS or DMS.

#### **13.2.5. Dense Media Separation (DMS) Testing**

The DMS test was conducted on a ~180 kg sample of the Main Outcrop Composite. This sample was crushed to -6.3 mm and the fine fraction, -850 micron was screened out. A slightly coarser screen cut-size was selected for the DMS fines compared to HLS to prevent contamination of the media with fines, thereby improving screening efficiency.

The DMS concentrate recovered 31.8% of the lithium in 8.8% of the mass and graded 6.3% Li<sub>2</sub>O. The flotation feed generated in the DMS test, which comprised a blend of the DMS middlings and 850 µm screen undersize material, graded 1.92% Li<sub>2</sub>O and contained 64% of the feed lithium in 58% of the mass. The DMS tailings accounted for a loss of 4% of the lithium, which is slightly higher than the proportion of lithium reporting to the HLS test tailings, but still acceptably low. The lithium grades of both the Flotation Feed and the DMS tailings were similar to those observed in the corresponding products from the HLS test, while the mass and lithium distributions were higher.

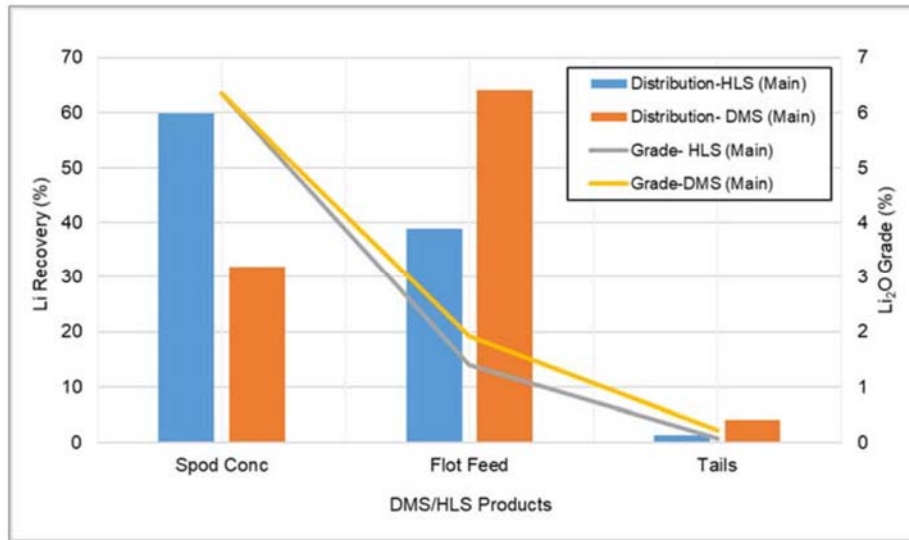

**Figure 40 – Comparison of Lithium Department in the HLS Test and the DMS Test (Main Composite).**

Three passes through the DMS were required to meet the target lithium grade, which was not predicted by the HLS results. It is expected that the presence of a large amount of near-density materials played a negative role during DMS operation, making DMS separation in the 2nd pass more challenging. Owing to the large amount of low-grade middling that mis-reported to the 2nd pass sinks, the lithium concentrate was diluted. Thus, a third DMS pass was required to basically act as a cleaner stage. Possibly for the same reason, the distribution of lithium in the DMS products did not exactly follow the distributions in the HLS tests. HLS tests produce a perfect separation by density that is not affected by the presence of near-density material. For this reason, the recovery of lithium from the Main Outcrop Composite into the DMS concentrate (~32%) was significantly lower than in the HLS concentrate (~60%).

### **13.2.6. Flotation Testing**

For the Main Outcrop Composite, the flotation feed was created by combining the DMS middlings and -850  $\mu\text{m}$  slimes fraction. For the variability samples, products generated in the HLS tests (HLS test middlings and -500  $\mu\text{m}$  fraction) were combined to create flotation feed samples.

Eight batch flotation tests were conducted. The flowsheet for the first test was based on the best practices for spodumene flotation developed from SGS' s previous work. Based on the test results, this flowsheet was then modified to incorporate successful variations.

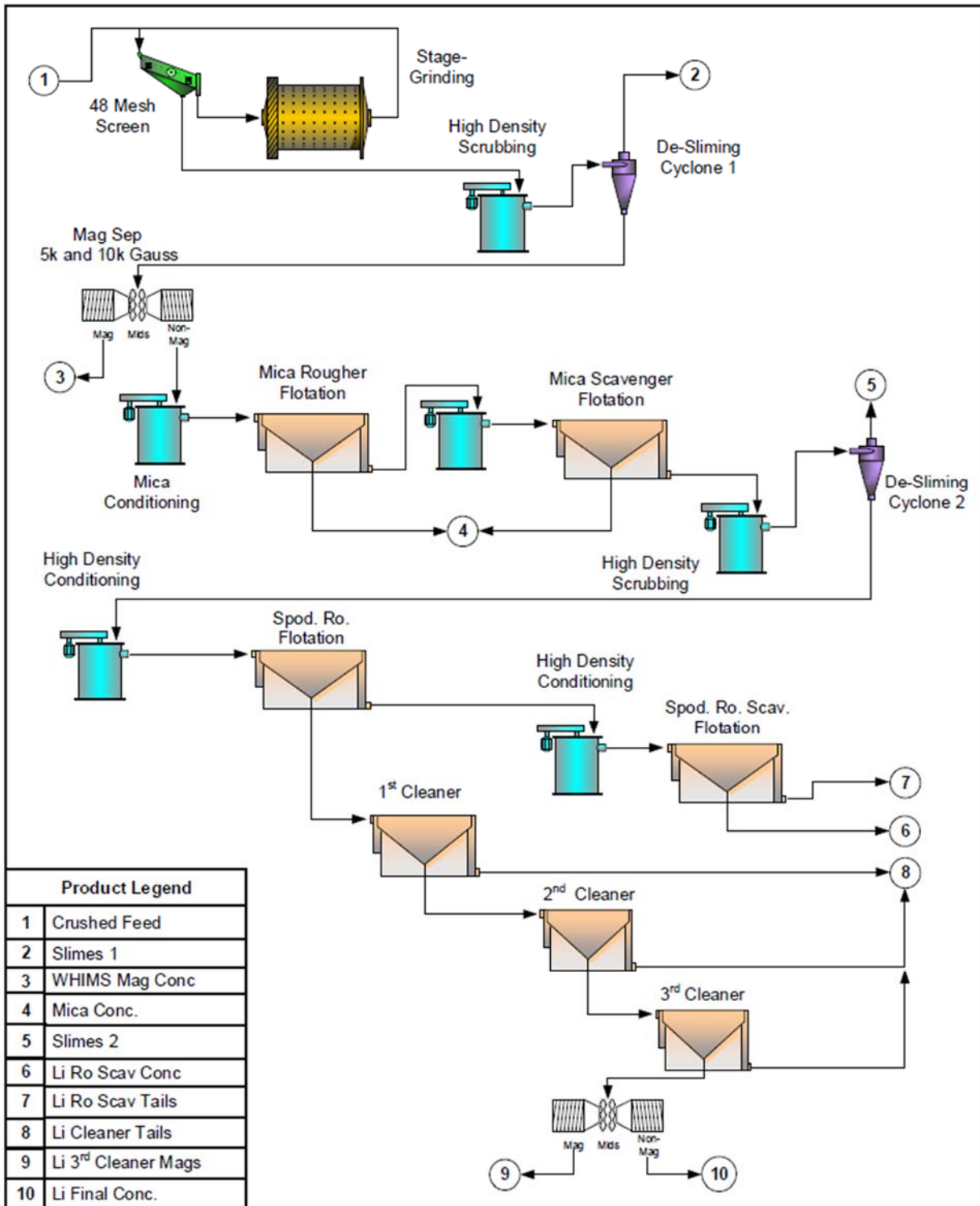

Figure 41 – Optimized Batch Flotation Test Flowsheet (SGS, 2019).

### **Tests on the Main Outcrop Composite Flotation Feed**

Tests F1 to F5 were conducted on charges of the stage-ground DMS Flotation Feed to test the performance of a variety of collectors, selected based on SGS' s experience on other similar projects.

All five flotation tests resulted in very good lithium recovery (> 80%), in concentrates grading >6% Li<sub>2</sub>O. F4 with low dosage of 7080E demonstrated the most promising lithium recovery (88.6%) and Li<sub>2</sub>O grade (6.30%) in the spodumene 2<sup>nd</sup> cleaner concentrate. The 3<sup>rd</sup> cleaner stage resulted in further concentrate upgrading to 6.52% Li<sub>2</sub>O with a slight decrease in lithium recovery to 87.5%.

### **Tests on Variability Sample Flotation Feed**

Tests F6, F7, and F8 evaluated the flotation performance of the three variability samples against that of the Main Outcrop Composite. Results are included in Table 11. The procedure used for the three variability tests was similar to that used in test F4. The flotation feeds for each composite were prepared by combining the HLS middlings and undersize fraction.

The spodumene flotation performance was fairly good, except for Var 1. However, the response of all the variability samples was inferior to that of the Main Outcrop Composite. The flotation concentrates from the tests on Var 2 (F7) and Var 3 (F8) both produced concentrates grading > 6% Li<sub>2</sub>O grade with high Li recovery (> 80%), while the lithium concentrate recovery and grade were both very low for Var 1 (test F6).

### **Locked-Cycle Flotation Test**

A single locked-cycle test (LCT) was conducted on a Flotation Feed sample from the Main Outcrop Composite (blend of the DMS Middlings and 850 µm screen undersize material). Charges for the locked cycle test were prepared by stage-grinding. Each cycle used a 2 kg charge and six cycles (A-F) were carried out. The basic conditions were based on test F4, and the LCT flowsheet is depicted in Figure 42.

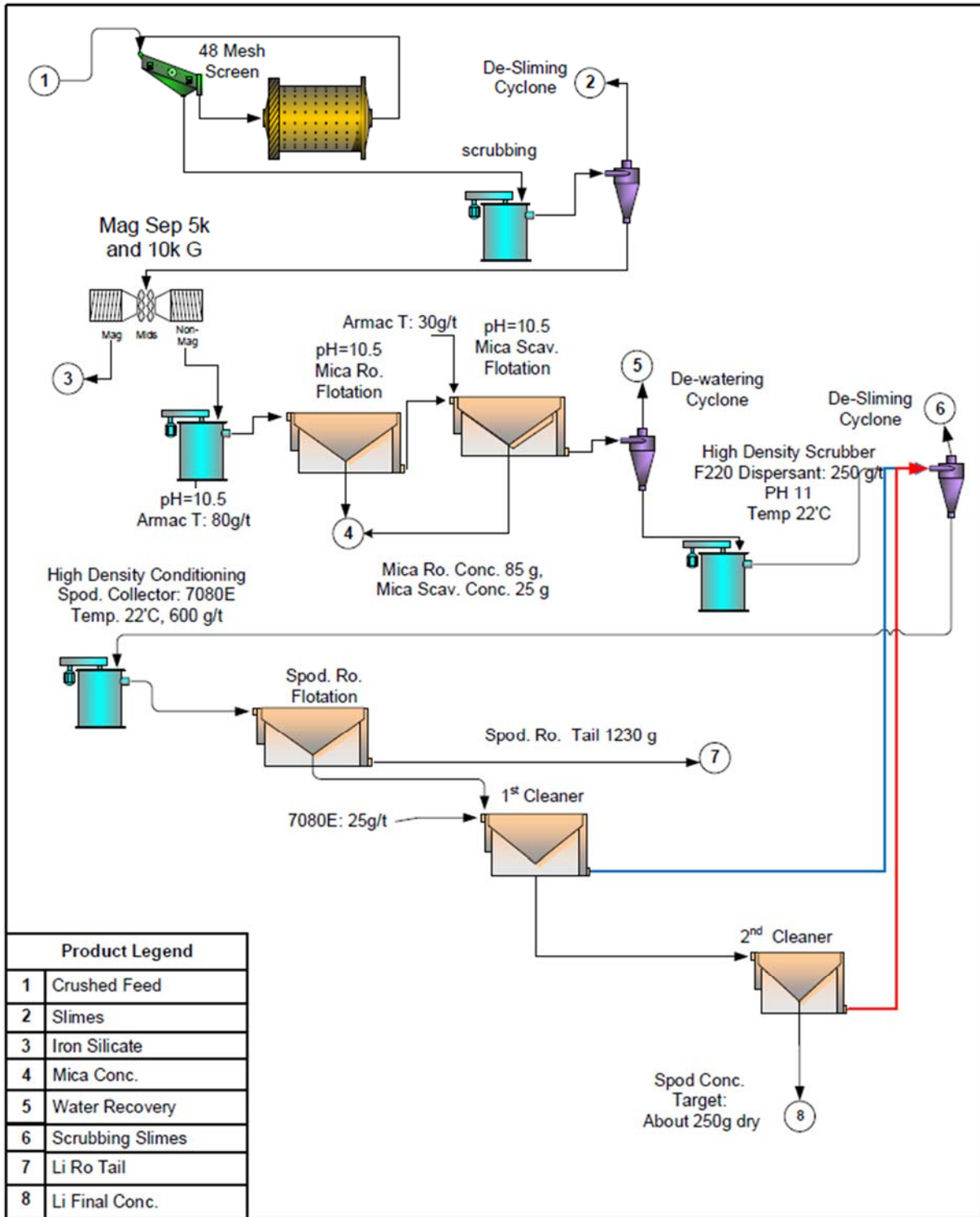

Figure 42 – Locked-Cycle Test Flowsheet (SGS, 2019).

The quality of the combined spodumene 2nd cleaner concentrate was excellent, with 6.19% Li<sub>2</sub>O and 87.2% lithium recovery. They were consistent with the projected lithium grade and recovery.

### ***13.2.7. Combined DMS and Flotation Testwork***

The mass yield of the LCT-1 2nd cleaner concentrate (14.3%) was higher than the DMS concentrate (8.8%), with the DMS concentrate containing a slightly higher grade (6.34% Li<sub>2</sub>O) compared to the flotation concentrate (6.16% Li<sub>2</sub>O). The combination of these two products yielded an on-spec spodumene concentrate, grading 6.23% Li<sub>2</sub>O at 88% lithium recovery.

The key sources of lithium loss were the DMS tailings (4.3%), combined slimes (2.5%), flotation magnetic concentrate (1.6%), and combined mica concentrate (1.6%).

Based on the positive results in the combined DMS + LCT-1 tests, the proposed final flowsheet should incorporate a DMS circuit followed by a flotation circuit to process the DMS middlings and the - 850 um undersize slimes fraction. This flowsheet is presented in Figure 16 and Figure 17, and the combined metallurgical results from the DMS + LCT-1 tests are included.

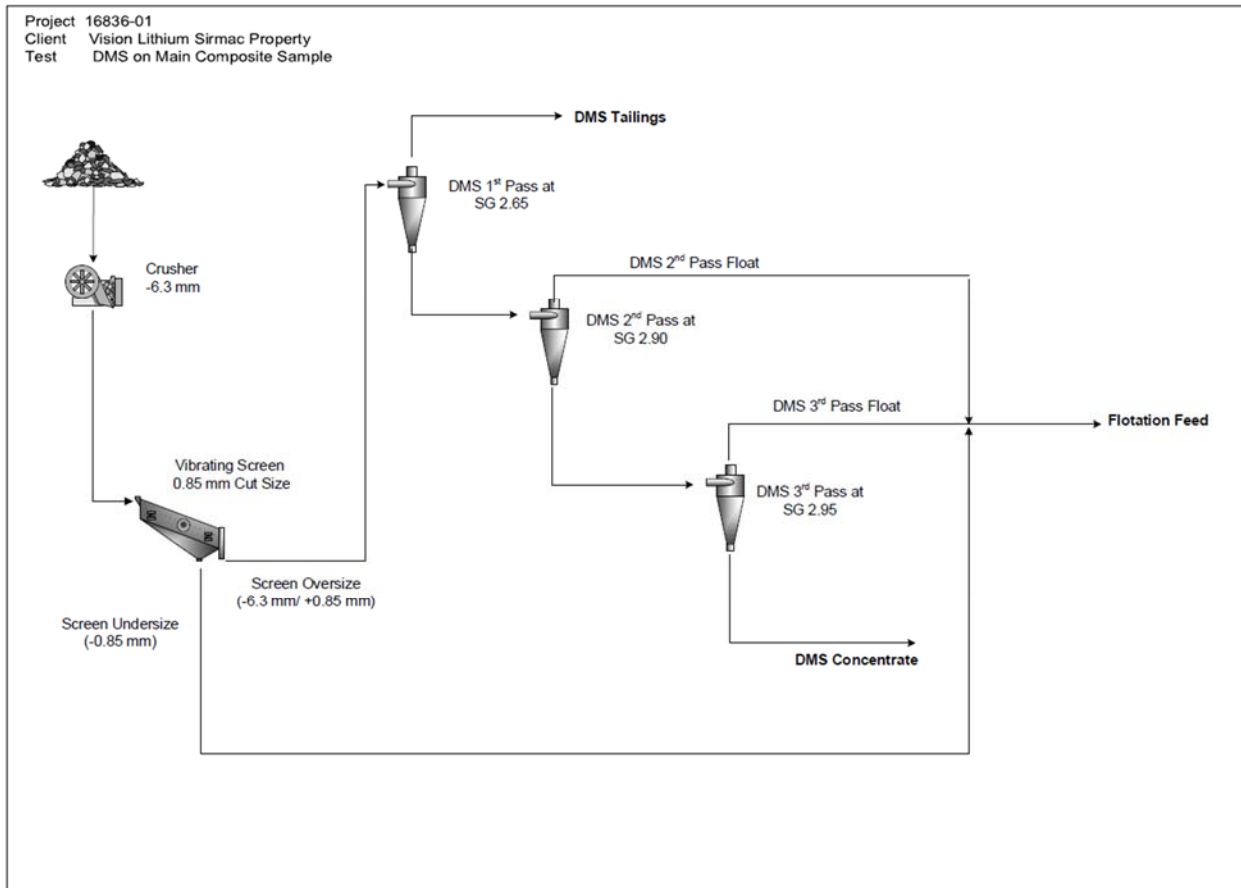

**Figure 43 – Final Developed DMS + Flotation Flowsheet for Main Outcrop Composite (Part 1 – DMS; SGS, 2019).**



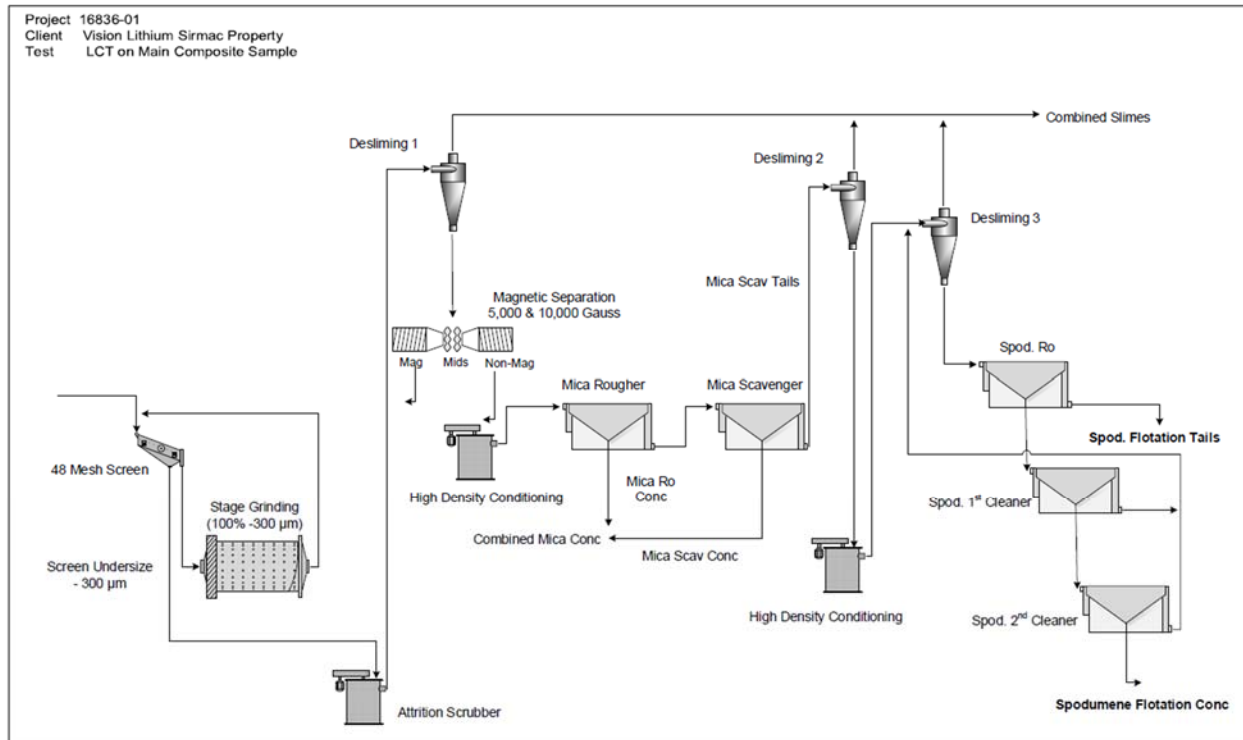

**Figure 44 – Final Developed DMS + Flotation Flowsheet for Main Outcrop Composite (Part 2 – Flotation).**

### 13.2.8. Lithium Extraction Tests

To extract lithium from spodumene concentrates generated in the mineral processing testwork, phase transformation, acid baking, and water leach tests were conducted. Dense media separation (DMS) concentrate 3rd pass sinks (from the Main Outcrop Composite) and flotation lithium concentrates were used in this program.

Full detail of the procedures and results regarding the lithium extraction tests are available in SGS Canada' 2019 report.

### 13.2.9. Mineral Processing Conclusions

The following conclusions can be drawn from the results of the testwork completed on samples from Vision Lithium's Sirmac Property:

- The lithium grade of the Main Outcrop Composite was 1.76% Li<sub>2</sub>O and the lithium grades of the variability samples ranged from 0.47% to 2.71% Li<sub>2</sub>O.
- The iron content of the samples was generally low (0.4-0.5% Fe<sub>2</sub>O<sub>3</sub>), with the exception of Var 1. The high iron content of Var 1 (2.70% Fe<sub>2</sub>O<sub>3</sub>) indicated the presence of a large proportion of ironbearing waste material. This was confirmed by semi-quantitative XRD analysis, which showed higher mica, fluorapatite and amphibole/pyroxene contents in Var 1 compared to the other variability samples.
- The feed material for flotation (DMS middlings and -850 μm slimes) was characterized as moderately soft, with BWI of 12.8 kWh/t.
- The potential for excellent lithium beneficiation by DMS was indicated in HLS tests on the two composites.
- This was confirmed in DMS testing with the Main Composite feed material. A three-pass DMS test at SG of 2.65 rejected most of the silicate gangue minerals to tailings and produced a middling product, while a DMS test at SG 2.90 produced high-grade spodumene concentrate that met the final product quality target (32% lithium recovery in ~9% of the feed mass, at a concentrate grade of 6.34% Li<sub>2</sub>O).
- This DMS concentrate grade was very similar to the predictions based on the results of the HLS test on the Main Outcrop Composite. However, the mass of DMS concentrate (and therefore lithium recovery to the DMS concentrate) was significantly lower than predicted by the HLS test.
- An additional 64% of the lithium reported to the DMS middlings plus the 850 μm screen undersize product, which once combined represented the feed to flotation. This product represented 58% of the feed mass and graded 1.92% Li<sub>2</sub>O, which was similar to whole ore head grade of 1.75% Li<sub>2</sub>O. Incorporation of DMS in the flowsheet therefore reduces the amount of material feeding the flotation plant by almost 50%.
- QEMSCAN analysis of the Main Outcrop Composite feed to flotation indicated that spodumene accounted for ~98% of the lithium in the sample, and that >83% of the spodumene was free or liberated in the -300 μm fraction. Based on this data and conventional mechanical flotation cell limitations, a grind size of 300 μm was selected for flotation testwork.

- Batch flotation tests on the Main Outcrop Composite feed to flotation all yielded excellent flotation performance and indicated that Custofloat 7080E demonstrated slightly better performance than FA-2 and FA-2/TP-A100 mix collectors. The final cleaner concentrate produced in the best batch test result graded 6.30% Li<sub>2</sub>O and recovered 88.6% of the lithium.
- The results of the batch flotation tests on the three variability were not as good as the tests on the Main Outcrop **Composite. Var 2 and Var 3 produced on-spec spodumene concentrates (>6% Li<sub>2</sub>O), but with lower lithium recovery (75-80%),** while the desired Li<sub>2</sub>O grade could not be produced in the test with Var 1. This was likely due to the significant amount of iron-bearing waste and apatite in the Var 1 sample.
- The single locked-cycle flotation test that was conducted on a sample of the Main Outcrop Composite yielded excellent results. **The projected spodumene recovery to the final concentrate was 88%, at a concentrate grade of 6.16% Li<sub>2</sub>O** and 0.82% Fe<sub>2</sub>O<sub>3</sub>.
- The predicted performance of the overall DMS + flotation flowsheet is very positive, with a projected recovery of 88.3% lithium at a combined concentrate grade of 6.23% Li<sub>2</sub>O. The ~12% lithium loss in this flowsheet are distributed as follows: 7% to the DMS tailings, 2.5% to the float tails, 1.6% to the magnetic concentrate and 1.6% to the mica concentrate.
- A downstream flowsheet incorporating high temperature (1050° C) phase transformation of  $\alpha$ -spodumene to  $\beta$ -spodumene, followed by acid baking and water leaching of the  $\beta$ -spodumene, extracted 98-99% of the lithium into an aqueous solution.
- The objective of the high temperature roasting step is to convert the inert  $\alpha$ -spodumene mineral into the leachable  $\beta$ -spodumene form. XRD results confirmed that the conversion conducted at 1050°C for one hour in the muffle furnace was complete. About 40 minutes retention was sufficient for complete conversion, but this has not been optimized.
- The purpose of acid baking and water leaching was to first convert lithium in  $\beta$ -spodumene to solid lithium sulphate, and then to leach the lithium sulphate from the solid phase into an aqueous solution. It was shown that the thorough mixing of the roasted spodumene with sulphuric acid in the mixer before baking, blending the calcine during acid baking at temperatures between 210°C and 240°C, and high intensity mixing during the water leach increased the lithium recovery from

~90% to ~98%. Lithium extraction was better when water leaching was performed at room temperatures or lower temperatures.

### **13.2.10. Mineral Processing Recommendations**

The following recommendations are made for future testwork:

- Study the benefit of re-crushing the 1st Pass DMS concentrate to a finer size before the 2nd pass. This might liberate more spodumene mineral for recovering in the DMS concentrate and may reduce the amount of near-density material reporting to the flotation feed.
- Run the DMS pilot plant with larger feed samples and more variability samples to evaluate the robustness of the flowsheet.
- Examine the benefit of pre-floating phosphate minerals ahead of the spodumene flotation, particularly with ore zones in which there is a large amount of phosphate mineral present in the flotation feed.
- Complete more crushing and grindability tests on variability samples to understand the comminution variability of the ore with the objective of designing a robust milling circuit for the commercial plant.
- Study the relative benefits of a flotation only flowsheet versus a DMS-flotation flowsheet.
- Further flowsheet evaluation on samples containing waste rock.

As the project with its low amount of tonnage, it cannot support the building of a mill, so further if tests is required they should aimed at following the flowsheet of an existing mill.

The latest tests are positive and show high recovery achieving above 6% Li<sub>2</sub>O concentrate. This is a favorable aspect for selling the mineralized material to a 3<sup>rd</sup> party without beneficiation.

## **14 MINERAL RESOURCE ESTIMATES**

*Part of this section have been retrieved from the NI 43-101 Technical Report on Mineral Resource Estimation of the Pegmatite #5 Lithium-Tantalum Deposit completed by SGS Canada – Geostat, and written by G. Desharnais, Ph.D., P.Geo, J.-P. Paiement, M.Sc., P.Geo, and J. Gagné, Eng., for Nemaska Lithium Inc. (2014). The information gathered by SGS Canada – Geostat in 2014 were used for the new estimation with updated economic variables as the Authors are of the opinion that the additional data collected in 2018 and 2022 confirm the model or, in some cases, do not concern the dyke studied here, the Dyke #5. The data has been verified in its form, grades, interpretation as well as interpolation parameters and classification and the block model is considered current. as there is no material change in that aspect. GoldMinds QP endorse the work done by SGS Qualified Persons.*

### **14.1. Mineral Resource Estimates of 2013**

All block modelling, 3D solid generation and geological interpretation was done by SGS Geostat. Work was carried out by Jean-Philippe Paiement, M.Sc., P.Geo. under the supervision of Guy Desharnais Ph.D. P.Geo and qualified person for this project. Modelling and block interpolation was done using Genesis© software, developed by SGS Canada Inc. Pit optimization was done using Gem's Whittle module and Lerchs-Grossmann algorithm. To this date, no other deposit in the Sirmac property block has mineral resources stated or estimated.

#### **14.1.1. Database**

Data was transferred to SGS Geostat on January 23<sup>rd</sup> 2013. The database was created using Geotic© and exported to Geobase© for validations and corrections. The database contains 126 holes (73 from 2012 and 53 historic), 44 trenches, 846 deviation measurements, 2, 269 assays (522 historic results) and 839 lithologies.

The database contains 73 diamond drill holes from 2012 totalling 3, 379 meters. Because of their unsure positions, not all collars were identified in the field the 53 historic drill holes were left out of the estimating process but used for modelling purposes. Drill hole coordinates were kept in UTM coordinate system. Collar positions were surveyed by handheld GPS and elevations were corrected to match topographic surfaces. The trenches were surveyed using DGPS measures of each sample position.

The 2,269 assays results include hole name, from, to, sample number and assay values for Li % (2012 DDH), Li<sub>2</sub>O % (historic and 2012 DDH) and Ta ppm.

### 14.1.2. Geological and Structural Interpretation

Historic and summary 2012 cross sections were provided by Nemaska. SGS Geostat built a new set of sections every 10 m with a baseline at N325 and 000 section located at the position of SIR-12-R06. This section set is best fitted to the drilling pattern (Figure 45).

The main objectives of the interpretation and modelling were to:

- Construct a topographic surface using the DTM model from topographic data provided by Nemaska;
- Construct a surface for the overburden/rock interface using the DDH data;
- Normalize and interpret geological information;
- Build structural data set and 3D geological interpretation of the mineralized dykes and sills.

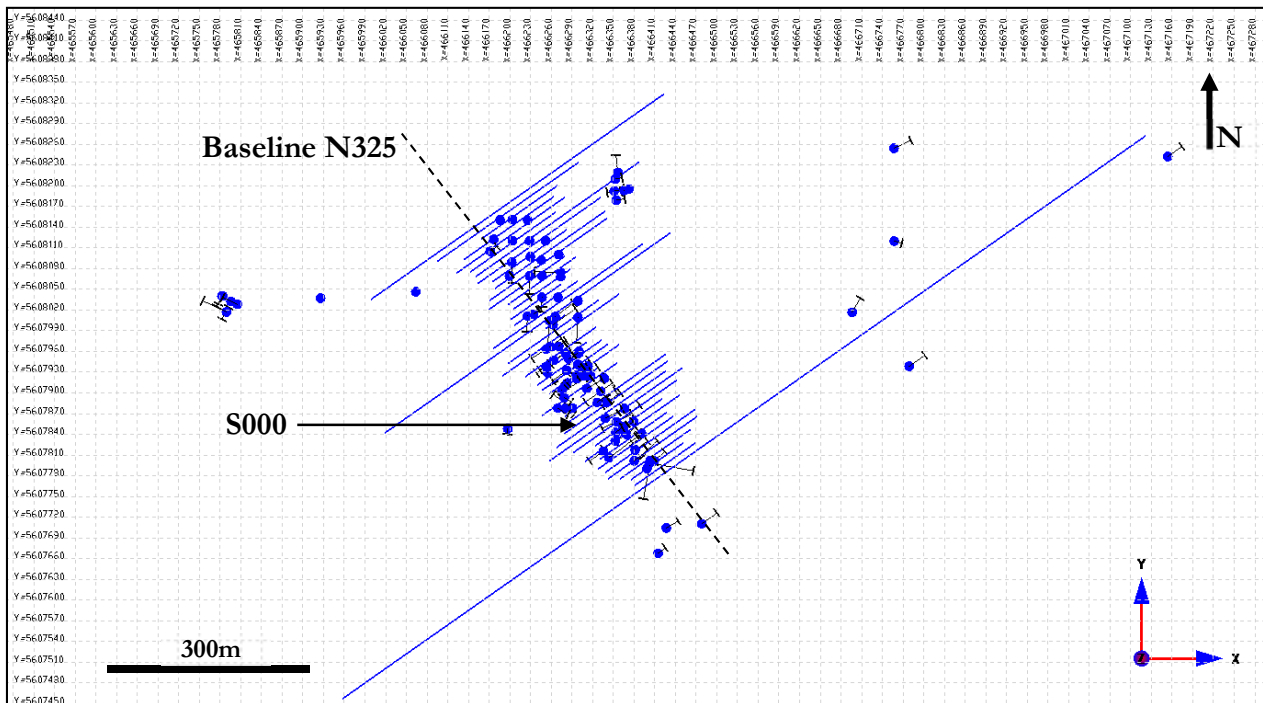
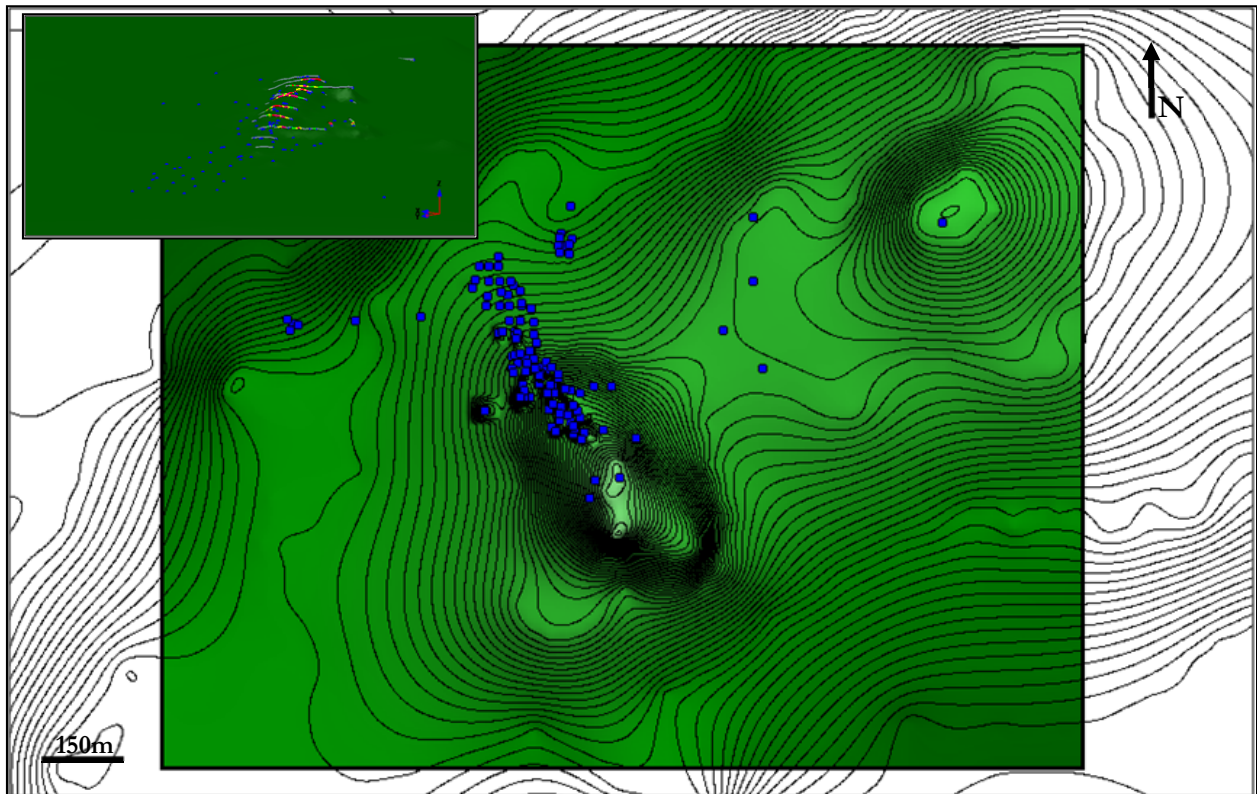

Figure 45 – Map view showing the positions of the cross sections.

Nemaska provided SGS Geostat with a topographic surface from the SIGEOM datasets. The dataset was constrained to fit local model needs and subsequently adjusted locally to fit DGPS points of trenches and survey geological contacts (Figure 46).

The overburden surface was generated by drawing the lower overburden contact on each section using drill hole lithologic data. The lines were then transformed to a DXF surface (Figure 47).



**Figure 46 – Topographic surface relative to drill hole collars (blue dots) with 3D view inset.**

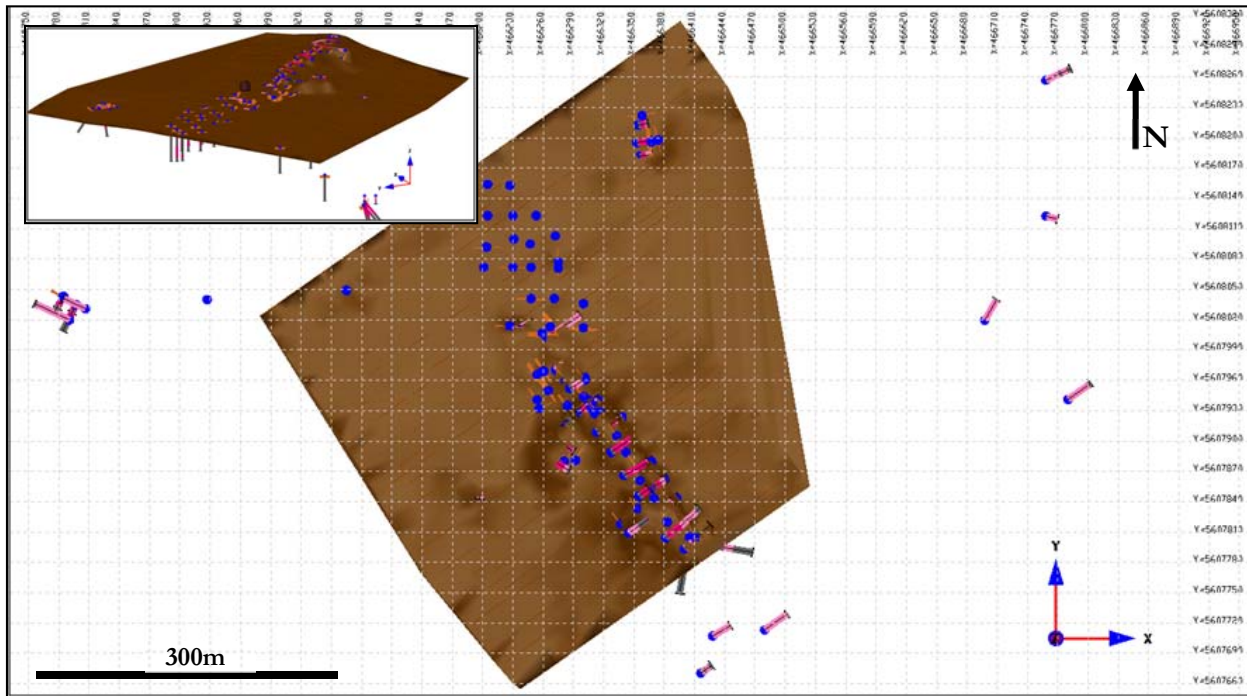

**Figure 47 – Overburden surface relative to drill holes with 3D view inset.**

Original Geotic drill logs were provided to SGS Geostat by Nemaska. These logs included original rock names, summary coding and a description. A total of 4 primary (Level 0) lithologies were created for modelling purposes (Table 9).

**Table 9: Lithologies Summary**

Rock type	Description	Level	Color legend	Rock Codes
OVB	Overburden	0	Brown	901
I1G	Pegmatite	0	Pink	300
I1G-S0	Spodumene bearing Pegmatite	0	Dark Pink	100-200
M4	Metasediments	0	Grey	400

To generate the geological model, SGS Geostat started with the general cross-section provided by Nemaska’s geologists. The general model provided by M. Gary H.K. Pearse (2010) also served as a base for the geological interpretation of the sections (Figure 11). The surface mapping data was also introduced in the modelling software in order to limit the surface extent of the mineralization. Recent interpretations suggest the presence of sub-horizontal sills and sub-vertical feeder dykes. This intrusive system was folded in late deformation (Figure 48). This interpretation is observed in drilling sections and by combining the



pegmatite and spodumene bearing pegmatite lithologies. A first envelop was built, corresponding to the pegmatite intrusion (Figure 48). Because of the zoned features of the pegmatites, mineralization is not observed all through the pegmatite envelope.

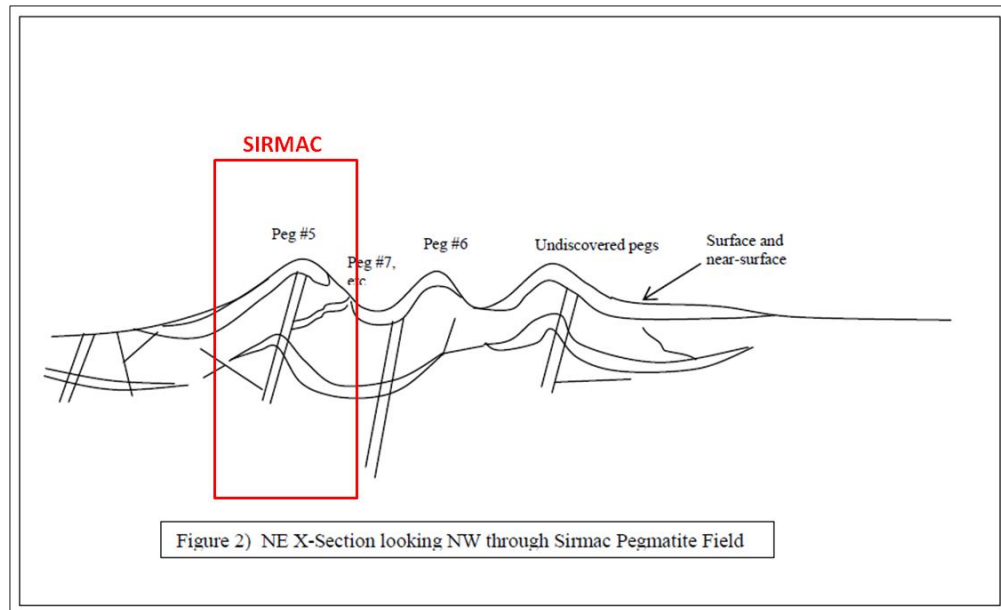

**Figure 48 – Schematic interpretation from Pearce, 2010.**

A modelling cut-off grade was then established to model the mineralized envelopes. Mineralized intervals were generated along the drill hole with a minimal grade of 0.30 %  $\text{Li}_2\text{O}$  and the presence of pegmatite lithology. Tantalum values were not taken in account because despite the negative statistical relation with the lithium mineralization (Figure 49) the geometric distribution is not well established. The assays corresponding to metasediments above the model cut-off grade were excluded from the envelopes because the Li are likely hosted in Li bearing micas which are not easily recovered by conventional processes (as opposed to Spodumene). A total of 73 intervals (average grade of 1.26 %  $\text{Li}_2\text{O}$ ) were created and tagged corresponding to the sills or the feeder dykes.

Using the mineralized intervals, 9 mineralized envelopes were created, 5 corresponding to the feeder dykes and 4 corresponding to the sills. The solids are exclusive from each other and the sills have priority over the feeder dykes. The overall volume of the envelopes is 209 000  $\text{m}^3$ .

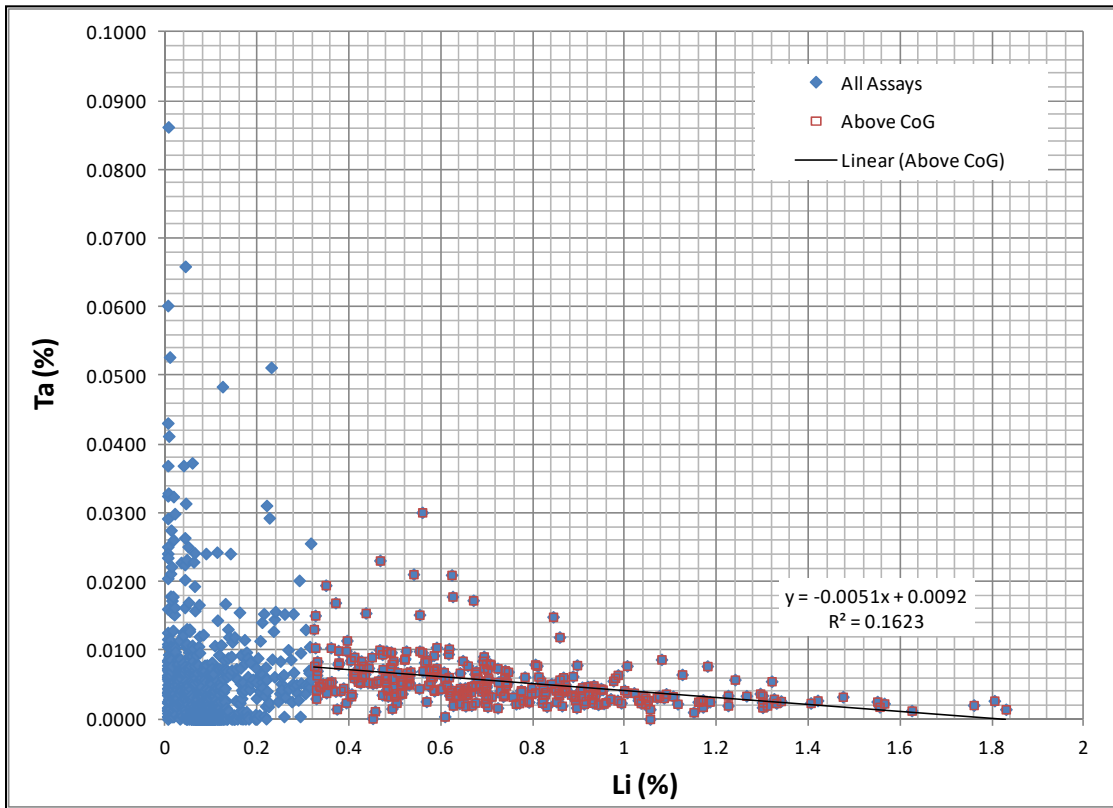

**Figure 49 – Li (%) and Ta (%) statistical relationship.**

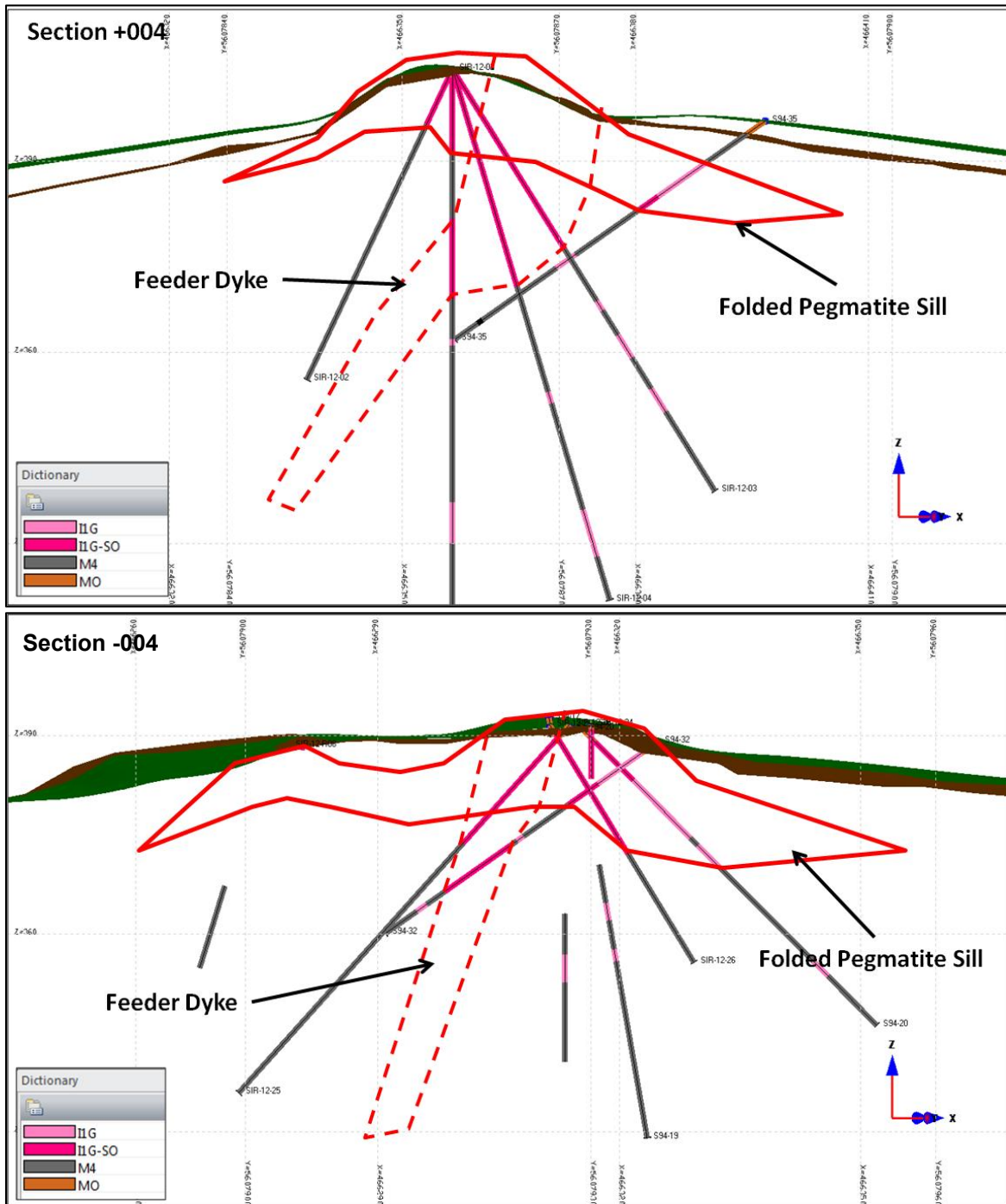

Figure 50 – Examples of lithological interpretation on sections.

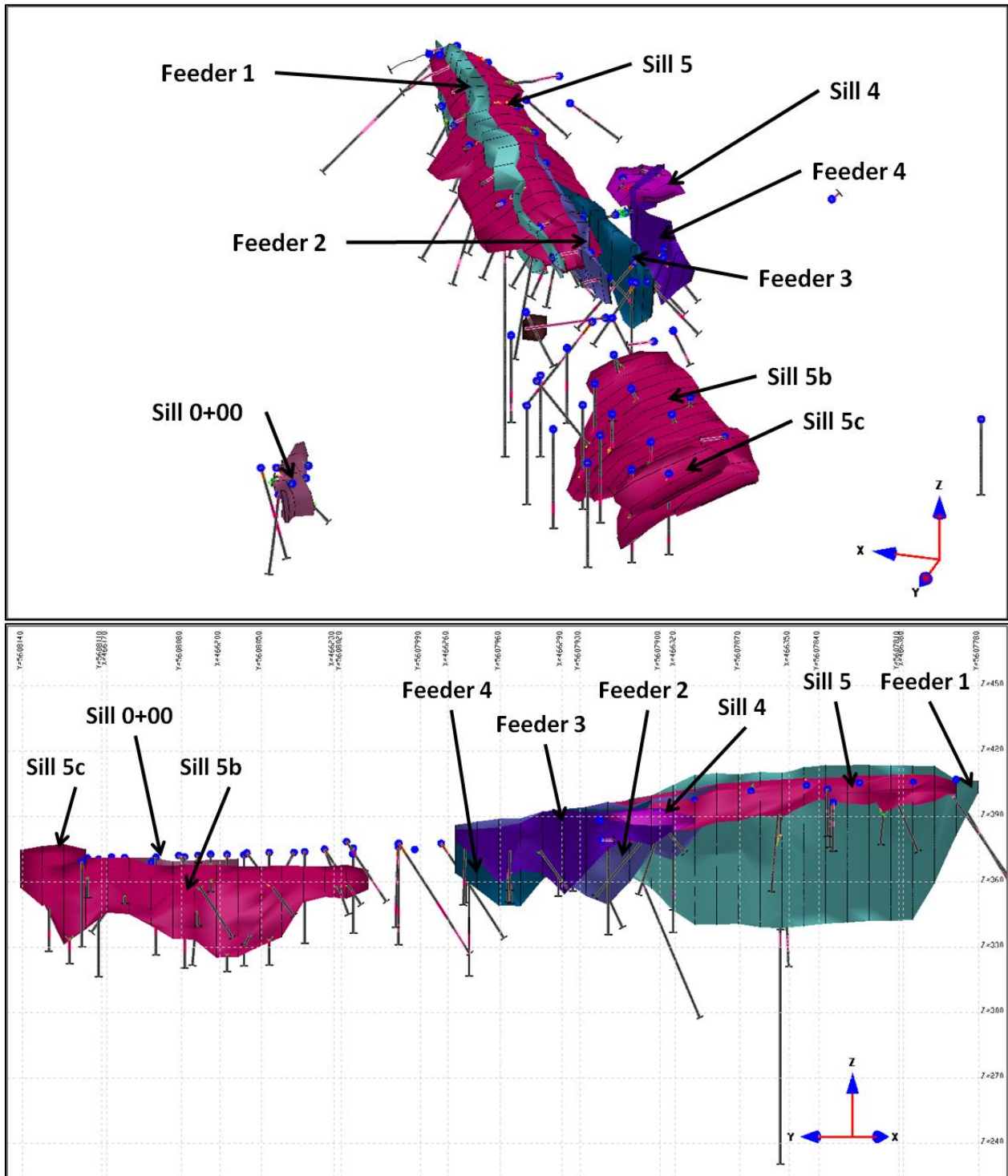
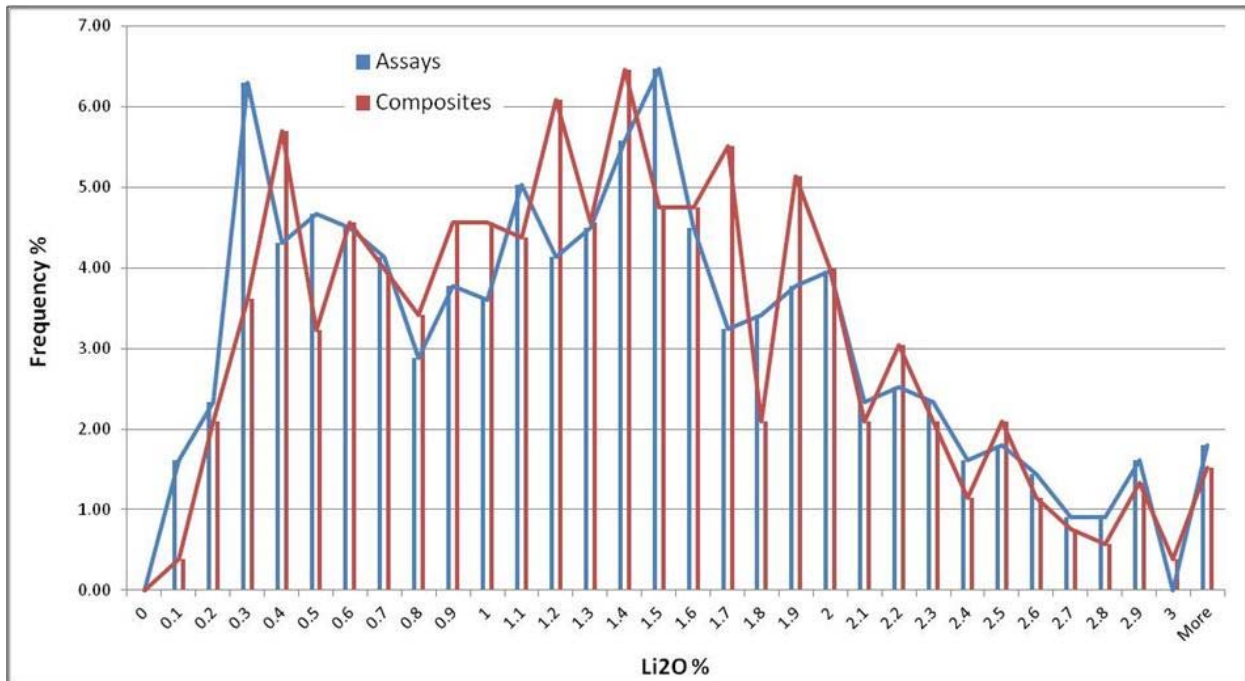

Figure 51 – Isometric and longitudinal views of the mineralized envelopes.

**14.1.3. Data compositing**

Assay data was composited in order to homogenize the sample length and weight during the interpolation process. This step of the process enables the creation of equal length composites within the limits of the mineralized intervals. The mean length of assay intervals is 1.14 m; composites of 1.5 m in length were generated. The composites were generated inside their respective envelopes, sills (mean value of 1.37 % Li<sub>2</sub>O; n = 358 and 0.0072% Ta<sub>2</sub>O<sub>5</sub>; n = 250) or feeder dykes (mean value of 1.20 % Li<sub>2</sub>O; n = 168 and 0.0069 % Ta<sub>2</sub>O<sub>5</sub>; n = 140).

The statistical distribution of the original assays and composites are bi-modal with a first mode between 1.33 % and 1.49 % Li<sub>2</sub>O corresponding to the mineralized material and a second mode between 0.20 % and 0.30 % Li<sub>2</sub>O corresponding to occasional waste material incorporated inside the mineralized envelopes (Figure 52). This bi-modal distribution is mostly due to the dyke material (Figure 53), which was more discontinuous than the sills and had more waste material incorporated in the envelopes in order to respect continuities. In order to respect these differences, the interpolation process was done on the sills and feeder dykes separately.



**Figure 52 – Histogram distribution for original assays and composites.**

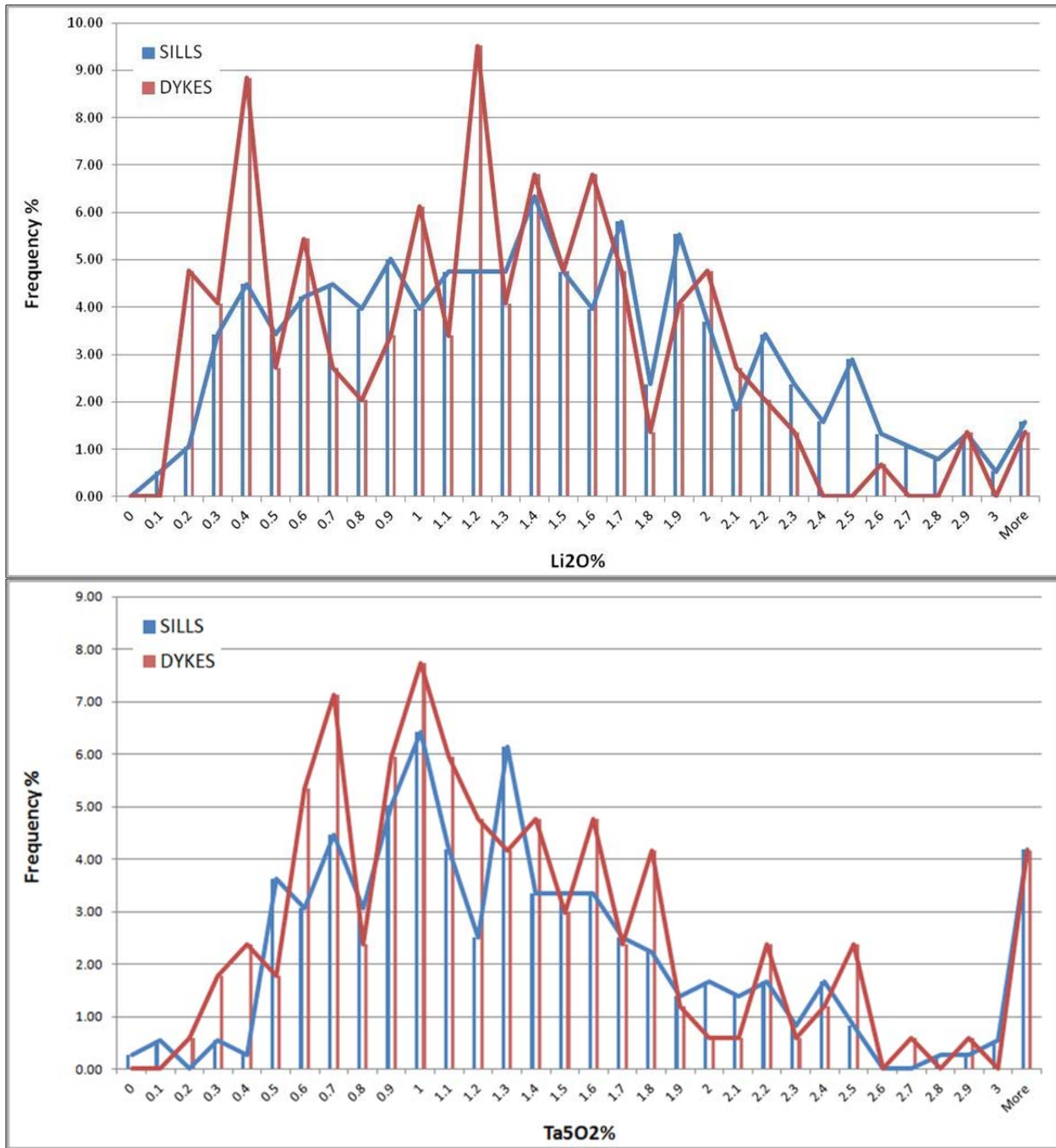

**Figure 53 – Histogram distribution comparing composites from the sills and feeder dykes.**

#### 14.1.4. Block Model Geometry

The area of the block model was determined from the extent and orientation of the mineralized envelopes. The block model was created inside the mineralized solids from minimum x, y, z coordinates to maximum coordinates (Table 10). Block size was set to 2 m along the X axis, 3 m along the Y axis and 3 m along the Z axis. A total of 18,523 blocks were generated and tagged according to the sills or feeder dykes envelopes. All the blocks are under the overburden surface.

The block model was then separated between sills and feeder dykes. The interpolated variables are Li<sub>2</sub>O %, Li %, Ta % and Ta<sub>2</sub>O<sub>5</sub> %. Blocks also have individual entries for their corresponding mineralized envelopes.

**Table 10: Block model geometry parameters.**

<b>GRID</b>	<b>X</b>	<b>Y</b>	<b>Z</b>
Origin	465 100	5 606 770	320
Dimensions	2	3	3
Discretization	1	1	1
Starting indices	1	1	1
Final coordinates	467 450	5 609 250	420
Final indices	1 176	495	34
<b>*Rotation of N-035° around Z axis</b>			
<b>** Fixed density : 2.7 t/m<sup>3</sup></b>			

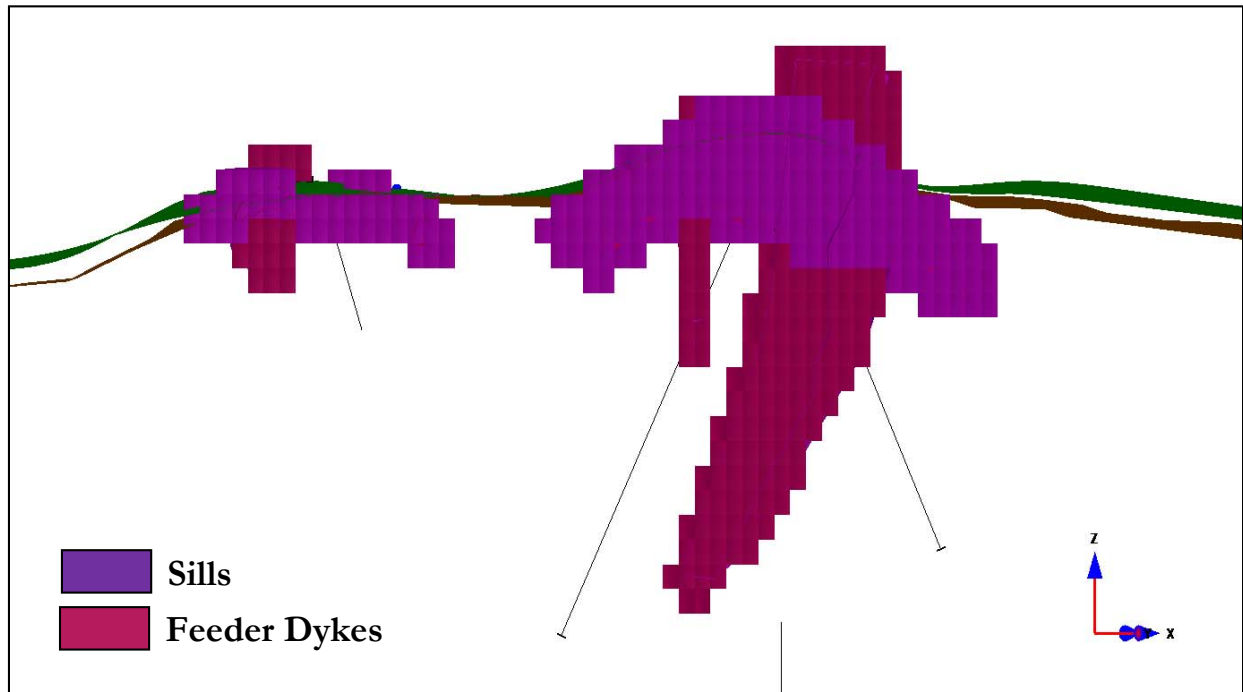

**Figure 54 – Color coded block corresponding to mineralized envelopes.**

#### **14.1.5. Block Model Interpolation and Classification**

In order to interpolate block's  $\text{Li}_2\text{O}$  %, Li %, Ta % and  $\text{Ta}_2\text{O}_5$  % values, 2 different search ellipses were used (Table 11). The composites, blocks and search ellipses are exclusive of each zone (sills and feeder dykes). Due to the restricted number of composites (sills  $n= 358$  and dykes  $n = 168$ ) the inverse square distance interpolation methodology was used with 2 passes using broader ellipses and search criterias in the second passes.

Of the 11,571 total blocks, 11,034 blocks were interpolated for Li and 10,905 blocks were interpolated for Ta using the stated parameters (Table 12), the remaining blocks were removed from the model because they were interpreted too unreasonable to be extrapolated from the measured datapoints.

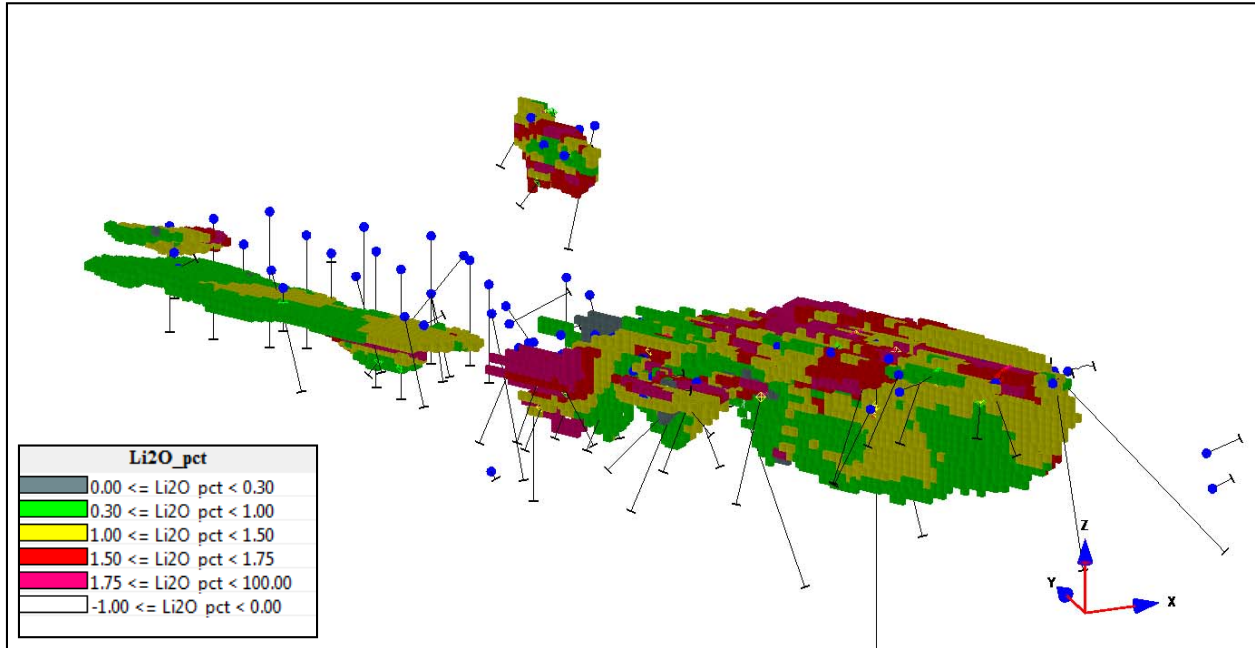

**Table 11: Search Ellipse parameters**

Ellipses	Azimuth		Major Axis	Interm. Axis	Minor Axis
Sills 1	325°	20° Spin	25m	12.5m	6m
Sills 2	325°	20° Spin	50m	25m	10m
Dykes 1	325°	-85° Spin	25m	12.5m	4m
Dykes 2	325°	-85° Spin	50m	25m	8m

**Table 12: Interpolation parameters**

Zones	Passes	Method	Ellipses	Min Comp.	Max. Comp	Max Comp /DDH
Sills	1	ISD	Sills 1	5	8	2
Dykes	2	ISD	Dyke 1	5	8	2
Sills	3	ISD	Sills 2	1	5	-
Dykes	4	ISD	Dyke 2	1	5	-



**Figure 55 – Interpolated block model.**

The interpolated blocks were compared with the composites used for interpolation and assays from the mineralized solids. The mean value of the assays (1.12 %Li<sub>2</sub>O) and composites (1.09 %Li<sub>2</sub>O) are comparable and the statistical distributions are similar (Figure 56). The interpolated mean value of the blocks is slightly higher due to the “smoothing” of the composite grades during the interpolation process. High grade values and low grade values are averaged hence lowering the variance of the block distribution (Figure 56).

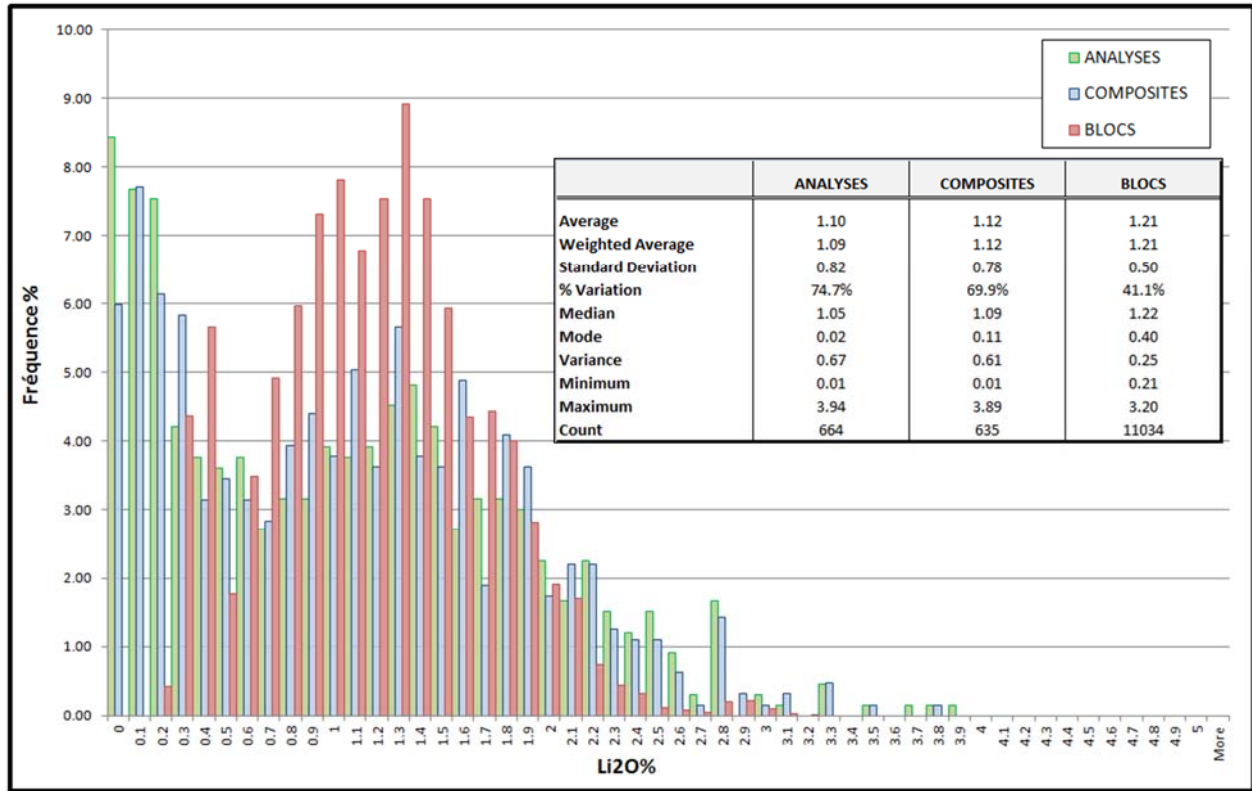

**Figure 56 – Statistical distribution of assays, composites and interpolation blocks.**

Classification of the resources was done on the basis of the interpolation process results from the first pass (Table 12). The authors feel that the criteria of the first interpolation pass are strict enough to represent measured resources. The ellipses used to interpolate the first pass are also representative of a drilling grid for the definition of measured Li resources. The geographic location of the block estimated during the first pass of interpolation was used to create 3D solids were used for classification purposes. Blocks were assign classification using envelopes for both the measured and indicated resources (Figure 57 and Figure 58).

The volume of each block was reported using the initial block size of 2m x 3m x 3m. Volumes were then converted in tonnage using a specific gravity of 2.7t/m<sup>3</sup> (Whabouchi Technical Report, 2012). No density measures were taken for the Sirmac deposit, but due to the similar nature and composition of the mineralized rock the authors feel that this value is representative.

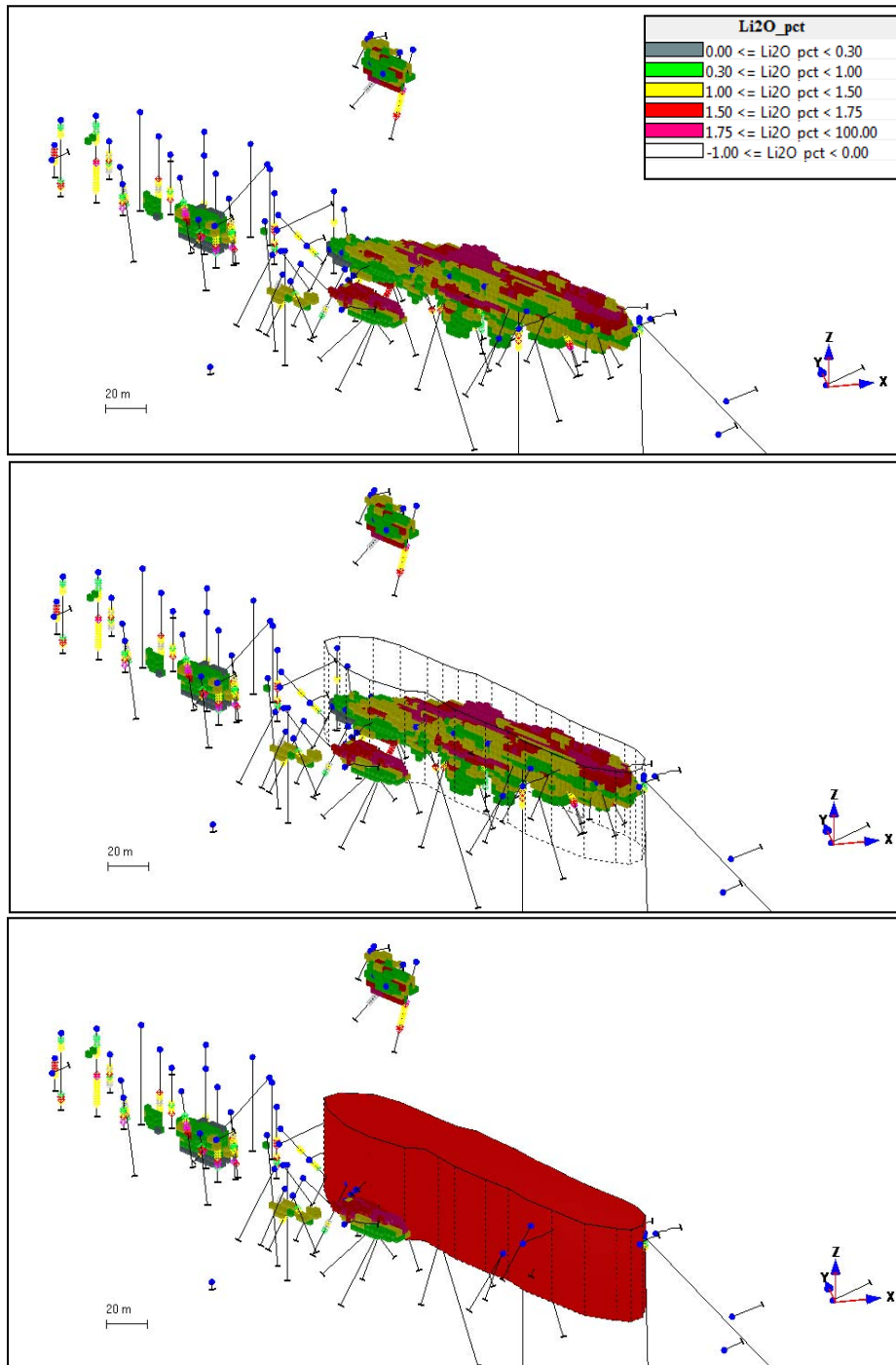

**Figure 57 – Blocks corresponding to the first interpolation pass (upper), measured resources envelope (middle and lower).**

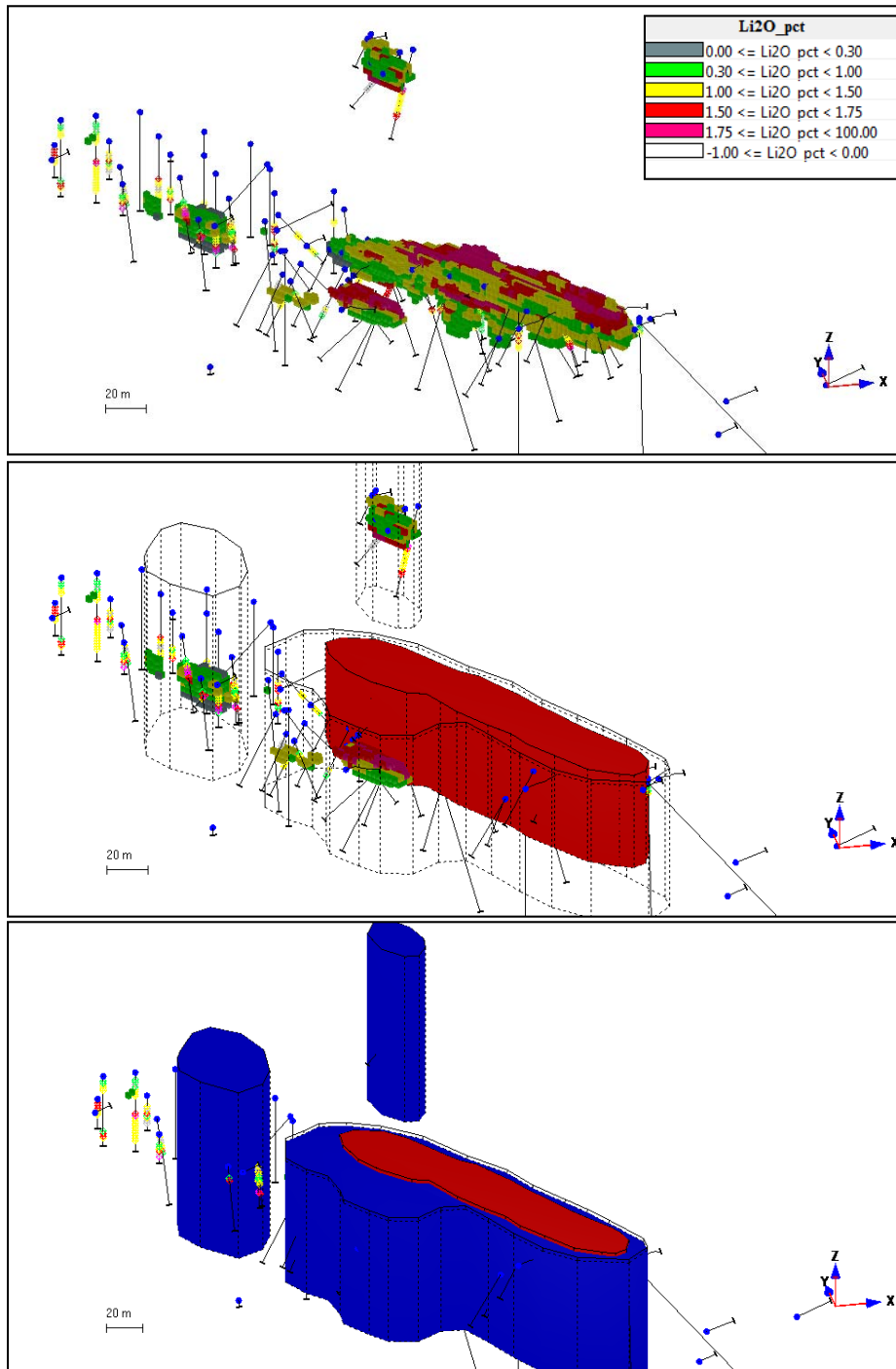

**Figure 58 – Blocks corresponding to the first interpolation pass (upper), indicated resources envelop (middle and lower).**

After reporting the blocks under the overburden surface, a quick sensitivity study was undertaken on the grade for the block model (Figure 59). These numbers do not represent mineral resources since they have not proven “a reasonable prospect of economic extraction” under the Ni-43-101 regulation and definitions of the Canadian Institute for Mining. The sensitivity study enables a better representation of the grade variation in the block model (Figure 59).

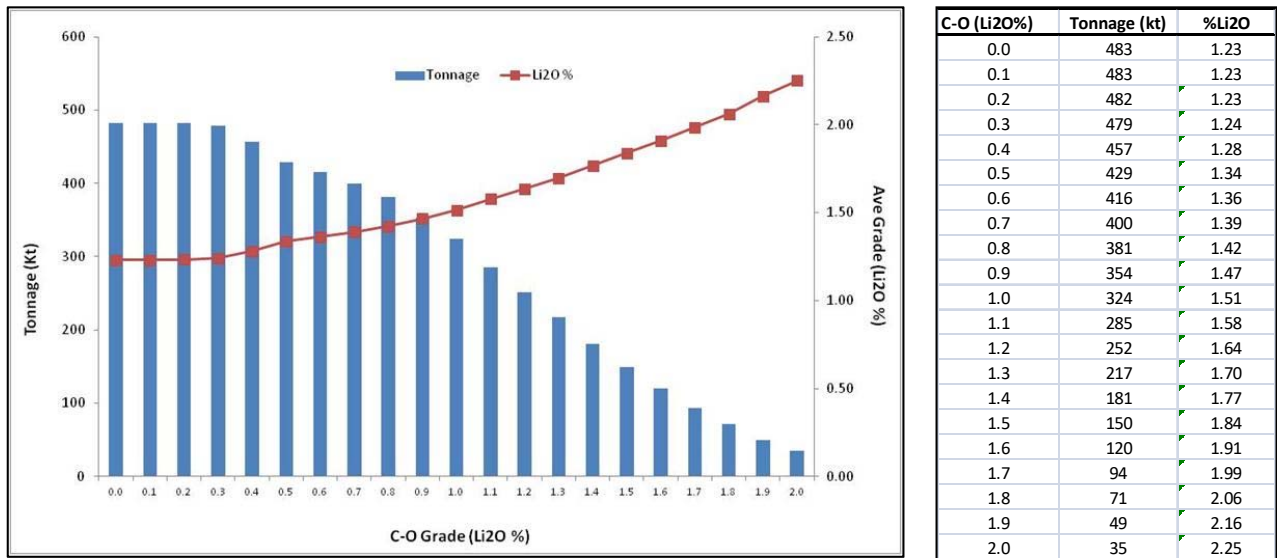

Figure 59 – Histogram distribution of tonnage and block grades.

**14.1.6. Whittle Pit Optimization**

In order to limit the mineral resources representing “a reasonable prospect of economic extraction”, a Whittle Pit optimization was completed using the Lerchs-Grossman 3D algorithm in Gems©. This work was done by Jonathan Gagné, Eng from SGS Geostat. In order to run the optimization process, the blocks of the resource model were assigned a value using economical assumptions (Table 13) and the equation below:

$$Bvalue = [Vol * Density * \%env] * [Sale\$ * (((Li\%HG * (Rec\%/100)) / Li\%Conc) * (1 - (NSR\%/100)))]$$

The resulting pit shell was used to limit the blocks that will represent the mineral resources. A cut-off grade of 0.51 %Li<sub>2</sub>O was also calculated using the economic parameters and equation below:

$$Cog = (((Processing Cost + G\&A Cost) * (1 + \%dilution)) / (1 - (NSR\%/100))) * Li\%Conc * (1 / Sale\$) * (1 / Rec\%)$$

**NOTE:** Since the Tantalum model is not yet well understood and the mineralization as yet to demonstrate economic potential, Ta is not considered in the economic evaluation but is still be reported in the resources statement.

**Table 13: Economic assumptions for pit optimization (Desharnais *et al.*, 2014)**

ITEM	VALUE	UNITS	SOURCES
<b>Sales Revenues</b>			
Concentrate sale price	310.00	C\$/t	Whabouchi Technical Report
<b>Operation Costs</b>			
Ore mining cost	4.50	C\$/t	SGS Geostat estimate
Waste mining cost	4.50	C\$/t	SGS Geostat estimate
Overburden mining cost	4.50	C\$/t	SGS Geostat estimate
Crushing and Processing	15.49	C\$/t milled	SGS Geostat estimate
General & Administration	6.91	C\$/t milled	SGS Geostat estimate
<b>Metallurgy and Royalties</b>			
Concentration Recovery	90.00	%	SGS Lakefield Met Tests
NSR Royalties	1.00	%	Nemaska Lithium
<b>Geotechnical Parameters</b>			
Pit slopes	50	Degrees	Whabouchi Technical Report
Rock specific gravity	2.7	t/m <sup>3</sup>	Whabouchi Technical Report
Overburden specific gravity	2.0	t/m <sup>3</sup>	Whabouchi Technical Report

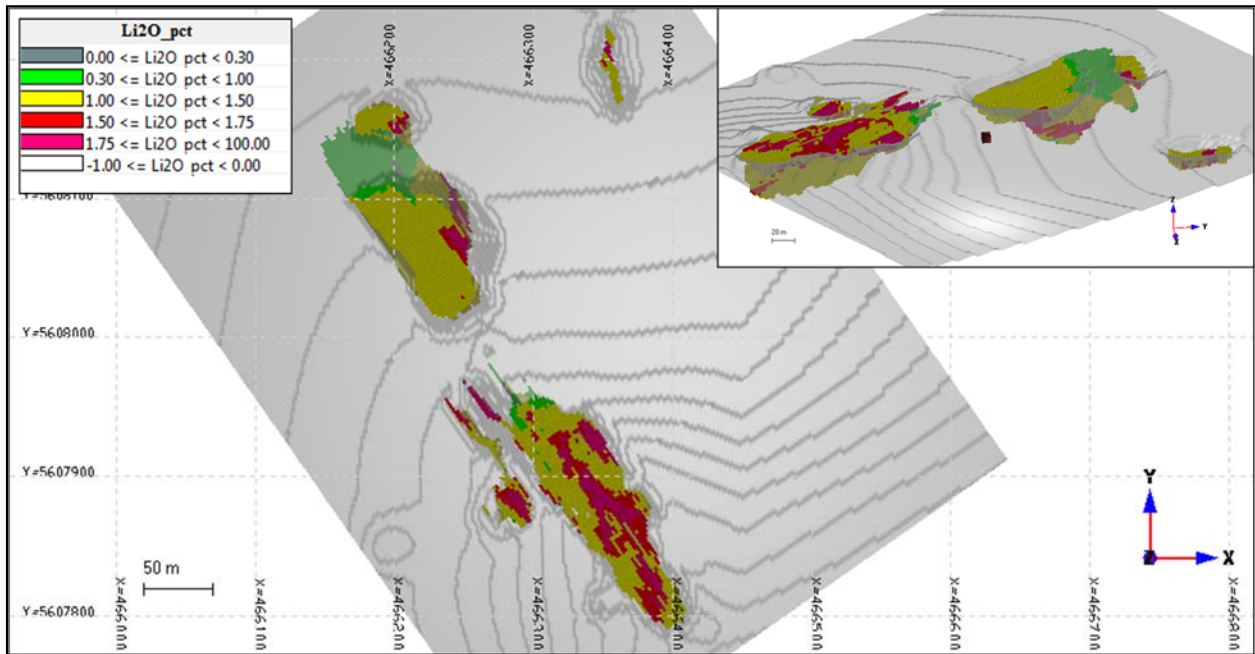

**Figure 60 – Pit outline and resource block model.**

**14.1.7. Mineral Resources**

Considering the blocks limited to the optimized pit shell and a cut-off grade of 0.50 %  $\text{Li}_2\text{O}$ , the mineral resources of the Sirmac deposit are 185kt of measured resources at 1.40 %  $\text{Li}_2\text{O}$ , 79kt of indicated resources at 1.40 %  $\text{Li}_2\text{O}$  and 40kt of inferred resources at 1.10 %  $\text{Li}_2\text{O}$  (Table 14). The Ta values are given from the block values inside the lithium mineralized solids and have yet to demonstrate extractability and economic potential. However, the authors feel that the values are reliable and could impact the project positively.

**These mineral resources do not represent mining reserves since they have not shown economic viability.**



**Table 14: Mineral Resources for the Sirmac Project with Li<sub>2</sub>O Cut off Grade of 0.50% (2013)**

Cut-Off Grade (Li <sub>2</sub> O%)	Category	Tonnage (t)	Average Grade Li <sub>2</sub> O %	Average Grade Ta <sub>2</sub> O <sub>5</sub> %
0.50	Measured	185 000	1.40	0.007
0.50	Indicated	79 000	1.40	0.008
0.50	Inferred	40 000	1.10	0.006
1.00	Measured	157 000	1.50	0.007
1.00	Indicated	67 000	1.50	0.008
1.00	Inferred	23 000	1.31	0.005
1.50	Measured	67 000	1.79	0.006
1.50	Indicated	28 000	1.89	0.006
1.50	Inferred	4 000	1.86	0.005

**\*NOTE:** The mineral resource estimate has been calculated using the Canadian Institute of Mining, Metallurgy and Petroleum (CIM) Definitions Standards for mineral resources in concordance with National Instrument 43-101 – Standards of Disclosure for Mineral Projects. Mineral resources which are not mineral reserves do not have demonstrated economic viability. Inferred mineral resources are exclusive of the Measured and Indicated resources.

Bulk density of 2.70 t/m<sup>3</sup> is used.

Effective date December 12, 2013.

\*\* Rounded to the nearest thousand.

## 14.1. Mineral Resource Estimates of 2023

### 14.1.1. Pit Design constrained Mineral resources

Vision Lithium requested GoldMinds to keep the existing amount of mineral resources above 0.5% Li<sub>2</sub>O for their contemplated DSO project. The parameters used in the optimization are conservative compared to what could be used as commodity prices in 2023.

GoldMinds kept the same pit constrained mineral resources shells to which a pit design was applied to define the new pit design constrained mineral resources.

**Table 15: 2023 assumptions for pit design**

ITEM	VALUE	UNITS	SOURCES
<b>Geotechnical Parameters</b>			
Pit over all slopes	50	Degrees	Other projects
Ramp width	13	M	Other projects
Ramp Grade	12	Degrees	Other projects
Bench face angle	75	Degrees	Other projects
Safety Berm	3	m	Other projects
Double bench	12.0	m	Other projects

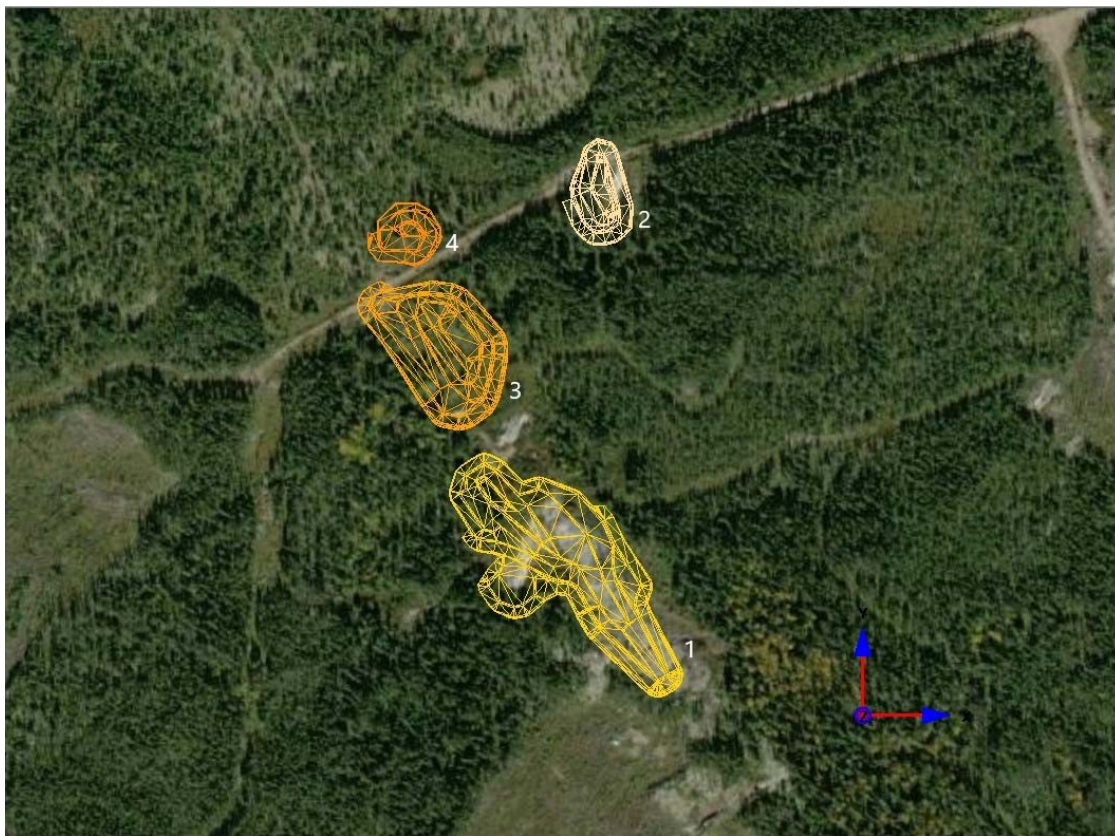

**Figure 61 – Plan view of the Property Dyke #5 with the pit outlines 2023.**

**14.1.2. Mineral Resources 2023 – Pit design constrained**

Considering the blocks limited to the optimized pit shell and a cut-off grade of 0.50 % Li<sub>2</sub>O, the mineral resources of the Sirmac deposit are 192,000 of measured resources at 1.38 %Li<sub>2</sub>O, 81,000 of indicated resources at 1.39 %Li<sub>2</sub>O and 49,000 of inferred resources at 1.05 %Li<sub>2</sub>O (Table 16). The Ta values are given from the block values inside the lithium mineralized solids and have yet to demonstrate extractability and economic potential.

**These mineral resources do not represent mining reserves since they have not shown economic viability and includes inferred material.**

**Table 16: Mineral Resources for the Sirmac Project with Li<sub>2</sub>O Cut-off Grade of 0.50% (2023)**

Cut-Off Grade Li <sub>2</sub> O %	Category	Tonnage t	Average Grade Li %	Average Grade Li <sub>2</sub> O %	Average Grade TaO <sub>5</sub> %
0.50	Measured	192,000	0.639	1.375	0.0074
0.50	Indicated	81,000	0.647	1.393	0.0081
0.50	Inferred	49,000	0.487	1.049	0.0062

**\*NOTE:** The mineral resource estimate has been calculated using the Canadian Institute of Mining, Metallurgy and Petroleum (CIM) Definitions Standards for mineral resources in concordance with National Instrument 43-101 – Standards of Disclosure for Mineral Projects. Mineral resources that are not mineral reserves do not have demonstrated economic viability. Inferred mineral resources are exclusive of the Measured and Indicated resources.

Bulk density of 2.70 t/m<sup>3</sup> is used.

Effective date January 23, 2023.

\*\* Tonnage rounded to the nearest thousand.

**14.1.1. Stripping Ratio**

A total of four (4) pits are designed out of the optimized scenario and it generates approximately 873 000t of overburden, waste rock and below cut-off grade rock. The ratio between the amount of overburden and waste rock that need to be removed to access a certain quantity of mineralized material is at 2.72:1 overall. The stripping ratio of the individual pits is presented in the following table.

**Table 17: Stripping ratio for the optimized pits**

<b>Pit #</b>	<b>Waste material t</b>	<b>Mineralized material t</b>	<b>Stripping Ratio</b>
1	414,000	233,600	1.77
2	75,800	10,000	7.57
3	346,800	70,500	4.92
4	36,700	7,400	4.93
All	873,300	321,600	2.72

The numbers above are used in the economic calculation of this PEA.

For the purpose of this PEA, the Ta<sub>2</sub>O<sub>5</sub> present in the pegmatite rocks is not taken into consideration.

## **15 MINERAL RESERVE ESTIMATE**

The present Technical Report is not an Advanced Property Technical Report. Therefore, this section will not be discussed in the present document.

## 16 MINING METHODS

### 16.1. Open Pit Quarry

#### 16.1.1. *Open pit quarry method*

The quarry operations method for the project is a simple drill, blast, muck and ship method. The work will be done 6 months per year from May to October. The waste rock will be drilled, blasted and stockpiled on a designated area on the property. The mineralized material will be drilled on a tight pattern and blasted. It will be stockpiled on the property and transported by trucks on a regular basis to a pad in Chibougamau close to the railway.

The work is to mine 321,000 metric tonnes of mineralized material and 873,000 metric tonnes of waste during a 4-year period.

The benches will be 6 meters high and probably the drill holes will be of 115mm diameter depending on the chosen contractor.

The different employees from the contractor and Vision Lithium will stay at a logging camp that is rented by the SOPFEU, 12 kilometers as the crow flies from the quarry site, 20km by road.

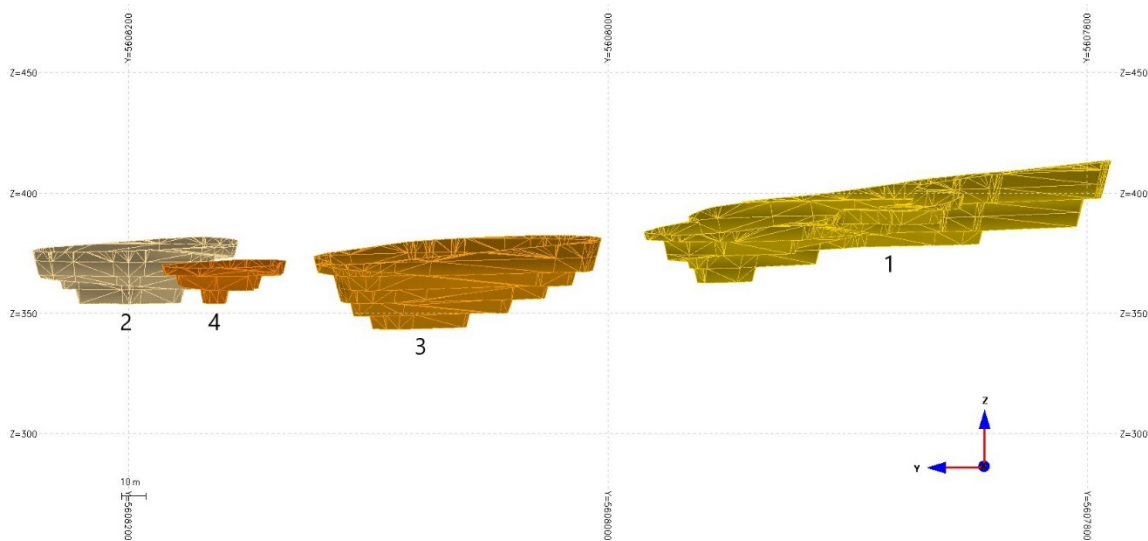

Figure 62 – Section view of the pit design.

### **16.1.2. Geotechnical study**

A geotechnical study should be done during the Feasibility stage (FS) or PFS stage if required.

### **16.1.3. Hydrogeological parameters and study**

A hydrogeological study shall be done during the Feasibility stage (FS), if required.

### **16.1.4. Phase design**

The project is designed to mine an average of 100,000 metric tonnes of mineralized material for year 1,2 and 3 and the remaining 21,000 metric tonnes for year 4. For the waste, for year 1 and 4 an amount of 130,000 metric tonnes per year will be mined out and for year 2 and 3, 307,000 metric tonnes per year.

Thus, for the first 4 years a total of 1,194,000 metric tonnes will be mined over a period of 6 months per year.

**It is important to mention that a first 49Kt at 1.82% Li<sub>2</sub>O of measured and indicated mineral resources can be extracted without stripping in pit #1. GoldMinds elected to use the average grade of the mineral resources in the 4 pit design to present a conservative perspective of general blending instead of cash flow optimization in the mining sequence. The company may elect to extract the 49,000 of higher grade material at the start of operations. The approach proposed by GoldMinds is to have extraction in zone 1 and zone 4 so the zone 4 can be used as water polishing pond for environmental purposes.**

## **16.2. Quarry Operation Planning**

### **16.2.1. Contracts operators**

For this PEA study, contractors' operation is used as a basis. It could be only one general contractor who would do the drill and blast, the mucking and the shipping to Chibougamau. A revised request for proposal will be submitted at the next study stage to firm up the estimated costs and final mining method to provide the feed material to a Chibougamau pad area. GMG has used in-house costs and similar contractor proposals to establish the PEA costs. Vision Lithium got a budgetary quote from a mining contractor based in the Province of Québec working in that type of work with lithium.

### ***16.2.2. Quarry operations planning parameters***

Forestry roads joining the property to the Chibougamau railhead can accommodate heavy load trucks up to 150 tonnes. The trucks will be standard road trucks with 40 metric tonnes rugged boxes or could be off-road trucks up to 100 metric tonnes depending on the chosen route.

The contractor will operate on a 6 months quarry operation basis with a schedule of 7 days per week, 12 hours a day. However, the transport of material could be on a 5 or 7-day basis, 12 or 24 hours per day depending on the trucking availability of the contractor.

The projected mine plan has room for variations and flexibility.

Drainage trenches to keep water from coming into pits is proposed as well as ditches to collect brown water to zone 4( identified as 1A on the map) as presented on the following figure.



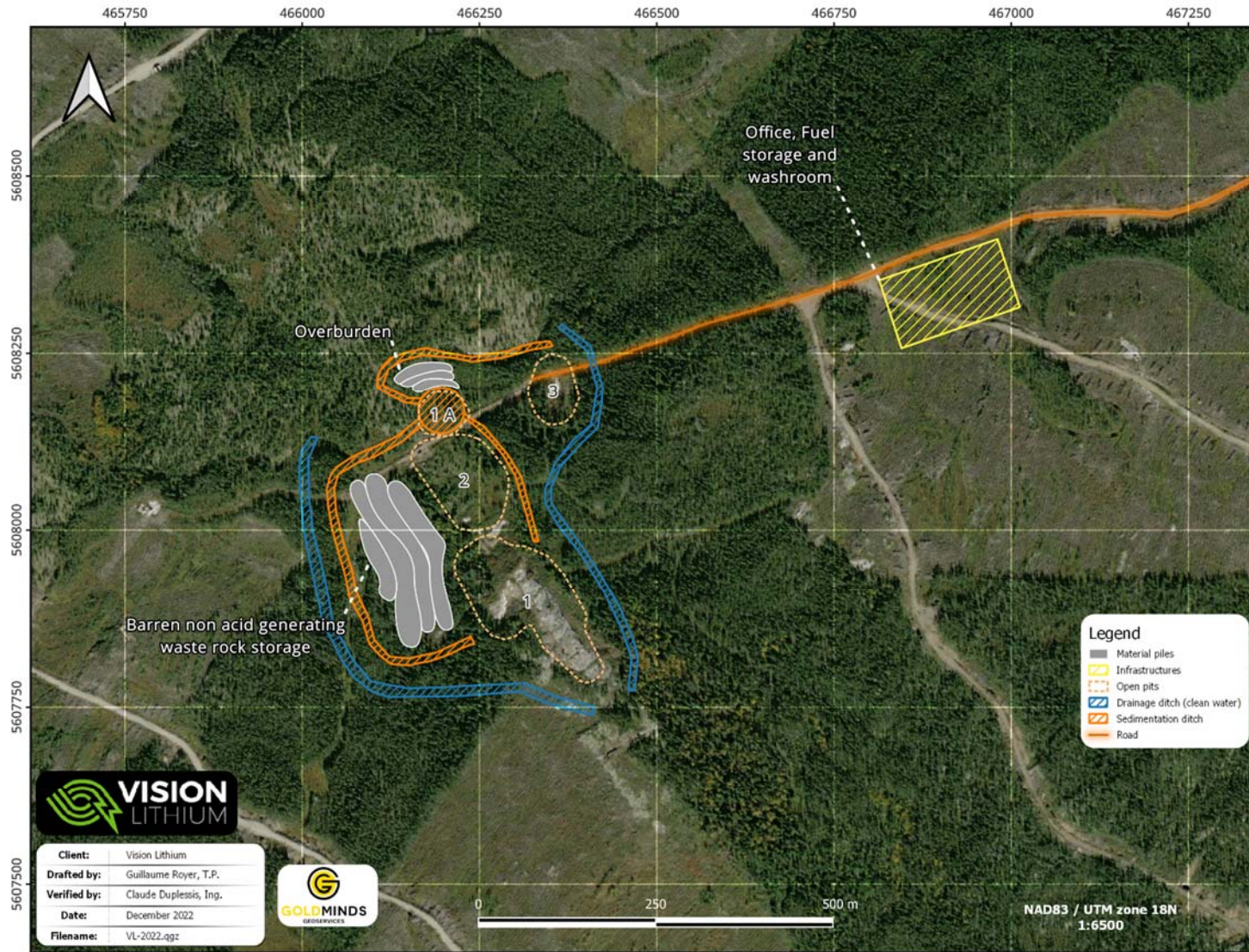

Figure 63 - Site surface plan.

## 17 RECOVERY METHODS

As the mineralized material is to be sold as a Direct Shipping mineralized material similar to some (DSO) iron projects, the recovery will depend of the company and plant which will process the material.

Nonetheless, Section 13 (Mineral Processing and Metallurgical Testing) shows the testing is positive and should be suitable for existing processing plants without limitation. The testing shows the Sirmac pegmatite #5 dyke is suitable to produce a spodumene concentrate grading 6%  $\text{Li}_2\text{O}$  and above.

## **18 PROJECT INFRASTRUCTURE**

### **18.1. Location**

For the Sirmac project infrastructures, there are only two locations; the quarry site and the Chibougamau site. All infrastructure of the Quarry site are visible on Figure 63. These are kept to a minimum as a quarry operation.

### **18.2. Quarry Site**

#### ***18.2.1. Access road***

The site roads already exist and they will be upgraded from time to time with waste rock from site.

#### ***18.2.2. Accommodation***

The different employees from the contractor and the client will stay at an existing logging camp that is rented by the SOPFEU, about 20 kilometers by road from the quarry site (12km as the crow flies).

#### ***18.2.3. Buildings***

The only buildings on site will be an office at the entrance of the site, a washroom and a small garage which will perform light servicing on equipment.

#### ***18.2.4. Fuel supply***

A portable diesel fuel tank on skids with a capacity of 50,000 liters will be installed beside the office and supplied by the general contractor.

#### ***18.2.5. Explosive magazines***

The two explosive magazines will be in a safe area following Government Regulations.

#### ***18.2.6. Electrical***

A generator will be installed by the contractor to supply electricity for the office, garage, fuel tank/pump and outside lighting.

#### ***18.2.7. Communication & security***

An internet satellite link Antenna with a booster on site will be installed at the office for communication and safety.

## **18.3. Chibougamau Site**

### ***18.3.1. Unloading pad***

An unloading pad will be constructed near the railyard for unloading the ore from the transportation trucks. The unloading area will have a capacity of 10,000 metric tonnes.

The best exact location has to be identified in further study, financial provision exist in the Cash flow for this structure.

### ***18.3.2. Loading area***

The loading area will be minimalist and, if needed, there will be only one loader.

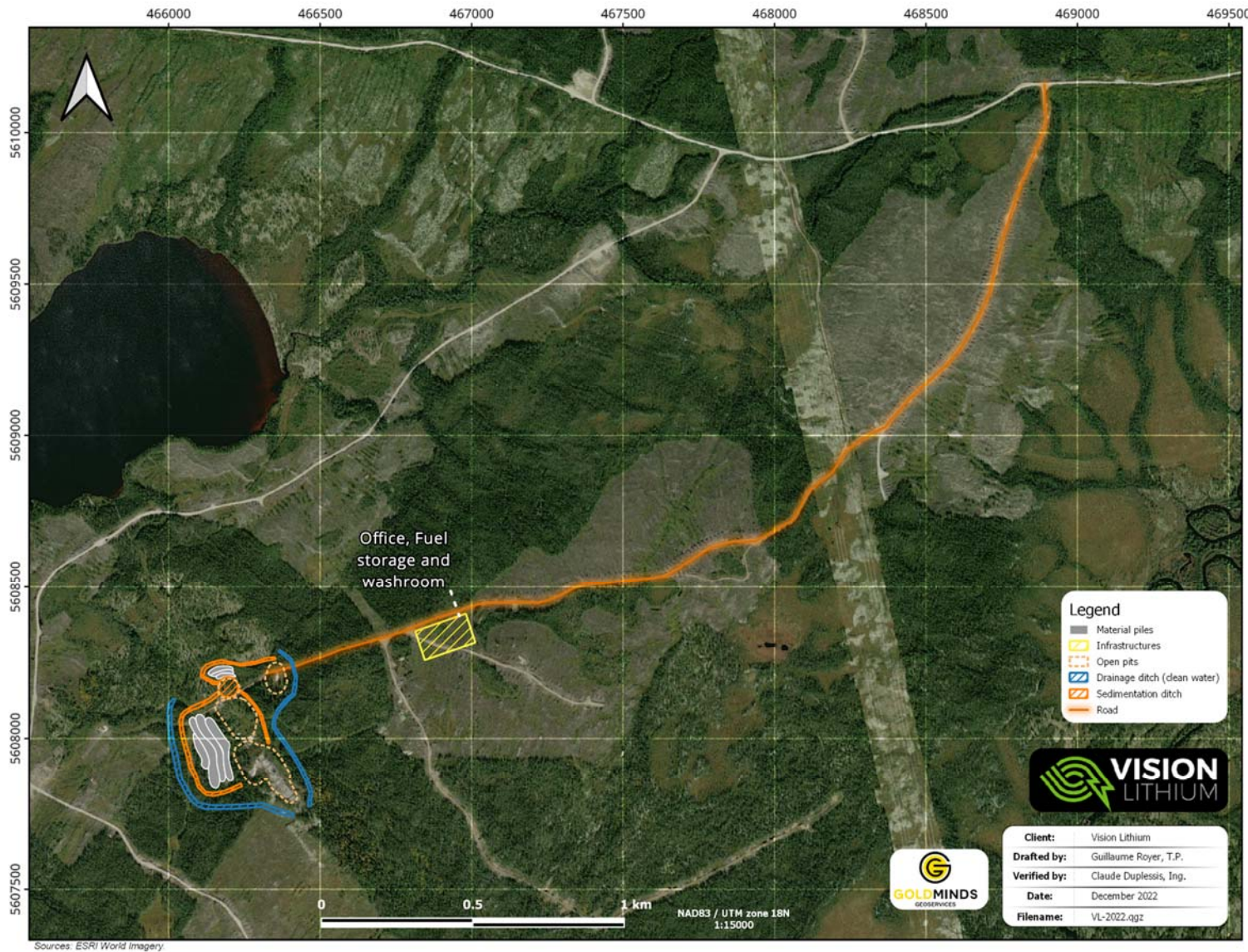

Figure 64 – Site surface plan with access road.

## 19 MARKET STUDIES AND CONTRACTS

At this time, the company relies on market studies found in competitors' studies.

The company is in negotiation to sell the product locally in the form of direct shipping ore (DSO).

The client provided several information on different studies with various price range.

Based on the positive metallurgical testing (details in Section 13 of this report), the resources at the Sirmac #5 pegmatite Dyke can be upgraded to 6% concentrate.

Hence the reference price is based on a 6% concentrate selling price. At the moment of preparing this report there is a high demand and limited supply for Lithium for the battery market.

+ Document received from the client of October 2022 Market spodumene concentrate offtake price: refer to SMM 6% Li<sub>2</sub>O spodumene concentrate CIF China like 5230 USD/t (12/10/2022)

Where:

For 1.5% to 2.5% Li<sub>2</sub>O DSO price = Market concentrate price in arriving day/6% x DSO Li<sub>2</sub>O content x 60%. On these premises a tonne at 1.5% DSO would quote 784 USD/t

The discount applied because of lithium manufacturer need to cover lithium loss (related to recovery rate) and process cost in spodumene beneficiation process.

+ In the documents and public release of others, the payable content of direct shipping material varies from 60% up to 80% depending of various conditions. GoldMinds elected to use a conservative 65% in the financial analysis.

+ Lac Rose Feasibility of July 2022 Technical grade 6% varies from US\$3333/mt up to US\$4,848/mt with 4039 US\$/t average price. As this PEA is considered a short term project which should beneficiate of higher price commodity bracket timeline, a 4100 US\$/t is used in the PEA

The company does not have any current contracts.

The web site of Trading economics present Lithium Carbonate price where we can see price soaring in 2022 and an adjustment in 2023. The following graphics shows from 2018 to 2023.

In the context of the PEA using mainly Lac Rose Feasibility study parameters and market analysis, the QP with the use of the 4100US\$/t concentrate at 6%, the average DSO grade of 1.33% Li<sub>2</sub>O represent a reasonable average Direct Shipping material value of rounded 591US\$/t. – 797 CA\$/t where 65% is considered payable by the buyer. The difference between probable effective recovery of 88% and 65% is consideration for process costs of the buyer which ranges from 60 to 80% as per public information

As additional information to support the price used in this PEA, the transaction of Core where DSO from Australia sold at US\$ 951/dmt of 1.4% Li<sub>2</sub>O. Link : <https://www.greencarcongress.com/2023/01/20230102-core.html>

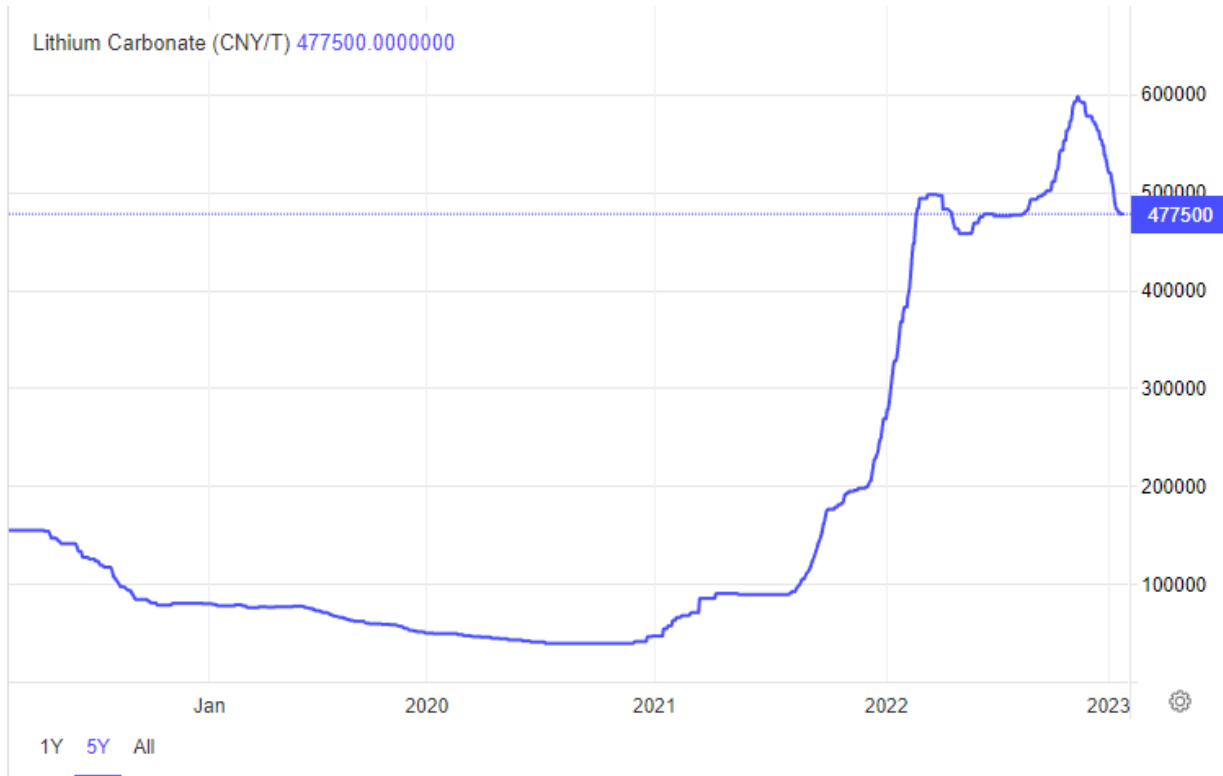

Figure 65: Lithium Carbonate price variation from 2018 to 2023 in CNY/T



The above figure is to present the significant demand for Lithium product. The  $\text{Li}_2\text{CO}_3$  specialized product is quoted at 477500 CNY which in Canadian \$ is 94431.19 based on a 0.20 CDN to 1 CNT. The graphic is used to present the significant increase in value of Lithium product and as well present a decrease in 2023 which could indicate high price in short term and lower in the medium to long term.

The Vision Lithium Sirmac project has the potential to proceed in the short term with the objective of Direct Shipping which could benefit from the higher current prices. A specific market analysis should be contemplated at the PFS stage.

## **20 ENVIRONMENTAL STUDIES, PERMITTING AND SOCIAL OR COMMUNITY IMPACT**

### **20.1. Background**

The Sirmac site was acquired in 2017 and had some preliminary exploration activities performed on it in 2012. At the time, drill holes, overburden removal and washing of the surface outcrop was performed. The site has not been reclaimed.

### **20.2. Regulatory Context and Permitting**

#### ***20.2.1. Federal***

Under the Impact Assessment Act (IAA 2019), only projects designated by the Regulations Designating Physical Activities (DORS/2019-285) are subjected to the environmental assessment procedure. Thus, an environmental assessment under the IAA 2019 is required for a project that involves the construction, operation, decommissioning and abandonment of a new lithium mine, other than a placer mine, with an ore production capacity of 5,000 t/d or more.

Vision Lithium is planning to open a mine with an ore production capacity less than 5,000 t/d and is thus not subjected to the IAA 2019.

The IAA also provides a discretionary authority that enables the Minister of Environment and Climate Change (the Minister) to designate a proposed project that is not on the Project List. The Minister may exercise this authority if the carrying out of the project may cause adverse effects within federal jurisdiction or adverse direct or incidental effects, or public concerns related to those effects warrant the designation.

This discretionary authority enables the Minister to consider exceptional circumstances such as where a project is proposed in an environmentally sensitive location or there is a new or unique type of project that was not contemplated when the Project List was developed.

Under subsection 9(1) of the IAA, the Minister may, upon request or on their own initiative, designate a project that is not on the Project List.

Designation requests may come from:

- the public
- an Indigenous community
- a non-governmental organization
- a federal authority
- the Agency
- another jurisdiction
- the project proponent

### ***20.2.2. Provincial***

The opening and operation of a mine triggers the environmental impact assessment and review procedure under chapter II of the Environment Quality Act (EQA). This section of the Report covers the particular regime defined by the James Bay and Northern Quebec Agreement (JBNQA). The process includes a participation by the Natives so that they can protect the rights and guarantees granted to them under the Agreement.

Under JBNQA, the James Bay Advisory Committee on the Environment (JBACE) was created for projects south of 55th parallel. To evaluate and review development projects within the jurisdiction of Québec, two other committees were created:

- The Evaluating Committee (COMEV), a Quebec / Cree / Canada agency responsible for assessing and drawing up guidelines for the impact study of projects located south of the 55th parallel.

- The Review Committee (COMEX): a Quebec / Cree agency responsible for reviewing projects south of 55th parallel.

The opening and operation of a lithium mine triggers the environmental impact assessment and review procedure under chapter II of the Environment Quality Act (EQA) regardless of the proposed exploitation tonnage. The process will include five principal steps:

- 1) Preparation and submission of a project notice to the provincial administrator.
- 2) Reception of the guidelines.
- 3) Preparation and submission of the ESIA.
- 4) Review and recommendation by the Administrator.
- 5) Delivery of the authorization.

The provincial review process will be made jointly by the Cree Authority and to the Government of Quebec for the main Certificate of Authorization, according to paragraph 164 of the LQE.

Following that, an operation certificate of Authorization must be obtained from the regional office of the MELCCFP.

### ***20.2.3. Other Permitting Requirements***

The provincial Mining Act provides the framework for the mining lease, the closure plan, and the financial guarantee associated with the closure plan. The mining lease is required to extract ore. To obtain the mining lease, a closure plan must have been submitted to the Ministry of Energy and Natural Resources and approved.

## **20.3. Environmental Studies**

An Environmental Baseline must be carried locally and regionally on various valued environmental components. They are mainly divided as:

Biophysical environment: topography, water quality, air quality, soil and rock characteristics, etc.

Biological Environment: Fauna and Flora.

Human Environment: Socio-Economical impacts and Opportunities

### ***20.3.1. Information available on the various Environment***

#### **Climate**

The region of the Property is situated in a Continental Subarctic climate (Dfc; Köppen climate classification) characterized by long cold winters and short mild summers. Mean temperatures range from -20°C in January to 16°C in July. Mean annual precipitation ranges from 51 mm in February to 106 mm in August (Mistissini; worldclimate.com). Exploration and mining activities may be carried out all year-round.

### ***20.3.2. Environment Baseline Studies that will have to be carried out***

#### **Hydrology**

The project is situated in the James Bay Watershed, Rupert River sub watershed and a more detailed watershed study will be carried out to assess the more precise direction of water and what waterbodies could be affected in the project proximity.

#### **Biological Environment: Vegetation and Wetlands**

The site is in a boreal vegetation zone, and more specifically in the continuous boreal forest subzone. The project site is also located in the spruce-moss bioclimatic domain, West sub-domain .

The main tree species present are jack pine (*Pinus banksiana*) and black spruce (*Picea mariana*). Other species are also present, but with lower densities, namely paper birch (*Betula papyrifera* var. *papyrifera*), trembling aspen (*Populus tremuloides*) and tamarack (*Larix laricina* ) Forestry roads nearby indicate logging activity in the vicinity.

Wetlands are present near the area. These are mostly open bogs, wooded bogs, ponds, marshes and shrub swamps.

There are no protected areas in the vicinity of the site.

### **Potential Endangered Wildlife**

The fauna and flora species at risk potentially present in the project area are presented in Table 18.

**Table 18: Fauna and Flora Species at Risk Potentially Present in the Project Area**

English Name	Latin Name	Québec Status	Canada Status
<b>Oiseaux</b>			
Lithiumen eagle	<i>Aquila chrysaetos</i>	Vulnerable	Not at risk
Yellow rail	<i>Coturnicops noveboracensis</i>	Threatened	Special Concern
Short-eared owl	<i>Asio flammeus</i>	ESDMV	Threatened
Narrow-billed Phalarope	<i>Phalaropus lobatus</i>	-	Special Concern
Wandering grosbeak	<i>Coccothraustes vespertinus</i>	-	Special Concern
Hirondelle rustique	<i>Hirundo rustica</i>	-	Special Concern
Harlequin Duck, Eastern population	<i>Histrionicus histrionicus</i>	Vulnérable	Special Concern
Bald Eagle	<i>Haliaeetus leucocephalus</i>	Vulnérable	Not at risk
Common Nighthawk	<i>Chordeiles minor</i>	ESDMV	Special Concern
Olive-sided Flycatcher	<i>Contopus cooperi</i>	ESDMV	Special Concern
Canada Warbler	<i>Cardellina canadensis</i>	ESDMV	Special Concern
Rusty Blackbird	<i>Euphagus carolinus</i>	ESDMV	Special Concern
Common Nighthawk	<i>Chordeiles minor</i>	ESDMV	Special Concern
Bank Swallow	<i>Riparia riparia</i>	-	Threatened
<b>Fish</b>			
Yellow Sturgeon	<i>Acipenser fulvescens</i>	ESDMV	Endangered
<b>Mammals</b>			
Woodland caribou, forest ecotype	<i>Rangifer tarandus caribou</i>	Vulnérable	Threatened
Pygmy weasel	<i>Mustela nivalis</i>	ESDMV	-
Rock vole	<i>Microtus chrotorrhinus</i>	ESDMV	-
Cooper's lemming vole	<i>Synaptomys cooperi</i>	ESDMV	-
Silver bat	<i>Lasiorycteris noctivagans</i>	ESDMV	-
Gray bat	<i>Lasiurus cinereus</i>	ESDMV	-
Red bat	<i>Lasiurus borealis</i>	ESDMV	-
Little brow Myotis	<i>Myotis lucifugus</i>	-	Endangered
Northern Myotis	<i>Myotis septentrionali</i>	-	Endangered
Eastern wolf	<i>Canis sp. cf. lycaon</i>	-	Threatened

English Name	Latin Name	Québec Status	Canada Status
<b>Plants</b>			
American Calypso	<i>Calypso bulbosa</i>	ESDMV	-
Shrub Willow	<i>Salix arbusculoides</i>	ESDMV	-
McCalla willow	<i>Salix maccalliana</i>	ESDMV	-
Pseudomontic willow	<i>Salix pseudomonticola</i>	ESDMV	-

**Note :**ESDMV : Species likely to be designated threatened or vulnerable; - : no status

### 20.3.3. Geochemical Characterization of Waste Rock, Ore.

Typical spodumene pegmatite consists of 30-40% K-feldspar, 20% plagioclase (albite), 20% quartz, 15% muscovite and 5-30% spodumene. The ore and the host rock are generally very inert for Northern Quebec lithium orebodies. This will have to be confirmed by a complete environmental geochemistry assessment, as provided in the guidelines: Guide de caractérisation des résidus miniers et du minerai, Juin 2020 by the MELCCFP.

## 20.4. Social Context

The site is located within the Eeyou Istchee Territory of the Mistissini Cree First Nation, and on the traditional trapping territories of the tallymen who live on the territory.

Vision Lithium intends to develop good relations with the Cree Nation of the Eeyou Istchee James Bay Region, and in particular the Cree Nation of Mistissini, the First Nations community whose traditional land use and economic activities may be most directly impacted by the Vision Lithium's development.

### 20.4.1. Socio-Demography

In 2021, the population of Mistissini was 3,731 inhabitants, while it was 3,523 inhabitants in 2016 (Statistics Canada, 2022a). This represents a population increase of 5.9%. The population density was 4.6 people/km<sup>2</sup>. In 2016, the average age of the population was 29.8 years (29.0 years for men and 30.5 years for women) while the median age was 26.5 years (25.4 years for men and 27.7 years for women) (Statistics Canada, 2017a). The average size of private households was 3.9 people in 2016. A total number of 670 families include a couple while 205 families are single parents. The first official language spoken is English, for both men and women, while the language most spoken at home is Cree. Of a total of 2,440 people,

1,325 have no certificate, diploma or degree, 205 have a high school diploma or equivalency certificate and 910 have a post-secondary certificate, diploma or degree.

In 2021, the population of Chibougamau was 7,233 inhabitants, while it was 7,504 inhabitants in 2016 (Statistics Canada, 2022b). This represents a population decline of 3.6%. The population density was 10.4 people /km<sup>2</sup>. In 2016, the average age of the population was 39.5 years (39.2 years for men and 39.8 years for women) while the median age was 39.8 years (39.4 years for men and 40.2 years for women) (Statistics Canada, 2017b). The average size of private households was 2.3 people in 2016. A total of 1,890 families include a couple, while 325 families are single parents. The first official language spoken is French, for both men and women. The most spoken language at home is also French. Of a total of 6,025 people, 1,535 have no certificate, diploma or degree, 1,090 have a high school diploma or equivalency certificate and 3,395 have a post-secondary certificate, diploma or degree.

In 2021, the population of Chapais was 1,468 inhabitants, while it was 1,499 inhabitants in 2016 (Statistics Canada, 2022c). This represents a population decline of 2.1%. The population density was 23.6 people /km<sup>2</sup>. In 2016, the average age of the population was 41.4 years (41.6 years for men and 41.1 years for women) while the median age was 43.8 years (44.2 years for men and 43.5 years for women) (Statistics Canada, 2017c). The average size of private households was 2.2 people in 2016. A total of 400 families include a couple while 55 families are single parents. The first official language spoken is French, for both men and women. The most spoken language at home is also French. Of a total of 1,215 people, 405 have no certificate, diploma or degree, 185 have a high school diploma or equivalency certificate and 625 have a post-secondary certificate, diploma or degree.

## **20.5. Closure Plan**

The closure plan will be developed with the required level of detail to be filed with the Provincial Impact Study.

Items in the mandatory closure plan include:

- A description of the closure activities (dismantling of infrastructures, revegetation, monitoring, etc.)
- A financial guarantee for 100% of the closure costs, including some contingency.



The main focus for the closure plan is long term water quality prediction.

As the project advances through various stages of study, a closure plan will have to be made for the future Project incorporating updated practices and regulations. This would replace the current closure plan that is currently in effect. Items in the mandatory closure plan include:

- A description of the closure activities (dismantling of infrastructures, revegetation, monitoring, etc.)
- A financial guarantee for 100% of the closure costs, including some contingency.

## **21 CAPITAL AND OPERATING COSTS**

### **21.1. Capital cost estimate**

#### ***21.1.1. Direct capital costs***

This section provides a breakdown for estimates on major capital and operating cost items for the development and operation of Vision Lithium Sirmac project.

Capital budget and production cost estimates have been based on USD converted at the exchange rate of 1.35US\$/CAN\$.

The following capital cost estimates project has an accuracy of +/-30 % for a Preliminary Economic Assessment level.

**Table 19: Capital costs**

TITLE	OWNER CAPITAL COST				
	YEAR 0	YEAR 1	YEAR 2	YEAR 3	YEAR 4
	K\$Can	K\$Can	K\$Can	K\$Can	K\$Can
SITE PREPARATION	500				
sustaining capital		25	25	25	25
UNLOADING DOCK adjacent to <i>Chantiers Chibougamau</i>	250				
sustaining capital		5	5	5	5
INFRASTRUCTURE	1000				
sustaining capital		20	20	20	20
CLOSURE COST	500				
TOTAL	2,250				
CONTINGENCY (15%)	338				
OWNER COST (5%)	225				
EPCM (5%)	112				
GRAND TOTAL	2,925	50	50	50	50

A tower radio system will have to be installed so the quarry will be in direct communication with management. That system will be supplied by the chosen contractor.

An environmental air sampling system will be installed permanently and the filters will be changed on a regular basis.

Geotechnical drilling will be done and inclinometers will be installed if required.

### **21.1.2. Indirect capital costs**

The indirect costs are the costs of temporary construction facilities and services, construction equipment, freight, insurance and engineering/procurement/construction management services.

In this project, the indirect costs include the costs associated with:

### **Project management**

Project management and procurement of all project equipment, materials and services will be carried out from Val D'Or if needed.

### **Detailed engineering**

The design will be carried out by Vision Lithium and the chosen contractor.

#### ***21.1.3. Contingency allowance***

Based on the level of development stage of the Project as well as assessment of major risks, a global contingency of 15% has been added to the CAPEX evaluation.

A contingency is an amount added to an estimate to allow for items, conditions, or events for which the state, occurrence, and/or effect is uncertain and that experience shows will likely result in additional costs. This amount covers unforeseen events, unknown or minor change in the preliminary design.

Contingency excludes:

- Major scope changes such as changes in final product specification, capacities, building sizes and location of the project;
- Extraordinary events such as major strikes and natural disasters;
- Management reserves;
- Escalation and currency effects.

#### ***21.1.4. Sustaining, owners and EPCM capital cost***

The sustaining capital costs are the capital expenditures during the life of the quarry that are to maintain or upgrade the existing asset and to continue the operation at the same level of production. In that case it is a % of the initial capital cost for each item.

For the owner's cost, we used 10% of the total initial capital cost.

For the EPCM cost, we use also 5% of the total initial capital cost. It is a low % because mostly of the EPCM work will be performed by the chosen contractor.

### **Operating cost estimate**

- Scope and methodology;
  
- The operating costs for the project were estimated annually. The operation has been divided into two (2) areas namely: contractor and client.
  
- The following table present the operating costs for the Quarry and the Shipping from the contractor and the owner.

**Table 20: Operating costs.**

	YEAR 0	YEAR 1	YEAR 2	YEAR 3	YEAR 4	TOTAL	TOTAL/mt
	K\$Can	K\$Can	K\$Can	K\$Can	K\$Can	K\$Can	K\$Can
TONNAGE MINERALIZED M.T.	-	100,000	100,000	100,000	21,000	321,000	
TONNAGE WASTE M.T.	-	130,000	307,000	307,000	129,000	873,000	
<b>OPERATING COST</b>							
CONTRACTOR	-	3,641	6,443	6,443	2,375	18,901	0.06
SHIPPING	-	6,852	6,852	6,852	1,439	21,995	0.07
GENERAL ADMIN	-	1,500	1,500	1,500	315	4,815	0.02
<b>GRAND TOTAL - BASE CASE EXW Chibougamau</b>	-	<b>11,993</b>	<b>14,795</b>	<b>14,795</b>	<b>4,128</b>	<b>45,711</b>	<b>0.14</b>
if train to port (157.17\$/m.t.)		15,717	15,717	15,717	3,301	50,452	0.16
<b>GRAND TOTAL – FOB Port Saguenay</b>		<b>20,858</b>	<b>23,660</b>	<b>23,660</b>	<b>5,991</b>	<b>74,168</b>	<b>0.23</b>

- Quarry and labor costs;
- The quarry operating cost was estimated annually and assuming it will be contracted out including the production equipment. The cost is based on operating the quarry equipment, the manpower associated with operating the equipment, the cost of fuel, generator and maintenance.
- Owner's G&A costs;
- The owner general and administration project costs include the operation of all the services, manpower and infrastructures required to support the operations.
- Transportation costs;

Supplied by the chosen contractor up to Chibougamau.

- o Quarry Utilities:
- Supplied by the chosen contractor

- Raw Material:
  - Supplied by the chosen contractor
- Other Costs:

This cost category includes building heating costs, office supplies, medical and safety equipment, telecommunications cost, waste disposal, etc. supplied by the chosen contractor.

- Royalties:

Royalties are paid by the owner or the operator of a mine to compensate for natural resources that are extracted.

In this project, royalties have been evaluated yearly as follow:

1% of the ore revenue which is: grade divided by the % spodumene concentrate taking into account the price of the spodumene concentrate and the recovery multiplied by the mineralized tonnage.

- Sales, Administration & General Management:

Selling, general and administrative expense (SG&A) is reported on the income statement as the sum of all direct and indirect selling expenses and all general and administrative expenses (G&A) of a company.

The OPEX estimate was developed using actual quotation from a contractor' prices from various sources.

## **22 ECONOMIC ANALYSIS**

### **22.1. Cautionary statement**

The results of the economic analyses discussed in this section represent forward-looking information as defined under Canadian securities law. The results depend on inputs that are subject to a number of known and unknown risks, uncertainties and other factors that may cause actual results to differ materially from those presented in the report. Information that is forward-looking includes:

- Mineral Resource estimates;
- Assumed commodity prices and exchange rates;
- Mine production plans;
- Projected recovery rates;
- Sustaining and operating cost estimates;
- Assumptions as to environmental, permitting and social risks.
- Changes to costs of production from what is assumed;
- Unexpected variations in quantity of mineralised material, grade, or recovery rates;
- Geotechnical and hydrogeological considerations during mining being different from what was assumed and was experienced in the past;
- Failure of plant, equipment, or processes to operate as anticipated;
- Accidents, labour disputes and other risks of the mining industry.

### **22.2. Financial Model Parameters**

All dollar amounts in this analysis are expressed in Canadian dollars (CAN\$), unless otherwise specified. The economic analysis includes four years of the entire project life. Corporate sunk costs to that point in time, including costs for exploration, technical studies, and permitting, are included in the initial capital. The basis of the project economic analysis is summarized in following table. Details of the capital and operating cost estimates are described in Section 21. The production schedules used for the economic analysis are described in Section 16. Metallurgical recoveries are described in Section 13.

### 22.3. Economic Analysis

The economic analysis for the overall project is summarized in the following table. The overall internal rate of return (IRR) before-tax is 839.5% with a NPV 5% of 183.6M\$. The after-tax IRR is 483.7%, and the payback (after-tax) is one year for the Qc base case. The NPV 5% after-tax is 104.8M\$.

**Table 21: Project Base Case Economic Parameters and Assumptions**

Items	Units	Values
Li <sub>2</sub> O spodumene concentrate	US\$/mt	4,100
DSO selling price	US\$/mt	591
Mining (ore*) tonnage over LoM (actual)	metric tonne	321,000.00
Royalty on sales (Owners)	%	1.00
Federal tax	%	15.00
Provincial tax	%	11.50
Mining tax	%	16.00

\*The term ore is used to simplify the table above, there is no ore in the PEA as a Preliminary Feasibility study is required to define ore.

- + The exchange rate used is US\$1:CAN\$1.35.
- + The cash flow does not take into account inflation.
- + The study does not include an escalation of commodity price during the life of the project.

The project cash flow summary of the base case\* is shown in the following table:

**Table 22: Vision Lithium Project Cash Flow Summary –Base Case Qc\* EXW Chibougamau**

Items	Value CA\$
Total revenue of sales	253,366,000
Total operating costs	45,711,000
Before-tax discounted (5.0%) NPV	183,576,500
After-tax discounted (5.0%) NPV	104,752,000

\*The base case is the product sold EXW Chibougamau.



**Table 23: Vision Lithium Project Cash Flow Summary – Mine to Port scenario FOB Saguenay**

Items	Value CA\$
Total revenue of sales	253,366,000
Total operating costs	74,168,000
Before-tax discounted (5.0%) NPV	157,903,000
After-tax discounted (5.0%) NPV	90,035,000

\*The base case is the product sold EXW Chibougamau.

### Operating Costs

The operating costs, also called operating expenditures (Opex), are expressed in CAN\$ per tonne processed, and are summarized below. This next Table outlines the costs of the total project.

**Table 24: Operating costs detailed EXW Chibougamau**

Items	Cost CA\$	Cost CA\$/t ore mined
Mine operating cost	18,901,000	58.88
Shipping quarry to Chibougamau	21,995,000	68.52
G&A	4,815,000	15.00
<b>Total</b>	<b>45,711,000</b>	<b>142</b>

**Table 25: Operating costs detailed FOB Port Saguenay**

Items	Cost CA\$	Cost CA\$/t ore mined
Mine operating cost	18,901,000	58.88
Shipping quarry to Chibougamau	21,995,000	68.52
Shipping Chibougamau to overseas	28,457,000	88.65
G&A	4,815,000	15.00
<b>Total</b>	<b>74,168,000</b>	<b>231,05</b>

**Capital cost expenditures**

The breakdown of the capital cost expenditures (Capex) and sustaining capital to materialize the study is summarized in the following table.

**Table 26: Total Capital costs for Vision Lithium project**

<b>Description</b>	<b>Cost – CAN\$</b>
<b>Sirmac project</b>	
Mine capital costs	500,000
Transfert station Dome Chibougamau	250,000
Infrastructure capital costs	1,000,000
Closure costs	500,000
Contingency (15%)	337,500
Owner cost (10%)	225,000
EPCM cost (5%)	112,500
<b>Total initial capex</b>	<b>2,925,000</b>

**The total of capex of the project whole (Chibougamau site and quarry) project is \$2,925,000.**

A minimum contingency of 15% on the initial Capex has been added even if it is a preliminary economic assessment with a +/- 30% precision.

Highlights of the Vision Lithium PEA Study:

- A project life of 4 years with the current resources;
- Project Internal Rate of Return of 483.7% after-tax base case EXW – Ex Works<sup>2</sup> Chibougamau;
- Project base case before tax Net Present Value of CAN\$184M (discounted at 5%), and after tax Net Present Value of CAN\$105M (discounted at 5%);
- Production starts at 100,000 metric tonnes of pegmatite (spodumene DS) for year 1, 2 and 3 and 21,000 metric tonnes for year 4.
- Total operating costs of CAN \$142.40 per metric tonne of mineralized pegmatite Li<sub>2</sub>O (averaged over the expected life of the quarry);
- Capex (direct and indirect costs) and sustaining capital requirements of CAN \$3.125M, where initial capex (direct) requirement is CAN \$2.925M;
- The Vision Lithium PEA was prepared as a surface extraction of mineralized material fresh rock.

---

<sup>2</sup> **EXW – Ex Works**

The seller only needs to have the goods ready for pickup. It is the buyer's job to load them onto the vehicle and take care of the rest of the transport. Once the goods are out of the seller's premises, they are no longer his concern.

**Table 27: Base Case Cash Flow — EXW Chibougamau -Québec**

Year		-1	1	2	3	4	Total
<b>PHYSICAL</b>							
Tonnage Beginning	(t)	321,000	321,000	221,000	121,000	21,000	
Ore Mined	(t)		100,000	100,000	100,000	21,000	321,000
Tonnage End	(t)	321,000	221,000	121,000	21,000	-	
Grade	%(Li2O)		1.33	1.33	1.33	1.33	1.33
Waste Mined	(t)		130,000	307,000	307,000	129,000	873,000
Total Mined	(t)		230,000	407,000	407,000	150,000	1,194,000
Strip Ratio	(t:t)		1.30	3.07	3.07	6.14	2.72
<b>Revenues</b>							
DSO selling price	(US\$/t)		591 \$	591 \$	591 \$	591 \$	591 \$
Exchange Rate	US\$:CA\$		1.35	1.35	1.35	1.35	1.35
DSO selling price	(CA\$/t)		797 \$	797 \$	797 \$	797 \$	797 \$
1% NSR Royalty	(CA\$)		797,275 \$	797,275 \$	797,275 \$	167,428 \$	2,559,253 \$
<b>Revenue</b>	<b>(CA\$)</b>		<b>78,930,229 \$</b>	<b>78,930,229 \$</b>	<b>78,930,229 \$</b>	<b>16,575,348 \$</b>	<b>253,366,035 \$</b>
<b>OPEX</b>							
Mining Operating Costs	(CA\$)		3,640,900 \$	6,442,810 \$	6,442,810 \$	2,374,500 \$	18,901,020 \$
Shipping	(CA\$)		6,852,000 \$	6,852,000 \$	6,852,000 \$	1,438,920 \$	21,994,920 \$
G&A Operating Costs	(CA\$)		1,500,000 \$	1,500,000 \$	1,500,000 \$	315,000 \$	4,815,000 \$
<b>Total Operating Cost</b>	<b>(CA\$)</b>		<b>11,992,900 \$</b>	<b>14,794,810 \$</b>	<b>14,794,810 \$</b>	<b>4,128,420 \$</b>	<b>45,710,940 \$</b>
<b>Total Operating Cost / Tonne DSO</b>	<b>(CA\$/t)</b>		<b>120 \$</b>	<b>148 \$</b>	<b>148 \$</b>	<b>197 \$</b>	<b>142 \$</b>
<b>CAPEX &amp; SUSTAINING CAPEX</b>							
Mine Capital Costs Sirmac	(CA\$)	500,000 \$	25,000 \$	25,000 \$	25,000 \$	25,000 \$	600,000 \$
Transfert station Dome Chibougamau	(CA\$)	250,000 \$	5,000 \$	5,000 \$	5,000 \$	5,000 \$	270,000 \$
Infrastructure Capital Costs Sirmac	(CA\$)	1,000,000 \$	20,000 \$	20,000 \$	20,000 \$	20,000 \$	1,080,000 \$
Closure Costs	(CA\$)	500,000 \$					500,000 \$
Sub-Total Capital Costs	(CA\$)	2,250,000 \$	50,000 \$	50,000 \$	50,000 \$	50,000 \$	2,450,000 \$
Contingency 15% on client capital cost	(CA\$)	337,500 \$					337,500 \$
Owner's cost 10% on client capital cost	(CA\$)	225,000 \$					225,000 \$
EPCM cost 5% on client capital cost	(CA\$)	112,500 \$					112,500 \$
<b>Grand Total Capital Costs</b>	<b>(CA\$)</b>	<b>2,925,000 \$</b>	<b>50,000 \$</b>	<b>50,000 \$</b>	<b>50,000 \$</b>	<b>50,000 \$</b>	<b>3,125,000 \$</b>
<b>ECONOMICS</b>							
Depreciation Pool Beginning	(CA\$)	2,250,000 \$	2,300,000 \$	1,633,489 \$	944,354 \$	213,896 \$	7,341,739 \$
Depreciation Period	(CA\$)	- \$	716,511 \$	739,135 \$	780,458 \$	213,896 \$	2,450,000 \$
Depreciation Pool End	(CA\$)	2,250,000 \$	1,583,489 \$	894,354 \$	163,896 \$	- \$	4,891,739 \$
Working Capital	(CA\$)	5,000,000 \$	- \$	- \$	- \$	(5,000,000) \$	- \$
Taxable Income	(CA\$)	- \$	66,220,818 \$	63,396,284 \$	63,354,961 \$	12,233,032 \$	205,205,095 \$
Federal Tax	(CA\$)	- \$	9,933,123 \$	9,509,443 \$	9,503,244 \$	1,834,955 \$	30,780,764 \$
Provincial Tax	(CA\$)	- \$	7,615,394 \$	7,290,573 \$	7,285,821 \$	1,406,799 \$	23,598,586 \$
Mining Tax	(CA\$)	- \$	10,595,331 \$	10,143,405 \$	10,136,794 \$	1,957,285 \$	32,832,815 \$
Total Tax	(CA\$)	- \$	28,143,848 \$	26,943,421 \$	26,925,859 \$	5,199,039 \$	87,212,165 \$
<b>Cash Flow Before Tax</b>	<b>(CA\$)</b>	<b>(7,925,000) \$</b>	<b>66,887,329 \$</b>	<b>64,085,419 \$</b>	<b>64,085,419 \$</b>	<b>17,396,928 \$</b>	<b>205,205,095 \$</b>
Pre-production CAPEX	(CA\$)	2,925,000 \$					
IRR	(%)	839.5%					
NPV 5%	(CA\$)	183,576,472 \$					
<b>Cash Flow After Tax</b>	<b>(CA\$)</b>	<b>(7,925,000) \$</b>	<b>38,743,481 \$</b>	<b>37,141,998 \$</b>	<b>37,159,560 \$</b>	<b>12,197,889 \$</b>	<b>117,992,930 \$</b>
Pre-production CAPEX	(CA\$)	2,925,000 \$					
IRR	(%)	483.7%					
NPV 5%	(CA\$)	104,797,500 \$					

**Table 28: Cash Flow Scenario FOB Port Saguenay**

Year		-1	1	2	3	4	Total
<b>PHYSICAL</b>							
Tonnage Beginning	(t)	321,000	321,000	221,000	121,000	21,000	
Ore Mined	(t)		100,000	100,000	100,000	21,000	<b>321,000</b>
Tonnage End	(t)	321,000	221,000	121,000	21,000	-	
Grade	%(Li2O)		1.33	1.33	1.33	1.33	<b>1.33</b>
Waste Mined	(t)		130,000	307,000	307,000	129,000	<b>873,000</b>
Total Mined	(t)		230,000	407,000	407,000	150,000	<b>1,194,000</b>
Strip Ratio	(t:t)		1.30	3.07	3.07	6.14	<b>2.72</b>
<b>Revenues</b>							
DSO selling price	(US\$/t)		591 \$	591 \$	591 \$	591 \$	<b>591 \$</b>
Exchange Rate	US\$:CA\$		1.35	1.35	1.35	1.35	<b>1.35</b>
DSO selling price	(CAD\$/t)		797 \$	797 \$	797 \$	797 \$	<b>797 \$</b>
1% NSR Royalty	(CA\$)		797,275 \$	797,275 \$	797,275 \$	167,428 \$	<b>2,559,269 \$</b>
<b>Revenue</b>	<b>(CA\$)</b>		<b>78,930,229 \$</b>	<b>78,930,229 \$</b>	<b>78,930,229 \$</b>	<b>16,575,348 \$</b>	<b>253,367,611 \$</b>
<b>OPEX</b>							
Mining Operating Costs	(CA\$)		3,640,900 \$	6,442,810 \$	6,442,810 \$	2,374,500 \$	<b>18,901,020 \$</b>
Shipping	(CA\$)		15,717,000 \$	15,717,000 \$	15,717,000 \$	3,300,570 \$	<b>50,451,570 \$</b>
G&A Operating Costs	(CA\$)		1,500,000 \$	1,500,000 \$	1,500,000 \$	315,000 \$	<b>4,815,000 \$</b>
<b>Total Operating Cost</b>	<b>(CA\$)</b>		<b>20,857,900 \$</b>	<b>23,659,810 \$</b>	<b>23,659,810 \$</b>	<b>5,990,070 \$</b>	<b>74,167,590 \$</b>
<b>Total Operating Cost / Tonne DSO</b>	<b>(CA\$/t)</b>		<b>209 \$</b>	<b>237 \$</b>	<b>237 \$</b>	<b>285 \$</b>	<b>231 \$</b>
<b>CAPEX &amp; SUSTAINING CAPEX</b>							
Mine Capital Costs Sirmac	(CA\$)	500,000 \$	25,000 \$	25,000 \$	25,000 \$	25,000 \$	<b>600,000 \$</b>
Transfert station Dome Chibougamau	(CA\$)	250,000 \$	5,000 \$	5,000 \$	5,000 \$	5,000 \$	<b>270,000 \$</b>
Infrastructure Capital Costs Sirmac	(CA\$)	1,000,000 \$	20,000 \$	20,000 \$	20,000 \$	20,000 \$	<b>1,080,000 \$</b>
Closure Costs	(CA\$)	500,000 \$					<b>500,000 \$</b>
Sub-Total Capital Costs	(CA\$)	2,250,000 \$	50,000 \$	50,000 \$	50,000 \$	50,000 \$	<b>2,450,000 \$</b>
Contingency 15% on client capital cost	(CA\$)	337,500 \$					<b>337,500 \$</b>
Owner's cost 10% on client capital cost	(CA\$)	225,000 \$					<b>225,000 \$</b>
EPCM cost 5% on client capital cost	(CA\$)	112,500 \$					<b>112,500 \$</b>
<b>Grand Total Capital Costs</b>	<b>(CA\$)</b>	<b>2,925,000 \$</b>	<b>50,000 \$</b>	<b>50,000 \$</b>	<b>50,000 \$</b>	<b>50,000 \$</b>	<b>3,125,000 \$</b>
<b>ECONOMICS</b>							
Depreciation Pool Beginning	(CA\$)	2,250,000 \$	2,300,000 \$	1,633,489 \$	944,354 \$	213,896 \$	<b>7,341,739 \$</b>
Depreciation Period	(CA\$)	- \$	716,511 \$	739,135 \$	780,458 \$	213,896 \$	<b>2,450,000 \$</b>
Depreciation Pool End	(CA\$)	2,250,000 \$	1,583,489 \$	894,354 \$	163,896 \$	- \$	<b>4,891,739 \$</b>
Working Capital	(CA\$)	5,000,000 \$	- \$	- \$	- \$	(5,000,000) \$	<b>- \$</b>
Taxable Income	(CA\$)	- \$	57,355,818 \$	54,531,284 \$	54,489,961 \$	10,371,382 \$	<b>176,748,445 \$</b>
Federal Tax	(CA\$)	- \$	8,603,373 \$	8,179,693 \$	8,173,494 \$	1,555,707 \$	<b>26,512,267 \$</b>
Provincial Tax	(CA\$)	- \$	6,595,919 \$	6,271,098 \$	6,266,346 \$	1,192,709 \$	<b>20,326,071 \$</b>
Mining Tax	(CA\$)	- \$	9,176,931 \$	8,725,005 \$	8,718,394 \$	1,659,421 \$	<b>28,279,751 \$</b>
Total Tax	(CA\$)	- \$	24,376,223 \$	23,175,796 \$	23,158,234 \$	4,407,837 \$	<b>75,118,089 \$</b>
<b>Cash Flow before tax</b>	<b>(CA\$)</b>	<b>(7,925,000) \$</b>	<b>58,022,329 \$</b>	<b>55,220,419 \$</b>	<b>55,220,419 \$</b>	<b>15,535,278 \$</b>	<b>176,750,021 \$</b>
Pre-production CAPEX	(CA\$)	2,925,000 \$					
IRR	(%)	726.9%					
NPV 5%	(CA\$)	<b>157,903,295 \$</b>					
<b>Cash Flow after tax</b>	<b>(CA\$)</b>	<b>(7,925,000) \$</b>	<b>33,646,106 \$</b>	<b>32,044,623 \$</b>	<b>32,062,185 \$</b>	<b>11,127,441 \$</b>	<b>101,631,932 \$</b>
Pre-production CAPEX	(CA\$)	2,925,000 \$					
IRR	(%)	418.6%					
NPV 5%	(CA\$)	<b>90,035,423 \$</b>					

## 22.4. Sensitivity Analysis for Vision Lithium project

The author are of opinion the project is a relative low risk operation as it does not require huge amount of capital and mill construction. Moreover it is a short time scale project in high commodity price thus the NPV 5% is selected.

**Table 29: Sensitivity table on %NPV calculation base case**

Base case EXW Chibougamau			
	%	Before Tax	After Tax
NPV	5	183 576 471 \$	104 797 500 \$
	6	179 799 398 \$	102 543 455 \$
	7	176 146 034 \$	100 364 103 \$
	8	172 610 963 \$	98 256 141 \$

**Table 30: Sensitivity table on selling price per tonne after tax Base case**

Selling price	(CA\$)	NPV5	IRR
	500	55 790 020 \$	266.3%
	600	72 275 588 \$	339.9%
	700	86 761 157 \$	412.9%
	797	104 797 500 \$	483.7%
	900	121 732 294 \$	558.2%
	1000	138 217 863 \$	630.6%

## 22.5. Important Caution Regarding the Economic Analysis

The Economic Analysis is preliminary in nature and includes the use of inferred mineral resources that are considered too speculative geologically to have the economic considerations applied to them that would enable them to be categorized as mineral reserves. Thus, there is no certainty that the results stated in the PEA will be realized. Actual results may vary, perhaps materially. Mineral resources that are not mineral reserves do not have demonstrated economic viability. Additional exploration work is required to increase the quality of the mineral resources.

## 23 ADJACENT PROPERTIES

### 23.1. Sirmac Property adjacent claims

*The following information of this subsection is collected after SIGEOM, the Quebec government's title management system, on December 9<sup>th</sup>, 2022.*

A great number of properties are immediately adjacent to the Sirmac Property. Within a radius of 15 kilometers around the Property, the main owners are Lithium MétauxTech Sirmac Inc., Canadian Mining House, Troilus Gold Corp. and two individuals: Glenn Griesbach and Tony Perron. **Figure 66** present an overview of the claims around the Property.

### 23.2. Other relevant information about adjacent properties

The information regarding adjacent properties is valid at the time of writing this report, collected from the spatial reference geominning information system of the Ministry (SIGEOM, consulted in December 2022). The situation may have changed and the reader should rely only upon news from the owners of the adjacent properties

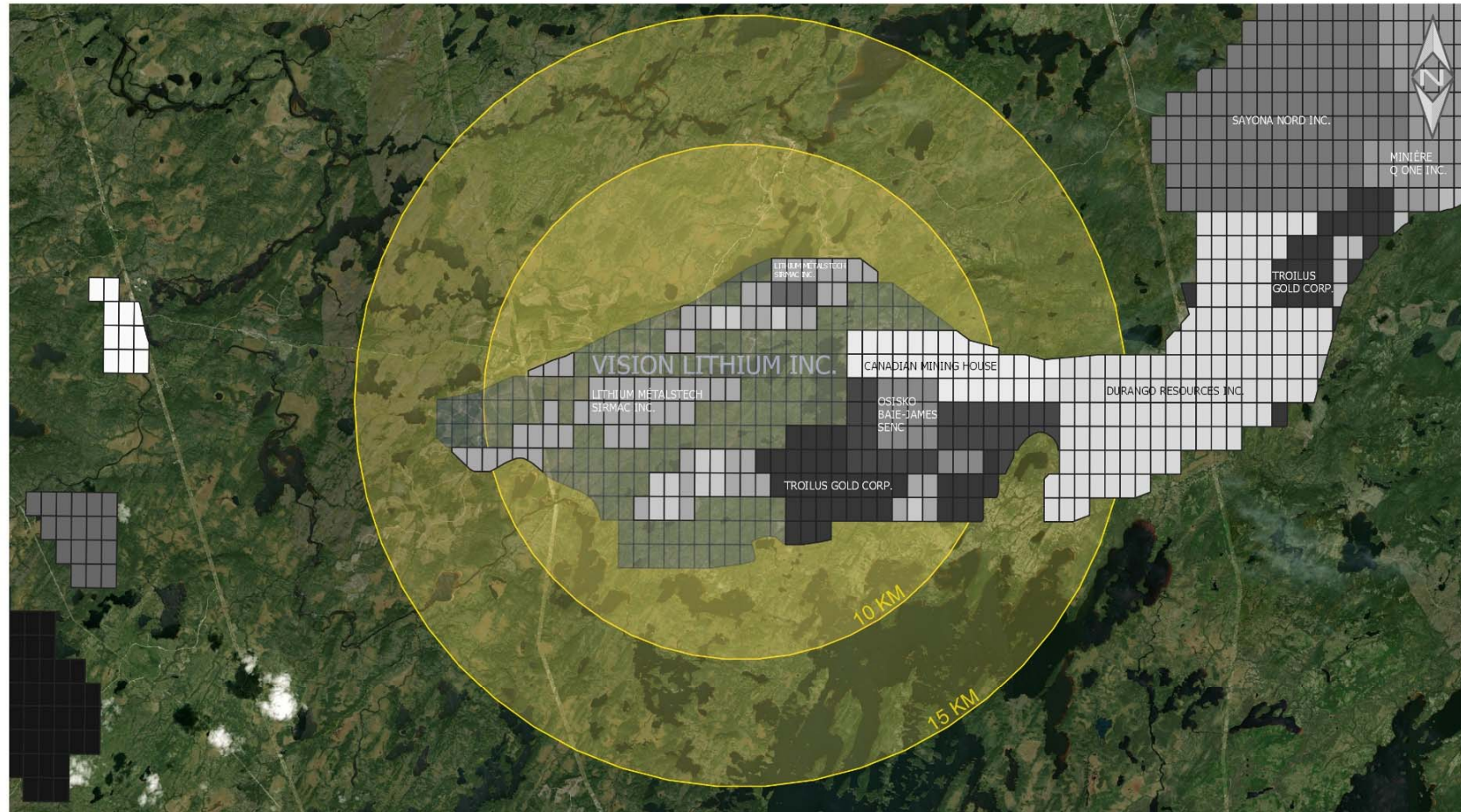

<h3>SIRMAC PROPERTY &amp; SURROUNDING CLAIMS</h3> <p>Eyouy Istchee Baie-James – Jamésie – Nord-du-Québec – Canada</p>		DRAWN by: Maude Marquis, Eng. REVISED by: Claude Duplessis, Eng. Géoservices GoldMinds Inc		
Projected coordinate system  NAD83 - UTM Zone 18 Data sources  Esri Satellite Gestion des Titres Miniers, GESTIM [claims] Vision Lithium Inc. Database		FIGURE 22-28_fig04	REV. 0	DATE 2022-12-21
		0                      5                      10                      15                      20 km		

Figure 66 – Sirmac Property and Adjacent Claims.



## **24 OTHER RELEVANT DATA AND INFORMATION**

The reader must be informed that the Dyke #5 sector of the property is not affected by the proposed protection zone of the Caribous.

All relevant data and information regarding the project at this stage have been presented and other sections of the current report.

Attention should be placed on valuation and testing of the Rubidium in the pegmatite Dyke #5 as the amount is significant and could worth more than Lithium. (Rubidium Carbonate USD6000/Kg Feb 2023). Average Rubidium on the assays is 943 ppm. More work is required to identify where the Rb is and it is not in the Mineral Resources at this stage, neither the Tantalum.

## 25 INTERPRETATION AND CONCLUSION

The Sirmac property holds potential as a lithium deposit with possibilities of tantalum secondary product. Tantalum recovery has yet to be demonstrated on the Sirmac deposit. The location of the site allows reasonable access to electricity, logistics, food supply and a qualified workforce.

NI 43-101 compliant Mineral Resources have been estimated for the Sirmac deposit and limited to an optimized pit shell and pit design constrain. The Mineral Resource comprises 192kt of measured resources at 1.38 %Li<sub>2</sub>O, 81kt of indicated resources at 1.39 %Li<sub>2</sub>O, and 49kt of inferred resources at 1.05 %Li<sub>2</sub>O. Those values are obtained using a cut-off grade of 0.50% Li<sub>2</sub>O.

The project has good grade and positive metallurgy, moreover the material is mostly above ground uphill away from creeks and lakes which makes it a favorable environment for rapid development.

**Table 31: Mineral Resources for the Sirmac Project with Li<sub>2</sub>O Cut off Grade of 0.50% (2023)**

Cut-Off Grade Li <sub>2</sub> O %	Category	Tonnage t	Average Grade Li %	Average Grade Li <sub>2</sub> O %	Average Grade TaO <sub>5</sub> %
0.50	Measured	192,000	0.639	1.375	0.0074
0.50	Indicated	81,000	0.647	1.393	0.0081
0.50	Inferred	49,000	0.487	1.049	0.0062

**\*NOTE:** The mineral resource estimate has been calculated using the Canadian Institute of Mining, Metallurgy and Petroleum (CIM) Definitions Standards for mineral resources in concordance with National Instrument 43-101 – Standards of Disclosure for Mineral Projects. Mineral resources that are not mineral reserves do not have demonstrated economic viability. Inferred mineral resources are exclusive of the Measured and Indicated resources.

Bulk density of 2.70 t/m<sup>3</sup> is used.

Effective date February 21, 2023.

\*\* Tonnage rounded to the nearest thousand.

## 26 RECOMMENDATIONS

GoldMinds suggests to proceed with all required permit for the extraction of a 50,000t bulk sample with high grade (1.82%Li<sub>2</sub>O) in sector 1 while preparing a PFS to obtain permits and a mining lease.

Vision Lithium should update the model after the bulk sample and add some drilling to fine tune the modelling to better define the mineralized dykes.

<b>WORK</b>	<b>Purpose</b>	<b>Budget Estimation</b>
<b>Bulk sample Reclamation plan</b>	Develop the property and test contractors and costs studies	\$CAD150,000
<b>PFS &amp; Mining Lease</b>	After Bulk refine model overall tonnage	\$CAD 250,000

The above amount are in the cash flow under Owner's cost and contingency costs.

## 27 REFERENCES

**NIBIISCHII CORPORATION (2021).** Réserves fauniques Assinica et des lacs Albanel-Mistassini-et-Waconichi [pdf map] (consulted on December 9th, 2022).

**BOILY, M. (1994).** Étude minéralogique préliminaire de la pegmatite lithinifère 5, Ceinture volcano-sédimentaire de Frotet-Evans. MRNF QC, GM53770.

**BRISSON, H. et al. (1997).** Géologie de la région du lac Assinica. MRNF QC, RG 96-11.

**RICHARD, L-P. et al. (2011).** Travaux de prospection 2010-2011, Propriété Sirmac, Région de la Baie-James, SNRC: 32J11. Nemaska Lithium, October 16<sup>th</sup>, 2011.

**HOCQ, M. et al. (1994).** Géologie du Québec. MRNF QC, MM 94-01.

**LAFERRIERE, A. et al (2012).** NI 43-101 Technical Report: Preliminary Economic Assessment of the Whabouchi Lithium Deposit and Hydromet Plant. Presented to Nemaska Lithium by SGS Canada Inc., BBA, Met-Chem and others, November 16<sup>th</sup>, 2012.

**LINNEN R.L. et al. (2012).** Granitic Pegmatites as Sources of Strategic Metals. Elements, vol. 8, pp. 275-280. August 2012.

**PEARSE G.H.K. (2010).** Review and Interpretation of Assessment Work on Sirmac Lake Pegmatite Project, Québec. NTS 32J11. Submitted to Guy Bourassa, Nemaska Lithium by Equapolar Consultants Limited. October 6, 2010.

**PERILYA LIMITED (2011).** Moblan Lithium Project – Significant Increase in Mineral Resources. Press Release submitted by Perilya Limited to the ASX market under JORC regulation. May 31, 2011.

**SGS Geostat (2014).** NI 43-101 Technical Report – Mineral Resources Estimation Pegmatite #5 Lithium Tantalum Deposit Sirmac Property, Québec for Nemaska Lithium Inc. January 15<sup>th</sup> 2014.

**MRB Associates (2019)** Technical Report for ABE resources Inc.

**SGS CANADA INC. (2019).** An investigation into Lithium Flowsheet Development for the Vision Lithium Sirmac Deposit, by Aghamirian, M., and Imeson, D. Prepared for Vision Lithium Inc. Project 16836-01. October 23, 2019.

End of the Technical Report.