



GENMIN

16 November 2022

Positive PFS outcome for scalable 5Mtpa mining operation at Baniaka

Low capital intensity of US\$40 per annualised production tonne results in estimated 38% after tax IRR for initial 10-year mine life

Potential for significant, further value to be unlocked through resource growth & exploration upside

Highlights

- Global Mineral Resource estimate for Baniaka increased to 760 million tonnes (**Mt**) representing just 15km (18%) of the interpreted 85km strike extent
- Detrital iron deposit (**DID**) and Soft Oxide (**SO**) Indicated Mineral Resource estimate of 168 million tonnes (**Mt**) underpin the Baniaka Preliminary Feasibility Study (**PFS**), representing only 22% of the Global Mineral Resource estimate
- Maiden DID and SO Probable Ore Reserve estimate of 101Mt provides Run-of-Mine (**ROM**) feed for an initial 10-year mine life at a 5Mt per annum (**Mtpa**) production rate
- Conventional, proven truck and shovel open pit mining operation with low-risk wet scrubbing, screening, and gravity separation ore treatment flowsheet
- ESG focus with clean, renewable hydroelectricity, no tailings dam (filter and dry stack into an engineered valley fill), and up to 0.5% of gross revenue allocated to community development
- Initial capital investment of approximately US\$200 million for 5Mtpa name plate capacity and associated infrastructure, including full ownership of strategic and dedicated power transmission line from Grand Poubara and rail loadout facility connected to the Trans-Gabon Railway near Franceville
- Average cash cost of US\$59 per dry metric tonne (**dmt**) inclusive of mine gate, road haulage, rail and port, and transshipment costs to Cape class vessels
- Positive project economics on a real, ungeared, 100% equity basis

	Pre-Tax	Post-Tax
NPV₍₈₎	US\$610M (AU\$938M)	US\$391M (AU\$601M)
IRR	45%	38%
Pay Back	-	2.7 years

Note: Based on 0.65 AU\$ to US\$

- Opportunities to enhance returns include selling a separate higher value Pellet Feed product (assumed mixed with the Fines in the PFS), and increasing scale to 10Mtpa as soon as project build debt funding permits
- Final investment decision expected in Q2-2023, however pre-development works commenced with Bond Equipment awarded US\$0.5 million first stage detailed design and engineering contract for the processing facility

African iron ore explorer and developer Genmin Limited (**Genmin** or the **Company**) (ASX: GEN), is pleased to advise the market of outstanding results from the Preliminary Feasibility Study (**PFS**) for the Company's 100% owned Baniaka iron ore project (**Baniaka**) located in Gabon, west Central Africa (Figure 1).

Genmin's Managing Director and CEO, Joe Ariti, commented: "I am delighted with the outcome of the PFS, which shows significant shareholder and stakeholder value can be realised with the development of a scalable 5 million tonne per annum mining operation at Baniaka whilst maintaining a strong focus on ESG. The financial metrics are compelling and with a modest initial capital investment, and operating hydroelectricity, rail and port infrastructure, this initial phase of monetising the province scale Baniaka asset is highly feasible."

"Pivoting from the PFS, our target is to achieve first production in mid-2024. To this end, we will be supporting Anglo American in finalising its due diligence and negotiating documentation in respect of debt financing and offtake, completing the social and environmental impact assessment by the end of the year, and lodging a large-scale mining permit application. Concurrently, we also plan to complete several pre-development work streams like the detailed design and engineering of the processing facility that is already underway."

"Finally, I would like to thank our small, but highly motivated and talented Genmin team who delivered the PFS. This outcome would not have been possible without their extraordinary efforts."

The PFS examined the development of a scalable 5Mtpa, truck and shovel, shallow, free dig contract open pit mining operation over an initial 10-year mine life to produce greener, high value-in-use Lump and Fines iron ore products. ROM DID and SO ore is beneficiated through a simple, low risk wet ore treatment flowsheet comprising scrubbing, screening and gravity separation.

Finer spiral circuit discard is filtered, added to coarse rejects and placed in an engineered valley fill storage facility. The Company has designed a solution that does not require a wet tailings storage facility, which is consistent with its ESG values.

The Project is based on leveraging off access to existing regional hydropower, rail and port infrastructure. This meant that only a power transmission line and connecting transport infrastructure from Baniaka to the Trans-Gabon Railway (**TGR**) needed to be considered in respect of engineering design and funding. Ranking several scenarios (truck haulage and rail spur either Company or third party financed) through impact on net present value showed, at 5Mtpa, road haulage to a new load out rail terminal located near Franceville was the best outcome. Consequently, the initial phase of Baniaka will be executed via road haulage to the TGR, with the construction of a rail spur deferred to a later date.

At steady state, Baniaka is expected to employ up to 400 people and over the life of this initial mining phase, contribute US\$602 million to Gabon in production royalties (US\$206 million) and corporate income tax (US\$396 million).

Pursuant to Gabon's Mining Code, 20% of State production royalties are invested in the local community, and in addition Genmin has set aside up to 0.5% of gross revenue for Company administered community development programmes.

Full detail of the PFS Mineral Resources, Ore Reserves, capital and operating costs, financial metrics, sensitivity analysis, project delivery and operations, and opportunities and risks are set out in the attached Executive Summary.

This announcement has been authorised by the Board of Directors of Genmin.

For further information, please contact:

Joe Ariti

Managing Director & CEO

Genmin Limited

T: +61 8 9200 5812

E: admin@genmingroup.com

Alex Cowie

Investor Relations

NWR Communications

M: +61 412 952 610

E: alexc@nwrcommunications.com.au

Follow GEN



About GENMIN

Genmin Limited (ASX: GEN), is an ASX-listed African iron ore exploration and development company with a pipeline of projects in the Republic of Gabon, west Central Africa. The Company has a 100% interest in three (3) projects comprising six (6) granted exploration licences covering approximately 5,064km².

Genmin's Baniaka and Bakoumba projects are located in south-east Gabon near the provincial city of Franceville, where the Company has an extensive footprint and controls all acreage prospective for iron ore. The Baniaka and Bakoumba projects represent an iron ore hub with 2,445km² of landholding and 121km of iron mineralised strike with only 13% drill tested with diamond drilling.

Genmin's flagship project, Baniaka, is at feasibility stage with defined JORC Code (2012 Edition) Mineral Resources and Ore Reserves and is favourably situated adjacent to existing and operating bulk commodity transport and renewable energy infrastructure.



Figure 1: Baniaka location and infrastructure

Forward-looking Statements

This announcement contains certain "forward-looking" statements. Forward-looking statements can generally be identified by the use of forward-looking terminology such as "anticipate", "estimate", "forecast", "believe", "expect", "potential", "intend", "aim", "will", "plans", "could", "should", "may", "likely" or other similar expressions. Forward-looking statements are not guarantees of future performance, and involve known and unknown risks, uncertainties and other factors which are subject to change without notice and may involve significant elements of subjective judgement and assumptions as to future events which may or may not be correct, which may cause the Company's actual results or performance to differ materially from those expressed or implied by such statements.

Neither the Company nor any other person gives any representation, warranty, assurance or guarantee that the occurrence of the events expressed or implied in any forward-looking statement will occur. Except as required by law, none of the Company, its related bodies corporate or their directors, officers, employees, advisors or agents or any other person will in any way be liable to any person for any loss, claim, demand, damages, costs or expenses of whatever nature arising in any way out of, or in connection with, the information contained in this announcement.

Genmin shareholders are cautioned not to place undue reliance on forward-looking statements, which speak only as at the date they are made. The forward-looking statements in this announcement are based on information available to the Company as at the date of this announcement. Except as required by law, the Company is under no obligation to update or revise any forward-looking statements in this announcement or to provide any additional or updated information whether as a result of new information, future events or results or otherwise.

Competent Persons Statement

The information in this announcement that relates to estimates of Mineral Resources is based on, and fairly represents, information compiled by Mr Richard Gaze who is a Member of the Australasian Institute of Mining and Metallurgy (**AusIMM**). Mr Gaze is a full-time employee of WSP Golder and Associates Pty Ltd (**WSP Golder**) and has sufficient experience relevant to the style of mineralisation and type of deposit under consideration and to the activity being undertaken to qualify as a "Competent Person" as defined in the 2012 edition of the "*Australasian Code for Reporting of Exploration Results, Minerals Resources and Ore Reserves*" (**JORC Code**). Mr Gaze consents to the inclusion in this announcement of the matters based on his information in the form and context in which it appears.

The information in this announcement that relates to estimates of Exploration Targets is based on, and fairly represents, information compiled by Dr Karen Lloyd who is a Fellow of the AusIMM. Dr Lloyd is a part-time employee of Genmin and holds performance rights over shares that have vesting conditions related to Baniaka. Dr Lloyd has sufficient experience relevant to the style of mineralisation and type of deposit under consideration and to the activity being undertaken to qualify as a "Competent Person" as defined in the JORC Code. Dr Lloyd consents to the inclusion in this announcement of the matters based on her information in the form and context in which it appears.

The information in this announcement that relates to estimates of Ore Reserves is based on, and fairly represents, information compiled by Mr Allan Blair who is a Member of the AusIMM. Mr Blair is a full-time employee of WSP Golder and has sufficient experience relevant to the style of mineralisation and type of deposit under consideration and to the activity being undertaken to qualify as a "Competent Person" as defined in the JORC Code. Mr Blair consents to the inclusion in this announcement of the matters based on his information in the form and context in which it appears.

JORC Table 1

Reporting criteria for the estimates of Exploration Targets, Mineral Resources and Ore Reserves at Baniaka is set out in the *JORC Code Table 1 Checklist of Assessment and Reporting Criteria* (**JORC Table 1**) located at Appendix 1 in the attached PFS Executive Summary.



**Baniaka
PFS**

Executive Summary.

16 November 2022



GENMIN

Contents

Introduction.....	3
Sources of Information	3
PFS Objectives.....	4
Property Ownership & Description	5
Work History	8
Geology.....	9
Mineralisation Styles.....	11
Detrital Iron Deposits.....	11
Soft Oxide Mineralisation.....	12
Intact Oxide Mineralisation	12
Primary Mineralisation	12
Mineral Resource Estimates	12
Exploration Targets.....	13
Ore Reserve Estimate and Mining	14
Metallurgy and Processing	16
Market Assessment.....	18
Social and Environmental Impact Assessment.....	19
Flora & Fauna	20
Local Population.....	21
Infrastructure and Logistics.....	22
Power Supply and Transmission	22
Non-Process Infrastructure and Accommodation Village.....	23
Rail and Port.....	26
Project Delivery and Operations.....	29
Project Delivery	29
Operations	29
Capital and Operating Costs	29
Capital Costs.....	29
Operating Costs	30
Economic Analysis.....	31
Discount Rate.....	32
Commodity Prices	34
Government and Community Contributions and Income Tax	34
Sensitivity Analysis	37
Opportunities and Risks	39
Conclusions and Recommendations.....	40
Conclusions	40
Recommendations	40
Appendix 1: JORC Table 1.....	41
Section 1 – Sampling Techniques and Data	41
Section 2 – Sampling Reporting of Exploration Results.....	47
Section 3 – Estimation and Reporting of Mineral Resources.....	51
Section 4 – Estimation and Reporting of Ore Reserves.....	65

List of Tables

Table 1: Ore types included for each PFS Prospect.....	3
Table 2: Third party technical consultants and specialists for PFS	4
Table 3: Summary of Baniaka Tenure.....	7

Table 4: Baniaka Global Mineral Resource Estimate – September 2022.....	13
Table 5: Baniaka Ore Reserve Estimate 1 November 2022	14
Table 6: Summary of signed Memoranda of Understanding for product offtake	18
Table 7: Capital Costs Estimates.....	30
Table 8: Operating Costs Estimates per dry metric tonne of product sold.....	31
Table 9: Considered development scenarios	31
Table 10: Production statistics	32
Table 11: Discount Rate Calculation	32
Table 12: Financial metrics.....	33
Table 13: Key performance metrics	33

List of Figures

Figure 1: Baniaka location and regional infrastructure.....	5
Figure 2: Northern Access Road terminating at Tsengué Base Camp (background)	6
Figure 3: Catering staff working in the kitchen at Tsengué Base Camp	7
Figure 4: Core library at Tsengué Base Camp	8
Figure 5: Reminac geologist logging core at Baniaka.....	9
Figure 6: PFS Prospects	10
Figure 7: Simplified schematic section.....	11
Figure 8: Bandjougoy Section 321785E (looking east).....	13
Figure 9: Practical pit designs	15
Figure 10: Production Schedule.....	16
Figure 11: Block flow diagram of the proposed flowsheet	17
Figure 12: FFMES & IRET conducting fish density and identification surveys	20
Figure 13: Local school children at Boumango 30km from Baniaka	21
Figure 14: Aerial view of the Grand Poubara Hydroelectric Power Station.....	22
Figure 15: Processing facility and mine General Arrangement.....	24
Figure 16: Accommodation village General Arrangement	25
Figure 17: Loading of Nouvelle Gabon Mining manganese onto the Trans-Gabon Railway	26
Figure 18: Owendo Mineral Port.....	27
Figure 19: OMP Phased Development Master Plan Summary	28
Figure 20: Life of Mine cashflows	33
Figure 21: Pricing Profile	34
Figure 22: Local students from the technical school in Moanda, near Franceville	35
Figure 23: Reminac plumber working at Tsengué Base Camp	35
Figure 24: 2019 Mining Code obligations.....	36
Figure 25: Company sponsored community development funding.....	37
Figure 26: Pre-Tax NPV (US\$M) Sensitivity Analysis	38
Figure 27: Post-Tax NPV (US\$M) Sensitivity Analysis	38
Figure 28: Tornado Chart (Contribution to NPV Variance by Input).....	39

Introduction

This Executive Summary presents the results of a Preliminary Feasibility Study (**PFS** or the **Study**) conducted on the Baniaka iron ore project located in the Republic of Gabon, west Central Africa (**Baniaka** or the **Project**). Baniaka is 100% owned by Ressources Minières d’Afrique Centrale Gabon SA (**Reminac**), a wholly owned subsidiary of Genmin Limited (either **Genmin**, **Reminac** or the **Company** henceforth), an Australian public company listed on the Australian Securities Exchange.

The Project comprises granted exploration licences G2-537 (**Baniaka Licence**) and G2-572 (**Baniaka West**) covering a total area of 881km² in the Haut-Ogooué province, approximately 45km south of the provincial city of Franceville.

Baniaka has a defined cumulative strike length of 85km of iron mineralisation, divided into 12 prospect areas (Figure 6). The PFS includes four (4) of the prospect areas, which are shown in Table 1 (**PFS Prospects**). Also shown in Table 1 are the ore types at each PFS Prospect included in the Study.

Table 1: Ore types included for each PFS Prospect

PFS Prospects	Ore Type
Flouflou	Detrital iron deposits (DID)
Bandjougoy	DID and Soft Oxide (SO)
Tsengué	DID and SO
Bingamba North	DID

The lower mineralised horizons at the PFS Prospects, the other prospects at Baniaka, together with Genmin’s portfolio of additional mineral assets in Gabon, offer longer term opportunities for iron and base metals exploration and development, and are excluded from the PFS.

The PFS examines the development of a scalable 5 million tonnes per annum (**Mtpa**), truck and shovel, shallow, free dig contract open pit mining operation at Baniaka, over an initial 10-year mine life to produce greener, high value-in-use (**VIU**) Lump and Fines iron ore products. For the PFS, the Pellet Feed fraction is assumed blended with the Fines rather than sold as a separate product.

Run-of-Mine (**ROM**) DID and SO material will be beneficiated through a simple, low risk wet ore treatment flowsheet comprising scrubbing, screening, and gravity separation. To achieve the modest initial capital investment, the Company has leveraged off access to existing regional hydropower, rail and port infrastructure. This meant only a power transmission line and connecting transport infrastructure (**Connecting Infrastructure**) from Baniaka to the Trans-Gabon Railway (**TGR**) needed to be considered in respect of engineering design and funding.

Ranking several Connecting Infrastructure scenarios (truck haulage, rail spur either Company or third party financed) through impact on net present value (**NPV**) showed, at 5Mtpa, road haulage to a new load out rail terminal located near Franceville was the best value outcome. Consequently, the initial phase of mining operations at Baniaka will be executed via road haulage to the TGR, with the construction of a rail spur deferred to a later date.

Sources of Information

The PFS was coordinated and compiled by Genmin based on technical and commercial assessments completed by third party consultants and specialists as outlined in Table 2.

Table 2: Third party technical consultants and specialists for PFS

Third party	Assessment Area
WSP Golder (formerly Golder Associates Pty Ltd) (WSP Golder), Perth, Australia, Johannesburg, South Africa & London, UK	<ul style="list-style-type: none"> Mineral Resource estimates Ore Reserve estimates Mine design and scheduling Process rejects and waste rock storage Ground and Surface Water Social & Environmental Impact Assessment (SEIA)
Bond Equipment (Bond), Klerksdorp, South Africa	<ul style="list-style-type: none"> Pilot scale metallurgical test work and process design
Central South University (CSU), Hunan, China	<ul style="list-style-type: none"> Pilot scale pyrometallurgical and VIU test work
TEREA (TEREA), Marseille, France & Libreville, Gabon	<ul style="list-style-type: none"> Environmental and social baseline data collection
Flora Fauna & Man Ecological Services (FFMES), Tortola, British Virgin Islands	<ul style="list-style-type: none"> Biodiversity baseline data collection
Institut de Recherche en Ecologie Tropicale (IRET), Gabon	
Bigen Group (Bigen), Pretoria, South Africa	<ul style="list-style-type: none"> Mine infrastructure, rail, roads, power supply and transmission
PRDW, Cape Town, South Africa	<ul style="list-style-type: none"> Port and shipping
Agemar UK Ltd (Agemar)	<ul style="list-style-type: none"> Marine operations
FTI Consulting (FTI), Perth, Australia	<ul style="list-style-type: none"> Financial modelling

The legal, project implementation, macroeconomic assessments and marketing components of the Study were completed by Genmin. Capital and operating cost estimates were sourced from industry specialists or obtained from third party quotations where necessary.

Mr Richard Gaze and Mr Allan Blair, full time employees of WSP Golder are the Competent Persons for the Mineral Resource and Ore Reserve estimates in accordance with the *Australasian Code for Reporting of Exploration Results, Mineral Resources and Ore Reserves 2012 edition (JORC Code)*.

Dr Karen Lloyd, the Company's Chief Strategy Officer is the Competent Person for the Exploration Targets in accordance with the JORC Code.

The production targets for Baniaka referred to in this PFS Executive Summary are based on 100% Probable Ore Reserves. The Mineral Resource and Ore Reserve estimates underpinning the production targets have been reported by a Competent Person in accordance with the requirements of the JORC Code.

PFS Objectives

Reminac commenced work on the PFS in the second half of 2021. The PFS tests the technical and commercial optionality to support a mining operation producing 5Mtpa of iron ore over an initial mine life of at least ten (10) years.

Mined ore will be beneficiated using standard washing, gravity and Dense Media Separation (**DMS**) processes to produce Lump, Fines and Pellet Feed iron ore products, which will be exported to global markets via an existing rail and port infrastructure solution. This infrastructure comprises the TGR and the Owendo Mineral Port (**OMP**), which is located approximately 21km south of the capital city of Libreville, at Port Owendo (Figure 1).

The Study considers several options relating to the use of this infrastructure, including truck haulage to a railhead near Franceville or a 65km rail spur connecting Baniaka to the TGR. The Company has been successful in negotiating Memoranda of Understanding (**MoU**) for access to rail and port facilities, and additionally, renewable power via the Grand Poubara Hydroelectric Power Station (**Grand Poubara**). The 20-megawatt (**MW**) power requirement will be supplied from excess capacity at Grand Poubara, which is approximately 40km north and downstream of Baniaka, via a purpose built 63kV overhead transmission line (**OHTL**).



Figure 1: Baniaka location and regional infrastructure

Property Ownership & Description

Baniaka is located approximately 45km south of Franceville, the third largest city in Gabon, which has a population of approximately 120,000 people. The principal road access to Franceville is via highways RN1 then RN3 from the capital city of Libreville, a distance of 730km. Franceville is also the railhead at the end of the TGR.

The Mvengué international airport (**Mvengué**) located between Moanda and Franceville is serviced daily by domestic flights from Libreville. The Company’s owned and established Tsengué Base Camp (**TBC**) is the main facility supporting exploration at Baniaka. The Project is directly accessible by vehicle from Mvengué to TBC

(approximately 75km) via a sealed road and then a northern unsealed access road (**Northern Access Road**) (Figure 2). Local labour and professional services are sourced from Franceville and nearby Moanda, supported by Reminac expatriate staff, consultants and contractors when required. Reminac manages field work at Baniaka from TBC, which is capable of accommodating approximately 130 people (Figure 3).

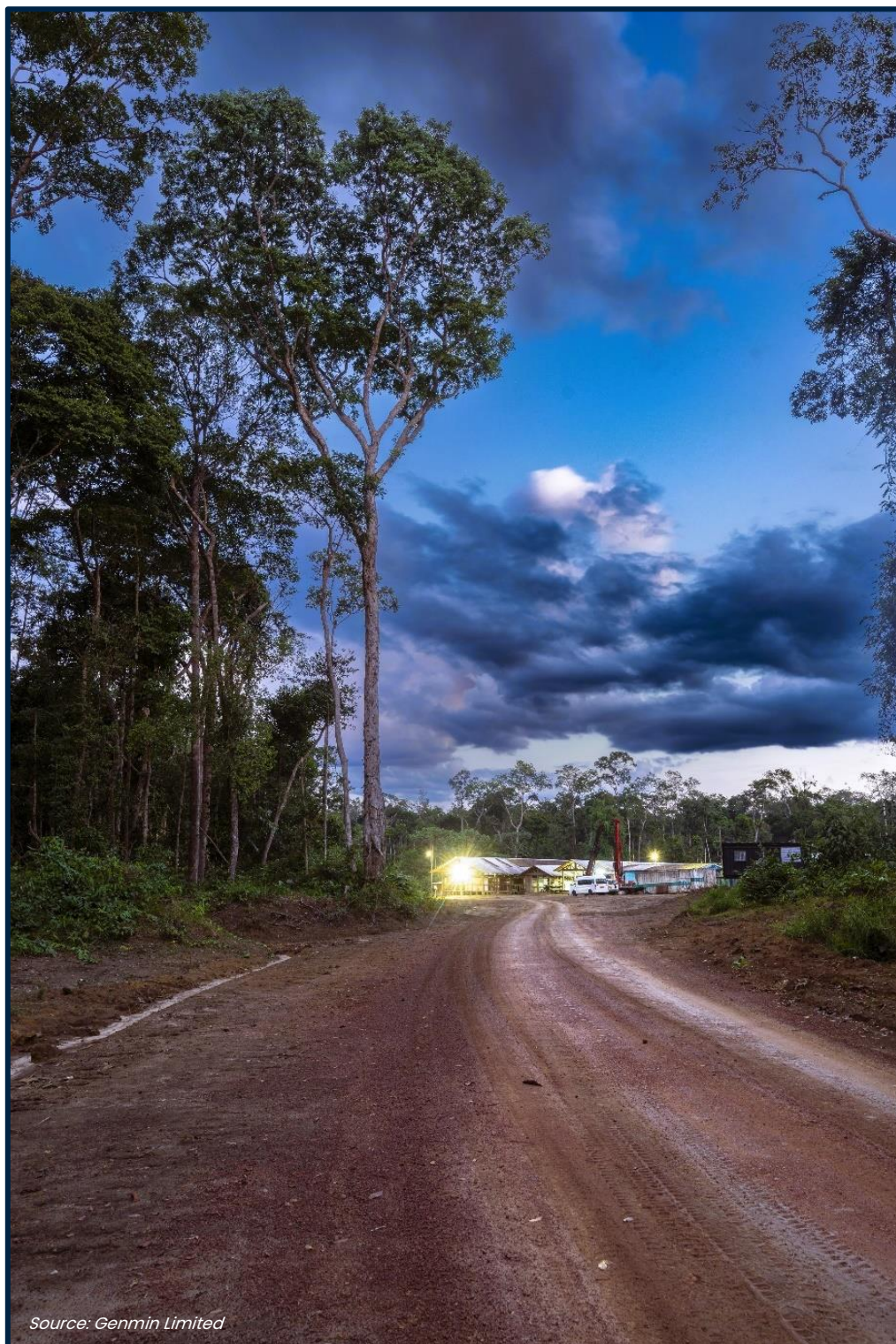

Figure 2: Northern Access Road terminating at Tsengué Base Camp (background)



Source: Genmin Limited

Figure 3: Catering staff working in the kitchen at Tsengué Base Camp

Table 3 provides a summary of Baniaka’s tenure. Both exploration licences allow exploration for iron mineralisation. A large-scale Mining Permit Application (**MPA**) in Gabon must be supported by both a feasibility study, and SEIA approved by the Direction Générale of Environment and the Protection of Nature (**DGEPN**). The Terms of Reference (**ToR**) for the SEIA were finalised following a visit to Baniaka by DGEPN in February 2022 and approved in July 2022. This approval authorised the commencement of baseline studies and associated stakeholder engagement programmes. This work programme was largely complete by November 2022 and the SEIA is on-track for submission to DGEPN before the end of 2022. The DGEPN approval process is expected to take three (3) months following submission. Genmin does not foresee any material impediments to the granting of a Mining Permit for Baniaka in accordance with its development timeline.

Table 3: Summary of Baniaka Tenure

Exploration Licence	Registered Holder	Location	Area (km ²)
G2-537, Baniaka	Reminac	Gabon	774
G2-572, Baniaka West	Reminac	Gabon	107

Several rivers cross the Project area with the largest, the M’baniaka River, crossing the Baniaka Licence from the south-west to the north-east. Other than the M’baniaka River, there are no material climatic or topographic impediments to field work at the Project, which experiences a tropical savanna climate (Köppen climate

classification). This is characterised by a long wet season (between October and May) and a short dry season (between June and September). The average total annual rainfall is 1,850mm. The average daily temperature is typically between 27 and 31 degrees year-round, with overnight minimum temperatures typically between 18 and 20 degrees year-round.

Work History

Limited exploration for iron mineralisation was carried out in the area prior to Reminac being granted the Baniaka Licence in late 2012. In the 1970's, Compagnie Minière de l'Ogooué (**COMILOG**) conducted a pitting program on two (2) traverses at what is now known as the Bingamba South and CP31 prospects (Figure 6). COMILOG also drilled three (3) diamond holes and conducted metallurgical magnetic separation tests on the diamond drill core. The Baniaka West area was included in a regional airborne magnetic survey, which highlighted two (2) magnetic anomalies along an east-west strike within the licence area. Reminac and its consultants have completed significant exploration on the Project since 2013.

The Company has completed over 44,000m of drilling at Baniaka (Figures 4 and 5), which has focused on estimating the grade and continuity of the iron mineralisation and progressing towards project development. This work has included geological mapping, processing and interpretation of airborne magnetic and radiometric geophysical data, the acquisition of ground magnetic geophysical data and ultra-ground penetrating radar data, reconnaissance and bulk density pitting and trenching, resource definition drilling, bulk metallurgical test work, and Mineral Resource estimation. The PFS supports the maiden Ore Reserve estimate.

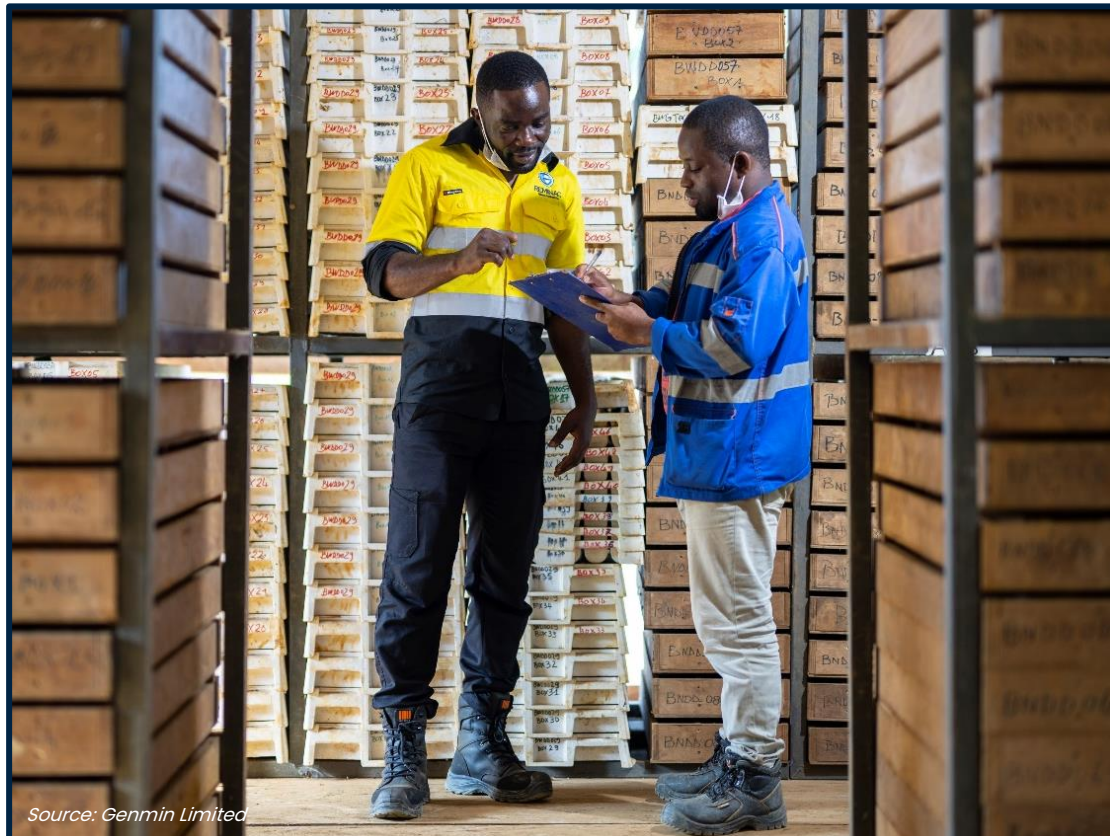

Source: Genmin Limited

Figure 4: Core library at Tsengué Base Camp

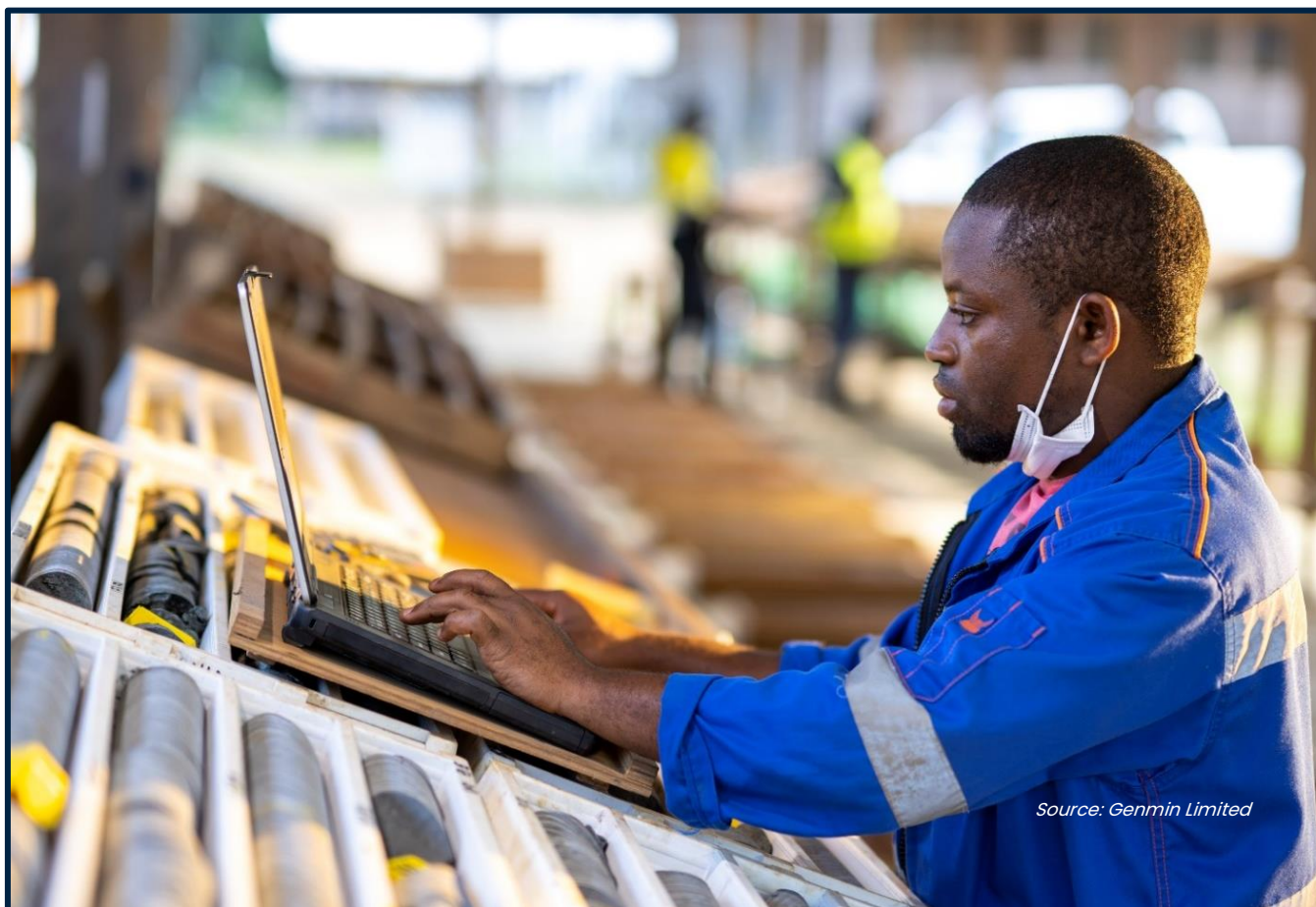

Source: Genmin Limited

Figure 5: Reminac geologist logging core at Baniaka

Geology

Gabon is geologically situated at the north-western margin of the Congo Craton. The oldest rocks in Gabon are Archaean basement that are divided between the Chaillu Massif and North Gabon Massif. In central, western, and south-eastern Gabon, the Archaean basement is overlain by Palaeoproterozoic sediments and a Phanerozoic sedimentary cover. Baniaka is located within the Chaillu Massif, where the Archaean basement comprises granitoids and gneisses with greenstone belts consisting of metasediments and metavolcanics including amphibolites, quartzites, micaceous schists and banded iron formation (**BIF**). Iron mineralisation at Baniaka is associated with an eluvial and/or colluvial accumulation of iron-rich fragments derived from erosion of the underlying iron-enriched BIF units (DID), oxide BIF (SO and Intact Oxide (**Oxide**)), and primary BIF (**Primary**)). The DID and Oxide BIF are enriched in iron compared to the Primary, with in-situ grades of 40–50% Fe and 40–45% Fe, respectively, and 33% Fe for the Primary.

Geological mapping and geochemical sampling confirmed the presence of BIF coincident with two (2) curvilinear magnetic trends with a cumulative strike length of approximately 85km spanning the Baniaka and Baniaka West licences (Figure 6). The BIF units are hosted in, and concordant with, felsic schists and para-gneisses with lesser amphibolite occurrences. Primary iron mineralisation is present as magnetite. The BIF units, wall rocks and early granitoids have been metamorphosed and have undergone multiple phases of deformation. Two (2) early phases of deformation show plunging, tight to isoclinal folds, boudinage structures and shearing. Two (2) later phases of deformation comprising open to gentle folding are also recognised. The metamorphic grade is Lower Amphibolite

Facies. Occasional felsic intrusives have been identified locally at the Tsengué and Bingamba North prospects and are interpreted to be sills sub-concordant with the BIF.

Faulting has been identified using interpretation of ground magnetics and topography, and subsequently verified by diamond drilling. The fault network of the PFS Prospects is well defined and pervasive, however faults have minor offsets of less than 15m. Younger brittle faulting, possibly related to the formation of the Francevillian basin to the north, and late undeformed dolerite dykes cross-cut the BIF units and wall rocks.

The southern BIF has been subdivided into working prospect areas, which comprise the PFS Prospects from west to east Flouflou, Bandjougoy, Tsengué, and Bingamba North (Figure 6). Extending beyond the PFS Prospects, the Bingamba South, and Bambono prospects comprise the southern extension and limit of the southern BIF trend. The northern arcuate trend comprises from east to west the Lendzoubi, Kopa, and Ngaila prospects, and the eastern extension of the northern trend includes the Ndzaki prospect and is partly overlain by the younger sedimentary formations of the Francevillian Group.

Oxide and Primary mineralisation at Bingamba North, Bingamba South, Bambono, and all prospects that comprise the northern BIF are excluded from the PFS.

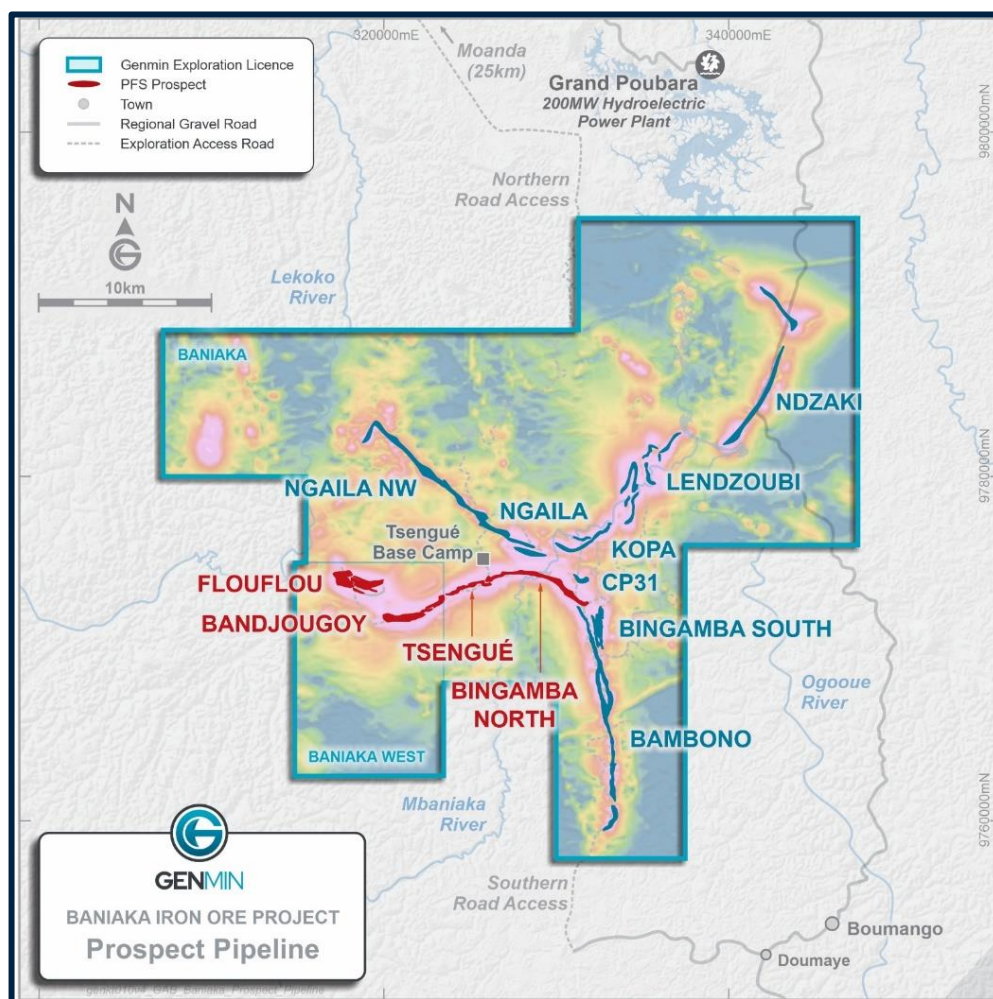

Figure 6: PFS Prospects

The Project area has been subject to intense tropical weathering, resulting in the progressive leaching of silica from fresh rock, which in turn leads to volumetric reduction and enrichment or accumulation of minerals that are stable

and resistant to weathering processes. Ferro-silicate minerals (amphiboles and phyllosilicates) have been progressively oxidised to residual clay mineral assemblages. Primary magnetite associated with the BIF units has been progressively oxidised to maghemite, martite and hematite with subordinate goethite as proximity to ground surface, and intensity of weathering increases.

The combined effects of volumetric reduction of the in-situ BIF coupled with progressive oxidation of magnetite to hematite has led to the formation of a series of weathering zones each with distinct characteristics, that are enriched in iron and depleted in gangue minerals and impurities to various extents. These weathering zones are closely related to the styles of iron mineralisation encountered at the Project.

Mineralisation Styles

Four (4) styles of iron mineralisation are noted at Baniaka, each typically found in layers that are sub-parallel to dominant topographic features and constrained by the up-dip projection of the Primary BIF (Figure 7).

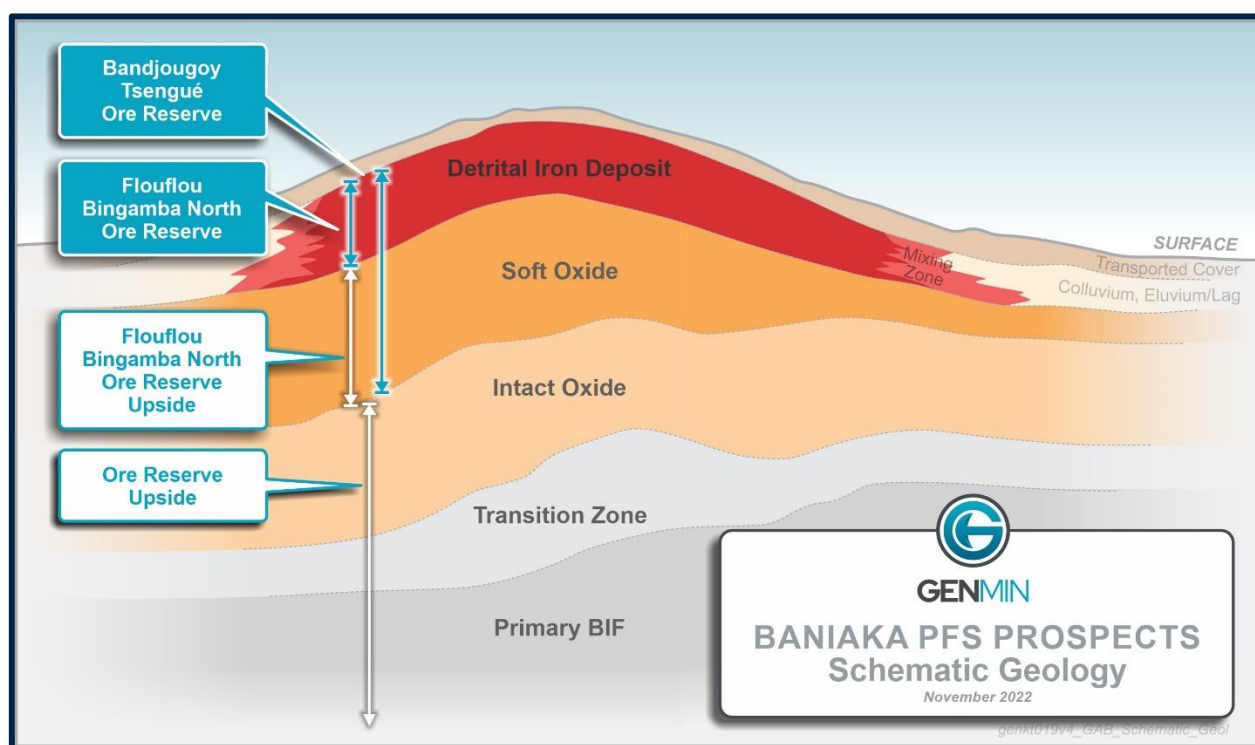

Figure 7: Simplified schematic section

Detrital Iron Deposits

The DID comprises a blanket of iron-rich, BIF-derived gravels and their cemented duricrust equivalents. The DID results from the oxidation and disaggregation of the underlying BIF with limited transportation and typically directly overlie or immediately flank the BIF and are interpreted as a residuum. The DID is predominantly comprised of particles of enriched BIF that range in size from coarse sand (0.5–1mm) to pebbles (4–65mm) with minor coarser and finer fractions. DID is characterised by a high Lump fraction (40–50% >6.3mm) and low magnetic susceptibility. DID thickness ranges from 1 to 16m, with the thickest accumulations occurring at Bandjougoy (Figure 6). DID is typically flanked by iron-poor, non-BIF derived gravels termed lateritic colluvium. The mixing zone between DID and lateritic colluvium is known as Hybrid (**HYB**). The DID mineralisation does spread laterally beyond the surface projection of the underlying BIF due to lateral dispersion associated with weathering.

Soft Oxide Mineralisation

Oxide material directly underlies the DID and corresponds to the in-situ weathered portion of the BIF. Oxide mineralisation is therefore effectively constrained by the hanging wall and footwall contacts of the BIF. The Oxide extends from the base of the DID to depths of up to 70m below the natural surface. The upper portion of the Oxide is a soft, sandy to friable hematite-dominant weathered rock that has been enriched in iron by both accumulation and supergene enrichment, and has low magnetic susceptibility. The SO occurs with thicknesses from 15 to 45m, averaging approximately 30m.

Intact Oxide Mineralisation

The lower portion of the Oxide is referred to as Intact Oxide, which is a texturally preserved, banded to massive, weathered rock that features some preserved silica and ferro-silicates, with iron mineralisation present as hematite-martite-maghemite. The Intact Oxide is typically thinner than the SO, ranging from 5 to 25m thick, averaging 15m thick, and has moderate magnetic susceptibility.

Primary Mineralisation

Underlying the Oxide mineralisation, the Primary BIF is comprised of fresh BIF with a thin transitional zone at the base of the Intact Oxide, where magnetic susceptibility is slightly less than the Primary BIF. The Primary BIF is characterised by strong to very strong magnetic susceptibility, with magnetite being the dominant iron oxide. Gangue minerals are silica present as quartz, and ferro-silicate minerals. The true thickness of the BIF ranges from 50m up to 250m at Bandjougoy, with an average thickness of approximately 150m.

Mineral Resource Estimates

WSP Golder has been retained by the Company since 2017 to prepare and report Mineral Resource estimates (**MRE**) for Baniaka. WSP Golder and the Company consider these estimates to be reasonable global estimates, which have been reported to a sufficient quality standard under the JORC Code reporting guidelines and other relevant regulatory framework.

The methodology adopted for estimation of the Mineral Resources comprised exploratory data analysis, definition of modelling domains, geological modelling, geostatistical analysis, block, grade and density modelling and classification. Geological models were created with Seequent Leapfrog software using the geological logging and assay data supplemented by drill section and plan interpretations. WSP Golder reviewed and validated the resultant wireframe models with the Company prior to undertaking resource estimation. Statistical and geostatistical analyses were carried out on data composited to 1m and 2m downhole intervals for Auger and diamond drill sample, respectively, and constrained to stratigraphic units. Variography was modelled using an omnidirectional variogram employing unfolding to account for topographic and strike trends, as necessary.

The Ordinary Kriging interpolation method was used for the estimation based on variogram parameters defined from geostatistical analyses. The variogram parameters from the mineralised units were used to estimate the non-mineralised units. Grade estimation was carried out for Fe, SiO₂, Al₂O₃, P, S, LOI¹⁰⁰⁰, CaO, MgO, Mn, Na₂O, K₂O and TiO₂. A typical cross-section through an estimation model is presented in Figure 8.

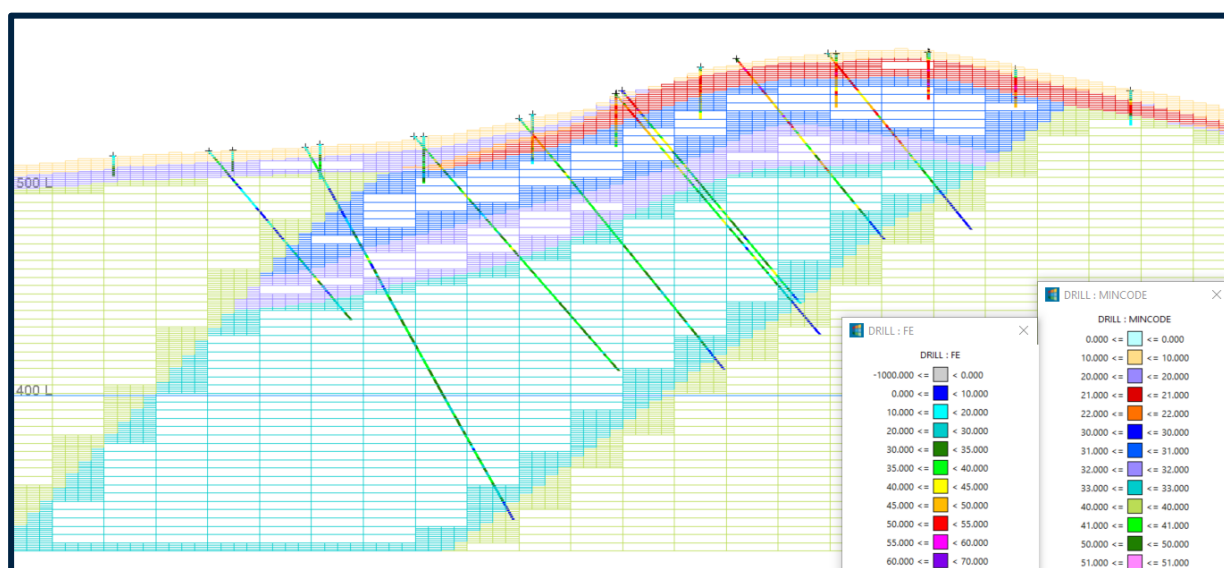

Figure 8: Bandjougoy Section 321785E (looking east)

Reasonable Prospects of Eventual Economic Extraction were assessed by WSP Golder using an open pit optimisation study with GEOVIA Whittle™ software (**Whittle**). The Global MRE for Baniaka was updated as part of the PFS and is presented in Table 4. The DID and SO Indicated MRE used to inform the PFS are highlighted in the dark teal rows, and total 167.7Mt.

Table 4: Baniaka Global Mineral Resource Estimate – November 2022

Class	Material	Tonnes (Mt)	%					LOI ¹⁰⁰⁰
			Fe	SiO ₂	Al ₂ O ₃	P	S	
Indicated	DID	67.1	47.4	15.9	8.0	0.072	0.076	7.5
	Soft Oxide	100.6	43.1	29.1	3.9	0.058	0.054	4.5
	Intact Oxide	61.5	37.0	39.0	3.2	0.059	0.052	3.1
	Total	229.2	42.8	27.9	4.9	0.063	0.060	5.0
Inferred	DID	5.8	41.8	21.3	10.2	0.067	0.071	7.3
	Soft Oxide	15.9	43.7	31.4	2.7	0.055	0.031	2.9
	Intact Oxide	19.3	36.7	42.1	2.6	0.057	0.033	2.0
	Primary BIF	488.6	33.5	44.5	2.3	0.058	0.084	1.2
	Total	529.6	34.0	43.7	2.4	0.058	0.081	1.4
Grand Total		758.7	36.7	38.9	3.2	0.059	0.074	2.5

Notes:

- Reported tonnes are rounded.
- Mineral Resources are inclusive of Ore Reserves.

Exploration Targets

Reminac notes a relationship between the true BIF thickness, BIF dip and BIF horizontal thickness with the presence and extent of DID and Oxide mineralisation at Baniaka. The Company has updated its Exploration Targets to accommodate the revised MRE. The Exploration Target estimates were previously reported in the Company's

Prospectus dated 9 February 2021 (**Prospectus**). Supporting technical information relating to the Exploration Target is summarised in the Independent Geologist’s Report (**IGR**) on the Mineral Assets of Genmin Limited, prepared by SRK Consulting (Australasia) Pty Ltd (**SRK**) and dated January 2021. SRK’s IGR is included in the Prospectus. In the Competent Person’s opinion, the Exploration Target estimates reported for Baniaka are acceptable as a reasonable representation of the grade and tonnage ranges and have been prepared to a sufficient quality standard under the guidelines set out in the JORC Code.

The following updated Exploration Targets developed by Reminac for Baniaka are exclusive of the Global MRE:

- **DID:** 28–51Mt at 43–54% Fe
- **Oxide:** 228 – 424Mt at 35–49% Fe
- **Primary:** 1,780 – 3,306Mt at 31–39% Fe

The potential quantity and grade given in the Exploration Target estimates are conceptual in nature. There has been insufficient exploration to estimate a Mineral Resource and it is uncertain if further exploration will result in the estimation of a Mineral Resource.

Ore Reserve Estimate and Mining

WSP Golder was engaged to prepare and report the Ore Reserve estimate, which is supported by the PFS. WSP Golder completed a series of open pit mining studies comprising pit optimisation, strategic scheduling, detailed LOM and pit stage designs, detailed scheduling and cashflow evaluation of the Project’s capital and operating costs to establish the technical merits and economic viability of the Project as the basis for statement of Ore Reserves under JORC Code reporting guidelines (Table 5).

Table 5: Baniaka Ore Reserve Estimate – November 2022

Classification	Ore Type	Tonnes (Mt)	%					LOI ¹⁰⁰⁰
			Fe	SiO ₂	Al ₂ O ₃	P	S	
Probable	DID	45.5	48.2	15.3	7.7	0.07	0.07	7.4
	HYB	2.1	35.9	25.8	12.9	0.06	0.07	8.6
	Soft Oxide	53.2	46.2	24.6	3.7	0.06	0.07	4.9
Total		100.9	46.9	20.4	5.7	0.06	0.07	6.1

Notes:

- Estimate totals may vary reflecting the level of rounding accuracy applied.
- Variable cut-off grades have been estimated on a block value basis. Break-even cut-offs for average grade material by ore type have been estimated at the rate of 29% Fe for DID, 29% Fe for HYB and 25% Fe for Soft Oxide.
- The Mineral Resource estimate includes HYB under DID category, while the Ore Reserve reports according to material type DID, HYB and Soft Oxide. Ore Reserves are a sub-set of Mineral Resources.
- Dilution and ore loss has been incorporated by block model regularisation at 5mN x 5mE x 4mRL to yield average mining dilution of 2% and mining recovery of 94%.
- Capital and operating costs have been estimated from a variety of reputable sources as outlined herein. Initial capital costs are estimated at \$258 million with sustaining capital US\$238 million over the 11.5-year LOM, incurred at the rate of US\$1.74/t rock mined. Operating costs totalling US\$3,642 million over the LOM have been based on average unit ore mining costs US\$3.77/t ore, waste mining costs US\$4.30/t rock, process costs US\$2.95/t ore, G&A cost US\$2.22/t ore, average product transport cost US\$43.65/t product, technical services US\$0.78/t ore, rehabilitation cost US\$0.26/t waste. Additional operating costs are incorporated for stockpile/reclaim cost of US\$5.1 million, clearing and grubbing of US\$12.9 million and bulk rejects disposal of US\$91.2 million (based on \$US2/t dry tailing).
- Selling costs are incurred at the rate of 7.5% government royalty, up to 1% royalty to Anglo American, US\$15/t product for shipping and insurance.
- Revenue prices are based on the long term average AME pricing as at September 2022 for the period 2023 to 2033.
- Revenue price penalties are applied consistent with S&P IODEX Platts 62.5% product specifications.
- Revenue price premiums are applied at VIU credit for Fines at the rate of 17% and the market premium for Lump.

Open pit optimisation studies were performed using industry standard software Whittle 4X. The optimal Whittle shell extends approximately 15km in strike length (Figure 9). The Revenue Factor equal to 1 (RF=1) pit denoting base price assumptions was chosen for the optimal shell and subsequently confirmed as the optimum net present value shell by strategic scheduling and by comparing with the optimum net present value at 90% of the difference between Best Case (shell by shell mining) and Worst Case (bench by bench mining) scenarios.

The optimal pit mines 140Mt at a strip ratio of 0.21 (Waste to Ore) and an average processed Fe grade of 45.5%. The RF=1 pit provides an optimal balance between extracting maximum reserves using a conventional open cut truck and shovel fleet and reducing waste tonnage. For shells larger than the RF=1 pit, the C1 cost (cost of mining and processing ore) and the stripping ratio increases. Practical pit designs were completed based on the RF=1 Whittle shell (Figure 9). Phase designs were completed to provide a practical mine design and aid in the creation of the production schedule. The larger areas were split into phases approximately 1km in length. Each phase design incorporates appropriate twin access ramps and a mining strategy that provides for both in-pit and ex-pit haulage of ore and waste.

Main haul roads were designed at 25m wide to accommodate two-way traffic for a Caterpillar 777 haul truck. Road widths of 15m have been designed for lower levels to minimise waste stripping and maximise ore extraction. Switchbacks have been designed to an inner radius of 25m and a minimum mining width of 20m has been implemented.

Waste rock encountered while mining is to be used for the construction of mine haul roads and embankments. Specific requirements for haul roads and embankments were outlined through a trafficability assessment conducted by WSP Golder, to manage the Loess material and provide design parameters for road pavements. Haul roads have been designed to a 10% gradient. Cut and fill is required to optimise haulage and trafficability in the undulating terrain. Additionally, a surface water assessment conducted by WSP Golder identified areas requiring embankments to prevent encroachment of water into the mining areas.

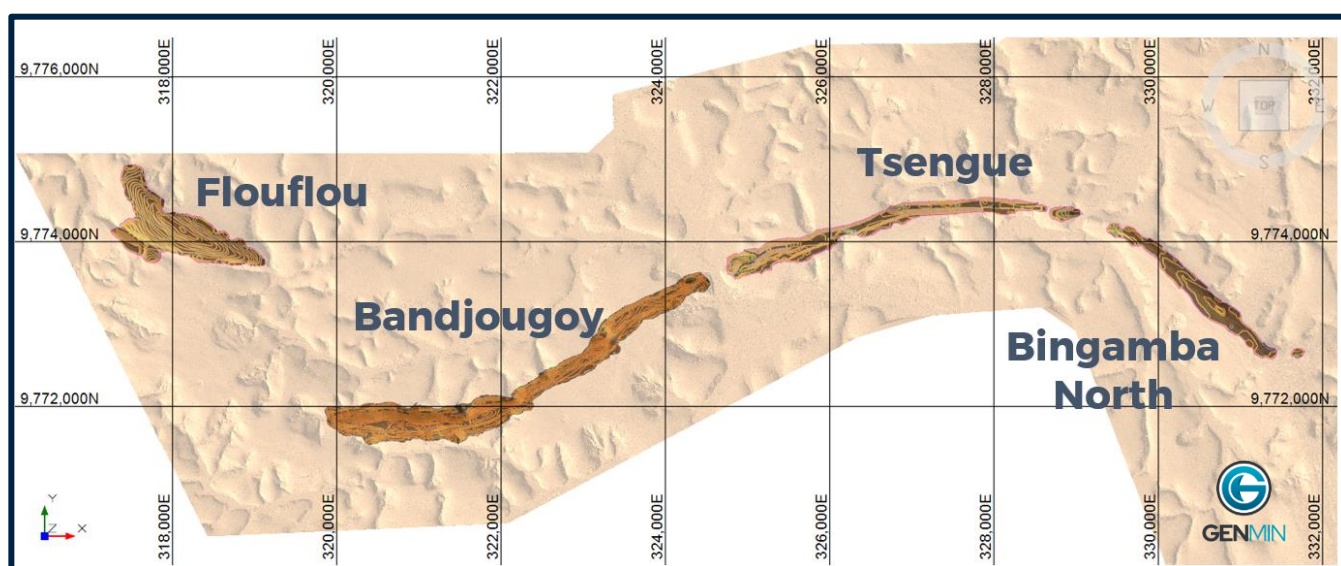

Figure 9: Practical pit designs

WSP Golder designed waste rock dumps (WRDs) for each mining area. The WRDs have been designed with embankments composed of colluvium and bedrock material to contain Loess material and to maximise efficiency in haulage, avoid sterilisation of future resources and prevent risk of collapse due to height and integrity issues surrounding the Loess material.

The production schedule was produced in Minemax Scheduler Software. The schedule considered Ore Reserves only for processing. The mining schedule provides a balance between the desired marketing strategy and optimisation of the NPV and Ore Reserve base. Mining was targeted at a relatively constant rate with priority being given to feeding the processing facility to deliver 5Mtpa of product. Over the LOM, ROM ore production averages 9.2Mtpa. Total movement ramps up progressively over the LOM as further waste stripping is required to access ore. Total ore mined amounts to 100.9Mt at 46.9% Fe grade. Processing throughput varies to achieve the 5Mtpa product target. Early periods see the schedule consume higher grade and yield material to bring forward higher value ore (Figure 10). Total product tonnes amount to 55.3Mt, with 17.1Mt (30.9%) of Lump, 22.5Mt (40.7%) of Fines, and 15.7Mt (28.4%) of Pellet Feed.

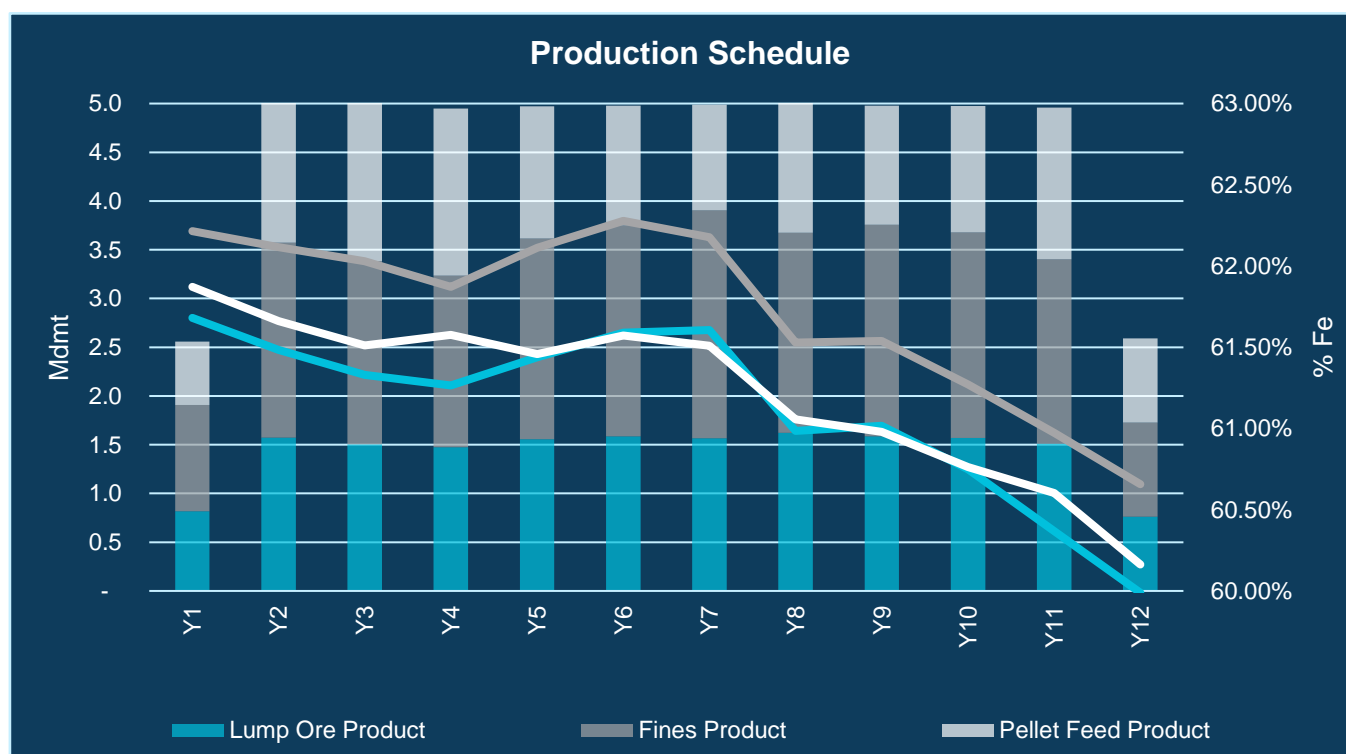

Figure 10: Production Schedule

Metallurgy and Processing

Bond was engaged by the Company to perform pilot scale metallurgical and process test work for the Study. The proposed ore treatment flowsheet was informed by the results of iterative bench scale metallurgical test work campaigns. Approximately 20t of bulk sample material from the PFS Prospects was shipped from Baniaka to Klerksdorp in South Africa for pilot scale flowsheet confirmation at Bond’s test facilities in early February 2021 (**Bond Test Work**).

The Bond Test Work included gravity-based separation processing methods such as DMS and spirals.

Lump (-32+6mm) and Fines (-6+0.5mm) products were produced. Generally, iron grades were higher than the earlier bench scale test work and the Platts 62% Fe CFR North China benchmark. Mass yields were in line with earlier test work.

Iron grades ranged from 63.6 to 65.4%, with overall mass yields between 55.5 and 65.3%. Average DID Lump and Fines yields were 26 and 36% respectively for an overall average yield of 62%.

The design envelope was determined from the Bond Test Work. Washability data was generated from this characterisation test work, which was then used to derive grade-yield curves for the various samples. This information together with the other test work data (such as particle size distribution, percentage slimes, etc) was used to develop a comprehensive mass balance and process design criteria. The overall mass balance and process design criteria were used to dictate the processing facility throughput and equipment sizing to achieve the product tonnage target of 5Mtpa. The final product quality ranges were also determined from the mass balance for the various material types tested. The Bond Test Work indicated that it was possible to meet or better the benchmark 62% Fe industry product grade with typical alumina and silica grades.

The processing facility comprises a standard ore treatment flowsheet including a feed preparation section, which includes primary and secondary crushing, scrubbing and size classification; a beneficiation section comprising of four (4) x DMS modules, a spiral separation module, products and rejects handling (thickening and filtration prior to stacking in a valley fill storage facility), and water recovery and process water circuit (Figure 11).

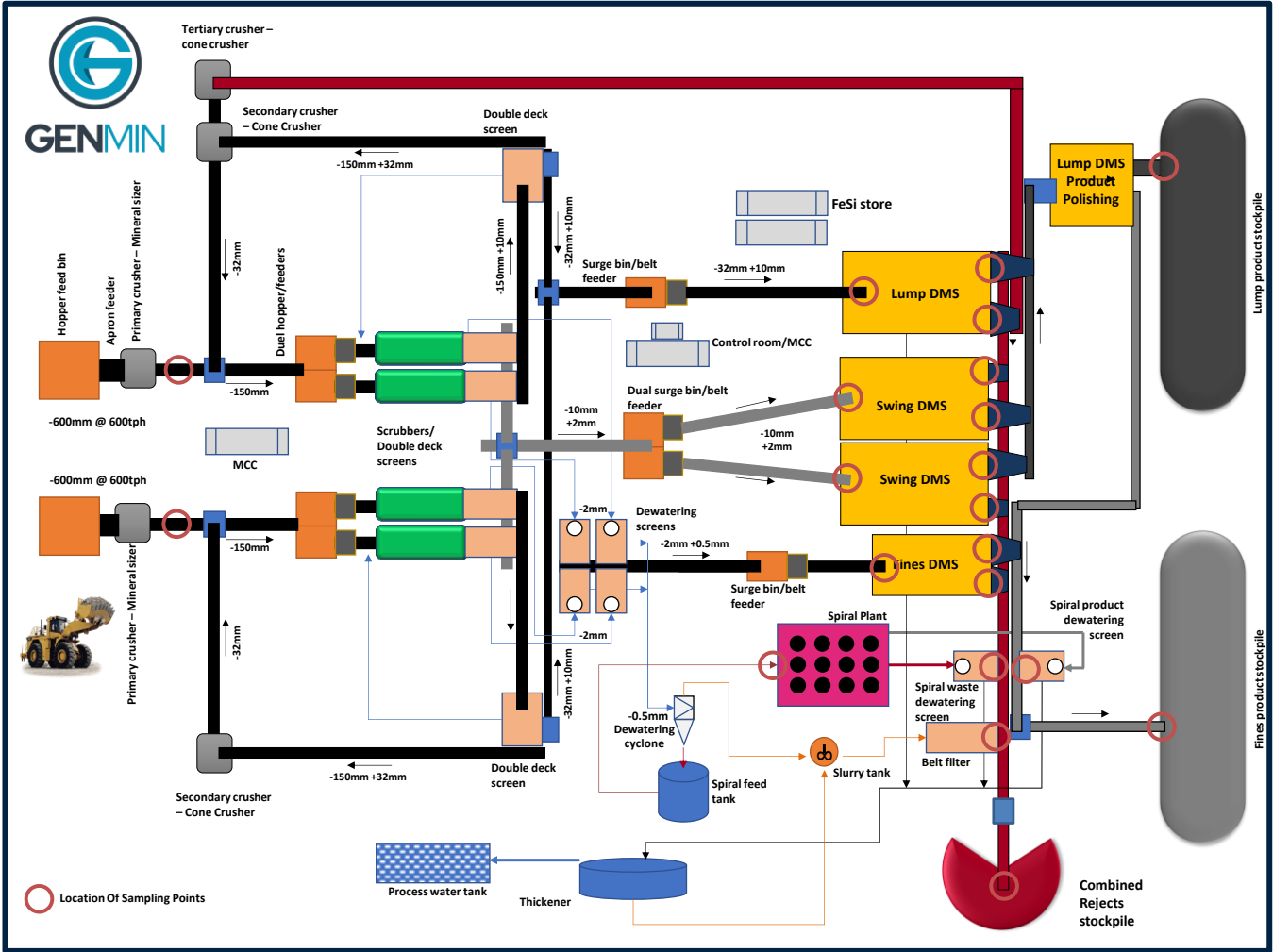

Figure 11: Block flow diagram of the proposed flowsheet

Market Assessment

Independent physical, chemical, metallurgical, and financial assessments of a composite Lump and a composite Fines product from the Bond Test Work was completed by CSU.

The work undertaken by CSU comprised a first phase of metallurgical characterisation of Baniaka Lump, a second phase of Sintering test work on Baniaka Fines and a final phase of VIU modelling.

CSU concluded that Baniaka Fines and Baniaka Lump have a potentially significant value with both products having high iron grade, low silica and alumina, with very low levels of other deleterious elements and alkali metals. Metallurgically, Baniaka Lump has excellent thermal stability and reducibility, while Baniaka Fines not only delivers high iron grades and low deleterious elements but improves Sintering efficiency with a 12.5% increase in productivity and 8.6% lower solid fuel consumption when substituting for some Australian Fines and Brazilian Fines currently used in Sinter feed blends. As such, CSU estimated Baniaka Fines is expected to receive up to a 17% price premium in the market resulting from its superior VIU qualities, and Baniaka Lump is estimated to be priced in line with the normal Lump premium. Subsequent to the CSU VIU assessment, one (1) of the proposed offtakers listed in Table 6 independently confirmed Sintering efficiency and productivity of Baniaka Fines.

Pivoting from the CSU VIU conclusions, Genmin has now signed a total of three (3) non-binding MoU for Baniaka offtake, which are summarised in Table 6.

Table 6: Summary of signed Memoranda of Understanding for product offtake

Entity	Term	Iron Ore Products (Mtpa)			Extension (Mt)
		Fines	Lump	Total	
Jianlong ¹	2 years	1.5	0.5	2.0	4.0
Minmetals ²	3 years	1.5	0.5	2.0	6.0
CDSS ³	3 years	1.5	0.5	2.0	6.0
Total		4.5	1.5	6.0	16.0

Notes:

¹ Jianlong Group

² China Minmetals Corporation

³ Changzhou Dongfang Special Steel

The key terms of the MoU were announced to the ASX on the 15 December 2021 and 12 January 2022. The MoU are non-binding, and each of Jianlong, Minmetals, and CDSS respectively, and Genmin will use all reasonable endeavours to enter into legally binding offtake agreements by 30 June 2023. Pricing for iron ore products will be determined by reference to the Platts Iron Ore Index or another agreed price index.

In July 2022, Genmin granted Anglo American Marketing Limited (**AAML**) an exclusivity period from the delivery of the PFS to conduct confirmatory due diligence, and negotiate and agree legally binding documentation for the provision of up to US\$75 million of funding for Baniaka, and an offtake agreement for up to 100% of iron ore products from Baniaka. In the event AAML was successful in agreeing terms for offtake with Genmin, the MoU with the Chinese parties set out in Table 6 would fall away, and it is expected they would become customers of AAML enabling access to the Baniaka products.

In March 2022, Reminac provided AAML with an approximately 80kg composite sample of Pellet Feed from the Bond Test Work to assess pelletising characteristics. Notably, the test work was undertaken on an intermediate rather than final product. Genmin engaged CSU to provide its opinion on the AAML pelletising test work. CSU concluded the following:

- Baniaka Pellet Feed is likely to be suitable as direct reduction pellet feed material given its material characterisation and favourable agglomeration properties.
- The impurity content of the Pellet Feed concentrate is low, and it has good “ballability”. The compressive strength of the unfired pellets is far greater than the required minimum strength for commercial production.
- The reduction process strength is high, and the low temperature reduction disintegration index is very good.
- The compressive strength of the fired pellets (4,000N) is approximately 1.5 times greater than that required for commercial pelletising. The drum strength is also very good.

AAML concluded milled Baniaka Pellet Feed concentrate can yield pellets with exceptional physical properties, and acceptable metallurgical and chemical properties for Blast Furnace iron making.

The Company is encouraged by these test results and will work to assess the value proposition offered by selling a separate Pellet Feed, and potentially producing pellets at Baniaka.

Social and Environmental Impact Assessment

A large-scale MPA in Gabon must be supported by both a feasibility study and an approved SEIA. The Baniaka SEIA is scheduled for submission to the DGEPN in late 2022 following the completion of a comprehensive baseline assessment and stakeholder engagement programme. This assessment was completed under the oversight of WSP Golder by Gabon based TERA and the internationally renowned biodiversity consultancy FFMEs. SEIA approval is expected in April 2023.

In accordance with the regulatory framework of the laws of the Republic of Gabon, Reminac presented its ToR including social and environmental studies to the DGEPN in June 2022. The ToR was prepared in line with the DGEPN’s draft review and subsequent recommendations and set out the proposed content of Genmin’s social and environmental baseline data collection program, and subsequent impact assessment. The final ToR accommodating DGEPN’s feedback and recommendations was approved, and therefore Reminac and its consultants FFMEs and TERA (under the direction of WSP Golder) commenced study work at Baniaka. Chemical, mineralogical, and water analyses have not identified concentrations of any potential acid or contaminant forming elements such as sulphur in sulphides, or their weathering by-products. The ToR approved by the DGEPN also includes the requirement for engagement with key stakeholders, and the development of a social licence to operate. Reminac is advancing in engagements with these stakeholders. Further to discussions and feedback from the DGEPN, Reminac does not have any reason to believe that the required environmental permits and social licence to operate for the planned mining and processing operation will not be granted should it continue to comply with its approved ToR.

Once submitted, the SEIA will include an overview of the obligations in Gabon, a technical description of the Project, the SEIA status of the Project area including sensitive receptors and an inventory of vulnerable fauna, strategies to mitigate impacts and enhance benefits, an analysis of Project alternatives and design strategies and, comprehensive social and environmental management plans including a conceptual mine closure plan.

Flora & Fauna

A landscape level biodiversity assessment was completed over an area of 1,622km² in both the dry season and wet season in 2022 (Figure 12). The study area encompassed the proposed 354km² MPA area, and the total projected disturbance footprint for mining, processing and ancillary facilities is estimated at 3.9km². While this is only a small proportion of the study area, the large-scale study area provided good baseline data from a range of habitats and allowed information on ecological connectivity to be quantified. This is particularly relevant to the scoping of offset programmes designed to secure net positive outcomes for vulnerable species.



Figure 12: FMES & IRET conducting fish density and identification surveys

Overall, 357 plant taxa were recorded with no endangered species identified and with the vulnerable large hardwood tree known as Okoume (*Aucoumea klaineana*) having the highest frequency.

A total of 39 mammal species were recorded with notable species including the Western Lowland Gorilla, African Forest Elephant, Central Chimpanzee, and White Bellied Pangolin. None of the 252 confirmed bird species (comprising 66% forest dependent and 24% open savannah species) were threatened but the Crowned Eagle and the Dja River Scrub Warbler were species of note.

A total of 24 reptile species (one (1) terrapin, one (1) crocodile, eight (8) lizards and 14 snakes) and 35 amphibians (all frogs) were confirmed. Of these the crocodile and one (1) frog species (*Cardioglossa annulate*) were notable.

While assessment continues on invertebrates and fish, both groups had high levels of species richness. As well as minimising disturbance, Baniaka will progressively rehabilitate disturbed areas to recreate habitat consistent with mine closure planning.

Local Population

While the mine site area is unpopulated, Genmin is committed to improving the quality of life of nearby communities through the provision of employment and social support programmes (Figure 13). A baseline assessment of key social metrics including livelihoods, diversity, disability, community health and education was undertaken in parallel to an ongoing engagement process to assist with the scoping of social support programmes, which will be defined in the final SEIA.



Source: Genmin Limited

Figure 13: Local school children at Boumango 30km from Baniaka

The Project will implement effective stormwater, erosion and fuel handling and storage processes to prevent adverse impact on the quality and flow of this water. No adverse impact on river hydrology or water quality is expected on the downstream river system, including on the Grand Poubara Dam and this will be confirmed via an ongoing water quality and aquatic biodiversity assessment programme with routine reporting to DGEPN.

The main air quality challenge for the Project will be preventing the generation of nuisance dust from the mining, processing and ultimate transportation of iron ore products. These are essentially non-toxic and non-carcinogenic products that with wet processing should not generate significant dust.

Baniaka is located in largely undeveloped closed woodland, which stretches for about 30km to the north-west along an existing access road which broadly follows the future transport corridor. This road then passes through a security gate before traversing the nearby sugar plantations of Sucrierie Africaine du Gabon (**Sucaf-Gabon**), enroute to Franceville. A large area of forest covered by a Rougier logging permit and with no access roads into Baniaka defines the Western boundary of the Project. There is a footbridge but no road bridge across the M'baniaka

River to the south where the landscape is comprised of a mosaic of savannah and woodland. The prevention of hunting by the Project workforce is a high priority as is the exclusion of outside hunting to protect vulnerable wildlife.

Infrastructure and Logistics

Power Supply and Transmission

Société de Patrimoine (**SdP**), a Gabonese State-Owned power generation entity, runs several hydro power stations across the country. Grand Poubara has been identified as the main power supply for the Project (Figure 14). Grand Poubara was built by Sinohydro in 2016 and is located approximately 35km north north-east from Baniaka, on the Ogooué River.



Figure 14: Aerial view of the Grand Poubara Hydroelectric Power Station

Grand Poubara has an installed capacity of 160MW and has significant excess capacity with only two (2) of the four (4) turbines operating at any given time. It supplies COMILOG’s metallurgical facility as well as the town of Moanda.

In April 2022, Reminac entered into a MoU with SdP for power supply to Baniaka and has reserved 30MW of capacity. At the time of publishing the PFS, Genmin was finalising the conversion of the MoU to a 20-year long form commercial agreement. The average power cost is estimated to be less than US\$0.10/kWh. Reminac will be responsible for the design, construction, installation and ongoing maintenance of the 63kV OHTL from Grand Poubara to the Project.

The power consumption for 5Mtpa of production for the Project will be approximately 9MW per month. The OHTL will connect with Baniaka's main substation located at the processing facility. During the construction period, the power will be supplied from site-based diesel generators.

Non-Process Infrastructure and Accommodation Village

The non-process infrastructure comprises a valley fill rejects storage facility, mine roads, accommodation village and connecting roads (Figure 15) and will be managed by Reminac. The Company will also manage the site preparation works for the haul road, access road, and power transmission corridor.

Raw water will be sourced from the Banikima River and pumped to a storage facility, located near the processing facilities, from where it will be distributed to multiple usage points. Waste-water treatment plants will be constructed at the processing facility and accommodation village to treat effluent.

Initially, construction will utilise the existing Northern Access Road from Sucaf-Gabon to TBC. An all-weather access road will be designed and constructed for high-capacity use. Final alignment and detailed design work will commence post the PFS.

It is expected that Baniaka will be supplied with an optic fibre communication cable connecting the Project with the nearby infrastructure running between Moanda and Franceville. The radio network will comprise vehicle borne VHF radio systems and a central transceiver located in an operations room. A satellite delivered television system will be provided for the accommodation village.

The workforce will comprise a combination of local employees and expatriates that will be transported from Franceville, Moanda and Mvengué, to work an equivalent roster of two (2) weeks on and one (1) week off.

The proposed 400-bed accommodation village will be located on a plateau approximately 8km east north-east of the processing facility (Figure 16). The amenities will provide a mix of accommodation configurations, facility management, security, first aid and medical, cleaning services, kitchen and dining, laundry, communications, leisure and recreational facilities, dedicated firefighting ring main, and a vehicle washing bay.

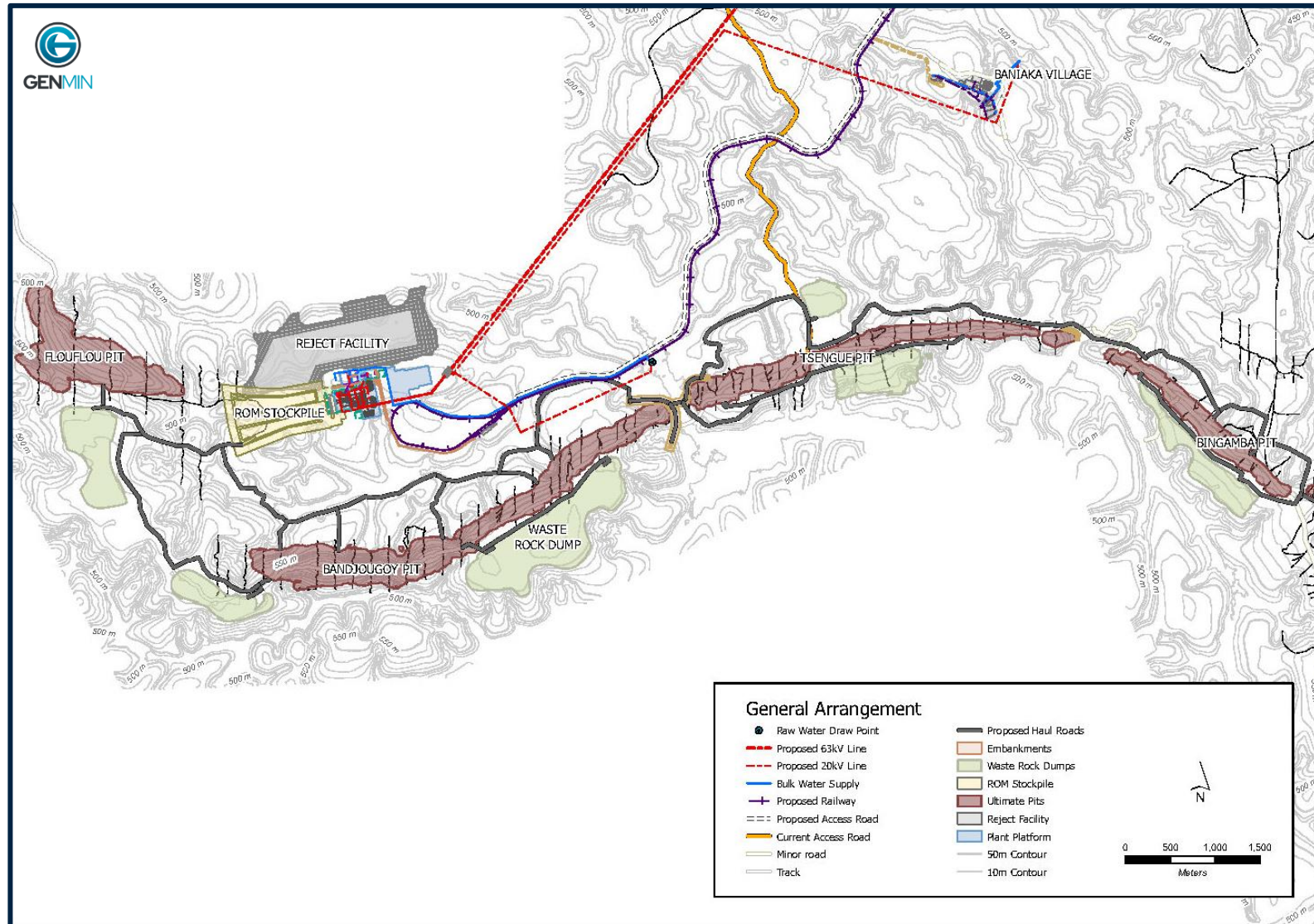

Figure 15: Processing facility and mine General Arrangement

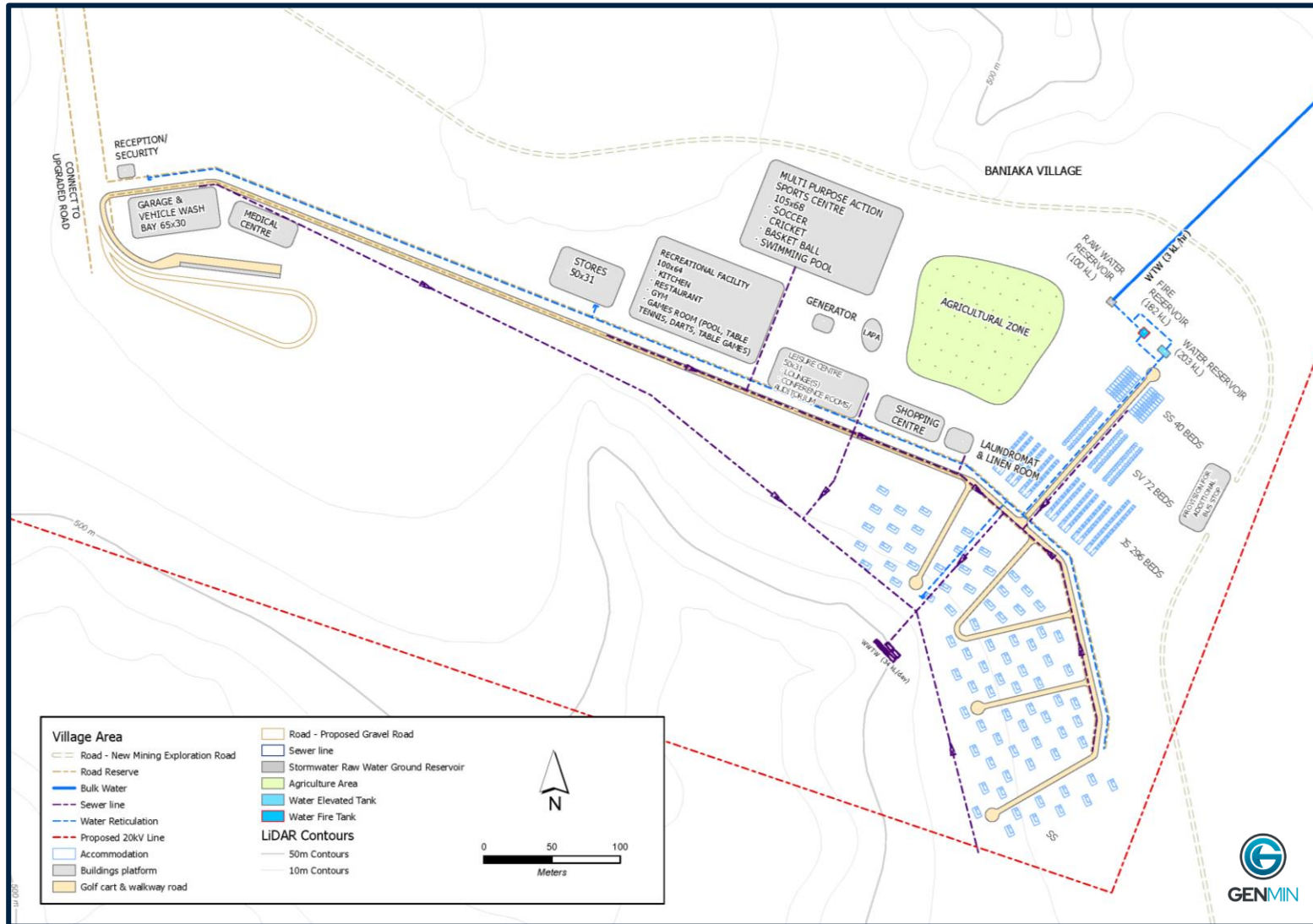

Figure 16: Accommodation village General Arrangement

Rail and Port

The TGR, a heavy haul standard gauge railway with 26t axle load, covers 648km between the port of Owendo, near Libreville, and Franceville. The railway was primarily established to support the manganese mining industry led by the Eramet Group, with all of its logistics managed through COMILOG, which also export manganese product from its own dedicated port facility next to OMP. The first section of the rail, from Owendo to Ndjolé, was opened in 1978 and the remaining portions gradually followed. The complete operation between Owendo and Franceville started in 1987.

SETRAG, a 51% owned subsidiary of COMILOG, operates the TGR under a long term concession. The rail usage is dominated by exports of manganese from COMILOG, Citic Mining, Nouvelle Gabon Mining (Figure 17), with each raiing and exporting approximately 6Mtpa , 1.8Mtpa and 1.4Mtpa respectively in 2021.

In 2021, Meridiam, a transformational infrastructure specialist, acquired a 41% interest in SETRAG through the issue of new shares providing capital to further modernise the railway to increase the capacity and lift the current railings from 12Mtpa to 19Mtpa, in order to accommodate the increased export traffic.

Bigen was appointed to study the rail infrastructure including an analysis of the existing main line and the provision of a new spur line to Baniaka. Bigen optimised the previous 2014 Canarail study rail route from the TGR to Baniaka and revised the capital cost estimate. The optimised rail route resulted in a spur line distance to Baniaka of 65km and a capital cost of approximately US\$170 million. It is anticipated that the spur line will take between 12 and 36 months to construct.



Figure 17: Loading of Nouvelle Gabon Mining manganese onto the Trans-Gabon Railway



Figure 18: Owendo Mineral Port

At 5Mtpa, Project NPV optimisation has shown road haulage from Baniaka to TGR is the best outcome. Consequently, a rail siding is planned to be constructed near Franceville, with road haulage of product along the intended rail corridor. The ramp up considers starting with 3Mtpa and increasing to 5Mtpa in the first years of operation. Computerised route alignment optimisation, and design work is to be undertaken post the PFS.

OMP (Figure 18) is a partnership between Arise, Meridiam and A.P. Moller Capital under a 30-year concession agreement (signed in March 2015) with a 20-year renewal. Figure 19 presents an extract from the OMP master plan and illustrates the expansion phases and the respective capacities being allocated to various commodities, which align with the anticipated rail increases and supports the execution of Baniaka (5Mtpa), and beyond.

OMP has made a commercial 15-year take or pay offer to Reminac to provide all rolling stock as well as the port land and waterside transhipping equipment and operational services to load 150kt to 180kt Cape size ocean going vessels. The service includes the management of product stockpiles and loading of trains at the mine loading point. OMP's provision of rolling stock will add to its existing fleet of approximately 40 locomotives and 3,000 rail wagons.

Currently, COMILOG is trial loading Cape size manganese cargos by transhipment from its private port facility to deep water outside the river channel. This de-risks the transhipment to Cape vessels concept selected by the Company. Subsequent development at OMP would see Cape size vessels being loaded at a berth and eliminate the need for transhipment.

A short video showing the Grand Poubara, TGR and OMP is available on [Genmin's website](#).

1.1 Phased development

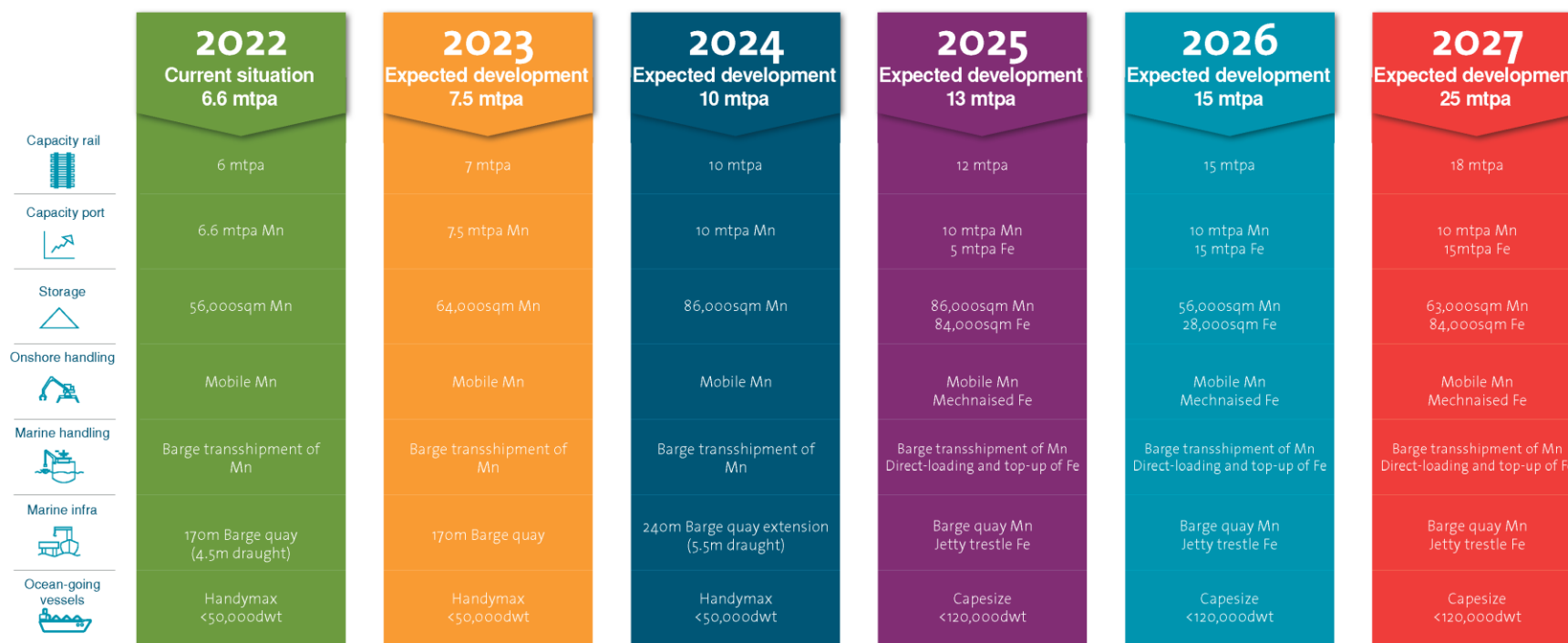

Source: Arise Ports & Logistics

Figure 19: OMP Phased Development Master Plan Summary

Project Delivery and Operations

Project Delivery

The proposed strategy for the delivery of Baniaka is for a Company Owner's Team (**Owner's Team**) to manage all aspects of the Project with key work packages awarded through an engineering, procurement and construction (**EPC**) or on a Lump Sum Turn Key (**LSTK**) contract basis, where appropriate.

The EPC contractors will generally be responsible for the non-process infrastructure work packages where there is a high level of technical risk and impact to the Project, and specialist know-how is required (e.g. the OHTL with step-down transformer and rail siding). The EPC contractors will be responsible for the design, construction and management of all technical and contractual interfaces, and ensuring the technical quality of the installed works.

In order to maximise the participation of local and regional contractors, the construction and delivery of general infrastructure will be broken down into suitable scopes matching the capability of these contractors. Typical items would include the accommodation village, roads, buildings, water, refuse disposal, etc.

The Company has commenced the formation of the Owner's Team by employing a small and focussed group of key experienced professionals.

The processing facility at Baniaka will be delivered through a LSTK contract, which will include detailed design, fabrication, supply, transport to site, construction and commissioning. Bond has been awarded the contract for the detailed engineering and design of the processing facility, noting that the confirmatory metallurgical test work for the final engineering design is well advanced.

Whilst the Project is of a moderate size it does have numerous interfaces and interdependencies, so comprehensive project planning and controls will be implemented by the Owner's Team, supported by specialists.

Mining activities including clearing, removal of topsoil and pre-strip will be undertaken by an experienced contract miner managed by Reminac.

Operations

Activities in Gabon will be managed through a Country Manager (**CM**, Level 1) based in Libreville and supported by finance, logistics, procurement, and outwardly focused stakeholder relations roles.

A General Manager Operations (**GMO**, Level 2) will be based at Baniaka and will report directly to the CM. The GMO will have a number of Level 3 reports including Head of Mining, Head of Processing, Head of Health, Safety & Training, and Head of Social Responsibility and Sustainability, who will in turn be supported by managers and technical specialists (Level 4).

The CM, GMO and several Level 3 positions are designated LOM expatriate roles given their mission critical importance. During steady state operations the workforce is estimated at between 350 – 400 personnel.

Capital and Operating Costs

Capital Costs

Bond completed the capital estimate for the processing facility using the process flow diagram, piping, instrumentation diagrams and 3D model of the planned processing facility and determined a full mechanical equipment list along with structural and platework designs. Cost estimates were then developed based on the

vendor prices for the mechanical equipment, along with fabrication costs obtained for similar equipment that has been previously constructed by Bond.

Bond assesses the capital estimate to be accurate to $\pm 25\%$. This estimate accuracy is based on the delivery of a complete processing facility, transportation, on-site assembly, commissioning, and technical support on site and on a LSTK basis. Bigen was responsible for the provision of the rail, non-process infrastructure and accommodation village costs, which were developed independently from its knowledge of similar projects and historical databases as well as sourcing multiple quotations locally. Table 7 capital costs include the haul road and fleet and the associated capital including the rail siding adjacent off the TGR near Franceville. The estimate accuracy for these costs is between 30 and 35%.

The initial capital investment is estimated at US\$200.8 million, equating to a capital intensity of US\$40 per production tonne at a production rate of 5Mtpa. A LOM sustaining capital estimate of US\$26 million has been allocated to the Project, which amounts to 14% of the initial capital cost

Table 7: Capital Costs Estimates

Cost Area	US\$M
Accommodation village and processing facility site preparation	12.0
Processing facility	82.0
Non-process Infrastructure	21.7
Power supply and transmission	20.7
Haul road & fleet, and rail siding	44.8
Surface water management and rejects storage	3.3
EPC	6.2
Owner's Costs	10.1
Total	200.8

Operating Costs

The operating cost estimate presented in Table 8 is based on a fixed and variable cost basis. Fixed costs include labour direct costs, labour related costs (flights, accommodation, training etc), technology support and software licensing fees, and the maintenance costs.

Mining will be outsourced to a mining contractor responsible for clearing, grubbing, pre-strip, mining, delivery to the ROM ore stockpile and feeding the processing facility. The mining contractor will also be responsible for stacking thickened and filtered discard and coarse DMS rejects into an engineered valley fill storage facility. Operating costs relating to ore and waste mining, and ex-pit material movements were derived using average rates sourced from contractor quotation, and a bottom-up budget estimate derived by WSP Golder. All other services, excluding the laboratory will be Company operated. Bigen and Bond assisted with the determination of operating costs for the non-process infrastructure, accommodation village and associated services, and processing plant support facilities respectively. The cost for the outsourced laboratory was received from an international laboratory service provider that has an in-country presence. Power costs were determined using the proposed rate/kWh and conditions captured in the signed MoU with SdP. The rail and port costs were determined using the OMP commercial offer to the Company.

Table 8: Operating Costs Estimates per dry metric tonne of product sold

Cost Area	US\$ per dmt
Mining (in pit) and ex-pit material movements	12.20
Processing	4.15
G&A costs	1.30
Sub-Total Mine Costs	17.65
Ex-mine logistics costs	42.10
Total	59.75

Economic Analysis

Genmin engaged FTI to assist with the development of a cashflow model (**Model**). The Model was designed to evaluate the economic feasibility on an ungeared, 100% ownership basis (before the 10% State participation right) and assist Genmin in its strategic planning relating to capital investment, hurdle rates and material contract negotiations.

The Model was prepared in real terms in US\$ with a flat exchange rate of 0.65 AU\$ per US\$ used for presentation purposes only. The Model was informed by the Ore Reserve mine schedule prepared by WSP Golder, the capital and operating cost estimates, regulatory provisions and charges, and the Company's macroeconomic assumptions relating to commodity pricing and foreign exchange rates. No residual asset value or allowance for additional resource conversion or expansion was included.

Four (4) development scenarios were considered as outlined in Table 9.

Table 9: Considered development scenarios

Scenario	Approach
1 Spur Line (Deferred)	Defer Company funded spur line to end of second year of production
2 Spur Line (Initial Capex)	Build Company funded spur line as part of initial capex
3 Spur Line (Charge to Operator)	Third party built and funded spur line with no capital cost to Company
4 Trucking only	LOM trucking to the TGR, and build rail terminal

Ranking these scenarios through impact on NPV showed, at 5Mtpa, road haulage to a new load out rail terminal located near Franceville was the best value outcome (**Scenario 4**). A summary of the production statistics relating to Scenario 4 are shown in Table 10, and Figure 10.

Table 10: Production statistics

Item	Unit	LOM Total / Average
Total Ore Processed	Mdmt	101
Fe ROM Grade	%	46.9
Lump Ore	Mdmt	17.1
Lump Ore - Fe Grade	%	61.2
Fines	Mdmt	22.5
Fines - Fe Grade	%	61.8
Pellet Feed	Mdmt	15.7
Pellet Feed - Fe Grade	%	61.2

Discount Rate

The risk adjusted discount rate (**RADR**) was calculated using a bottom-up method. This approach used a market (systematic) risk calculation (using the Weighted Average Cost of Capital (**WACC**)), which was added to an idiosyncratic risk (unsystematic risk unique to Baniaka) calculation as presented in Table 11.

Table 11: Discount Rate Calculation

Input Parameter (T=0)	Selected Value
Risk-free rate	3.142%
Project Beta	1.0
Market risk premium	6.00%
Cost of equity	13.3%
Cost of pre-tax debt	7.00%
Tax rate	30%
Cost of post-tax debt	4.90%
Gearing	50%
Debt: Equity	1:1
After-tax nominal WACC	9.12%
Forecast inflation	6.9%
After-tax real WACC	2.08%
Risk Premium	6.00%
RADR	8.08%

The estimated financial metrics for Scenario 4 are presented in Table 12 and the key performance metrics are presented in Table 13. The LOM cashflows are presented in Figure 20.

Table 12: Financial metrics

Item	Unit	Value
RADR	%	8.0
NPV Pre-Tax	US\$M (AU\$M*)	610 (938)
NPV Post Tax	US\$M (AU\$M*)	391 (601)
Pre-Tax IRR	%	45.0
Post-Tax IRR	%	38.0
Post-Tax Payback Period	Years	2.7

** Converted to Australian dollars at a USD:AUD foreign exchange spot rate of 0.65.*

Table 13: Key performance metrics

Item	Unit	LOM Total / Average
EBITDA	US\$M	1,448
EBT	US\$M	1,177
NPAT	US\$M	772
C1 Costs	US\$ / dmt product	59
C2 Costs	US\$ / dmt product	64
C3 Costs	US\$ / dmt product	70
AISC	US\$ / dmt product	67

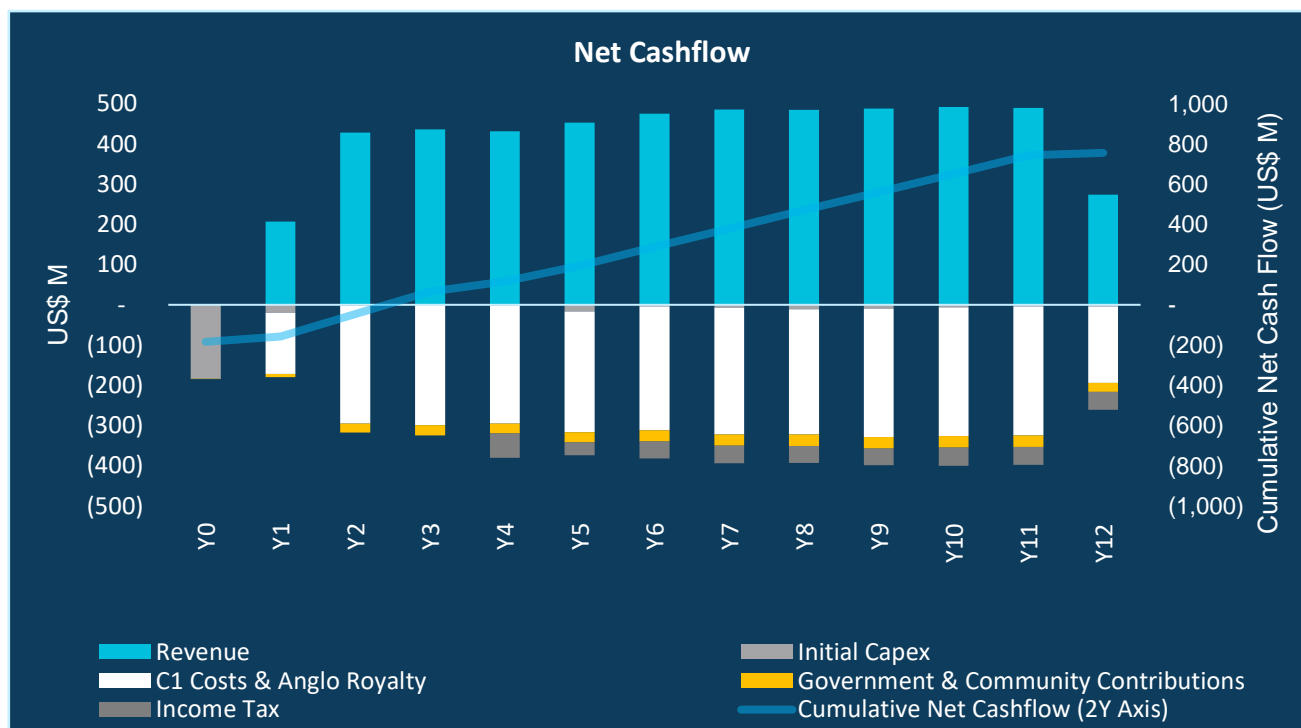

Figure 20: Life of Mine cashflows

Commodity Prices

Genmin has several non-binding MoU in place with potential offtake partners.

The Company used the AME 62% Fe CFR North China annual spot price forecast for each year commencing from 2024 (**AME Forecast**) and informed its predicted revenue pricing based on the detailed results of the VIU test work performed by CSU.

Baniaka Fines are expected to receive up to a 17% price premium in the market resulting from its VIU qualities whilst Baniaka Lump is estimated to be priced in line with the market lump price.

The Lump premium applied was based on the AME 62.5% Fe premium (US¢ per dmtu) forecast for each year commencing in 2024. The premium was forecast at US¢24.0 for 2024 increasing to US¢29.8 in 2035, and averaging US¢26.8 over that period.

The AME Forecast ranged from US\$87 per dmt in 2024 and US\$108 per dmt in 2035, averaging US\$97 per dmt over that period.

No VIU price adjustment was applied to Pellet Feed product as VIU test work was incomplete at the date of publication of the PFS.

Figure 21 shows the price received offer based on the AME Forecast and adjustment for the Lump premium and Fines VIU premium.

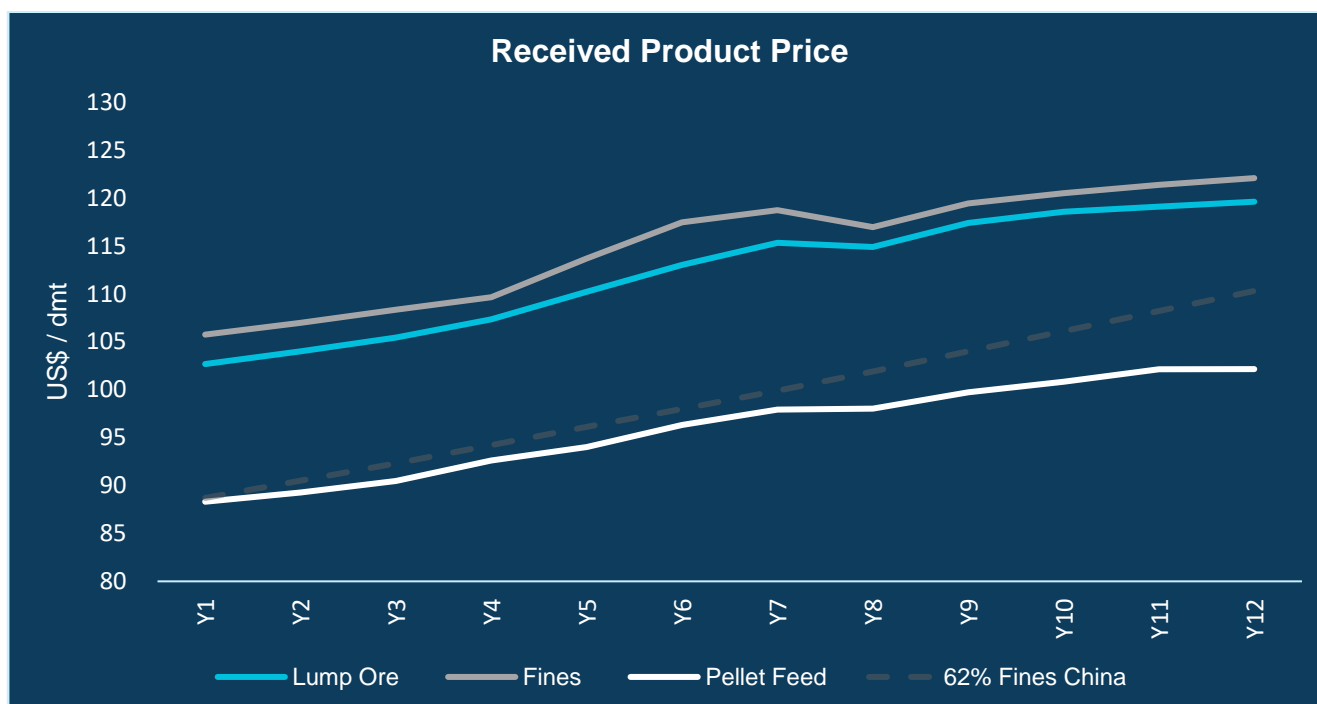

Figure 21: Pricing Profile

Forward freight rates were estimated by Agemar and then discounted from the received price in the Model.

Government and Community Contributions and Income Tax

A review of the 2019 Mining Code (Act N °037/2018 of 11 June 2019) was undertaken by FTI to inform the Model in relation to government and community contributions, and income tax liabilities (Figure 24 and Figure 25).

The undiscounted LOM Ad Valorem royalty payable to the State is estimated at US\$206 million (Figure 24 and Figure 25). Government and community contributions amount to US\$298 million over the life of the Project. This includes

discretionary funding of US\$26 million for Company sponsored community development, and US\$14 million to the Industrial Fund of Gabon.



Source: Genmin Limited

Figure 22: Local students from the technical school in Moanda, near Franceville



Source: Genmin Limited

Figure 23: Reminac plumber working at Tsengué Base Camp

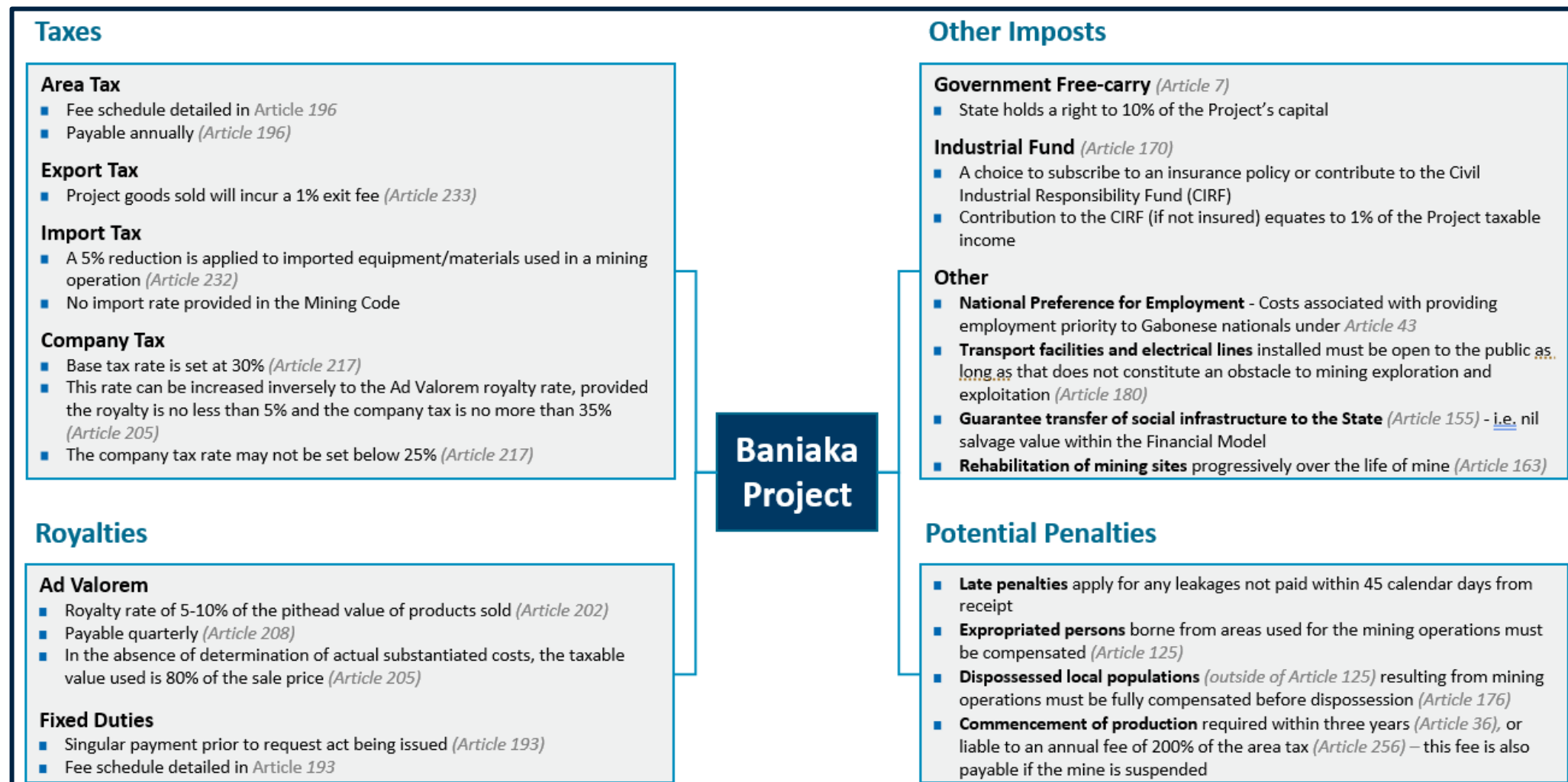

Figure 24: 2019 Mining Code obligations

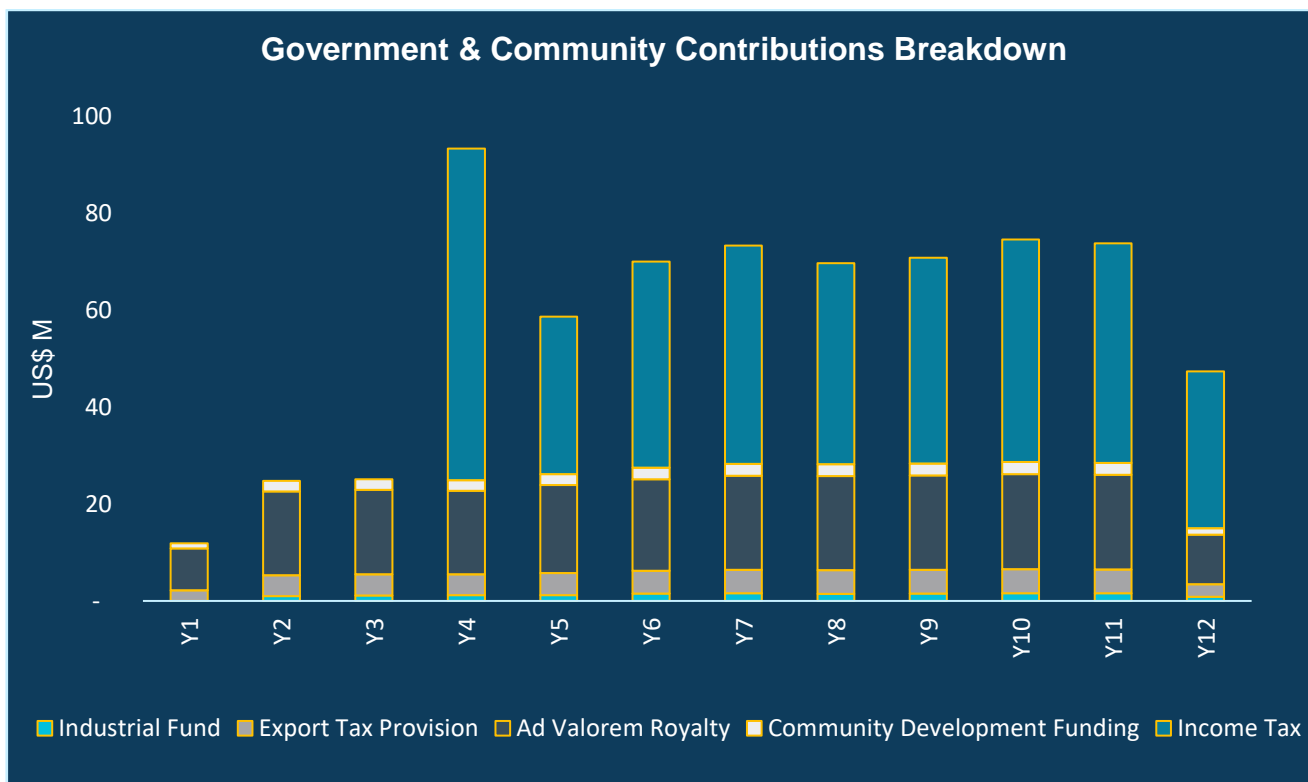

Figure 25: Company sponsored community development funding

Sensitivity Analysis

Genmin elected to perform probabilistic scenario modelling rather than undertaking a traditional univariate sensitivity analysis on the deterministic outcome of the modelling. This was undertaken to allow the assessment of the risk profile of the Project in the context of likelihood of event occurrence and considers the confidence limits of the material inputs to the Model. A range analysis was performed to identify the minimum and maximum values on key Project risk variables and probability weightings were given to those values to fit distribution curves and correlation coefficients for Monte Carlo simulations performed using Oracle Crystal Ball software. A total of 10,000 iterations were run to ensure a good representation of random values of risk variables and the probability that those variables contribute to a risk event. Statistical analysis of the simulation results was performed and cumulative probability distribution curves of all 10,000 iterations were plotted to assess the overall Project risk and analyse its economic sensitivity to the key input variables.

The Project has a positive estimated NPV across a wide range of deterministic input ranges as presented in Figure 26 and Figure 27.

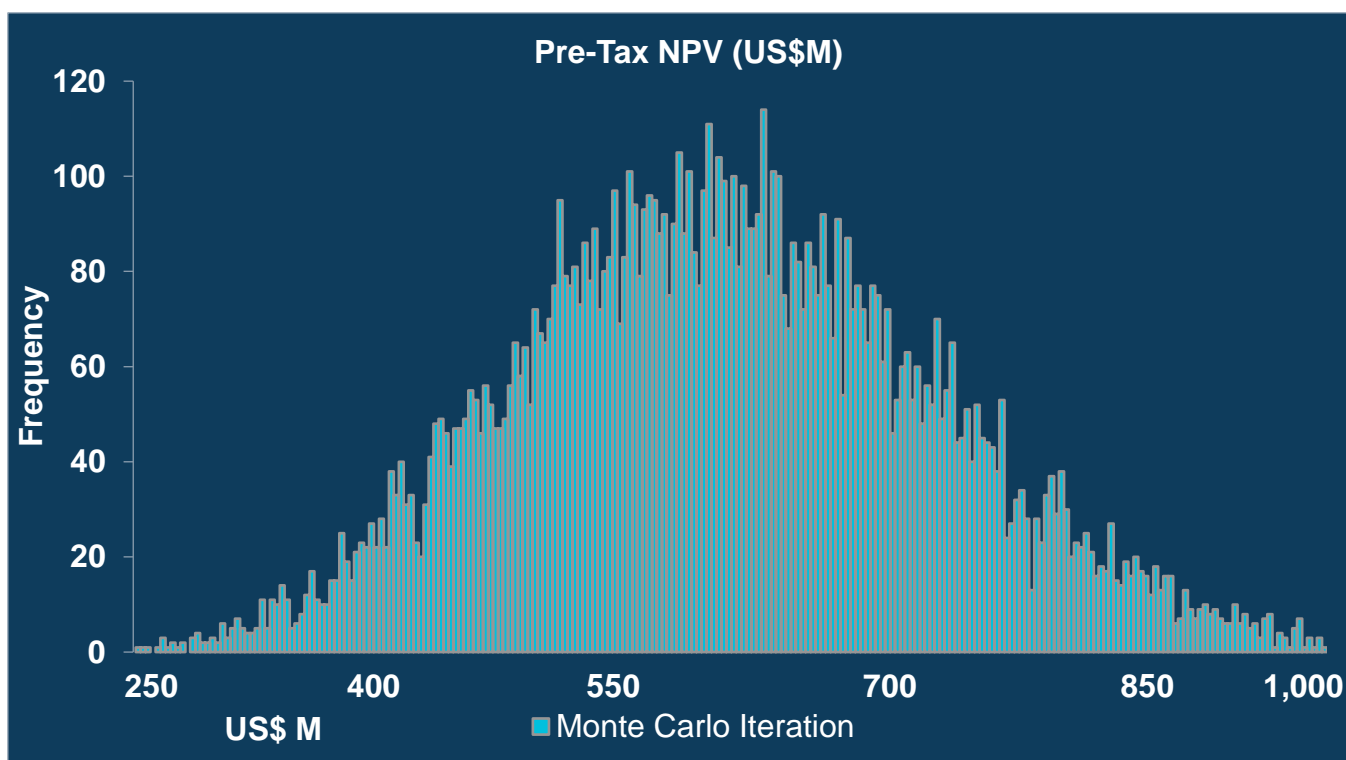

Figure 26: Pre-Tax NPV (US\$M) Sensitivity Analysis

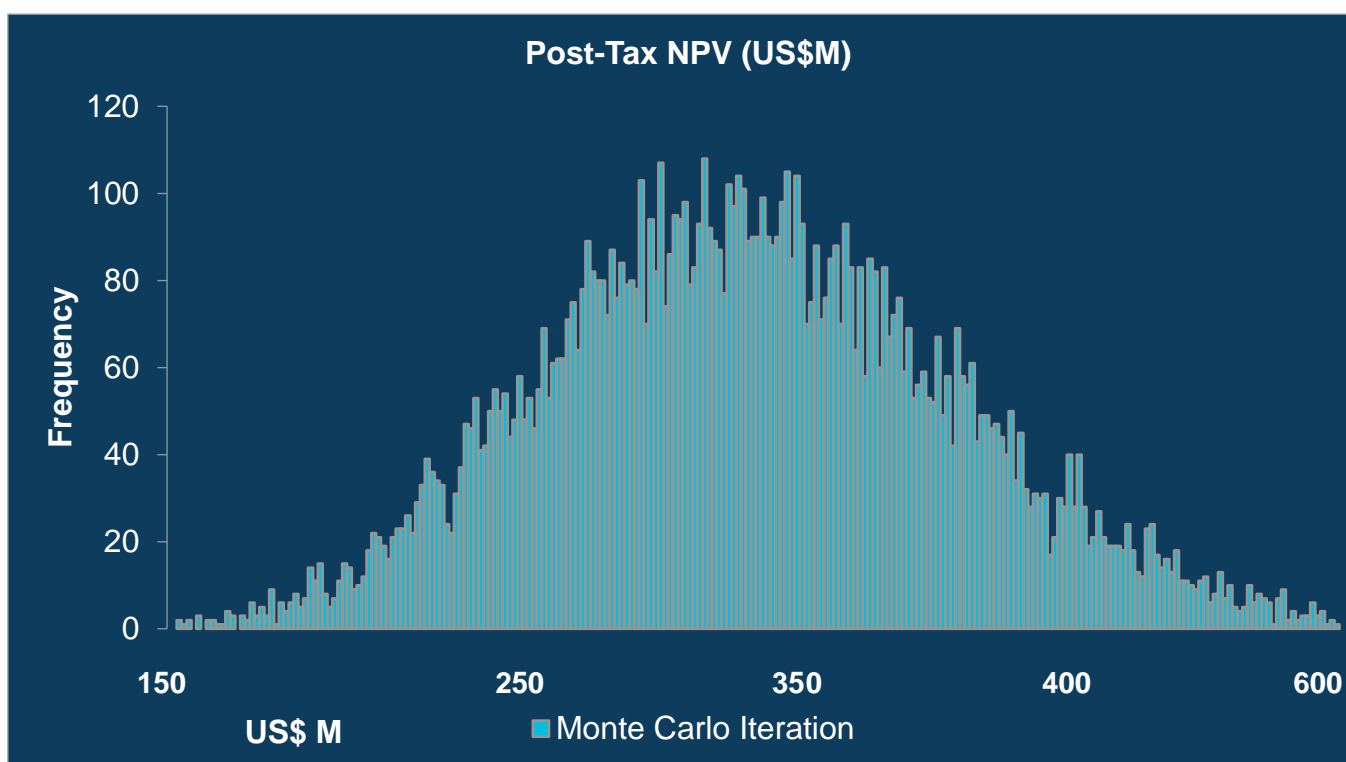

Figure 27: Post-Tax NPV (US\$M) Sensitivity Analysis

The Monte Carlo analysis showed the Project NPV is most sensitive to the long term iron ore spot price, logistics costs, and steady state Fines production (Figure 28). The Project’s NPV is not sensitive to the capital cost.

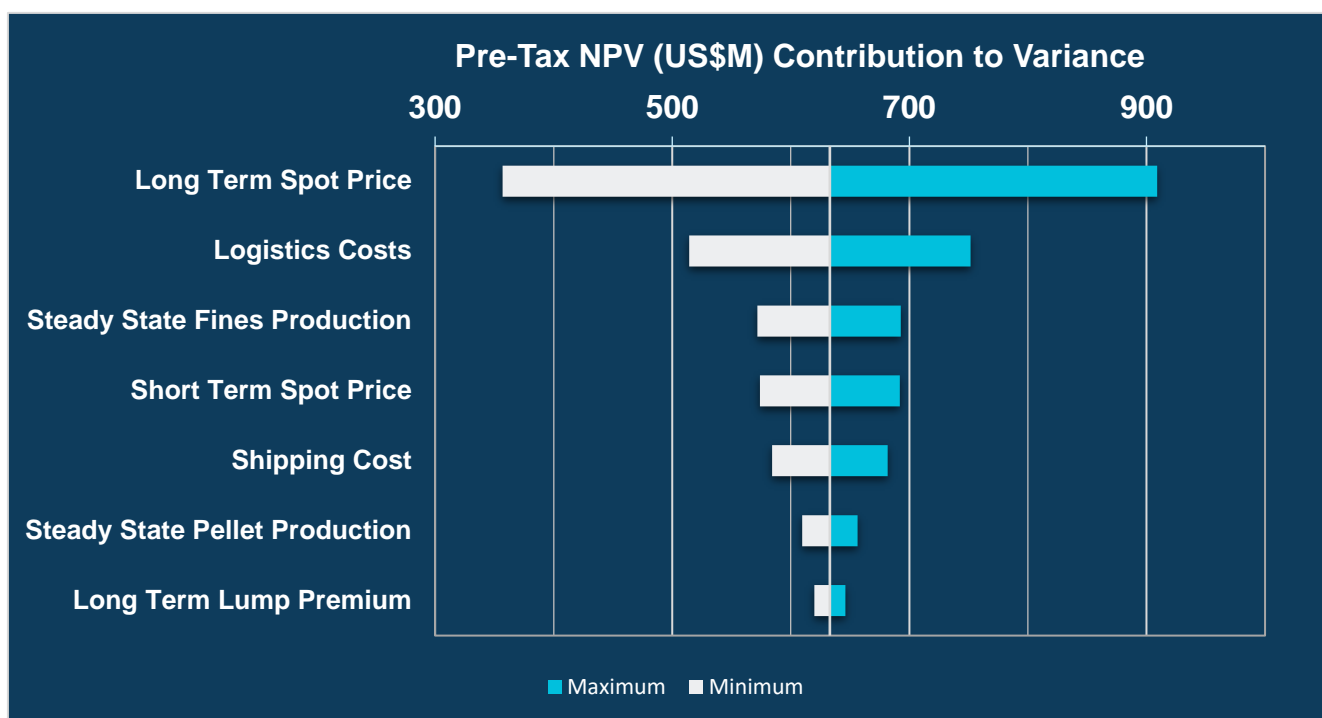

Figure 28: Tornado Chart (Contribution to NPV Variance by Input)

Opportunities and Risks

There are a number of opportunities and risks inherent in the delivery, operation, forecast financials, and outcomes related to Baniaka.

Opportunities to enhance Project returns include selling a separate Pellet Feed product rather than blending it back into the Fines product, increasing scale to 10Mtpa to reduce C1 cash cost through realisation of economies of scale in respect of rail, port, and transshipment costs, and producing only Fines to maximise resource value by removing the pricing volatility in the Lump premium. The detailed design of the processing facility has included the flexibility to crush all Lump production to Fines, either continually or during seasonal periods of low Lump premium.

A future facing opportunity is to work with the potential offtake partner to develop a greener iron ore premium in those markets more mature in reducing Scope 1 and Scope 3 carbon emissions.

Key risks related to achieving the estimated financial outcomes revolve around iron ore pricing in particular a sustained retreat with China’s economy contracting, the performance of third parties in delivering rail and port services, the realisation of price premiums, the availability and retention of skills to deliver and operate Baniaka, and to a lesser extent delays in receiving permits and approvals, which increase the pre-development working capital.

Conclusions and Recommendations

The PFS has established the economic robustness of an initial ten (10) year iron ore mining operation at Baniaka producing a total of 5Mtpa of Lump, Fines and Pellet Feed products.

Conclusions

- The Project is amenable to the development of a scalable 5Mtpa truck and shovel, shallow, free dig contract open pit mining operation, over an initial 10-year mine life underpinned by a Maiden Ore Reserve estimate of approximately 100Mt.
- ROM ore can be beneficiated through a simple, low risk wet ore treatment flowsheet comprising scrubbing, screening, and gravity separation.
- Leveraging access to existing regional hydropower, rail and port infrastructure results in a modest initial capital investment of approximately US\$200 million, equivalent to a capital intensity of approximately US\$40 per dmt of product, and a payback period of less than three (3) years.
- Ranking several Connecting Transport scenarios (truck haulage and rail spur, either Company or third party financed) through impact on value showed, at 5Mtpa, road haulage to a new purpose built load out rail terminal located near Franceville was the best outcome, giving an ungeared, 100% ownership Pre-Tax NPV (8%) of US\$610 million (AU\$938 million) and a Post-Tax Project NPV (8%) of US\$391 million (AU\$601 million).
- CI operating costs are estimated at approximately US\$59 per dmt of product shipped at 5Mtpa.
- Committing additional capital to fund and fully own a new rail load out facility near Franceville and the OHTL from Grand Poubara is strategically important, enabling the Company to control and leverage key infrastructure in the region.

Recommendations

Having regard to the fully developed and operating regional energy and transport infrastructure, and the simplicity of the proposed shallow, low strip open pit mining operation and maturity of the processing solution, it is recommended that rather than complete a definitive feasibility study, the Company immediately progresses to pre-development activities at Baniaka by focusing on procuring permits and approvals, commencing long lead project delivery activities and, concurrently, completing a series of optimisations studies to realise more value, including:

- Complete and submit the SEIA in support of the Mining Permit Application.
- Commence detailed design and engineering of the processing facility, and design and construction of the permanent accommodation village.
- Commence detailed engineering of an optimised haul road alignment, and rail loadout terminal.
- Complete VIU test work on Pellet Feed to allow the development of a price protocol for this material, which is currently priced with no VIU adjustment.
- Improve the sophistication of the geometallurgical model to provide greater alignment with product grades and yields achieved in the Bond Test Work.
- Optimise the mine schedule to minimise ex-pit material movements and smooth the LOM grade profile.

Appendix 1: JORC Table 1

Section 1 – Sampling Techniques and Data

(Criteria in this section apply to all succeeding sections)

Criteria	JORC Code explanation	Commentary
Sampling techniques	<ul style="list-style-type: none"> <i>Nature and quality of sampling (e.g. cut channels, random chips, or specific specialised industry standard measurement tools appropriate to the minerals under investigation, such as down hole gamma sondes, or handheld XRF instruments, etc). These examples should not be taken as limiting the broad meaning of sampling.</i> <i>Include reference to measures taken to ensure sample representivity and the appropriate calibration of any measurement tools or systems used.</i> <i>Aspects of the determination of mineralisation that are Material to the Public Report.</i> <i>In cases where ‘industry standard’ work has been done this would be relatively simple (e.g. ‘reverse circulation drilling was used to obtain 1m samples from which 3kg was pulverised to produce a 30g charge for fire assay’). In other cases, more explanation may be required, such as where there is coarse gold that has inherent sampling problems. Unusual commodities or mineralisation types (e.g. submarine</i> 	<p>Bandjougoy, Tsengué, Flouflou and Bingamba North</p> <ul style="list-style-type: none"> Auger drilling is the dominant sampling method supporting the Mineral Resource Estimates (MRE). Auger is drilled in 0.5m runs. Metre samples are collected as two (2) 0.5m sub-samples by manually removing the material from the Auger flights onto a sample tray. The two (2) samples are photographed separately, and then composited into a single bag, numbered and recorded on paper log sheets. Diamond drill core samples intercepting the residuum are also informing the MRE. The core is sampled as quarter (PQ diameter) or half core (HQ or NQ diameter) to a nominal 2m in the residuum and BIF and broken by changes in dominant lithology. A nominal 4m length is used in non-banded iron formation (BIF) lithologies. Sampling of the detrital iron deposits (DID) and in-situ BIF lithologies is systematically conducted over the full drilled interval of those lithologies for all drillholes. No selective methods are used in the collection of samples from diamond drill holes. The Auger and diamond drill sampling is consistent with peer iron ore projects and is considered representative of the lithologies under investigation. A Terraplus KT10 Plus handheld magnetic susceptibility meter is used to collect measurements every meter in Auger and 50cm on diamond core. The instrument manual states that the KT-10 meter is calibrated at the factory and a periodic calibration is not required.

Criteria	JORC Code explanation	Commentary
	<p><i>nodules) may warrant disclosure of detailed information.</i></p>	
<p>Drilling techniques</p>	<ul style="list-style-type: none"> • <i>Drill type (e.g. core, reverse circulation, open-hole hammer, rotary air blast, Auger, Bangka, sonic, etc) and details (e.g. core diameter, triple or standard tube, depth of diamond tails, face-sampling bit or other type, whether core is oriented and if so, by what method, etc).</i> 	<p>Bandjougoy, Tsengué, Flouflou and Bingamba North</p> <ul style="list-style-type: none"> • Auger samples are collected from vertical holes drilled with two V2000 Mobile Drill portable 3 ½” (88.9mm) Auger rigs. Auger provides a mixture of loose material through unconsolidated ground to shallow depths with limited penetration into the in-situ basement lithologies. • Diamond drilling was completed in two (2) campaigns in 2018 using the Company’s own track mounted Hanjin P7000 multi-purpose rig and in 2021 using a track mounted Longyear LF™90 chuck drive coring rig operated by contractor Boart Longyear. • Auger provides a mixture of loose material through unconsolidated ground to shallow depths with limited penetration into the in-situ basement lithologies • Drill holes pass through the residuum blanket, with hole azimuth and dip designed to target orthogonal penetration of the underlying BIF units. Through the residuum, hole size is typically PQ3 diameter (83.1mm), HQ3 (61.1mm) diameter in soft material and NQ (47.6mm) in competent rock. Core in unconsolidated and soft material of the residuum and Soft Oxide (SO) is routinely recovered using a triple tube core barrel to optimise core recovery. Core is oriented in consolidated ground, below the residuum and SO, using a Boart Longyear TruCore™ core orientation tool. Core is not oriented in the residuum which is unconsolidated and subsequently lacking in-situ surfaces from which to measure structural information. • Diamond drill holes are surveyed using either a Reflex EZ-Gyro™ (2018) or a Stockholm Precision Tools (SPT) Gyromaster™ (2021) north seeking gyroscopic downhole survey tool for dip and azimuth.
<p>Drill sample recovery</p>	<ul style="list-style-type: none"> • <i>Method of recording and assessing core and chip sample recoveries and results assessed.</i> • <i>Measures taken to maximise sample recovery and ensure representative nature of the samples.</i> • <i>Whether a relationship exists between sample recovery and grade and whether sample bias may have occurred due to preferential loss/gain of fine/coarse material.</i> 	<p>Bandjougoy, Tsengué, Flouflou and Bingamba North</p> <ul style="list-style-type: none"> • Sample recovery from Auger drilling cannot be clearly defined due to the open hole nature of the technique. Test work has demonstrated that coarse particles (>1 mm, and >31.5 mm in particular) may be ground by the Auger bit during drilling. These coarse particles are generally high Fe and low contaminant, and the Fe content is transferred to the <1 mm fraction, with minor reduction in overall Fe head grade while reducing apparent mass yield of coarse fractions. • Diamond core recovery is measured by a technician at the drill rig and marked up on the core tray. Core recovery is recorded in the geological database and reviewed systematically. Lower recoveries are predominantly encountered in unconsolidated ground. Measures taken to ensure high recoveries are maintained in poor ground conditions include retrieval of core in short (0.3 to 0.5m) runs, and the extensive use of triple tube core barrels in oxidised lithologies.

Criteria	JORC Code explanation	Commentary
<p>Logging</p>	<ul style="list-style-type: none"> • Whether core and chip samples have been geologically and geotechnically logged to a level of detail to support appropriate Mineral Resource estimation, mining studies and metallurgical studies. • Whether logging is qualitative or quantitative in nature. Core (or costean, channel, etc) photography. • The total length and percentage of the relevant intersections logged. 	<p>Bandjougoy, Tsengué, Flouflou and Bingamba North</p> <ul style="list-style-type: none"> • Logging of Auger samples involves weighing, washing and logging a fixed volume aliquot of the air-dried sample. The washed material is then qualitatively logged based on the type and proportion of fragments greater than ~1mm in size. Other logging parameters include overall sample texture and dominant iron minerals. • Diamond core is cleaned to reveal undisturbed material, assembled, oriented, measured, marked-up and systematically logged for geology (regolith, lithology, texture and dominant minerals) and geotechnical parameters prior to being photographed. Where core is oriented, representative structures are recorded on a regular basis, with corresponding confidence in the measurements. • Due to the unconsolidated nature of the residuum coupled with the destructive nature of Auger drilling, no geotechnical or structural logging can be recorded • All logging is cross-checked with magnetic susceptibility measurements and assay data subsequent to their receipt to ensure any anomalous or erroneous grade-lithology relationships are identified and recognised or logging corrected, as necessary. • All remaining samples are kept indefinitely on site after sampling at the Baniaka sample storage facility. • All sample intervals are logged for the entire length of the drill hole regardless of lithology.
<p>Sub-sampling techniques and sample preparation</p>	<ul style="list-style-type: none"> • If core, whether cut or sawn and whether quarter, half or all core taken. • If non-core, whether riffled, tube sampled, rotary split, etc and whether sampled wet or dry. • For all sample types, the nature, quality and appropriateness of the sample preparation technique. • Quality control procedures adopted for all sub-sampling stages to maximise representivity of samples. • Measures taken to ensure that the sampling is representative of the in-situ material collected, including for instance results for field duplicate/second-half sampling. 	<p>Bandjougoy, Tsengué, Flouflou and Bingamba North</p> <ul style="list-style-type: none"> • Preparation of Auger material prior to consignment to the sample preparation laboratory involves the following: <ul style="list-style-type: none"> ◦ Air drying the samples and manually breaking large clay clumps. ◦ Riffle splitting to obtain a sub-sample targeting 5kg to 6kg for iron colluvium for preparation (reject retained in original sample bag). The splitter is cleaned with compressed air between each sample. • Diamond drill core is cut in quarter (PQ diameter) or half (HQ and NQ diameter) using a core saw and sampled to meet the desired sample mass. In unconsolidated ground, material is split using a core splitter or large pallet knife depending on sample hardness. • Auger and diamond core samples are put into numbered plastic bags with pre-numbered sample tickets and stored in lots in labelled large plastic bags. • In 2018, samples were prepared at an onsite preparation laboratory operated by Setpoint Laboratories. For the 2021 campaign, samples are prepared at Intertek Genalysis Owendo (Intertek) near Libreville. Preparation protocol is as follows: drying at 105°C, crushing to 80% passing (P₈₀) 2mm, riffle splitting and pulverisation to P₈₀ passing 75µm; and packaging and shipping to an external independent analytical laboratory, ALS.

Criteria	JORC Code explanation	Commentary
	<ul style="list-style-type: none"> • Whether sample sizes are appropriate to the grain size of the material being sampled. 	<ul style="list-style-type: none"> • Field duplicates are collected as part of the sample preparation process at a rate of one per 20 samples and examination of the results indicates no material bias is present. • The sample size is considered adequate given the particle sizes involved. A 5kg sample weight is targeted in the residuum where particles are the largest (top size circa 35mm) consistent with the nomogram method given in the Field Geologists' Manual Fifth Edition, Monograph 9, published by The Australasian Institute of Mining and Metallurgy, Carlton, Victoria 3053 Australia.
<p>Quality of assay data and laboratory tests</p>	<ul style="list-style-type: none"> • The nature, quality and appropriateness of the assaying and laboratory procedures used and whether the technique is considered partial or total. • For geophysical tools, spectrometers, handheld XRF instruments, etc, the parameters used in determining the analysis including instrument make and model, reading times, calibrations factors applied and their derivation, etc. • Nature of quality control procedures adopted (e.g. standards, blanks, duplicates, external laboratory checks) and whether acceptable levels of accuracy (i.e. lack of bias) and precision have been established. 	<p>Bandjougoy, Tsengué, Flouflou and Bingamba North</p> <ul style="list-style-type: none"> • Samples from the 2018 campaign were analysed at ALS or Intertek Genalysis facilities in Perth, Western Australia. • Samples from the 2021-2022 campaign are analysed at ALS facilities at both Loughrea, Ireland and Johannesburg, South Africa. Analysis is conducted for a suite of 24 elements and oxides by ME-XRF21u (lithium borate fusion and XRF finish on fused disks) and loss on ignition at 371, 650 and 1000°C by OA-GRA05x (Muffle Furnace or TGA). The techniques are industry standard for iron ore assaying and are consistent with similar analytical packages offered by Intertek, SGS, and Bureau Veritas laboratories. • Magnetic susceptibility is measured using as handheld KT-10 Plus Terraplus meter and the resulting data is used to aid geological interpretation. • Certified Reference Material (CRM) samples are inserted at a rate of one per 50 samples. CRM samples are sourced from Geostats Pty Ltd and include four (4) iron grades ranging 25.6-63.0% Fe. For the 2021-2022 program, certified blank material (OREAS 22e) is inserted at a rate of one per 50 samples, with river sand used in prior programs. • Field duplicates are inserted at a rate of one per 20 samples. • A review of the QAQC data was completed and was found to be adequate.
<p>Verification of sampling and assaying</p>	<ul style="list-style-type: none"> • The verification of significant intersections by either independent or alternative company personnel. • The use of twinned holes. • Documentation of primary data, data entry procedures, data verification, data storage (physical and electronic) protocols. • Discuss any adjustment to assay data. 	<p>Bandjougoy, Tsengué, Flouflou and Bingamba North</p> <ul style="list-style-type: none"> • All intersections are reviewed and validated by two (2) senior geological personnel from WSP Golder, both designated as Competent Persons (CP). All data and associated intersections that are included in the MRE have been reviewed by the respective CP. • Genmin has drilled Auger holes parallel to pit and trench excavations to provide comparison between channel samples (considered representative) with the size fragment biased (lower grade) Auger drilling. Comparison between the two (2) sample datasets has assisted Genmin understand the limitations of the Auger drill technique for sampling the residuum. • A batch of approximately 430 samples has been sent to two (2) alternate laboratory facilities for umpire analyses. Results are expected by the end of Q2 2022.

Criteria	JORC Code explanation	Commentary
		<ul style="list-style-type: none"> Logging is conducted at the Baniaka logging shed, where primary data is recorded directly into a Microsoft Excel spreadsheet. The data is then validated on site and electronic files sent from to independent database consultants Maxgeo, Perth, Australia who are engaged to maintain the Company's geological database. Analytical data is provided by ALS in digital ASCII format, which is imported directly into the database following satisfactory review of associated QAQC data. Following the completion of the database update process, geological logging is validated against analytical grades and drill sections. No adjustments are made by the Company to primary data such as chemical assays. Corrections are only made to subjective data, such as geological logging, where geochemical profiles indicate potential misclassification of material type.
<p>Location of data points</p>	<ul style="list-style-type: none"> Accuracy and quality of surveys used to locate drill holes (collar and down-hole surveys), trenches, mine workings and other locations used in Mineral Resource estimation. Specification of the grid system used. Quality and adequacy of topographic control. 	<p>Bandjougoy, Tsengué, Flouflou and Bingamba North</p> <ul style="list-style-type: none"> The topography is a Digital Elevation Model (DEM) surface created from a high-resolution LiDAR point mesh calibrated and validated with Differential Global Positioning System (DGPS) points collected throughout the airborne survey area. The LiDAR survey data was classified according to the international LAS standard and format, and the bare earth class used for topographic model generation that excludes vegetation. The grid system is WGS84, UTM Zone 33S. Where appropriate, DGPS points have been added to the LiDAR survey DEM to improve local accuracy. Drill collars are pegged using handheld GPS units with a nominal accuracy of 15m. The Company has conducted a DGPS and Total Station in thick vegetation surveys to achieve centimetre level accuracy for all drill collars following completion of the 2021 drilling programs. Auger drill holes completed in 2018 were however not surveyed by DGPS or Total Station. The LiDAR-based DEM was used as a reference surface to derive elevations of the 2018 Auger holes. All diamond drillholes are surveyed with the DGPS or Total Station method, with nominal accuracies stated by the 2022 survey contractor of $\pm 3\text{cm}$ for planar coordinates (X,Y), and $\pm 5\text{cm}$ for elevation (Z). All diamond drill holes were surveyed using either a Reflex EZ-Gyro™ (2018) or a Stockholm Precision Tools (SPT) Gyromaster™ (2021) to confirm inclination and azimuth, except for BWDD012 and BWDD013, which were completed prior to provision of the survey tool by drill contractor Boart Longyear. Drill collars are pegged using handheld GPS units with a nominal accuracy of $\pm 15\text{ m}$. The Company has conducted a DGPS and Total Station (in thick vegetation) survey in 2022 to achieve centimetre level accuracy for all drill collars following completion of the 2021 drilling program.

Criteria	JORC Code explanation	Commentary
		<ul style="list-style-type: none"> Auger drill holes completed in 2018 and six (6) newly reported holes drilled in 2022 were not surveyed by DGPS or Total Station. The LiDAR-based DEM was used as a reference surface to derive elevations of the 2018 Auger holes. All drillholes surveyed with the DGPS or Total Station method have nominal accuracies stated by the 2022 survey contractor of ± 3 cm for planar coordinates (X, Y), and ± 5 cm for elevation (Z). No downhole survey or orientation is conducted on auger holes due to the shallow depth, and destructive nature of the drilling technique All diamond drill holes were down-hole surveyed using a Reflex EZ-GyroTM.
Data spacing and distribution	<ul style="list-style-type: none"> Data spacing for reporting of Exploration Results. Whether the data spacing and distribution is sufficient to establish the degree of geological and grade continuity appropriate for the Mineral Resource and Ore Reserve estimation procedure(s) and classifications applied. Whether sample compositing has been applied. 	Bandjougoy, Tsengué, Flouflou and Bingamba North <ul style="list-style-type: none"> The 2018 and 2022 Auger holes at Bandjougoy were drilled along 22 200m-spaced N-S sections with a nominal 50m spacing between holes along section, and closer 100m drill line spacing in areas of complexity. The 2018 and 2021 auger holes at Flouflou were drilled along fifteen 200 m spaced N-S sections and one (1) E-W section with a nominal 50m spacing between holes along section. A 200m x 50m spacing is deemed sufficient to establish geological and grade continuity to achieve an Indicated classification in DID mineralisation. The combined drilling dataset at Bingamba North comprises fourteen 200m spaced NE-SW sections and three N-S sections section with a nominal 50m spacing between holes along section. A 200m x 50m spacing is deemed sufficient to establish geological and grade continuity to achieve an Indicated classification in DID mineralisation. No drilling results are reported in this report.
Orientation of data in relation to geological structure	<ul style="list-style-type: none"> Whether the orientation of sampling achieves unbiased sampling of possible structures and the extent to which this is known, considering the deposit type. If the relationship between the drilling orientation and the orientation of key mineralised structures is considered to have introduced a sampling bias, this should be assessed and reported if material. 	Bandjougoy, Tsengué, Flouflou and Bingamba North <ul style="list-style-type: none"> The residuum is a horizontal blanket of material that generally follows the topography throughout the deposits. Auger drilling is vertical and perpendicular to the mineralisation. Diamond drilling targets the in-situ BIF, which generally dips from 30 to 40 degrees north or northwest at Bandjougoy. The drillhole declination is set at 50 or 60 degrees to the south, hence intercepted Oxide and Primary mineralisation is typically intersected within 10 degrees of orthogonal. Diamond drilling also provides useful geological and grade definition in the residuum
Sample security	<ul style="list-style-type: none"> The measures taken to ensure sample security. 	Bandjougoy, Tsengué, Flouflou and Bingamba North

Criteria	JORC Code explanation	Commentary
		<ul style="list-style-type: none"> • Auger and core samples are collected at the end of every day, transported to and stored at the Baniaka sample storage facility under supervision of Genmin technical staff. • Sub-samples are submitted to the Intertek preparation facility in Owendo, Gabon, in sealed bags or boxes. Pulps are sent from the preparation facilities to ALS or Intertek. • The Chain of Custody is managed by Genmin personnel on site, in Libreville, and in Perth.
Audits or reviews	<ul style="list-style-type: none"> • <i>The results of any audits or reviews of sampling techniques and data.</i> 	<p>Bandjougoy, Tsengué, Flouflou and Bingamba North</p> <ul style="list-style-type: none"> • Independent consultant WSP Golder has visited Baniaka twice, in October 2016 and in October 2017 as part of conducting ongoing Mineral Resource Estimates. Sampling techniques and data were considered fit for the estimation of Mineral Resources by WSP Golder.

Section 2 – Sampling Reporting of Exploration Results

(Criteria in this section apply to all succeeding sections)

Criteria	JORC Code explanation	Commentary
Mineral tenement and land tenure status	<ul style="list-style-type: none"> • <i>Type, reference name/number, location and ownership including agreements or material issues with third parties such as joint ventures, partnerships, overriding royalties, native title interests, historical sites, wilderness or national park and environmental settings.</i> • <i>The security of the tenure held at the time of reporting along with any known impediments to obtaining a licence to operate in the area.</i> 	<p>Bandjougoy, Tsengué, Flouflou and Bingamba North</p> <ul style="list-style-type: none"> • The PFS Prospects are on the Baniaka West Exploration Licence (Permis de Recherche Minière) G2-572 that covers 107km² and the Baniaka Exploration Licence (Permis de Recherche Minière) G2-537 that covers 774km². Reminac S.A., a wholly indirectly owned subsidiary of Genmin, owns 100% of the licences. • The Company declares herewith that the licences are in good standing and in compliance with the appropriate regulations. Baniaka West was renewed on 18 December 2020 for a further three (3) years. • The Company declares herewith that the Baniaka tenement is in good standing and in compliance with the appropriate regulations. Baniaka was extended on 7 July 2022 for a further six (6) years. • There is no history of difficulties with compliant mineral tenure in the Republic of Gabon, and the government is generally supportive of mineral development projects.
Exploration done by other parties	<ul style="list-style-type: none"> • <i>Acknowledgment and appraisal of exploration by other parties.</i> 	<p>Bandjougoy, Tsengué, Flouflou and Bingamba North</p> <ul style="list-style-type: none"> • Compagnie Minière de l'Ogooué, Moanda, Gabon (COMILOG) had a permit over the immediately adjacent area to the East in the late 1970s. Ground magnetic reconnaissance and pitting was conducted on the BIF units at Baniaka. No results were available for Genmin to review.

Criteria	JORC Code explanation	Commentary
		<ul style="list-style-type: none"> Several COMILOG pits in the Company’s adjacent Baniaka Exploration Licence were located and resampled (e.g. COMILOG Pit 31 or CP31 in the eponymous prospect).
Geology	<ul style="list-style-type: none"> <i>Deposit type, geological setting and style of mineralisation.</i> 	<p>Bandjougoy, Tsengué, Flouflou and Bingamba North</p> <ul style="list-style-type: none"> A residual blanket of colluvial and eluvial/lag gravels and duricrusts derives from weathering and erosion of bedrock. Laterite duricrust (LAT) and gravels (LCOL) are developed on the metamorphic rocks that flank the BIF units. Canga duricrust (CAN) and DID gravels are developed on BIF bedrock, forming the mineralised body. The LAT, LCOL, CAN, DID and HYB units are collectively termed the residuum. The residuum varies from 1m to 16m thick. In-situ BIF underlies the residuum and is divided into three main categories based on changes in the degree of weathering, iron oxide mineralogy, magnetic susceptibility and material strength with increasing depth below the residuum. The three (3) categories ordered by reducing oxidation state are as follows: <ul style="list-style-type: none"> Soft Oxidised BIF (SO); Intact Oxidised BIF (Intact Oxide); and Fresh primary BIF (Primary).
Drill hole Information	<ul style="list-style-type: none"> <i>A summary of all information material to the understanding of the exploration results including a tabulation of the following information for all Material drill holes:</i> <ul style="list-style-type: none"> <i>easting and northing of the drill hole collar</i> <i>elevation or RL (Reduced Level – elevation above sea level in metres) of the drill hole collar</i> <i>dip and azimuth of the hole</i> <i>down hole length and interception depth</i> <i>hole length.</i> <i>If the exclusion of this information is justified on the basis that the information is not Material and this exclusion does not detract from the understanding of the report, the</i> 	<p>Bandjougoy, Tsengué, Flouflou and Bingamba North</p> <ul style="list-style-type: none"> This table does not specifically relate to disclosure of individual drill hole information pertaining to exploration results, but Exploration Targets, MRE and Ore Reserves.

Criteria	JORC Code explanation	Commentary
	<p><i>Competent Person should clearly explain why this is the case.</i></p>	
<p>Data aggregation methods</p>	<ul style="list-style-type: none"> <i>In reporting Exploration Results, weighting averaging techniques, maximum and/or minimum grade truncations (e.g. cutting of high grades) and cut-off grades are usually Material and should be stated.</i> <i>Where aggregate intercepts incorporate short lengths of high-grade results and longer lengths of low-grade results, the procedure used for such aggregation should be stated and some typical examples of such aggregations should be shown in detail.</i> <i>The assumptions used for any reporting of metal equivalent values should be clearly stated.</i> 	<p>Bandjougoy, Tsengué, Flouflou and Bingamba North</p> <ul style="list-style-type: none"> No exploration results are reported. No metal equivalents are reported, and no metal equivalents have been used in the Exploration Targets, MRE and Ore Reserves.
<p>Relationship between mineralisation widths and intercept lengths</p>	<ul style="list-style-type: none"> <i>These relationships are particularly important in the reporting of Exploration Results.</i> <i>If the geometry of the mineralisation with respect to the drill hole angle is known, its nature should be reported.</i> <i>If it is not known and only the down hole lengths are reported, there should be a clear statement to this effect (e.g. 'down hole length, true width not known').</i> 	<p>Bandjougoy, Tsengué, Flouflou and Bingamba North</p> <ul style="list-style-type: none"> The residuum within the project is horizontal to sub-horizontal and is closely related to topographic variations. The true thickness of the mineralisation is largely represented by the intercept length within Auger drill holes. As some Auger holes do not reach in-situ basement material, the true thickness of the profile may not be wholly represented by the data in that location. In-situ mineralisation is constrained to BIF lithologies that dip at approximately 30 to 60 degrees to the North. Diamond drill hole direction and inclination has been planned to intersect BIF lithologies orthogonally where possible, with drill sections completed perpendicular to strike of the BIF. Sample intervals are considered appropriate for the style of mineralisation in the project area and are consistent with other publicly reported iron ore assets.
<p>Diagrams</p>	<ul style="list-style-type: none"> <i>Appropriate maps and sections (with scales) and tabulations of intercepts should be included for any significant discovery being reported These should include, but</i> 	<p>Bandjougoy, Tsengué, Flouflou and Bingamba North</p> <ul style="list-style-type: none"> This report relates to Exploration Targets and the estimation of MRE and Ore Reserves. Appropriate figures showing the morphology and extent of mineralisation are given in the body of the report.

Criteria	JORC Code explanation	Commentary
	<p><i>not be limited to a plan view of drill hole collar locations and appropriate sectional views.</i></p>	
<p>Balanced reporting</p>	<ul style="list-style-type: none"> Where comprehensive reporting of all Exploration Results is not practicable, representative reporting of both low and high grades and/or widths should be practiced to avoid misleading reporting of Exploration Results. 	<p>Bandjougoy, Tsengué, Flouflou and Bingamba North</p> <ul style="list-style-type: none"> This report relates to the reporting of Exploration Targets, MRE and Ore Reserves
<p>Other substantive exploration data</p>	<ul style="list-style-type: none"> Other exploration data, if meaningful and material, should be reported including (but not limited to): geological observations; geophysical survey results; geochemical survey results; bulk samples – size and method of treatment; metallurgical test results; bulk density, groundwater, geotechnical and rock characteristics; potential deleterious or contaminating substances. 	<p>Bandjougoy, Tsengué, Flouflou and Bingamba North</p> <ul style="list-style-type: none"> Genmin has undertaken surface mapping over most of the Baniaka project since 2012 and has utilised airborne and surface magnetic surveys to locate and define the strike length of the underlying BIF geology. Drilling, pitting and costean programs have confirmed the relationship between ground magnetic data and the presence of BIF, and typically associated residuum mineralisation. Historically, bench scale (45–58kg samples) metallurgical test work on the Tsengué prospect, the contiguous eastern extension of Bandjougoy indicated that wash and screen followed by density separation produce saleable products with low to market concentrations of deleterious elements with an appreciable mass yield for material with a head grade of residuum samples down to ~30% Fe. Subsequent results from tonnage scale pilot scale metallurgical test work for Bandjougoy and Tsengué DID sample MIN06039 realised iron product grades and mass yields as follows: <ul style="list-style-type: none"> Lump (-32+6mm) 64.8% Fe, at a mass yield of 27.7%; and Fines (-6+0.5mm) 65.2% Fe, at a mass yield of 37.6%. <p>The total mass yield was 65.3%. These results were reported to the ASX on 15 September 2021.</p> <ul style="list-style-type: none"> Genmin has updated its Exploration Targets to accommodate the MRE reported in Section 3 of this table, and are exclusive of the MRE <ul style="list-style-type: none"> DID: 28–51Mt at 43–54% Fe Oxide: 228 – 424Mt at 35–49% Fe Primary: 1,780 – 3,306Mt at 31–39% Fe <p>These Exploration Targets are based on the identified relationship between the true BIF thickness, BIF dip and BIF horizontal thickness with the presence and extent of DID and Oxide mineralisation at Baniaka. The Oxide iron grades assume a 1:1 split between Soft and Intact Oxide and DID iron grades a 3:1 split between high grade and low grade lithologies.</p>

Criteria	JORC Code explanation	Commentary
Further work	<ul style="list-style-type: none"> The nature and scale of planned further work (e.g. tests for lateral extensions or depth extensions or large-scale step-out drilling). Diagrams clearly highlighting the areas of possible extensions, including the main geological interpretations and future drilling areas, provided this information is not commercially sensitive. 	<p>Bandjougoy, Tsengué, Flouflou and Bingamba North</p> <ul style="list-style-type: none"> Genmin has completed a further 36 Auger holes at Bandjougoy on a nominal 50 x 25m spacing to study the shorter-range geology and quality variability and determine the recommended spacing for Measured classification of DID mineralisation. The samples are awaiting preparation and analysis. In addition to exploration works, the following major work packages are underway: Ongoing Social and Environmental Impact Assessment (SEIA). Genmin has completed a further 36 Auger holes at Bandjougoy on a nominal 50m x 25m spacing to study the shorter-range geology and quality variability and determine the recommended spacing for Measured classification of DID mineralisation. The samples are awaiting preparation and analysis. Genmin has also conducted infill drilling to achieve a nominal drill spacing of 200m x 50m for the DID portion of Bingamba North mineralisation (Auger drilling), and the Oxide portion of in-situ Bandjougoy and Tsengué mineralisation (reverse circulation and diamond drilling). This drilling is complete, and part of the assays have been received and are being reviewed. A further infill program of 2,000m of drilling to upgrade the Inferred Oxide Mineral Resource at Bingamba North is planned and scheduled for completion in late 2022. This drill program is part of ongoing resource definition work and is outside the scope of the PFS.

Section 3 – Estimation and Reporting of Mineral Resources

JORC Code Explanation	Commentary
<p>Database integrity</p> <p>Measures taken to ensure that data has not been corrupted by, for example, transcription or keying errors, between its initial collection and its use for Mineral Resource estimation purposes.</p> <p>Data validation procedures used.</p>	<p>Bandjougoy, Tsengué, Flouflou and Bingamba North</p> <ul style="list-style-type: none"> Collar Information: Positional data is loaded into the database by an independent contractor. Where vertical accuracy is lacking, the sample location is registered to the LiDAR topographic DEM. Survey Information: Survey data is captured digitally and validated on site; where it significantly differs from theoretical drilling parameters, confirmation readings are collected. Geology Data: The geology data is recorded in Excel spreadsheets designed with drop-down lists to minimize data entry and transcription errors. It is then validated on site, prior to being sent to an independent contractor to load in a master database. Upon receipt of assays, a final validation is conducted before use in resource modelling. Assay Data: Assays are merged into the database from assay certificates and cross-validated with geological data.

JORC Code Explanation	Commentary
	<ul style="list-style-type: none"> • Bulk Density Data: Bulk density data obtained in pits and costeans and on core samples is periodically statistically validated to identify any outliers and underlying measurement errors. • QAQC Data: QC sample (field duplicates, blanks and CRM) lists are pre-populated before sampling. The data is systematically checked for errors before upload to the database. Corrective measures are undertaken where necessary to remediate any errors identified in the QAQC validation process.
<p>Site visits</p> <p>Comment on any site visits undertaken by the Competent Person and the outcome of those visits. If no site visits have been undertaken indicate why this is the case.</p>	<p>Bandjougoy, Tsengué, Flouflou and Bingamba North</p> <ul style="list-style-type: none"> • WSP Golder has visited the Project twice; once in October 2016 by Jorge Peres, an employee of WSP Golder at the time of the visit, and in October 2017, by Geordie Matthews, an employee of WSP Golder and under the supervision of Richard Gaze (Competent Person or CP). <ul style="list-style-type: none"> ◦ During the 2016 visit, WSP Golder observed sites at Bingamba North, Bingamba South and the eastern end of Tsengué. Auger drilling, pits and costeans were inspected and field observations of the excavations confirm details of the geology and morphology of the mineralisation and genetic model proposed by Genmin. Outcropping BIF was observed. ◦ During the 2017 visit, WSP Golder travelled to the Tsengué Base Camp, and from there observed field activities including Auger and diamond drilling, recently dug pits and road cuttings. Sample storage, drying, geological logging and sampling procedures were observed in practice. Historic and in progress drilling sites were visited and comparison of diamond drill pads photographs to the LiDAR topography compared as a visual check of spatial conformity and consistency. The difficulties in collecting handheld GPS readings under heavy canopy were noted.
<p>Geological interpretation</p> <p>Confidence in (or conversely, the uncertainty of) the geological interpretation of the mineral deposit. Nature of the data used and of any assumptions made. The effect, if any, of alternative interpretations on Mineral Resource estimation. The use of geology in guiding and controlling Mineral Resource estimation. The factors affecting continuity both of grade and geology.</p>	<p>Bandjougoy, Tsengué, Flouflou and Bingamba North</p> <ul style="list-style-type: none"> • The geology model was derived from all available validated data and created with Leapfrog Geo with additional manual controls in the interpretation process where data was insufficient to support an implicit interpretation. • Residuum: The geology and morphology of the residuum mineralisation proposed by Genmin, having been refined over the course of continued work on the Project, has proven to be robust and supported by field data. While the interactions between the in-situ profile, paleo-erosional events (colluvial movement) and recent erosional events (as a result of the progression of the current drainage network) are not fully understood, these subtleties are considered to have a relatively minor impact on the total volume and are mitigated in part by the recognition of soft geological boundaries. • The residuum geology model is created in three stages, as follows:

JORC Code Explanation	Commentary
	<ul style="list-style-type: none"> ○ The first stage defines the upper and lower limits of the residuum, with loess and soil above and basement beneath. The shape and trends of the residuum is guided by the topography to which it is closely related. ○ The second, modelled within the residuum, is a hybrid (HYB) shell defined by sample intervals being logged as material type, containing a dominant or major population of SO particles (>25% passing 1mm) or by sample intervals having a grade greater than or equal to 40% Fe. ○ The third is a 40% Fe grade shell, the DID shell, which is created using a 40% Fe cut-off grade and constrained within the HYB shell. <ul style="list-style-type: none"> • The HYB shell may be coincident with the 40% Fe grade shell, indicating a hard boundary between mineralised and unmineralised residuum. • The remaining residuum is termed LCOL and is unmineralised or marginally mineralised (waste). • Pit and costean sample data are used where the samples are derived from wall channels. Floor samples and attributed geology were discarded as they could not be effectively located spatially and lacked continuous grade sampling. There are no current alternate hypotheses or interpretations that inform the geology model better than is achieved using current interpretation and practice. <p>General: The following influences have been shown to have a material effect on the geological and grade continuity of the mineralisation:</p> <ul style="list-style-type: none"> • Recent surficial erosion as expressed by the current drainage system. Erosion may result in the depletion or removal of the residuum horizon, downslope (colluvial) movement and mixing or where there are incisions into the plateaux or ridge lines, absence of the entire profile. • Structural complexity, particularly faulting of and intrusive bodies within, the underlying BIF units. • For the MRE, extrapolation beyond the limits of the data was nominally limited to half the drill spacing laterally and to the limits of the drill data vertically on a section-by-section basis. <p>All geology models were based on sectional interpretations provided by Genmin, and implicit modelling based on grade and geological logging. All geology models are reviewed, validated and approved for use in MRE by senior Genmin personnel.</p>
<p>Dimensions</p>	<p>Bandjougoy, Tsengué, Flouflou and Bingamba North</p>
<p>The extent and variability of the Mineral Resource expressed as length (along strike or otherwise), plan width, and depth below surface to the upper and lower limits of the Mineral Resource.</p>	<ul style="list-style-type: none"> • The strike length of each 40% Fe shell for Bandjougoy and Tsengué is approximately 3,770m and 5,070m respectively. • The 40% Fe envelope continues uninterrupted from the western limit of Tsengué westward into Bandjougoy. The boundary between Tsengué and Bandjougoy is delineated by licence boundaries.

JORC Code Explanation	Commentary
	<ul style="list-style-type: none"> • The width of the 40% Fe shell varies with topography (past and present) and width of the underlying BIF. In places, recent rivers and valleys incise or break continuity. • Soil and loess ranges from 0.5m to 10m thick throughout the Project, covering the residuum. • The residuum is a surficial entity with limited vertical extent within ~26m of the surface. • The vertical thickness of the 40% Fe shell, which is contained within the residuum horizon, is greatest directly above the underlying BIF and then thins to pinch out laterally across strike, and typically does not exceed ~16m in thickness. <p>Flouflou DID</p> <ul style="list-style-type: none"> • The strike length of the 40% Fe shell for Flouflou is approximately 2,260m. • The 40% Fe presents as a wide blanket following the trend of the underlying stratigraphy and displays a broad fold with the western limb trending to the northwest and the eastern limb trending east-southeast. • The width of the 40% Fe shell varies with topography (past and present) and width of the underlying BIF. In places, recent rivers and valleys incise or break continuity. • Soil and Loess ranges from 0.5m to 10m thick throughout the Project, covering the residuum. • The residuum is a surficial entity with limited vertical extent within ~26m of the surface. • The vertical thickness of the 40% Fe shell, which is contained within the residuum horizon, is greatest directly above the underlying BIF and then thins to pinch out laterally across strike, and typically does not exceed ~17m in thickness. <p>Bingamba North DID</p> <ul style="list-style-type: none"> • The strike length of the 40% Fe shell for Bingamba North is approximately 3,100m. • The 40% Fe presents as a blanket following the trend of the underlying stratigraphy trending northwest-southeast • The width of the 40% Fe shell varies along strike with an average width of 250m. • Soil and Loess ranges from 0.5m to 10m thick throughout the Project, covering the residuum. • The residuum is a surficial entity with limited vertical extent within ~26m of the surface. • The vertical thickness of the 40% Fe shell, which is contained within the residuum horizon, is greatest directly above the underlying BIF and then thins to pinch out laterally across strike, and typically does not exceed ~15m in thickness.
<i>Estimation and modelling techniques</i>	Bandjougoy and Tsengué DID
The nature and appropriateness of the estimation technique(s) applied and key assumptions, including treatment of extreme grade values, domaining,	<ul style="list-style-type: none"> • All drill data available to WSP Golder as of 5 May 2022 was used for the interpretation and estimation.

JORC Code Explanation	Commentary
<p>interpolation parameters and maximum distance of extrapolation from data points. If a computer assisted estimation method was chosen include a description of computer software and parameters used.</p> <p>The availability of check estimates, previous estimates and/or mine production records and whether the Mineral Resource estimate takes appropriate account of such data.</p> <p>The assumptions made regarding recovery of by-products.</p> <p>Estimation of deleterious elements or other non-grade variables of economic significance (e.g. sulphur for acid mine drainage characterisation).</p> <p>In the case of block model interpolation, the block size in relation to the average sample spacing and the search employed.</p> <p>Any assumptions behind modelling of selective mining units.</p> <p>Any assumptions about correlation between variables.</p> <p>Description of how the geological interpretation was used to control the resource estimates.</p> <p>Discussion of basis for using or not using grade cutting or capping.</p> <p>The process of validation, the checking process used, the comparison of model data to drill hole data, and use of reconciliation data if available.</p>	<ul style="list-style-type: none"> • The Mineral Resource block model used Ordinary Kriging (OK) for grade estimation. All geological and grade domains, including waste domains, are estimated where an adequate number of samples are present. • As the residuum closely follows the contours of the topography, and the mineralised proportion generally is coincident with the underlying basement, unfolding was employed to compensate for vertical variability along and across strike. • Spatial grade continuity was quantified by semi-variogram (variogram) models based on along-strike, cross-strike and downhole variograms for each element. The calculations were applied to the unfolded dataset. The resulting variogram models provided the sample weights for the OK grade estimate. • The search ellipse orientation is set to conform to the local geological trend within each domain (where necessary) to ensure samples are selected from within each discrete unit, with the minor axis (direction of least continuity or highest variability) vertical. • Residuum grade estimates used an unfolding approach to the base of the residuum to minimise the effects of topographic variation on the grade model. As the residuum blanket is a product of weathering, oxidation and depletion of the underlying basement geology, this contact was chosen as the reference surface for unfolding. • Samples are length-weighted for estimation. • Proprietary WSP Golder software was used for unfolding, to perform variography, interpolate grades and validate the resulting models. Maptek Vulcan was used to create, composite and flag the drill dataset and to create and flag the block model. • Conformance between sample data and the grade estimate is acceptable, and visual validation and trend plots confirm grade data is honoured spatially. • The recovered product – particulate enriched and oxidised BIF fragments – provides no secondary by-product of notable value. • The grade estimation includes the following 12 elements and oxides: Fe, SiO₂, Al₂O₃, P, S, LOI, CaO, MgO, Mn, Na₂O, K₂O and TiO₂. • There is no indication that deleterious elements will present issues during mining and rehabilitation, such as acid mine drainage, however the clayey nature of the loess and residuum waste may require careful management in the equatorial environment of Gabon to avoid release of fine sediment into streams and rivers. • The block model block sizes are as follows: <ul style="list-style-type: none"> ◦ Parent Block Size: 25m × 25m × 4m

JORC Code Explanation	Commentary
	<ul style="list-style-type: none"> ○ Sub-block Size: 5m × 5m × 1m ○ Estimation Panel Size: 25m × 25m × 4m • Block sizes were chosen to accommodate the vertical thickness of the mineralised domains and sample lengths of the drill data. The estimation panel size was selected based on the orientation of the mineralised domain, average drill section spacing and on section hole spacing for each Prospect. • No selective mining unit or minimum mining width and height was used in either the estimation process or classification. The grade estimates reflect the mining selectivity reflected by the estimation panel size used. • Iron ore assay suites tend to be a whole rock assay, with the sum of the proportion all components totalling to ~100%. The estimation approach honours this relationship and any relationship between analytes by estimating all grade variables together and selecting the same sample population for estimation of each variable. On a global basis the total assay and total estimated values agree within acceptable tolerance of ±10% of the total assay. • The following geological and/or grade domains were estimated independently (using hard boundaries): <ul style="list-style-type: none"> ○ 40% Fe grade shell ○ HYB fragment shell ○ LCOL waste ○ Cover (soil and loess) ○ Basement country rock ○ Grade capping is not applied to the dataset prior to estimation as the population distributions are negatively skewed, meaning that apparent grade outliers existing in the low-grade portion of the distribution. Typically, the lowest grades within mineralised domains are internal waste and therefore were not capped. All waste domains are unclassified and excluded from the Mineral Resource. ○ The grade estimates were compared to the sample data visually and statistically and the grade estimate was found to be globally representative of the sample data, with average grade conformance generally within ±10%. There are no other datasets to compare the model to. <p>Flouflou DID</p> <ul style="list-style-type: none"> • All drill data available to WSP Golder as of 24 May 2022 was used for the interpretation and estimation, from drilling completed between 2018 and 2022 inclusive. • The Mineral Resource block model had OK for grade estimation method. All geological and grade domains, including waste domains, are estimated where an adequate number of samples are present.

JORC Code Explanation	Commentary
	<ul style="list-style-type: none"> • As the residuum closely follows the contours of the topography, and the mineralised proportion generally is coincident with the underlying basement, unfolding was employed to compensate for vertical variability along and across strike. • Spatial grade continuity was quantified by variogram models based on along-strike, cross-strike and downhole variograms for each element. The calculations were applied to the unfolded dataset. The resulting variogram models provided the sample weights for the OK grade estimate. • The search ellipse orientation is set to conform to the local geological trend within each domain (where necessary) to ensure samples are selected from within each discrete unit, with the minor axis (direction of least continuity or highest variability) vertical. • Residuum grade estimates used an unfolding approach to the base of the residuum to minimise the effects of topographic variation on the grade model. As the residuum blanket is a product of weathering, oxidation and depletion of the underlying basement geology, this contact was chosen as the reference surface for unfolding. • Samples are length-weighted for estimation. • Proprietary WSP Golder software was used for unfolding, to perform variography, interpolate grades and validate the resulting models. Maptek Vulcan was used to create, composite and flag the drill dataset and to create and flag the block model. • Conformance between sample data and the grade estimate is acceptable, and visual validation and trend plots confirm grade data is honoured spatially. • The recovered product – particulate enriched and oxidised BIF fragments – provides no secondary by-product of notable value. The grade estimation includes the following 11 elements and oxides: Fe, SiO₂, Al₂O₃, P, S, LOI¹⁰⁰⁰, MgO, Mn, Na₂O, K₂O, and TiO₂. • There is no indication that deleterious elements will present issues during mining and rehabilitation, such as acid mine drainage, however the clayey nature of the loess and residuum waste may require careful management in the equatorial environment of Gabon to avoid release fine sediment into streams and rivers. • The block model block sizes are as follows: <ul style="list-style-type: none"> ○ Parent Block Size: 25m × 25m × 4m ○ Sub-block Size: 5m × 5m × 1m ○ Estimation Panel Size: 25m × 25m × 4m

JORC Code Explanation	Commentary
	<ul style="list-style-type: none"> • Block sizes were chosen to accommodate the vertical thickness of the mineralised domains and sample lengths of the drill data. The estimation panel size was selected based on the orientation of the mineralised domain, average drill section spacing and on section hole spacing for each Prospect. • No selective mining unit or minimum mining width and height was used in either the estimation process or classification. The grade estimates reflect the mining selectivity reflected by the estimation panel size used. • Iron ore assay suites tend to be a whole rock assay, with the sum of the proportion all components totalling to ~100%. The estimation approach honours this relationship and any relationship between analytes by estimating all grade variables together and selecting the same sample population for estimation of each variable. On a global basis the total assay and total estimated values agree within acceptable tolerance of ±10% of the total assay. • The following geological and/or grade domains were estimated independently (using hard boundaries): <ul style="list-style-type: none"> ○ 40% Fe grade shell ○ HYB fragment shell ○ LCOL waste ○ Cover (soil and Loess) • Grade capping is not applied to the dataset prior to estimation as the population distributions are negatively skewed for the main element Fe, meaning that apparent grade outliers existing in the low-grade portion of the distribution. Typically, the lowest grades within mineralised domains are internal waste and therefore were not capped. All waste domains are unclassified and excluded from the Mineral Resource. • The grade estimates were compared to the sample data visually and statistically and the grade estimate was found to be globally representative of the sample data, with average grade conformance generally within ±10%. There are no other datasets with which to compare the model. <p>Bingamba North DID</p> <ul style="list-style-type: none"> • All drill data available to WSP Golder as of 4 July 2022 was used for the interpretation and estimation, from drilling conducted between 2015 and 2022. • The Mineral Resource block model had OK for grade estimation method. All geological and grade domains, including waste domains, are estimated where an adequate number of samples are present. • As the residuum closely follows the contours of the topography, and the mineralised proportion generally is coincident with the underlying basement, unfolding was employed to compensate for vertical variability along and across strike.

JORC Code Explanation	Commentary
	<ul style="list-style-type: none"> • Spatial grade continuity was quantified by variogram models based on along-strike, cross-strike and downhole variograms for each element. The calculations were applied to the unfolded dataset. The resulting variogram models provided the sample weights for the OK grade estimate. • The search ellipse orientation is set to conform to the local geological trend within each domain (where necessary) to ensure samples are selected from within each discrete unit, with the minor axis (direction of least continuity or highest variability) vertical. • Residuum grade estimates used an unfolding approach to the base of the residuum to minimise the effects of topographic variation on the grade model. As the residuum blanket is a product of weathering, oxidation and depletion of the underlying basement geology, this contact was chosen as the reference surface for unfolding. • Samples are length-weighted for estimation. Proprietary WSP Golder software was used for unfolding, to perform variography, interpolate grades and validate the resulting models. Maptek Vulcan was used to create, composite and flag the drill dataset and to create and flag the block model. • Conformance between sample data and the grade estimate is acceptable, and visual validation and trend plots confirm grade data is honoured spatially. • The recovered product – particulate enriched and oxidised BIF fragments – provides no secondary by-product of notable value. The grade estimation includes the following 11 elements and oxides: Fe, SiO₂, Al₂O₃, P, S, LOI¹⁰⁰⁰, MgO, Mn, Na₂O, K₂O, and TiO₂. • There is no indication that deleterious elements will present issues during mining and rehabilitation, such as acid mine drainage, however the clayey nature of the loess and residuum waste may require careful management in the equatorial environment of Gabon to avoid release of fine sediment into streams and rivers. • The block model block sizes are as follows: <ul style="list-style-type: none"> ○ Parent Block Size: 25m × 25m × 4m ○ Sub-block Size: 5m × 5m × 1m ○ Estimation Panel Size: 25m × 25m × 4m • Block sizes were chosen to accommodate the vertical thickness of the mineralised domains and sample lengths of the drill data. The estimation panel size was selected based on the orientation of the mineralised domain, average drill section spacing and on section hole spacing for each Prospect. • No selective mining unit or minimum mining width and height was used in either the estimation process or classification. The grade estimates reflect the mining selectivity reflected by the estimation panel size used.

JORC Code Explanation	Commentary
	<ul style="list-style-type: none"> • Iron ore assay suites tend to be a whole rock assay, with the sum of the proportion all components totalling to ~100%. The estimation approach honours this relationship and any relationship between analytes by estimating all grade variables together and selecting the same sample population for estimation of each variable. On a global basis the total assay and total estimated values agree within acceptable tolerance of $\pm 10\%$ of the total assay. • The following geological and/or grade domains were estimated independently (using hard boundaries): <ul style="list-style-type: none"> ○ 40% Fe grade shell ○ HYB fragment shell ○ LCOL waste ○ Cover (soil and Loess) • Grade capping is not applied to the dataset prior to estimation as the population distributions are negatively skewed for the main element Fe, meaning that apparent grade outliers existing in the low-grade portion of the distribution. Typically, the lowest grades within mineralised domains are internal waste and therefore were not capped. All waste domains are unclassified and excluded from the Mineral Resource. • The grade estimates were compared to the sample data visually and statistically and the grade estimate was found to be globally representative of the sample data, with average grade conformance generally within $\pm 10\%$. There are no other datasets with which to compare the model.
<i>Moisture</i>	Bandjougoy, Tsengué, Flouflou and Bingamba North
Whether the tonnages are estimated on a dry basis or with natural moisture, and the method of determination of the moisture content.	<ul style="list-style-type: none"> • Tonnages are estimated and quoted on a dry basis
<i>Cut-off parameters</i>	Bandjougoy, Tsengué, Flouflou and Bingamba North
The basis of the adopted cut-off grade(s) or quality parameters applied.	<ul style="list-style-type: none"> • The residual iron ore mineralisation throughout the PFS Prospects is driven by the proportion of recoverable SO fragments. At a head grade of 40% Fe, most samples have a large recoverable fragment content. Where samples contain at least 25% of ≥ 1 mm eBIF fragments but grade is less than 40% Fe, mass yield is lower, but the recovered product remains saleable. • The 40% Fe grade shell is reported at a nominal 40% Fe cut-off grade implied by the grade shell, and the HYB shell is reported with the HYB shell and at a 30% Fe cut-off grade, which is the lower limit of the grade population with $\geq 25\%$ SO fragments. All estimated waste domains, including the basement geology, have been capped to 30% Fe.

JORC Code Explanation	Commentary
<p data-bbox="100 343 492 375"><i>Mining factors or assumptions</i></p> <p data-bbox="100 383 817 774">Assumptions made regarding possible mining methods, minimum mining dimensions and internal (or, if applicable, external) mining dilution. It is always necessary as part of the process of determining reasonable prospects for eventual economic extraction to consider potential mining methods, but the assumptions made regarding mining methods and parameters when estimating Mineral Resources may not always be rigorous. Where this is the case, this should be reported with an explanation of the basis of the mining assumptions made.</p>	<p data-bbox="837 343 1489 375">Bandjougoy, Tsengué, Flouflou and Bingamba North</p> <ul data-bbox="837 383 2136 1276" style="list-style-type: none"> • RPEEE has been assessed for the MRE's • Resource models with parent block size 25m (X) by 25m (Y) by 4m (Z) were used for the assessment of the RPEEE, with an assumed ore loss and dilution of 0.5% and 6% respectively. • Mining is via conventional open pit load and haul. Mining costs are estimated at US\$3.59/t mined. Incremental haulage costs of US\$0.15/tkm have also been included in the assessment. • Consideration was given to processing costs based on the requirement for processing the DID material, mass yield and rail transport from site to port. Processing costs are estimated to be US\$2.95/t ore for DID material, general and administration costs of US\$2.00/t ore and transport from mine to port US\$26.36/t product. • A capital cost allowance has been included in the RPEEE optimisation for the provision of crush, scrubbing and dense media processing plant and mine site infrastructure. Third party capital costs including rail, port and power are excluded as they are covered under operating charges. WSP Golder considers the capital cost allowances to be appropriate for the purposes of assessing RPEEE. • Product prices were based on research by AME Mineral Economics Pty Limited (AME) dated Q1 2022. The base price for 62% Fe CFR was US\$125/t (May 2022). Prices were adjusted for value in use (VIU) premiums for both Lump and Fines products. The VIU premiums were determined by independent Central South University (CSU) in Hunan, China on Lump and Fines samples from the 2021 pilot scale metallurgical test program. RPEEE was also tested at a forecast LTP discounted by 26%. No material changes were noted in the reported tonnages or grades between pit shells using May 2022 or LTP. • Shipping costs from Gabon to northern China were estimated to be US\$15.00/t product. • Royalty rates are based on the 2019 Mining Code of Gabon. The 2019 Mining Code Article 205 specifies that royalty rates for Base Metals and Other substances is between 5-10% of the sale price of the mineral product following deduction of allowable fees, taxes and costs. An assumed midpoint royalty rate of 7.5% has been used for RPEEE. NPV was calculated at a 15% discount rate. • The pit optimisations used to test RPEEE are for that purpose only.
<p data-bbox="100 1324 571 1356"><i>Metallurgical factors or assumptions</i></p> <p data-bbox="100 1364 817 1468">The basis for assumptions or predictions regarding metallurgical amenability. It is always necessary as part of the process of determining reasonable prospects for</p>	<p data-bbox="837 1324 1489 1356">Bandjougoy, Tsengué, Flouflou and Bingamba North</p> <ul data-bbox="837 1364 2136 1468" style="list-style-type: none"> • Pilot and previous bench scale metallurgical test work demonstrated that saleable Lump (-32 + 6.3mm) and coarse Fines (-6.3 +1mm) were produced at acceptable mass yields at the cut-off grades used to delineate the Mineral Resource.

JORC Code Explanation	Commentary
<p>eventual economic extraction to consider potential metallurgical methods, but the assumptions regarding metallurgical treatment processes and parameters made when reporting Mineral Resources may not always be rigorous. Where this is the case, this should be reported with an explanation of the basis of the metallurgical assumptions made.</p>	<ul style="list-style-type: none"> • Tonnage scale pilot metallurgical test work commenced in 2021 and is ongoing. This work focuses on DID and Oxide samples and is well advanced at independent mineral processing and engineering group Bond Equipment in South Africa, to define engineering level process design criteria for the preliminary feasibility study (PFS). The results of the pilot test work have confirmed that the DID samples produce saleable quality lumps and fines, confirming combined product yields ranging from 55.5% to 65.3% and grades ranging from 64.1% Fe to and 65.1% Fe. • Results from the first samples processed were announced to the ASX on 15 September 2022. HYB samples collected for the pilot program were found to be elevated in grade beyond the target range of 30–40% Fe, and as such further sampling has been conducted to gather samples in the HYB grade range. • VIU test work has been conducted at CSU, China on composite Lump and Fines products from Baniaka. Results of the test work were announced to the ASX on 23 March 2022, and concluded that: <ul style="list-style-type: none"> ○ A lump premium of approximately 15% may be expected, after adjustments for grade and strength qualities ○ A fines premium of approximately 17% may also be expected. This premium was proposed by CSU based on and increase in productivity and reduction in solid fuel consumption during sintering when benchmarked against competitor fines products.
<p><i>Environmental factors or assumptions</i></p> <p>Assumptions made regarding possible waste and process residue disposal options. It is always necessary as part of the process of determining reasonable prospects for eventual economic extraction to consider the potential environmental impacts of the mining and processing operation. While at this stage the determination of potential environmental impacts, particularly for a greenfields project, may not always be well advanced, the status of early consideration of these potential environmental impacts should be reported. Where these aspects have not been considered this should be reported with an explanation of the environmental assumptions made.</p>	<p>Bandjougoy, Tsengué, Flouflou and Bingamba North</p> <ul style="list-style-type: none"> • The Company is undertaking a Social and Environmental Impact Assessment (SEIA) for Baniaka, which is based on the Bandjougoy and Tsengué combined DID and SO Resources, and DID only Resources for Flouflou and Bingamba North prospects. WSP Golder has been retained by the Company to complete the mine planning and waste storage components of the PFS. The preferred storage of mine waste and processing rejects is drystacking them together to minimise risk of potential environmental impacts. WSP Golder considers that the waste storage alternatives featured in the PFS studies to be suitable to support RPEEE.
<p>Bulk density</p>	<p>Bandjougoy, Tsengué, Flouflou and Bingamba North</p>

JORC Code Explanation	Commentary																																	
<p>Whether assumed or determined. If assumed, the basis for the assumptions. If determined, the method used, whether wet or dry, the frequency of the measurements, the nature, size and representativeness of the samples. The bulk density for bulk material must have been measured by methods that adequately account for void spaces (vugs, porosity, etc), moisture and differences between rock and alteration zones within the deposit. Discuss assumptions for bulk density estimates used in the evaluation process of the different materials.</p>	<ul style="list-style-type: none"> • Hand-dug pits are used to estimate the dry bulk density of unconsolidated material. Once the desired material type is reached, a sub-pit is excavated, and the extracted material weighted. The excavation is lined with a plastic sheet and filled with water to estimate its volume. The material was air dried prior to September 2017, and oven dried on site after that date, to obtain the moisture content and calculate a dry bulk density. Moisture content typically ranges 5% – 10%. • Two (2) large volume samples from pits at Tsengué and Bingamba have also been used to check the in-situ bulk density. A pit is mechanically dug into the desired material type with the material loaded directly into a truck, then volume of the hole is calculated from field measurement. The truck is then weighed at a calibrated weigh bridge and the difference between the empty and full truck giving a wet in-situ density for the pit. Representative moisture samples were collected to estimate a dry bulk density (8% – 11% moisture). • The water displacement method is not appropriate for unconsolidated core samples and has only been used on competent samples from the BIF and country rocks. • Bulk density values were assigned to the Mineral Resources as follows: <table border="1" data-bbox="880 831 1657 1289"> <thead> <tr> <th>Unit</th> <th>MINCODE</th> <th>Density (g/cm³)</th> </tr> </thead> <tbody> <tr> <td>AIR</td> <td>0</td> <td>-</td> </tr> <tr> <td>Cover (COV)</td> <td>10</td> <td>1.14</td> </tr> <tr> <td>Colluvium (COL)</td> <td>20</td> <td>1.79</td> </tr> <tr> <td>DID (40% Fe shell)</td> <td>21</td> <td>2.56</td> </tr> <tr> <td>Hybrid (HYB)</td> <td>22</td> <td>2.17</td> </tr> <tr> <td>BIF (Generic)</td> <td>30</td> <td>2.82</td> </tr> <tr> <td>eBIF-1</td> <td>31</td> <td>2.82</td> </tr> <tr> <td>eBIF-2</td> <td>32</td> <td>3.01</td> </tr> <tr> <td>mBIF</td> <td>33</td> <td>3.34</td> </tr> <tr> <td>BIF (Basement)</td> <td>40</td> <td>2.24</td> </tr> </tbody> </table>	Unit	MINCODE	Density (g/cm ³)	AIR	0	-	Cover (COV)	10	1.14	Colluvium (COL)	20	1.79	DID (40% Fe shell)	21	2.56	Hybrid (HYB)	22	2.17	BIF (Generic)	30	2.82	eBIF-1	31	2.82	eBIF-2	32	3.01	mBIF	33	3.34	BIF (Basement)	40	2.24
Unit	MINCODE	Density (g/cm ³)																																
AIR	0	-																																
Cover (COV)	10	1.14																																
Colluvium (COL)	20	1.79																																
DID (40% Fe shell)	21	2.56																																
Hybrid (HYB)	22	2.17																																
BIF (Generic)	30	2.82																																
eBIF-1	31	2.82																																
eBIF-2	32	3.01																																
mBIF	33	3.34																																
BIF (Basement)	40	2.24																																
<p>Classification</p>																																		

JORC Code Explanation	Commentary
<p>The basis for the classification of the Mineral Resources into varying confidence categories.</p> <p>Whether appropriate account has been taken of all relevant factors (i.e. relative confidence in tonnage/grade estimations, reliability of input data, confidence in continuity of geology and metal values, quality, quantity and distribution of the data).</p> <p>Whether the result appropriately reflects the Competent Person’s view of the deposit.</p>	<p>Bandjougoy, Tsengué, Flouflou and Bingamba North</p> <ul style="list-style-type: none"> • The Mineral Resources are classified as Indicated. The detrital mineralisation is drilled to a 200m by 50m spacing and shows good continuity along strike and conforms to the current understanding of the geological profile of the Baniaka mineralisation. Mineral Resource confidence for the DID Mineral Resources relies on the following guidelines: <ul style="list-style-type: none"> ◦ Drill Spacing: Indicated Resources have a maximum drill spacing of 200m between drill lines and 50m between drill holes. Inferred Mineral Resources have a maximum drill spacing of 400m between drill lines and 50m between drill holes. ◦ Geological confidence, i.e., the mineralisation well understood and having clear continuity, a higher confidence is supportable. There is a high level of confidence in the geological model and interpretation. The geomorphic model of the mineralisation has been demonstrated as a robust predictor of the extent, continuity, and grade profile of the mineralisation between drill lines and promotes confidence in the Mineral Resource. • The Competent Persons consider the Mineral Resource outcome adequate given their knowledge of the Project, the available data, the methods employed, and validations undertaken.
<p>Audits or reviews</p> <p>The results of any audits or reviews of Mineral Resource estimates.</p>	<p>Bandjougoy, Tsengué, Flouflou and Bingamba North</p> <ul style="list-style-type: none"> • SRK Consulting (Australasia) Pty Ltd (SRK) compiled an Independent Technical Report (ITR) on Genmin’s projects in Gabon dated April 2018. A high-level review of the Maiden DID MRE prepared by WSP Golder was undertaken. SRK concluded that: <i>“The classification of Mineral Resources was considered appropriate based on the distance between drilling sections, sampling information and the geological confidence criteria.”</i> • In January 2021, SRK prepared an Independent Geologists Report (IGR) for the Genmin initial public offering Prospectus. As part of the IGR, SRK completed a high-level review of the DID, Oxide and Primary MRE prepared by WSP Golder. In the Summary of the IGR, SRK concluded that: <i>“In SRK’s opinion, the Mineral Resource and Exploration Target estimates reported for the Mineral Assets are acceptable as a reasonable representation of global grades and tonnages and have been prepared to a sufficient quality standard under the guidelines set out in the JORC Code (2012).”</i> • The conclusions of the ITR and IGR provide independent opinion that the methodologies taken in the collection & interpretation of geological data, and subsequent MRE are appropriate for the style of mineralisation and are of sufficient quality to report Mineral Resources in accordance with the JORC Code.

JORC Code Explanation	Commentary
<p>Discussion of relative accuracy/confidence</p> <p>Where appropriate a statement of the relative accuracy and confidence level in the Mineral Resource estimate using an approach or procedure deemed appropriate by the Competent Person. For example, the application of statistical or geostatistical procedures to quantify the relative accuracy of the resource within stated confidence limits, or, if such an approach is not deemed appropriate, a qualitative discussion of the factors that could affect the relative accuracy and confidence of the estimate.</p> <p>The statement should specify whether it relates to global or local estimates, and, if local, state the relevant tonnages, which should be relevant to technical and economic evaluation. Documentation should include assumptions made and the procedures used.</p> <p>These statements of relative accuracy and confidence of the estimate should be compared with production data, where available.</p>	<p>Bandjougoy, Tsengué, Flouflou and Bingamba North</p> <ul style="list-style-type: none"> • No numerical quantification of the confidence level of the Mineral Resources in terms of tonnage or grade has been undertaken. • Confidence in the models is directly related to drill spacing. Prior work by WSP Golder indicated that a 400m section spacing is the limit of an Inferred Mineral Resource, and where geological continuity is assessed to be good, a 200m section spacing is the limit of an Indicated Resource. Classification confidence decreases with structural complexity and with decreasing strike length and width. • There is no production or trial mining data with which to compare the Mineral Resources.

Section 4 – Estimation and Reporting of Ore Reserves

JORC Code Explanation	Commentary
<p>Mineral Resource estimate for conversion to Ore Reserves</p> <ul style="list-style-type: none"> • <i>Description of the Mineral Resource estimate used as a basis for the conversion to an Ore Reserve.</i> • <i>Clear statement as to whether the Mineral Resources are reported additional to, or inclusive of the Ore Reserves.</i> 	<ul style="list-style-type: none"> • The MRE for Flouflou, Bandjougoy, Tsengué and Bingamba North reported October 2022 were used as the basis for the Ore Reserve estimate. The MRE was estimated using exploration data collated by Genmin since 2015 and is further detailed in the 2022 PFS MRE (21462819-014-R-Rev0). • The Mineral Resources reported herein are inclusive of Ore Reserves.
Site Visits	

JORC Code Explanation	Commentary
<ul style="list-style-type: none"> • <i>Comment on any site visits undertaken by the Competent Person and the outcome of those visits.</i> • <i>If no site visits have been undertaken indicate why this is the case</i> 	<ul style="list-style-type: none"> • The Competent Person for Ore Reserves (Allan Blair, Principal Mining Engineer, WSP Golder) visited Baniaka and its associated supporting infrastructure during a site visit in September 2022. As a result of the site visit and review of the associated PFS studies, the CP is satisfied that there are reasonable grounds to estimate and report an Ore Reserve Estimate.
<p>Study Status</p> <ul style="list-style-type: none"> • <i>The type and level of study undertaken to enable Mineral Resources to be converted to Ore Reserves.</i> • <i>The Code requires that a study to at least Pre-Feasibility Study level has been undertaken to convert Mineral Resources to Ore Reserves. Such studies will have been carried out and will have determined a mine plan that is technically achievable and economically viable, and that material Modifying Factors have been considered.</i> 	<ul style="list-style-type: none"> • Genmin has led the completion of a PFS which has investigated and reported all Modifying Factors considered material to enable the conversion of Mineral Resources to Ore Reserves. • The Ore Reserve Estimate and accompanying mine plan are technically achievable and economically viable.
<p>Cut-off parameters</p> <ul style="list-style-type: none"> • <i>The basis of the cut-off grade(s) or quality parameters applied.</i> 	<ul style="list-style-type: none"> • Cut-off grades are informed using quality parameters determined by metallurgical test work, including grade and particle size distribution analysis for iron and steel making elements and their oxides. • Fixed and variable operating costs also inform the estimation of cut-off grades, with cut-off grades being variable depending on the quality of material being mined and processed.
<p>Mining factors or assumptions</p> <ul style="list-style-type: none"> • <i>The method and assumptions used as reported in the Pre-Feasibility or Feasibility Study to convert the Mineral Resource to an Ore Reserve (i.e. either by application of appropriate factors by optimisation or by preliminary or detailed design).</i> • <i>The choice, nature and appropriateness of the selected mining method(s) and other mining parameters including associated design issues such as pre-strip, access, etc.</i> • <i>The assumptions made regarding geotechnical parameters (eg pit slopes, stope sizes, etc), grade control and pre-production drilling.</i> 	<ul style="list-style-type: none"> • The Resource models, which form the basis for estimation of the Ore Reserve, were combined and regularised to account for dilution and ore loss. The resulting regularised mining model was then used in an open pit optimisation assessment using the industry standard GEOVIA Whittle 4X software. A range of pit shells were produced using operating costs and other inputs derived from the supporting PFS level study. The resultant optimal pit shells were then used as a basis for detailed pit designs. • A detailed mining schedule was completed using Minemax Scheduling software. • The mining method selected is conventional open cut truck and shovel fleet, with limited drill and blast required. Both rigid body off-highway mining trucks and articulated mining trucks of 20–90t capacity will be required to mine the oxide, shallow deposit. • The open pit mine will be developed using a phased pit design. The CP considers the proposed mining method to be appropriate given the nature and geometry of the mineralisation and the scale of the proposed operations.

JORC Code Explanation	Commentary
<ul style="list-style-type: none"> • <i>The major assumptions made and Mineral Resource model used for pit and stope optimisation (if appropriate).</i> • <i>The mining dilution factors used.</i> • <i>The mining recovery factors used.</i> • <i>Any minimum mining widths used.</i> • <i>The manner in which Inferred Mineral Resources are utilised in mining studies and the sensitivity of the outcome to their inclusion.</i> • <i>The infrastructure requirements of the selected mining methods.</i> 	<ul style="list-style-type: none"> • PFS level geotechnical studies were completed by WSP Golder. The resultant recommended pit design parameters were used to determine the overall pit slope angle in the pit optimisations and bench and berm configurations in the pit designs. Dewatering of the orebody was also considered by WSP Golder, and appropriate allowances for dewatering and associated infrastructure are included in the project capital and operating costs. Grade control will be based on additional RC drilling. • Grade control is allowed for in the pit optimisation input costs and financial modelling. • The MRE detailed in the 2022 PFS MRE (21462819-014-R-Rev0) was regularised to a Selective Mining Unit (SMU) of 5 (X) x 5 (Y) x 4 (Z) m. This was determined by WSP Golder to best match the preferred equipment size, style and geometry of mineralisation and selectivity required for the scale of operation. • The CP considers that the SMU selected for use includes sufficient allowance for mining dilution and recovery factors, which were estimated by WSP Golder to be 94% mining recovery, and 2% dilution. • The minimum mining width considered was 20m. • No Inferred Mineral Resources were used in the final reporting of the Genmin 2021-2022 PFS or associated Ore Reserve Estimate. • The nominated mine site infrastructure includes waste rock dumps, stockpiles, and Run-Of-Mine (ROM) pad, processing plant, surface haul roads and other road networks, explosives storage facilities, mine and ancillary workshops, fuel storage/supply facilities, technical and administration facilities, and mine camp accommodation at Baniaka. • Beyond the mine site specific infrastructure, Genmin has developed a mine to Ocean-Going Vessel (OGV) solution which includes connection to the existing Trans-Gabon railway by a 60km rail spur, access to hydro-electricity supply from the Grand Poubara hydro-electricity scheme located approximately 30km North of Baniaka, and export of iron ore products via the existing Mineral Port at Owendo. Memoranda of Understanding are in place to support this infrastructure solution.
<p>Metallurgical factors or assumptions</p>	<ul style="list-style-type: none"> • The metallurgical process featured in the Baniaka PFS is industry standard for the production of iron ore Lump and Fines, and features crushing, scrubbing, primary and secondary sizing, and concentration of sized materials using Dense Media Separation (DMS) to produce saleable products. The metallurgical process is considered appropriate for this style of mineralisation. • The process flowsheet and plant design use well tested methods and equipment with no use of any novel or untested methodologies or technologies. The process plant has been designed to achieve a nameplate capacity of 5 million tonnes per annum (Mtpa) of product.
<ul style="list-style-type: none"> • <i>The metallurgical process proposed and the appropriateness of that process to the style of mineralisation.</i> • <i>Whether the metallurgical process is well-tested technology or novel in nature.</i> 	

JORC Code Explanation	Commentary
<ul style="list-style-type: none"> • <i>The nature, amount and representativeness of metallurgical test work undertaken, the nature of</i> • <i>the metallurgical domaining applied and the corresponding metallurgical recovery factors applied.</i> • <i>Any assumptions or allowances made for deleterious elements.</i> • <i>The existence of any bulk sample or pilot scale test work and the degree to which such samples are considered representative of the orebody as a whole.</i> • <i>For minerals that are defined by a specification, has the ore reserve estimation been based on the appropriate mineralogy to meet the specifications?</i> 	<ul style="list-style-type: none"> • Multiple tonnage scale pilot samples were taken across the full strike extent of the Baniaka deposits reported in the Ore Reserve Estimate and are considered representative of the ore types covered by the PFS. • Metallurgical domains that inform the PFS are directly associated with the gross material types (DID, Oxide BIF) domains that comprise the MRE. • Comprehensive 26 element chemical analyses have been undertaken on all samples used to inform the Ore Reserve Estimate and includes all payable and common deleterious elements for iron ore for both feed and product samples including Fe, P, S, SiO₂ and Al₂O₃. • Metallurgical yields and recoveries of iron and deleterious elements are dependent on material type and process feed iron head grade. They are modelled between 40% and 60% mass yield based on the results of pilot scale metallurgical test work conducted using commercial scale equipment. • Recoveries also considered VIU work conducted at CSU concluded that (see ASX announcement dated 23rd March 2022) that economic product grades are readily achievable from all ore types informing the Ore Reserve Estimate. The data concerning competitor iron ore products to support this statement was provided to Genmin by CSU, is considered commercial in confidence, and has been reviewed and considered reasonable for use by WSP Golder.
<p>Environmental</p> <ul style="list-style-type: none"> • <i>The status of studies of potential environmental impacts of the mining and processing operation. Details of waste rock characterisation and the consideration of potential sites, status of design options considered and, where applicable, the status of approvals for process residue storage and waste dumps should be reported</i> 	<ul style="list-style-type: none"> • In accordance with the Regulatory framework of the laws of the Republic of Gabon, Genmin presented Terms of Reference (ToR) including social and environmental studies to the Direction Générale of Environment & Nature Protection (DGEPN) in June 2022. The ToR were prepared in line with the DGEPN's draft review and subsequent recommendations and set out the proposed content of the Company's social and environmental baseline data collection program and subsequent impact assessment. The final ToR accommodating DGEPN's feedback and recommendations was approved, and therefore Genmin and its consultants Flora Fauna & Man Ecological Services and TERA (under the direction of WSP Golder) commenced study work at Baniaka. • WSP Golder was also retained by Genmin to complete mine and process waste disposal studies. These studies included waste rock characterisation and considered several sites and options for process and waste rock placement including dry stacking for fine grained process residues, and conventional dumps for waste rock. A co-disposal solution has been determined as optimal for the combined placement of process residue and fine-grained overburden. • Chemical, mineralogical, and water analyses have not identified concentrations of any potential acid or contaminant forming elements such as sulphur in sulphides, or their weathering by- products.

JORC Code Explanation	Commentary
	<ul style="list-style-type: none"> Further to discussions and feedback from the DGEPN Genmin does not have any reason to believe that the required environmental permits for the planned mining and processing operation (including waste storage facilities) will not be granted should Genmin continue to comply with its approved ToR.
<p>Infrastructure</p> <ul style="list-style-type: none"> <i>The existence of appropriate infrastructure: availability of land for plant development, power, water, transportation (particularly for bulk commodities), labour, accommodation; or the ease with which the infrastructure can be provided, or accessed.</i> 	<p>Land</p> <ul style="list-style-type: none"> The immediate area surrounding Baniaka is sufficient to accommodate the construction of the planned mining operation and associated infrastructure set out in the Baniaka PFS. <p>Labour</p> <ul style="list-style-type: none"> Baniaka is located approximately 60km from two (2) major regional cities (Franceville and Moanda), both which have served Gabon’s mature manganese mining industry since the 1960’s. Professional and skilled labour is readily available in country, and in the immediate province servicing Baniaka. The School of Mining and Metallurgy of Moanda provides mining specific professional education to Gabonese nationals wishing to pursue a career in the mining industry. <p>Accommodation</p> <ul style="list-style-type: none"> Mine and construction workers for the Baniaka project will be accommodated at a mine village to be constructed at the Baniaka site. Early-stage construction workers will be accommodated at the Company’s already established exploration and study camp, which currently has accommodation for approximately 120 persons. Personnel will work on a Drive-In Drive-Out shift basis. <p>Port & Rail</p> <ul style="list-style-type: none"> A Memorandum of Understanding (MoU) with Owendo Mineral Port (OMP) for an integrated rail and port logistics solution from Baniaka through to ocean-going, Cape-size (up to 180,000 DWT) vessels. The MoU outlines the parties will enter into tripartite agreement with SETRAG for accessing the Trans-Gabon Railway (TGR) initially via road transport and moving to a 100% rail solution following completion of a ~65km rail spur from Baniaka to the TGR railhead at Franceville. This will comprise an initial 10km spur followed by a ~55 km section to the process plant. <p>Electricity & Water</p> <ul style="list-style-type: none"> An MoU with la Société de Patrimoine du service public de l’eau potable, de l’Énergie électrique et de l’assainissement, operator of the Grand Poubara Hydroelectric Power Station located approximately

JORC Code Explanation	Commentary
	<p>30km northeast of Baniaka. The MoU addresses the supply of 30 megawatts of renewable hydroelectricity which will be delivered via a power transmission line to Baniaka. Water will be accessed from existing water sources in the Baniaka catchment area.</p>
<p>Costs</p> <ul style="list-style-type: none"> • <i>The derivation of, or assumptions made, regarding projected capital costs in the study.</i> • <i>The methodology used to estimate operating costs.</i> • <i>Allowances made for the content of deleterious elements.</i> • <i>The source of exchange rates used in the study.</i> • <i>Derivation of transportation charges.</i> • <i>The basis for forecasting or source of treatment and refining charges, penalties for failure to meet specification, etc.</i> • <i>The allowances made for royalties payable, both Government and private.</i> 	<p>The principal assumptions used in the derivation of PFS cost estimates are:</p> <ul style="list-style-type: none"> • A production rate of 5Mtpa of product which governs the scale of operation required to achieve that target • Contractor based mining and haulage of ore and waste • Principal to act as owner operator of process plant and ancillary infrastructure • Availability of low-cost hydroelectric power using distribution to mine gate to be provided by the Company • Product transport from mine/railhead and trans-shipping to OGV on a toll basis <p>CAPEX</p> <ul style="list-style-type: none"> • Capital cost estimates were provided by consultants to Genmin who are specialists in their respective fields, and whose work inform the PFS. <p>OPEX</p> <ul style="list-style-type: none"> • Mining costs were estimated using commercial budget estimates from mining contractors servicing African projects and validated against ground up owners' cost estimates grossed up by 20% to allow for contractors' margin. Contractor budget estimates were subsequently discounted by 10% match the Owners' estimates. • Provisions for deforestation have been included based on the surface area of pits, waste dumps and infrastructure. A clearance rate has been provided by US\$17,300 per hectare. • WSP Golder provided an estimate for rehabilitation of the mining and associated areas, implemented as a factor of waste movement. • Road haulage costs for the 18-month ramp-up period based on a 55km haul to the rail spur were estimated by both WSP Golder and validated by Genmin using quotations sourced by Genmin. • Process and all other ancillary operating costs were estimated by consultants to Genmin who are specialists in their respective fields, and whose work inform the PFS. • Genmin commissioned a PFS level study within Gabon regarding personnel costs, which informs all operating costs that are not provided as a contracted service. • The CP has reviewed the capital and operating cost estimates and considers that they have been estimated to a level of confidence reasonable for use in a PFS level study.

JORC Code Explanation	Commentary
	<ul style="list-style-type: none"> • Exchange rates forecasts were sourced from Bloomberg, Oxford Economics Economist Intelligence Unit, and in-house Genmin analysis. <p>Derivation of Transport Charges</p> <ul style="list-style-type: none"> • Rail transport from railhead to mineral port, stockpiling, rehandling, trans-ship loading, and transfer to OGV have been provided in a commercial proposal by OMP, the operator of the port on a fee for wet metric tonne basis. • Road haulage costs to railhead incurred during the initial 18 month ramp up period were estimated by WSP Golder. • Treatment and refinement charges for pelletising and smelting are not incurred for this study. • Penalties for failure to meet product specification are addressed in the revenue factor section below. • Government and other royalties in accordance with the 2019 Mining Code of Gabon and its' associated regulatory framework were used. The 2019 Mining Code Article 205 specifies that royalty rates for Base Metals and Other substances are between 5-10% of the sale price of the mineral product following deduction of allowable fees, taxes and costs. A midpoint royalty rate of 7.5% was used for mine optimisation and subsequent scheduling and financial modelling. • Genmin has also entered an agreement with Anglo American Marketing Pty Limited. The agreement states the royalty payable for each calculation period will be calculated as follows: 0.75% of the Royalty Revenue received for Royalty Product Sold or otherwise beneficially disposed of at below US\$120/t at 1% of the Royalty Revenue received for Royalty Product Sold or otherwise beneficially disposed of at equal to or above US\$120/t.
<p>Revenue Factors</p> <ul style="list-style-type: none"> • <i>The derivation of, or assumptions made regarding revenue factors including head grade, metal or commodity price(s) exchange rates, transportation and treatment charges, penalties, net smelter returns, etc.</i> • <i>The derivation of assumptions made of metal or commodity price(s), for the principal metals, minerals and co-products.</i> 	<ul style="list-style-type: none"> • The base long term commodity price forecast used in the PFS was sourced from industry analyst AME and implemented through a grade-based price formulation using AME forecasts for 58%, 62%, and 65% fines iron ore products and premiums received for 62.5% lump iron ore products. • Fines premiums are based on conclusions from the CSU Value in Use study. • Premiums and discounts are applied based on iron content and the presence of deleterious material. These premiums and discounts are based on a combination of confidential commercial information and benchmarked VIU differentials for impurities, published by S&P Global as of October 2022.

JORC Code Explanation	Commentary
<p>Market Assessment</p> <ul style="list-style-type: none"> • <i>The demand, supply and stock situation for the particular commodity, consumption trends and factors likely to affect supply and demand into the future.</i> • <i>A customer and competitor analysis along with the identification of likely market windows for the product.</i> • <i>Price and volume forecasts and the basis for these forecasts.</i> • <i>For industrial minerals the customer specification, testing and acceptance requirements prior to a supply contract.</i> 	<ul style="list-style-type: none"> • Genmin has completed a market analysis covering the forward supply and demand outlook and longer-term pricing forecasts. • The CSU VIU test work report concludes that Baniaka products are an attractive feedstock in comparison to competitor products due to better than average sinter productivity, reduced solid fuel consumption, and good thermal stability and reducibility.
<p>Economic</p> <ul style="list-style-type: none"> • <i>The inputs to the economic analysis to produce the net present value (NPV) in the study, the source and confidence of these economic inputs including estimated inflation, discount rate, etc.</i> • <i>NPV ranges and sensitivity to variations in the significant assumptions and inputs.</i> 	<ul style="list-style-type: none"> • The base case economic evaluation undertaken as part of the PFS indicates a positive pre-tax NPV at an 8% discount rate. • The discount rate applied has been supplied by Genmin through in-house research.
<p>Social</p> <ul style="list-style-type: none"> • <i>The status of agreements with key stakeholders and matters leading to social licence to operate.</i> 	<ul style="list-style-type: none"> • The ToR approved by the DGEPN includes requirement for engagement with key stakeholders, and the development of a social licence to operate. Genmin is advancing in engagements with these stakeholders and has no reason to believe that a social licence to operate should not be forthcoming should Genmin continue to comply with its approved ToR.
<p>Other</p> <ul style="list-style-type: none"> • <i>To the extent relevant, the impact of the following on the project and/or on the estimation and classification of the Ore Reserves:</i> • <i>Any identified material naturally occurring risks.</i> • <i>The status of material legal agreements and marketing arrangements.</i> • <i>The status of governmental agreements and approvals critical to the viability of the project, such as mineral</i> 	<ul style="list-style-type: none"> • No material naturally occurring risks have been identified for Baniaka. • The disposal for loess silty clay material and the impact of the high rainfall environment on mining productivity will require engineered solutions and active management, as provided in the mine design and strategy. • Genmin has not yet entered any binding contract for the sale of its products from Baniaka and is currently progressing in this area, with the establishment of several MoU's. • A Mining Lease must be granted by the Government of Gabon prior to the commencement of activities. • Genmin has no reason to believe that the necessary government approvals will be received to allow construction at Baniaka to be undertaken and allow mining and processing as set out in the schedule.

JORC Code Explanation	Commentary
<p><i>tenement status, and government and statutory approvals. There must be reasonable grounds to expect that all necessary Government approvals will be received within the timeframes anticipated in the Pre- Feasibility or Feasibility study. Highlight and discuss the materiality of any unresolved matter that is dependent on a third party on which extraction of the reserve is contingent.</i></p>	
<p>Classification</p> <ul style="list-style-type: none"> <i>The basis for the classification of the Ore Reserves into varying confidence categories.</i> <i>Whether the result appropriately reflects the Competent Person's view of the deposit.</i> <i>The proportion of Probable Ore Reserves that have been derived from Measured Mineral Resources (if any).</i> 	<ul style="list-style-type: none"> Indicated Mineral Resources within the final pit design (which has been derived by applying appropriate Modifying Factors as described above) and which are above the calculated variable cut-off grade and included in the process blend schedule to provide a net positive cashflow during each period, have been classified as Probable Ore Reserves. The results of the classification appropriately reflect the CP's view of the deposit. There are no Measured Mineral Resources to be converted to Ore Reserves.
<p>Audits or Reviews</p> <ul style="list-style-type: none"> <i>The results of any audits or reviews of Ore Reserve estimates.</i> 	<ul style="list-style-type: none"> WSP Golder has followed an internal peer review process on the Ore Reserve Estimate; no external audits or reviews have been undertaken.
<p>Discussion of relative accuracy/confidence</p> <ul style="list-style-type: none"> <i>Where appropriate a statement of the relative accuracy and confidence level in the Ore Reserve estimate using an approach or procedure deemed appropriate by the Competent Person. For example, the application of statistical or geostatistical procedures to quantify the relative accuracy of the reserve within stated confidence limits, or, if such an approach is not deemed appropriate, a qualitative discussion of the factors which could affect the relative accuracy and confidence of the estimate.</i> <i>The statement should specify whether it relates to global or local estimates, and, if local, state the relevant tonnages, which should be relevant to technical and economic evaluation.</i> 	<ul style="list-style-type: none"> The relative accuracy and confidence of the Ore Reserve estimate is inherent in the resource geostatistical evaluation, the Mineral Resource classification and Ore Reserve Classification. Baniaka is at the pre-development stage, as such there are no production data available for reconciliation and/or comparative purposes. Factors that may include the global tonnages and the associated grades include mining dilution and recovery and the processing yield and recovery.

JORC Code Explanation	Commentary
<ul style="list-style-type: none"> • <i>Documentation should include assumptions made and the procedures used.</i> • <i>Accuracy and confidence discussions should extend to specific discussions of any applied.</i> • <i>Modifying Factors that may have a material impact on Ore Reserve viability, or for which there are remaining areas of uncertainty at the current study stage.</i> • <i>It is recognised that this may not be possible or appropriate in all circumstances. These statements of relative accuracy and confidence of the estimate should be compared with production data, where available.</i> 	

Pioneering iron ore production in Gabon.



GENMIN

genmingroup.com | ASX:**GEN**