



Technical Report
Efemçukuru Gold Mine
Türkiye

Centered on Latitude N 38° 17' 31.59" and Longitude E 26° 58' 30.30"

Effective Date: December 31, 2023

Prepared by:
Eldorado Gold Corporation
1188 Bentall 5 - 550 Burrard Street
Vancouver, BC V6C 2B5

Qualified Persons

Mr. David Sutherland, P.Eng.
Mr. Peter Lind, P.Eng.
Mr. Mike Tsafaras, P.Eng.
Mr. Sean McKinley, P.Geo.
Mr. Ertan Uludag, P.Geo.

Company

Eldorado Gold Corporation
Eldorado Gold Corporation
Eldorado Gold Corporation
Eldorado Gold Corporation
Eldorado Gold Corporation

Contents

SECTION • 1	SUMMARY	1-1
1.1	Introduction.....	1-1
1.2	Contributors and Qualified Persons.....	1-2
1.3	Reliance on Other Experts	1-2
1.4	Property Description and Location	1-2
1.5	Accessibility, Climate, Local resources, Infrastructure and Physiography.....	1-4
1.6	History.....	1-5
1.7	Geological Setting and Mineralization	1-5
1.8	Deposit Types.....	1-5
1.9	Exploration	1-6
1.10	Drilling	1-6
1.11	Sample Preparation, Analyses and Security.....	1-7
1.12	Data Verification	1-7
1.13	Mineral Processing and Metallurgical Testwork.....	1-8
1.14	Mineral Resources Estimates.....	1-8
1.15	Mineral Reserve Estimates	1-9
1.16	Mining Methods	1-9
1.17	Mineral Processing and Recovery Methods.....	1-10
1.18	Project Infrastructure.....	1-11
1.19	Market Studies and Contracts	1-11
1.20	Environmental Studies, Permitting and Social or Community Impact	1-11
1.21	Capital and Operating Costs	1-12
1.22	Economic Analysis.....	1-14
1.23	Adjacent Properties	1-14
1.24	Other Relevant Data and Information	1-14
1.25	Interpretations and Conclusions.....	1-14
1.26	Recommendations.....	1-14
SECTION • 2	INTRODUCTION.....	2-1
SECTION • 3	RELIANCE ON OTHER EXPERTS	3-1
SECTION • 4	PROPERTY DESCRIPTION AND LOCATION.....	4-1
4.1	Introduction.....	4-1
4.2	Property Location.....	4-1
4.3	Ownership	4-2
4.4	Land tenure	4-3

4.5	Royalties.....	4-4
4.6	Permits and Agreements.....	4-5
SECTION • 5	ACCESSIBILITY, CLIMATE, LOCAL RESOURCES, INFRASTRUCTURE AND PHYSIOGRAPHY	5-1
5.1	Access and Infrastructure	5-1
5.2	Physiography.....	5-2
SECTION • 6	HISTORY	6-1
SECTION • 7	GEOLOGICAL SETTING AND MINERALIZATION.....	7-1
7.1	Regional Geology	7-1
7.2	Local Geology.....	7-3
SECTION • 8	DEPOSIT TYPES.....	8-1
8.1	Deposit Geology	8-1
8.2	Deposit Model.....	8-4
SECTION • 9	EXPLORATION	9-1
9.1	Surface and Subsurface Exploration Work	9-1
9.2	Mapping	9-2
9.3	Surface Sampling and Trenching	9-2
9.4	Geophysics.....	9-2
9.5	Ongoing Exploration & Future Prospects.....	9-2
SECTION • 10	DRILLING.....	10-1
10.1	Exploration & Delineation Drilling	10-1
10.2	Infill Drilling	10-4
SECTION • 11	SAMPLE PREPARATION, ANALYSES AND SECURITY.....	11-1
11.1	Sample Method	11-1
11.2	Assay Method.....	11-1
11.3	Quality Assurance and Quality Control (QA/QC) Program	11-1
11.4	Concluding Statement.....	11-8
SECTION • 12	DATA VERIFICATION	12-1
12.1	Drill Data handling and security.....	12-1
12.2	Block Model to Mill Reconciliation	12-1
12.3	Data Verification by Qualified Persons	12-3
SECTION • 13	MINERAL PROCESSING AND METALLURGICAL TESTWORK	13-1
13.1	Introduction.....	13-1
13.2	Historical Testwork	13-2
13.3	Recent Metallurgical Testwork	13-5
13.4	Flotation	13-8
13.5	Gravity Concentration	13-10
13.6	Performance Analysis of the Flotation Circuit	13-11

13.7	Recommendations for Future Testwork.....	13-12
SECTION • 14	MINERAL RESOURCE ESTIMATES.....	14-1
14.1	Introduction.....	14-1
14.2	Mineralization Models	14-1
14.3	Data Analysis.....	14-3
14.4	Variography	14-7
14.5	Model Set-up	14-8
14.6	Estimation.....	14-9
14.7	Mineral Resource Classification and Summary.....	14-18
SECTION • 15	MINERAL RESERVE ESTIMATES	15-1
15.1	Cut-off Values.....	15-1
15.2	Break-Even Cut-off Value	15-3
15.3	Incremental Cut-off Value	15-3
15.4	Marginal Cut-off Value	15-4
15.5	Dilution	15-5
15.6	Mineral Reserves Statement.....	15-6
SECTION • 16	MINING METHODS	16-1
16.1	Introduction.....	16-1
16.2	Mining Methods	16-2
16.3	Underground Mine Design	16-5
16.4	Geotechnical Assessment.....	16-6
16.5	Backfill.....	16-11
16.6	Mining Rate	16-12
16.7	Mine Development and Production Assumptions.....	16-12
16.8	Mining Sequence	16-12
16.9	Mobile Equipment Fleet	16-13
16.10	Mine Schedule.....	16-14
16.11	Ventilation.....	16-16
16.12	Mining Services	16-18
SECTION • 17	RECOVERY METHODS	17-1
17.1	Introduction.....	17-1
17.2	Process Performance	17-1
17.3	Process Flowsheet and Equipment	17-4
SECTION • 18	PROJECT INFRASTRUCTURE.....	18-1
18.1	Site Access and Local Roads.....	18-1
18.2	Site Layout	18-2
18.3	Surface Tailings and Development Rock Management.....	18-5
18.4	Fire / Fresh Water Supply Storage and Treatment Distribution	18-8

18.5	Sewage Collection and Treatment	18-11
18.6	Waste Disposal.....	18-11
18.7	Power Supply and Electrical Distribution	18-12
18.8	Communications.....	18-15
18.9	Ancillary Facilities	18-15
18.10	Diesel Storage.....	18-19
18.11	Port of İzmir.....	18-19
SECTION • 19	MARKET STUDIES AND CONTRACTS	19-1
19.1	Market	19-1
19.2	Contracts.....	19-2
19.3	Income Tax.....	19-2
SECTION • 20	ENVIRONMENTAL STUDIES, PERMITTING AND SOCIAL OR COMMUNITY IMPACT.....	20-1
20.1	Permitting and Certifications	20-1
20.2	Air Quality.....	20-2
20.3	Energy and GHG Emissions Management	20-3
20.4	Water Management	20-4
20.5	Land Use	20-9
20.6	Biodiversity	20-9
20.7	Approvals and Permits.....	20-10
20.8	Closure.....	20-12
SECTION • 21	CAPITAL AND OPERATING COSTS	21-1
21.1	Capital Cost estimate.....	21-1
21.2	Operating Cost Estimate.....	21-2
SECTION • 22	ECONOMIC ANALYSIS.....	22-1
SECTION • 23	ADJACENT PROPERTIES.....	23-1
SECTION • 24	OTHER RELEVANT DATA AND INFORMATION.....	24-1
24.1	Life of Asset Strategy.....	24-1
SECTION • 25	INTERPRETATION AND CONCLUSIONS.....	25-1
25.1	Mineral Resources and Mineral Reserves	25-2
25.2	Mining Methods	25-2
25.3	Metallurgy	25-2
25.4	Processing and Paste Backfill	25-2
25.5	Tailings and Mine Rock Management Facilities	25-2
25.6	Environmental and Permitting	25-2
25.7	Infrastructure	25-3
25.8	Capital & Operating Costs, and Financial Modelling	25-3
25.9	Risks and Opportunities.....	25-3



SECTION • 26 RECOMMENDATIONS.....	26-1
26.1 Geology - Exploration	26-1
26.2 Mining – Planning and Operational.....	26-1
26.3 Metallurgy and Processing.....	26-1
26.4 Sustainability Studies.....	26-2
26.5 Budget.....	26-2
SECTION • 27 REFERENCES.....	27-1
SECTION • 28 DATE AND SIGNATURE PAGE	28-1

LIST OF FIGURES

Figure 1-1: Property Location Map - Çeşme Peninsula Türkiye (Eldorado, 2019)	1-3
Figure 1-2: Efemçukuru Project Area (Eldorado 2023)	1-4
Figure 4-1: Efemçukuru Project Area (Eldorado, 2023)	4-2
Figure 4-2: Location Map Showing Project Location (Eldorado, 2019).....	4-3
Figure 4-3: Efemçukuru Land Position (Eldorado, 2023)	4-4
Figure 5-1: Project Accessibility (Eldorado, 2019)	5-1
Figure 5-2: Efemçukuru Mine Facilities Layout (Eldorado, September 2023).....	5-4
Figure 7-1: Simplified Tectonic Map of the Western Anatolian Extensional Province, outlining Major Structures, Geologic Units, and Locations of Mineral Deposits (from Boucher, 2016).....	7-2
Figure 7-2: Geological Map of the Efemçukuru Deposit (from Eldorado, 2023).....	7-3
Figure 7-3: Geological cross section through the Batı, Kestanebeleni (MOS) and Kokarpınar Veins (from Eldorado, 2023).....	7-5
Figure 8-1: Longitudinal Projection of the Mineral Resource Block Model, Illustrating Gold Distribution and High-Grade Shoots at Kestanebeleni (Eldorado, 2023).....	8-2
Figure 8-2: Mineral Paragenesis at Efemçukuru (Boucher, 2016).....	8-4
Figure 10-1: Map of exploration and delineation drillhole collars and traces (Eldorado, 2023).....	10-2
Figure 10-2: Oblique 3-D view (facing west) of Infill Drillhole Collars and Traces, Kestanebeleni	10-4
Figure 10-3: Diamond Drill Rig in an Underground Drill Station	10-5
Figure 10-4: Infill Drilling Pattern a) 10 m x 10 m grid b) five dice pattern	10-5
Figure 11-1: CRM Charts, 2020 to 2023, Efemçukuru Mine	11-4
Figure 11-2: Efemçukuru Blank Data – 2020-2023 Drill Programs.....	11-5
Figure 11-3: Relative Difference Chart, Efemçukuru 2020-2023 Duplicate Data	11-6
Figure 11-4: Percentile Rank Plot, Efemçukuru 2020-2023 Duplicate Data	11-6
Figure 11-5: QQ Plot for Efemçukuru Duplicate Data	11-7
Figure 12-1: Flowchart of the Reconciliation Procedure at Efemçukuru Mine (Eldorado, 2023).....	12-2
Figure 14-1: Kestanebeleni, Kokarpınar and Batı System Modeling Domains (Eldorado, 2023).....	14-2
Figure 14-2: Modeled voids in the Kestanebeleni Vein System (Eldorado, 2019).....	14-3
Figure 14-3: Average Coefficient of Variation for Capped and Uncapped Data a by Domain	14-5
Figure 14-4: Cumulative Probability Plots, Kestanebeleni Vein System.....	14-6
Figure 14-5: Cumulative Probability Plots, Kokarpınar and Batı Systems	14-7
Figure 14-6: SOS Modeled Grades and Composited Drill Hole Samples (Au, g/t) (Eldorado, 2023)	14-10
Figure 14-7: MOS Modeled Grades and Composited Drill Hole Samples (Au, g/t) (Eldorado, 2023)	14-11
Figure 14-8: NOS Modeled Grades and Composited Drill Hole Samples (Au, g/t) (Eldorado, 2023)	14-12
Figure 14-9: KBNW Modeled Grades and Composited Drill Hole Samples (Eldorado, 2023).....	14-13

Figure 14-10: Modeled Kokarpınar Domains (KPS on left; KPM on right) and Composited Drill Hole Samples (Au, g/t) (Eldorado, 2023).....	14-13
Figure 14-11: Batı Veins (#1 on Left, #2 on Right) Modeled Grades and Composited Drill Hole Samples (Au, g/t) (Eldorado, 2023).....	14-14
Figure 14-12: Model Trend Plot showing 10 m Binned Averages along Elevations for OK and NN Gold Grade Estimates, SOS Domain	14-15
Figure 14-13: Model Trend Plot showing 10 m Binned Averages along Elevations for OK and NN Gold Grade Estimates, MOS Domain.....	14-16
Figure 14-14: Model Trend Plot showing 10 m Binned Averages along Elevations for OK and NN Gold Grade Estimates, NOS Domain	14-16
Figure 14-15: HERCO plot, SOS domain.....	14-17
Figure 14-16: HERCO plot, MOS domain	14-17
Figure 14-17: HERCO plot, NOS domain.....	14-18
Figure 14-18: Mineral Resources Classification, Efemçukuru Mine (Eldorado, 2023).....	14-19
Figure 15-1: Schematic Showing Dilution Encapsulated by SO Mining Shape.....	15-6
Figure 16-1: Isometric View Showing Mine Areas and Vein Wireframe (Eldorado, 2023).....	16-1
Figure 16-2: Schematic Cross Section Showing DAF Production Block Layout	16-3
Figure 16-3: Schematic Long and Cross Sections Showing LHOS Production Block Layout.....	16-4
Figure 16-4: View Looking South-West Showing Production Blocks.....	16-4
Figure 16-5: Back Analysis of Stope Performance (The Mathews Stability Graph)	16-10
Figure 16-6: Schematic Showing DAF Mining Sequence for a Typical Production Block.....	16-13
Figure 16-7: Schematic Showing LHOS Mining Sequence for a Typical Production Block.....	16-13
Figure 16-8: Current and LOM Plan Mine Development.....	16-15
Figure 16-9: Primary Ventilation Components.....	16-17
Figure 16-10: Dewatering System.....	16-19
Figure 17-1: Simplified Plant Process Flow Diagram with Column Flotation Cells.....	17-3
Figure 17-2: Crusher availability and utilization between 2013 and 2023.....	17-5
Figure 17-3: Distribution of Flotation Tailings to TSF and Paste Plant.....	17-9
Figure 17-4: Availability and Utilization of Flotation Plant between 2013 and 2023	17-10
Figure 18-1: Mine Main Access Road	18-3
Figure 18-2: Project Layout (Eldorado 2023).....	18-4
Figure 18-3: General View of the Mine Site (Eldorado, September 2023).....	18-5
Figure 18-4: View of Tailings Area (Eldorado, September 2023)	18-7
Figure 18-5: Mine Rock Sedimentation Pond (Eldorado, 2019)	18-9
Figure 18-6: East Pond (Eldorado, 2019).....	18-10
Figure 18-7: Water Treatment Plant (Eldorado, 2019).....	18-11
Figure 18-8: Power Line (Eldorado, 2019)	18-13



Figure 18-9: Process Plant and Crushed Ore Bins (Eldorado, 2019)	18-16
Figure 18-10: Filtration Plant and North Portal (Eldorado, September 2023)	18-17
Figure 18-11: Mine Building beside South Portal (Eldorado, 2019).....	18-18
Figure 19-1: Gold Price	19-1
Figure 20-1: Continuous Air Quality-Monitoring Station.....	20-3
Figure 20-2: Water Quality Monitoring	20-8

LIST OF TABLES

Table 1-1: Efemçukuru Gold Mine Mineral Resources, as of September 30, 2023.....	1-9
Table 1-2: Efemçukuru Mineral Reserves, effective September 30, 2023.....	1-9
Table 1-3: Capital Cost Summary	1-13
Table 1-4: Operating Cost Summary.....	1-13
Table 2-1: Cross-Reference List	2-2
Table 4-1: Royalties Calculation	4-4
Table 4-2: Key Project Permits	4-5
Table 5-1: Distribution of Annual Climate Data (İzmir Meteorological Station data 1938-2022)	5-3
Table 9-1: Exploration Activity Summary for Efemçukuru Mining Area.....	9-1
Table 10-1: Summary of Drilling on the Efemçukuru Deposit.....	10-2
Table 11-1: QAQC sample frequency, 2020 to 2023	11-2
Table 11-2: Main CRM Samples used between 2020 and 2023	11-3
Table 12-1: Annual Resource Model to Mill Reconciliation Data.....	12-2
Table 13-1: Reports Reviewed	13-1
Table 13-2: Efemçukuru Grindability Data – MacPherson Consultants	13-3
Table 13-3: Head Assay of typical High-Grade Ores	13-6
Table 13-4: Modal Mineralogy of a Plant Feed Sample (February 2018)	13-7
Table 13-5: Comminution Characteristics of Efemçukuru Ore, Kestanebeleni Vein	13-7
Table 13-6: Comminution Characteristics of Efemçukuru Ore, Kokarpınar Vein	13-7
Table 13-7: Mass Pull, Grade and Recovery of Concentrates from Locked Cycle Tests	13-8
Table 13-8: Summary of Kinetic Variability Test Results, Kokarpınar Vein.....	13-9
Table 13-9: Summary of Kinetic Variability Test Results, Batı Vein	13-10
Table 13-10: Variability Tests, Polymetallic Flowsheet	13-10
Table 13-11: Average Mass Pull, Grade and Recoveries of the Continuous Column Flotation Tests ..	13-12
Table 14-1: Project Limits and Block Model Properties.....	14-1
Table 14-2: Efemçukuru Statistics for 1.0 m Uncapped Composite Au Data (g/t).....	14-4
Table 14-3: Efemçukuru Statistics for 1.0 m Capped Composite Au Data (g/t)	14-5
Table 14-4: Correlogram Parameters for the main Kestanebeleni domains	14-8
Table 14-5: Gold Grades (g/t) by Domain	14-14
Table 14-6: Efemçukuru Mine Mineral Resources, as of September 30, 2023.....	14-20
Table 15-1: Example of the Net Smelter Return Calculation Performed on the Block Model	15-2

Table 16-1: Development Dimensions	16-5
Table 16-2: Rock Mass Quality	16-7
Table 16-3: Current Equipment Fleet	16-14
Table 16-4: LOM Plan Development	16-15
Table 16-5: LOM Plan Production Schedule	16-16
Table 16-6: Fresh Air Requirement for Diesel Equipment	16-17
Table 17-1: Process Design Criteria and Recent Plant Performance Data	17-4
Table 17-2: Reagent Types, Addition Points and Dosages in the Efemçukuru Flotation Plant	17-7
Table 17-3: Characteristics of the Efemçukuru Flotation Circuit	17-7
Table 17-4: Summary of Production Data between 2014 and 2023	17-11
Table 18-1: Surface Areas of the Dry Tailings and WRD Storage Areas at Efemçukuru	18-6
Table 20-1: Permits Obtained Prior to Mining and During Mining at Efemçukuru	20-10
Table 21-1: Capital Cost Summary by Year (in US\$ M)	21-1
Table 21-2: Unit costs	21-2
Table 25-1: Project Risks	25-4
Table 25-2: Opportunities	25-5
Table 26-1: Study Budget	26-2

GLOSSARY

Units of Measure

Annum (year).....	a
Centimeter.....	cm
Cubic centimeter.....	cm ³
Cubic meter.....	m ³
Degree (angle).....	°
Degrees Celsius.....	°C
Dollar (American).....	US\$
Gigawatt Hour.....	GWh
Gram.....	g
Grams per tonne.....	g/t
Hectare (10,000 m ²).....	ha
Hour.....	h
Kilo (thousand).....	k
Kilogram.....	kg
Kilometer.....	km
Kilometers per hour.....	km/h
Kilotonne.....	kt
Kilovolt.....	kV
Kilowatt hour.....	kWh
Kilowatt hours per tonne.....	kWh/t
Kilowatt.....	kW
Litre.....	L
Megavolt Ampere.....	MVA
Megawatt.....	MW
Meter.....	m
Meter above Sea Level.....	masl
Metric ton (tonne).....	t
Microns.....	µm
Milligram.....	mg
Millilitre.....	mL
Millimeter.....	mm
Million cubic meters.....	Mm ³
Million ounces.....	Moz
Million tonnes.....	Mt
Million.....	M
Million Years.....	Ma
Ounce.....	oz

Parts per million	ppm
Percent	%
Square meter	m ²
Thousand tonnes	kt
Three-Dimensional	3D
Tonnes	t
Tonnes per hour	tph
Tonnes per year	tpa
Volt	V
Watt	W
Weight / weight	w/w

Abbreviations and Acronyms

Acidity or Alkalinity	pH
Aluminum	Al
Antimony	Sb
Air Quality Assessment and Management	AQAM
Atomic Absorption	AA
Cadmium	Cd
Calcium Hydroxide	Ca(OH) ₂
Cumulative Distribution Function	CDF
Cobalt	Co
Coefficient of Variance	CV
Copper	Cu
Copper Sulphate	CuSO ₄ .5H ₂ O
Certified Reference Material	CRM
Cumulative Distribution Function	CDF
Cut-off Value	COV
Cyanide	CN
Drift and Fill	DAF
Diamond Drill Hole	DDH
Directorate of State Hydraulic Works	DSI
Semi pure gold alloy	Doré
East	E
Eldorado Gold Corporation	Eldorado
Engineering, Procurement, Construction Management	EPCM
Environmental Impact Assessment	EIA
Environmental Management Plan	EMP
European Union	EU
Fast Radial Basis Function	FastRBF™
Feasibility Study	FS
Flocculant	FLOC
Flow Moisture Point	FMP

Friable	FRB
General and Administration	G&A
General Directorate of State Hydraulic Works	DSI
Geological Strength Index	GSI
Gold	Au
Greenhouse Gases	GHG
HERCO Discrete Gaussian Model aka HERCO (Hermite Coefficient)	Herco
High Density Polyethylene.....	HDPE
High Grade.....	HG
Hydrochloric Acid.....	HCl
Hydrogen Oxide.....	H ₂ O
Incremental cut-off Grade	ICOG
Induced Polarization.....	IP
Inductively Coupled Plasma	ICP
Internal Rate of Return.....	IRR
International Financial Reporting Standards.....	IFRS
International Organization for Standardization.....	ISO
Intrusion #3.....	INT3
Inverse Diameter Weighting	IDW
Investment Tax Credit.....	ITC
Iron.....	Fe
Kestane Beleni North West Shoot.....	KBNW
Kışladağ Concentrate Treatment Plant.....	KCTP
Kopinar Vein System Middle Domain	KPM
Kopinar Vein System South Domain	KPS
Lead.....	Pb
Lerchs-Grossman	L-G
Life-of-mine	LOM
Locked Cycle Test	LCT
London Metal Exchange.....	LME
Longitudinal Longhole Open Stopping	LLHOS
Longhole Open Stopping.....	LHOS
Manganese.....	Mn
Mechanical, Piping, Electrical, Instrumentation.....	MPEI
Measured & Indicated	M&I
Mercury	Hg
Middle Ore Shoot.....	MOS
Mine Rock Sedimentation Pond.....	MRSP
Mine Rock Storage Facility.....	MRSF
Ministry of Environment, Urbanisation and Climate Change.....	MoEUCC
Motor Control Center.....	MCC
National Instrument 43-101	NI 43-101
Nearest Neighbour.....	NN
Nearest Neighbour Kriging	NNK

Net Present Value.....	NPV
Net Smelter Return	NSR
Nickel	Ni
North	N
North East	NE
North Ore Shoot.....	NOS
North West	NW
Operator Control Station.....	OCS
Ordinary Kriging.....	OK
Outer Diameter	OD
Polyvinyl Chloride	PVC
Potassic.....	POT
Potassium.....	K
Potential of Hydrogen.....	pH
Prefeasibility Study	PFS
Probability Assisted Constrained Kriging.....	PACK
Process Control Systems	PCS
Programmable Logic Controllers.....	PLCs
Quarter	Q
Qualified Person(s)	QP(s)
Quality assurance	QA
Quality control.....	QC
Quartz	Qz
Request for Quotations	RFQ
Reverse Circulation.....	RC
Rock Quality Designation	RQD
Run of Mine	ROM
Semi-Autogenous Grinding	SAG
Selective Mining Unit.....	SMU
Selenium	Se
Sequencing Batch Reactor.....	SBR
Silicon	Si
Silver	Ag
Sodium Cyanide	NaCN
Sodium Hydroxide.....	NaOH
Sodium Isobutyl Xanthate.....	SIBX
Sodium Metabisulphite	Na ₂ S ₂ O ₅
Sodium Metabisulphite	SMBS
South.....	S
South East.....	SE
South Ore Shoot	SOS
South West.....	SW
Specific Gravity.....	SG
Spherical	SPH

Standard Reference Material.....	SRM
Sulfur.....	S
Sulfur Dioxide	SO ₂
Sulfide	S ²⁻
Sulfuric Acid.....	H ₂ SO ₄
Tailings Management Facility	TMF
Tailings Storage Facility	TSF
Technical Study	TS
Tourmaline	WMT
Transport Costs and Refining Costs	TCRC
Transportable Moisture Limit	TML
Transverse Longhole Open Stoping.....	TLHOS
Tüprag Metal Madencilik Sanayi Ve Ticaret Limited Sirketi	Tüprag
Turkish Electricity Distribution Corporation.....	TEDAS
Turkish Electricity Transmission Corporation.....	TEIAS
Uninterrupted Power Supply.....	UPS
Universal Transverse Mercador.....	UTM
Uranium.....	U
Value Added Tax	VAT
Water Pollution Control	WPC
Wardell Armstrong International.....	WAI
West.....	W
Work Breakdown Structure.....	WBS
Zinc.....	Zn

SECTION • 1 SUMMARY

1.1 INTRODUCTION

Eldorado Gold Corporation (Eldorado) is a gold and base metal producer with mining, development and exploration operations in Türkiye, Canada and Greece, headquartered in Vancouver, British Columbia. Eldorado owns and operates the Efemçukuru gold mine in Türkiye through its wholly owned Turkish subsidiary, Tüprag Metal Madencilik Sanayi Ve Ticaret Anonim Şirketi (Tüprag). Eldorado has prepared this technical report on the Efemçukuru gold mine to provide a description of the geology and mineralization, mineral resources and mineral reserves, and mine and mill operations at the Efemçukuru gold mine, updating the previous Technical Report effective December 31, 2019 (Technical Report Efemçukuru Gold Mine, 2019).

Information and data for this report were obtained from the Efemçukuru gold mine. The work entailed review of pertinent geological, mining, process and metallurgical data to support the preparation of this technical report.

This technical report: will be publicly filed with Canadian and U.S. securities regulatory authorities; may be publicly filed with and published by any stock exchange and other regulatory authority and any publication of this technical report for regulatory purposes, including electronic publication in the public company files on their websites accessible by the public; may be published by Eldorado on its company website or otherwise; and supports Eldorado's Annual Information Form which will be submitted in March 2024.

1.1.1 Cautionary Statement

The Technical Report presented contains forward-looking information regarding the following Project elements:

- Mineral reserve estimates.
- Commodity prices.
- Exchange rates.
- Proposed mine production plan.
- Projected recovery rates, estimation, and realization of mineral reserves.
- Estimated costs and timing of capital, sustaining, and operating expenditures.
- Construction costs.
- Closure costs and requirements.
- Schedule.

The results of the economic analysis are subject to several known and unknown risks, uncertainties and other factors that may cause actual results to differ materially from those presented here.

Additional risks to the forward-looking information include:

- Changes to costs of production from what are estimated.
- Unrecognized environmental and social risks.

- Unanticipated reclamation expenses.
- Unexpected variations in quantity of mineralized material, grade, or recovery rates.
- Geotechnical or hydrogeological considerations during mining being different from what was assumed.
- Failure of mining methods to operate as anticipated.
- Failure of plant, equipment, or processes to operate as anticipated.
- Changes to assumptions as to the availability of electrical power, and the power rates used in the operating cost estimates and financial analysis.
- Ability to maintain the social licence to operate.
- Accidents, labour disputes, and other risks of the mining industry.
- Changes to interest rates.
- Changes to tax rates or mining royalties.

1.2 CONTRIBUTORS AND QUALIFIED PERSONS

The qualified persons responsible for preparing this technical report as defined in National Instrument 43-101 (NI 43-101), Standards of Disclosure for Mineral Projects and in accordance with 43-101F1 (the “Technical Report”) are:

David Sutherland, P.Eng., Eldorado Gold, author of items 1 through 6, 18, 20, and 24 thru 27.

Sean McKinley, P.Geo., Eldorado Gold, author of items 7 through 10 and 23.

Ertan Uludag, P.Geo., Eldorado Gold, author of items 11, 12 and 14.

Peter Lind, P.Eng., Eldorado Gold, author of items 13, 17, 19, and 21.

Mike Tsafaras, P.Eng. author of items 15, 16, 21 and 22.

All of the qualified persons are employees of Eldorado and have visited the Efemçukuru gold mine.

1.3 RELIANCE ON OTHER EXPERTS

The qualified persons relied on appropriate experts within the Eldorado organization concerning legal, political, environmental, or tax matters relevant to the technical report. Details pertaining to reliance on other experts are described in Section 3.

1.4 PROPERTY DESCRIPTION AND LOCATION

The Efemçukuru mine has been an operating underground mine in commercial production since 2011. Facilities at the mine consist of an underground crushing plant, milling and flotation plant, filtration and paste backfill plant, water treatment plant, and ancillary buildings.

The mine is located near the village of Efemçukuru in the İzmir province in western Türkiye, approximately 20 km south-west of the city of İzmir (Figure 1-1). The mine site is accessed via paved roads directly to the site.

All water is sourced from contact water, all contact water discharged is treated before release. Power is supplied from the local grid with sufficient capacity for current and future operations.



Figure 1-1: Property Location Map - Çeşme Peninsula Türkiye (Eldorado, 2019)

The Efemçukuru Mine land position consists of a single operating license (number 51792) with a total area of 2261.49 ha. According to Turkish mining law, Tüprag retains the right to explore and develop any mineral resources contained within the license area provided fees and taxes are maintained. The license was issued on April 20, 1999 and renewed on August 19, 2013; it is currently set to expire on August 19, 2033. Within the 126.6 ha operating area, forestry land makes up about 80%, treasury land makes approximately 1%, and the remaining area is private land wholly owned by Tüprag.

For this report, the “Project” refers to the 170.24 ha operating area shown in Figure 1-2. No prior environmental liabilities were assumed with the Project. Capital cost allowances have been made in respect of estimated closure costs.

The Project is fully permitted with no additional permits currently required. All infrastructure required to mine and process the Mineral Reserves as disclosed in this report fall under the scope of the existing EIA and operating license.

Approximate project co-ordinates are:

- UTM 497 850 E and 4 238 425 N
- UTM Zone 35S
- Map Sheet İZMİR L17 – İZMİR L17b3 (1:25,000 Scale)
- Longitude E 26° 58' 30.30"
- Latitude N 38° 17' 31.59"



Figure 1-2: Efemçukuru Project Area (Eldorado 2023)

1.5 ACCESSIBILITY, CLIMATE, LOCAL RESOURCES, INFRASTRUCTURE AND PHYSIOGRAPHY

All infrastructure required to operate the mine is in place. The mine site is accessed via approximately 40 km of paved roads from the city of Izmir. Power is supplied via a 10 MW power line connected to the national grid at the sub-station in Urla.

Supplies are procured locally or imported through the port of Izmir which is also the point of shipment for concentrates produced.

The Efemçukuru mine site is situated within the Aegean climatic zone characterized by hot and dry summers and warm and rainy winters. Seasonal rains occur from November to April, with annual precipitation of 600 to 800 mm, while annual evaporation may reach up to 1,500 mm. Average temperatures in the region range between 30 °C in summer and -5 °C in winter with an annual average of approximately 17 °C.

The Efemçukuru Project area is located on a major uplifted structure at the western end of the Izmir-Ankara Suture Zone. Steep hills and narrow valleys characterize the project site with elevation at site ranging from 540 masl in the valley to 770 masl in the surrounding hills.

1.6 HISTORY

The Efemçukuru Deposit was discovered by Tüprag in 1992, while carrying out reconnaissance work in western Türkiye.

Ancient workings were identified in the deposit and it was concluded that the area was likely mined during the Roman dynasty two thousand years ago. Later in the early 20th century, a British company owned the exploration rights and undertook limited surface work on the Efemçukuru deposit.

No modern work was completed on the property before Tüprag's acquisition of the property.

The Efemçukuru mine started commercial production in June 2011, and annual ore production ramped up from 435 kt to 545 kt with no major changes on the operation.

1.7 GEOLOGICAL SETTING AND MINERALIZATION

Western Anatolia, Türkiye, is host to several major porphyry and epithermal gold deposits. The gold-rich region is part of the Western Tethyan orogen. The Efemçukuru deposit is hosted in the centre of a broadly NE-SW trending upthrown block known as the Seferihisar Horst, which regionally exposes basement rocks of the Bornova Flysch in the Menderes Massif (Boucher, 2016).

The intermediate sulfidation veins at Efemçukuru are hosted by quartz, feldspar, muscovite and chlorite bearing schists and phyllites of the Bornova Flysch, with the distinction based on intensity of deformation fabric and relative muscovite abundance. The schists host chlorite-altered spilitic basalt lenses as well as lenses of finely crystalline, massive white marble.

Two major, broadly NW-SE striking epithermal vein systems, namely Kestanebeleni and Kokarpınar, occur at Efemçukuru. They have strike extents of approximately 2 km and 4 km respectively. At surface, the veins are up to 5 m wide, are characterised by banded quartz-rhodochrosite-rhodonite with pyrite-galena-sphalerite and have surface coatings of Mn- and Fe-oxide. The two main veins have complex geometries with multiple shoots and splays. The Kestanebeleni vein is divided into several ore shoots along its strike length, including South Ore Shoot (SOS), Middle Ore Shoot (MOS), North Ore Shoot (NOS) and Kestanebeleni Northwest (KBNW). In the footwall to the Kestanebeleni vein, two similarly oriented but narrower veins are present and termed the Batı veins. The Kokarpınar vein has a more consistent northwesterly strike and dips moderately to the northeast.

1.8 DEPOSIT TYPES

The formation of the Efemçukuru gold deposit in western Anatolia coincided with Miocene extension, magmatism and hydrothermal activity including the formation of several other significant gold-rich porphyry and epithermal deposits in the region (Baker, 2019). Efemçukuru is classified as an intermediate sulfidation epithermal system due to its high-base metal content and the Mn-rich nature of the veins. The dominantly NE dipping Efemçukuru veins formed within faults that had east side down normal-dextral (right lateral) shear sense. The spatial and temporal distribution of rhyolite, high temperature calc-silicate alteration, and intermediate sulfidation epithermal veins support a magmatic-hydrothermal origin. Detailed carbon and oxygen isotope analysis of vein carbonates indicate a mixed meteoric and magmatic source for the hydrothermal fluids and strongly support

degassing and boiling of magmatic fluids during formation of the main epithermal veins (Boucher, 2016).

1.9 EXPLORATION

The Turkish Mine Exploration Institute records document Efemçukuru as a manganese occurrence. Modern exploration activity at Efemçukuru were initiated in 1992 when Tüprag geologists recognized the exploration potential of the area while conducting reconnaissance work in western Türkiye.

Exploration since 2010 has focused on the Kokarpınar vein located east of, and subparallel to, the Kestanebeleni vein. In 2018, the Batı veins were discovered in the footwall to the Kestanebeleni vein. Since 2018, the Batı and West veins have been added to the focus of the exploration.

Geological mapping at Efemçukuru has proven to be highly effective for discovering and delineating new veins. Mapping of the underground mine developments is ongoing. Surface and underground mapping, in addition to drill hole logging combined with structural data, have been used to model the vein systems in 3D and help define new mineralized targets around the mine.

Nearly 150-line km of ground geophysics, including ground magnetic, IP (induced polarization) and gradient IP surveys, have been conducted on the property to assist in mapping and tracing with depth structures, lithologies, alteration domains and sulfides associated with the epithermal veins.

Interpretations from surface mapping, sampling and geophysics have resulted in the identification of additional systems (e.g., Dedebağ, Volkan, Huseyinburnu) in the southwestern part of the property that are collectively called the West veins. These veins, and related blind veins (that are not exposed at surface), have been the focus of exploration drilling in 2023 and remain prospective for the discovery of additional mineralization. Mine exploration from underground has also helped identify new mineralized targets and extensions at Efemçukuru.

1.10 DRILLING

Several phases of exploration drilling were carried out between 1992 and 1997 to gather geological, geochemical and metallurgical data following discovery of the Kestanebeleni vein. Delineation and further exploration drilling from 2006 to 2008 focussed on the Kestanebeleni NOS. Tüprag continued drilling activity on the Kokarpınar vein area between 2009 and 2011. Drilling in 2011 and 2012 focused on testing the Kestanebeleni vein along strike including KBNW, testing down-dip extensions to the South Ore Shoot (SOS), as well as further defining the geometry and continuity of the Kokarpınar vein. Exploration drilling programs in 2013 through 2017 tested the Kokarpınar vein over a 3 km strike length and identified Mineral Resources in several discrete shoots. Between 2018 and 2021 exploration drilling targeted the expansion of the resource in the Kokarpınar vein and the newly discovered Batı veins. Following this, from 2021 to 2023, drilling continued to delineate the Kestanebeleni, Kokarpınar and Batı veins, and drilling was also undertaken to test the West vein area.

Diamond drilling is essential for infill and delineation to increase the geologic confidence in the mining areas and to improve the grade control model. At Efemçukuru, the gold is not visible and is unevenly distributed along the mineralized vein. Core recovery is typically good and averages 97% in over 92% of core intervals intercepting mineralized zones.

Drilling of a specific area is scheduled to be finished 6 to 8 months prior to mining. This timeline is sufficient for short-term grade model updates and applying any changes to the planned development or stope sequencing prior to planned production from the stope area.

1.11 SAMPLE PREPARATION, ANALYSES AND SECURITY

Most diamond drilling since production commenced at Efemçukuru mine comprised of infill and delineation drill holes. Drill core is placed into core boxes marked with hole ID, sequence numbering, and depth interval. Sample intervals are selected and marked up by the logging geologist. Drill core samples are either cut with a diamond rock saw (if a delineation hole) or whole core sampled (if an infill hole). Samples are bagged and sent to the nearby ALS analytical laboratory in Izmir for sample preparation, including cataloging, crushing to 90% passing 2 mm, sub-sampling by riffle splitter until approximately 1 kg remains, and then pulverizing of the sub-sample to 90% passing 75 microns.

Exploration core samples are assayed for gold by 50 g fire assay and underground core samples are assayed for gold by 30 g fire assay with an atomic absorption (AA) finish. All samples are assayed for multi-element determination using fusion digestion and inductively coupled plasma (ICP) spectroscopy analysis. A comprehensive quality control / quality assurance (QA/QC) program is carried out as part of the assaying procedure, involving regular insertion of Certified Reference Materials (CRMs), duplicates and blank samples. The procedure includes inserting either a Certified Reference Material (CRM), blank, or duplicate into the sample stream of every eighth sample. Site geologists regularly monitor the performance of CRMs, blanks, and duplicates as the assay results arrive on site.

Assay results are provided to Eldorado in electronic format and as paper certificates. Upon receipt of assay results, values for CRMs and field blanks are tabulated and compared to established CRM pass-fail criteria.

Laboratory check assays are conducted at the rate of one per batch of 20 samples, using the same QA/QC criteria as routine assays. In addition, the ALS laboratory is regularly visited by the site geology team to observe and check that stated procedures are being used.

The site geology team regularly monitors the performance of CRMs, blanks and duplicates as the assay results arrive on site. Eldorado implemented a program that monitors data from regularly submitted coarse reject duplicates. The data indicates no bias in the assay process or in the analyses.

In the QP's opinion, the QA/QC results demonstrate that the Efemçukuru mine's assay database is sufficiently accurate and precise for the resource estimation.

1.12 DATA VERIFICATION

All of the QP's carried out verification of data pertaining to the sections for which they are responsible. Details of the verification activities carried out are described in Section 12.

1.13 MINERAL PROCESSING AND METALLURGICAL TESTWORK

The Efemçukuru concentrator has been processing ore from the mine since commissioning in 2011. Based on this long operating history, the operation has developed understanding around blending different feed materials coming from various ore shoots to match overall processing capacity, in particular sulfide content.

Metallurgical testwork has been carried out on ore samples from future ore zones within the Kokarpınar and Batı veins. This testwork has included comminution testing, to confirm that the future ore feeds can be milled at the required throughput rate. Flotation tests have also been carried out to assess the expected quality of future concentrates and any additional blending requirements that may be necessary.

1.14 MINERAL RESOURCES ESTIMATES

The mineral resource estimates for Efemçukuru consist of 3D block models formed on the Kestanebeleni, Kokarpınar, and Batı epithermal vein systems. Creation of these models utilized a commercial mine planning software package (Geovia Gems). Currently, mining only occurs within the Kestanebeleni vein system with underground development currently underway to the Kokarpınar vein. Gold mineralization at Efemçukuru, primarily occurring in the principal veins, can only be confirmed through assays. By necessity, domains to control grade interpolation are grade based. For the Efemçukuru mineralization, creation of the modeling domains used a 2.0 g/t Au grade threshold and general vein geometry. An examination of the risk posed by extreme gold grades showed that this risk does exist but was mitigated by a series of assay gold grade caps (40 to 200 g/t). Prior to grade interpolation, the assay data were composited into 1-m fixed length composites.

Modelling consisted of grade interpolation by ordinary kriging for Kestanebeleni domains and inverse distance weighting (IDW) to the second power in the remainder of the zones where data was too limited to create correlograms. Nearest-neighbour (NN) grades were also interpolated for validation purposes. No grades were interpolated outside the modeling domains. The search ellipsoids were oriented preferentially to the orientation of the vein in the respective domains. A two-pass approach was instituted for interpolation. The first pass required a grade estimate to include composites from a minimum of two holes from the same estimation domain. The second pass allowed a single hole to place a grade estimate in any block that was uninterpolated from the first pass. The gold model was validated by visual inspection, checks for global bias and local trends, and for appropriate levels of smoothing (change-of-support checks).

The Mineral Resources of the Efemçukuru mine were classified using the CIM Definition Standards for Mineral Resources and Reserves (May 10, 2014) that are incorporated by reference into NI 43-101. The mineralization of the Project satisfies sufficient criteria such that it can be classified into Measured, Indicated, and Inferred Mineral Resource categories.

Efemçukuru Mineral Resources, as of September 30, 2023, are shown in Table 1-1. The Efemçukuru Mineral Resources are reported at a 2.5 g/t Au cutoff grade. Fourth-quarter 2023 production totalled 22,374 ounces of gold produced from 137,987 t of ore, at an average feed grade of 5.81 g/t.

Table 1-1: Efemçukuru Gold Mine Mineral Resources, as of September 30, 2023

Mineral Resource Category	Resource (t × 1,000)	Grade Au (g/t)	Contained Au (oz × 1,000)	Grade Ag (g/t)	Contained Ag (oz × 1,000)
Measured	1,588	7.15	365	20	1,017
Indicated	3,991	6.51	835	21	2,694
Measured & Indicated	5,580	6.69	1,200	21	3,711
Inferred	1,323	4.13	176	32	1,346

1.15 MINERAL RESERVE ESTIMATES

The Mineral Reserves of the Efemçukuru mine were classified using the CIM Definition Standards for Mineral Resources and Reserves (May 10, 2014) that are incorporated by reference into NI 43-101. The mineralization of the project satisfies sufficient criteria to be classified into Proven and Probable Mineral Reserves. Only Measured and Indicated Mineral Resources were converted, using appropriate modifying factors, to Mineral Reserves. The Mineral Reserves are inclusive to the Mineral Resources.

The Mineral Reserve estimate is summarized in Table 1-2 and has an effective date of September 30, 2023. Fourth-quarter 2023 production totalled 22,374 ounces of gold produced from 137,987 t of ore at an average feed grade of 5.81 g/t.

Table 1-2: Efemçukuru Mineral Reserves, effective September 30, 2023

Category	Ore (t × 1,000)	Grade Au (g/t)	Contained Au (oz × 1,000)	Grade Ag (g/t)	Contained Ag (oz × 1,000)
Proven	1,290	5.18	215	13	528
Probable	2,082	5.01	335	15	991
Proven & Probable	3,372	5.08	550	14	1,519

1.16 MINING METHODS

The Efemçukuru mine has produced 5.8 Mt of ore at an average grade of 7.1 g/t Au as of December 2023, using combination of Drift-and-Fill (DAF) and Longhole Open Stopping (LHOS) methods. Break-even cut-off values of \$126.60/t for drift and fill mining and of \$123.62/t for LHOS were calculated based on the 2024 budget costs and a steady state life of mine (LOM) production profile. The 2024 budget costs are supported by 2023 actual production costs. Use of the Deswik Stope Optimizer software identified potentially mineable material in the form of mining shapes for both DAF and LHOS mining methods. Dilution was captured as internal dilution (mining shape) and planning (overbreak), the latter equaling 16%. A mining recovery factor of 97% was also implemented. Both factors are supported by regular reconciliation and stope closure exercises.

Efemçukuru mine employs small-scale underground mechanized mining methods to exploit the narrow, high-grade, subvertical mineralization. The projected mine life is six years at the current production rate of 545 ktpa.

The current mine layout has the following features:

- Six declines (SOS, MOS, NOS, KBNW, Kokarpınar Ore Shoot, and Batı Ore Shoot), each covering approximately a 400-m strike extent.
- Two surface portals (south and north).
- One surface conveyor adit for conveying crushed ore to the surface crushed ore bins.
- Five primary ventilation surface exhausts (south, central, north, northwest, and Batı) and three fresh air raises for NOS, Kokarpınar, and Batı.
- Link drives connect declines and serve as a secondary egress from the mine.

The mine plan is based on the combination of DAF and LHOS methods. Both DAF and LHOS stopes are mined concurrently from multiple production blocks to fulfil production requirements. The production blocks are mined in a top-down sequence, but stopes within a production block are mined bottom-up (overhand).

A geotechnical domain model has been developed and updated for geotechnical logging of exploration and stope definition drilling information. At Efemçukuru, the rock mass has been classified by the widely used Q-System by adopting characterization logging values to determine Q-input parameters. The selection of DAF and LHOS mining methods is primarily based on the orebody geometry (width and dip) and the expected ground conditions determined through geotechnical assessment. Regular geotechnical assessments indicate that the current mining method, stope sizes, and mining sequence will not change significantly over the LOM.

The mine operates seven days a week and three shifts a day. This annual schedule is equivalent to 365 days per year of operation.

1.17 MINERAL PROCESSING AND RECOVERY METHODS

The Efemçukuru operation is an underground mine with facilities consisting of an underground crushing plant, milling and flotation plant, filtration and paste backfill plant, water treatment plant, and ancillary buildings. The process plant produces a gold-containing bulk sulphide flotation concentrate. Major sulfide minerals comprise pyrite, sphalerite, and galena.

Ore is ground to a P_{80} target of 54 μm . The reagents used in flotation are sodium bisulfite (NaHS) as sulfidizing agent, copper sulfate ($\text{CuSO}_4 \cdot 5\text{H}_2\text{O}$) as activator, xanthate (SIBX) as collector, S-8045 as promoter, and OrePrep F-549 as frother. In most cases, gold recovery is proportional to sulfur recovery and has averaged between 93 to 94% in recent years.

Run-of-mine ore is crushed underground and transferred to two ore storage bins on surface via a conveyor. The two ore storage bins allow for blending of different ore types feeding the process plant to target a desirable gold / sulfur ratio and reduce contents of penalty elements for concentrate sales.

The comminution circuit consists of a semi-autogenous grinding (SAG) mill operated in closed circuit with a pebble crusher, a ball mill operated in closed circuit with hydrocyclones, and a flash flotation cell. Ball mill discharge is treated in a flash cell to recover the fast-floating liberated sulfide mineral particles and prevent overgrinding of gold containing particles. Overflow from the hydrocyclones is sent to flotation.

The flotation circuit consists of a rougher / scavenger flotation bank and two parallel cleaner flotation banks. Concentrates from the flash flotation cell and the first two cells of the rougher / scavenger bank are combined and upgraded in cleaner bank 1. Rougher cells 3-6 concentrate are treated in cleaner bank 2. Concentrates from cleaner banks 1 and 2 are combined and sent to the final concentrate thickener.

Underflow of the concentrate thickener is filtered, and the filtered concentrate is stored in big bags for shipping. The tailings are sent to a tailings thickener. The final tails are filtered. A portion of the tailings is used in the underground paste backfill plant, and the rest is dry stacked in the tailings storage facility (TSF).

Column flotation as the third cleaner flotation stage was added in 2020 to increase concentrate quality and reduce mass pull with minimal gold recovery loss.

1.18 PROJECT INFRASTRUCTURE

The project is well established for LOM purposes with all surface infrastructure in place to support the current reserves.

Existing ancillary buildings, the warehouse, and administration buildings will continue to be utilized.

Two tailings facilities are in operation, the central TSF and south TSF which have capacity for the current reserves; a third north TSF location is available for future expansion. The central mine rock storage facility (MRSF) is in operation, the south MRSF construction was recently completed, the two facilities have capacity for mining of the current reserves; a north MRSF is planned for future expansion. The operating and constructed facilities have capacity for the current reserves.

All power, water supply, water collection and treatment, and road infrastructure exist and will support operations for the reserves at the current throughput.

1.19 MARKET STUDIES AND CONTRACTS

Gold-bearing concentrate from Efemçukuru is marketed to a number of smelters as well as concentrate traders. The concentrate has attractive gold and sulfide content and reasonably low levels of deleterious elements, providing for payability in the 94% range.

1.20 ENVIRONMENTAL STUDIES, PERMITTING AND SOCIAL OR COMMUNITY IMPACT

Tüprag has acquired and maintained all permits required to construct and operate the Efemçukuru project.

Tüprag conducted baseline studies throughout the early 2000's prior to development. An EIA was submitted in 2005 and was approved with Environmental Positive Certificate (received / awarded) in September 2005. Since mining began in 2011, Efemçukuru mine operations have routinely collected environmental data outlined in the Environmental Management Plan (EMP) and submitted data to the relevant government agencies. An inspection and monitoring committee has regularly visited the

Efemçukuru mine site since 2007. The committee checks if the present mining operations are executed within the applicable laws, regulations, and EIA commitments.

Tüprag submitted applications for revisions to the EIA and received approvals for the revisions in 2015 to allow for larger facilities. The Environmental Licence and Permit for the operation was renewed in June 2023 and is valid until June 2028. The permit covers air emissions, water emissions, and environmental noise while the environmental license addresses the mining waste storage facilities, environmental and geochemical characterization of mining wastes, and potential risks identified. MRSF and TSF areas are designed to address identified risks and licensed as Category B facilities by the Ministry of Environment, Urbanisation and Climate Change (MoEUCC).

Efemçukuru Gold Mine is certified ISO 14001 (Environmental Management System), ISO 45001 (Occupational Health and Safety Management System) and ISO 50001 (Energy Management System). ISO 14001 certificate was first obtained in 2012 and renewed in 2022. ISO 45001 certificate was first obtained in 2019 and renewed in 2022. ISO 50001 certificate was obtained in 2023. Regular monitoring and measurement for energy performance and GHG emissions are calculated and disclosed in Eldorado Gold Sustainability Reports. Mitigation targets have been established and annually reviewed to comply with Eldorado Gold's target to mitigate GHG emissions by 30% by 2030 based on a business-as-usual operating and growth scenario.

1.21 CAPITAL AND OPERATING COSTS

Efemçukuru is fully constructed and operating, and actual costs form the basis of future operating and sustaining cost estimates. All costs are expressed in US dollars.

Mining sustaining capital costs include mine development, paste backfill borehole development, purchase of additional equipment, equipment leasing costs, and health and safety initiatives (Table 1-3).

Additional growth capital cost is included for development of the Kokarpınar and Batı veins system and associated infrastructure required to support mining in these vein systems.

Table 1-3: Capital Cost Summary

Growth Capital	LOM Total (US\$)
Mine Development (Kokarpınar & Bati)	\$26.3 M
Mine Infrastructure (Kokarpınar & Bati)	\$9.9 M
Exploration and Resource Conversion	\$24.9 M
Subtotal	\$61.1 M
Sustaining Capital	
Mine – Capital Development	\$14.5 M
Mine – Other	\$26.4 M
Process	\$7.8 M
Administration / Finance (hardware and software)	\$1.9 M
Subtotal	\$50.6 M
Total Capital Costs	\$111.6 M
Closure	\$9.8 M

Figures may not add to total due to rounding.

The underground mine operating costs were estimated based on actual 2023 operating costs and 2024 budget estimates that allow for maintaining a steady state production profile.

The underground operating costs include all consumables (ground support, explosives, services, cement, aggregates, and fuel) and equipment required to meet the development and production schedule objectives. The operating unit costs for mobile equipment and fuel consumption rates were largely obtained from historic mine data. Labour requirements were developed to support the operation and maintenance of the fleet and for the general operation of the underground mine. All these estimates align with manpower levels.

General and administrative costs are based on current personnel requirements and salaries. Adjustments have been made if known changes, such as increasing manpower, are required in future. General supplies are based on the current operating experience.

Process operating costs were based on current annual consumption of process reagents, major wear parts, and utilities. Budget quotations were obtained for supply of all significant consumables and utilities. Power consumption is based on 2023 operating experience.

Unit rates representative to a steady state peak production profile are summarized in Table 1-4.

Table 1-4: Operating Cost Summary

Area	Unit Costs (US\$/t processed)
Mining	43.76
Processing	35.09
Site General & Administrative	37.09
Total Mine Operating Costs	115.95

Figures may not add to total due to rounding.

1.22 ECONOMIC ANALYSIS

Eldorado Gold, being a producing issuer, is not required to include information in this section as this Technical Report does not describe a material expansion of current production. Eldorado has performed an economic analysis related to the Efemçukuru operation using a gold price of \$1,700/oz, at the forecasted production rates, metal recoveries, capital costs, and operating costs estimated in this Technical Report. Eldorado confirms that the outcome is a positive cash flow that supports the Mineral Reserve estimate. Sensitivity analysis incorporating changes in metal prices, capital costs, and operating costs indicate robust economics.

The LOM plan shows that Efemçukuru has a production life of almost six years and can sustain a production rate of 545 ktpa until 2029, based on the current Mineral Reserves.

The mine has the potential to extend this mine life through conversion of identified Inferred Resources, and through resource expansion with ongoing exploration activities.

1.23 ADJACENT PROPERTIES

There are no exploration or mining properties adjacent to the Efemçukuru Project site, nor in the local region. The closest active operating gold mine is located in Ovacik of the İzmir province, approximately 100 km north of Efemçukuru.

1.24 OTHER RELEVANT DATA AND INFORMATION

Efemçukuru has generated an extended mine plan, which included additional Inferred Resources to the Proven and Probable Reserve schedule. Applying the same mine design criteria as described in Section 15, the MSO software was used to generate additional stope shapes from the inferred resources.

Using the same assumed mining dilution, mining recovery, and cost structure to determine cutoff grades, approximately 400 kt has been identified that would extend the mine life by nearly a year, into 2030.

1.25 INTERPRETATIONS AND CONCLUSIONS

Efemçukuru has a solid working history and the work completed in the technical study indicates that the mineral resource estimates, mineral reserve estimates, and Project economics are sufficiently defined to indicate that the Project remains technically and economically viable.

The qualified persons have a high degree of confidence in the contents of this technical report.

1.26 RECOMMENDATIONS

The technical study outlines a solid technical and economical assessment for the Efemçukuru mining operation. It is recommended to proceed with the following studies to further optimize and improve operations:



- Continue with drilling programs to seek ancillary vein systems near strike and other targets in the region.
- Continue metallurgical testwork on future ore zones to further develop blending strategies or options for campaign production of a base metal concentrate.
- Study narrow vein mining techniques for thinner structures.

SECTION • 2 INTRODUCTION

Eldorado Gold Corporation (Eldorado), an international gold mining company based in Vancouver, British Columbia, owns and operates the Efemçukuru gold mine in Türkiye through its wholly owned Turkish subsidiary, Tüprag Metal Madencilik Sanayi Ve Ticaret Limited Sirketi (Tüprag). This technical report has been prepared for Eldorado to provide a description of the geology and mineralization, Mineral Resources and Mineral Reserves, and mine and mill operations at the Efemçukuru gold mine, updating the previous Technical Report effective from December 31, 2019 (Technical Report on the Efemçukuru Project, 2019).

Information and data for this report were obtained from the Efemçukuru gold mine. The work entailed review of pertinent geological, mining, process, and metallurgical data to support the preparation of this technical report.

The quality of information, conclusions, and estimates contained herein is based on i) information available at the time of preparation, ii) data supplied by outside sources, and iii) the assumptions, conditions, and qualifications set forth in this technical report. This technical report is intended for use by Eldorado subject to the relevant securities legislation. Eldorado is permitted to file this technical report as a “technical report” with Canadian securities regulatory authorities pursuant to NI 43-101 and with the U.S. securities regulatory authorities pursuant to the multi-jurisdictional disclosure system of the United States Securities Exchange Act of 1934, as amended. Except for the purposes legislated under Canadian securities law and U.S. securities law, any other uses of this report by any third party are at that party’s sole risk. The user of this document should ensure that this is the most recent technical report for the property as it is not valid if a new technical report has been issued.

When preparing reserves for any of its projects, Eldorado uses a consistent prevailing gold price methodology that is in line with the CIM Guidance on Commodity Pricing used in Resource and Reserve Estimation and Reporting. This was set for gold at US\$1,400/oz Au, as of September 2023 for Eldorado’s current mineral reserve work. All cut-off grade determinations, mine designs, and economic tests of extraction in this technical report use this price. To demonstrate the potential economics of a project, Eldorado may elect to use metal pricing closer to the current prevailing spot price and then provide some sensitivity around this price. This analysis (see Section 22) generally provides a better summary of the project value at prevailing prices rather than limiting it to reserve prices, which might vary from prevailing spot prices. Eldorado stresses that only material that satisfies the mineral reserve criteria is subjected to further economic assessments at varied metal pricing.

The qualified persons responsible for preparing this technical report in accordance with National Instrument 43-101 (NI 43-101), Standards of Disclosure for Mineral Projects and in accordance with 43-101F1 Technical Report are David Sutherland, P.Eng., Peter Lind, P.Eng., Ertan Uludag, P.Geo., Mike Tsafaras, P.Eng., and Sean McKinley, P.Geo. Each of these qualified persons is an employee of Eldorado and have visited the Efemçukuru gold mine.

David Sutherland, Project Manager, was responsible for overall preparation of the technical study and sections related to infrastructure and environment (Sections 1, 2, 3, 4, 5, 6, 18, 20, 22, 24, 25, 26 and 27). He most recently visited the Efemçukuru gold mine on November 8, 2023.

Mike Tsafaras, Director, Underground Mine Planning, was responsible for the mineral reserves and the preparation of related sections on mineral reserves calculation, mining methods, and costs (Sections 15, 16, 21 and 22). He most recently visited the Efemçukuru gold mine on March 27 to 30, 2023.

Sean McKinley, Manager, Geology & Advanced Projects, was responsible for the preparation of the sections concerned with geological information, exploration, and drilling (Sections 7, 8, 9, 10 and 23). He most recently visited the Efemçukuru gold mine on February 3, 2023.

Ertan Uludag, Manager, Resource Geology, was responsible for the mineral resources and the preparation of related sections on sample preparation and analyses, data verification, and mineral resource estimation (Sections 11, 12 and 14). He most recently visited the Efemçukuru gold mine on June 21, 2023.

Peter Lind, Vice President, Technical Services, was responsible for the preparation of the sections in this report that dealt with metallurgy and process operations, costs and payability (Sections 13, 17, 19 and 21). He most recently visited the Efemçukuru gold mine on March 30, 2023.

Notwithstanding the descriptions above, the QPs have undertaken their own review of the technical and scientific information in this technical report. See Section 12 for more information regarding the data verification and inspection activities performed by the QPs.

This document presents a summary of the current and forecast operations at the mine.

Currency used is US\$ throughout, unless otherwise stated.

Turkish names frequently include Turkish characters. In some cases, the names may have been written using a standard US keyboard. The following table Table 2-1 is provided as a cross reference list.

Table 2-1: Cross-Reference List

Standard US Keyboard Name	Turkish Name
Bati	Batı
Canakkale	Çanakkale
Dag	Dağ
Efemcukuru	Efemçukuru
Esme	Eşme
Gokgoz Tepe	Gökgöz Tepe
Gumuskol	Gümüşkol
Izmir	İzmir
Karapinar	Karapınar
Katrancilar	Katrancılar
Kisla	Kışla
Kisladag	Kışladağ
Kokarpinar	Kokarpınar

Standard US Keyboard Name	Turkish Name
Sayacik	Sayacık
Sogutlu	Söğütlü
TEDAS	TEDAŞ
Tuprag	Tüprag
Turkiye	Türkiye
Uzak	Uşak

As of May 31, 2022, the Turkish government requested that Türkiye be officially used as the country name in English, which was agreed to by the United Nations. Historic reports maintain the names as issued and may reference “Turkey”.

SECTION • 3 RELIANCE ON OTHER EXPERTS

The qualified persons relied on appropriate experts within the organization concerning legal, political, environmental, or tax matters relevant to the technical report.

Specifically, Eldorado and Tüprag legal departments provided legal advice and opinions related to title, mineral tenure, permitting, and other related matters.

Tüprag provided additional information related to the environmental monitoring, permitting, and financial data including Turkish taxes, royalties, and provided an update of country-specific risks.

The following disclosure is made in respect of these Experts:

- Mehmet Erdem Gurbuz, Finance Manager, Tüprag (Efemçukuru)
- Seda Erdemir, Country Finance Director, Tüprag

Report, opinion, or statement relied upon:

- Calculation of royalties, taxes and depreciation provided in the Efemçukuru Financial Model

Extent of reliance:

- Full reliance

Portion of Report to which disclaimer applies:

- Section 22

SECTION • 4 PROPERTY DESCRIPTION AND LOCATION

4.1 INTRODUCTION

Tüprag, a wholly owned subsidiary of Eldorado, is operating the Efemçukuru gold mine and related processing facilities on its mineral licenses near the village of Efemçukuru of the Menderes District, İzmir Province, in the Aegean Region of Türkiye.

The Efemçukuru underground gold mine has been in commercial production since 2011. Surface facilities consist of the processing plant, tailing filter plant, paste backfill plant, tailings storage areas, waste rock dumps, water treatment plant, water storage ponds, and administrative facilities.

Ore is mined using conventional mechanized cut and fill and long-hole mining methods and processed to produce a flotation concentrate for sale to smelters and refiners.

4.2 PROPERTY LOCATION

The Efemçukuru gold mine is located in İzmir province in western Türkiye, approximately 20 km southwest from İzmir, near the village of Efemçukuru (Figure 4-2). The village of Efemçukuru lies 700 m southwest of the project area and has a population of approximately 650 people. İzmir, Türkiye's third largest city, is located along the Aegean Sea and has major port facilities available to service the Project. İzmir is an industrial centre with a population of over 4 million.

Approximate project co-ordinates are:

- UTM 497 850 E and 4 238 425 N
- UTM Zone 35S
- Map Sheet İZMİR L17 – İZMİR L17b3 (1:25,000 Scale)
- Longitude E 26° 58' 30.30"
- Latitude N 38° 17' 31.59"

Land use within the concession area falls into three categories: agricultural land (vineyards), forestry land, and treasury land.

The mining concession defines the "Project" of 170.24 ha as shown in Figure 4-1.



Figure 4-1: Efemçukuru Project Area (Eldorado, 2023)

4.3 OWNERSHIP

Land use within the concession area falls into three categories: agricultural land (vineyards), forestry land, and treasury land. Forestry land makes up about 57% of the 170.24 ha of project area and treasury land makes approximately 2%. The remaining area in operational area is private land which is wholly owned by Tüprağ.



Figure 4-2: Location Map Showing Project Location (Eldorado, 2019)

4.4 LAND TENURE

The total Efemçukuru land position (Figure 4-3) consists of a single operating licence (number 51792) with a total area of 2261.49 ha. According to Turkish mining law, Tüprag retains the right to explore and develop any mineral resources contained within the licence area, provided fees and taxes are maintained. The licence was issued on April 20, 1999, renewed on August 19, 2013, and is set to expire on August 19, 2033. The duration of a mining licence can be extended if the mine production is progressing at the end of licence period.

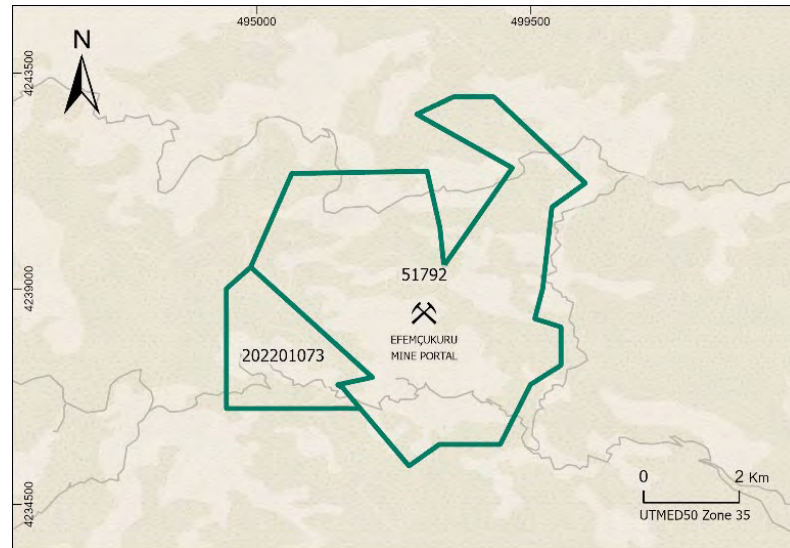

Figure 4-3: Efemçukuru Land Position (Eldorado, 2023)

4.5 ROYALTIES

Mining licences in Türkiye are divided into five groups. The Efemçukuru licence belongs to group 4, which includes gold, silver, and platinum mines. Royalty rates (Table 4-1) for group 4 licences are calculated on a sliding scale implemented in 2019 by the Republic of Türkiye Ministry of Energy and Natural Resources. The rates are revised periodically and are based on the run of mine (ROM) sales price. The ROM sales price is calculated by subtracting processing, transport, and depreciation costs from the gold and silver revenues. This amount is then multiplied by the appropriate royalty rate. The royalty rates are determined once a year by the General Directorate of Mines based on the average sales price of gold and silver quoted on the London Metal Exchange (LME). Concentrate produced at the Efemçukuru mine is considered the product of ore processing and is eligible for the 40% reduction in the royalty rate. The royalty rate for Efemçukuru in 2023 was approximately 9.75% at an average gold selling price of \$1,941/oz.

Table 4-1: Royalties Calculation

Royalty (%)	Gold (Annual average price, \$/oz)
1.25	<800
2.5	801-900
3.75	901-1000
5.0	1001-1100
6.25	1101-1200
7.5	1201-1300
8.75	1301-1400
10	1401-1500
11.25	1501-1600
12.5	1601-1700
13.75	1071-1800
15.0	1801-1900
16.25	1901-2000

Royalty (%)	Gold (Annual average price, \$/oz)
17.5	2001-2100
18.75	>2101

There are no private royalties or encumbrances against the Project.

4.6 PERMITS AND AGREEMENTS

The process of obtaining the necessary permits for a mining operation in Türkiye is similar to the European Union EIA Directive. Table 4-2 lists key Project permits obtained to date, including the date and the governmental authority that issued them. These permits are all of the permits required to conduct work on the Property.

Table 4-2: Key Project Permits

Name of Permit	Issue Date	Issuer
Mining Licence	04/20/1999	Ministry of Energy and Natural Resources
Mining Exploration Licence	07/19/2023	Ministry of Energy and Natural Resources
EIA Permit	9/8/2005	MoEUCC
Energy Permitting	6/21/2010	TEDAŞ
Sewage Water Treatment Plant Design Approval	6/25/2010	MoEUCC
Private Security Permission	12/24/2010	Governor of İzmir
Provisional Acceptance Certificate of Bademler Substation	3/21/2011	TEDAŞ
Provisional Acceptance Certificate of Mine Site Electrical Installation	4/12/2011	TEDAŞ
Workplace Opening Permit	11/09/2023	Governor of İzmir
Mining Operation Licence	8/19/2013	Ministry of Energy and Natural Resources
Mining Operating Permit	8/19/2013	Ministry of Energy and Natural Resources
Underground Explosive Magazine	9/18/2013	İzmir Security Directorate
Temporary Solid and Hazardous Waste Storage Area Permit	04/28/2020	MoEUCC
Provisional Acceptance Certificate (new after upgrading switchgear in Yelki Substation)	8/27/2014	TEDAŞ
EIA Capacity Expansion Permit	11/17/2015	MoEUCC
Forestry Permit Exploration Drilling and Drilling Access Road	5/4/2017	Ministry Forest and Water Affairs
Forestry Permit Power Line	5/4/2017	Ministry Forest and Water Affairs
Forestry Permit Operation	05/20/2020	Ministry Forest and Water Affairs
Purchase and Use of Explosive Certificate	11/17/2023	İzmir Security Directorate
Waste Water Treatment Plant Design Approval	7/25/2018	MoEUCC
Mining Waste Management Plan Approval	03/02/2018	MoEUCC
Central TSF Closure Plan Approval	07/19/2018	MoEUCC
Environmental Permit and License	06/19/2023	MoEUCC

To the extent known, all permits are in place and there are no other significant factors and risks that may affect access, title, or the right or ability to perform work on the property.

SECTION • 5 ACCESSIBILITY, CLIMATE, LOCAL RESOURCES, INFRASTRUCTURE AND PHYSIOGRAPHY

5.1 ACCESS AND INFRASTRUCTURE

The mine site is accessed via approximately 40 km of paved roads from the city of İzmir to the northeast and county of Menderes to the east (Figure 5-1). The site can be alternatively accessed from the Seferihisar highway to the west and İzmir-Kavacık road to the northeast. A 2 km paved mine road currently provides access to the mine property from the regional roads. The travel time by road from İzmir is 45 to 60 minutes.



Figure 5-1: Project Accessibility (Eldorado, 2019)

Power is supplied to the mine via a 10 MW power line that originates from the Urla 2TM station. There are emergency generators with 8.5 MW of capacity installed at the mine site. These generators supply power to critical units at the mill as well as to water discharge and ventilation infrastructure at underground operations.

The proximity of the site to İzmir, one of the largest industrial centers in Türkiye and the second largest port, is advantageous to the project for concentrate shipments, material supplies, and commodities required for the Project.

The city of İzmir has a population of approximately three million people (metro) and is third largest city in Türkiye with significant industrial capacity. The country also has a very active mining and metals sector with a well-educated labour force to support the industry. This provides a significant source of qualified personnel to meet the Project's requirements along with existing training programs established to support operations. The workforce from nearby communities represents 52% of employees.

The Efemçukuru mine site is situated within the Aegean climatic zone, characterized by hot, dry summers and warm, rainy winters. Seasonal rains occur from November to April, with annual precipitation of 600 to 800 mm, while annual evaporation may reach up to 1,500 mm. Under these conditions, the Kokarpınar stream is generally intermittent and flowing water is restricted to the wet season in response to precipitation, or to short-term storm events during the summer.

Average temperatures in the region range between 30 °C in summer and -5 °C in winter, with an annual average of approximately 17 °C. The study area is susceptible to orographic effects caused by the lifting of moisture-laden air from the Aegean Sea. Accordingly, the study area experiences a significant amount of rainfall variation on a monthly basis.

Long-term climatic records are not available for the Kocadere River catchment. Although a meteorological station does exist at the Efemçukuru mine site, it has only been in operation since 1998. The next closest meteorological station located at Beyler, approximately 7 km to the southwest, has a longer period of record. However, the lack of data overlap prevents correlation with the meteorological data recorded at the mine site.

The next closest stations with overlapping periods of record are Balçova, roughly 14 km to the northeast; Seferihisar, approximately 15 km to the southwest; and İzmir, approximately 20 km to the northeast. Owing to the relatively long period of record and strong correlation with data collected at the mine site, the precipitation record from the İzmir meteorological station (1938-2022) has been used in the evaluation of long-term precipitation conditions at the Efemçukuru mine site.

Table 5-1 presents the expected seasonal variation of monthly climate data for the study area. The expected annual average precipitation is 710.4 mm, while annual average evaporation is 1699 mm. Average wind speed is 11.1 km/h.

The Project operates all year round and production has only been affected by extreme weather conditions with previous events stopping operations for no more than a few days. The infrastructure and water management systems have been adequately sized considering storm events.

5.2 PHYSIOGRAPHY

The Efemçukuru Project is located on a major uplifted structure at the western end of the İzmir-Ankara Suture Zone. Steep hills and narrow valleys characterize the project site with elevation on site ranging from 540 masl in the valley to 770 masl in the surrounding hills. The deposit crops out at Kestanebeleni hill which slopes steeply to the Kokarpınar stream valley. The majority of mine facilities are also located on the same slope to Kokarpınar stream (Figure 5-2). Vegetation consists of mature pine trees with sparse undergrowth covering the hillsides. The flatter land in the valleys and upper slopes of the hills has been cultivated with grape vines.

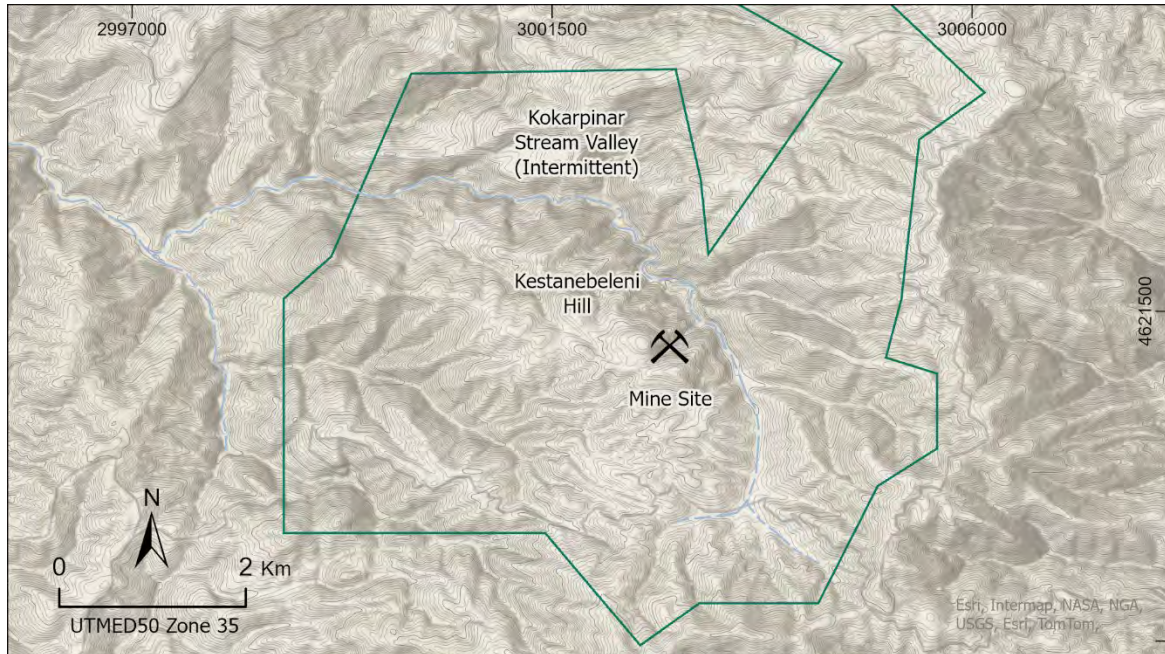
Table 5-1: Distribution of Annual Climate Data (İzmir Meteorological Station data 1938-2022)

Month	Temp	Precipitation		Evaporation	
	°C	mm	% of Annual	mm	% of Annual
January	8.8	134.8	19%	48.4	3%
February	9.6	103.4	15%	61.8	4%
March	11.6	75.1	11%	93	5%
April	15.9	45.7	6%	127	7%
May	20.8	31.3	4%	181	11%
June	25.4	12.4	2%	236.5	14%
July	27.9	4.1	1%	279.1	16%
August	27.7	5.9	1%	258.7	15%
September	23.8	15.1	2%	186.4	11%
October	18.9	44.6	6%	115.4	7%
November	14.3	91.8	13%	65.1	4%
December	10.6	146.2	21%	47.5	3%
Totals	N/A	710.4	100%	1699.9	100%



Figure 5-2: Efemçukuru Mine Facilities Layout (Eldorado, September 2023)

SECTION • 6 **HISTORY**

Mining in the Efemçukuru area began during the Roman times as evidenced by numerous adits and shallow excavations on outcrops of epithermal veins. Later in the early 20th century, a British company owned the exploration rights and completed limited surface work. The area was rediscovered in the early 1980s during reconnaissance work by the Turkish Geological Survey who noted base metal and manganese occurrences.

Subsequently, the Efemçukuru deposit was recognised by Tüprag in 1992 while carrying out reconnaissance work for gold in western Türkiye. Tüprag applied for and acquired the exploration license the same year, and then conducted systematic exploration activities over multiple years to delineate mineralization initially along the Kestanebeleni vein. A feasibility study was conducted in 2007, and construction of the underground mine began in 2008. In June of 2011, commercial production began at Efemçukuru with an initial expected life of mine of 10 years (Wardrop, 2007). Annual ore production has ramped up from 435 kt to 545 kt with no major changes to the operation.

SECTION • 7 **GEOLOGICAL SETTING AND MINERALIZATION**

7.1 REGIONAL GEOLOGY

Western Anatolia, Türkiye, is host to several major porphyry and epithermal gold deposits, including the Kışladağ porphyry gold mine (17 Moz), the Efemçukuru intermediate sulfidation gold mine (2.5 Moz), and the Ovacik low sulfidation gold mine (3.9 Moz) (Baker, 2019). The gold-rich region is part of the Western Tethyan orogen, defined by a series of Cretaceous through Cenozoic magmatic belts that have a strike length of over 3,500 km from Slovakia to Iran, before continuing to the east through the Central and Eastern Tethyan orogen. The magmatic belts in Türkiye broadly young from north to south. Cretaceous to Paleogene subduction-related arc magmatism in the Pontides transitions southwards to post-collision, extension-related Neogene magmatism resulting from slab roll-back in central and western Anatolia (Jolivet et al., 2015).

During slab-roll back, the Hellenic trench retreated relative to the Cyprus trench, diverged and consequently tore the Aegean slab, resulting in the upwelling of hot asthenosphere beneath western Anatolia between 15 and 8 Ma (e.g., Dilek and Altunkaynak, 2009; Jolivet et al., 2015). The combination of slab roll-back, tearing and continental rifting facilitated the exhumation of metamorphic core complexes such as the Menderes Massif and Cyclades (Figure 7-1; van Hinsbergen, 2010; Jolivet et al., 2015). Miocene magmatism in western Anatolia was emplaced in NE-trending extensional to transtensional continental rifts during this exhumation and associated crustal thinning (e.g., Dilek and Altunkaynak, 2009; Ersoy et al., 2010). Structurally controlled epithermal, porphyry, and base metal deposits formed along detachment faults and WNW- to NE-trending grabens and faults and their intersections during Neogene tectonic denudation in the Menderes Massif region (Figure 7-1; Gessner et al., 2017; Menant et al., 2018).

The Efemçukuru deposit is hosted in the center of a broadly NE-SW trending horst known as the Seferihisar Horst, which regionally exposes basement rocks of the Bornova Flysch in the Menderes Massif (Boucher, 2016). The flysch predominantly comprises lower greenschist facies schist with intercalations of mudstone, fine-grained sandstone, limestone, and marly sandstone. Locally, lenses of ophiolitic basalt (spilite) and serpentinite, tens to hundreds of meters thick, are interbedded with limestone and marly sandstone segments. Although the Bornova Flysch within the Seferihisar Horst is non-fossiliferous, other stratigraphically similar sequences of the flysch contain abundant faunal records that provide age constraints. In these, Upper Jurassic to Lower Cretaceous pelagic limestone is overlain by ophiolitic sequences of spilite and serpentinite in an Upper Cretaceous to Lower Paleocene siliciclastic sequence (Okay and Altiner, 2007). Bedding dip directions of the flysch sequence across the entire Seferihisar Horst outline a broad, asymmetric NE-trending syncline.

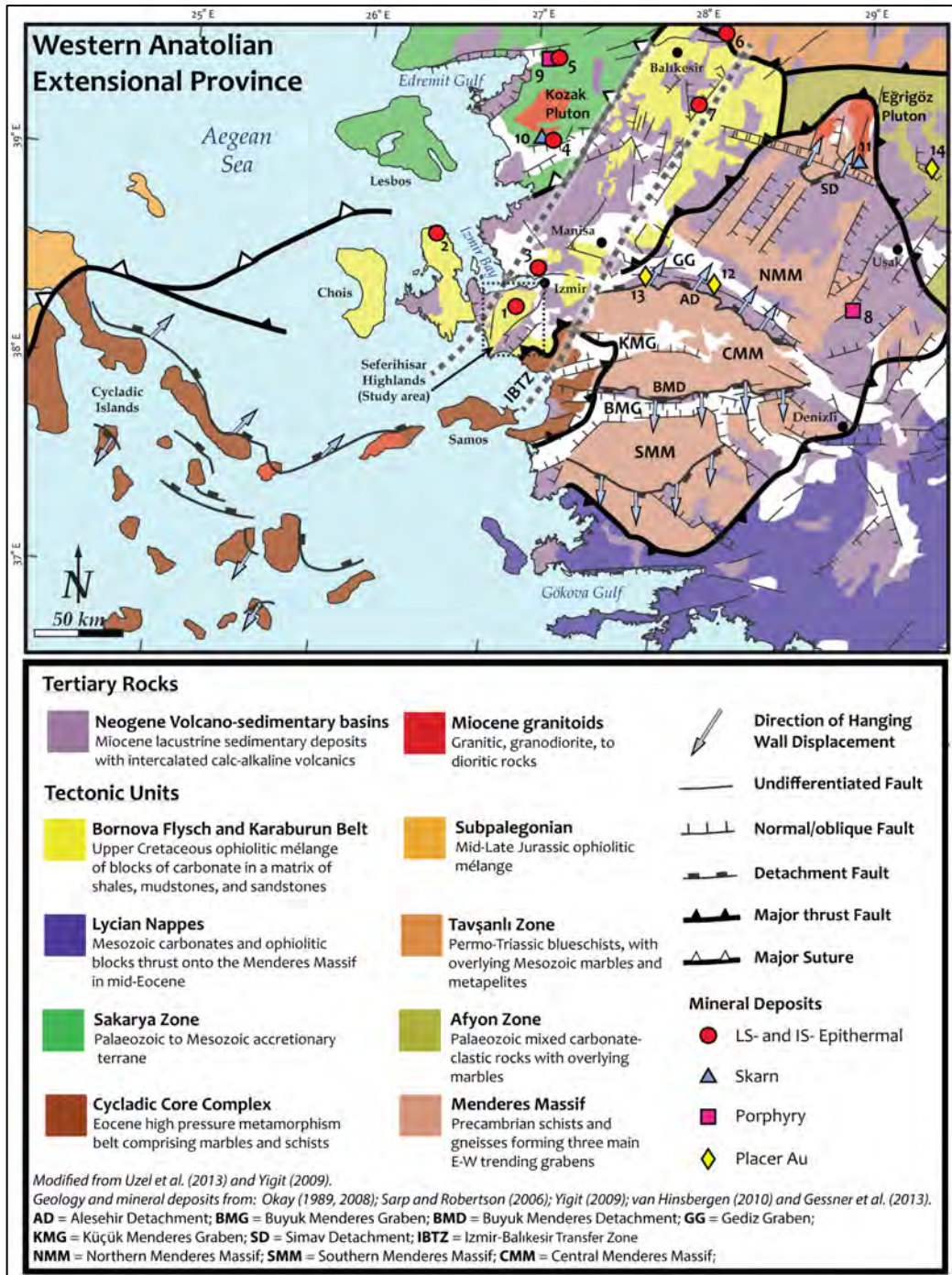

Note: Numbered deposits and main commodity in parentheses are: 1 = Efemçukuru (Au); 2 = Kalecik (Hg); 3 = Arapdağ (Au, Ag, Pb, Sb); 4 = Ovacık (Au, Ag); 5 = Küçükdere (Au); 6 = Balya (Au, Ag, Pb, Zn); 7 = Sındırgı (Au, Ag); 8 = Kışladağ (Au); 9 = Tepeoba (Cu, Mo, Au); 10 = Ayazmant (Fe, Cu); 11 = Kalkan (Fe); 12 = Pactolus (modern day Gediz) River (historic Au); 13 = Irlamaz-Manisa (Au); 14 = Sart (Au).

Figure 7-1: Simplified Tectonic Map of the Western Anatolian Extensional Province, outlining Major Structures, Geologic Units, and Locations of Mineral Deposits (from Boucher, 2016)

7.2 LOCAL GEOLOGY

The intermediate sulfidation veins at Efemçukuru are hosted by schist and phyllite of the Bornova Flysch (Figure 7-2). On the property, the Bornova Flysch comprises a low-grade metamorphic sequence of fine-grained shales to phyllite and schist that have been locally folded and are commonly calc-silicate altered. Phyllitic rocks locally contain lenses of fine-grained sandstone and sequences of black carbonaceous silty mudstones. The mineralogy of the phyllites is quartz, feldspar, muscovite, chlorite, and rare biotite, whilst the schists are similar but have muscovite in lieu of biotite. Spilitic basalt lenses within the schist are strongly chlorite altered. Larger lenses or blocks of finely crystalline to massive white marble also occur locally within the schists.

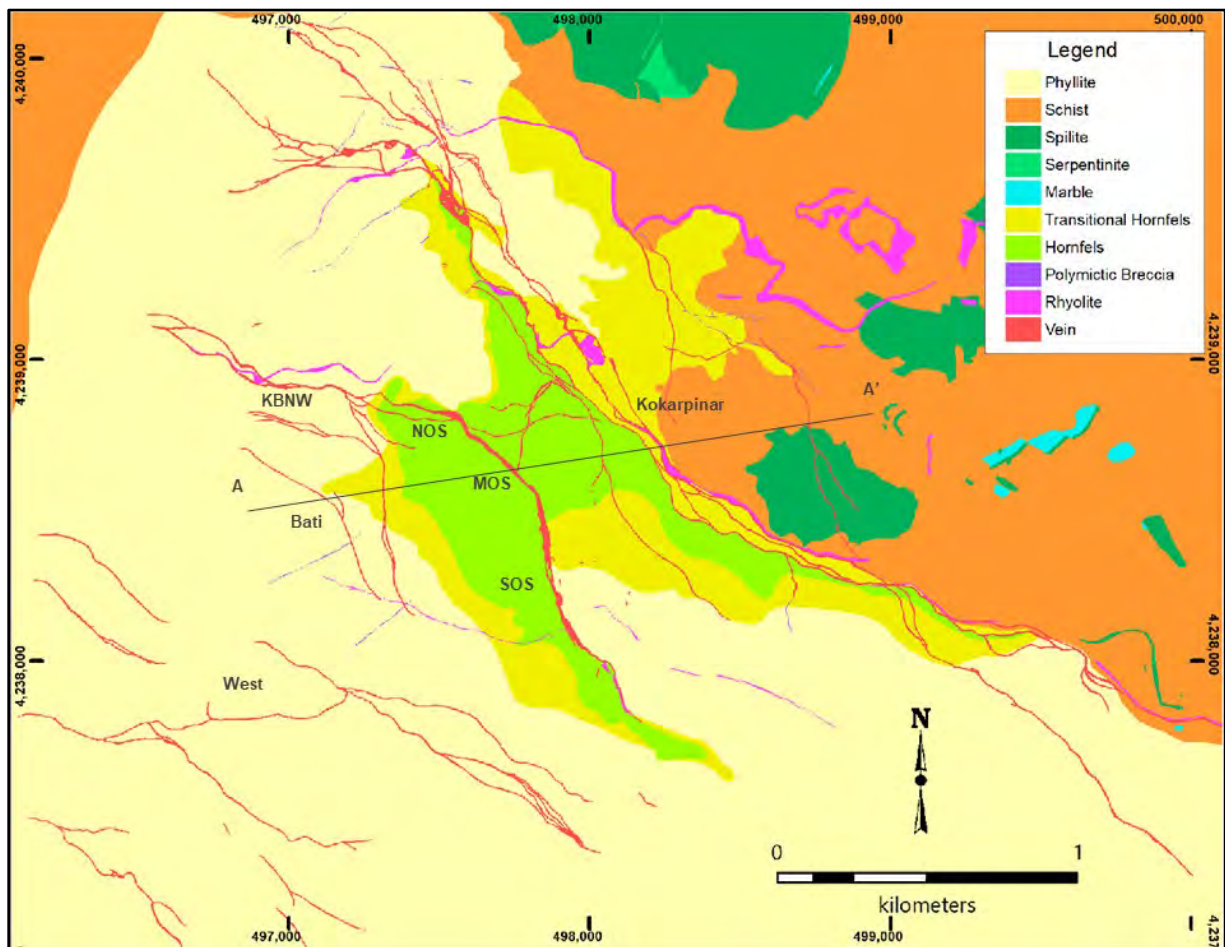

Figure 7-2: Geological Map of the Efemçukuru Deposit (from Eldorado, 2023)

A calc-silicate alteration, locally termed hornfels, occurs in a broadly NW-trending pattern in the center of the deposit area. The alteration commonly occurs as alternating dark green and tan-grey bands within meta-sedimentary rocks. The banded texture is characterized by up to 10 to 20 cm wide alternating bands of very fine-grained quartz and fine-grained chlorite, actinolite, epidote, and clinozoisite. The calc-silicate assemblage also occurs in veins and veinlets that cut small-scale folds and locally overprints rhyolite dikes. Contacts between calc-silicate alteration and phyllite are

gradational and mapped as transitional hornfels where the rock bands become progressively less altered, and the banding texture disappears.

Rhyolite outcrops in the deposit area occur as 1 to 5 m wide NW-striking dikes. The rhyolites are cream-white in color, fine-grained with a granular texture, and include 1 to 3 mm round quartz phenocrysts in a groundmass of orthoclase, quartz, and minor plagioclase. Sulfides are rare, except adjacent to crosscutting veins or stockwork veinlets, where up to 0.5% disseminated pyrite can occur in weakly to moderately silicified rhyolite. Contacts of the rhyolite dikes with the flysch units are usually sharp with little associated visible alteration or faulting. Boucher (2016) sampled a rhyolite dike from the deposit and interpreted a U-Pb zircon age of 13.17 ± 0.25 Ma which provides an upper age for the epithermal mineralization at Efemçukuru.

Polymictic breccias also form dikes particularly in the Göktepe region and in Kokarpınar NW where they cut rhyolite. These breccias are dark green, matrix-supported with angular to sub-round clasts of schist, phyllite and spilite, and more rarely round to angular clasts of rhyolite and epithermal vein fragments. The breccia matrix comprises aphanitic quartz, interstitial chlorite, and very fine-grained (< 1 mm), disseminated euhedral to subhedral pyrite and galena. Total sulfide content is typically less than 0.5%.

7.2.1 Mineralization

Two major, broadly NW-SE striking epithermal vein systems, namely Kestanebeleni and Kokarpınar, occur at Efemçukuru. They have strike extents of approximately 2 km and 4 km respectively (Figure 7-2). Both vein systems cut the rhyolite dikes, calc-silicate alteration and unaltered phyllite and schist. At surface, the veins are up to 5 m wide and occur as either multi-phase, brecciated, banded crustiform-colloform or as massive quartz-rhodochrosite-rhodonite-sulfide veins. Stockwork veins are commonly associated with the major epithermal veins and occur both in the footwall and hanging wall, as well as between vein splays, in zones of at least 3 m wide. The stockwork zones manifest as thin (< 3 cm) Fe-oxide-stained quartz veinlets cutting strongly to moderately illite and smectite altered phyllites over widths. Minor (< 2%), fine-grained disseminated pyrite characterizes the stockwork zone. The bulk of the epithermal veins at surface contain Mn- and Fe-oxide coated, banded quartz-rhodochrosite-rhodonite with pyrite-galena-sphalerite. Evidence that the major veins exploited fault zones includes the common presence of lithified cataclasite proximal to the veins and clasts of cataclasite within the veins. Furthermore, the vein-hosting fault network was likely coeval with the calc-silicate alteration event because calc-silicate (epidote) partly cements the cataclasite and the distribution of the hornfels broadly maps out the fault-vein network.

In detail, the two main veins have complex geometries with multiple shoots and splays. The Kestanebeleni vein is divided into several ore shoots: SOS, MOS, NOS and KBNW (Figure 7-2). The southern portion of Kestanebeleni system, including the SOS and MOS, dips moderately to steeply ($45-70^\circ$) to the east-northeast. In the northern zones at the NOS and KBNW, the vein has a more moderate dip ($55-60^\circ$) to the north-northeast (20° to 25°). In the footwall to the Kestanebeleni vein occur two similarly oriented but narrower veins called the Batı veins (Figure 7-3). The Kokarpınar vein has a more consistent northwesterly strike and dips moderately to the northeast. In the furthest northwest and southeast extent of Kokarpınar the veins display a complex horsetail geometry with numerous splays. The Kokarpınar vein is also divided into four ore shoots: Kokarpınar South (KPS), Kokarpınar Middle (KPM), Kokarpınar North (KPN), Kokarpınar Northwest (KPNW).

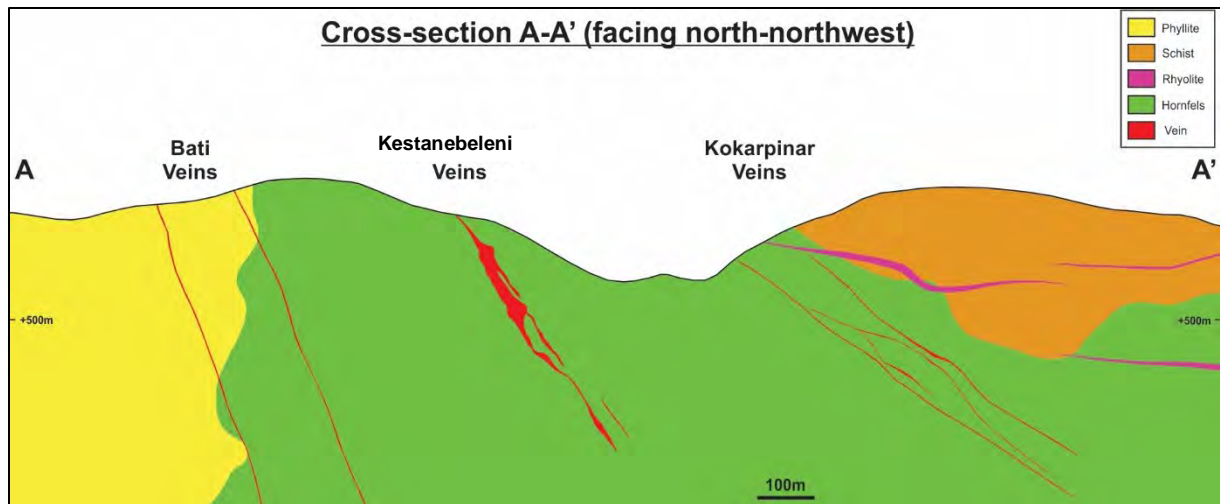

Figure 7-3: Geological cross section through the Bati, Kestanebeleni (MOS) and Kokarpinar Veins (from Eldorado, 2023)

The thickest vein segments typically coincide with areas where the controlling fault system has a more northerly strike and steeper dip. Northwest-striking fault segments lack veins or have thin vein material. Such patterns are consistent with an oblique east side down normal-dextral (right lateral) shear sense on the overall fault-vein network, with northwest striking segments accommodating a dominantly right lateral component. North-striking steeply dipping segments accommodating dominantly normal and extensional shear sense leading to preferential vein development.

SECTION • 8 DEPOSIT TYPES

8.1 DEPOSIT GEOLOGY

The epithermal veins at Efemçukuru contain multiple ore shoots with zoned mineral and metal distributions and a complex paragenesis. The 2 km long Kestanebeleni vein hosts the major gold resource at Efemçukuru and comprises four ore shoots: SOS, MOS, NOS and KBNW (Figure 8-1).

The SOS outcrops for 500 m and dips between 45° to 70° to the northeast. The shoot has a down dip extent of approximately 500 m. The southern half of the shoot consists mostly of a single vein whereas in the central part of the SOS, the vein splays at depth. A second larger splay is developed nearer the surface, close to the mid-point of the SOS, and continues for approximately 230 m to the north end of the shoot. Where the SOS consists of a single vein, its thickness generally ranges from 3 m to 5 m but can locally reach more than 10 m. Gold mineralization is not generally distributed across the whole vein, but more typically occurs as high grade (> 50 g/t × m) discrete zones within the vein that have a steep northerly dominant plunge and shallow to moderate southerly secondary plunge. Where the vein breaks into splays, the splays are generally narrower, with thicknesses of 1 to 2 m. Additionally, significant stockwork type mineralization is locally present between the vein splays where they cut hornfels. Limited amounts of stockwork mineralization occur where the vein hanging wall consists of phyllite, but these instances are more restricted in size and continuity.

In the MOS area, the Kestanebeleni vein strikes 320° over approximately 230 m and has an average dip of 60° to 65° to the northeast. High-grade gold mineralization in the MOS forms a steeply plunging central shoot and is hosted entirely within hornfels. The shoot has a narrow surface expression of approximately 3 m, but expands with depth to more than 20 m. A single splay diverges from the main vein in the central part of the shoot and an extensive zone of stockwork mineralization occurs between the two veins and extends into the hanging wall. The stockwork zone is traceable along strike for approximately 75 m and is best developed between 550 m and 600 m elevation, with some extensions above and below these elevations.

The NOS is separated from the MOS by an inflection that coincides with an additional 25° westward bend in the strike of the Kestanebeleni vein. Here the vein strikes approximately 300° and the vein flattens to a 45° dip. The NOS outcrops intermittently for approximately 200 m along this bearing before it pinches out. Another inflection occurs between the NOS and KBNW, with the latter striking nearly east-west over a 300 m strike length before reverting to a 300° strike orientation. KBNW is typically narrower than the other three main shoots (< 3 m) and comprises two vein splays for much of its length.

The Kestanebeleni vein has a distinct mineralogical zonation with the proportions of Mn-silicate and carbonate and sulfide vein material varying across the vein system. Mn-rich vein assemblages are most abundant in the upper portions of the SOS, whereas the sulfide content of the MOS and NOS, particularly at depth, is much higher. The increased sulfide content coincides with an increase in Pb and Zn in the MOS and NOS and the Ag / Au ratio is typically higher at depth and on the periphery of the veins.

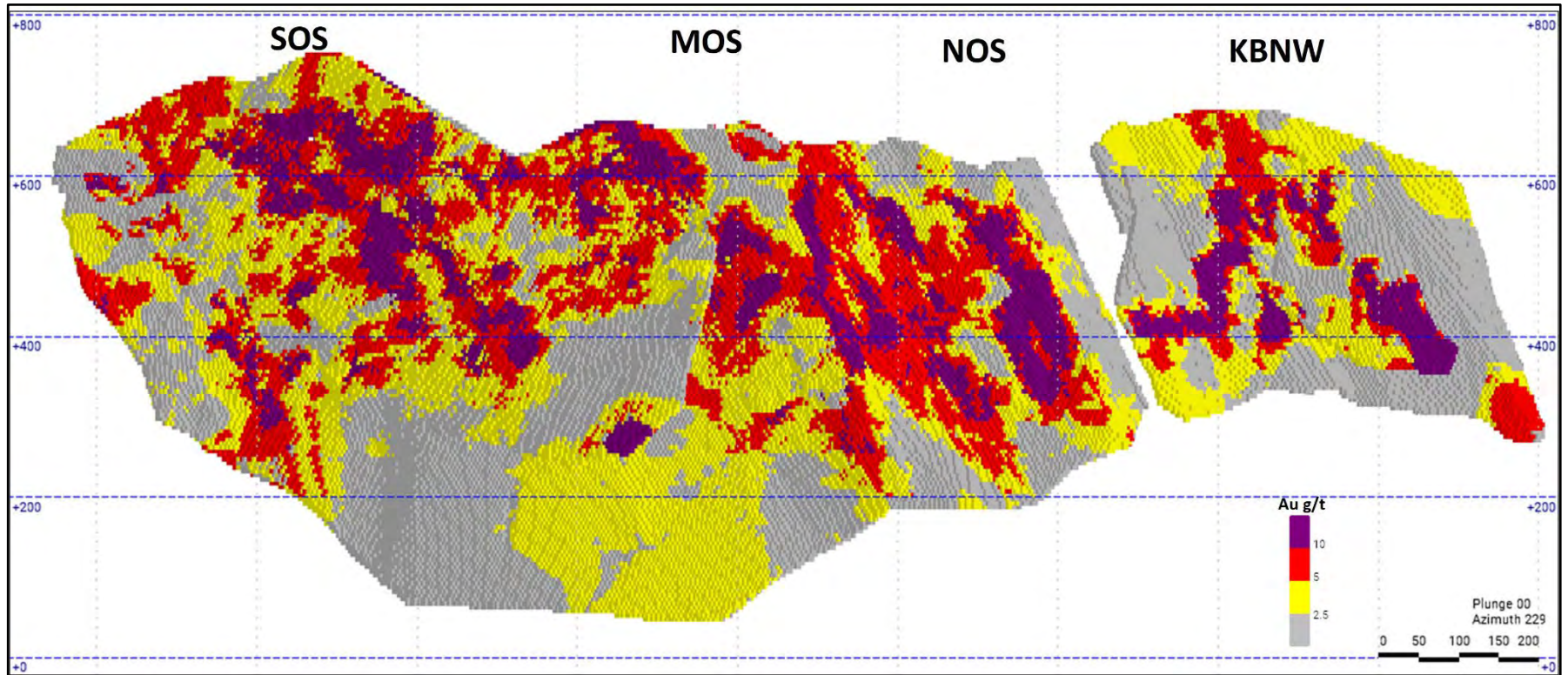

Figure 8-1: Longitudinal Projection of the Mineral Resource Block Model, Illustrating Gold Distribution and High-Grade Shoots at Kestanebeleni (Eldorado, 2023)

The majority of gold is fine-grained (< 30 microns), occurring as free grains in quartz and rhodonite gangue, and within and in contact with pyrite, chalcopyrite and sphalerite, and to a lesser extent galena. However, higher gold grades are not directly related to sulfide abundance. Silver content of the deposit is highly variable. There are two major trends about gold / silver ratio, where one is 1-1 ratio that is mostly dominant where gold grade higher than 10 g/t, and the other is 1 to 10 ratio and dominant where the gold grade is lower than 10 g/t. The average silver grade for both the MOS and SOS is low (11.9 and 8.3 g/t), but parts of the MOS shoot contain silver values in excess of 100 g/t.

The veins have a distinct paragenesis in addition to the mineralogical and metal zonation (Figure 8-2; Boucher, 2016). Three main vein-forming stages have been identified: 1) early quartz-rhodonite-rhodochrosite veining and breccia-fill, 2) quartz-sulfide-(rhodonite / rhodochrosite) veining, and 3) quartz-calcite veining that cross-cuts the other two stages.

Calc-silicate alteration, veins and breccia that locally cement cataclasite in the fault-vein system and consists of a mineral assemblage of quartz-chlorite-epidote-actinolite are characteristic of the earliest hydrothermal stage.

The main epithermal stage commenced with vein- and breccia-fill of very fine-grained quartz and rhodonite (pyroxmangite), rhodochrosite, and minor pyrite. This stage is associated with significant brecciation of calc-silicate altered phyllite wall rock, characterized by highly variable clast sizes reaching up to a few decimeters. The breccia clasts are angular and do not show significant comminution prior to hydrothermal vein emplacement. Comb-textured quartz and the Mn-rich phases commonly occur along the edges of the brecciated clasts growing towards the vein interiors. Adularia is extremely rare and has only been observed in the earlier phases of this vein stage where it appears in thin veinlets cutting flysch wall rock breccia clasts. Veins and veinlets are characterized by colloform banded quartz, rhodonite (pyroxmangite), axinite, and rhodochrosite, with minor calcite and rare pyrite and galena. Quartz textures vary from anhedral fine grained to chalcedonic crystals in individual bands or, in the later veins of this stage, as comb-textured vug infill. The Mn-phases typically grow together in pink bands superimposed on quartz-rich bands. Calcite and rhodochrosite can also be bladed in some vugs. This stage lacks abundant sulfide, although rare disseminated euhedral pyrite (< 0.5%) is observed in the later stages.

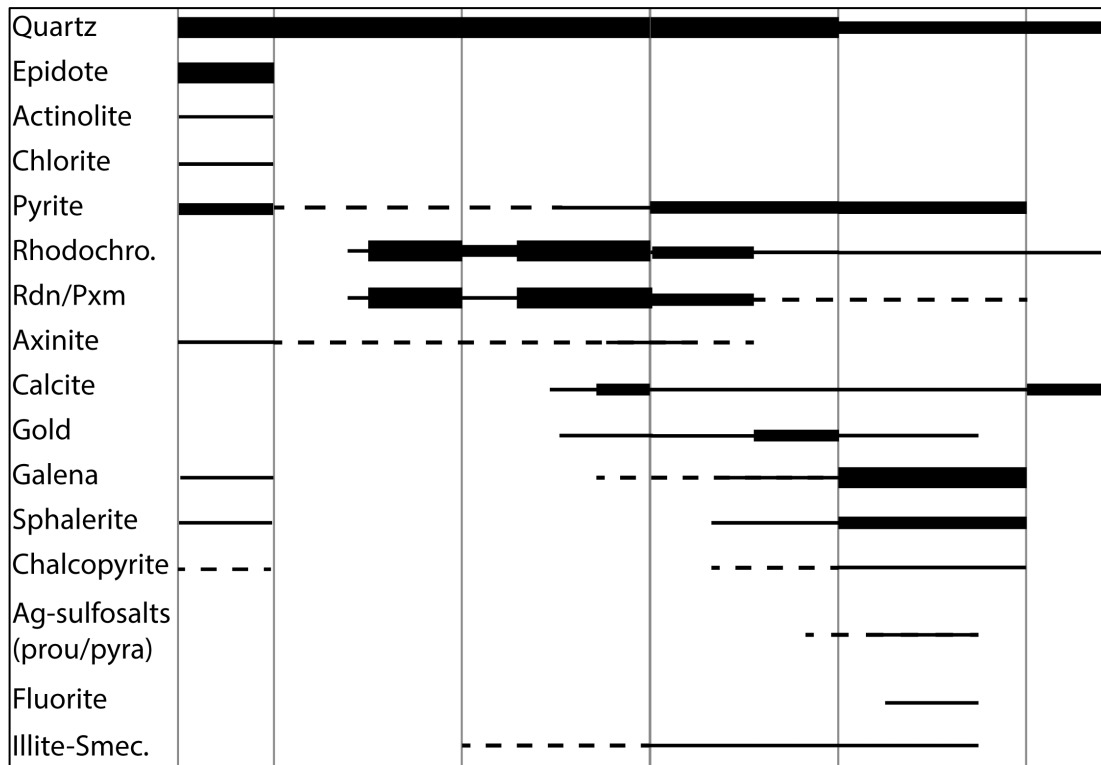

Figure 8-2: Mineral Paragenesis at Efemçukuru (Boucher, 2016)

The quartz-sulfide stage consists of veins of quartz and minor rhodonite (pyroxmangite), axinite, rhodochrosite, and calcite that are disseminated and banded with very fine-grained pyrite, galena, and sphalerite. Base metal sulfides and pyrite are more abundant with subhedral to euhedral pyrite, sphalerite, galena, and (rarely) chalcocopyrite occurring as fine-grained disseminations in quartz-rich portions of the veins. These minerals can also occur as very fine-grained, cockade textured bands surrounding brecciated clasts of the previous stages of veining. Colloform banding of quartz, carbonate, base-metal sulfides, and carbonate and quartz vug infill are also common. The highest gold grades commonly occur with weakly disseminated (< 2%) pyrite, galena, and sphalerite.

The last vein stage includes thin veinlets of quartz, calcite, and rarely rhodochrosite. These 1 to 5 mm wide veinlets are observed in all drill core intercepts where they traverse the previous paragenetic stages. Quartz is anhedral, very fine-grained, and granular with interstitial calcite.

8.2 DEPOSIT MODEL

The formation of the Efemçukuru gold deposit in western Anatolia coincided with Miocene extension, magmatism and hydrothermal activity including the formation of several other significant gold-rich porphyry and epithermal deposits in the region (Baker, 2019). In detail, Efemçukuru can be classified as an intermediate sulfidation epithermal vein deposit due to its high-base metal content and the Mn-rich nature of the veins, analogous to intermediate-sulfidation epithermal veins of Mexico (Simmons et al., 2005). The dominantly NE dipping Efemçukuru veins formed within faults that had east side down normal-dextral (right lateral) shear sense.

Classic porphyry-epithermal models commonly show epithermal deposits forming on the periphery of higher temperature and deeper magmatic-hydrothermal systems such as porphyry and/or skarn deposits (Sillitoe and Hedenquist, 2003). The spatial and temporal distribution of rhyolite, high temperature calc-silicate alteration, and intermediate sulfidation epithermal veins support a magmatic-hydrothermal origin. Furthermore, detailed carbon and oxygen isotope analysis of vein carbonates indicate a mixed meteoric and magmatic source for the hydrothermal fluids and strongly support degassing and boiling of magmatic fluids in the generation of the main epithermal veins (Boucher, 2016).

SECTION • 9 EXPLORATION

9.1 SURFACE AND SUBSURFACE EXPLORATION WORK

Prior to modern exploration and mining, the Turkish Mine Exploration Institute records documented Efemçukuru as a manganese occurrence. However, later evidence recognised by Tüprag suggests that Romans mined the deposit in ancient times. Later, in the early 20th century, a British company owned the exploration rights and carried out limited work on the Efemçukuru deposit.

Modern exploration activity at Efemçukuru began in 1992, when Tüprag geologists recognized the exploration potential of the area while conducting reconnaissance work in western Türkiye. Between 1992 and 1996, Tüprag conducted ground magnetic surveys, rock chip and soil sampling, geological mapping and 6,000 metres of diamond-drilling focusing primarily on the Kestanebeleni vein. This work identified high-grade gold mineralization in three separate zones: the SOS, the MOS and the NOS.

Drilling in 1997 and 1998 provided the basis for initial resource estimates for the SOS and MOS, and a prefeasibility study was completed in 1999. Drilling programs from 2006 to 2010 significantly increased the Mineral Resources along strike to the north and downdip, resulting in the first resource estimate for the NOS. Drilling in 2011 and 2012 focused on a new zone, the KBNW, along strike from the NOS. Exploration since 2010 has focused on the Kokarpınar vein located east of, and oriented subparallel to, the Kestanebeleni vein. In 2018, the Batı veins were discovered in the footwall to the Kestanebeleni vein. Since 2018, the Batı and West veins have been added to the focus of exploration activities.

Table 9-1: Exploration Activity Summary for Efemçukuru Mining Area

Exploration Activity	Quantity	Length (m)	Area (km ²)
Stream Silt Sampling	147	-	-
Soil Sampling	4,733	215,500	
Rock Chip Sampling	5,365	-	-
Trench Sampling	868	1,820	
Mapping	-	-	34
Geophysics Magnetics	-	77,410	
Geophysics IP	-	70,225	-

9.2 MAPPING

Geological mapping at Efemçukuru has proven to be highly effective for discovering and delineating new veins. Mapping at 1:5,000 scale was carried out over the Kestanebeleni vein in the early stages of exploration. To date, a total area of 34 km² has been mapped at Efemçukuru, including detailed geological mapping over the entire strike length of the Kestanebeleni, Kokarpınar, Batı, and West vein systems. In addition, mapping of the underground mine developments is ongoing. Surface and underground mapping, in addition to drill hole logging combined with structural data, have been used to model the vein systems in 3D and help define new mineralized targets.

9.3 SURFACE SAMPLING AND TRENCHING

A total of 5,365 rock chip samples have been collected across the majority of outcropping veins on the property and 868 trench samples were obtained from 20 trenches. These data sets have helped prioritize drill targets but have not been used in the resource estimations.

9.4 GEOPHYSICS

Nearly 150-line km of ground geophysics have been conducted on the property to assist in identifying the epithermal vein systems (Table 9-1). This includes ground magnetic and IP and gradient IP surveys.

9.5 ONGOING EXPLORATION & FUTURE PROSPECTS

The surface mapping, sampling, and geophysics described above have identified numerous vein systems (e.g., Dedebağ, Volkan, Huseyinburnu) in the southwestern part of the property that are collectively called the West veins. These targets have been the focus of exploration drilling in 2023 and remain prospective for the discovery of additional mineralization.

Mine exploration from underground has helped identify new mineralized targets and extensions at Efemçukuru. Recent targets include the down-dip extensions of the SOS and the MOS. These targets have been assessed through underground exploration drilling from a hanging wall development named the Kestanebeleni HW drift.

SECTION • 10 DRILLING

10.1 EXPLORATION & DELINEATION DRILLING

Five phases of exploration drilling were carried out at the Efemçukuru site between 1992 and 1997, gathering geological, geochemical, and metallurgical data following discovery of the Kestanebeleni vein.

Delineation and further exploration drilling from 2006 to 2008 focussed on the Kestanebeleni NOS. Following the positive feasibility study for the project, Eldorado continued drilling activity on the Kokarpınar Vein area between 2009 and 2011.

Drilling in 2011 and 2012 focused on a new zone, the KBNW, along strike from the NOS on down-dip extensions to the SOS and the Kokarpınar vein. Exploration drilling programs in 2013 through 2017 tested the Kokarpınar vein over a 3 km strike length and allowed data to generate Mineral Resource estimates in several discrete shoots.

In 2017, approximately 19,765 m of drilling was completed from the Kestanebeleni Drift to test the extent of the mineralization at deeper parts of the MOS and the SOS-MOS transition area. In 2018, 22,867 m of exploration drilling was completed targeting expansion of the resource in the Kokarpınar vein and the newly discovered Batı veins, located in the footwall of the Kestanebeleni vein. A further 4,944 m were drilled in 2018 to delineate a mineralized zone at Kestanebeleni NW shoot. In 2019, a total of 26,084 m of exploration drilling at the Batı and Kokarpınar veins and 5,827 m of delineation drilling on Kokarpınar vein was completed.

In 2020, a total of 20,178 m of exploration drilling was completed at the Batı and Kokarpınar veins. The following year, 2021, a total of 15,121 m of exploration drilling at the West and Kokarpınar veins, and 19,591 m of delineation drilling focused on Kokarpınar vein was completed. In 2022, a total of 23,066 m of exploration at the West and Kokarpınar veins, and 59,679 m of delineation drilling on Kestanebeleni, Batı, and Kokarpınar veins was completed. Recently, during 2023, a total of 37,847 m of exploration drilling at the Batı and West veins, and 19,108 m of delineation drilling on Kestanebeleni, Batı and Kokarpınar veins was completed.

Table 10-1 summarizes the drilling that has been completed by Tüprag on the property to the end of 2023, and a drill hole location map of the Efemçukuru mine area is illustrated in Figure 10-1.

Table 10-1: Summary of Drilling on the Efemçukuru Deposit

Pre-Mining				
Location	Type of Drilling	Year	# of Holes	Meters
Kestanebeleni Vein	Exploration – Development	1992 through February 2011	299	51,052
	Infill – Core		101	6,589
	Reverse Circulation		58	5,028
Kokarpınar Vein	Core		16	4,340
	Percussion		8	394
Post-Mining				
Location	Type of Drilling	Year	# of Holes	Meters
Kestanebeleni Vein	Exploration – Development	February 2011 through 2023	212	54,134
	Infill – Core		5022	391,668
	Reverse Circulation		7	1,220
	Geotechnical		16	1,710
Kokarpınar Vein	Exploration - Development		461	146,430
Batı Vein			298	96,931
Other			163	53,284
Total			6661	812,780

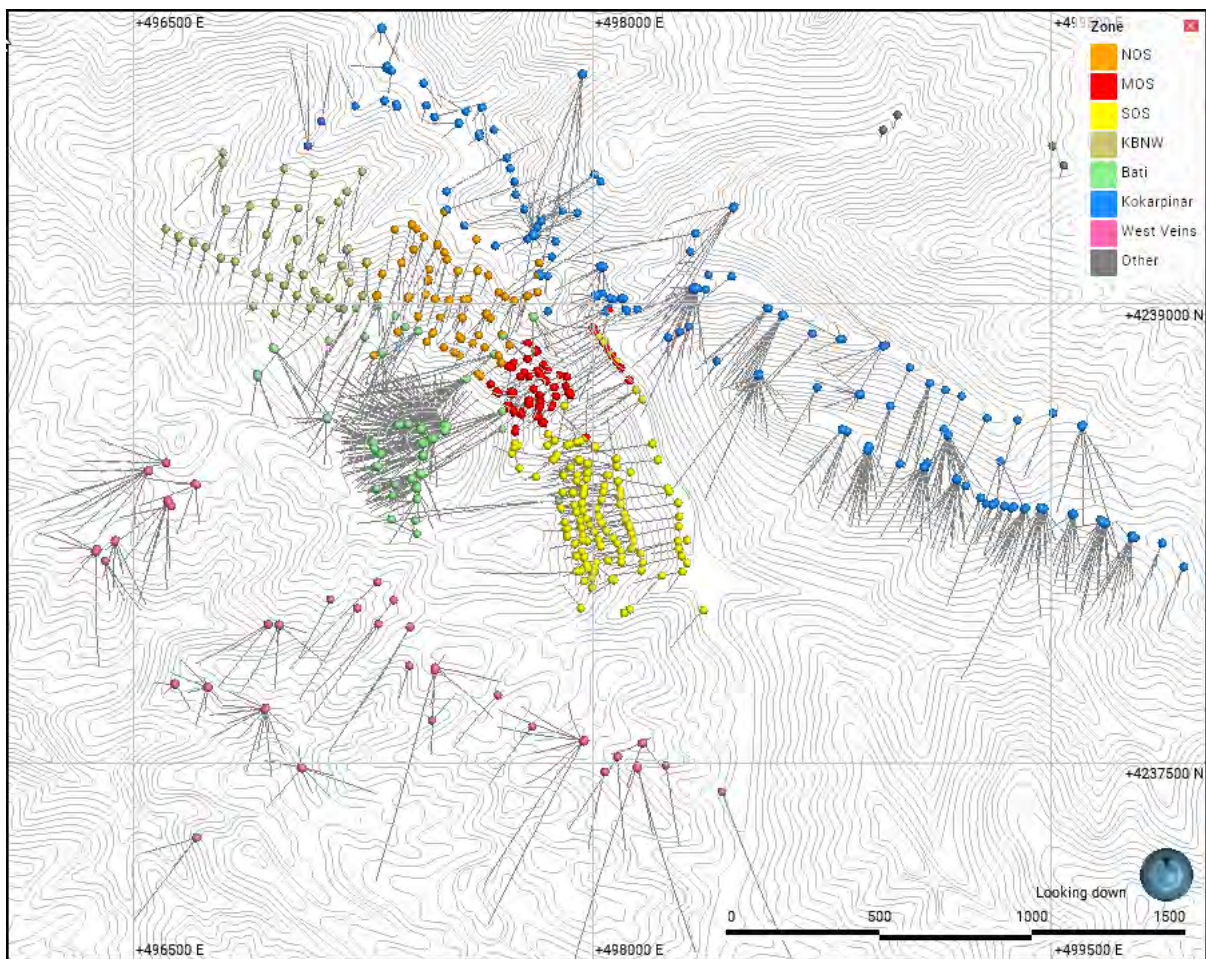

Figure 10-1: Map of exploration and delineation drillhole collars and traces (Eldorado, 2023)

Various drilling contractors were used at different stages of the programs. In the early days, Kennebec and Major Drilling from Quebec were used. Turkish contractors, including IDC, Ortadogu Drilling, Spektra Jeotech, and Solid Drilling, were engaged in later years.

Core drilling programs were executed by using skid mounted Longyear 38, D-120, D-150, Atlas Copco CS-14 and Geo1500 rigs. Reverse circulation drilling was completed with Tüprag's Explorer rig and an IDC Mustang rig.

Exploration and delineation drilling was carried out along the Kestanebeleni vein on profiles spaced from 20 m to 40 m apart. The down dip spacing along profiles ranges from 20 m to over 40 m. Deeper exploratory holes were drilled from the 435-exploration drift to intersect the vein over 500 m below surface vein exposure.

In early drill programs, most core holes were drilled roughly perpendicular to the vein at dips ranging from -45 to -85 degrees. The inclination and direction of drilling for the 2006 and 2007 programs was variable due to the limited number of collar locations available from which to drill. Holes drilled along 195 to 260 degrees azimuths at Kestanebeleni vein and along 200 to 300 degrees azimuths at Kokarpınar vein. Down hole deviation surveys for holes drilled in 2007 and 2008 were measured using gyroscope (1991 to 1997), Reflex EZ Shot (2006 to 2016), and Devishot (2017 to 2023) survey instruments. Readings were taken at 25 m intervals down the hole between 2006 and 2018. Since 2019, readings were taken at 6 m intervals down the hole for surface drilling and at 9 m intervals down the hole for underground drilling.

Standard logging and sampling conventions were used to capture information from the drill core. The core was logged in detail onto paper logging sheets, and the data were then entered into the project database. Specific gravity measurements were made on mineralized intervals as well as adjacent wall rock on each side. The core was photographed before being sampled.

Core recovery in the mineralized units was very good, averaging 97% for over 92% of core intervals in the mineralized zones. The relatively small number of poorer recovery intervals have a negligible impact on the Efemçukuru Mineral Resource estimate.

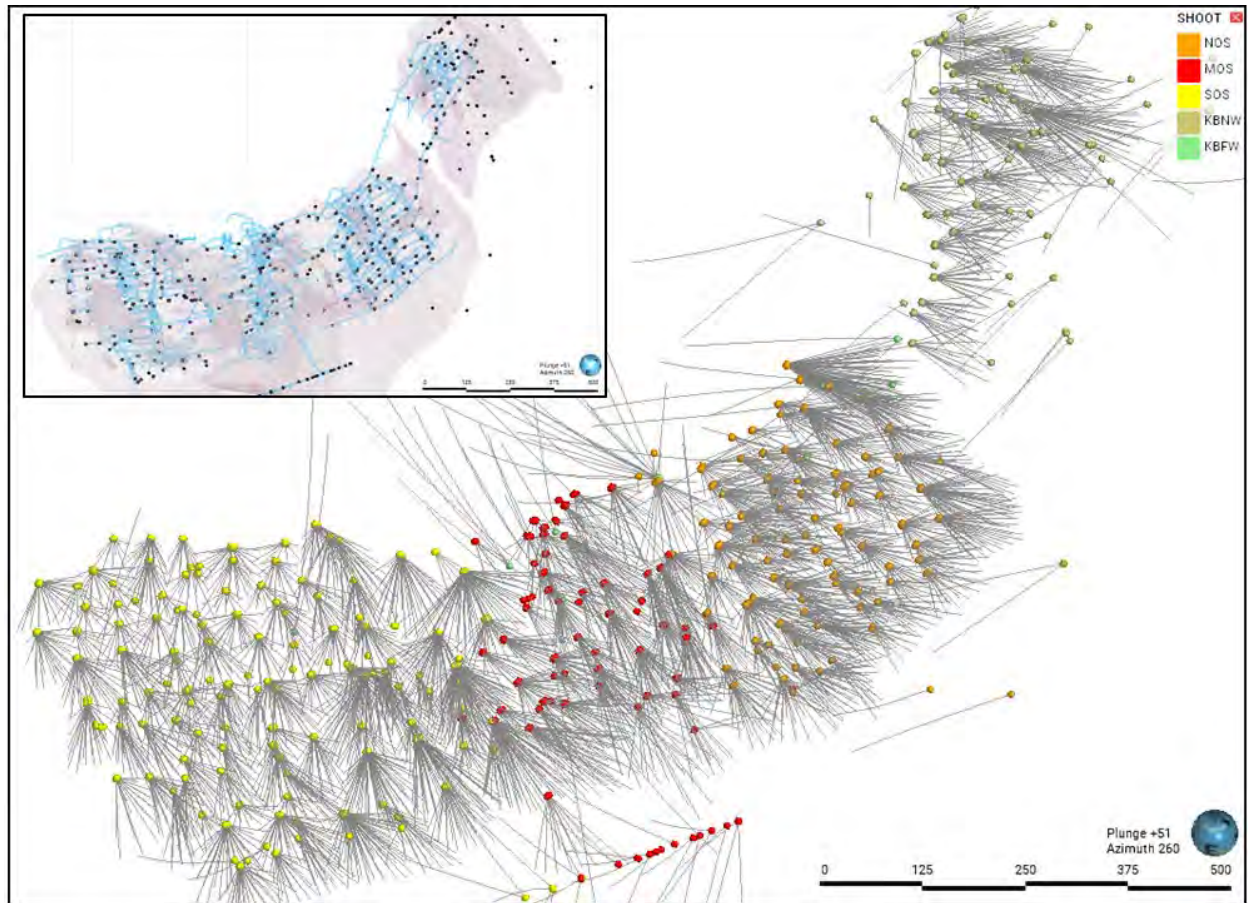

Figure 10-2: Oblique 3-D view (facing west) of Infill Drillhole Collars and Traces, Kestanebeleni

Note: For clarity, the inset shows the same view of the collar locations relative to the Kestanebeleni vein and the underground development (blue)

10.2 INFILL DRILLING

Diamond drilling is essential for infill and delineation to increase the geologic confidence in the mining areas and to improve the grade control model. At Efemçukuru, the gold is not visible and is not evenly distributed along the mineralized vein. Added complications are the local structural patterns that control the gold mineralization. As such, the definition of gold mineralization is dependent on diamond drilling. An average of over 35,000 m of mostly BQ-size core is drilled annually by three drill rigs at a cost of about \$30/m.

Figure 10-3 shows a diamond drill rig in an underground drill station.



Figure 10-3: Diamond Drill Rig in an Underground Drill Station

The planning and execution of the drilling pattern depends on the configuration of the ore shoot and the planned mining method. Ore extraction is mainly by drift and fill (DAF) mining augmented by long hole open stoping (LHOS). For areas mined by DAF, a 10 by 10 m staggered grid pattern is implemented (Figure 10-4a). Narrow vein LHOS was implemented over the last few years. This mining type is defined by a modified 10-by-10-meter grid that contains a fifth hole located at the centre of the defined square (a “five-spot” or “dice” pattern; Figure 10-4b). The drilling of a specific area is scheduled to be finished six to eight months prior to mining. This scheduling is sufficient for short-term grade model updates and any needed changes to the planned development or stope sequencing prior to planned production from the stope area.

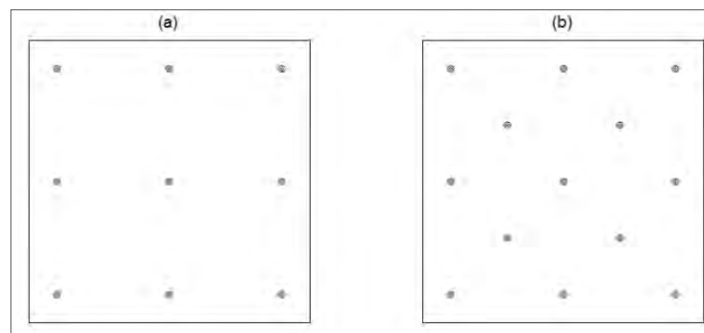

Figure 10-4: Infill Drilling Pattern a) 10 m × 10 m grid b) five dice pattern

SECTION • 11 SAMPLE PREPARATION, ANALYSES AND SECURITY

11.1 SAMPLE METHOD

Most diamond drilling since production commenced at Efemçukuru mine comprised of infill and delineation drill holes (indicated to measured programs and inferred to indicated campaigns). Only sampling for the last four years (2020 to 2023) is described in this section as most previously sampled material has been mined and the majority of the resources to be mined rely on drilling carried out since 2020.

Drill core is placed into core boxes marked with hole ID, sequence numbering, and depth interval. Sample intervals, selected and marked up by the logging geologist, range from 0.1 m to 3.7 m. The drill core samples were either cut with a diamond rock saw (if a delineation hole) or whole core sampled (if an infill hole) at the mine's core logging facility in Gazimir, 33 kilometers east of the Efemçukuru mine site. The samples are bagged and sent for sample preparation to ALS, an independent analytical laboratory located nearby in Gazimir, which holds an ISO / IEC 17025 certificate. The sample preparation procedure is as follows:

- Samples are logged into the lab's tracking system.
- The samples are crushed to 90% passing 2 mm.
- The samples are sub-sampled by riffle splitter until about 1 kg remains.
- The sub-sample is pulverized to 90% passing 75 microns.

The procedure includes inserting either a Certified Reference Material (CRM), blank, or duplicate into the sample stream of every eighth sample.

11.2 ASSAY METHOD

Exploration core samples are assayed for gold by 50-g fire assay and underground core samples are assayed for gold by 30-g fire assay with an AA finish. All samples are assayed for multi-element determination using fusion digestion and inductively coupled plasma (ICP) spectroscopy analysis.

Underground core samples that return assays greater than 10 ppm and exploration core samples that return assays greater than 5 ppm, are re-assayed by fire assay with a gravimetric finish.

11.3 QUALITY ASSURANCE AND QUALITY CONTROL (QA/QC) PROGRAM

Assay results are provided to Eldorado in electronic format and as paper certificates. Upon receipt of assay results, values for CRMs and field blanks are tabulated and compared to the established CRM pass-fail criteria:

- Automatic batch failure if the CRM result is greater than the round-robin limit of three standard deviations.

- Automatic batch failure if two consecutive CRM results are greater than two standard deviations on the same side of the mean.
- Automatic batch failure if the field blank result is over 0.5 g/t Au, if the analytical blank is over 0.05 g/t.

If a batch fails, it is re-assayed until it passes. Override allowances are made for barren batches. Batch pass / failure data are tabulated on an ongoing basis, and charts of individual reference material values, with respect to round-robin tolerance limits, are maintained.

Laboratory check assays are conducted at the rate of one per batch of 20 samples, using the same QA/QC criteria as routine assays. Additionally, the ALS laboratory is visited once a year by the site geology team to observe and ensure that stated procedures are being followed.

11.3.1 QA/QC

Eldorado regularly monitors the performance of CRMs, blanks and duplicates as the assay results arrive on site. The last three years of CRM, blank, and duplicate data were used for this report.

Table 11-1 shows the number of samples, blanks, duplicates, and CRMs used during drill campaigns for 2020, 2021, 2022 and 2023.

Table 11-1: QAQC sample frequency, 2020 to 2023

Number of Samples	2020 –2023			
	Exploration	% of Total	Mine	% of Total
# Samples	25,395	84	34,589	90
# Blanks	1,208	4	1,701	5
# Duplicates	1,845	6	420	1
# CRM	1,822	6	1,661	4
Total Assayed Samples	30,270		38,371	

Note: Totals may not add to 100% due to rounding.

11.3.2 CRM Performance

Eldorado strictly monitors the performance of the CRM samples as the assay results arrive at site. Multiple CRM samples are inserted into the sample batches to cover a wide range of gold grades (0.5 to 35 g/t). This corresponds to three grade groupings: ones close to the resource / reserve cut-off grade range (2 to 4 g/t); ones that hover about the average gold grade of deposit (7 to 10 g/t); and ones that control high-grade gold mineralization (greater than 10 g/t). CRM samples utilized over the last four years are shown in Table 11-2. CRM performance is monitored by charting. Examples of CRM charts are presented in Figure 11-1.

All samples were given a “fail” QA/QC flag as a default entry in the mine’s database. A “pass” flag was only allowed once the assays were shown to have passed acceptance criteria. At the data cut-off of March 31, 2023, all samples had passed QAQC criteria.

Table 11-2: Main CRM Samples used between 2020 and 2023

CRM CODE	Au g/t	Standard	# Used	Period used	
	Mean	Deviation	CRM Samples	From	To
COS055	2.638	0.087	239	12-Sep	22-Jan
COS057	2.244	0.057	9	18-Sep	21-Dec
COS058	3.012	0.121	383	12-Oct	23-Mar
COS059	1.476	0.057	2	18-Sep	20-Dec
COS082	0.634	0.019	40	16-Nov	23-Mar
COS084	8.264	0.295	6	18-May	22-Jan
COS085	4.014	0.106	10	16-Mar	20-Oct
COS086	6.692	0.14	36	16-Mar	22-Mar
COS087	11.655	0.334	103	16-Mar	21-Dec
COS095	1.003	0.025	24	23-Mar	23-Mar
GS-12B	11.88	0.57	169	22-Mar	23-Mar
GS-1Z	1.155	0.095	284	22-Mar	23-Feb
GS-4N	3.88	0.271	495	22-Mar	23-Mar
GS-6G	6.3	0.3	22	22-Mar	22-Jun
GS11B	11.04	0.28	579	18-Jan	23-Mar
GS25	25.6	0.51	287	19-Feb	20-Dec
GS3P	3.05	0.08	44	19-May	21-Mar
GS3Q	3.3	0.12	10	16-Jun	21-Mar
GS3U	3.29	0.08	37	16-Apr	23-Mar
GS7G	7.18	0.21	203	19-Jul	21-Jan
GS7K	7.08	0.21	441	16-Jun	23-Jan
GS7L	7.99	0.16	60	16-Sep	23-Mar

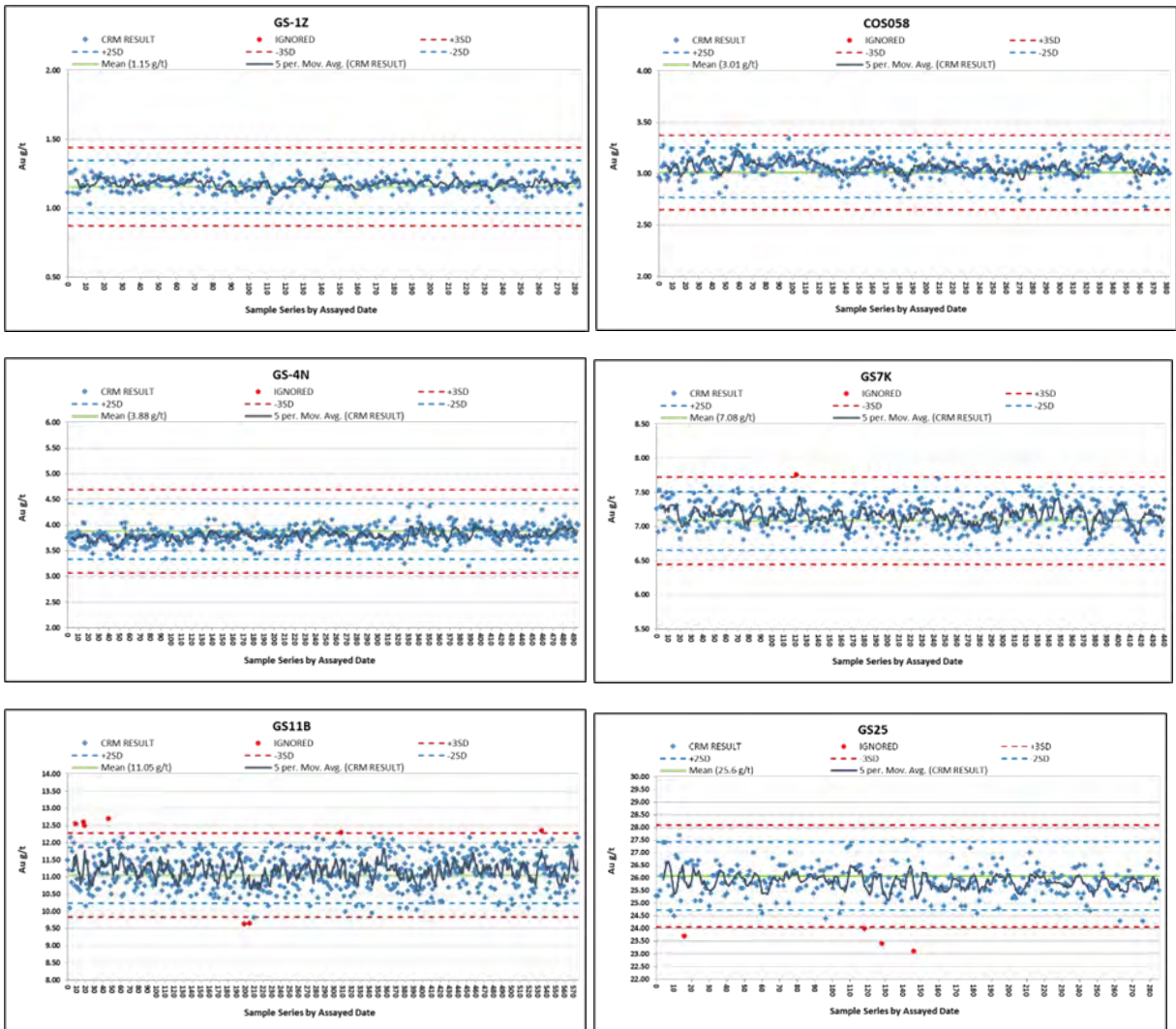

Figure 11-1: CRM Charts, 2020 to 2023, Efemçukuru Mine

11.3.3 Blank Sample Performance

Two blank sample types are used: a field blank in the form of a rock sample, and an analytical blank sample that is a pre-pulverized sample. Field blank samples are used to check for contamination during the entire sample preparation and analytical process at the laboratory, with a chosen rejection threshold of 0.5 g/t. Analytical blank samples are used to check the contamination after the sample preparation process, with a chosen rejection threshold of 0.05 g/t. The analytical detection limit for gold was 0.01 g/t, and results are shown in Figure 11-2.

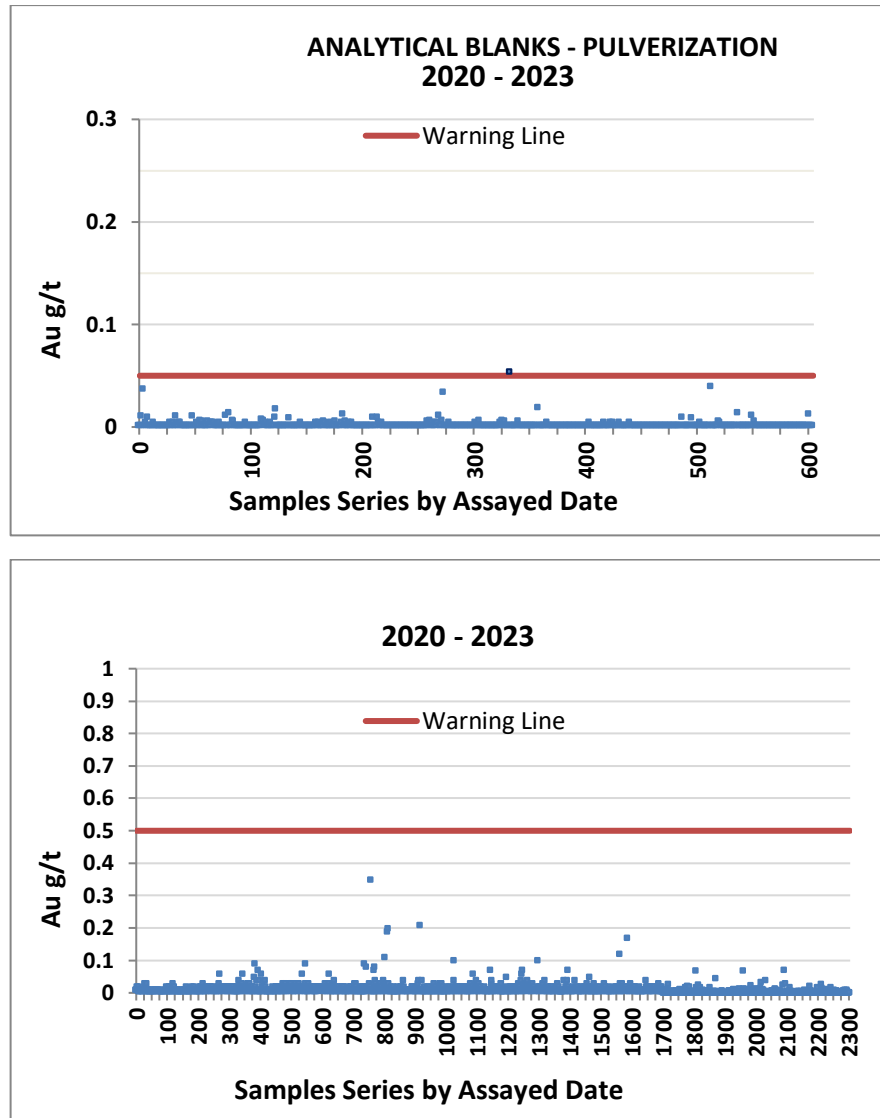

Figure 11-2: Efemçukuru Blank Data – 2020-2023 Drill Programs

11.3.4 Duplicates Performance

Eldorado implemented a program that monitors data from regularly submitted coarse reject duplicates. The duplicate data for Efemçukuru reproduce well and are shown in a relative difference chart in Figure 11-3 and percentile rank chart in Figure 11-4. Patterns observed in the relative difference plot are about zero, suggesting no bias in the assay process. The coarse reject chart shows that almost all data greater than 1 g/t fall well within the 20% limits. Of note is the excellent replication of samples with values greater than 10 g/t. This is also shown in the percentile rank plot where, at the 90th percentile of the population, the Efemçukuru data shows 10% difference in the coarse reject data.

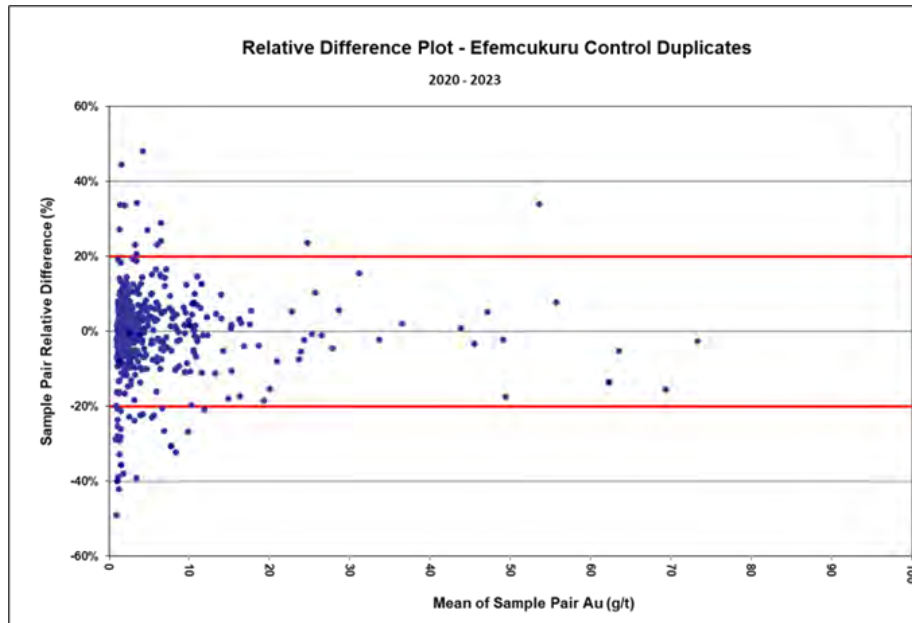

Figure 11-3: Relative Difference Chart, Efemçukuru 2020-2023 Duplicate Data

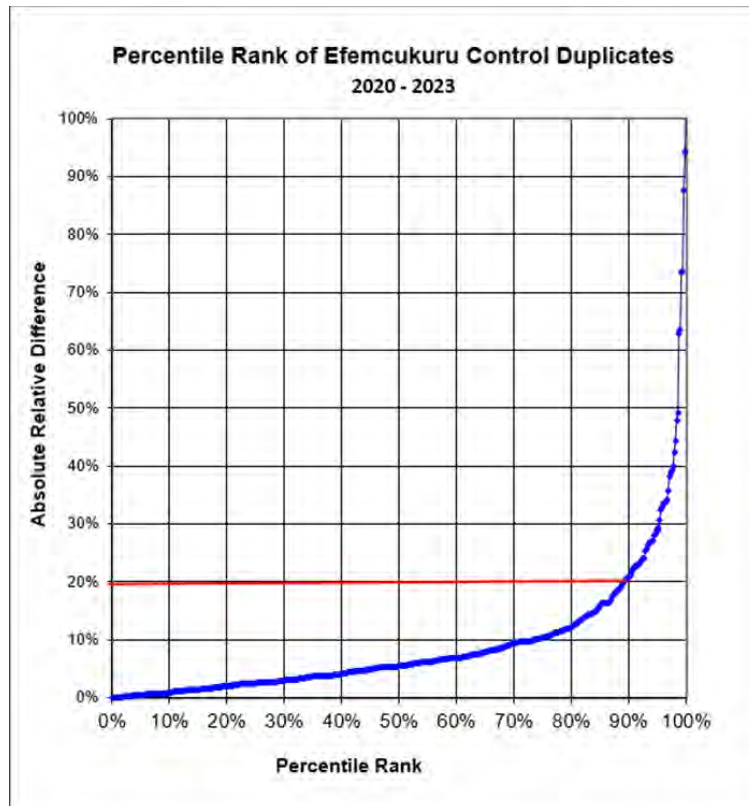

Figure 11-4: Percentile Rank Plot, Efemçukuru 2020-2023 Duplicate Data

Duplicate data were plotted on a Quantile-Quantile (QQ) plot to test for any bias in the analyses. If the distribution lies on or oscillates tightly about the 1:1 line, then the sample population is unbiased. This is the pattern observed for the Efemçukuru gold data in Figure 11-5.

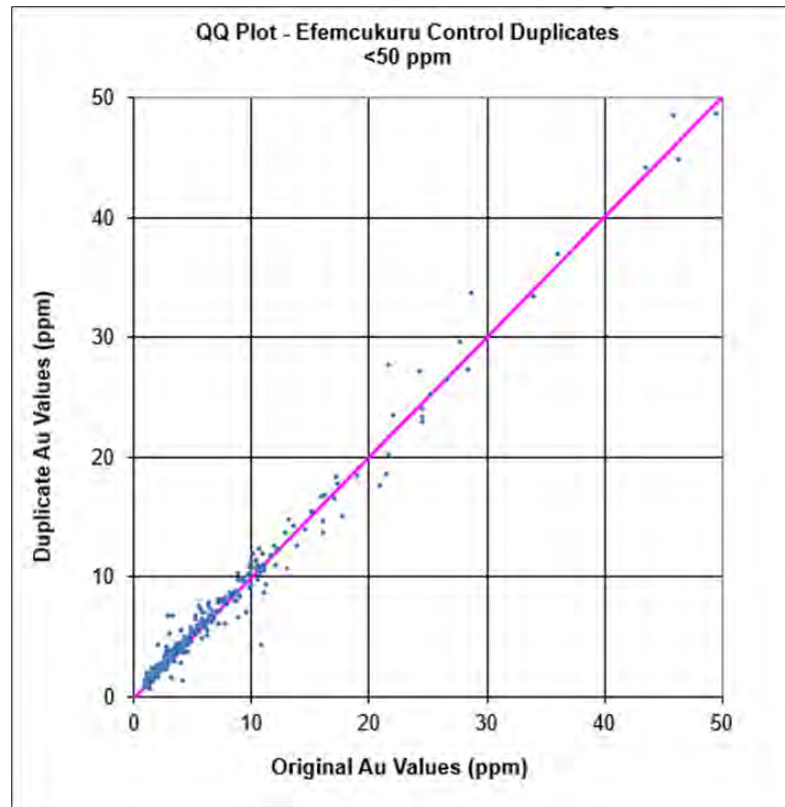

Figure 11-5: QQ Plot for Efemçukuru Duplicate Data

11.3.5 Specific Gravity Program

Definition drilling is conducted at underground drill locations, where multiple holes are drilled into the orebody from one location. In each drill location, several specific gravity (SG) measurements are taken so that the SG samples are approximately 40 meters apart.

Samples taken for assay from core holes were being measured for specific gravity and tabulated by rock type. The specific gravity for non-porous samples (the most common type) was calculated using the weights of representative samples in water (W_2) and in air (W_1). The bulk density (D) was calculated using the following equation:

$$D = W \frac{W_1}{(W_1 - W_2)}$$

Less-common porous samples were dried and then coated with paraffin before weighing. An allowance was made for the weight and volume of the paraffin when calculating the SG.

11.4 CONCLUDING STATEMENT

No drilling, sampling, or recovery factors were employed that would have any material impact on the accuracy or reliability of the results.

The QP is not aware of any sampling or assaying factors that may materially impact the mineral resource estimate discussed in section 14. There are currently no recommendations to improve QA/QC results.

In the QP's opinion, the QA/QC results demonstrate that the Efemçukuru mine's sample preparation, security, analytical procedures and assay database are sufficiently accurate and precise for the resource estimation.

SECTION • 12 DATA VERIFICATION

12.1 DRILL DATA HANDLING AND SECURITY

12.1.1 Core Logging Data

Core logging data is captured directly into a digital interface and stored in an acquire™ database. Built-in checks within the database system contribute to data integrity by:

- Requiring geologists to choose geological codes from pick lists,
- Preventing overlapping intervals and intervals that extend beyond the maximum depth of the drillhole, and
- Minimizing data handling errors by eliminating the need for manual manipulation of data.

12.1.2 Analytical Data

All assay data are imported into the Efemçukuru mine database. The data entry system has checks in place that prevent such common errors as overlapping sample intervals, or sample intervals that extend beyond the maximum length of the hole. Once assay results are received from the laboratory, the following steps are taken to ensure that the data provided to end-users (geologists, resource modelers) are complete and error-free:

- A “quarantine” system is in place to hold information until validated and checked.
- Release can only be made by the database administrator.
- Assay data are imported directly from the laboratory’s csv file.
- Drilling data such as collar surveys, down hole surveys, assays and logged lithologies are routinely cross checked against original source files.
- Discrepancies are rare but when observed, immediately corrected.

As a result of these checks and balances, the data supporting the Efemçukuru resource work are sufficiently free of error and adequate for resource estimation.

12.2 BLOCK MODEL TO MILL RECONCILIATION

Another form of data verification is reconciliation of the block model to the final mill production figures. The reconciliation process flowchart that occurs at Efemçukuru mine is shown in Figure 12-1.

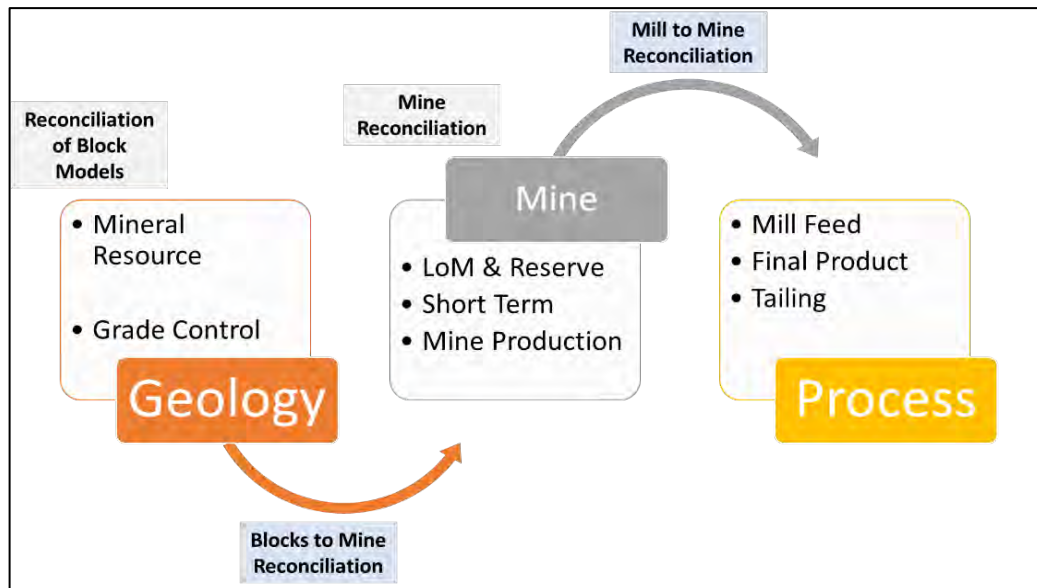

Figure 12-1: Flowchart of the Reconciliation Procedure at Efemçukuru Mine (Eldorado, 2023)

The annual reconciliation of resource model to mill feed tonnage and grade since 2012 is shown in Table 12-1, and illustrates a marked improvement from 2016, to within 1-2 percentage points, with excellent performance over subsequent years. These results demonstrate that the Efemçukuru data management and QAQC protocols produce highly verifiable data to allow quality resource estimation at the Efemçukuru mine. Validations have been thorough on programs conducted since 2012. There have been no limitations or failure to conduct data verification.

Table 12-1: Annual Resource Model to Mill Reconciliation Data

Year	Resource Model			Mill Feed			Differences of Resource Model (%)		
	Tonnes	Au g/t	Au oz	Tonnes	Au g/t	Au oz	Tonnes	Grade	Gold
2012	369,953	9.86	117,325	352,156	9.26	104,791	-4.8%	-6.2%	-10.7%
2013	399,930	9.32	119,833	413,513	8.87	117,895	3.4%	-4.8%	-1.6%
2014	428,276	8.38	115,334	436,851	8.34	117,099	2.0%	-0.5%	1.5%
2015	454,238	7.28	106,384	454,864	7.82	114,329	0.1%	7.3%	7.5%
2016	471,178	7.36	111,508	476,529	7.40	113,398	1.1%	0.6%	1.7%
2017	471,680	6.94	105,238	481,648	7.01	108,594	2.1%	1.1%	3.2%
2018	498,366	6.86	109,903	499,120	6.77	108,620	0.2%	-1.3%	-1.2%
2019	511,175	7.12	117,018	521,033	7.03	117,818	1.9%	-1.2%	0.7%
2020	515,973	6.74	111,889	523,702	6.76	113,746	-1.5%	-0.2%	-1.7%
2021	518,609	6.77	112,828	528,212	6.50	110,429	-1.9%	3.9%	2.1%
2022	541,155	5.83	101,459	544,449	5.82	101,868	-0.6%	0.2%	-0.4%
2023	540,072	5.61	97,385	547,089	5.64	99,284	1.3%	0.6%	2.0%
Total	5,719,604	7.79	1,326,969	5,779,167	7.72	1,327,913	1.0%	-0.9%	0.1%

12.3 DATA VERIFICATION BY QUALIFIED PERSONS

12.3.1 David Sutherland, P.Eng

Mr. David Sutherland, an employee based at Eldorado Gold's Vancouver Corporate Office, holds the role of Project Manager. With visits to the site since 2008, including his latest visit on November 8th, 2023, Mr. Sutherland reviewed the historic operations data and current capital and operating budgets. Additionally, recent pricing for equipment and construction costs for Eldorado's ongoing projects in Türkiye and Greece were used to benchmark current budgets. Based on these verifications, it is the opinion of the QP that the cost models are sufficient to support the technical report at a feasibility level and support the continued operation of the Efemçukuru project.

12.3.2 Mike Tsafaras, P.Eng.

Mr. Mike Tsafaras, an employee based at Eldorado Gold's Vancouver Corporate Office, holds the role of Director, Underground Mine Planning, Technical Services. Mr. Tsafaras visited site from March 27th to 30th, 2023, and has performed a number of reviews in support of Mineral Reserves that included: underground design parameters (Stope Optimizer inputs), production scheduling assumptions (productivity rates, mine sequencing), unit cost summary and cutoff value calculation, net smelter return (NSR) formulation and application in the resource block model, and re-interrogation of solids with block model for checking material quantities. As a result of the data verification, Mr. Tsafaras considers that Mineral Reserves are supported, and the mine plan is achievable.

12.3.3 Sean McKinley, P.Geo.

Mr. Sean McKinley, an employee based at Eldorado Gold's Vancouver Corporate Office, holds the role of Manager, Geology & Advanced Projects. He has made frequent visits to the site between 2013 and 2023, the most recent being on February 3, 2023.

While on site, Mr. McKinley usually undertakes the following tasks as part of his verification process:

- Visits drill sites both on surface and underground to verify drilling procedures and core handling.
- Visits the core shack on site to monitor core logging procedures.
- Discusses geological features observed in drill cores with site geologists.

While in the office, Mr. McKinley completes the following data verification tasks:

- Examines drill collar locations in 3D to assess for spatial errors or offsets away from roads, drill platforms or underground workings.
- Examines drillhole traces in 3D to visually assess possible spurious downhole surveys (e.g. "bends" in drillholes, excessive deviations). Drillholes are not used in any models until the source of such errors are determined and remedied.
- Examines 3D geological model elements to ensure that they honor the underlying raw data and that they adhere to our understanding of the property geology and structure.

By using these procedures, it is the opinion of the QP that all geological models and their source data are of a high quality and are suitable for use in a mineral resource estimation.

12.3.4 Ertan Uludag, P.Geo.

Mr. Ertan Uludag, an employee based at Eldorado Gold's Vancouver Corporate Office, holds the role of Manager, Resource Geology. With frequent visits to the site since 2011, including his latest visit from June 19th to 21st, 2023, Mr. Uludag conducts on-site tasks involving the verification of drilling procedures, close monitoring of core logging, sampling, and collaborative discussions with site geologists. During model updates, Mr. Uludag examines drill collar locations and drillhole traces in 3D, ensuring spatial accuracy and identifying anomalies before incorporating them into models. He confirms that no limitations were encountered during the verification process, and the verification procedures were conducted without any constraints or failures. These verifications and opinions expressed in the report pertain specifically to sections 11, 12, and 14, for which he holds responsibility. Additionally, he consistently reviews quality assurance / quality control (QA/QC) data and model reconciliation at quarterly intervals, ensuring maintenance of accuracy and quality in resource geology management.

12.3.5 Peter Lind, P.Eng.

Mr. Peter Lind, an employee based at Eldorado Gold's Vancouver Corporate Office, holds the role of Vice President, Technical Services. With frequent visits to the site since 2021, including his latest visit from March 27th to 30th, 2023, Mr. Lind reviewed testwork programs and results including assay data from metallurgical head samples and testwork products. Additionally, he reviewed processing costs and sustaining capital costs to support the calculation of cut-off values. Based on these verifications, it is the opinion of the QP that the metallurgical testwork supports the continuing processing of future ores through the Efemçukuru process plant.

SECTION • 13 MINERAL PROCESSING AND METALLURGICAL TESTWORK

13.1 INTRODUCTION

The Efemçukuru concentrator has been successfully processing ore from the Efemçukuru mine since commissioning in mid-2011. The original process flowsheet was designed to produce gold doré from gravity concentrate and gold-containing sulfide minerals in flotation concentrate. However, production of gravity concentrate was considerably lower than what was estimated in the feasibility study (expected 30% recovery) and the process flowsheet was revised in 2018 to produce only flotation concentrate for sale. This change had no effect on overall recovery because gravity concentrate was recovered from the flotation concentrate.

Mineral processing and metallurgical tests of ore samples taken during the production period are discussed in this section.

Key results from metallurgical testwork conducted between 2011 and 2019 are described in Section 13. below. Subsequent studies completed between 2020 and 2023 are the focus of this section. Table 13-1 shows the list of reports of the metallurgical testwork conducted.

Table 13-1: Reports Reviewed

Report Title	Author	Date
Technical Report on the Efemçukuru Project, NI 43-101 Report	Wardrop	August 2007
Tüprag Madencilik Efemçukuru Gold Mine, Turkey Metallurgical Testwork	Wardell Armstrong International	March 2016
Efemçukuru Gold Ore	Petrolab, Mineralogical Report AM2767	February 2018
Performance Evaluation and Optimization of Efemçukuru Concentrator	Hacettepe Mineral Technologies (HMT)	August 2018
Pilot Column Flotation Cell Tests and Selection of Column Flotation Cells for Efemçukuru Flotation Plant	Hacettepe Mineral Technologies	January 2019
Plant Archive: Plant data recorded from 2011 to end of 2023	TÜPRAG	2023
Performance Evaluation & Optimization of Flash Flotation Cell	Hacettepe Mineral Technologies	August 2019
Testing of Alternative Collectors	Hacettepe Mineral Technologies	December 2019
Testing MX-505 as an Alternative Collector: Plant Scale Trial	Hacettepe Mineral Technologies	November 2020
Performance Analysis of the Flotation Plant & Evaluation of Cleaner Tailings	Hacettepe Mineral Technologies	November 2021
Ore Variability Flotation Tests	Hacettepe Mineral Technologies	April 2022

Report Title	Author	Date
Flotation of High Sulfide Ore	Hacettepe Mineral Technologies	July 2022
The Relationship between Froth Parameters and Flotation Performance	Hacettepe Mineral Technologies	February 2023
Ore Variability Test Program	MRD Mineral Mining Technologies ALS Metallurgy Pty Ltd	December 2023
Plant Archive: Plant data recorded from 2011 to end of 2023	TÜPRAG	December 2023

13.2 HISTORICAL TESTWORK

This section summarizes a number of relevant testwork programs that were carried out prior to construction and during early years of operation at Efemçukuru.

13.2.1 Mineralogical Examinations

Vancouver Petrographics conducted an examination of 13 samples submitted by Tüprag in 1993. The major gangue minerals were identified to be quartz with varying amounts of rhodochrosite and rhodonite, as well as chlorite, hematite, jarosite, fluorites, calcite and manganese-silicates. The dominant sulphide mineral was found to be pyrite with subordinate and varying amounts of chalcopyrite, sphalerite, and galena, and generally trace amounts of arsenopyrite, tetrahedrite, covellite, pyrrhotite and marcasite. Gold was identified in five of the 13 samples. Generally, the gold was associated with pyrite as grains between 3 and 53 microns in size, and at times, the gold-containing pyrite was associated with sphalerite and/or chalcopyrite. Gold grains were also observed to be present as blebs in sphalerite, and chalcopyrite, and galena, and carbonate gangue. However, the most common association of the gold grains was found to be with the pyrite.

Anamet Services conducted a mineralogical examination in 1997 and identified the main gangue and ore-bearing minerals to be essentially the same as were reported by Vancouver Petrographics. Anamet also confirmed the presence of an unidentified bismuth-lead-silver sulphide mineral, and metallic bismuth, while the gold-bearing mineral was identified as being electrum, which is native gold, but containing varying amounts of silver in solid solution. The electrum was found to occur mainly as inclusions and along fractures with mainly pyrite, while sulphide-electrum intergrowths were also observed. The maximum liberated size particle of electrum was about 30 microns. Intergrowths and partial intergrowths of electrum particles of 15 microns, or larger, with mainly pyrite, were observed. Electrum particle sizes ranged from 0.5 to 30 microns but were found to be mostly associated or locked in pyrite. The pyrite was generally liberated at a grind size of about 75 microns, although a significant proportion of the electrum would be locked in the pyrite at this grind size. Galena, sphalerite and chalcopyrite would generally be liberated at this grind size, although individual grains would contain intergrowths and/or inclusions of the other minerals.

13.2.2 Comminution Testwork

A.R. MacPherson Consultants conducted grinding testwork on Efemçukuru samples in 1998 as summarized in Table 13-2.

Table 13-2: Efemçukuru Grindability Data – MacPherson Consultants

Composite Sample	Unit	Value
Feed Size, F ₈₀	µm	21,370
Product Size, P ₈₀	Mm	231
Gross Autogenous Work Index	kWh/t	22.45
Correlated Autogenous Work Index	kWh/t	18.10
Rod Mill Bond Work Index	kWh/t	18.40
Ball Mill Bond Work Index	kWh/t	17.20
Bond Abrasion Index	G	0.6701
SAG Mill Products SG	g/cm ³	3.06

The rod mill value was determined at the closing size of 1,410 microns (14 mesh), and the ball mill value at the closing size of 149 microns (100 mesh). The testwork reflects that the ore is relatively hard. In addition, the ore is abrasive and resistant to impact breakage, highlighting the need for a pebble crusher in the SAG mill circuit. This data was incorporated into the design of the grinding circuit.

13.2.3 Gravity Concentration and Flotation Testwork

Several testwork programs were conducted using gravity concentration and flotation testing of the Efemçukuru samples. The most comprehensive program was that conducted by CSMA Minerals in April 1998. Supplementary flotation testwork was conducted by WAI and reported in February 2006. Gravity-gold-recoverable (GRG) testwork was completed by Knelson Research on three samples submitted. The results obtained are discussed below.

13.2.3.1 CSMA Minerals, April 1988

The material presented to gravity concentration and flotation was milled to 85% passing 75 microns without any additional grinding step between the processes. The gravity concentration tests were performed with a Knelson centrifugal concentrator, and the concentrate obtained was further upgraded using a Mozeley separator. Eight samples were tested: EFG1, EFG2, EFG3, EFG4, EFG5, EFG6 and EFG7 and GC2. The first seven samples represented different types of mineralization of the Efemçukuru deposit. Sample GC2 was a composite sample representing the anticipated mill feed average mineralization.

The gold and silver in all the samples was shown to be clearly amenable to gravity recovery. The gold recovery values obtained varied between 26.1 to 57.0% while the silver recoveries varied between 5.4 and 30.8%. The subsequent flotation recovery was also good, with between 30 and 65% of the residual gold being recovered into a flotation concentrate resulting in an overall recovery ranging between 81 and 95%. The flotation recovery for the residual silver after gravity concentration varied between 44 and 77% resulting in an overall silver recovery of between 49 and 90%. The differences in the recoveries give an indication of the variability of the ore in the deposit. There was insufficient sample available from the gravity concentrate for a sulphur analysis to be determined and this presents a slightly distorted view of the sulphur balance. The design grind adopted was 80% passing 67 microns.

The testwork also indicated that selectivity was highly variable, with flotation concentrate mass recoveries generally ranging from 5.4% to 17.1%, although the test from sample EFG7 resulted in a very high mass recovery of 28.9%. This sample was taken from the transition zone where oxidation levels are higher.

The GC2 sample, a composite of all the ore types representing the expected average mineralization, gave the lowest gravity concentration recovery of all the samples, highlighting the variability of the Efemçukuru ore samples. However, the combined recovery from the gravity and flotation processes was 91% which is a reasonable overall gold recovery value.

13.2.3.2 Knelson Research & Technology Centre, 2007

Three ore composites, made up from a number of individual core intervals, were tested to determine the amount of gravity recoverable gold under standard test conditions utilizing four stages of size reductions. The samples were selected to represent the two sources of ore, namely SOS (South Ore Shoot) and MOS (Middle Ore Shoot), and also to test a high-grade MOS sample. The results indicate that ores from both SOS and MOS contain a significant amount of free gold, resulting in 41 to 57% gold recovery in these gravity concentration tests. Gold grains in the recovered gravity concentrates had a particle size of 80% passing 93, 88, and 115 microns, respectively for samples EFG10 (SOS sample), EFG11 (MOS sample) and EFG12 (MOS high-grade sample).

Since the recovery of gold under plant conditions varies with regard to mass recovery, and gold will be lost during the subsequent upgrading with a shaking table, the actual gravity gold recovery would be less. However, the Knelson results confirm the gravity recovery values previously obtained by CSMA Minerals, and also validates the selection of the gravity concentration process in the flowsheet. The assumed recovery of 30% gold in the process design criteria recovery by gravity will be a conservative estimate for the planned ore feed to the plant consisting of 50% EFG10-type and 50% EFG11-type material.

13.2.4 Flotation Testwork

13.2.4.1 Wardell Armstrong International

The most definitive flotation testwork of Efemçukuru samples was reported by WAI (CSMA Minerals) during 2005 and 2006 when batch and locked-cycle flotation tests were undertaken on two samples. The two samples tested represented the MOS (Middle Ore Shoot) and the SOS (South Ore Shoot). The results from the locked-cycle testwork conducted on these two samples, MOS (sample GC4) and SOS (sample GC3), were reported together with the flotation testwork results from the composite sample GC2 which had been tested in 1998.

The variation in the head grades of the three representative samples was apparent, although the GC2 head grade values are a reasonable average of the MOS/GC4 and SOS/GC3 samples with respect to gold, silver and sulphur. Similarly, the mass recovery for GC2 at 8.1% is reasonably positioned between the MOS/GC4 sample with the higher mass recovery of 16.4% and the relatively high 6.92% sulphur grade, and the SOS/GC3 sample with the lower mass recovery of 3.9% and the lower sulphur grade of 1.45%. However, the GC2 sample recoveries for gold, silver and sulphur would be expected to range between those obtained for the MOS/GC4 and the SOS/GC3 samples, but this was not found to be the case. The gold, silver and sulphur recoveries for GC2 were in fact

lower than the SOS/GC3 sample results. The probable presence of oxidized material in this sample could have contributed to these results. However, it is apparent that the two different areas of the deposit, namely the MOS/GC4 and SOS/GC3, are mineralogically distinct as typified by the different grades, and particularly the sulphur grade. A sulphide flotation recovery process will therefore be expected to give varying results depending on the origin, and the sulphur grade, of the ore reporting to the processing plant.

The overall design of the flotation circuit was based on GC2 conditions, namely a final flotation concentrate mass recovery of 8.1% and an overall gold recovery of 92% of which 30% would be recovered by gravity concentration and 62% by flotation.

13.3 RECENT METALLURGICAL TESTWORK

After operations began, it was apparent that the gravity concentration previously envisaged was less effective and a direct flotation flowsheet was instead adopted. A metallurgical testwork program was undertaken by Wardell Armstrong International (WAI) in 2016 to update the information about metallurgical characteristics and flotation behavior of main ore types from the SOS, NOS, and MOS.

More recently, testwork has been carried out to characterize ore from the other vein systems, including the Kokarpınar and Batı veins. In 2023, this included metallurgical testwork carried out at ALS Perth, and comminution testwork reported by JKTech as summarized in this section.

13.3.1 Head Assay

Efemçukuru is an underground mine and ore is currently mined from three ore shoots, the SOS, MOS and NOS. ROM ore is crushed in a jaw crusher underground and stored in bins on the surface. The plant feed is prepared as a blend of these ores, and their distribution in the blend is determined according to head assays. Typical head assays of these ore samples are summarized in Table 13-3. Head assays of plant feed sample taken during plant survey in February 2018 by HMT is also given in the table for comparison; this sample represents a snapshot of the feed during three-hour plant survey.

During the original design stage, expected mill feed grades were around 10.0 g/t Au and 17.8 g/t Ag. Head grades of typical high-grade ores and a plant feed sample from February 2018 are presented in Table 13-3. These samples were variability samples representing high-grade parts of the ore body.

Table 13-3: Head Assay of typical High-Grade Ores

Element	SOS*	NOS*	MOS1*	MOS2*	Plant Feed**
Au (g/t)	17.5	23.5	7.0	15.2	5.1
Ag (g/t)	28.6	36.4	13.4	17.2	18.9
Cu (%)	0.09	0.14	0.03	0.04	0.04
Pb (%)	0.21	1.32	0.25	0.31	0.64
Zn (%)	0.36	1.48	0.28	0.77	0.39
Fe (%)	3.53	7.89	2.26	5.25	4.63
Total Sulfur (%)	2.17	6.65	1.13	4.88	2.77
Sulfide Sulfur (%)	1.46	0.07	1.06	4.83	-
Total Carbon (%)	1.55	1.38	2.41	-	-

*WAI Report; **HMT report

13.3.2 Mineralogical Examination

Typical mineralogical analysis of the plant feed is given in Table 13-4. Major sulfide minerals identified in all the samples are pyrite, sphalerite, and galena. A small percentage of chalcopyrite is also present. Major gangue minerals are quartz, manganese-minerals with minor feldspar, calcium-carbonates, siderite, mica-group minerals, and epidote group minerals.

Gold is generally finely crystalline and primarily associated with pyrite and galena, some association with manganese-carbonates and iron oxides.

Pyrite and sphalerite generally show good liberation, with improving liberation for the fine size fractions. Galena also shows improving liberation for the fine size fractions.

Table 13-4: Modal Mineralogy of a Plant Feed Sample (February 2018)

Minerals	%
Quartz	38.29
Pyrite	11.18
Manganese-Silicate	9.89
Manganese-Carbonate	9.85
Feldspar	7.40
Calcium-carbonates	4.84
Siderite	4.33
Mica	3.97
Epidote	3.49
Ultramafics	1.79
Iron Oxides	1.62
Sphalerite	1.60
Fluorite	0.93
Galena	0.47
Others	0.30
Chalcopyrite	0.03

13.3.3 Comminution Characteristics

Comminution characteristics of the ore have been measured by various laboratories at different periods. Original design values, results of earlier tests performed by WAI, and recent testing by ALS and reported by JKTech are summarized in Table 13-5 and Table 13-6. All of the tests reflect that the ore is moderately hard, abrasive, and resistant to impact breakage.

Table 13-5: Comminution Characteristics of Efemçukuru Ore, Kestanebeleni Vein

Sample Name	Bwi (kWh/t)	Ai	Axb	ta	SCSE* (kWh/t)	S.G. (t/m ³)
Plant Feed in February 2018	20.4	-	43.4	0.35	9.9	2.89
SOS Ore	18.1	0.567	43.1	0.53	10.1	2.95
NOS Ore	19.4	0.636	34.4	0.21	11.6	3.11
Original Design Values	20.7	0.713	46.4	0.51	-	2.90

*SAG circuit specific energy

Table 13-6: Comminution Characteristics of Efemçukuru Ore, Kokarınar Vein

Sample Name	DWi (kWh/t)	Mia (kWh/t)	Mih (kWh/t)	Mic (kWh/t)	Axb	ta	SCSE* (kWh/t)	S.G. (t/m ³)
Kokarınar – Zone 51	4.6	14.2	9.7	5.0	59.5	0.57	8.33	2.72
Kokarınar – Zone 52	6.9	18.5	13.8	7.1	42.3	0.38	10.07	2.91

*SAG circuit specific energy

13.4 FLOTATION

Flotation testwork was performed on four samples (SOS, NOS, MOS1, MOS2) by WAI. Optimum primary grind size was determined to be 80% passing 63 μm . The reagents used in flotation were sodium bisulfite (NaHSO_3) as sulfidizing agent, copper sulfate ($\text{CuSO}_4 \cdot 5\text{H}_2\text{O}$) as activator, xanthate (SIBX) as collector, S-8045 as promoter, and OrePrep F-549 as frother.

After rougher and open-circuit cleaner tests, locked-cycle tests (LCT) were performed for each sample under optimum flotation conditions. Table 13-7 shows concentrate mass pull, concentrate grade, and recovery values of final concentrates from LCT tests. The gold grade of the concentrates ranged between 106 g/t and 220 g/t, and gold recovery between 86.5% and 94.5%. Despite the NOS containing 6.58% sulfide sulfur content, the final concentrate contained 119 g/t Au with 93.6% Au recovery. For the SOS ore sample, gold recovery (86.5%) is lower despite total sulfur recovery being almost 95%.

Mineralogical analysis has identified gold as being predominantly associated with pyrite, and in most cases gold recovery is proportional to sulfur recovery. The situation with the SOS ore samples may be indicative of some minor gold association with non-sulfide gangue, particularly manganese-bearing minerals.

Table 13-7: Mass Pull, Grade and Recovery of Concentrates from Locked Cycle Tests

Sample		Weight (%)	Grade			Recovery (%)		
			Au (g/t)	Ag (g/t)	S _T (%)	Au	Ag	S _T
SOS	Concentrate	6.3	220	305	34.3	86.5	76.1	94.7
	Feed		16.1	25.3	2.29			
NOS	Concentrate	16.3	119	179	38.8	93.6	95.1	98.2
	Feed		20.6	30.6	6.42			
MOS1	Concentrate	4.4	185	246	24.7	94.5	89.9	97.3
	Feed		8.6	12.0	1.11			
MOS2	Concentrate	14.0	106	106	33.9	93.7	93.2	96.4
	Feed		15.8	15.9	4.90			

An additional series of flotation variability tests were carried out on samples from different zones of the Kokarpinar vein. These test results are summarized in Table 13-8 and were carried out as bulk kinetic tests to assess overall recoveries and elemental deportment. The same overall reagent scheme was used as with previous work and plant practice. Grind size targeted for base case tests was a P₈₀ of 54 μm .

Tests from Kokarpinar zones 61 and 52 showed modest improvements when a finer grind (38 μm) was used. The use of MX505 again primarily diluted the recovered minerals and did not show a clear benefit.

Table 13-8: Summary of Kinetic Variability Test Results, Kokarpınar Vein

Sample	Conditions		Weight (%)	Grade			Recovery (%)		
				Au (g/t)	Ag (g/t)	S _T (%)	Au	Ag	S _T
Kokarpınar Middle									
Kokarpınar Zone 61	Base	Concentrate	35.6	34.9	74.5	30.7	95.3	95.6	98.5
		Feed		15.2	29.0	10.85			
	Fine Grind (38 µm)	Concentrate	32.7	40.4	84.6	31.5	96.9	97.6	98.5
		Feed		15.2	29.0	10.85			
	Effect of MX505	Concentrate	35.5	36.8	79.0	28.7	95.8	97.8	98.4
		Feed		15.2	29.0	10.85			
Kokarpınar Zone 63	Base	Concentrate	38.2	21.1	290	28.2	94.2	94.8	98.0
		Feed		8.3	107.3	10.98			
	Fine Grind (38 µm)	Concentrate	36.7	22.9	273	29.2	95.5	93.5	97.1
		Feed		8.8	107	11.0			
Kokarpınar Zone 84	Base	Concentrate	16.9	45.5	73.2	34.3	93.6	78.9	93.7
		Feed		7.7	17.0	6.05			
	Fine Grind (38 µm)	Concentrate	17.3	44.5	75.6	34.0	94.4	84.1	94.8
		Feed		7.7	17.0	6.05			
	Effect of MX505	Concentrate	23.4	34.0	64.0	27.8	94.2	83.0	96.0
		Feed		7.7	17.0	6.05			
Kokarpınar South									
Kokarpınar Zone 51A	Base	Concentrate	20.3	49.0	49.0	15.1	88.4	86.2	93.4
		Feed		8.8	12.0	1.98			
	Fine Grind (38 µm)	Concentrate	20.6	39.9	47.0	14.6	86.1	85.9	94.5
		Feed		8.8	12.0	1.98			
Kokarpınar Zone 51B	Base	Concentrate	13.4	46.4	39.7	13.1	88.2	67.2	91.4
		Feed		7.7	7.0	1.67			
	Fine Grind (38 µm)	Concentrate	14.2	44.6	38.2	12.3	88.9	67.8	91.4
		Feed		7.7	7.0	1.67			
Kokarpınar Zone 52	Base	Concentrate	17.9	35.9	37.1	11.6	88.8	80.2	87.2
		Feed		11.1	9.0	2.41			
	Fine Grind (38 µm)	Concentrate	20.5	34.3	37.9	10.1	91.8	90.8	87.6
		Feed		11.1	9.0	2.41			
	Effect of MX505	Concentrate	18.1	36.2	38.7	11.9	88.7	89.5	88.3
		Feed		11.1	9.0	2.41			
Kokarpınar Zone 52B	Base	Concentrate	13.2	52.7	68.4	17.8	89.5	83.9	91.6
		Feed		9.3	12.0	2.31			
Kokarpınar Footwall	Base	Concentrate	17.7	169.3	80.6	15.8	95.7	89.7	91.7
		Feed		41.4	23.0	2.97			

Similar kinetic variability flotation tests were carried on samples from the two principal zones of the Batı veins, summarized in Table 13-9. Sulfur, gold, and silver recoveries were high in all cases. For Batı zone 71, there was no advantage to grinding finer to 38 µm from the base case of 54 µm. The addition of MX505 had a mostly dilutive effect with higher mass pull, resulting in lower concentrate grades.

Table 13-9: Summary of Kinetic Variability Test Results, Batı Vein

Sample	Conditions		Weight (%)	Grade			Recovery (%)		
				Au (g/t)	Ag (g/t)	S _T (%)	Au	Ag	S _T
Batı Zone 71	Base	Concentrate	14.3	76.3	134.0	30.6	95.2	91.8	94.5
		Feed		14.6	22.0	4.34			
	Fine Grind (38 µm)	Concentrate	15.5	79.2	120.0	27.7	95.9	91.7	93.6
		Feed		14.6	22.0	4.34			
	Effect of MX505	Concentrate	18.1	62.8	100.3	23.3	96.5	91.7	95.7
		Feed		14.6	22.0	4.34			
Batı Zone 72	Base	Concentrate	19.2	36.3	151.3	29.7	97.0	94.7	95.0
		Feed		7.6	34.0	5.87			

Some of the future mining zones in the Kokarınar and Batı veins contain relatively high levels of lead and/or zinc. Future operation could include overall blending strategies to maximize payability and manage potential penalty metals. If higher overall value could be delivered, campaigning could be carried out to produce a low-volume high-lead concentrate. Examples of testwork carried out to mimic a polymetallic flowsheet follows in Table 13-10. A significant proportion of the gold and silver deported to the lead concentrate with a very low mass pull.

Table 13-10: Variability Tests, Polymetallic Flowsheet

Sample		Wt. (%)	Grade					Recovery (%)				
			Au (g/t)	Ag (g/t)	S _T (%)	Pb (%)	Zn (%)	Au	Ag	S _T	Pb	Zn
Batı Zone 71	Pb Conc	2.5	311	480	24.0	24.2	8.0	74.4	58.2	13.3	70.4	12.1
	Zn Conc	4.0	12.9	82.6	22.5	2.4	31.5	5.0	16.3	20.2	11.4	77.6
	Py Conc	7.3	18.3	23.8	40.1	0.7	0.9	11.4	6.9	52.4	5.9	3.4
	Feed		14.6	22.0	4.3	0.9	1.5					

13.5 GRAVITY CONCENTRATION

A series of gravity concentration tests were performed by HMT in 2018 using pulp samples taken from SAG Mill discharge and ball mill discharge during a plant survey in February 2018. The pulp samples were screened through a 500-µm aperture screen, and the undersize material was classified further in a hydrocyclone to remove the -38 µm size fraction as slime material. The cyclone underflow was again classified in a teetered bed separator (TBS) into two size / density streams. Both streams (underflow and overflow streams) were concentrated separately by using a shaking table to produce coarse and fine gravity concentrates.

The results show that a gravity concentrate (combined coarse and fine concentrates) from SAG Mill discharge contained 67 g/t Au with 33% recovery, and from Ball Mill discharge contained 107 g/t Au with 65% (stage) recovery. These gravity concentrates are not suitable for direct smelting, but very

compatible with the bulk sulfide flotation concentrate. This is mainly due to fine grain size of gold particles associated with sulfide minerals, such as pyrite.

13.6 PERFORMANCE ANALYSIS OF THE FLOTATION CIRCUIT

A pilot scale column flotation unit was installed in the flotation plant in 2018 for upgrading the final concentrate by removal gangue mineral particles. The grade of the concentrate was improved significantly, with approximately 30% mass rejection, and gold recovery was not negatively affected. Given the positive results of the pilot scale tests, the operation decided to install two column flotation cells in the flotation circuit. A comprehensive plant survey was performed in August 2021 to determine the plant performance with the column cells.

Cell-by-cell profile sampling and hydrodynamic measurements (gas hold-up, superficial air velocity, and froth depth) were conducted in the flotation circuit. The measurements show that the flotation cells in the rougher and cleaner sections are generally in an expected operating range.

Mass balance of the flotation circuit was performed on a size-by-size assay basis. The process plant was operated at 65 tph and a feed grade of 3.2 g/t Au and 2.15% S. The feed grade was lower than the long-term average values and was specifically organized for the sampling survey to determine the performance of the plant under difficult feed conditions.

Mass balance calculations show that the flotation circuit produces a concentrate assaying 40 g/t Au, and 27% S at recoveries of 95.8% and 97.23%, respectively. Modelling and simulation studies were performed using JKSimFloat v6.1 to estimate the plant performance under several operating conditions. The simulation studies showed that the gold grade of the concentrate could be increased to 55 g/t without negatively affecting the gold recovery with modified column flotation operating conditions. The simulation tool could be used effectively to estimate plant performance under various operational conditions and feed grade.

The grade of the flash flotation concentrate was 67 g/t Au and 38% S at the time of sampling survey. With such a high grade, this stream could be sent directly to the concentrate thickener. However, an online grade control is required to monitor the grade of the Flash concentrate, and some other key streams in the plant, to send this stream to the final concentrate. An online monitoring system was tested in the flotation plant for this purpose and installed on some streams (details are provided in Section 17).

Batch scale rougher kinetic flotation tests were conducted on Cleaner Tails and Column Tails to determine the effects of collector addition and regrinding to fine particle size (approx. $d_{80}=38 \mu\text{m}$). The results showed that regrinding of the cleaner tails increased the gold recovery by more than 40%. This could be due to the increased degree of liberation of gold and pyrite in the cleaner tail.

13.6.1 Pilot Scale Column Flotation Tests

A pilot scale column flotation unit was installed in the flotation plant in 2018 for upgrading the final concentrate by removal of entrained gangue mineral particles. The pilot unit has dimensions of 508 mm diameter \times 4,000 mm length and two sparger systems, SparJet and a cavitation tube. The pilot tests were performed using the final concentrate and rougher cell 1-2 concentrate. Effects of various operational parameters (froth depth, froth wash water rate, air flow rate, sparger system, feed flow

rate [i.e., residence time], and frother addition) were investigated to determine the optimum operating conditions.

The results show that upgrading the final concentrate by using the column flotation cell as the third cleaner flotation stage is the most beneficial option. The optimum operating conditions for the column cell were determined as: froth depth at 30 cm; wash water of 12 L/min; air flow rate of 8 m³/h; cavitation tube sparger system at 70% pump speed; and residence time of 30 minutes. Continuous column flotation tests were conducted for 33 days (on day shift, two sampling campaigns per shift) applying the optimum operating parameters to validate the findings from optimization studies.

Mass balance of each sampling campaign was conducted by using JKSimFloat software to determine flowrates and metal recoveries. The feed grade to the column cells (i.e., the final concentrate of the flotation circuit) ranges from 35 g/t to 120 g/t Au, and from 13% to 35% S. Recoveries of both gold and sulfur are over 95% independent of feed grade. Sulfur grade of the column concentrate is generally over 35% S, independent of the feed grade. Gold grade of the concentrate, however, depends on feed grade and increases linearly with gold grade of the feed to the column flotation cell. Gold grade of the column concentrate ranges from 60 g/t to 150 g/t, depending on feed grade. Table 13-11 shows average mass pull, grade, and recoveries obtained from the continuous column tests. The concentrate can be produced assaying approximately 98 g/t Au and 37% S, with 98% recovery for both elements, and approximately 30% of the mass is rejected.

Table 13-11: Average Mass Pull, Grade and Recoveries of the Continuous Column Flotation Tests

	Mass Pull (%)	Grade					Recovery				
		Au g/t	Ag g/t	S %	Pb%	Zn%	Au %	Ag %	S %	Pb %	Zn %
Concentrate	68.6	97.6	212	37.0	7.94	8.48	98.0	97.5	98.2	97.5	97.6
Feed	100	66.4	148	25.5	5.54	5.93	100	100	100	100	100

The results of the column test work have closely matched the plant performance achieved following the installation of the column cell into the plant flowsheet.

13.7 RECOMMENDATIONS FOR FUTURE TESTWORK

13.7.1 Variability Tests

Ore variability testing should continue as new areas are being developed. The test program should involve:

- Complete chemical analysis and mineralogical analysis including gold deportment.
- Comminution tests (SMC, Bond ball mill work index, and Abrasion Index).
- Flotation tests.

With minor variations, this variability work has continued to indicate that the designed process is suitable for the treatment of these ores. As development of and access to the Kokarpinar and Bati veins continues, higher base metal grades may warrant increased attention to blending or a plant adjustment at some point in the future.

Concentrates with high gold grade can be produced in the Efemçukuru flotation plant due to the high Au / S ratio of the ore. The gold grade may decrease with Au / S ratio ore zones despite high sulfur grades in the concentrate. Detailed ore characterization and flotation tests should be conducted to improve the gold grade of the concentrates to be produced from such ore types.

The results of the testwork described in this report are being relied on for metallurgical performance and recovery estimations. The samples that have been tested from Kokarpinar and Bati zones display similar characteristics to the zones currently being processed (SOS, MOS, and NOS) and would be expected to provide similar results when processed in the Efemçukuru mill. Samples used for metallurgical testing are representative of their respective ore zones as described in the report.

Deleterious elements that have been identified during testwork and from operational performance include moderate levels of arsenic and halides (chlorine and fluorine). The introduction of column flotation has benefitted in terms of rejecting gangue from the final concentrate and thereby reducing the concentrations of halides. Arsenic levels are manageable within the expected ranges required to meet sales contract specifications. Base metals (lead and zinc) can be deleterious or provide some addition value depending on the specific sales contract and method of downstream processing.

SECTION • 14 MINERAL RESOURCE ESTIMATES

14.1 INTRODUCTION

The mineral resource estimates for Efemçukuru are based on 3D block models formed on the Kestanebeleni, Kokarpınar, and Batı epithermal vein systems. Creation of these models utilized Geovia GEMS, a commercial mine planning software package. Currently, mining only occurs within the Kestanebeleni vein system. The project limits and block model properties are presented in Table 14-1.

Table 14-1: Project Limits and Block Model Properties

Number of Blocks (#)	
Columns	820
Rows	372
Levels	144
Origin	
X	496,636
Y	4,237,916
Z	765
Block Size (m)	
Column Size	4
Row Size	4
Level Size	5

14.2 MINERALIZATION MODELS

Gold mineralization at Efemçukuru primarily occurs in the Kestanebeleni, Kokarpınar, and Batı veins. Within these veins, the gold distribution can be irregularly distributed, either located along the footwall or hanging wall vein margins, within the central portions or combinations of all three. This distribution can only be confirmed through assays. By necessity, domains to control grade interpolation are grade-based.

Modeling domains used a 2.0 g/t Au grade threshold and general vein geometry for their construction. The domains also honored a minimum 2.0 m rule for mineralization thickness. Generated shapes were checked in plan and section to ensure conformance to assay data and the vein models. The domains were further divided into shoots according to structural and spatial considerations (Figure 14-1). A stockwork mineralization zone occurs in the MOS and comprises a separate modeling domain. The Kokarpınar vein system consists simply of a South domain (KPS) and Middle domain (KPM). These domain solids coded the drill hole data and block model cells ahead of grade interpolation.

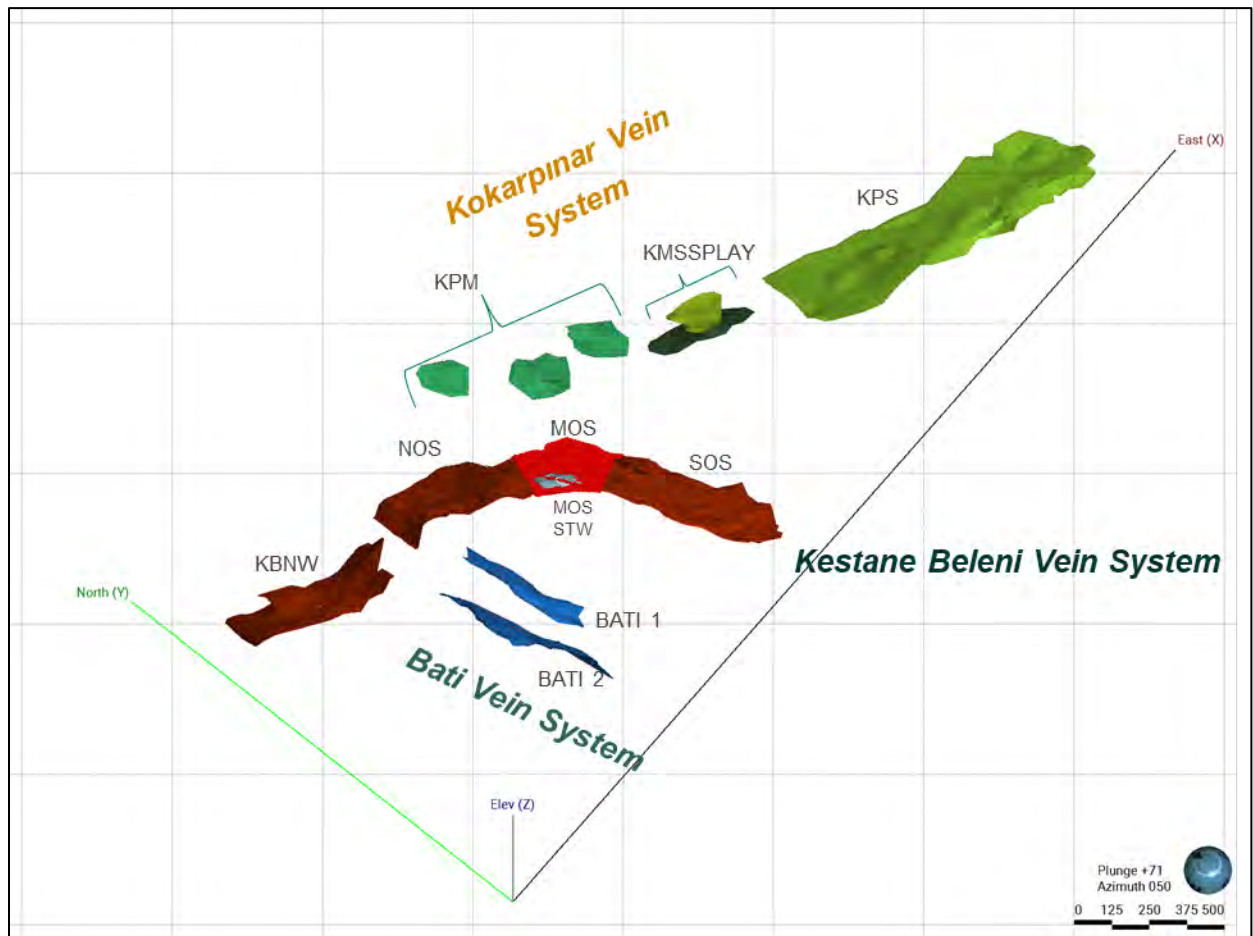

Figure 14-1: Kestanebeleni, Kokarpınar and Batı System Modeling Domains (Eldorado, 2023)

14.2.1 Historical Mine Openings or Voids

Evidence of historical mining, by the presence of numerous small underground openings and small surface rock piles, occurs predominantly in the upper parts of the SOS (Figure 14-2). First identified by the diamond drill campaigns, these openings, or voids, became exposed by mining. This allowed better location definition through surveying tools such as cavity-monitoring systems. The block model captured the void volumes, totalling 36,074 m³, to ensure proper accounting in tonnage estimates and for operational safety purposes.

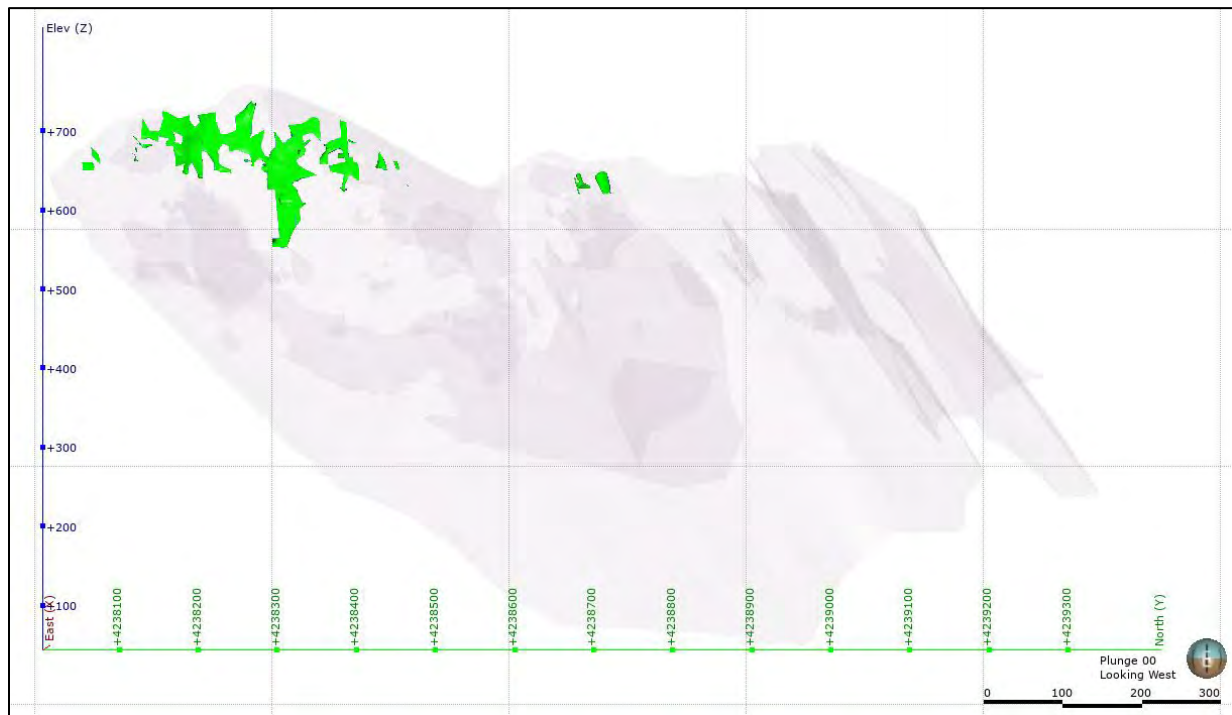

Figure 14-2: Modeled voids in the Kestanebeleni Vein System (Eldorado, 2019)

14.3 DATA ANALYSIS

The Efemçukuru resource database comprises 5,882 drill holes totaling 768,579 meters as of March 31, 2023. Most of the sample lengths are between 0.5 and 1.5 meters (average 0.92 m), thereby supporting the justification of using a down hole composite length of 1 m. Composited data were interrogated, by domain, using descriptive statistics, histograms, box plots, and cumulative distribution function (CDF) plots. Summaries of the statistical properties for uncapped data are shown in Table 14-2.

Table 14-2: Efemçukuru Statistics for 1.0 m Uncapped Composite Au Data (g/t)

	SOS	MOS	MOSSTW	NOS	KBNW	KPS	KPM	KPM SPLAY	BATI 1	BATI 2
# Samples	17,624	8,481	6,484	6,249	1,344	845	378	147	355	297
Min	0.003	0.007	0.010	0.009	0.002	0.010	0.010	0.008	0.010	0.010
Max	3,768	309	203	1,355	178	1,499	705	68	260	186
Mean	8.57	10.95	0.54	9.64	8.47	10.67	9.60	7.07	7.29	7.21
SD	48.61	16.05	4.52	24.43	19.93	66.65	39.25	10.38	20.11	17.48
Variance	2,363	258	20	597	397	4,443	1,540	108	404	306
CV	5.67	1.47	3.15	2.53	2.35	6.25	4.09	1.47	2.76	2.42
Q25	2.03	2.70	0.24	2.72	0.30	0.66	2.07	1.90	1.46	1.46
Median	3.94	5.80	1.43	5.10	2.29	1.90	3.80	4.01	3.10	3.00
Q75	8.57	13.21	1.38	10.36	6.84	4.22	7.48	7.71	6.35	5.94
Kurtosis	4,520.2	60.2	855.1	1,523.3	27.7	322.2	263.9	17.2	96.7	62.3
Skewness	63.4	5.6	23.9	30.6	4.8	16.3	15.2	3.9	9.0	7.1

14.3.1 Evaluation of Extreme Grades

Extreme gold grades were examined, mainly by histogram and CDF plots. The examination showed a risk does exist with respect to extreme gold grades at Efemçukuru. Assay gold grades were capped prior to compositing, and the capped values and composite data statistics are shown in Table 14-3.

Table 14-3: Efemçukuru Statistics for 1.0 m Capped Composite Au Data (g/t)

	SOS	MOS	MOSSTW	NOS	KBNW	KPS	KPM	KPM SPLAY	BATI 1	BATI 2
# Samples	17,624	8,481	6,484	6,249	1,344	845	378	147	355	297
Min	0.003	0.007	0.010	0.009	0.002	0.010	0.010	0.008	0.010	0.010
Max	100	200	40	100	70	40	40	40	40	40
Mean	7.64	10.91	0.54	9.03	7.42	4.80	6.63	6.57	5.74	5.83
SD	11.59	15.48	2.86	12.81	14.10	8.57	8.45	7.99	7.88	8.48
Variance	134	240	8	164	199	73	71	64	62	72
CV	1.52	1.42	2.10	1.42	1.90	1.78	1.28	1.22	1.37	1.46
Q25	2.03	2.70	0.24	2.72	0.30	0.66	2.07	1.90	1.46	1.46
Median	3.94	5.80	1.36	5.10	2.29	1.90	3.80	4.01	3.10	3.00
Q75	8.57	13.21	1.38	10.36	6.84	4.22	7.48	7.71	6.35	5.94
Kurtosis	25.6	33.8	87.2	22.7	9.8	8.9	7.3	8.8	9.0	7.7
Skewness	4.4	4.5	7.9	4.2	3.1	3.0	2.7	2.9	2.9	2.8
Capped Au g/t	100	200	40	100	70	40	40	40	40	40
# Capped Samples	72	5	13	44	34	30	11	5	10	9

The coefficient of variation (CV), defined as the ratio of the standard deviation to the mean, is a useful metric for comparing the effect of capped grades on the distributions. Average CV values for capped and uncapped composite data in the main modeling domains are plotted in Figure 14-3. The assay cap grade strategy succeeds in moderating the effects of extreme grades in each of the modeling domains, especially in the Kokarpinar vein system.

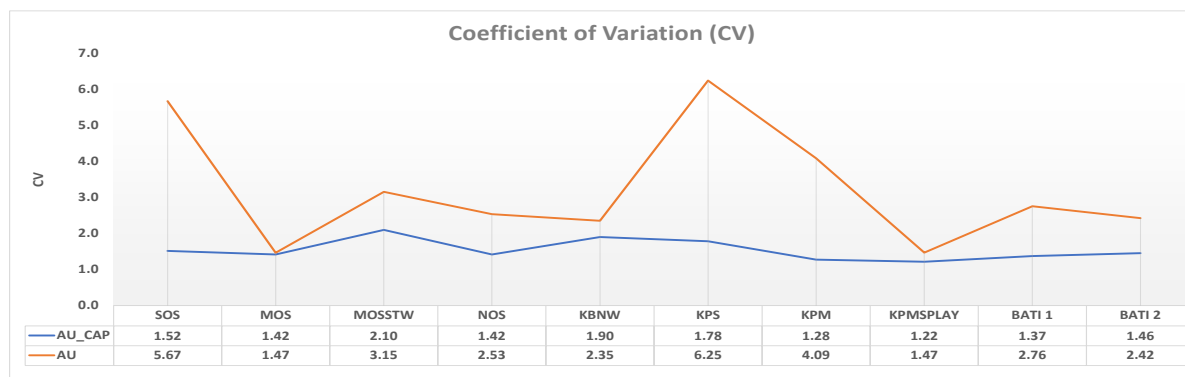
**Figure 14-3: Average Coefficient of Variation for Capped and Uncapped Data a by Domain**

14.3.2 Histograms and Cumulative Distribution Function (CDF) Plots

Cumulative frequency diagrams, also called cumulative distribution function (CDF) diagrams, demonstrate the relationship between the cumulative frequency (expressed as a percentile or probability) and grade on a logarithmic scale. These are useful for characterizing grade distributions and identifying multiple populations within a data set.

The analyses show asymmetrical positive skewed trends, typical patterns for epithermal precious metal systems. Additionally, multi-modal populations are present, another common observation for these mineralization types where veining clearly show episodic pulses of emplacement. CDF plots for the main zones are shown in Figure 14-4 and Figure 14-5 as cumulative probability graphs.

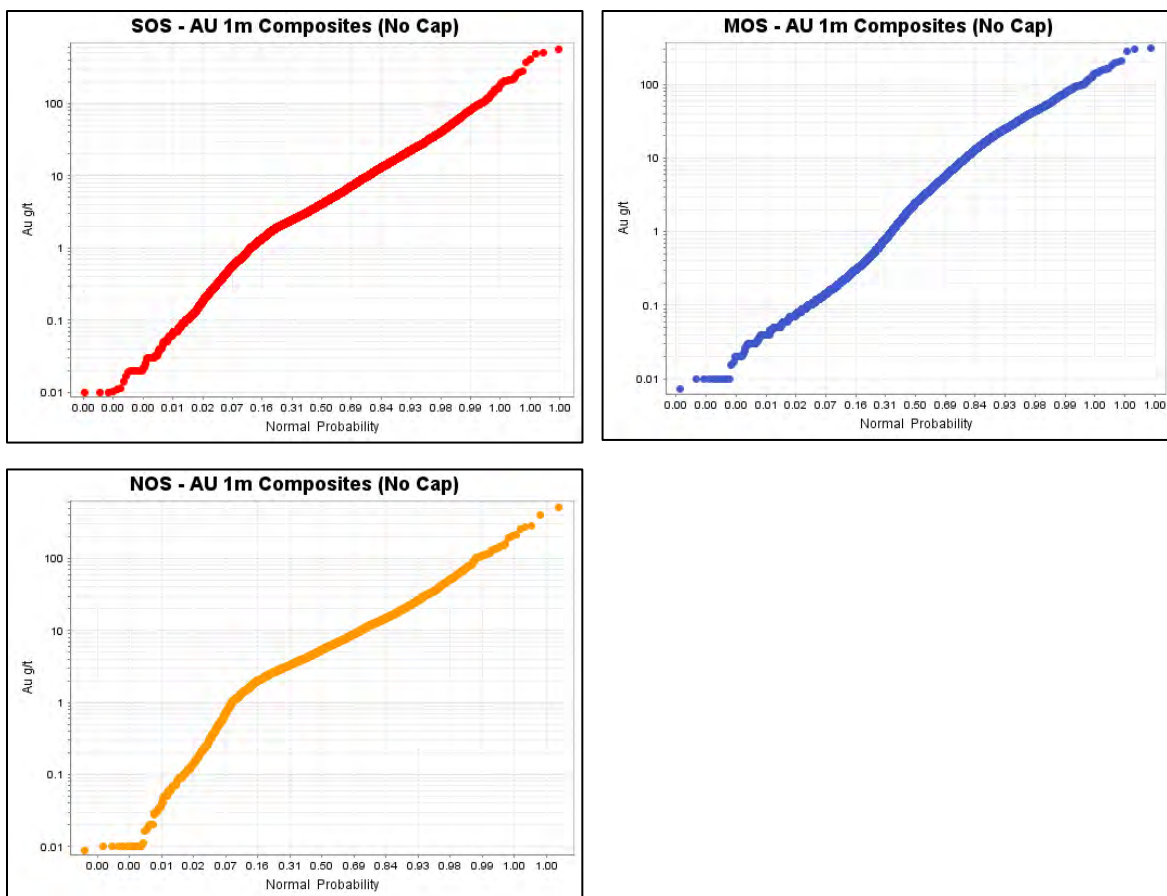

Figure 14-4: Cumulative Probability Plots, Kestanebeleni Vein System

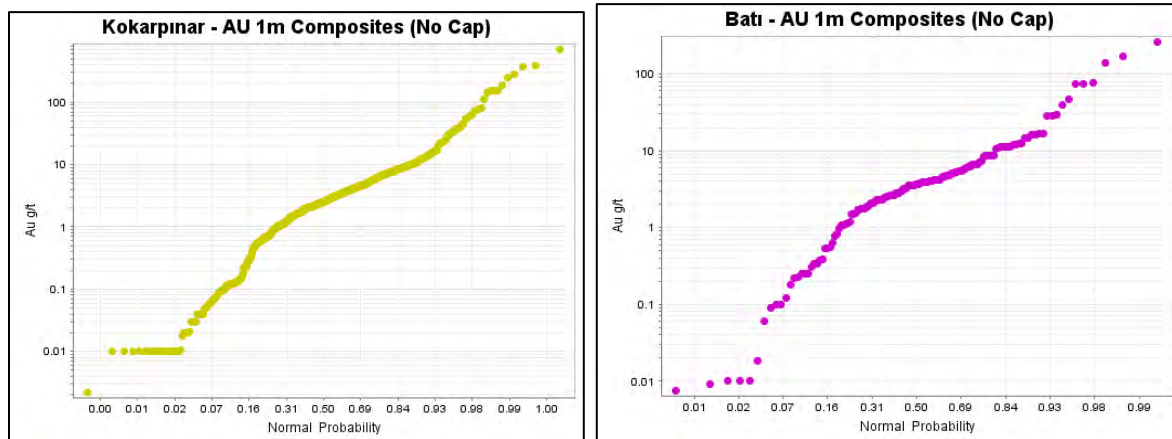

Figure 14-5: Cumulative Probability Plots, Kokarpınar and Batı Systems

14.3.3 Estimation Domains

The data analysis and geologic interpretation of the gold mineralization at Efemçukuru supports the use of a grade-based shell to define the mineralized portions of the vein systems. Grade shells were constructed in the veins using a threshold grade of about 2 g/t Au. There are several small splay veins at the hanging wall of the main vein. The spatial relationships between the main vein and small splay veins do not necessitate the use of separate domains for grade interpolation. The MOS stockwork zone, with its marked grade contrast and mineralization style, was treated as a separate estimation domain. Grades in these domains are estimated with a hard boundary logic, where only composites within a domain were used to interpolate grade into blocks defined by that domain.

14.4 VARIOGRAPHY

Variography is the study of the spatial variability of an attribute. Correlograms, rather than the traditional variograms, were used on the Efemçukuru data because of their lower sensitivity to outliers and their normalization to the variance of the data for a given lag.

Correlograms were calculated for gold in the SOS, MOS, and NOS. Correlogram model parameters and orientation data of rotated correlogram axes are shown in Table 14-4.

Table 14-4: Correlogram Parameters for the main Kestanebeleni domains

	SOS	MOS	NOS
Nugget (Co)	0.12	0.18	0.204
First Structure (C1) Model	SPH	SPH	SPH
Proportion of C1	0.707	0.561	0.534
Range of anisotropy X	2.5	4.7	3.9
Range of anisotropy Y	2.1	2.2	1.7
Range of anisotropy Z	5.7	3.1	6.5
Rotation Z	19	-2	-51
Rotation X	-34	-17	34
Rotation Z	29	-40	36
Second Structure (C2) Model	SPH	SPH	SPH
Proportion of C2	0.172	0.259	0.262
Range of anisotropy X	8.2	38.6	35.3
Range of anisotropy Y	48.8	22.6	7.2
Range of anisotropy Z	74.9	61.2	77.6
Rotation Z	-8	67	-51
Rotation X	54	-24	34
Rotation Z	32	-95	36

Notes: Models are Spherical. The Anisotropy Rotation is ZXZ RRR hand rule. Positive rotation around the X axis is from Y towards Z, around Y axis is from Z towards X, and around the Z axis is from X toward Y.

Overall observations from the generated correlograms are:

- For the Kestanebeleni domains that experienced more closely spaced infill drilling campaigns (conversion of Indicated to Measured Resources), the models show distinct small- ranged first structures and a smaller nugget.
- Gold in the SOS domain displays dominantly NW to SE trending, moderate NE-dipping and SE-plunging structures. The SOS gold nugget effect is 12% of the total variation.
- MOS domain distribution displays a NW to SE-trending, moderately steep NE-plunging structure. The nugget effect for the MOS distribution is somewhat higher at 18% of the total variation.
- The gold distribution in NOS displays a WNW to ESE-trending, moderately steep NE-plunging structure. The nugget effect for NOS distribution, the highest of the three main domains, comprises 20.4% of the total variation.

14.5 MODEL SET-UP

The model was set-up using Geovia GEMS software. The block size for the Efemçukuru model was selected based on mining selectivity considerations (underground mining). The block size mirrors the minimum mining unit for Drift and Fill mining method: 4.0 m east x 4.0 m west x 5.0 m high.

The capping limits were applied to the assay data prior to compositing. The assays were composited into one-metre fixed length down-hole composites, and compositing honoured the estimation domain by breaking the composites on the domain code values. The compositing process was reviewed and determined to have performed as expected.

Various coding was done on the block model in preparation for grade interpolation. The block model was coded according to domains and sub-domains for usage of different search ellipsoids. Once mining in an area is deemed to be complete, construction of 3D depletion shapes allows proper remaining ore percentage to be calculated ahead of remaining tonnage tabulation.

14.6 ESTIMATION

Efemçukuru estimation plans, or sets of parameters used for estimating blocks, were designed using a philosophy of restricting the number of samples for local estimation. This was determined to be an effective method of reducing smoothing and producing estimates that match the Discrete Gaussian change-of-support model and ultimately the actual recovered grade-tonnage distributions. While local predictions based on the small number of samples were uncertain, this method produced reliable estimates of the recovered tonnage and grade over the entire deposit. The global grade-tonnage curves from the estimations are accurate predictors of the actual grade-tonnage curves.

Modelling consisted of grade interpolation by ordinary kriging (OK) for SOS, MOS and NOS domains, and inverse distance weighting (IDW) to the second power in the remainder of the zones due to their insufficient data to create correlograms. Nearest-neighbour (NN) grades were also interpolated for validation purposes. No grades were interpolated outside the modeling domains.

The search ellipsoids were oriented preferentially to the orientation of the vein in the respective domains. A two-pass approach was instituted for interpolation. The first pass required a grade estimate to include composites from a minimum of two holes from the same estimation domain, whereas the second pass allowed a single hole to place a grade estimate in any uninterpolated block from the first pass. This approach was used to enable most blocks to receive a grade estimate within the domains. SOS, MOS and NOS model blocks received between two and five composites from a single drill hole (for the two-hole minimum pass). Maximum composite limit equaled 16. The remaining domains received a minimum of three and maximum of two composites from a single drill hole, whereas the total maximum composite limit ranged from six to eight. The minimum and maximum number of composites were adjusted to incorporate an appropriate amount of grade smoothing.

In all domains, an outlier restriction was used to control the effects of high-grade composites in local areas of less dense drilling, particularly in Kokarpinar and Batı vein systems. The restricted distance generally ranged from 30 to 40 m, meaning that composites exceeding the outlier values beyond this distance from a model block center were used in estimation. The threshold grades generally ranged from 25 to 40 g/t Au.

Bulk density values were estimated into the Kestanebeleni blocks by inverse distance weighting to the fourth power, using a minimum of two and a maximum of eight composites. Averaged measured density values, equalling 2.8, were simply assigned to Kokarpinar and Batı model blocks.

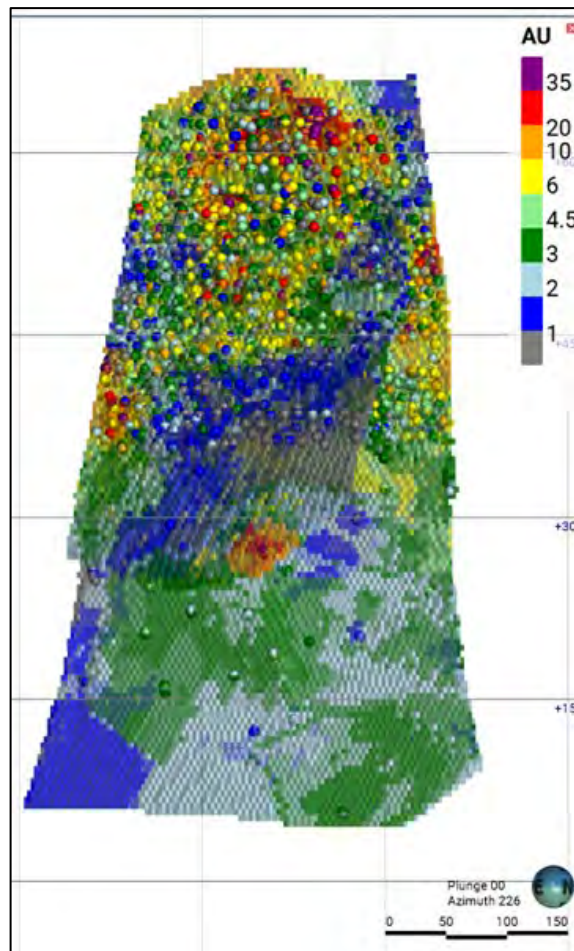

Figure 14-7: MOS Modeled Grades and Composited Drill Hole Samples (Au, g/t) (Eldorado, 2023)

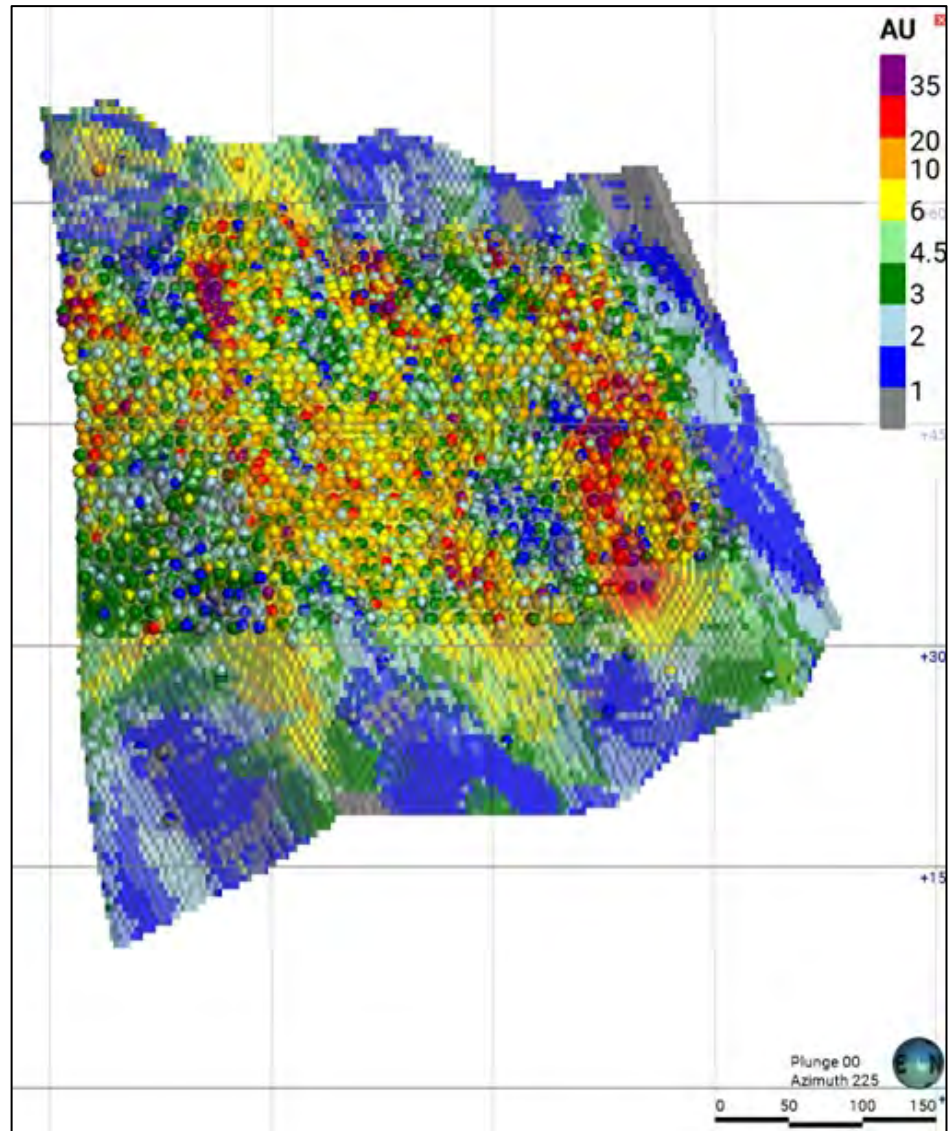

Figure 14-8: NOS Modeled Grades and Composited Drill Hole Samples (Au, g/t) (Eldorado, 2023)

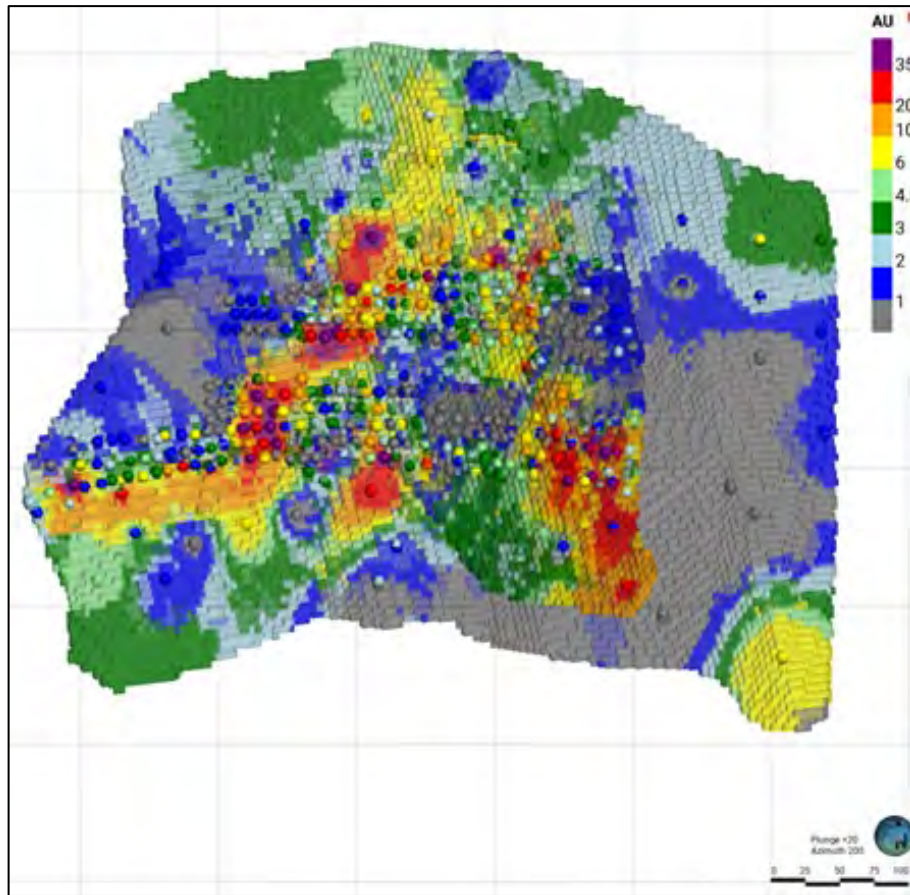

Figure 14-9: KBNW Modeled Grades and Composited Drill Hole Samples (Eldorado, 2023)

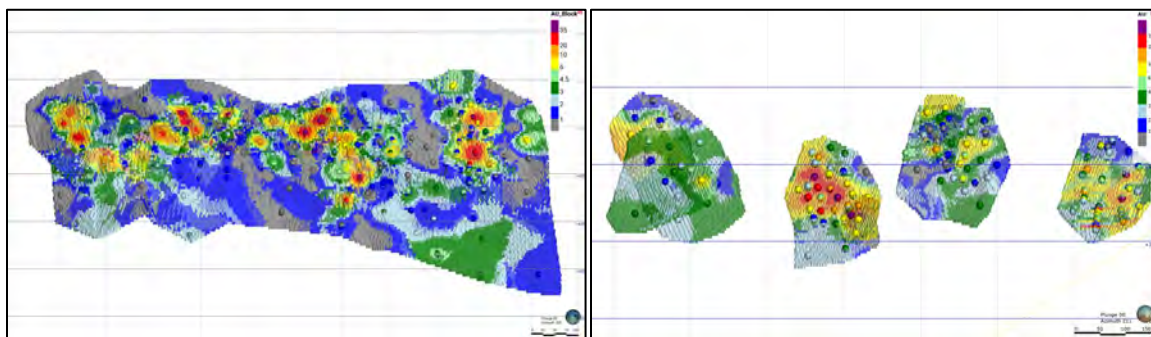

Figure 14-10: Modeled Kokarpınar Domains (KPS on left; KPM on right) and Composited Drill Hole Samples (Au, g/t) (Eldorado, 2023)

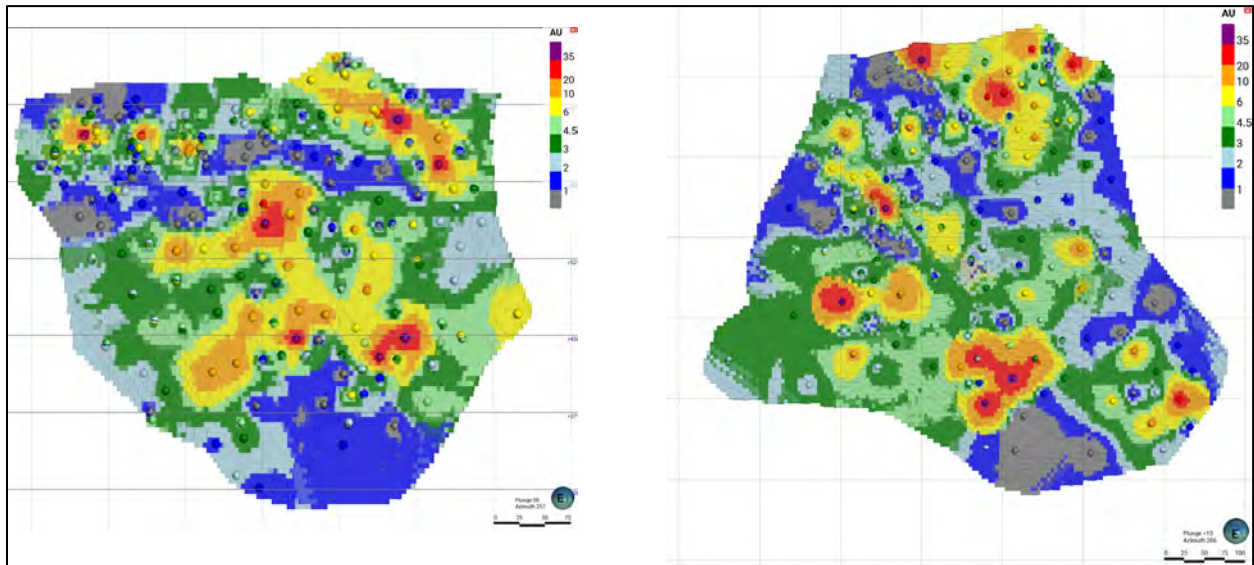

Figure 14-11: Batı Veins (#1 on Left, #2 on Right) Modeled Grades and Composited Drill Hole Samples (Au, g/t) (Eldorado, 2023)

14.6.1.2 Model Checks for Bias

Eldorado checked the block model estimates for global bias by comparing the average metal grades (with no cut-off) from the OK and ID models with means from nearest-neighbour estimates. The nearest-neighbour estimator declusters the data and produces a theoretically unbiased estimate of the average value when no cut-off grade is imposed. It is a good basis for checking the performance of different estimation methods. Results summarized in Table 14-5 show no global bias in the estimates.

Table 14-5: Gold Grades (g/t) by Domain

	Zone	OK or ID Estimate	NN Estimate	Difference
Kestanebeleni	SOS	5.84	5.77	-1.3%
	MOS	5.90	5.82	-1.4%
	NOS	6.00	5.81	-3.3%
	KBNW	4.74	4.78	0.8%
Kokarpınar	KPS	3.45	3.42	-1.1%
	KPM	5.82	5.95	2.2%
	KPMSP1	3.61	3.65	1.2%
	KPMSP4	4.17	3.99	-4.4%
Batı	BATI 1	4.93	4.85	-1.5%
	BATI 2	5.00	5.21	4.1%

Eldorado also checked for local trends in the grade estimates (grade slice or swath checks). This was done by plotting the mean values from the nearest-neighbour estimate versus the OK or ID modeled results for elevation benches, eastings, and northings in 10 m swaths. Examples for the SOS, MOS and NOS are shown in Figure 14-12 to Figure 14-14. The model estimate should be smoother than the nearest-neighbour estimate, thus the nearest-neighbour estimate should fluctuate around the model estimate on the plots. The observed trends behave as predicted and show no significant trends in the estimates in models.

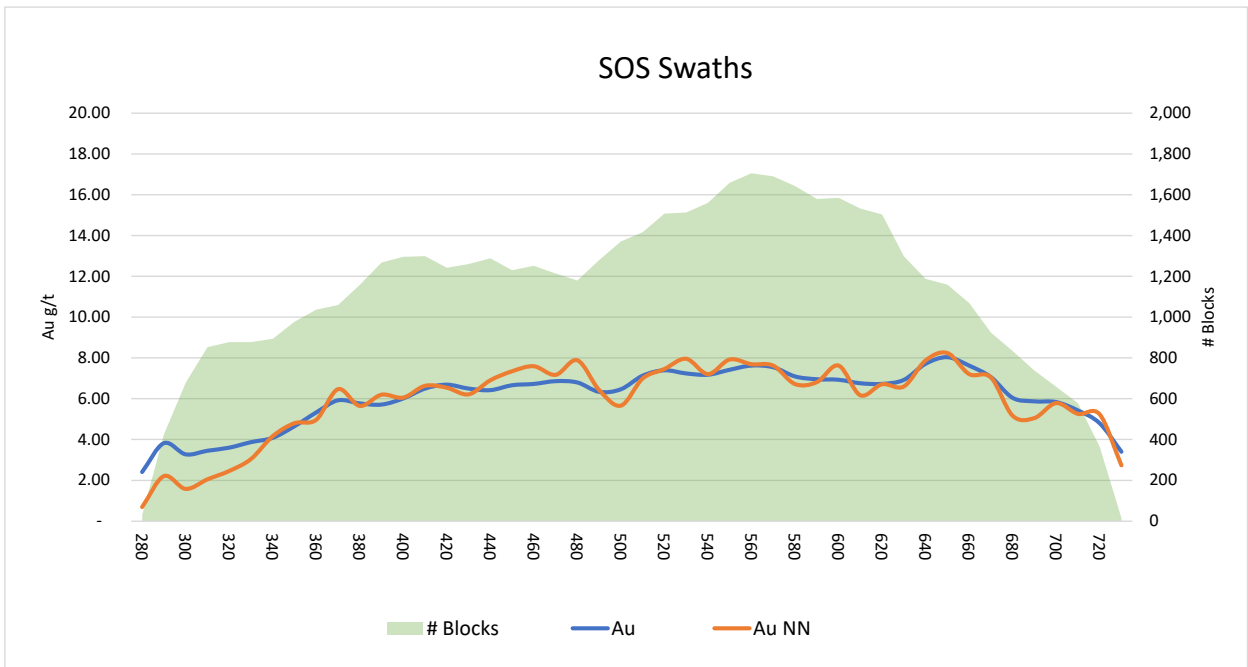

Figure 14-12: Model Trend Plot showing 10 m Binned Averages along Elevations for OK and NN Gold Grade Estimates, SOS Domain

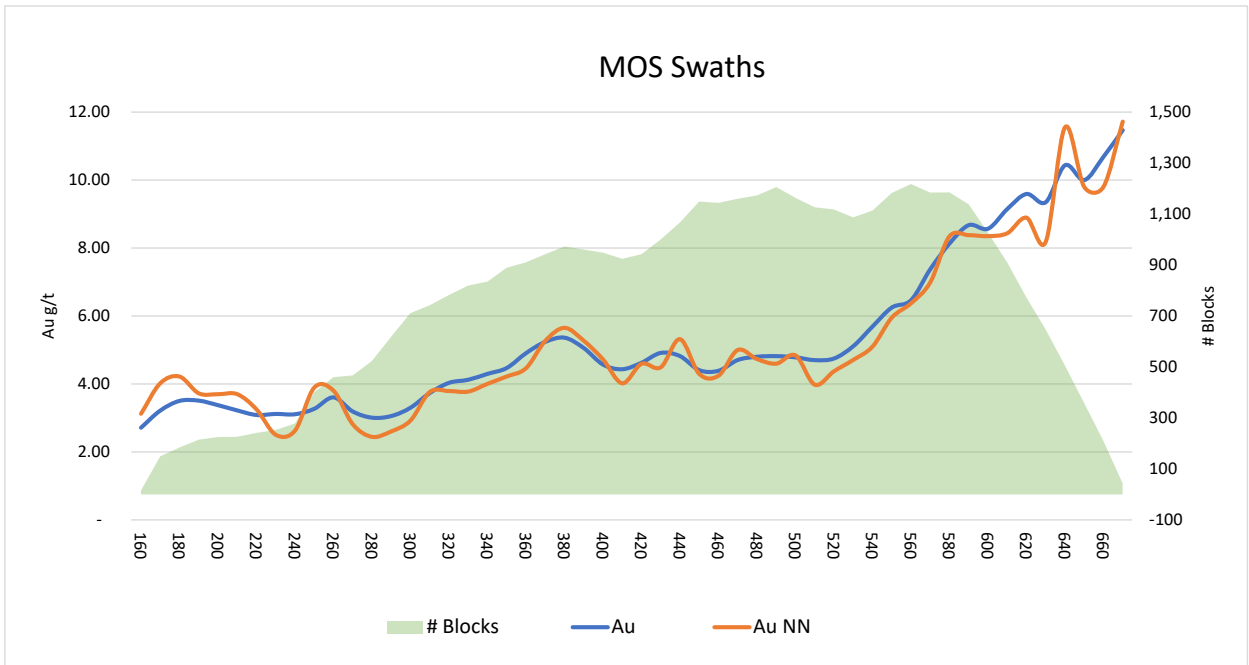

Figure 14-13: Model Trend Plot showing 10 m Binned Averages along Elevations for OK and NN Gold Grade Estimates, MOS Domain

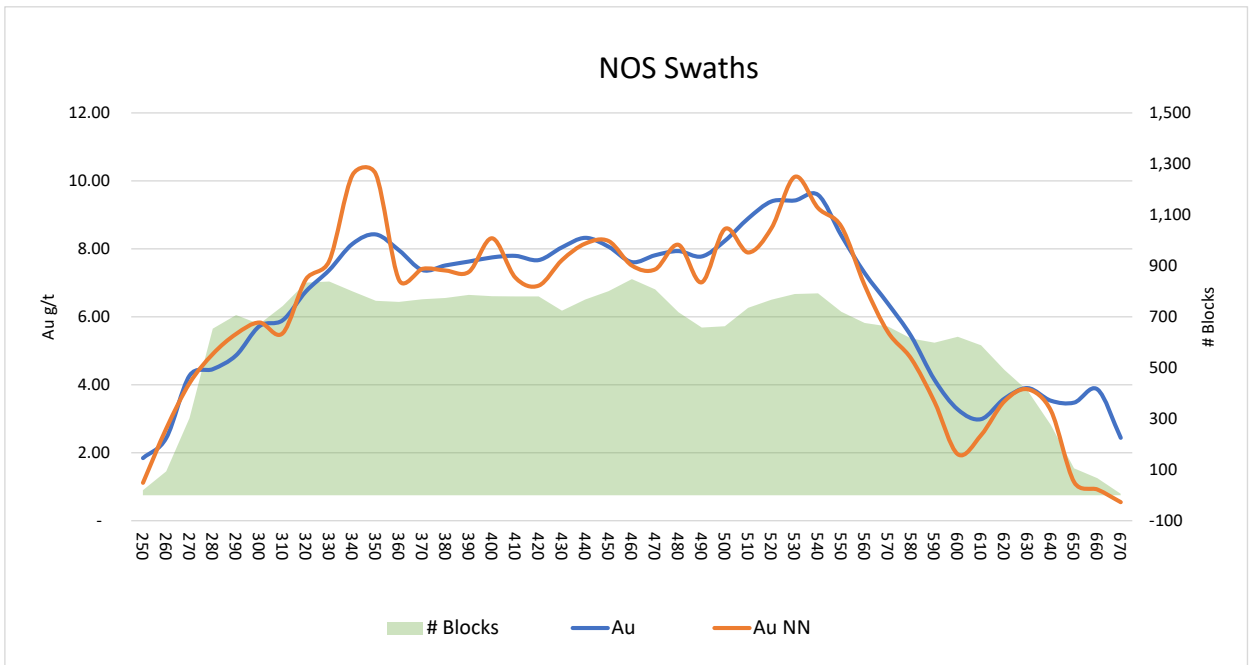

Figure 14-14: Model Trend Plot showing 10 m Binned Averages along Elevations for OK and NN Gold Grade Estimates, NOS Domain

14.6.1.3 Model Check for Change-of-Support

An independent check on the smoothing in the estimates was made using the Discrete Gaussian or Hermitian polynomial change-of-support method. This method uses the declustered distribution of composite grades from a NN or polygonal model to predict the distribution of grades in blocks. The histogram for the blocks is derived from two calculations:

- Block-to-Block Comparison
- Between-Block Variance

The frequency distribution for the composite grades transformed by means of Hermite polynomials (Herco) into a less skewed distribution with the same mean as the declustered grade distribution and with the block-to-block variance of the grades.

The distribution of hypothetical block grades derived by the Herco method is then compared to the estimated grade distribution to be validated by means of grade-tonnage curves.

The distribution of calculated 4 m × 4 m × 5 m block grades for gold in the SOS, MOS and NOS are shown in Figure 14-15 to Figure 14-17. These figures show the grade-tonnage distribution obtained from the block estimates. The grade-tonnage predictions produced for the model show that grade and tonnage estimates are validated by the change-of-support calculations over the likely range of mining grade cut-off values (around 3.0 g/t Au).

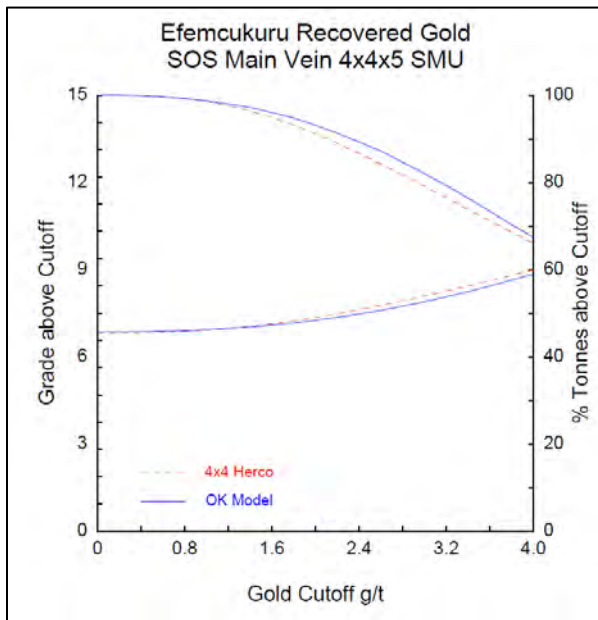

Figure 14-15: HERCO plot, SOS domain

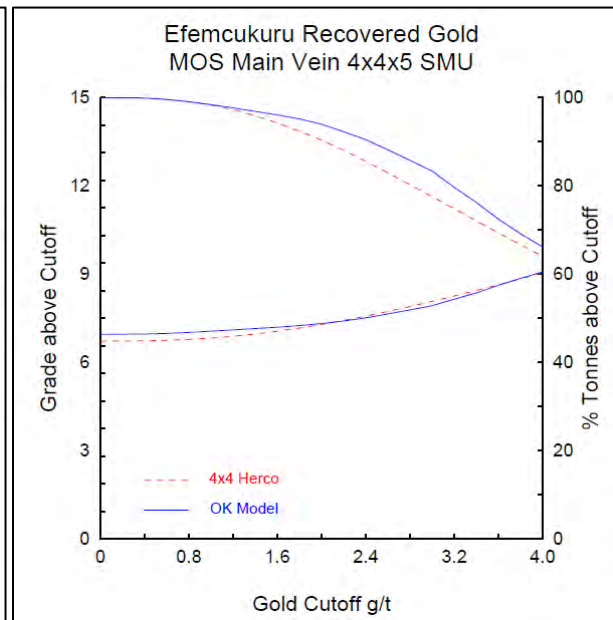

Figure 14-16: HERCO plot, MOS domain

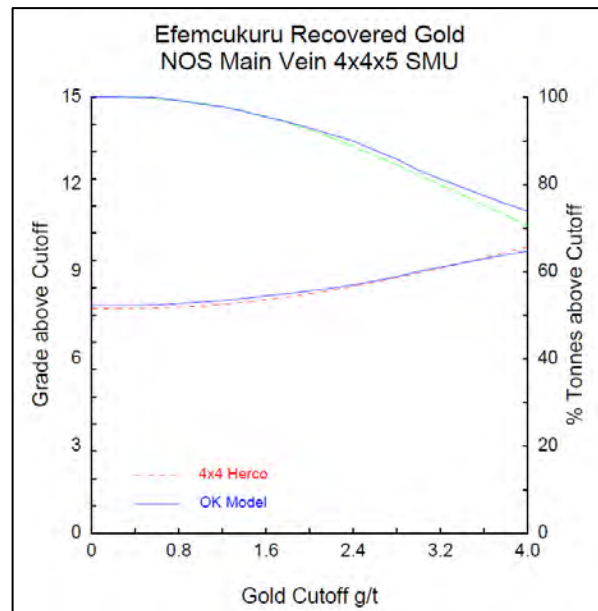

Figure 14-17: HERCO plot, NOS domain

14.7 MINERAL RESOURCE CLASSIFICATION AND SUMMARY

The Mineral Resources of the Efemçukuru Project were classified using the CIM Definition Standards for Mineral Resources and Mineral Reserves (May 10, 2014) that are incorporated by reference into NI 43-101. The mineralization of the project satisfies sufficient criteria to be classified into Measured, Indicated, and Inferred Mineral Resource categories.

Inspection of the model and drill hole data on plans and sections combined with spatial statistical work showed good geologic and grade continuity in areas near active mining. The model and data were tested by underground infill drilling that resulted in an approximate sample spacing of about 10 m. When taken together with all observed factors, blocks covered by this data spacing at SOS, MOS and NOS may be classified as Measured Mineral Resource. A three-hole rule was used to assist in selecting eligible model blocks, where blocks containing an estimate resulting from four or more samples from different holes were tagged. These blocks were examined in longitudinal section, where polygons were digitally drawn around contiguous areas of appropriately tagged blocks. These shapes were subsequently used to classify blocks as Measured Mineral Resources.

The Indicated Mineral Resource category is supported by the present drilling grid over most of the remaining part of the deposits. The drill spacing is at a nominal 45 m on and between sections. Geologic and grade continuity is demonstrated by the inspection of the model and drill hole data in plans and sections over various zones, combined with spatial statistical work. Considering these factors, blocks covered by this data spacing may be classified as Indicated Mineral Resource. A two-hole rule was used by limiting potential blocks to those interpolated by the first pass. As in the Measured Resources, eligible model blocks were looked at in longitudinal section and polygons digitally drawn around contiguous areas of appropriately tagged blocks. These polygons were used to classify blocks not already assigned as Measured Resources as Indicated Mineral Resources.

All remaining model blocks containing a gold grade estimate were assigned as Inferred Mineral Resources. The classified Mineral Resources are shown at the Figure 14-18.

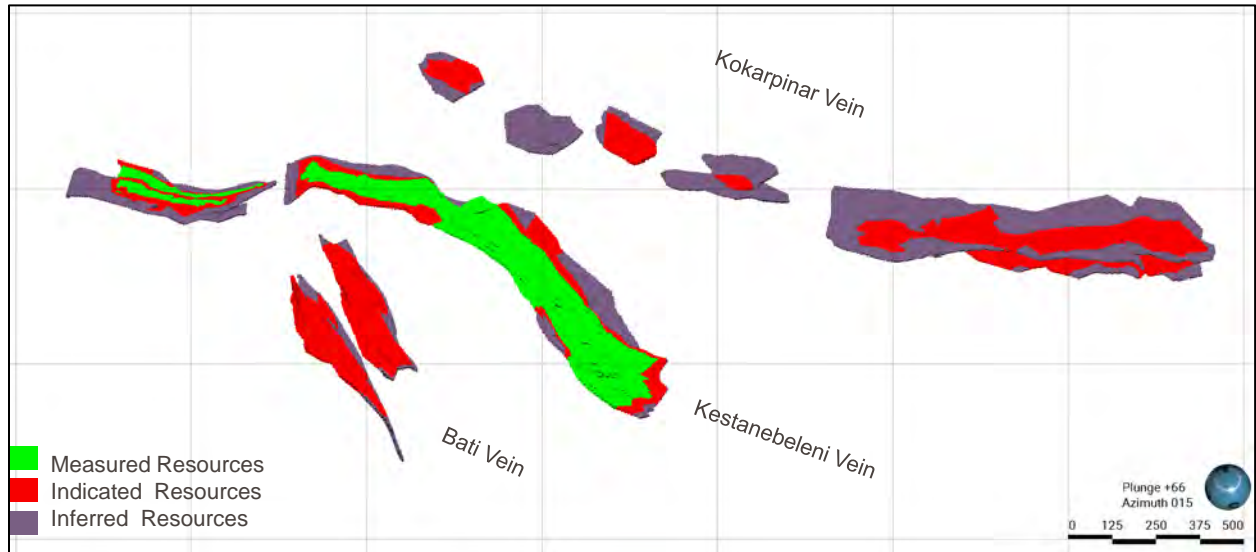

Figure 14-18: Mineral Resources Classification, Efemçukuru Mine (Eldorado, 2023)

Efemçukuru resources were constrained by 3D volumes whose design was guided by the reporting cut-off grade of 2.5 g/t Au, contiguous areas of mineralization and mineability. Only material internal to these volumes were eligible for reporting.

Efemçukuru mine Mineral Resources, as of September 30, 2023, are shown in Table 14-6.

Table 14-6: Efemçukuru Mine Mineral Resources, as of September 30, 2023

Deposit / Shoot	Mineral Resource Category	Resource	Au Grade	Contained Au	Ag Grade	Contained Ag
		(kt)	(g/t)	(koz)	(g/t)	(koz)
South Ore Shoot (SOS) Kestanebeleni	Measured	694	6.03	135	13	286
	Indicated	174	4.97	28	9	49
	Measured & Indicated	868	5.82	162	12	335
	Inferred	91	5.63	16	10	30
Middle Ore Shoot (MOS) Kestanebeleni	Measured	491	8.01	126	22	350
	Indicated	444	4.76	68	28	402
	Measured & Indicated	934	6.47	194	25	752
	Inferred	251	3.64	29	50	402
North Ore Shoot (NOS) Kestanebeleni	Measured	255	7.00	57	35	283
	Indicated	309	6.00	60	39	385
	Measured & Indicated	564	6.45	117	37	668
	Inferred	164	4.22	22	33	175
KBNW Kestanebeleni	Measured	146	9.85	46	20	96
	Indicated	277	7.35	65	20	178
	Measured & Indicated	422	8.21	111	20	274
	Inferred	194	4.60	29	23	146
Kokarpınar	Measured					
	Indicated	1,870	7.07	425	17	1,041
	Measured & Indicated	1,870	7.07	425	17	1,041
	Inferred	528	3.96	67	29	498
Bati	Measured					
	Indicated	918	6.41	189	22	639
	Measured & Indicated	918	6.41	189	22	639
	Inferred	94	3.85	12	31	95
Stockpile	Measured	3	6.23	1	20	2
Total Mineral Resources	Measured	1,588	7.15	365	20	1,017
	Indicated	3,991	6.51	835	21	2,694
	Measured & Indicated	5,580	6.69	1,200	21	3,711
	Inferred	1,323	4.13	176	32	1,346

There are no foreseen environmental, permitting, legal, title, taxation, socio-economic, marketing, political, or other relevant factors that could materially affect the Mineral Resource estimates.

SECTION • 15 MINERAL RESERVE ESTIMATES

The Efemçukuru operation commenced commercial production in 2011. As of December 2023, the mine has produced 5.8 Mt of ore, at an average grade of 7.1 g/t Au, using a combination of Drift and Fill (DAF) and Longhole Open Stopping (LHOS) methods.

As of September 30, 2023, Mineral Reserves are estimated to be 3.4 Mt at a grade of 5.1 g/t Au, containing 550 koz Au.

Mineral Reserve quantities are derived from the interrogation of development and stope design triangulations using Deswik mining software. The Deswik Stope Optimizer (DSO) software was used to optimize the mine design based on cut-off values and stope geometry parameters using the resource model described in Section 14. Mining losses and dilution are factored into the Mineral Reserve estimate.

Reserve designs were sequenced and scheduled into a LOM plan using Deswik's interactive scheduling software and exported to spreadsheets for financial analysis. Additional key assumptions and parameters are detailed in Section 16.

15.1 CUT-OFF VALUES

A range of cut-off values (COVs) have been calculated to identify break-even ore, incremental ore, and marginal ore.

COVs of \$127/t for DAF and \$124/t for LHOS were calculated based on the 2023 budget costs and a steady state life of mine (LOM) production profile. The 2023 budget costs are supported by 2022 actual production costs. The reference point of the COV is at the entrance point to the processing facility. As such, it refers to the diluted and extracted material reporting to the processing facility.

15.1.1 Stope Net Smelter Return Calculation

The basis for underground design optimization was the Net Smelter Return (NSR) revenue per tonne of ore, calculated for each block in the resource model. Metal prices assumed are \$1,400 per ounce of gold and \$19 per ounce of silver to ensure a consistently positive cashflow and an acceptable return on investment under the present and future metal price environments. Additionally, offsite costs for concentrate transportation, treatment and refining are used in the calculation. All cost assumptions are representative of Efemçukuru's actual costs and are in line with budget costs.

The NSR calculation, smelter terms, and offsite costs are summarized in Table 15-2. The table shows an estimate of NSR as an example data record within the resource model.

Table 15-1: Example of the Net Smelter Return Calculation Performed on the Block Model

Script Variable	Description	Unit	Value	Formula
Test Block NSR Calculation				
AU	Gold Grade	g/t	8.93	-
AG	Silver Grade	g/t	26.81	-
S	Sulphur Grade	%	6.31	-
AS	Arsenic Grade	%	0.88	-
CU	Copper Grade	%	0.14	-
PB	Lead Grade	%	1.40	-
ZN	Zinc Grade	%	0.54	-
Metallurgical Recovery				
Mill rec	Recovery	factor	0.935	-
Metal Pricing				
AU Price	Gold Price	US\$/oz	1,400.00	-
AG.Price	Silver Price	US\$/oz	19.00	-
Concentrate				
MassPull	Mass Pull	%	17.06	$(3.354*[CU]) + (1.342*[PB]) + (2.525*[AS]) + (1.731*[ZN]) + (2.176*([S] - 1.007*[CU] - 0.155*[PB] - 0.427*[AS] - 0.489*[ZN]))$
AUCon	Contained Gold	g/t	48.90	$0.934*[AU]/[MassPull]*100$
AGCon	Contained Silver	g/t	146.76	$0.934*[AG]/[MassPull]*100$
Gross Value Concentrate				
Settle	Deduction	factor	0.99	-
AU pay	Payable Gold	factor	0.94	-
AG pay	Payable Silver	factor	0.61	-
Revenue	Revenue	US\$/t	359.02	$[AU]*[GoldPri]/31.1035 * [Mill rec] * [Settle] * [AU pay] + [AG]*[Sil.Pri]/31.1035 * [Mill rec] * [Settle] * [AG pay]$
Concentrate Treatment & Refining				
Con.TCRC	Concentrate TCRC	\$/t	217.40	-
TCRC	TCRC	\$/t	37.09	$[MassPull]/100*[Con.TCRC]$
Net Smelter Return				
ProCost	Process Cost	\$/t	35.10	-
HaulCost	Haulage Cost	\$/t	3.00	-
Inc.Rate	Inclusion Rate	factor	0.60	-
Roy.Rate	Royalty Rate	factor	0.07	-
Royalty	Royalty	\$/t	11.92	$([Revenue] - [ProCost] - [HaulCost] - [TCRC]) * [Inc.Rate] * [Roy.Rate]$
NSR	NSR	\$/t	310.02	$IF((([Revenue] - [TCRC] - [Royalty]) < 0, ([Revenue] - [TCRC] - [Royalty])))$

15.2 BREAK-EVEN CUT-OFF VALUE

The break-even COV is defined as the value of the material, which will generate revenue from the sale of the finished product that is equal to the cost for mining, processing, sustaining capital, general and administrative (G&A) labour, and treatment and refining of contained metal(s), inclusive of applicable royalties. The break-even COVs determined are \$127/t for DAF and \$124/t for LHOS.

The break-even COV is used to begin identifying the potentially mineable material in the mine design process and is the main input parameter in the stope optimization process. Efemçukuru is using DSO software to identify potentially mineable material in the form of mining shapes for both DAF and LHOS mining methods.

The break-even cut-off value (BCOV) is calculated with the following formula:

$$BCOV \left(\frac{\$}{t} \right) = \text{Mining Cost} \left(\frac{\$}{t} \right) + \text{Processing Cost} \left(\frac{\$}{t} \right) + \text{G\&A Cost} \left(\frac{\$}{t} \right) + \text{Sustaining Cost} \left(\frac{\$}{t} \right)$$

Note the following regarding calculation of the break-even COV:

- Sustaining capital costs include sustaining development capital costs relating to footwall drifts and haulage drives, underground infrastructure, ventilation raises, and escape ways, as well as equipment rebuild costs.
- Tailings dam capacity is deemed to be adequate for the duration of the current life of mine, and therefore there are no cost allowances for tailings dam expansions.
- The process recovery factor used is reflective of the mill recovery factor and payability factor achieved after refining and selling the concentrate produced on site.

15.3 INCREMENTAL CUT-OFF VALUE

The Incremental cut-off value (ICOV) is defined as the grade of the material which will generate revenue from the sale of the finished product, where the revenue is equal to the downstream variable costs of mining, processing, G&A, and treatment and refining of contained metal(s) inclusive of applicable royalties. The ICOV is calculated with the following formula:

$$ICOV \left(\frac{\$}{t} \right) = \text{Variable Mining Cost} \left(\frac{\$}{t} \right) + \text{Variable Processing Cost} \left(\frac{\$}{t} \right) + \text{Variable G\&A Cost} \left(\frac{\$}{t} \right)$$

There are circumstances when mineralized material below the stated break-even COV may be added to the production stream by using an incremental cut-off. For example, when additional stopes with grades slightly below break-even COV are identified between two high grade stopes, or at the extremities of the mining horizon and do not require additional development. The decision to include incremental material in the mining profile is carefully analyzed and approved by senior engineers and/or managers. The ICOV determined is \$49/t for DAF and \$46/t for LHOS.

Note the following regarding calculation of the ICOV:

- The cost components refer to variable costs only. Fixed costs are assumed to be fully covered by mining areas with average diluted grades above the stated break-even COV.
- Transport costs and refining costs (TCRCs) contain both the variable and fixed components and are included in the block model calculation of value per tonne.
- Material identified using the ICOV must not displace the mining material above the break-even COV. There must be capacity available within the entire system to accept the ICOV for it to be evaluated with only the variable costs.

15.4 MARGINAL CUT-OFF VALUE

There are circumstances where mineralized material is already broken (e.g., development material or stockpiles) and is below the stated break-even or incremental COV, but still may be deemed economical as most of the costs associated with it have already been spent (sunk costs). In these instances, mining costs are removed from the cost structure.

The marginal cut-off value (MCOV) is defined as the grade which will generate revenue from the sale of the finished product that is equal to the variable portion of processing and G&A while also covering mine re-handle costs. MCOV is applied to material that has already been mined or is stockpiled.

The MCOV is calculated with the following formula:

$$MCOV \left(\frac{\$}{t} \right) = \text{Rehandling Cost} \left(\frac{\$}{t} \right) + \text{Variable Processing Cost} \left(\frac{\$}{t} \right) + \text{Variable G\&A Cost} \left(\frac{\$}{t} \right)$$

Mine re-handling cost can include:

- Transporting cost of the broken development material from underground to the surface processing plant.
- Loading and transporting material from a surface stockpile to the processing plant.

The MCOV of \$24/t was applied to mineralized development material that must be mined to access higher value areas. Ideally, all low-value material would be stockpiled and fed to the processing stream when there is spare processing capacity.

A summary of the cut-off value calculation inputs is presented in Table 15-22 and Table 15-23.

Table 15-2: Cut-off Value Input and Calculation Summary – Drift and Fill Method

DAF – Input Values based on actual Metrics and Budget				
Cut-off Value Cost Inputs	Units	Total Cost	Variable Cost	Fixed Cost
Mining Cost	\$/t	45.31	28.61	16.70
Process Cost	\$/t	35.09	20.09	15.00
General & Administrative	\$/t	37.09	0.00	37.09

DAF – Input Values based on actual Metrics and Budget				
Sustaining Capital	\$/t	9.11	N/A	N/A
Mining Rehandle	\$/t	3.72	N/A	N/A
Outputs				
Cut-off Values Calculated*				
Break-even Cut-off Value (BCOV)			126.60 \$/t	
Incremental Cut-off Value (ICOV)			48.70 \$/t	
Marginal Cut-off Value (MCOV)			23.81 \$/t	

* Grade of the diluted mined ore at the plant entrance point

Table 15-3: Cut-off Value Input and Calculation Summary – Longhole Open Stopping

LHOS – Input Values based on actual Metrics and Budget				
Cut-off Value Cost Inputs	Units	Total Cost	Variable Cost	Fixed Cost
Mining Cost	\$/t	42.32	25.63	16.70
Process Cost	\$/t	35.09	20.09	15.00
General & Administrative	\$/t	37.09	0.00	37.09
Sustaining Capital	\$/t	9.11	N/A	N/A
Mining Rehandle	\$/t	3.72	N/A	N/A
Outputs				
Cut-off Values Calculated*				
Break-even Cut-off Value (BCOV)			123.62 \$/t	
Incremental Cut-off Value (ICOV)			45.72 \$/t	
Marginal Cut-off Value (MCOV)			23.81 \$/t	

* Grade of the diluted mined ore at the plant entrance point

15.5 DILUTION

15.5.1 Dilution and Ore Losses

Stope shapes generated using DSO follow stope design parameters and contain the following dilution types (also refer to Figure 15-1):

- Internal dilution – dilution encapsulated as part of normal stope design (mining shape).
- Planned dilution – dilution external to mining shape which is attributable to a certain degree of overbreak.

Mining losses, expressed as a mining recovery factor, is also applied to allow for incomplete extraction of the design stope. Mining recovery is affected by the following issues:

- Incomplete clean-out of the stope during remote mining.
- Underbreak during blasting.
- Complications due to excessive stope failures resulting in abandoning a stope because of excessive dilution.

- Low sill pillar recoveries.

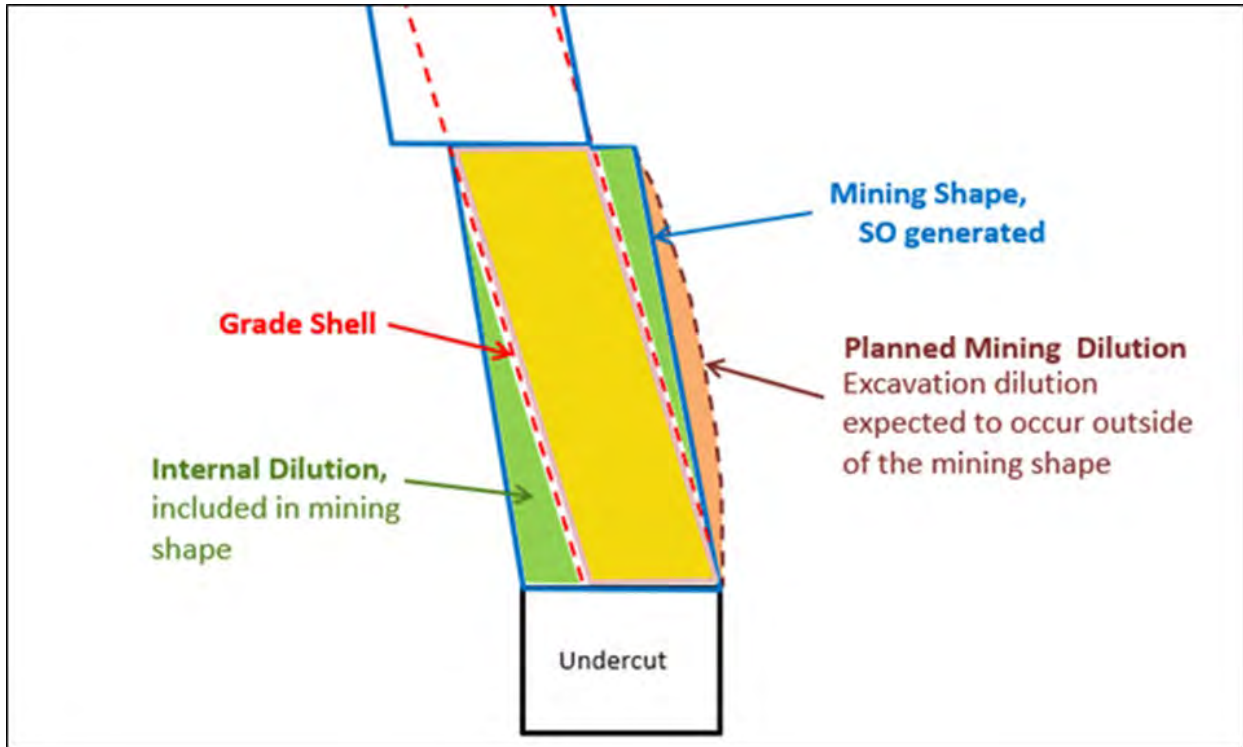

Figure 15-1: Schematic Showing Dilution Encapsulated by SO Mining Shape

The blended planned mining dilution and mining recovery factors are prorated averages between DAF and LHOS metrics and are provided in Table 15-4.

Table 15-4: Planned Mining Dilution and Mining Recovery Factors

Blended Dilution and Mining Recovery Factors	
Planned Mining Dilution	16%
Mining Recovery	97%

15.6 MINERAL RESERVES STATEMENT

Mineral Reserves estimation practices are in accordance with CIM Estimation of Mineral Resource and Mineral Reserve Best Practice Guidelines (November 29, 2019) and follow CIM Definition Standards for Mineral Resources and Mineral Reserves (May 10, 2014), that are incorporated by reference into NI 43-101. The mineralization of the project satisfies sufficient criteria to be classified into Proven and Probable Mineral Reserves. Only Measured and Indicated Mineral Resources were converted, using appropriate modifying factors, to Mineral Reserves. The following steps were followed in developing the Reserves estimates:

- Calculate NSR values for each individual block in the resource model, using long term metal prices, metallurgical recoveries, metal payability and downstream smelter treatment and refining cost assumptions. Supporting test work, actual performance and forecasts supporting these assumptions are discussed in detail in Sections 13, 17, 19 and 21 of this Technical Report.
- Design stopes using DSO, considering depleted mineral resources, existing workings, resource categories and site costs / cutoffs. Dilution is estimated and applied at this step.
- Design ore development required for accessing and extracting the stopes. Deplete development from the stopes. Interrogate grades of designed development for inclusion in mineral reserves.
- Sequence and schedule development and stope production. Mining recovery factors are estimated and applied at this step, as well as any additional planned dilution. Assign whether stopes can be upgraded to mineral reserves based on resource classification.
- Input scheduled quantities to a financial LOM study to support mineral reserve economics.

The Mineral Reserve estimate is summarized in Table 15-5 and has an effective date of September 30, 2023. Fourth-quarter 2023 production totalled 22 koz of gold produced from 138 kt of ore at an average feed grade of 5.8 g/t is summarized in Table 15-6.

Table 15-5: Efemçukuru Mineral Reserves as of September 30, 2023

Category	Tonnes (kt)	Grade (g/t Au)	Contained Au (koz)	Grade (g/t Ag)	Contained Ag (koz)
SOS – Proven	213	4.53	31	8	56
SOS – Probable	38	4.52	6	8	10
SOS – Proven + Probable	251	4.52	37	8	66
MOS – Proven	619	5.37	107	12	240
MOS – Probable	430	3.72	51	16	215
MOS – Proven + Probable	1,049	4.70	158	14	455
NOS – Proven	256	4.88	40	20	162
NOS – Probable	252	5.29	43	22	181
NOS – Proven + Probable	508	5.08	83	21	343
KBNW – Proven	199	5.66	36	11	68
KBNW – Probable	380	4.39	51	9	112
KBNW – Proven + Probable	580	4.83	90	10	180
KOK-61 – Proven	0	0.00	0	0	0
KOK-61 – Probable	326	7.25	76	24	251

Category	Tonnes (kt)	Grade (g/t Au)	Contained Au (koz)	Grade (g/t Ag)	Contained Ag (koz)
KOK-61 – Proven + Probable	326	7.25	76	24	251
KOK-84 – Proven	0	0.00	0	0	0
KOK-84 – Probable	146	4.85	23	8	36
KOK-84 – Proven + Probable	146	4.85	23	8	36
BATI – Proven	0	0.00	0	0	0
BATI – Probable	509	5.07	83	11	186
BATI – Proven + Probable	509	5.07	83	11	186
ROM Stockpile – Proven	3	6.23	1	20	2
Total Proven	1,290	5.18	215	13	528
Total Probable	2,082	5.01	335	15	991
Total Proven + Probable	3,372	5.08	550	14	1,519

Mineral Resources are inclusive of Mineral Reserves.

Table 15-6: Efemçukuru Q4 2023 Production

Category	Tonnes (kt)	Grade (g/t Au)	Contained Au (koz)	Grade (g/t Ag)	Contained Ag (koz)
Q4 2023 Production	138	5.81	22	21	92

The Mineral Reserve estimates could be materially affected by risks associated with mining. These include changes in continuity of mineralization, geotechnical aspects such as ground collapse or unrecognized fault disruption, excessive ground water inflows, and excessive dilution.

There are no foreseen environmental, permitting, legal, title, taxation, socio-economic, marketing, political, or other relevant factors that could materially affect the Mineral Reserve estimates.

SECTION • 16 MINING METHODS

16.1 INTRODUCTION

The Efemçukuru mine employs small-scale underground mechanised mining methods to exploit the narrow, high-grade, subvertical mineralization. The present mine plan is based entirely on the proven and probable reserves of 3.2 million fully diluted and recovered tonnes (post 2023 Q4 depletion) presented in Section 15. The projected mine life is six years at a planned production rate of 545 ktpa.

Efemçukuru is an epithermal gold deposit comprising three major veins, Kestanebeleni, Kokarpınar, and Batı, with Kestanebeleni containing the bulk of the ore. Kestanebeleni and Kokarpınar veins strike north-westerly (320° – 340°), dip 60° E to 70° E, and can be traced on surface for strike lengths of over 1 km. Two similarly oriented but narrower veins, called the Batı veins, occur in the footwall to the Kestanebeleni vein. The Batı veins strike north-westerly (340° – 355°), 60° E to 75° E dip. This section describes current mining of the Kestanebeleni vein, and future mining of the Kokarpınar and Batı veins (Figure 16-1).

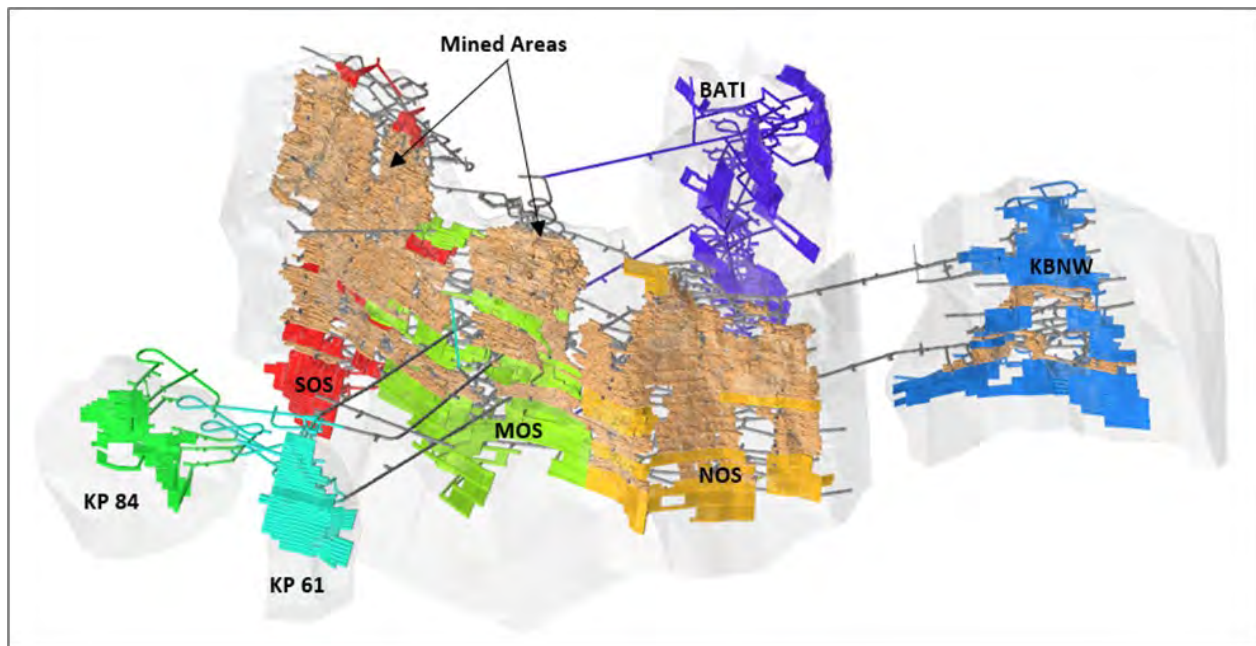

Figure 16-1: Isometric View Showing Mine Areas and Vein Wireframe (Eldorado, 2023)

The mine design has been developed to allow flexible access to all shoots. Six spiral footwall ramps, one at each orebody, provide access for moving personnel, equipment, and supplies underground. Advantages of the six-ramp system include increased stope availability and more robust ventilation, which result in increased equipment and labour productivity. All declines are interconnected by link drives, which serve as a secondary egress from the mine, spaced vertically 80 to 100 m apart.

Ore is hauled by truck to a central ore pass system above the underground crusher before being crushed and conveyed to surface via a 380 m belt conveyor. The ore pass system provides 3,500 tonnes of surge capacity for underground production with a further 5,000 t capacity in bins on surface. Waste rock is hauled to surface via the South 672 Portal or North 656 Portal.

Drift & Fill (DAF) is the primary stoping method used for widths between 2 m and 8 m. This method allows selective recovery of ore within the orebody. Longhole Open Stopping (LHOS) is used where the ground conditions are amenable to large stable spans.

Paste backfill is used as a “free standing” structure to control stability of walls, dilution, and safety for the LHOS. In the DAF stopes, paste backfill is used as the working floor. The paste plant is located near the North 656 Portal.

16.2 MINING METHODS

The present mine plan is based on the combination of the DAF and LHOS mining methods.

DAF methodology is used at locations under the following conditions:

- In shallow, weathered areas close to surface, where the HW is not stable enough for large spans.
- At the NOS fold hinge, where ground conditions are expected to be less favourable.
- Adjacent to existing DAF mining, where LHOS is not practical.

A schematic for a typical DAF production block, showing crosscut layout and sublevels, is provided in Figure 16-2.

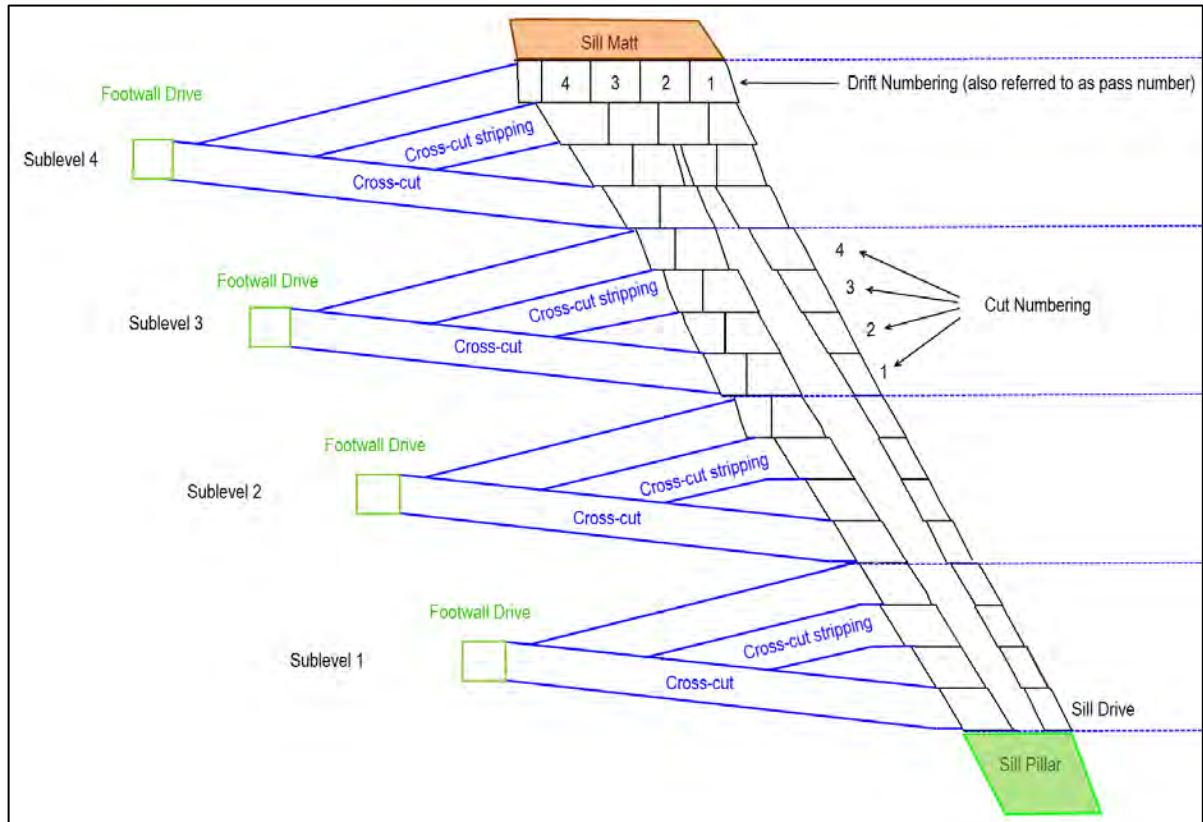

Figure 16-2: Schematic Cross Section Showing DAF Production Block Layout

LHOS methodology is used under the following conditions:

- Where good ground conditions are amenable to large stable spans,
- In deeper areas of the mine
- At narrow sections of orebody, where DAF results in excessive dilution.

A schematic for a typical LHOS production block is illustrated in Figure 16-3.

The current sublevel vertical spacing of 20 m is optimized for DAF mining. The 20 m sublevel is also an appropriate sublevel interval for LHOS given that dilution mitigation is a primary focus for the mine.

Both DAF and LHOS stopes are mined concurrently from multiple production blocks to fulfil production requirements. Overall, the production blocks are mined in a top-down sequence, but stopes within a production block are mined bottom-up (overhand).

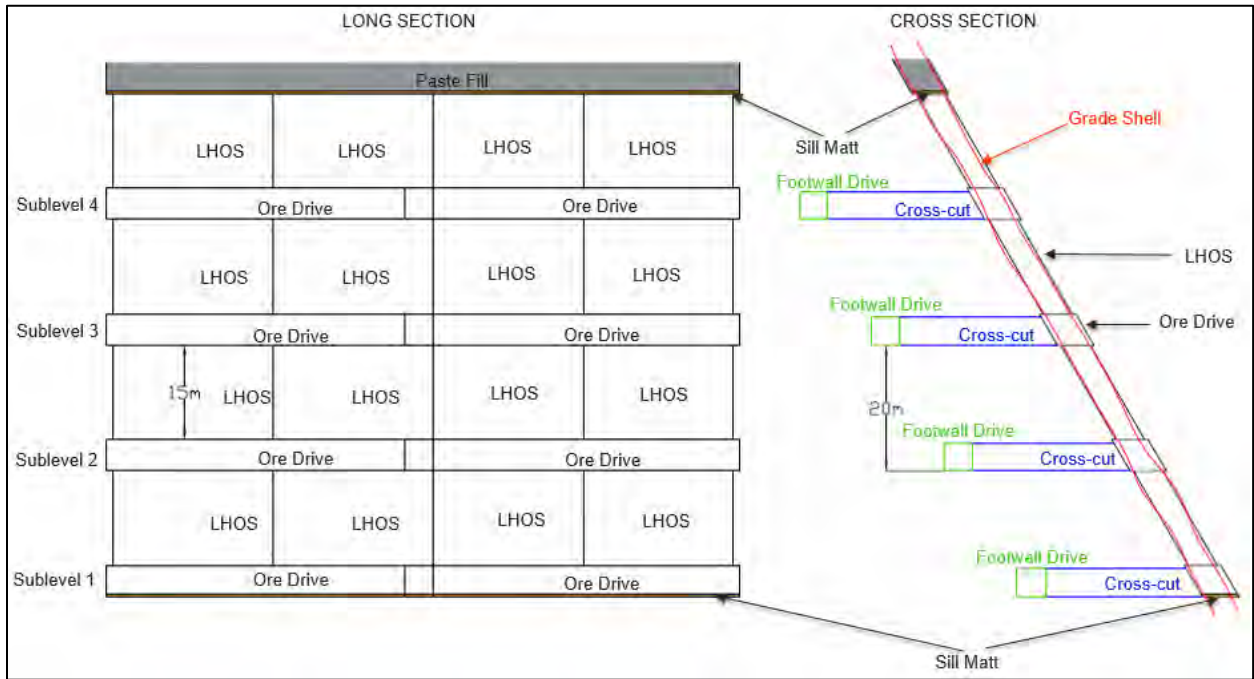

Figure 16-3: Schematic Long and Cross Sections Showing LHOS Production Block Layout

Current operations have also established the division of the orebody into independent production blocks of 80 m in vertical extent for mine planning, with each production block consisting of four sublevels where possible. Production blocks are illustrated in Figure 16-4.

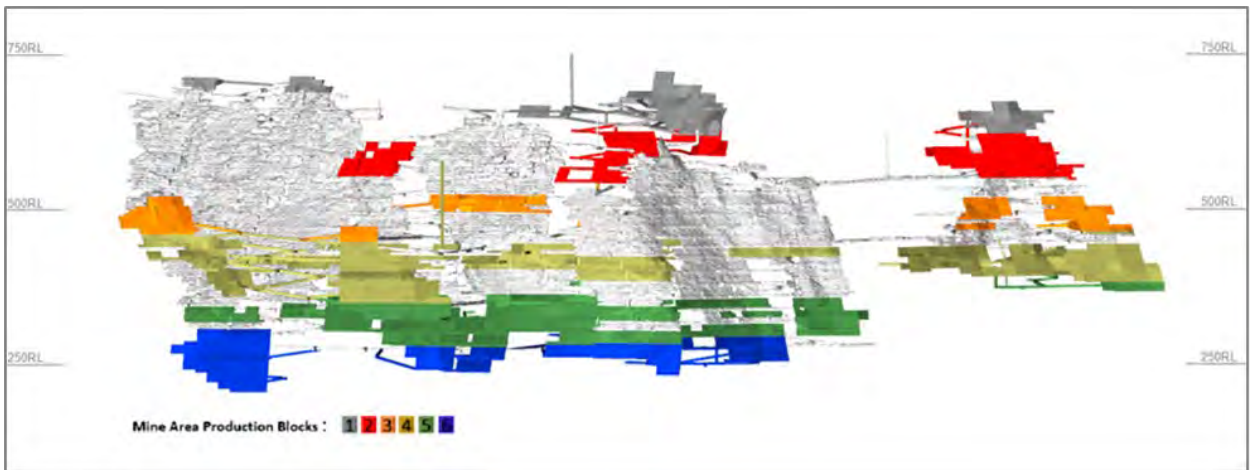

Figure 16-4: View Looking South-West Showing Production Blocks

16.3 UNDERGROUND MINE DESIGN

The current mine layout has the following features:

- Six declines, each covering approximately 400 m strike extent:
 - SOS
 - MOS
 - NOS
 - KBNW
 - Kokarpınar Ore Shoot
 - Batı Ore Shoot
- Two surface portals (south and north).
- One surface conveyor adit for conveying crushed ore to the surface crushed ore bins.
- Five primary ventilation surface exhausts (south, central, north, northwest, and Batı) and three fresh air raises for the NOS, Kokarpınar and Batı.
- Link drives connect declines and serve as a secondary egress from the mine.

16.3.1 Development Dimensions

Development dimensions are provided in Table 16-1 and are based on current practices and equipment sizes.

Table 16-1: Development Dimensions

Development	Width (m)	Height (m)	Gradient
Diamond Drill Access	4.5	4.5	1:20 to 1:50
Diamond Drill Cuddy	6.0	5.0	1:20
Decline or Incline	4.5	4.5	1:6.7 (15%)
Footwall Drive	4.5	4.5	1:20 to 1:50
Level Access (Decline to FWDRV)	4.5	4.5	1:20 to 1:50
Ore Drive	4.5	5.0	1:50
Stockpile	4.5	4.5	1:20
Sump	5.0	4.5	-1:5
Vent Access	4.5	4.5	1:20 to 1:50
Vent Raise	4.0	4.0	NA
Crosscut	4.5	4.5	-1:6 to 1:6

16.3.2 Development Stand-off Distances

The following development stand-off distances are used in the LOM plan:

- Footwall-drive: 50-m lateral standoff (40-m true distance) from stopes / orebody.
- Decline: 20-m lateral standoff from the footwall drives.
- Vent raises: 40-m minimum distance from stopes.
- Infrastructure: 60 m from stopes.

Efemçukuru easily maintains adequate standoff distances for access infrastructure due to the use of footwall drives and DAF stopes requiring 50-m long crosscuts.

16.4 GEOTECHNICAL ASSESSMENT

16.4.1 Geotechnical Conditions

General rock types and geotechnical and mining conditions at Efemçukuru include:

- The current reported resources are contained within the Kestanebeleni, Kokarpınar, and Batı vein structures.
- All veins outcrop at surface and a minimum 20-m crown pillar is being maintained between the surface and the underground mining.
- Mineralization consists of moderately dipping (50° to 70°) stacks of various quartz veins that strike north-south and northwest-southeast.
- Phyllites and hornfels are the primary host rocks (silica and calc-silicate altered phyllites are referred to as hornfels).
- Mineralization is bound by planar fault zones along footwall and hanging wall contacts; there are also minor faults sub parallel to the veins.
- Inter-veins waste usually carries low background Au grades.
- There are no in-situ stress measurements, but the direction of principal stress is estimated to be horizontal and sub-perpendicular to the strike of veins.
- The mine is generally considered dry but is affected by high seasonal ground water inflows and seepages primarily associated with historic workings and structural features (faults, shears, and dykes).
- Ground conditions in the MOS are generally worse than the SOS and the NOS, with the NOS having the strongest ground conditions.
- Mineralization of the KBNW is dipping (50°) and narrow, with indications for relatively poor ground conditions amenable for DAF mining method.
- Mineralization of the Kokarpınar is dipping (45°-60°) and narrow, striking west-east. It is amenable for DAF mining method.

- Mineralization of the Batı is dipping (60°-80°) and narrow, with indication of relatively good ground conditions amenable for LHOS. It is dominantly comprised of quartz and quartz sulphide veins that strike northwest-southeast.

16.4.2 Rock Mass Quality

Geotechnical observations concluded that:

- Rock quality designation (RQD) analysis from exploration and delineation drilling indicates that the hornfels are the most competent unit followed by the veins and phyllite.
- The rock strength data indicates that the strongest intact rock unit is the mineralised veins followed by hornfels, with the phyllite being the weakest of the three rock units.

The geologic units and corresponding quality encountered at Efemçukuru are described in Table 16-2:

Table 16-2: Rock Mass Quality

Rock Type	Quality
Hornfels	Competent
Stockworks Hornfels	Competent
Veins	Competent but blocky and jointed
Phyllite	Generally competent
Stockworks Phyllite	Generally competent
Fault zones	Very weak soil like material with clay alteration

16.4.3 Geotechnical Domaining

A geotechnical domain model has been developed and updated for geotechnical logging of exploration and stope definition drilling information. Major fault structures are also mapped and updated in the geotechnical domain model. The model contains RQD, Q', and Q for rock mass classification.

16.4.4 Rock Mass Classification

At Efemçukuru, the rock mass has been classified by the widely used Q-System (Barton et al., 1974), adopting characterization logging values to determine Q input parameters. The Q-system was developed to measure tunnelling conditions and support requirements. The rock quality (Q) is a function of six variables:

$$Q = \left(\frac{RQD}{J_n} \right) \times \left(\frac{J_r}{J_a} \right) \times \left(\frac{J_w}{SRF} \right)$$

Where:

- RQD is defined as the percentage of intact, sound pieces of core, longer than 100 mm in the total length of core measured in the geotechnical domain.
- J_n = joint set number. This parameter refers to the number of joint sets identified in the rock mass. The RQD / J_n parameter is a representation of the block size in the rock mass.
- J_a = joint alteration number. This parameter refers to alteration, the type and thickness of infill on the joint.
- J_r = joint roughness number. This parameter refers to the surface roughness of the joint. The J_r / J_a parameter is a representation of the inter-block shear strength of the rock mass.
- J_w = joint water reduction factor. J_w is a measure of water pressure, which has an adverse effect on the shear strength of joints by reducing the normal effective stress.
- SRF = stress reduction factor. SRF is based on one of the following parameters: a loosening load in an excavation through shear zones; rock stress in competent rock; or squeezing loads in plastic incompetent rock. The J_w / SRF parameter indicates the conditions of active stress around an excavation.

The last two parameters (J_w and SRF) are related to the active stress conditions around an excavation. If the rock mass alone is to be characterized, these parameters are removed from the classification system to calculate the modified rock quality (Q'). Q' is based on rock mass conditions and is the basis for determining N' from the Mathews Stability Graph Method to assess slope stability (Hutchinson and Diederichs, 1996). Therefore, Q' is calculated as:

$$Q' = \left(\frac{RQD}{J_n} \right) \times \left(\frac{J_r}{J_a} \right)$$

Where any statements about Q' rock mass classification ratings are made, it is assumed that:

$$\frac{J_w}{SRF} = 1$$

The analysis indicates that the Q' values vary between 4 and 40 for the vein and main host rocks, indicating fair to very good rock quality. Fault zones have a rock quality index of less than 0.3, indicating very poor to extremely poor rock quality.

16.4.5 Slope Stability Assessment

It is a common practice to classify rock mass quality and assess ground conditions using the Norwegian Geotechnical Institute (NGI) Q system. The geotechnical information is gathered from the underground mapping and from the slope definition drilling. The slope stability is assessed utilizing site-specific stability graph method developed at the mine.

The Mathews stability number modifies the Q' value by three factors to consider the magnitude of the induced stresses in the stope surface, the relative orientation of the major joint set to the surface and the angle of the stope surface.

The modified Mathews stability number (N) is defined as:

$$N' = Q' \times A \times B \times C$$

Where:

- Q' is the modified Q value.
- A is the rock stress factor.
- B is the joint orientation factor.
- C is the gravity adjustment factor.

The most appropriate N' and HR parameters are considered to assess stope stability of the walls on the Mathews stability graph.

Hydraulic radius is defined as:

$$HR = \left(\frac{Lw \times Hw}{(2 \times Lw) + (2 \times Hw)} \right)$$

Where:

- HR is the hydraulic radius.
- Lw is the length of the wall.
- Hw is the height of the wall.

The selection of DAF and LHOS mining methods is primarily based on the orebody geometry (width and dip) and the expected ground conditions determined through geotechnical assessment.

Because of insufficient geotechnical data from exploration boreholes for KBNW and Kokarpınar, mining in this area has been conservatively based on the DAF mining method. There may be opportunity to use more LHOS mining method once sufficient geotechnical information becomes available from ongoing exploration and planned stope definition drilling prior to mining.

Since the start of LHOS operations in 2015, there has been a considerable amount of stope performance data made available for the development of a site-specific empirical stability graph for mine design and planning purposes at Efemçukuru (Figure 16-5).

The geotechnical assessment indicates that the current mining method, stope sizes, and mining sequence will not change significantly over the LOM.

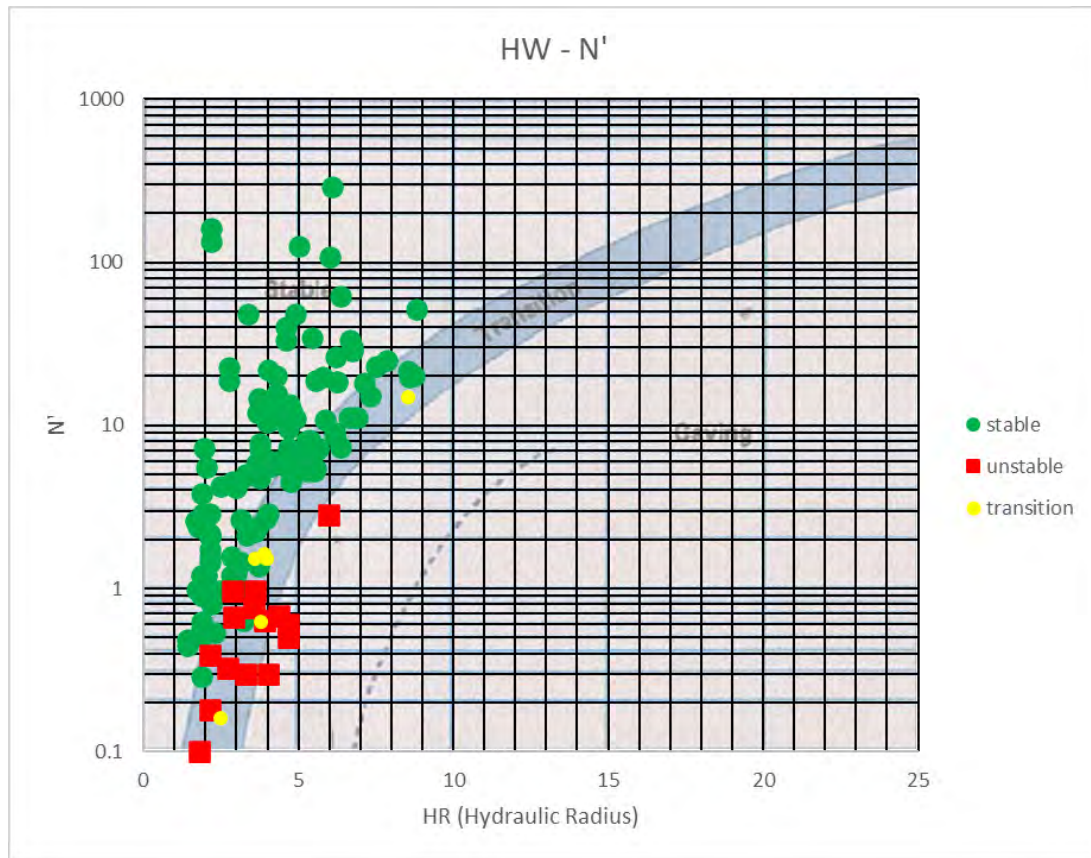

Figure 16-5: Back Analysis of Stope Performance (The Mathews Stability Graph)

16.4.6 Sill Pillar Recoveries

Sill pillars are temporarily left in place and serve to increase the number of production areas in operation at the same time. These pillars are designed to a 20-m vertical height, similar to the regular long-hole stope height, and placed every 80-m vertical interval. The sill pillars are recovered, using blind up-holes, as the mining progresses upwards to the sill level.

16.4.7 Geotechnical Mine Design Guidelines

Adopted stable stoping spans and mining sequence include:

- A minimum crown pillar size of 20 m (below surface).
- Maximum sublevel spacing of 20 m (floor to floor).
- Maximum stope length of 20 m along and across strike.
- Continuous retreat blind up-hole stoping in MOS and SOS sill pillars.
- Minimum one stope pillar separation (of 5 m waste) between two lenses in the case of DAF mining.

- Minimum separation of 60 m between major developments and between stoping and major infrastructures.
- Preferred sequence for mining the stacked lenses is from the hanging wall towards the footwall.
- Filling of all stope voids with backfill and tight filling of stopes where multiple lifts of stopes are mined.
- Pouring 0.5 m thick, mesh reinforced, 30 MPa grade concrete at the base of sill pillar stopes until the quality of paste fill is improved to allow safe mining directly beneath paste fill.

16.4.8 Ground Support

Typical ground support used at Efemçukuru consists of:

- Fibrecrete – 30 MPa (30-mm or 100-mm thick).
- Steel mesh – 6-mm diameter and 100-mm x 100-mm cells.
- Primary bolting – 2.4 m-long splitsets.
- Cable bolts – 6-m, single strand, plain, 25-tonne capacity in intersections and along hanging wall contacts in longhole stopes, and 9-m long cable bolts in sill pillars.
- Multiple combinations of the above.

16.5 BACKFILL

Current mining methods require systematic filling of all stope voids for stability and to enable extraction of adjacent ore. Efemçukuru is currently using a combination of backfill types:

- Paste fill made from filtered tailings and cement.
- Development waste rock used as unconsolidated rockfill.
- Cemented rockfill used where required.

The primary backfill method is paste fill. The current fill recipe is to mix paste fill at yield stress of 100 Pa to 500 Pa (or conical slump of 190 mm to 240 mm) at solids density between 65% and 69% by weight. The current cement content is 7% or 10% by dry solids weight, depending on the stope and required duty. The bulk density of the paste fill is 1.7 t/m³.

The paste backfill reticulation system has been extended to each active mining area. A combination of 4-inch and 5-inch schedule 80 and schedule 40 steel pipelines are used. Paste is delivered underground using an 80-bar capacity Putzmeister positive displacement pump, pumping through Schedule 40 and 80 steel pipelines and a network of surface and internal boreholes.

16.6 MINING RATE

Efemçukuru has a sustainable ore production rate of 545 ktpa. The mine plan has a duration of approximately six years. Mining unit dimensions follow geotechnical mine design guidelines (described above), with maximum LHOS dimensions of 20 m high and 20 m along and across strike. For DAF, 5 m heights are mined with variable widths ranging from 2 m to 8 m.

16.7 MINE DEVELOPMENT AND PRODUCTION ASSUMPTIONS

The development and production assumptions have been prepared based on demonstrated performance at Efemçukuru. The following assumptions apply to the schedule:

- Lateral development: 850 m/month mine total (includes DAF production)
- Lateral development: 70 m/month for single face advance
- Development advance rate: 3.5 m/round
- Longhole stope rate: 15,000 t/month
- Mining dilution factor: 16% (DAF and LHOS combined average)
- Mining recovery factor: 97% (DAF and LHOS combined average)

16.8 MINING SEQUENCE

Each mine area is divided into vertical production blocks 80 m high (four sublevels).

Within each production block, stopes are mined bottom-up (overhand sequence), with each sublevel mined and filled in its entirety before the overlying sublevel can commence.

For DAF, the intra-production block sequence is such that each cut (lift) must be completed and filled before the crosscut is stripped and the next cut can commence. A schematic outlining the basic DAF sequence is provided in Figure 16-6.

For LHOS, the intra-production block sequence commences at the lowest sublevel at the furthest extents of the ore drive(s) from the crosscut access. Stopes are mined and filled sequentially, retreating to the crosscut access. When a sublevel is finished in its entirety, stoping on the next sublevel can commence. A schematic outlining the basic LHOS sequence is provided in Figure 16-7.

								- Pastefill	
								- Concrete Sill Matt	
Production Block	Sublevel 4	Blind up-holes	28	29	30	31	29	28	- Sill Pillar
		Cut 2	27			26	27		
		Cut 1	25			24	25		- New Cross Cut
	Sublevel 3	Cut 4	23			22	23		
		Cut 3	21			20	21		
		Cut 2	19			18	19		
		Cut 1	17			16	17		- New Cross Cut
	Sublevel 2	Cut 4	15			14	15		
		Cut 3	13			12	13		
		Cut 2	11			10	11		
		Cut 1	9			8	9		- New Cross Cut
	Sublevel 1	Cut 4	7			6	7		
		Cut 3	5			4	5		
		Cut 2	3			2	3		
		Sill Drive	1			0	1		- New Cross Cut
Central Cross-Cut									

Figure 16-6: Schematic Showing DAF Mining Sequence for a Typical Production Block

Production Block	Sublevel 4	Stope	20	21	22	23	24	25	24	23	22	21	20	- Sill Pillar (blind uphole extraction)
		Ore Drive	13			12		13						
	Sublevel 3	Stope	14	15	16	17	18	19	18	17	16	15	14	
		Ore Drive	7			6		7						
	Sublevel 2	Stope	8	9	10	11	12	13	12	11	10	9	8	
		Ore Drive	1			0		1						
	Sublevel 1	Stope	2	3	4	5	6	7	6	5	4	3	2	
		Sill Drive	1			0		1			- Sill Drive			
	Central Cross-Cut													

Figure 16-7: Schematic Showing LHOS Mining Sequence for a Typical Production Block

16.9 MOBILE EQUIPMENT FLEET

The current equipment fleet is provided in Table 16-3. The equipment levels are generally consistent with the current fleet numbers throughout the LOM plan.

Table 16-3: Current Equipment Fleet

Equipment	Capacity	Number
Twin Boom Jumbo	-	4
Longhole Production Drill	-	2
Cablebolter	-	1
Underground Trucks	30 t	6
LHD 7 tonne	6.7 t (3.2 m ³)	2
LHD 10 tonne	10.0 t (4.7 m ³)	3
Backhoe Loader	1 m ³	3
Explosives Charging Truck	-	2
Shotcrete Truck	-	2
Concrete Mixing Truck	4.5m ³	2
Service Vehicle	-	5
Scaler	-	1
Telehandler	3.0 t	3
General Service Truck	-	4
Scissor Lift	4.5 t	2
Grader	-	2
Boom Truck	0.9 t	2
Cable Reeler	0.3 t Platform – 4.0 t Reel Lifter	2
Diamond Drill	-	3

16.10 MINE SCHEDULE

The mine operates seven days per week and three shifts per day. This annual schedule is equivalent to 365 days per year of operation.

16.10.1 Development Schedule

More than 43,000 m of mine development has been completed as of December 2023. The current existing underground mine development and the LOM plan for development is shown in Figure 16-8.

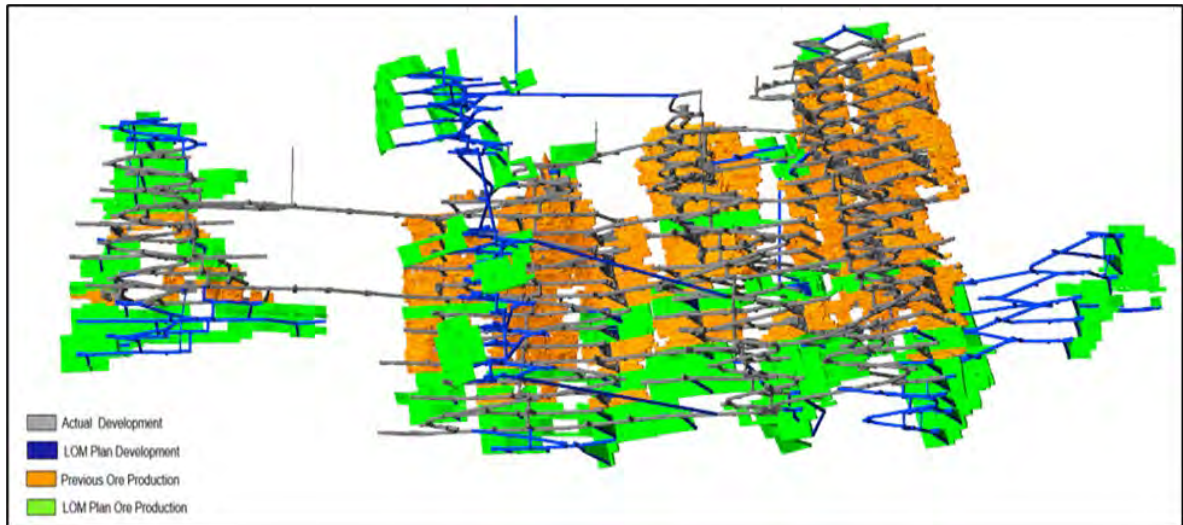

Note: View - looking to the East

Figure 16-8: Current and LOM Plan Mine Development

Development planned for the LOM is summarized in Table 16-4.

Table 16-4: LOM Plan Development

Mine Development	Unit	2024	2025	2026	2027	2028	2029	Total
Operating Development								
Lateral Ore (incl. DAF)	m	5,261	5,299	5,105	4,339	4,272	3,576	5,261
Lateral Waste	m	1,440	1,308	1,765	1,553	1,979	1,467	1,440
Capital Development								
Lateral Waste	m	3,047	3,428	3,325	3,471	3,458	1,860	3,047
Vertical Waste	m	293	131	104	269	152	100	293
Total Lateral								
	m	9,748	10,034	10,195	9,363	9,710	6,903	9,748
Total Vertical								
	m	293	131	104	269	152	100	293

16.10.2 Production Schedule

Efemçukuru plans to mine 545 kt of ore at an average grade of 5.4. g/t Au in 2024. The LOM production plan is summarized in Table 16-5.

Table 16-5: LOM Plan Production Schedule

Ore Classification	Unit	2024	2025	2026	2027	2028	2029	Total
Proven	Tonnes (kt)	384	271	224	84	139	65	1,168
	Au g/t	5.50	5.00	5.65	4.41	4.38	4.96	5.17
	Au (koz)	68	44	41	12	20	10	194
Probable	Tonnes (kt)	161	274	321	461	406	441	2,063
	Au g/t	5.17	5.26	4.70	4.76	4.98	5.14	4.97
	Au (koz)	27	46	48	70	65	73	330
Total Ore Production	Tonnes (kt)	545	545	545	545	545	505	3,231
	Au g/t	5.40	5.13	5.09	4.70	4.83	5.11	5.04
	Payable Au (koz)	95	90	89	82	85	83	524

16.11 VENTILATION

The primary ventilation layout relies on declines serving as fresh air intakes and longhole raises, interconnected between sublevels, serving as an exhaust.

Each mine area has a decline coupled with an exhaust raise system to provide primary ventilation. Fresh air flows down the declines and onto each level via the level access and the footwall drives. Secondary ventilation using axial flow fans and vent duct takes primary airflow from the footwall drives and directs it into the ore drives and stopes. The used air returns to the footwall drives under positive pressure and exits the level via the exhaust rises connected to the footwall drives on each level.

The exhaust raise system comprises longhole raise extensions between levels. Each longhole raise extension is approximately 20 m long and has a cross sectional area of approximately 16 m². Axial flow primary vent fans are installed in underground bulkheads within the exhaust.

The main components of the LOM plan primary ventilation layout are shown in Figure 16-9.

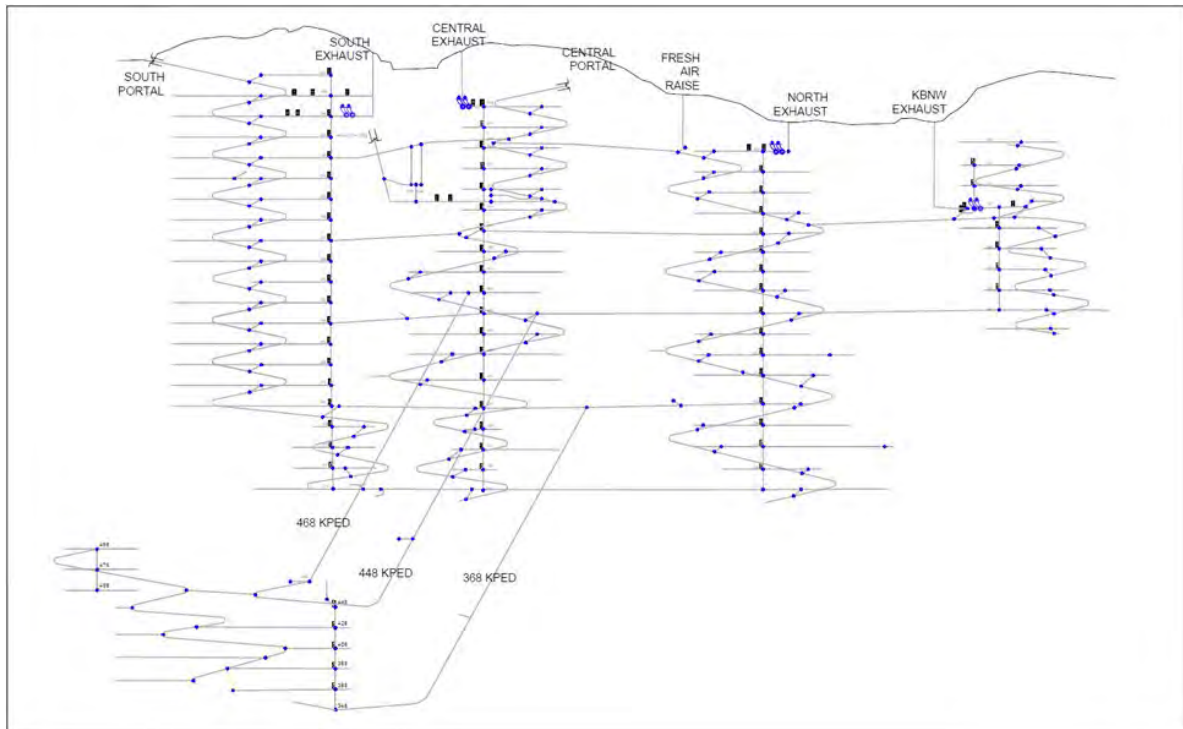

Figure 16-9: Primary Ventilation Components

16.11.1 Fresh Air Demand

Fresh air demand for the current operations and LOM plan requirements, equipment quantities, and power demands are summarized in Table 16-6. The determination of air quantities is based on 0.06 m³/s per kW of power, which is in line with international norms.

Table 16-6: Fresh Air Requirement for Diesel Equipment

Equipment	No of Units	Diesel Engine Power (kW)	Effective Utilization (%)	Total Required Airflow (m ³ /s)
Production Fleet				
Jumbo	4	120	20	5.76
Longhole Drill Rig Type 1	1	65	23	0.90
Longhole Drill Rig Type 2	1	55	48	1.58
LHD – 10 tonne	3	220	70	27.72
LHD – 7 tonne	2	150	65	11.70
Truck – 30 tonne Type 1	2	240	41	11.81
Truck – 30 tonne Type 2	4	315	83	62.75
Support Fleet				

Equipment	No of Units	Diesel Engine Power (kW)	Effective Utilization (%)	Total Required Airflow (m ³ /s)
Service Vehicles	15	110	54	53.46
Forklift	3	101	39	7.09
Backhoe	3	74	55	7.33
Light Vehicle	12	120	50	43.20
Utility Vehicle	5	96.5	76	22.00
Allowance for Leakage	10%			25.53
Total				280.82

The current mine intake airflow is 330 m³/s, which is sufficient to ventilate the workings at the current and planned LOM production levels.

The mine has eight Zitron 90 kW axial main fans installed; two per each mining area (Figure 16-9). For the primary fans in the existing mining areas, no major changes are anticipated over the LOM.

16.11.2 Ventilation Design Parameters

The ventilation system design is being modelled using Ventsim Mine Ventilation Simulation Software (Ventsim). This software allows input parameters including resistance, k-factor (friction factor), length, cross-sectional area of openings, perimeter, and fixed quantities (volume) of air. The k-factors used are average standards for various types of drifts, raises, and openings. Underground ventilation control requires several sets of ventilation control doors, regulators, and auxiliary fans (of various kW) to direct air quantities to the workings.

16.12 MINING SERVICES

16.12.1 Dewatering

The current mine dewatering system at Efemçukuru is a “clear water” system that consists of primary and secondary infrastructure. The primary infrastructure includes large, fixed pumps that handle all water feeding into and out of the sedimentation sumps (settling ponds). The secondary infrastructure includes smaller face pumps that handle dirty water before it reaches the sedimentation sumps.

Pump stations have been designed at approximately 80 to 180 m vertical spacing. Keeping the pump stations within this limit will avoid the need for high pressure pipes and reduce the pump sizes required.

At present the mine experiences a ground inflow of approximately 65 L/s. During periods of high rainfall, however, volumes of water from the underground can be as high as 150 L/s.

The current dewatering capacity is 200 L/s, after having been recently increased by the addition of four new pumps, two each at levels 295 L and 475 L.

A main pumping station is located at the base of the MOS mining area on 295 level with all water collected from SOS, NOS, and KBNW delivered to the 295-main pump station under gravity through pipelines installed along the connecting drives. The clean water from MOS 295 pump station is pumped to MOS 475 pump station and from there to the WRSP on surface in Figure 16-10.

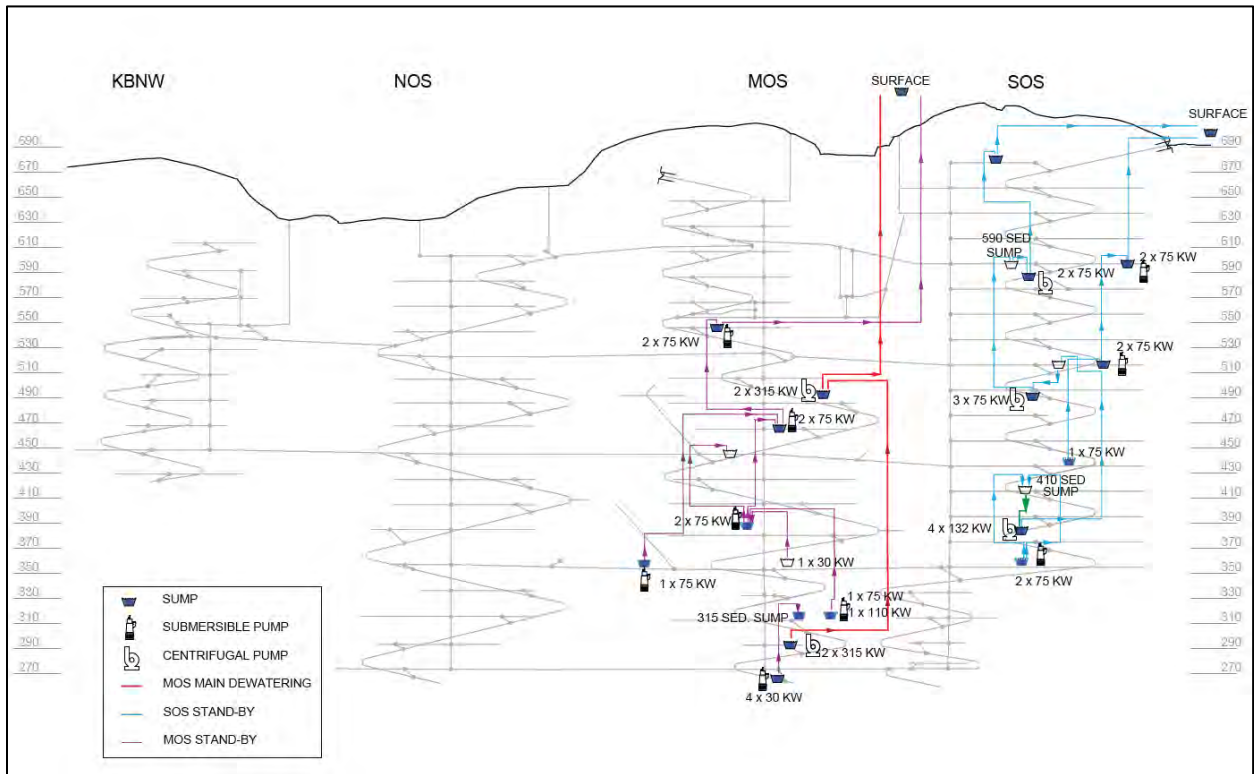

Figure 16-10: Dewatering System

16.12.2 Power Supply

The mine power is supplied directly from the site's electrical distribution on surface which is connected to the grid. Infrastructure is in place to service to all mining areas and continually expanded as the mine develops.

16.12.3 Compressed Air

Compressed air is only utilised for instrument air (vortex of electrical boxes), at the workshop, and for blowing out the main pump sumps. Compressed air is not required for drilling equipment because all drilling equipment is equipped with on board compressors.

16.12.4 Explosives Storage and Handling

The explosives and detonator magazine with 25,000 kg capacity is located on level 650, where blasting agents and accessories are stored in two separate rooms. Bulk emulsion is used for underground production and development.

16.12.5 Delivery of Supplies and Personnel Transportation

Flatbed diesel-powered utility vehicles move supplies, including drill parts, explosives, and other consumables from surface to underground work areas. Diesel-powered enclosed personnel carriers transport the crews. Supervisors, engineers, geologists, surveyors, mechanics, and electricians share smaller diesel-powered vehicles.

16.12.6 Communications

A leaky-feeder radio system provides the primary communication underground. Supervisors and mobile maintenance crews utilize handheld radios. The leaky-feeder radio system is linked to the surface PABX system.

All main ramps and level accesses are covered with fibre optic cables and Wi-Fi hotspots. Wi-Fi telephones are used by supervisors. All underground personnel are tracked with a personnel tracking software.

16.12.7 Maintenance

Preventive maintenance encompasses all activities that prolong the life of equipment and reduce premature failures. Maintenance personnel underground perform preventative and corrective maintenance work including adjustments, lubrication, and refuelling.

All major repair and maintenance on mining equipment including drills, loaders, and trucks is performed in an underground workshop at the 555 level.

16.12.8 Fuel Storage and Distribution

Diesel fuel is delivered to the mine-site by road tanker and stored in fuel tanks buried on surface, compliant with local Turkish regulations. The storage fuel tank is installed on a concrete pad with concrete berms to prevent contamination in the event of a spillage. All bulk lubricants for operations are stored in the warehouse.

Mine trucks hauling waste rock are refuelled on surface. A lube-fuel truck fuels LHD units, drills, and other underground diesel equipment not reporting to the surface each shift.

16.12.9 Fire Protection, Safety, and Mine Rescue

The North, South and Middle ramps are fresh air escape routes. A total of ten refuge stations are located underground; two on the KBNW, three on the North Ramp, three on the Middle ramp, and

two on the South Ramp. Eight of the refuge stations are portable and two of them are permanent. The refuge stations provide a self-contained atmosphere, provide oxygen at controlled rates, and remove carbon dioxide from the air.

Mine rescue equipment and facilities are located at the mine site. Two mine rescue teams are trained with the necessary firefighting and rescue skills. Detailed ventilation plans are updated regularly for the mine rescue teams.

Fire extinguishers are located at key infrastructure locations and at strategic points along each underground sub level. All underground miners are trained in basic safety, first aid, and underground mine survival techniques. A stench gas system is used to warn all employees in case there is an emergency underground.

Fire suppression systems are fitted to all mobile equipment.

SECTION • 17 RECOVERY METHODS

17.1 INTRODUCTION

Run-of-mine (ROM) ore is crushed underground and then transferred to two ore storage bins on surface via a conveyor. The two ore storage bins allow for blending of different ore types feeding the process plant feed, target a desirable gold / sulfur ratio and reduce contents of penalty elements for concentrate sales.

The process flowsheet for the recovery of gold was originally a combination of gravity concentration and flotation. Cleaner flotation concentrate was previously subjected to further upgrade by gravity concentration to produce a smeltable grade product that was smelted at Efemçukuru to produce gold doré. The remaining flotation concentrate after gravity concentration was thickened, filtered, and stored in big bags for shipping. Gravity gold recovery from the plant operation was only around 1% of total gold production and was seen as not being economically viable, which led to the decommissioning of the gravity concentration circuit in 2018.

A simplified process flow diagram of the current circuit is provided in Figure 17-1. The comminution circuit consists of a semi-autogenous grinding (SAG) mill operated in closed circuit with a pebble crusher, a ball mill operated in closed circuit with hydrocyclones, and a flash flotation cell. The entire ball mill discharge is treated in a flash cell to recover the fast-floating liberated sulfide mineral particles and prevent overgrinding of gold containing particles. Overflow from the hydrocyclones is sent to a rougher / scavenger flotation bank. The flotation circuit consists of a rougher / scavenger flotation bank and two parallel cleaner flotation banks. The concentrates from the first two cells of the rougher / scavenger bank are combined and upgraded in cleaner bank 1. The concentrates from rougher cells 3 to 6 are treated in cleaner bank 2. The concentrates from both cleaner banks and flash flotation cell are combined and sent to the column flotation cells.

The column flotation cells were installed and commissioned in 2020 to further upgrade the final concentrate. The tail of the column flotation section is recirculated to the ball mill discharge pump box. The column concentrate is sent to the concentrate thickener. Underflow of the concentrate thickener is filtered, and the filtered concentrate is stored in bulk bags for shipping. Rougher / scavenger flotation tailings are passed through a Knelson gravity concentrator, with concentrate sent to the ball mill discharge pup box. The tailings after Knelson gravity concentrator are sent to the tailings thickener.

The tailings thickener underflow is filtered to obtain a material of approx. 15% to 20% moisture content. A portion of the filtered material is used in the paste backfill plant, and the rest is dry stacked in the tailings storage facility (TSF).

17.2 PROCESS PERFORMANCE

A summary of performance data of the process plant is presented in Table 17-1, using data from 2023. The original process design values are also included for comparison. The current annual throughput is more than 35% higher than the original design value.

The average annual throughput was increased to 535,863 tonnes in the last four years. The crushing plant was operated for longer hours and its availability increased to 95%. The mill availability and



utilization figures increased to over 97%, indicating very short shutdown periods for mostly scheduled maintenance works. The average gold grade of the plant feed was 6.2 g/t. While much lower than the design value, this average gold grade was still a very high grade against comparable operations around the world. Additionally, a pyrite concentrate could be produced assaying 56.8 g/t Au and 165 g/t Ag at 93.5% Au recovery. The annual concentrate production was 54,526 tpa.

The crushing and grinding test data from 2018 was used in Table 17-1, because comminution tests have not been conducted on the plant feed since 2018. According to the 2018 data, the plant feed is harder than that estimated in the design stage. Although the plant feed is harder than estimated, the grinding circuit is capable of treating throughputs higher than estimated in the design stage.

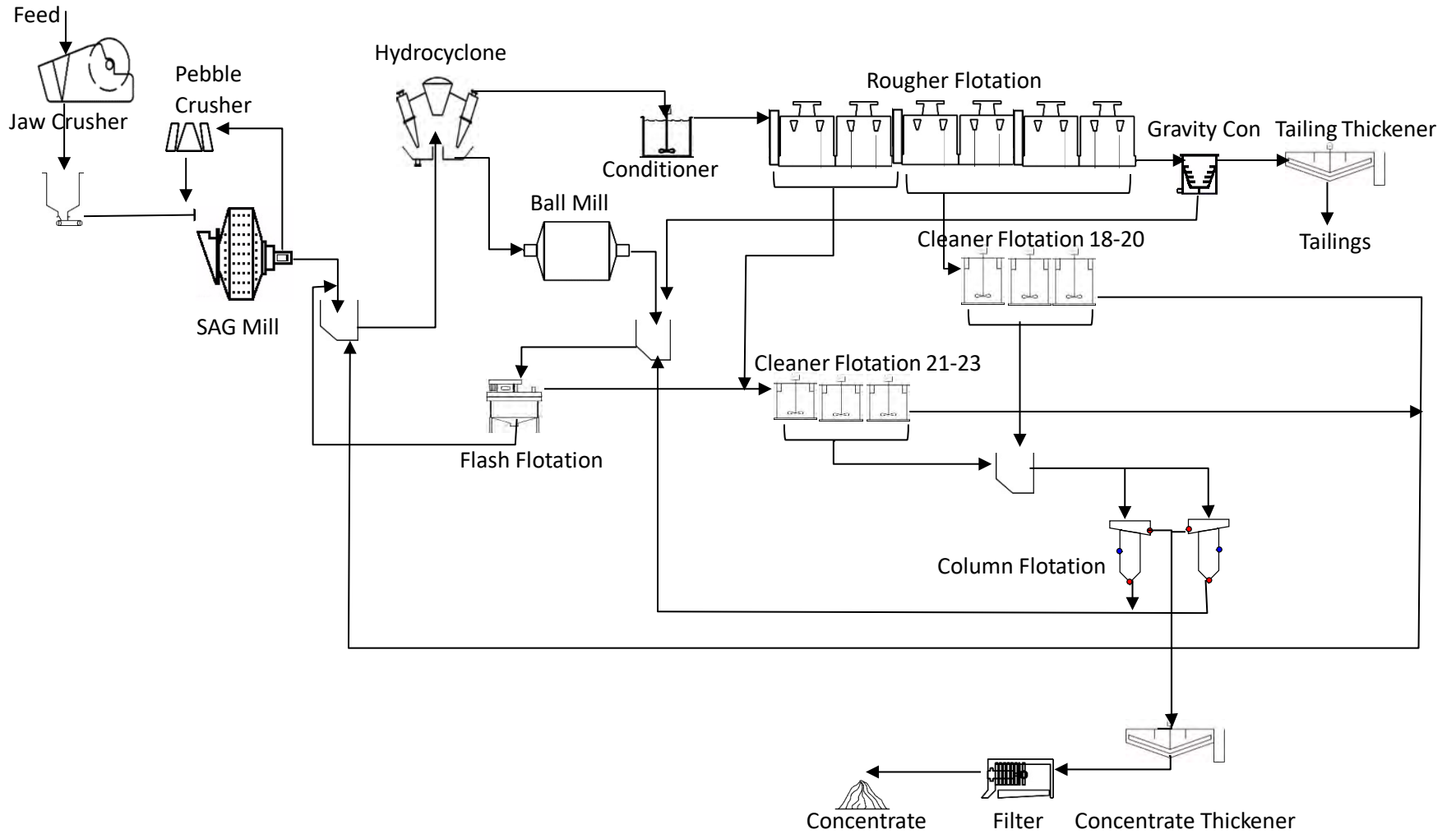

Figure 17-1: Simplified Plant Process Flow Diagram with Column Flotation Cells

Table 17-1: Process Design Criteria and Recent Plant Performance Data

	Unit	Design	Actual Operation (2023)
Availability / Utilization			
Annual ore throughput	dry t	401,500	547,089
Daily (calendar) ore throughput	dry t	1,100	1,499
Plant availability	%	90.0	97.6
Plant utilization	%	-	97.3
Grinding and flotation processing rate	dry t/h	50.9	62.6
Ore Properties			
Bond abrasion index		0.670	
Bond crushing work index	kWh/t	17.0	
Bond ball mill work index	kWh/t	17.2	
Specific Gravity		2.91	
JK drop weight Axb		46.4	
JK drop weight ta		0.51	
Recovery and Concentration			
Gold recovery	%	92.0	92.7
Concentrate Mass Pull	%	8.2	10.3
Moisture content of concentrate filter cake	%	8.0	8.5-11

Operating crushing and ball mill work indices of the plant feed are significantly higher than the design values, and the current plant feed is harder than the ore samples used in comminution tests during design stage. The moisture content of the concentrate filter cake is 8.5% to 11%, which is 0.5% to 3% higher than the design value. Other parameters are similar to the design values.

17.3 PROCESS FLOWSHEET AND EQUIPMENT

17.3.1 Crushing

The crushing circuit is located in the underground mine. The ore is fed to the jaw crusher from two ROM bins, originally by chain feeder but more recently by gravity. There are gates over the ROM bins to minimize oversized rocks being fed to the crusher. A scalping grizzly removes any fine material of less than 80 mm prior to crushing. The crusher produces a product of 80% passing approximately 90 to 100 mm.

Certain sections of the crushing circuit have been revised to improve operational efficiency since the beginning of the operation. In 2014, the chain feeders were removed, and isolation gates were installed. The design value of the scalping grizzly aperture size was 150 mm. In 2015, the scalping grizzly aperture size was reduced first to 100 mm and then to 80 mm. The scalping magnet was replaced with a stronger unit to reduce tramp material.

The crushing circuit operates at a nominal tonnage of 140 tph. The crushed material is transferred to two bins of 4,200 tonne capacity. Material can be directed to either of the two bins by the operator to improve plant blending ability.

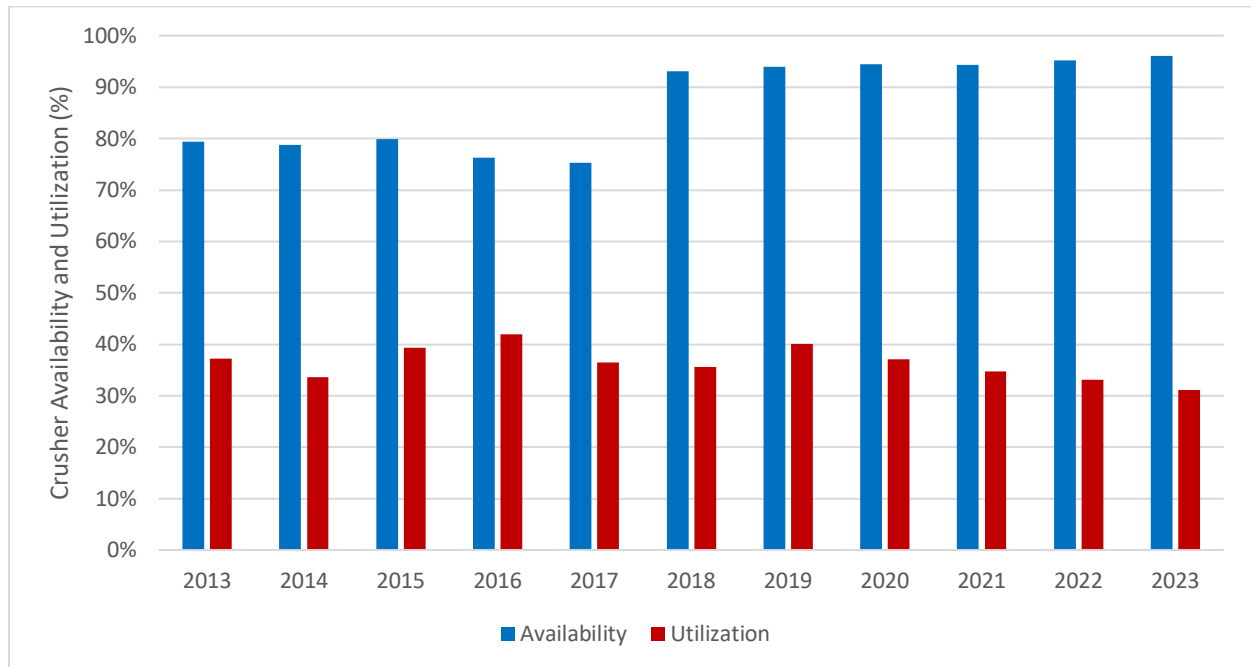

Figure 17-2: Crusher availability and utilization between 2013 and 2023

17.3.2 Grinding and Classification

The grinding circuit consists of a SAG mill, a ball mill, and a pebble crusher. Fresh mill feed particle size is 80% passing 90 to 100 mm. The particle size distribution of the cyclone overflow is 80% passing 53 μm . The 5.5 m \times 3.0 m grate discharge SAG mill is installed with a 1,500-kW variable speed motor. The SAG mill draws an average of 745 kW, corresponding to a motor load of about 50%. The grinding ball top size is 125 mm, and the ball charge ranges between 10% and 15%. The particle size distribution of the SAG mill discharge is approximately 80% passing 600 μm .

The pebble crusher is a short head cone crusher equipped with a 132-kW motor. Pebbles of 100% passing 70 mm are crushed to 80% passing 10 to 12 mm. The pebble crusher processes approximately 15% of the fresh mill feed in the form of pebbles.

The 3.6 m \times 6.0 m overflow ball mill is installed with a 1,500-kW variable speed motor. The mill draws typically an average of 891 kW, corresponding to a motor load of 59%. The mill operates using a grinding ball top size of 40 mm at typically 27% ball charge. Grinding media consumption is approximately 1.04 kg/t in the SAG mill and 1.37 kg/t in the ball mill.

The entire ball mill discharge is treated in a flash flotation cell of 10 m³ volume. The tailings of the column flotation cells are recirculated to the ball mill discharge pump box, and also treated in the flash flotation cell. The flash flotation tailings, SAG mill discharge, and the cleaner tailings are collected in a cyclone feed pump box and classified in a cyclone cluster. The cyclone cluster was

revised in April 2016, replacing three (2 operating, 1 standby) 381 mm hydrocyclones with eight (5 operating, 3 standby) 250 mm hydrocyclones. The new cyclone cluster includes a 49 mm apex and 90 mm vortex and gives better control of particle size in the overflow. The particle size distribution of the cyclone overflow is approximately 80% passing 54 µm.

17.3.3 Flotation

Gold in Efemçukuru ore is mainly associated with sulfide minerals, predominantly pyrite, galena, sphalerite, and trace amounts of chalcopyrite. Hence, the process plant is based on bulk sulfide mineral flotation and produces a gold concentrate containing bulk sulfide minerals. The flotation circuit consists of rougher / scavenger flotation for recovering gold-bearing sulfide minerals in the cyclone overflow, flash flotation for recovering liberated gold-bearing sulfide minerals from the ball mill discharge, cleaner flotation for upgrading rougher / scavenger concentrate and column flotation treating the flash concentrate and cleaner concentrate to produce the final gold concentrate. The type of flotation reagents, their dosages and addition points are given in Table 17-2.

The pulp pH is adjusted to about pH 8 by adding sulfuric acid solution to the hydrocyclone pump box. The copper sulfate (CuSO_4) and the sodium hydrogen sulfide (NaHS) are introduced into SAG mill discharge to the cyclone feed pump box. Copper sulfate is used as an activator for sphalerite flotation and pyrite. The sodium hydrogen sulfide is mainly used for surface cleaning of slightly oxidized sulfide minerals, particularly pyrite. The collector and promoter are added at two points, the ball mill discharge (flash feed) and the conditioning tank (where cyclone overflow is conditioned with flotation reagents). Sodium isobutyl xanthate (SIBX) is of moderate strength and works as the collector in bulk sulfide mineral flotation. In addition to SIBX, Aero 8045 is a dithiophosphate formulation promoter used to improve flotation of gold bearing sulfides. Both reagents are added to the ball mill discharge (prior to flash flotation) and to the conditioning tank before rougher / scavenger flotation. MX 505 is sometimes used in place of S8045 to reduce loss of gold from the final tailing when difficult ores are treated in the process plant. F-549 is used as the frother and added in two points in the flotation circuit. An anionic flocculant is used for dewatering the final concentrate and the final tailings.

Table 17-2: Reagent Types, Addition Points and Dosages in the Efemçukuru Flotation Plant

Reagent	Addition Point	Dosage (g/t) of fresh ore
pH Regulator (H ₂ SO ₄)	SAG Mill Discharge	1.7 kg/t
Activator (CuSO ₄ .5H ₂ O)	SAG Mill Discharge	31 g/t
Sulfidizer (NaHS)	SAG Mill Discharge	15 g/t
Collector (SIBX)	Conditioning Tank	71 g/t
	Ball Mill Discharge	
Promoter (Aero 8045)	Conditioning Tank	50 g/t
	Ball Mill Discharge	
Promoter (MX 505)	Conditioning Tank	20 g/t
Frother (OrePrep F-549)	Conditioning Tank	15 g/t
	Flash Flotation Feed Box	
Flocculant	Concentrate Thickener	44 g/t
	Tailing Thickener	

Characteristics of the flotation cells at Efemçukuru plant are given in Table 17-3. There is one flash cell of 10-m³ volume, six 20-m³ tank cells (rougher / scavenger flotation) and six 5-m³ tank cells (cleaner flotation) in the circuit. Two column flotation cells of 1.8 m diameter and 8 m height were installed in 2020 as the second and final cleaner flotation stage. The column cells are currently operated in parallel, although they can also be operated in series (where the concentrate of Column 1 is fed to the Column 2). The serial mode of operation is considered beneficial for the ore types with low gold and sulfur grades. Three stages of cleaner flotation could be applied in the serial mode to increase the grade of the final concentrate.

Table 17-3: Characteristics of the Efemçukuru Flotation Circuit

Flotation Cells	Flash Flotation	Rougher / Scavenger Flotation		Cleaner Flotation
	Dorr-Oliver 10 m ³	Wemco 20 m ³	Dorr-Oliver 5 m ³	Eriez
Cell Type	DO 10m ³ Flash	Wemco 20RT	DO 5RT	Column Cells (1.8m D x 8m H)
Number of Cells	1	6	6	2
Motor rpm	990	888	975	-
Rotor rpm	280	196	312	-
Effective Surface Area (m ²)	0.9	4.7	2.4	2.56
Launder Lip Length (m)	5.0	14.6	12.0	11.3
Impeller Diameter (mm)	500	762	400	-
Aspect Ratio	Cone Top and Bottom	0.71:1	1:1	-

Ball mill discharge combined with the tailing of the column flotation cells is treated in the flash flotation cell to recover the liberated gold bearing particles and minimize overgrinding. Tailings of the flash

flotation are circulated to the cyclone feed pump box. The cyclone overflow is treated in the rougher / scavenger flotation bank. Concentrate of the first two cells is upgraded in cleaner bank 1. The rougher / scavenger concentrate of the remaining cells (cell 3 to 6) is treated in cleaner bank 2. Concentrates of the two cleaner circuits are combined with the flash flotation concentrate and sent to the column flotation stage. The column concentrate is sent to the concentrate thickener as the final concentrate. Cleaner tailings are circulated back to the cyclone feed pump box. Tailings of the rougher scavenger bank are further treated in a gravity separation circuit, which consists of one Knelson centrifugal concentrator to minimize gold loss in the final tailing. Total residence times for flash flotation cell, rougher / scavenger bank, cleaner bank 1, cleaner bank 2, and column cells are approximately 5, 49, 20, 15 and 30 minutes, respectively.

Column flotation, as the third cleaner flotation stage, increases concentrate quality and reduces concentrate tonnage with negligible gold recovery loss. Hence, a project was initiated in late 2019 for design and installation of column flotation cells in the circuit. Based on mass balance and simulation studies performed using plant surveys and pilot scale column flotation tests, two flotation column cells of 1.8 m (diameter) × 8 m (height) were sized with a distributor as the feeder to the column cells. The two column flotation cells can be operated in parallel or in series as the third cleaner flotation stage depending on plant requirements.

17.3.4 Dewatering

The final concentrate is dewatered in a 5 m diameter high-rate thickener. An anionic type flocculant is used at 8 g/t dosage (based on equivalent fresh mill feed tonnage) to improve the settling rate of the solid particles. The concentrate slurry is first treated in a de-aeration tank prior to the thickener to reduce air entrainment and prevent the generation of froth at the surface of the thickener. The concentrate thickener produces an underflow of 55% w/w pulp density at approximately 5.0 – 6.5 tph capacity. The underflow is transferred to a surge tank of 58 m³ volume, which provides approximately 11 hours of residence time. The water recovered from the thickener overflow is sent to the process water tank. The solids content of the overflow water was significantly reduced after modifications (installing de-aeration tank, water sprays and revision of feed line) were made in 2017 – 2018.

The concentrate thickener underflow is further de-watered in a 1,500 mm × 1,500 mm filter press with 42 plates. A filter cake with moisture content of 8.5 to 11% is produced and shipped in big bags (approximately 1.5 tonne per bag).

Flotation tailings are fed to a 13 m diameter high-rate thickener, achieving a thickener underflow solids content of 55% w/w. An anionic flocculant is used at 10 g/t (based on equivalent fresh mill feed tonnage) for flocculation of the tailings particles. The thickener overflow is circulated to the flotation plant as process water. The thickener underflow is sent by a positive displacement diaphragm pump to a 246 m³ surge tank in the tailing filter plant, with 8.4 hours of residence time. A part of the tailings material is used for making paste for backfilling in the underground mine, and the remaining tailings are filtered and then dry stacked in the TSF. Three pressure filters of 1,500 mm × 1,500 mm size with 60 plates in each filter are used to produce dry stacked tailings of 16% moisture content.

Distribution of tailings between the TSF and paste plant (for underground backfill) are illustrated on an annual basis in Figure 17-3. Approximately 40% of the tailing is used as backfill material in the underground mine.

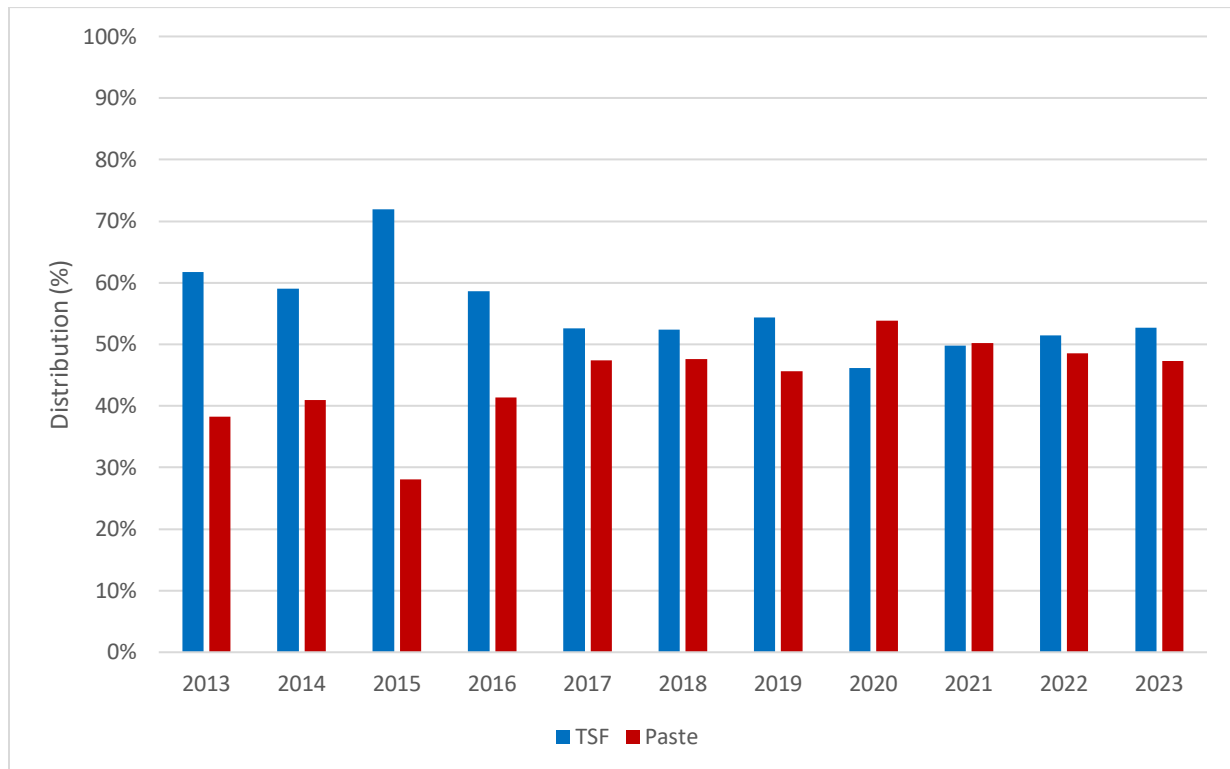

Figure 17-3: Distribution of Flotation Tailings to TSF and Paste Plant

17.3.5 Paste Backfill

In the paste backfill mode, thickened flotation tailings are pumped from the surge tank to the tailing filters by a dedicated positive displacement pump. The filters discharge directly onto the filter discharge conveyor and subsequently to the backfill delivery conveyor. This conveyor is reversible and can discharge either onto a stockpile or the paste backfill mixer feed conveyor.

The paste backfill mixer feed conveyor transfers the filtered tailings to the paste mixer. Paste components are directed to the feed chute of the paste mixer along with cement dosed at a proportion of the measured dry weight of the tailing solid. The cement addition is about 2.8 t/h for 35 dry t/h capacity and makes approximately 8% of the backfill material. The mixed paste discharges into a backfill paste hopper and from here the paste is pumped to the underground reticulation system.

The performance of the paste plant has improved with some modifications made since 2016. The paste mixer was replaced in 2016 with a larger unit with a 132-kW shaft motor and four 7.5 kW high-speed mixers to improve mixing of paste material. With this modification, the quality of the paste was improved and shut-down time for cleaning the mixer was significantly reduced. In 2017, in order to improve paste quality and minimize dust, a vortex mixer was installed and the cement feeder line was revised.

17.3.6 Process Water

Process water is supplied from the water treatment plant and from the two thickener overflows. The excess water is sent to the water treatment plant. The water treatment plant supplies clean water to the reagent preparation, pump gland water, thickener spray water, and other facilities. Process water is used in grinding, cyclone classification, flotation launder spray, flocculant dilution, and for general hose down requirements. The sulfide mineral content of Efemçukuru ore is relatively low and does not contain a significant amount of soluble mineral components affecting water quality. The flotation reagent scheme is also simple and does not have a major impact on process water quality. Therefore, process water is used without treatment and has no negative impact on flotation performance.

17.3.7 Operational Performance

Figure 17-4 shows availability and utilization of the flotation plant from 2013 to end of 2023. After commissioning and ramp-up periods, operational performance has increased to the expected levels in 2012. Availability and utilization of the flotation plant in recent years are 97.6% and 97.3%, respectively.

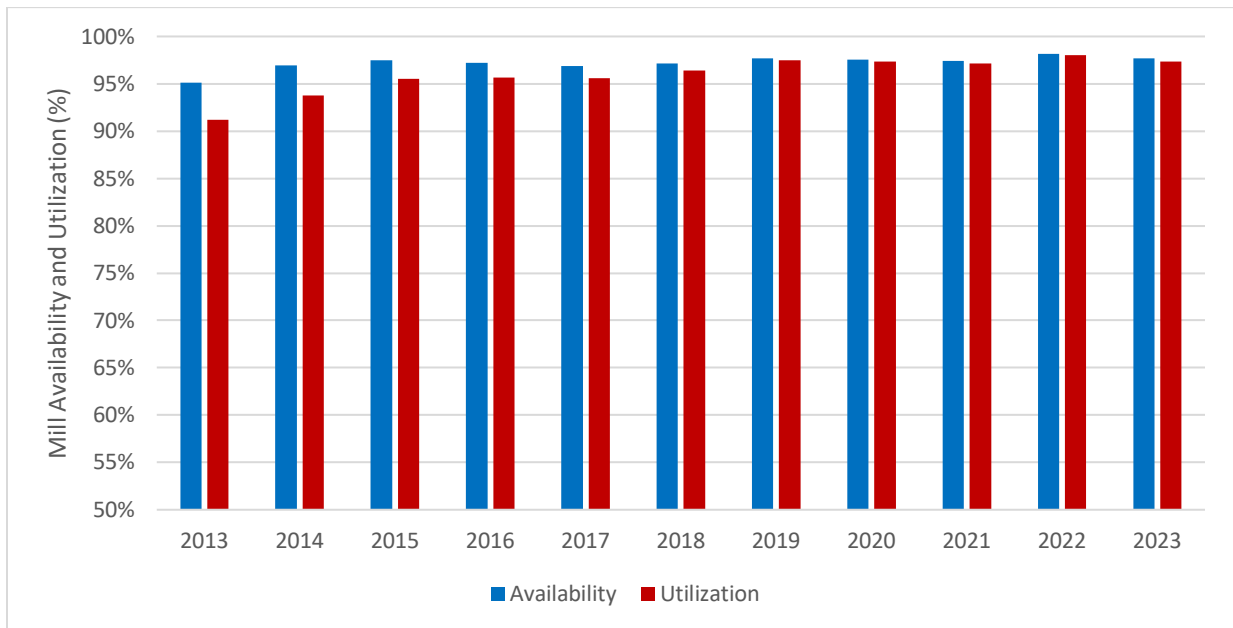

Figure 17-4: Availability and Utilization of Flotation Plant between 2013 and 2023

A summary of the production data from 2014 to the end of 2023 is presented in Table 17-4. Mill throughput has increased sharply after ramp-up period and continued to increase gradually throughout the mine life to over 545 kt per annum.

Table 17-4: Summary of Production Data between 2014 and 2023

	Unit	2014	2015	2016	2017	2018	2019	2020	2021	2022	2023
Milled ore tonnes	kt (dry)	437	455	477	482	499	521	524	528	545	547
Feed gold grade	g/t	8.34	7.82	7.40	7.01	6.77	7.03	6.76	6.51	5.82	5.64
Feed silver grade	g/t	13.3	20.8	14.9	20.9	19.8	19.3	20.8	18.1	15.6	19.7
Concentrate tonnage	kt (dry)	44.7	44.2	46.8	54.2	59.5	60.5	58.0	52.0	51.5	56.7
Concentrate gold grade	g/t	75	75	69	59	54	57	57	62	58	51
Concentrate silver grade	g/t	120	176	139	174	156	155	170	168	151	172
Recovered gold in concentrate	koz	108	106	104	102	103	111	106	104	96	93
Recovered silver in concentrate	koz	170	218	211	300	298	301	316	281	251	312
Gold recovery	%	93.3	93.7	93.0	94.6	94.6	94.0	93.5	93.6	93.6	93.0

The gold grade of the plant feed averaged about 8.0 g/t in the first four years of operation but has decreased gradually to 5.6 g/t in 2023. Unlike gold grade, silver grade increased from approximately 13 g/t to 20 g/t since 2015.

Gold grade of the concentrate ranges between 75 g/t and 87 g/t during 2011-2015 period and decreased gradually to approximately 54 g/t in the following years. The gold grade in the concentrate is influenced by the lower feed grade, and more importantly by the lower gold / sulphur ratio during recent years. The silver grade in the concentrate increased from about 120 g/t to approximately 170 g/t in parallel with its increased head grade in the flotation feed.

Annual average gold and silver production and gold recoveries are given in Table 17-4. Gold recovery has increased from 87% in the ramp-up period up to between 93.0% and 94.6% in recent years. This increase is closely related to better understanding flotation behaviour and improved mill availability / utilization.

SECTION • 18 PROJECT INFRASTRUCTURE

Efemçukuru gold mine consists of an underground mine with a process plant and ancillary facilities on surface. The mine is situated southwest of Izmir and is easily accessible by road. The site has local access to a large seaport in Izmir, an approximately 60 km drive from site, and an international airport in Menderes, an approximately 30 km drive from site. The surface infrastructure at the Efemçukuru site to support the mining and processing operations include the following:

- Site access roads
- Plant site roads
- Waste storage including two MRSFs and three TSFs
- Water treatment, supply and distribution
- Sewage collection and disposal
- Power supply and distribution
- Communications systems
- Ancillary facilities
- Diesel Storage

18.1 SITE ACCESS AND LOCAL ROADS

The access to site is from İzmir through regional paved and gravel roads. The roads are narrow and winding, with some isolated steep grades. However, the roads are paved, in good condition, and easily passable by commercial trucks.

The regional network west off the D550 highway near the Izmir Adnan Menderes Airport accesses the site via the İzmir-Görece-Menderes Yolu (highway) which turns into Atatürk Cd (road) in Menderes for 5.5 km from the D550.

The primary access is from Menderes. The following directions can be applied to reach the mine site.

- At the turnabout, turn right (west) onto Kuva-i Milliye Cd. (road).
- Continue for 600 m.
- Turn right onto and keep on straight on main roadway for 5.2 km including:
 - Dereköy Kümesi road, Mendere road, Yeniköy Yolu road
- Turn right onto the Çatalca bypass for 6.3 km, keeping straight join Çatalca road and continue for 5.3 km.
- Keep right at the junction to Efemçukuru Village and continue on Çatalca road for 2.2 km.
- Turn left onto the site road.

An alternative access to Izmir northeast of the site. The mine access road is a 2.7 km paved road from the regional network to the gate house at the plant site. The road is private access and includes a weighbridge (Figure 18-1).

During operations, flotation concentrate is bagged on site and a convoy of 40 tonne trucks haul the concentrate 25 km off site to a storage facility in Sarnıç daily. The concentrate is then transported to the port when the sale is recognized. A pilot vehicle leads the convoy and provides warning for oncoming vehicles. The convoys leave the plant at the same time each day so locals are aware.

18.2 SITE LAYOUT

The Efemçukuru mine site consists of the concentrator process plant; ancillary buildings; tailings filtration / backfill plant at the north portal; the filtered tailings storage facility (TSF); and mine rock storage facilities (MRSF); mine rock sedimentation pond (MRSP); and water collection (East) pond. The site layout was designed to limit the disturbed footprint, the amount of tree removal and to blend in with the surroundings. A range fence primarily for control of domestic and wild animals surrounds the entire site. The site excavations have balanced cut and fill quantities to limit aggregates and rock from off site sources.



Figure 18-1: Mine Main Access Road

The plant and ancillary buildings are along the Kokarpınar Stream with the waste facilities to the west in the valley above. The mine is access via three portals as shown in Figure 18-2.

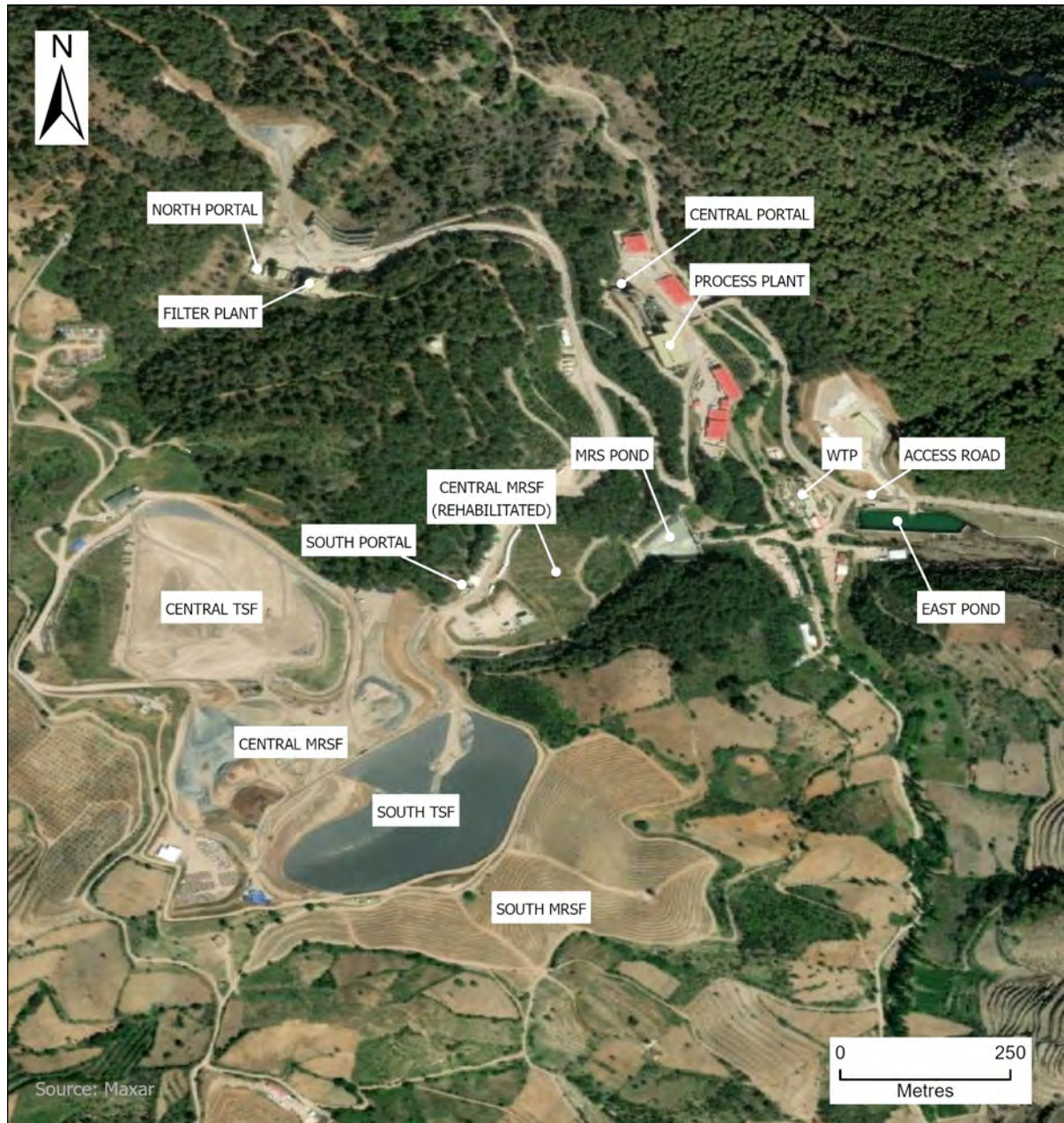

Figure 18-2: Project Layout (Eldorado 2023)

The plant site is located on the west side of the Kokarpınar valley at an elevation of 605 meters above sea level (masl). It consists of the ore storage bins, concentrator building, and ancillary facilities. The ore bins are fed from the underground crusher by a belt conveyor, which daylightes above the concentrator on a small pad with an access road to allow service vehicles. The site has been designed to limit the disturbed footprint by terracing the facilities into the topography to avoid large excavations. The location of the plant site lends itself to the utilization of the existing forestry

roads for access. The plant site drains to the catchment pond located at the north of the site. Water from the catchment pond is pumped to the water treatment plant.

Site roads were designed to follow the alignment of the existing exploration roads, where possible, to minimize site disturbance and removal of trees. The roads allow access from the plant to the filtration plant, the north portal, the development rock dump, the south portal, and filtered tailings storage. A haul road allows access from the filtration plant to the filtered tailings storage area. Internal roads are sealed for dust control. Figure 18-3 shows a general view of the mine site looking west.



Figure 18-3: General View of the Mine Site (Eldorado, September 2023)

18.3 SURFACE TAILINGS AND DEVELOPMENT ROCK MANAGEMENT

Mining waste within the scope of the Efemçukuru gold mine project consists of mine rock and process tailings, where tailings are dry stacked or used as cemented paste-fill. The MRSFs and TSFs are lined facilities and built pursuant to the provisions of the Mining Waste Regulation.

Within the borders of the operations area, there are two operating TSFs and two operating MRSFs. In addition, there is another TSF and another MRSF permitted for future use but not currently required to handle the reserves stated in this report.

The three dry TSF areas are referred to as the central TSF, south TSF (both operating), and north TSF (future expansion). The three MRSF areas are referred to as the central MRSF, south MRSF (operating) and north MRSF (future expansion). The 2015 EIA Report (subject to the EIA-Positive decision) presented three MRSF areas as central, south, and north, respectively; however, the central and south WRD areas were merged to establish the central MRSF area. The surface areas

of the storage facilities are given in Table 18-1. The total capacity of the central, south, and north dry TSFs is sufficient for approximately 2.4 Mm³ of dry tailings, whereas the total capacity of the central and south MRSF storage areas is sufficient for approximately 2.3 Mm³ of mine rock. The constructed facilities have storage capacity exceeding the planned mine rock and tailings amounts generated for mining and processing the reserves.

Table 18-1: Surface Areas of the Dry Tailings and WRD Storage Areas at Efemçukuru

Project Units	Area (ha)
Central TSF	6.64
South TSF	5.3
North TSF (future)	3.20
Central MRSF	8.2
South MRSF	4.5
North MRSF (future)	6.28

By the end of the mine's economic life cycle, an approximate 1.7 Mt of mine rock will be stored at the project site. While waste placement continues at the central MRSF storage area, rehabilitation of approximately 2 ha in the lower section has been accomplished in the recent years in compliance with the rehabilitation requirements of the MoEUCC.

By the end of the economic life of the mine, approximately 1.5 Mt of dry tailings will be stored in central and south TSFs. Additionally, mining waste facility licenses for the dry tailings storage facility located at the central valley were obtained from the General Directorate of Environmental Management under the MoEUCC. While tailings placement continues at the central TSF area, rehabilitation of approximately 4.33 ha (65%) has been accomplished in the recent years in compliance with the rehabilitation requirements.

Construction works in the south TSF were completed in 2019 and the south MRSF were completed in 2023 and approved by the MoEUCC. Construction works are not currently planned at the north TSF & north WRD areas.

The tailings storage design includes the following elements:

- Storage of dry stacked filtered tailings in a facility incorporating compacted tailings structural shells with 3H:1V (18°) outer slopes on the downstream and upstream sides of the facility to provide structural stability for the pile.
- Underdrain and base liner system comprised of a fully lined base, a central rock drain, and a toe drainage blanket to collect seepage from the tailings pile.
- Engineered closure cover system comprised of a synthetic cover over the tailings, overlain by a 1 m-thick store and release soil cover system.

The mine rock storage facility design includes the following design elements:

- Overall 3H:1V slope contoured to promote drainage, reduce erosion and to provide long-term stability.
- Underdrain and grouted / sealed foundation system below the liner to promote drainage of any collected water and limiting water infiltration into the underlying bedrock.
- Drain system over liner to collect mine rock pile seepage.
- Closure cover system comprised of a synthetic cover over the mine rock, overlain by a 1 m-thick store and release soil cover system.

The detailed design for the north TSF and MRSF areas will be completed during a subsequent stage of the Project if required. This design will incorporate information from the planned geotechnical site investigations in the area of the storage facilities, along with other relevant project information as it becomes available. The detailed design will also include staging plans for disposal, concurrent reclamation during the mining operations, and other design factors.

The Efemçukuru waste management practices and designs for the TSFs and MRSFs are cited numerous times as examples of best practice by the Joint Research Centre, the European Commission's in-house science service, in their science policy report "Best Available Techniques (BAT) Reference Document for the Management of Waste from Extractive Industries".



Figure 18-4: View of Tailings Area (Eldorado, September 2023)

Figure 18-4 shows the current activities in the disposal area looking west-northwest.

- Left side – nearly completed construction in South Mine Rock Storage Facility.
- Middle – completed South Tailings Storage Facility (open lined area).
- Upper middle - Central Mine Rock Storage Facility in operation (dark pile).
- Top – Central Tailings Storage Facility in operation with progressive closure.
- Right side – rehabilitated Central Mine Rock Storage Facility (below buildings).
- Lower – Tüprag vineyard.

18.4 FIRE / FRESH WATER SUPPLY STORAGE AND TREATMENT DISTRIBUTION

The plant site requires 75 m³ of water per hour, which is provided from mine dewatering, site collection, and recycled water from the process. Mine water is pumped from underground to the MRSP located below the lower portion of the central MRSF. The MRSP stores mine water (dewatering) and contact water collected by the diversion ditches around the perimeter of the project site. Mine and contact water stored in the MRSP is treated and used in the process with the excess water treated, tested, and released back to the environment or stored in the East Pond for use in the process when dewatering flows do not meet process requirements.

Prior to release to the environment, all contact water is fully treated. Discharge water quality, depending on parameter, is continuously monitored by online monitoring system or by sampling and analysis at frequencies identified in permit conditions to verify it is within the allowable effluent limits as set by the MoEUCC.

Figure 18-5 shows the MRSP (forefront of photo) and above the pond is the rehabilitated lower portion of the central MRSP. The South 676 Portal is located on the north side hill above the valley (top right side of photo). Filtered tailings storage is located further up the valley (not shown in photo). Figure 18-6 shows the East Pond looking west.



Figure 18-5: Mine Rock Sedimentation Pond (Eldorado, 2019)



Figure 18-6: East Pond (Eldorado, 2019)

The water treatment plant located on the southeast of the plant site supplies fresh-treated water to a fire and fresh water storage tank located on the hill above the process plant. Water from the storage tank is then distributed by gravity to the process plant. The freshwater tank serves double duty as storage of both fire and fresh water. Fire and fresh water reservoirs inside the tank are separated with the use of a standpipe inside the tank to draw off the fresh water off the top of the fresh water standpipe, assuring storage for fire water is maintained. Figure 18-7 shows a view of the water treatment plant.

The fire water distribution system consists of a dedicated buried firewater main and hydrant system for the plant site and ancillary buildings. Hose cabinets are placed within the process plant and ancillary facilities, supplemented by portable fire extinguishers in all facilities. Hose stations located at 50-m intervals and automatic sprinklers over the drive protect the underground conveyor. Ancillary buildings are equipped with automatic wet sprinkler systems and/or fire detection and alarm systems.

The hypochlorinator and two potable water storage tanks are located at the mill site. Each potable water tank has a capacity of 60 m³. Buried piping distributes potable water to the ancillary facilities. The potable water is suitable for general use in the facilities but not for consumption. A tanker truck supplies drinking water to a storage tank located at the process plant.

Emergency showers and eyewash stations are situated throughout the process building.



Figure 18-7: Water Treatment Plant (Eldorado, 2019)

18.5 SEWAGE COLLECTION AND TREATMENT

There are nearly 450 personnel employed at the site. Sewage and domestic wastewater resulting from the personnel and domestic ancillary facilities are treated in the wastewater treatment plant at a rate of approximately 47 m³ per day.

Sewage treatment is performed by a sequencing biological reactor (SBR). Solids are disposed off site at an approved facility.

18.6 WASTE DISPOSAL

There is a waste management system currently being used at the project site to monitor and report on collection and waste disposal. A dedicated disposal facility has a surface area of approximately 1.73 ha and allows temporary storage of domestic waste, packaging waste, electronic waste, scrap metals, and waste oils generated on the site (kitchen waste), as well as limited amounts of hazardous waste (used batteries, cartridges of photocopier, containers contaminated with chemicals, etc.). The area ensures various collected types of waste are segregated in different containers or areas so that waste is properly recycled or disposed of off-site. The area is isolated from other infrastructure and waste is protected from atmospheric conditions before disposal. The area facilitates the collection of

wastes and the recycling and recovering of material effectively and safely, offering environmental and economic benefits.

The municipality regularly collects all domestic wastes from the covered waste containers placed in designated areas around the site. Colour coded containers segregate different wastes and are covered to protect from wind and rain.

18.7 POWER SUPPLY AND ELECTRICAL DISTRIBUTION

18.7.1 General

The electrical system has been sized to account for the process loads, water treatment plant loads, mining loads, and the ancillary loads, such as the workshop / warehouse mine dry / canteen and administration building. The site has a connected load of approximately 16 MW and with an annual power consumption of approximately 48 GWh.

18.7.2 Power Supply

The existing power line is 34.5 kV, 50 Hz overhead pole line from the National Grid to the mine substation. The power line originates from the substation located at Çamlı village in the district of Urla, approximately 15 km to the west of the plant site. The substation has sufficient capacity to meet the mine's current and future needs.

There is a second substation available also near Çamlı village if required (Figure 18-8).



Figure 18-8: Power Line (Eldorado, 2019)

18.7.3 Site Power Distribution

The site layout shows the location of the incoming power line, main substation, and site power distribution. The following description of the plant site electrical distribution system is in accordance with the site electrical single line diagrams.

The incoming 34.5 kV overhead power line from the national grid has terminated at the main substation located at the north of the plant site. The main substation consists of a main disconnect, metering facilities, main transformer (34.5 / 6.6 kV, 10 MVA), and 6 × 6.6 kV feeder positions in a walk-in type outdoor rated enclosure. Distribution from the main substation location includes the following feeders:

- 6.6 kV power line extending north to provide power to the filter plant area (electrical room – ER4) and the north adit area (ER5), which supply underground facilities.
- 6.6 kV power line extending east to provide power to the concentrator building substation loads, including:
 - 6.6 kV grinding area motor loads in the concentrator building (ER3).

- 6.6 kV feeder cable to serve the low voltage loads in the concentrator building (ER3) and buildings adjacent to the concentrator building such as the administration, canteen, lab, and gatehouse buildings.
- 6.6 kV feeder cable to serve the low voltage loads in the mine dry, truck shop, and warehouse.
- 6.6 kV power line extending east to provide power to the water treatment plant substation loads including:
 - 6.6 kV feeder cable to serve the low voltage loads in water treatment, sewage treatment, project department, and contractor area.
 - 6.6 kV overhead power line extending east to west to provide power to air quality station and surface work office building.
- 6.6 kV feeder cable installed along the primary crusher conveyor structure to underground distribution which serves the primary crusher (ER1).
- 6.6 kV power line to provide power to the south portal and underground equipment (ER8).
- 6.6 kV power line to provide power to the HV compensation panel.

These rooms contain area low voltage motor control, control system cabinets, HVAC, lighting, and provision for power correction equipment where required. The electrical rooms are installed on concrete supports, where appropriate, and adjacent to structures where there are concentrations of electrical equipment requiring power and control.

Underground 400 V cables exit from ER3 location to provide power to the power distribution centers and motor control centers of the ancillary buildings. Motor control centers are complete with motor starters, contactors, disconnect switches, transformers, panels, circuit breakers, and fuses.

Stand-by generators are located around the site with enough power to supply for operation of emergency lighting and power essential drives in the event of power outages at site.

18.7.4 Electrical Equipment and Materials

All electrical equipment is rated for a minimum elevation of 750 masl, an ambient temperature range of 0°C to 40°C and is certified by Conformité Européenne (CE).

18.7.5 General Power and Lighting

Power outlets consist of 16 A, 220 V, 1 Phase, 50 Hz plug in receptacles for small tools, and 63 A, 400 V, 3 Phase, 50 Hz receptacles for welders and other heavy equipment. The lighting fixture types are:

- LED fixtures sized as required for lighting of the mill areas.
- Fluorescent and LED fixtures for office and electrical rooms.
- LED flood light fixtures mounted on the buildings for yard lighting.

18.7.6 Power and Control Cables

Distribution cables are aluminium-armoured polyvinyl chloride (PVC) jacketed, cross-linked polyethylene insulated conductors. Cables run from the electrical room to the electrical equipment and devices, mounted on cable tray / racking throughout the mill building and direct buried between buildings, unless otherwise noted.

18.8 COMMUNICATIONS

A communications network is existing with satellite technology for voice, fax, internet service and OT system networks.

18.9 ANCILLARY FACILITIES

The ancillary facilities were designed utilizing concrete panels and blockwork, as far as practical, to maximize the use of locally available materials and methods and to blend in with the local architecture. The following is a general description of the ancillary facilities included on the Efemçukuru site.

18.9.1 Process Buildings

The process buildings, including the concentrator building and filtration plant building, are structural steel buildings with concrete panel siding. The reagent and bag storage areas, electrical and mechanical rooms, and offices are located in a two-storey structure annexed to the main process building.

The concentrator building has a 20-t overhead crane servicing the grinding and flotation areas, and a 7.5t overhead crane servicing the reagent and concentrate storage areas. Figure 18-9 shows the process plant and crushed ore bins.



Figure 18-9: Process Plant and Crushed Ore Bins (Eldorado, 2019)

The filtration plant is located beside the North 656 Portal and on the side of the hill to utilize the topography.

Figure 18-10 is a view of the tailing filter / backfill plant and north portal looking south located in higher up the north valley.



Figure 18-10: Filtration Plant and North Portal (Eldorado, September 2023)

18.9.2 Laboratory

A laboratory does not exist on site. Laboratory services are provided by a provider in Izmir.

18.9.3 Workshop and Warehouse

The workshop and warehouse complex are a prefabricated concrete / blockwork building. The building has been designed to provide facilities for maintenance and repair.

The workshop and warehouse include two indoor truck bays, an outdoor wash bay, machine shop, welding shop, and electrical / instrumentation work area. Maintenance and planning personnel have offices located on the second floor.

The warehouse has 144 m² of indoor storage area and an outdoor fenced secure storage is included.

18.9.4 Administration Building

The administration building is approximately 500 m², including space for finance, accounting, and administration personnel. The General Manager also has an office in this building.

18.9.4.1 Mine Dry and Canteen

The mine dry is a three-storey building approximately 1,600 m² in area. The mine dry is equipped with lockers and baskets for 250 miners. The building includes offices for the mine manager, mine superintendent, geology manager and superintendent, technical office superintendent, engineering and geology groups, shift supervisors, and safety engineers. Additional rooms include a lamp room, a kitchen, guest rooms, and meeting rooms.

Figure 18-11 is a view of mine building beside south portal which includes mine dry, offices and mine control room. The canteen is approximately 540 m² with a kitchen to provide hot meals.



Figure 18-11: Mine Building beside South Portal (Eldorado, 2019)

18.9.4.2 Core Storage

Core is stored on site, the 1ha storage yard is on the southwest edge of the property is adjacent to the south TSF. The site includes a 90 m² complex for processing core.

18.9.4.3 Gatehouse

The main gatehouse is located at the access point to the plant site. It includes a reception area, a training room, and space for safety and security personnel.

18.9.4.4 Accommodation and Transportation

The personnel from Izmir and the surrounding communities are transported to the site by bus.

18.10 DIESEL STORAGE

Diesel is stored on site in tanks in areas with secondary containment. There is sufficient volume for a few days of operation. Supply is readily available from multiple sources with deliveries on an ongoing basis.

18.11 PORT OF İZMİR

The Port of İzmir is owned by the Turkish Government and operated by the Turkish State Railways, it is situated on the Gulf of İzmir and locate in Konak adjacent to İzmir. The port is a large facility handling approximately nine million tonnes of cargo annually. The port is used for both the import of materials required for the project and exporting concentrates.

SECTION • 19 MARKET STUDIES AND CONTRACTS

19.1 MARKET

19.1.1 Market Studies

Eldorado has been selling gold concentrate from the Efemçukuru operation since 2011, although no formalized market study was completed in respect to concentrate sales. The market for the Efemçukuru concentrate is well established with sales to refineries and market traders in Europe and Asia.

According to Article 168 of the Turkish Constitution, the Turkish Mining act amended and put into effect in August 2017, the Turkish Central Bank has the right to purchase all gold produced within Türkiye at London Metal Exchange spot prices.

19.1.2 Price

The price of gold is the largest single factor in determining profitability and cash flow from operations. The financial performance of the project has been, and will continue to be, closely linked to the price of gold. Reserves have been determined at a gold price of \$1,400 per troy ounce and a silver price of \$19 per troy ounce. The projected gold price is based on analysis of price projections from industry peers, investment banks, and analysts.

Figure 19-1 shows the price of gold over the last three years.

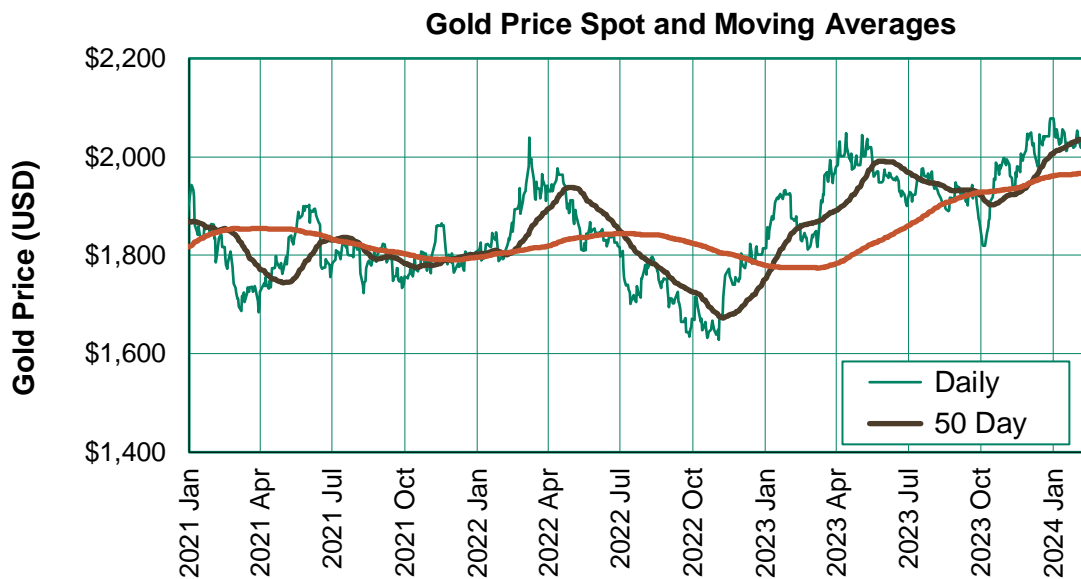

London Bullion Market Association daily closing price

Figure 19-1: Gold Price

19.2 CONTRACTS

Efemçukuru has no hedging in place for the sale of gold concentrate. There are a number of contracts in place for the sale of gold concentrate.

Contracts for sales of gold concentrate contain a range of settlement terms, generally based on the grade of gold contained within the concentrate and credit for silver, less penalties, for deleterious within the concentrate. Gold and silver sales are based on spot price.

All contracts in place are at market rates with terms and charges are within industry norms.

The Project is fully constructed with the exception of mine development which is self-performed, there are no existing or required contracts for Property development.

19.3 INCOME TAX

The current corporate taxation for Turkish corporations is 25%. There is a reduction of 5% on corporate tax rate with regards to earnings of export companies as 100% of concentrate from the Efemçukuru operation is exported. The Project also has existing tax incentives in place applied to the income tax which results in an effective corporate tax rate for the Project of 11%.

Depreciation is based on mine life use (reserves processed divided by remaining reserves) as per the Turkish tax code.

The QP has reviewed has analysed the assumptions that support the results of the technical report.

SECTION • 20 ENVIRONMENTAL STUDIES, PERMITTING AND SOCIAL OR COMMUNITY IMPACT

20.1 PERMITTING AND CERTIFICATIONS

The Efemçukuru site has received and maintained all permits required to operate within Türkiye.

Eldorado's comprehensive Environmental Impact Assessment (EIA) report received an Environmental Positive Certificate in September 2005. Tüpraş applied and received subsequent EIA amendment in 2015 to increase the mining ore production rate to 600,000 tonnes per annum. The EIA report presents the baseline studies performed since the 2000s. Potential impacts have been identified and sound mitigation measures are defined. A Cumulative Impact Assessment is included in 2015 EIA, prepared in line with International Finance Corporation's guidelines. Valued Ecosystem Components that may be affected by project activities were identified and included in environmental assessments. The report also proposed an Environmental Management Plan (EMP) and monitoring plan, to mitigate and monitor any impacts of the project. Data outlined in the EIA monitoring plan have been collected since the commissioning of the project and reported to the relevant government agencies on a semi-annual basis.

The Environmental Licence and Permit for the operation was renewed in June 2023 and is valid until June 2028. The permit covers air emissions, water emissions, environmental noise while the environmental license addresses the mining waste storage facilities.

Efemçukuru Gold Mine is ISO certified including:

- ISO 14001 (Environmental Management System),
- ISO 45001 (Occupational Health and Safety Management System), and
- ISO 50001 (Energy Management System).

ISO 14001 certificate was first obtained in 2012 and renewed in 2022. ISO 50001 certification was recently obtained in 2023.

An inspection and monitoring committee established by the local governor's office regularly visits Efemçukuru site. The purpose of the committee is to ensure that mining operations are conducted in compliance with the applicable laws, regulations, and EIA commitments. The committee, which has been conducting regular visits since September 2007, is composed of experts from various government agencies. During the inspections, water samples are collected from monitoring wells and surface water monitoring locations. These samples are analyzed in accredited laboratories, and the analysis results are regularly evaluated by the committee experts. Additionally, biannual soil samples are collected and analyzed from 17 separate locations around the site. The results are regularly evaluated by a soil commission. It is expected that inspections will continue during the closure period.



The Project is in compliance with the EIA commitments and permits granted, there are no environmental issues that would impact the ability to extract the mineral resources or mineral reserves.

20.2 AIR QUALITY

Efemçukuru is subject to the "Regulation on Control of Industrial Air Pollution " and "Regulation on Air Quality Assessment and Management" (AQAM) as legislated in Türkiye and published in the Official Gazette dated July 03, 2009, and June 06, 2008, respectively.

Air quality baseline measurements at and in the vicinity of the project area were conducted including all regulated pollutants during the EIA process and reported in the EIA Report. Potential air quality impacts due to the projects' construction and operational activities were assessed using AERMOD software for atmospheric dispersion modeling, and mitigation measures were identified in the EIA report. Emission inventory has been prepared and updated annually, including all active fixed and fugitive sources. A fugitive dust control plan has been developed and implemented at site together with an air quality monitoring plan.

Mitigation measures (such as the use of dust filters, road paving, speed limits, and water spraying on haul roads, at the crushers, and at conveyors) are undertaken to ensure compliance with AQAM limits. Regular maintenance and inspection of mobile equipment is conducted to reduce exhaust gas emissions. Air quality is monitored annually at ventilation shafts, including discharge rate, particulate matter, and heavy metals. A continuous air quality monitoring station is installed at site. All regulated pollutants including PM, PM10, PM 2.5, CO, NO_x and SO₂ are monitored, together with meteorological measurements. Monitoring of air quality at Efemçukuru and Kavacık villages is conducted using the high-volume dust collector, BAM-1020. Air quality monitoring results are in compliance with the regulatory air quality standards at site and villages in the vicinity of the project area. The monitoring results are reported regularly to the MoEUCC.



Figure 20-1: Continuous Air Quality-Monitoring Station

Noise monitoring is undertaken by the environmental department. Noise monitoring includes day and night periods. Results are reviewed to assess compliance with the Environmental Noise Control Regulation and reported to the MoEUCC regularly.

20.3 ENERGY AND GHG EMISSIONS MANAGEMENT

The Efemçukuru gold mine has an energy policy in place and is certified to ISO 50001. An Energy and Carbon Management (ECM) Leader, supporting the General Manager, monitors and reports on major sources of energy consumption and greenhouse gas (GHG) emissions. Regular monitoring and measurement for energy performance and GHG emissions are calculated and disclosed in Eldorado Gold Sustainability Reports. Mitigation targets have been established and are annually reviewed to comply with Eldorado Gold's commitment to reduce GHG emissions by 30% by 2030.

Various ECM programs have been implemented to reduce GHG. Ventilation on demand infrastructure has been installed in the underground mine, which reduced energy consumption and subsequent carbon emissions by 11%. Efemçukuru received a battery-electric transmixer in April 2022 as the project's first trial of electric equipment. Efemçukuru maintains a culture of continuous improvement by regularly reviewing the energy and carbon management system and working closely with cross-functional teams at site on energy-saving initiatives. Physical climate risk scenario analysis has been conducted by a third-party to understand physical climate-related risks and opportunities at site. At Efemçukuru, flash flooding caused by severe precipitation events is identified as a present-day risk. Wildfires at the site are also identified as a relevant hazard carrying



high risk in present and future conditions. The site seeks to design, construct, and operate water management and treatment facilities to withstand heavy rainfall. Water balance is maintained at site and processes and plans identified to manage water in accordance with regulatory requirements. Efemçukuru has a monitoring and management plan to assess forests and wooded areas surrounding sites, including continuous cleaning near the asset's fence line. The site also has firefighting equipment available, and personnel collaborate with local fire brigades. The site assesses the implementation of a formal weather forecast and early monitoring system for the site.

20.4 WATER MANAGEMENT

20.4.1 Water Supply

Water needed for the project is obtained exclusively from contact water from the following sources on site.

- Water generated by the moisture content of the aggregate ore.
- Groundwater pumped from the underground mine.
- Seepage and surface runoff collected from Tailings and Mine Rock Storage facilities.
- Water collected from mineral processing and surface facilities.
- Reuse water from dewatering of tailings and concentrate.

Contact water is sent to the water treatment plant and treated water is reused as process water. Bottled water is purchased for all site employees.

20.4.2 Geochemistry

Geochemical characterization of mining wastes and the classification of MRSFs and dry stacked TSFs were completed according to Regulation on Mining Waste and are outlined in the Efemçukuru Gold Mine Waste Management Plan (Mitto, 2018). The waste management plan was submitted to the MoEUCC and approved by the authorities in March 2018.

Mine rock has been subjected to extensive testing, including static testing (acid base accounting), whole rock analysis, mineralogical composition (XRD, XRF, Rietveld refinement analysis, optical microscopy, and selective electron microscope reviews), and kinetic testing. Static tests were performed on approximately 600 mine rock samples between 2004 and 2023. Test results indicated that approximately 83% of the samples tested contain less than 1% sulphide and average sulphide content is around 0.23%. The ratio of neutralization potential to acid potential (NP / AP) is greater than 1 in nearly 85% of the samples. A limited amount (approximately 20%) of the samples were acid-generating or potentially acid generating (PAG). Fourteen samples for kinetic testing were selected and tested (some up to a duration of 104 weeks), covering the whole range of sulfide content of the expected mine rock to be produced.

Most of the selected samples were chosen to have a NP / AP ratio below 1 and represent the 20% of PAG mine rock. Results indicate that pH levels between the environmentally acceptable values of 6.0 to 9.0 were observed in leach solutions; acidity and sulfate levels are low, and reactivity of sulphide minerals is low, while alkalinity is mostly produced from the carbonate minerals in the mine



rock. It was observed that the silicates also contributed to neutralization. Alkalinity is always higher than acidity, which is why the acidity occurring in the mine rock is immediately neutralized. Kinetic testing results verified that ARD potential identified will not be realized over time.

The neutralization potential of 80% of the mine rock greatly exceeds the acid generating potential of the remaining 20%. It is suggested that mixing and encapsulation of the 20% of PAG development rock with the non-acid generating (NAG) rock will utilize the available excess NP and neutralize any acidity formed. The waste rock with a potential for ARD (PAG) is mixed or macro-encapsulated with the NAG.

The mine rock has been classified under the Turkish mining regulations as "Wastes arising from metallic mining excavations" and is managed according to Regulation on Mining Waste Annex 4/C, which regulates inert mining waste conditions set by İzmir Directorate of Environment.

The dry tailings are categorized as a non-hazardous mining waste according to the results of Mining Waste Regulation Annex-3/A and Annex-3/B analyses. Static and kinetic tests were performed on a total of three dry tailing samples for the purpose of determining the geochemical characteristics of the dry tailings (ARD potential and metal leaching). Static test results shows that the samples do not have the potential for acid production and have a significant neutralization potential. Kinetic test results were compared against the limit values for Class-II (non-hazardous) facilities, pursuant to the regulation on landfill of wastes according to the MoEUCC. The dry tailings have no acid rock drainage potential and the heavy metal and trace elements observed in the kinetic tests do not exceed the limit values. For this reason, dry tailings are characterized as "non-hazardous" and classified as "mine wastes other than 01 03 04 and 01 03 05".

The dry stacked tailings storage facility (TSFs) and mine rock storage facility (MRSFs) have a base liner system to contain any contact seepage or surface runoff water. The contact water collected from the TSFs and MRSFs are collected and treated at the wastewater treatment plant during operation. TSFs were designed and constructed according to regulation on mining wastes. The construction permit file was prepared and approved by MoEUCC. Construction works are supervised by an accredited third party, with QA/QC reports prepared and submitted to the ministry. Construction activities approved and Category B Mining Waste Facility Environmental License has been granted for both the south and central TSFs by the MoEUCC. The MoEUCC approved progressive reclamation with grading and store-and-release cover placement is ongoing to reduce infiltration during and after construction of TSFs and MRSFs.

Environmental stability of the cemented paste backfill was evaluated by conducting a geochemical characterization program related to ARD and metal leaching potential. Results of the static testing suggest that cemented backfill has high neutralization capacity and is NAG. Results of the kinetic testing (humidity cell and flooded column) suggest that acidic conditions will not be generated over the long term. Soluble constituents will continue to be gradually depleted over time under steady state and geochemically stable conditions, maintaining the gradual decline in concentration for many parameters observed over the period of testing.

Baseline ground water quality was determined from groundwater monitoring data collected within the area of the current mine workings from February 1998 through May of 2011 by calculating the



95th percentile upper confidence limit (UCL95) of each monitored constituent using the USEPA-developed numerical code ProUCL (USEPA, 2007).

Due to the release of constituents from the cemented paste backfill, an evaluation of mine water quality was conducted using mass loading calculations. Geochemical controls, such as mineral precipitation and sorption that will limit dissolved concentrations in the mine water, were not taken into account. The results show that predicted concentrations in the mine water are only slightly elevated relative to the baseline groundwater concentration. The release of mass from the backfill is predicted to have little or no effect on the overall mine ground water composition.

Underground mine workings receive groundwater inflows during operation. Some of this inflow may contact acid generating rock and consequently contain dissolved metals. This water is pumped to the sediment pond and treated before being used as process water.

20.4.3 Water Management Plan

Site-level risks related to surface water and groundwater have been identified and assessed during the EIA and controls have been established and presented in EIA report. A site wide water management plan has been developed and maintained at Efemçukuru. The various elements of the water management plan include non-contact water diversions, contact water channels, sumps, ponds, and the water treatment plant.

Surface water management during construction and operation involves conveying mining and construction contact water to sedimentation ponds and, where possible, diverting non-contact water away from mining and construction activities to Kokarınar stream. Clean water diversion channels were constructed to divert non-contact surface runoff away from the mining facilities.

The contact water management system is designed to never release contact water, with the exception of controlled discharges that meet all regulatory requirements for surface water and groundwater protection. Contact water from surface facilities, TSF, and MRSF footprints are collected and sent to Mine Rock Sedimentation Pond (MRSP). Modelling of run-off quantities and contact water diversion channel and pond sizing was completed assuming the 100-year, 24-hour storm event. Groundwater inflows into the mine workings is collected at sumps within the underground and pumped to the MRSP. Contact water from the MRSP is sent to the water treatment plant and then treated water is used as process water or stored in the East Pond. When the water collected in these ponds surpasses the process requirement, they can be discharged after being treated in the treatment plant.

The wastewater treatment plant (WTP) is designed and permitted to treat contact water to meet water pollution control regulation discharge limits before contact water is discharged to the receiving environment. The WTP has an operational capacity of 12,240 m³/d. The effluent of the water treatment plant is subject to real-time, online independent monitoring by the MoEUCC. The wastewater generated by site personnel is treated separately in the sewage water treatment plant, which has a design flow of 47 m³/day. The quality of the discharge water from the sewage treatment plant within the mine site also complies with the provisions of the water pollution control regulations.



20.4.4 Monitoring

Baseline surface water and ground water quality is well documented in the EIA. A water monitoring program was developed addressing both surface water and groundwater, including water quality and quantity parameters in EIA Report. Site-level water quantity and water quality data is maintained and reported to the MoEUCC regularly.

Streamflow measurements have been collected since 1998 at two monitoring stations (Weir 1 and Weir 2) in Kokarpınar stream. On-going hydraulic head monitoring is conducted at monitoring wells by the environmental department in order to assess potential drawdown resulting from underground mine dewatering.

Within the scope of the monitoring program implemented in the construction and initial operation phases, the surface and ground water quality and quantity are monitored at the monitoring stations in a manner to allow identification of any possible impacts related to the project activities. Monthly water quality monitoring includes in-situ measurements, sampling, and analysis to ensure effectiveness of the mitigation measures.

Surface water and groundwater quality sampling is conducted by experts from Dokuz Eylül University's Geological Engineering and Environmental Engineering Departments. In-situ measurements are carried out at monitoring locations, and the water samples are taken and sent to accredited laboratories.

In-situ measurements and sampling at surface water monitoring locations (physical, chemical, and biological parameters) are carried out monthly along Kokarpınar stream.

Groundwater monitoring wells at site are used to observe groundwater levels and samples obtained to monitor the ground water quality. Groundwater monitoring well locations are selected based on groundwater flow directions at and around the site and approved by the State Hydraulic Works.

An inspection and monitoring committee visits the mine site every month and conducts regular audits of the operations to ensure compliance with environmental regulations. The committee takes soil and water samples which are sent for analysis to an accredited laboratory. The committee is comprised of experts and representatives of local government offices.

Monitoring results is reviewed and reported to the MoEUCC regularly.



Figure 20-2: Water Quality Monitoring

The parameters analyzed in surface water and ground water samples during the water quality tests include:

- Temperature.
- Electrical conductivity.
- Dissolved oxygen and pH, ORP.
- Total suspended solid (TSS) and total dissolved solids (TDS).
- Compound prevalence, including the following:
 - Carbonate (CO_3), bi-carbonate (HCO_3), hydrogen sulphide (HS), nitrite nitrogen ($\text{NO}_2\text{-N}$), ammonium nitrogen ($\text{NH}_4\text{-N}$), nitrate nitrogen ($\text{NO}_3\text{-N}$), sulphate (SO_4).
- Element prevalence, including the following:
 - Phosphorus (P), sodium (Na), calcium (Ca), magnesium (Mg), chloride (Cl), fluoride (F), aluminum (Al), arsenic (As), barium (Ba), cadmium (Cd), cobalt (Co), Copper (Cu), Iron (Fe), mercury (Hg), manganese (Mn), nickel (Ni), lead (Pb), selenium (Se), zinc (Zn), chromium (Cr), and hexavalent chromium (Cr^{+6}).

20.5 LAND USE

Land use within the concession area falls into three categories: agricultural land (vineyards), forestry land, and treasury land. Forestry land makes up about 80% of the project area (126.6 ha) and treasury land makes approximately 1%. The remaining area can be classified as private land. As of November 2023, Tüprag is the owner of 100% of the private land within the workplace opening permit area.

Progressive reclamation of the waste storage areas is ongoing in both the TSFs and MRSFs. As the waste storage areas are filled on a cell-by-cell basis, soil cover from the stored reserve is applied and a vegetation cover using native species is planted. At closure, only the last waste cells, the demolished building sites, and roadways will remain to be re-contoured, covered with the stored topsoil and seeded, or replanted with native species.

The success of re-vegetation will be monitored throughout the life of the Project and a limited post-closure period, allowing for supplementary seeding or planting if required. Adherence to the proposed land use management plan will ensure that the mix of plant species on the site will be restored and soil erosion prevented.

Reverse and restoration of the site to its current uses will depend on socio-economic conditions prevailing after closure.

20.6 BIODIVERSITY

The Efemçukuru project area is not located in a natural protection area.

Biodiversity baseline studies for the site were conducted in 1998, 2003-2004, 2011-2012 within the scope of EIA studies, and in 2014 within the scope of Cumulative Impact Assessment where endemism, threat status (IUCN Red list) of species, and vulnerable ecosystem components were identified. Biomonitoring studies have been conducted in 2021 and 2022 to identify key biodiversity features, critical habitats and prepare a Biodiversity Action Plan.

The Project is located on natural habitat(s), modified habitat(s), and critical habitat(s). Based on biodiversity studies and field surveys, *Lupinus anatolicus* (Anatolian Lupine) and *Squalius fellowesii* (Aegean Chub) were considered as a Species of Conservation Concern (SCC) and triggers critical habitat. No net loss (preferably net gain) is aimed for critical habitats, while for natural habitats no net loss of biodiversity where feasible through the design and implementation of mitigations measures will be achieved. Impacts will be minimized by implementation of mitigation hierarchy to conserve biodiversity values at modified habitats.

The Biodiversity Action Plan was prepared in 2022 and included the following elements:

- Key biodiversity features identified, including species of conservation concern, natural and modified habitat, critical habitat with stated ambition of no net loss.
- Endemism, threat status (red lists), and habitat type of species identified.
- Mitigation measures defined according to the mitigation hierarchy involving four stages:

- Avoid, minimize, restore, and offset.
- Monitoring measures identified to evaluate that the identified mitigation measures generate the expected results in avoiding or reducing potential impacts.
- Roles and responsibilities are assigned to site employees, contractors, and subject matter experts.

Effectiveness of the mitigation measures are monitored by external expert ecologists. To increase natural recovery rate at disturbed areas, the topsoil removed during site preparation and construction works is stored at the designated area within the mine site. Topsoil is used for progressive reclamation at MRSFs and TSFs, with 66% of the central TSF and 23% of the central MRSF reclaimed and monitored regularly by ecologists for vegetative cover stability and invasive species.

20.7 APPROVALS AND PERMITS

The process of obtaining the necessary permits for a mining operation in Türkiye is similar to the European Union EIA Directive process.

Table 20-1 lists key Project permits obtained prior and during mining to date, including the date and the governmental authority that issued them.

Table 20-1: Permits Obtained Prior to Mining and During Mining at Efemçukuru

Name of Permit	Issue Date	Issuer
Mining License	1999-04-20	Ministry of Energy and Natural Resources
Mining Operation License	2013-08-19	Ministry of Energy and Natural Resources
Mining Operating Permit	2013-08-19	Ministry of Energy and Natural Resources
Mining Exploration License	2022-07-19	Ministry of Energy and Natural Resources
EIA Permit	2005-09-08	MoEUCC
EIA Capacity Expansion Permit	2015-11-17	MoEUCC
Trial Permit	2011-06-01	Governor of İzmir
Workplace Opening Permit	2012-05-24	Governor of İzmir
Workplace Opening Permit	2013-02-27	Governor of İzmir
Workplace Opening Permit	2015-07-13	Governor of İzmir
Workplace Opening Permit	2016-03-18	Governor of İzmir
Workplace Opening Permit	2016-07-01	Governor of İzmir
Workplace Opening Permit	2023-11-09	Governor of İzmir
Environmental Permit and License	2012-07-12	MoEUCC
Environmental Permit and License	2015-01-30	MoEUCC
Environmental Permit and License	2017-01-19	MoEUCC
Environmental Permit and License	2018-04-27	MoEUCC
Environmental Permit and License	2019-05-16	MoEUCC
Environmental Permit and License	2020-11-18	MoEUCC
Environmental Permit and License	2023-06-19	MoEUCC

Name of Permit	Issue Date	Issuer
Mining Waste Management Plan Approval	2018-03-02	MoEUCC
Central TSF Closure Plan Approval	2018-07-19	MoEUCC
Forestry Permit Exploration Drilling	2006-07-12	Ministry Forest and Water Affairs
Forestry Permit Exploration Drilling Access Road	2006-07-12	Ministry Forest and Water Affairs
Forestry Permit Exploration Drilling	2007-04-17	Ministry Forest and Water Affairs
Forestry Permit Exploration Drilling Access Road	2007-12-31	Ministry Forest and Water Affairs
Forestry Permit Exploration Drilling	2007-12-31	Ministry Forest and Water Affairs
Forestry Permit Exploration Drilling Access Road	2011-04-11	Ministry Forest and Water Affairs
Forestry Permit Exploration Drilling	2011-04-11	Ministry Forest and Water Affairs
Forestry Permit Exploration Drilling Access Road	2013-03-14	Ministry Forest and Water Affairs
Forestry Permit Exploration Drilling	2013-03-14	Ministry Forest and Water Affairs
Forestry Permit Exploration Drilling Access Road	2017-05-04	Ministry Forest and Water Affairs
Forestry Permit Exploration Drilling	2017-05-04	Ministry Forest and Water Affairs
Forestry Permit Power Line	2010-12-22	Ministry Forest and Water Affairs
Forestry Permit Power Line	2017-05-04	Ministry Forest and Water Affairs
Forestry Permit Operation	2008-02-25	Ministry Forest and Water Affairs
Forestry Permit Operation	2010-07-28	Ministry Forest and Water Affairs
Forestry Permit Operation	2012-04-30	Ministry Forest and Water Affairs
Forestry Permit Operation	2017-05-04	Ministry Forest and Water Affairs
Forestry Permit Operation	2020-05-20	Ministry Forest and Water Affairs
Forestry Permit Operation	2020-02-17	Ministry Forest and Water Affairs
Forestry Permit Operation	2020-05-20	Ministry Forest and Water Affairs
Forestry Permit Operation	2020-05-20	Ministry Forest and Water Affairs
Forestry Permit Operation	2020-05-20	Ministry Forest and Water Affairs
Forestry Permit Operation	2020-05-20	Ministry Forest and Water Affairs
Purchase and Use of Explosive Certificate	2008-12-02	İzmir Security Directorate
Purchase and Use of Explosive Certificate	2009-12-31	İzmir Security Directorate
Purchase and Use of Explosive Certificate	2011-12-01	İzmir Security Directorate
Purchase and Use of Explosive Certificate	2014-11-18	İzmir Security Directorate
Purchase and Use of Explosive Certificate	2017-11-08	İzmir Security Directorate
Purchase and Use of Explosive Certificate	2020-11-18	İzmir Security Directorate
Purchase and Use of Explosive Certificate	2021-04-06	İzmir Security Directorate
Purchase and Use of Explosive Certificate	2023-11-17	İzmir Security Directorate
Underground Explosive Magazine	2013-09-18	İzmir Security Directorate
Energy Permitting	2010-06-21	TEDAŞ
Provisional Acceptance Certificate of Yelki Substation	2011-12-26	TEDAŞ
Provisional Acceptance Certificate (switchgear upgrade Yelki Substation)	2014-08-27	TEDAŞ
Provisional Acceptance Certificate of Mine Site Electrical Installation	2011-04-12	TEDAŞ
Provisional Acceptance Certificate of Bademler Substation	2011-03-21	TEDAŞ



Name of Permit	Issue Date	Issuer
Sewage Water Treatment Plant Design Approval	2010-06-25	MoEUCC
Wastewater Treatment Plant Design Approval	2010-05-13	MoEUCC
Wastewater Treatment Plant Design Approval	2013-11-13	MoEUCC
Wastewater Treatment Plant Design Approval	2018-07-25	MoEUCC
Private Security Permission	2010-12-24	Governor of İzmir
Temporary Solid and Hazardous Waste Storage Area Permit	2014-06-08	MoEUCC
Temporary Solid and Hazardous Waste Storage Area Permit	2020-04-28	MoEUCC

The Efemçukuru Project has received and maintained all permits required to operate within Türkiye. Discussions are regularly held with the local communities and there are no ongoing negotiations which would materially affect the Project or operations. There are no known environmental impacts that would limit the ability to extract the mineral resources or mineral reserves.

20.8 CLOSURE

Closure of the mine site is described in the EIA and EMP and has been approved by the MoEUCC.

The closure plan includes building and facility removal, waste disposal, recovery and neutralization and/or stabilization of mineral process solutions, regrading and recontouring of MRSF and TSF areas to safe stable slopes, placement of topsoil or suitable substitute growth medium where native topsoil is lacking, preparation of the reclaimed area for seeding and revegetation, seeding and transplanting of suitable native and agricultural plants for revegetation of disturbed areas, installation of fences to manage and protect rehabilitated areas from grazing, and irrigation of rehabilitated areas where appropriate.

Water treatment will remain operating to treat any contaminated seepage from the waste facilities until water is within allowable discharge limits.

The EMP includes long term monitoring of the Project after closure to ensure restorative measures are effective. Social economic programs will be implemented to assist with the transition from operation to a closure.

Progressive reclamation has been ongoing with lower section of the Central MRSF covered and vegetated, along with a large portion of the Central TSF.

Closure costs are allocated in the capital costs described in Section 21.

SECTION • 21 CAPITAL AND OPERATING COSTS

The capital and operating cost estimates presented in this Technical Study for Efemçukuru are based on feasibility-level estimates for the current producing operation centered around the mining of the Mineral Reserves. The estimate information is backed by thirteen years of operating and construction data from ongoing operations.

21.1 CAPITAL COST ESTIMATE

The total capital cost consists of \$50.55 million in sustaining capital and \$61.07 million in growth capital, as summarized in Table 21-1. Capital expenditures for mining, processing, and infrastructure were completed in 2011, prior to the start of production. All capital expenditures prior to December 31, 2023 are considered sunk costs and therefore not included in the economic evaluation. The mine is fully constructed and operating, and actual costs form the basis of future operating, sustaining capital, and growth capital cost estimates.

21.1.1 Mine Capital Cost

The mining sustaining capital costs include mine development, paste backfill borehole development and reticulation, purchase of additional equipment, equipment rebuilds, equipment leasing costs, and health and safety initiatives. In the process plant, sustaining capital includes rebuilds and minor upgrades to the plant equipment. General and administrative sustaining costs are for Information Technology upgrades and building maintenance. All costs are expressed in US dollars.

In addition to the sustaining costs listed, the economic analysis considers additional capital cost classified as growth capital. Growth capital primarily comprises the underground development and infrastructure required to extend the mining operations from the Kestanebeleni vein to the Kokarpinar and Batı vein systems.

Table 21-1: Capital Cost Summary by Year (in US\$ M)

Sustaining Capital	2024	2025	2026	2027	2028	2029	Total
Mine – Capital Development	2.36	2.22	3.27	3.03	3.24	0.38	14.50
Mine – Other	6.44	5.41	6.00	4.71	3.72	0.13	26.41
Process	2.45	2.43	1.70	0.88	0.29	-	7.75
General Administration	1.13	0.18	0.16	0.14	0.14	0.14	1.89
Sustaining Subtotal	12.38	10.24	11.13	8.76	7.39	0.65	50.55
Growth Capital	2024	2025	2026	2027	2028	2029	Total
Capital Development to KP and Batı	3.93	4.60	3.66	4.28	4.00	5.81	26.29
Infrastructure for KP and Batı	1.33	4.35	2.21	1.37	0.42	0.19	9.87
Resource Expansion and Conversion	1.48	6.30	7.00	8.00	1.00	-	23.78
Exploration	1.13	-	-	-	-	-	1.13
Growth Subtotal	7.87	15.26	12.87	13.65	5.42	6.00	61.07
Total Capital	20.24	25.50	24.01	22.41	12.81	6.65	111.62

No additional infrastructure is required on surface, the process plant and ancillary buildings are currently sized to support planned operations. Construction of both the new TMF and new MRSF were recently completed and have capacity to store all waste materials planned for mining and processing the life of mine reserves.

A majority of the sustaining capital is allocated to mining at 41% for sustaining mine development and infrastructure, 39% for mine equipment replacement and rebuilds, 15% for process requirements, and 4% for sustaining general and administrative costs.

Nearly all of the growth capital is essentially allocated to mining (98%) which includes all mine development and infrastructure required, exploration accounts for less than 2%.

21.1.2 Closure Costs and Salvage

Closure costs to cover and reclaim the MRSF and TSF areas, and to remove the infrastructure and reclaim the disturbed areas is estimated at \$9.75 million.

Salvage costs recovered from sale of the main process equipment, mobile mining equipment, and recyclable metals is estimated at \$3 million,

21.2 OPERATING COST ESTIMATE

21.2.1 Cost Estimate Basis

The average operating cost are estimated to be \$116.29/t or \$764.88/oz Au. Projected operating costs are summarized in Table 21-2. The costs shown reflect the operating costs associated with processing the reserves.

Table 21-2: Unit costs

Area	Unit Costs (\$/t)	Unit Costs (\$/oz Au)
Mining	43.76	288.70
Processing	35.09	231.50
G&A	37.09	244.69
Total	115.95	764.88

The underground mine operating costs were estimated based on actual 2023 operating costs and 2024 budget estimates that allow for maintaining a steady state production profile of 545 ktpa.

Underground operating costs include all consumables (ground support, explosives, services, cement, aggregates, and fuel) and equipment (LHDs, haul trucks, jumbos, etc.) required to meet the development and production schedule objectives. The operating unit costs for mobile equipment and fuel consumption rates were largely obtained from recent operating mine data. Labour requirements were developed to support the operation and maintenance of the fleet and for the general operation of the underground mine. All these estimates are based on current labour levels and planned additions.



G&A costs were estimated based on a projected personnel list, with salaries indicative of local standards and annual allowances for general supplies and support costs based off current costs.

Process operating costs were based on estimated annual consumption of process reagents, major wear parts, and utilities. Costs for supply of all consumables and utilities is based on current operational costs. Power consumption was calculated based on current electrical load lists.

Continuing the operations will utilize nearly the same labour, consumables, and utilities as the existing operations with minimal variations planned.

SECTION • 22 ECONOMIC ANALYSIS

Eldorado Gold, being a producing issuer, is not required to include information in this section as this Technical Report does not describe a material expansion of current production. Eldorado has performed an economic analysis related to the Efemçukuru operation using a gold price of \$1,700/oz and a silver price of \$20/oz, at the forecasted production rates, metal recoveries, capital costs, and operating costs estimated in this Technical Report. Eldorado confirms that the outcome is a positive cash flow that supports the Mineral Reserve estimate. Sensitivity analysis incorporating changes in metal prices, capital costs, and operating costs indicate robust economics.

The LOM plan shows that Efemçukuru has a production life of almost six years and can sustain a production rate of 545,000 tpa until 2029, based on the current Mineral Reserves.

The mine has the potential to extend this mine life through conversion of identified Inferred Resources, and through resource expansion with ongoing exploration activities.

SECTION • 23 ADJACENT PROPERTIES

The Property is located within the Cassandra mines complex which is comprised of a group of Hellas Gold mining and exploration concessions, covering 317 km². The other properties within the complex include Stratoni, which is currently on care and maintenance, and the Skouries copper gold porphyry deposit that is under development.

There are no other relevant adjacent properties.

SECTION • 24 OTHER RELEVANT DATA AND INFORMATION

24.1 LIFE OF ASSET STRATEGY

The mine planning team at Efemçukuru generated an extended mine plan, which included additional Inferred material to the Proven and Probable material.

Applying the same mine design criteria as described in Section 15, the MSO software was used to generate additional stope shapes from the inferred resources, indicating that there is an opportunity to extend minelife.

SECTION • 25 **INTERPRETATION AND CONCLUSIONS**

Efemçukuru has had a solid history of operational performance since production commenced in 2011. The mine has achieved and surpassed many metrics described in the previous technical report (Eldorado, 2019). Production tonnages and gold produced have exceeded earlier plans and the life of mine has been extended through resource expansion and conversion.

The geology of the Efemçukuru deposit is well understood. The deposit is an example of an intermediate sulfidation epithermal vein system. Diamond drill holes continue to be the principal source of geologic and grade data for the Efemçukuru mine, and the associated generated data is well managed and controlled by a robust QA/QC program and database management system. These systems demonstrate that the Efemçukuru data is sufficiently accurate and precise for resource estimation.

The Mineral Resource estimate used industry-accepted methods and were classified as Measured, Indicated, and Inferred Mineral Resources in accordance with the CIM Definition Standards for Mineral Resources and Mineral Reserves (May 10, 2014) that are incorporated by reference into NI 43-101. The current Measured and Indicated Mineral Resources remain at healthy levels due to exploration and conversion success.

The Mineral Reserve estimate used industry-accepted methods and were classified as Proven and Probable Mineral Reserves using the CIM Definition Standards for Mineral Resources and Mineral Reserves (May 10, 2014) that are incorporated by reference into NI 43-101. The cut-off grade was calculated from first principles and honors current and projected costs and mining factors. The current Mineral Reserves define almost six years of mine life, through to 2029.

Annual resource model to mill reconciliation has shown consistent excellent agreement between predicted (resource), planned (reserves) and processed tonnage and grades. This outcome demonstrates the steadfast high-quality level of both Mineral Resource and Reserve estimates.

The metallurgy and metal recovery values are well understood at Efemçukuru mine. The process plant has evolved to mill 545 ktpa with minimal capital outlay. Currently, the process plant produces a gold bearing bulk sulphide concentrate for sale to third party smelters. Continual improvement initiatives led to the planned implementation of column flotation to improve concentrate gold grade and overall quality while offering savings in less total concentrate tonnes being produced and transported.

The surface waste rock dump and dry stack tailings facilities continue to occupy quite small “footprints” while operating at high level standards with progressive closure ongoing. Water is tightly managed and controlled, all water is sourced from contact water, and any returned to the environment is passed through a water treatment facility.

It is concluded that the work completed in the Feasibility level assessment of the Efemçukuru reserves indicate that the exploration information, mineral resource, and Project economics are sufficiently defined to indicate the Project is technically and economically viable.

25.1 MINERAL RESOURCES AND MINERAL RESERVES

Information and data contained in or used in the preparation of Mineral Resource update were obtained from verified data and information from several surface diamond drill campaigns undertaken by Tüprag. It is the opinion of the qualified persons that the information and analysis provided in this report is considered sufficient for reporting Mineral Resources.

A test of reasonableness for the expectation of economic extraction was made on the Efemçukuru Mineral Resources by developing underground mine designs based on optimal operational parameters and gold price assumptions. An underground mine design was chosen to constrain Mineral Resources likely to be mined by underground mining methods. Eligible model blocks within this shell were evaluated at a resource cut-off grade of 2.5 g/t Au.

The Mineral Resource model was used as input for the Mineral Reserve estimate. The modelling methods, grade models, resource classification, and density model were reviewed and determined to be appropriate for the Mineral Reserve estimation. It is the opinion of the qualified persons that the information and analysis provided in this report is considered sufficient for reporting Mineral Reserves.

25.2 MINING METHODS

The existing underground mine supports the extraction of approximately 545 ktpa. Mining is conducted using a conventional fleet and mining methods, ventilation, dewatering systems, and electrical infrastructure are in place and will be expanded as necessary with on-going mine development.

25.3 METALLURGY

Production data and historical test work data was reviewed and provides a high degree of confidence in the process designs and the stated recoveries. Testwork has continued recently with samples from Kokarpınar and Batı veins.

25.4 PROCESSING AND PASTE BACKFILL

No additional process equipment is required to support the production plans outlined in this report.

25.5 TAILINGS AND MINE ROCK MANAGEMENT FACILITIES

All infrastructure required to store planned waste rock and processed tailings are in place on surface and have sufficient capacity to hold planned volumes for mining and processing the reserves stated in this report. No additional facilities are currently required.

25.6 ENVIRONMENTAL AND PERMITTING

All permits required to operate the mine through to the end of mine life as stated in this report are in place and will be maintained as required.

25.7 INFRASTRUCTURE

All support infrastructure on surface is existing with no additions required to support future operations. Mining infrastructure including ventilation, dewatering systems, electrical, communications, and mine refuge infrastructure are expanded or installed as part of normal mining development with no changes planned to existing practices.

25.8 CAPITAL & OPERATING COSTS, AND FINANCIAL MODELLING

The accuracy of the capital and operating cost estimates is consistent with the practices outlined by the Association for the Advancement of Cost Engineering for a feasibility study. The economic model has been built from first principles and includes all relevant data; the qualified persons have a high level of confidence in the stated economic performance of the Project.

Eldorado's forecasts of costs are based on a set of assumptions current as at the date of completion of this technical report. The realized economic performance achieved on the Project may be affected by factors outside the control of Eldorado, including but not limited to mineral prices and currency fluctuations.

25.9 RISKS AND OPPORTUNITIES

Risks and opportunities are evaluated on an ongoing basis as part of business planning for the Project. As the Project is very mature with significant data for the site and ongoing operations most of the risks and opportunities are around the new ore bodies geochemistry, geotechnical, and hydrogeological characteristics. The surface infrastructure is in operation with minimal changes for future operations.

25.9.1 Project Risks

As with most mining projects, there are risks that could affect the economic viability of the Project. Many of these risks are based on a lack of detailed knowledge and can be managed with additional sampling, testing, design, and engineering are conducted at higher levels of study.

The following table identifies what are currently deemed to be the most significant internal project risks, potential impacts, and possible mitigation approaches that could affect the technical feasibility, and economic outcome of the Project.

Table 25-1: Project Risks

Category	Description	Initial Risk	Future Controls	Residual Risk
Geology	Lower than expected reserves in new zones	Medium	Further delineation drilling	Low
Mining	Kokarpınar and Batı veins system production does not meet forecast	Medium	Further mine planning and evaluation of equipment and labour requirements	Low
Water Management	Increased water ingress in new zones	Low	Conduct further hydrology modelling and ensure site water balance is accurate	Low
Infrastructure	Increased distance to new mining zones creates high pipe pressures and line losses	Medium	Ensure paste recipe is suitable for long pumping distances, install additional protection system and rupture valves in specific areas.	Low
Geotechnical	Required paste backfill strengths not achieved	High	Ensure proper testwork and adequate design is carried out.	Medium
Ventilation	Blast clearing time is too long.	High	Modify ventilation infrastructure plan.	Low
Processing	Kokarpınar and Batı veins processing recovery lower than forecasted	Medium	Additional sampling and testing to verify recovery, adjustments to mine plans	Low
Mining	Seismicity	Low	Seismic monitors, ground control plan updates	Low
Geotechnical	Unexpected ground conditions in Kokarpınar and Batı veins	High	Ensure adequate drilling and sampling, ground control plan, QA/QC	Low
Environment	Tailings chemistry and ARD generation	Low	Additional testing and ensure water treatment and tailings management systems are adequate	Low

External risks are, to a certain extent, uncontrollable and difficult to anticipate and mitigate, although, in many instances, some risk reduction can be achieved. External risks are things such as the political situation in the Project's region, metal prices, exchange rates and government legislation. These external risks are generally applicable to all mining projects. Negative variance to these items from the assumptions made in the economic model would reduce the profitability of the mine and the mineral resource estimates.

The largest risk to the project economics is a decrease in gold price, project economics have been tested to \$1200/oz Au and the project economics remain positive. Escalation in costs (operating, sustaining capital, or growth capital) have impacts on project economics to a lesser extent than gold price. Sensitivities were completed in a range of +/- 20% and the project economics remain positive. Economics were tested with varying process recovery in a range of +/- 3% and maintained positive economics. Recovery is a reasonable proxy for mining grades, a test was completed with a 25% recovery loss and economics remained positive.

25.9.2 Project Opportunities

Opportunities that could improve the economics are largely based on future conversion of inferred resources, zone extensions at depth and along vein strikes, or new discoveries in untested areas. The major opportunities that have been identified at this time are summarized in Table 25-2. Further information and assessments are needed before these opportunities should be included in the Project economics.

Table 25-2: Opportunities

Category	Description	Outcome	Opportunity Level
Geology	Orebody resources continue at depth and laterally	Additional mine life and ounce production	Moderate
Geology	Conversion of Inferred Resources to Reserves	Additional mine life and ounce production	High
Geology	Discovery of new economic resources within project area	Additional mine life and ounce production	Moderate

SECTION • 26 RECOMMENDATIONS

26.1 GEOLOGY - EXPLORATION

Drill programs are recommended for continuing resource expansion and conversion with the following recommendations:

- Efemçukuru should continue with aggressive efforts to assess ancillary vein systems for new gold mineralization. This should consist of both surface and underground based programs.
- Near mine district options should also be reviewed.

26.2 MINING – PLANNING AND OPERATIONAL

Mining studies are recommended to evaluate the following:

- Ongoing evaluation of narrow vein mining methods to continue, as future ore becomes narrower.
- Optimize long hole drilling accuracy (via operational practice and/or equipment selection) to minimize dilution and ore loss in sill pillar extraction levels (i.e., underneath previously backfilled levels), as future mining will have an increased amount of such levels due to production block depletion and advancement towards one another (refer to Section 16.2). Evaluate the use of technological advances, such as mechanical rock excavation units based on the continuous mining technology. The continuous mining technology allows for rapid advancement of development headings and selective extraction of irregular narrow vein orebodies without drilling and blasting.

26.3 METALLURGY AND PROCESSING

Bulk flotation of gold and sulfide minerals has been successfully operated since the process plant was commissioned in 2011. Bulk flotation testing will continue in the following areas:

- Current plant throughput is about 30% over the original design. Impacts of coarser grind size and shorter flotation retention time on flotation gold recovery and concentrate quality need to be determined.
- At present, rougher / scavenger concentrate is not reground. Effect of regrinding on the final concentrate quality should be investigated.
- Dilution of mine waste rocks in the mill feed remains high due to mining in the narrow ore zones. Techniques to reduce dilution should continue to be investigated.
- Non-sulfidic gangues in the final concentrate should be below 20% when the concentrate is adequately cleaned, although this benchmark has not always been achieved during operation. Larger amounts of non-sulfidic gangues in the concentrate means lower gold grade and lower sulfur content, both of which affect concentrate marketing and values unfavourably.

- Research into the viability of selective sequential flotation to help minimize deleterious element content should also be ongoing. If successful, pre-concentration of some of these elements, like the base metals (lead and zinc), may not only minimize potential penalty charges but create a saleable product.

26.4 SUSTAINABILITY STUDIES

Continue studies and programs to maintain permits and social license are recommended to include:

- Biodiversity gap analysis
- Additional water monitoring well
- Probabilistic water balance study
- Asset retirement obligations and closure studies

26.5 BUDGET

Below is a description of the recommended steps in the continued advancement of the operation, Table 26-1 summarizes each item and its estimated cost. Costs are budgeted and included in capital cost evaluations.

Table 26-1: Study Budget

	Item	Cost US\$
26.1	Geology and exploration programs	\$24.9 M
26.2	Mine planning and operational improvement studies	\$0.4 M
26.3	Metallurgical and processing improvement studies.	\$0.1 M
26.4	Sustainability and closure studies	\$0.7 M
	Total	\$26.1 M

SECTION • 27 REFERENCES

Baker, T., 2019, Gold±Copper Endowment and Deposit Diversity in the West Tethyan Magmatic Belt, Southeast Europe: Implications for Exploration: *Economic Geology*, v. 114 (7), pp. 1237-1250.

Boucher, K., 2016, The structural and fluid evolution of the Efemçukuru epithermal gold deposit, western Turkey: M.Sc thesis, Vancouver, BC, Canada, The University of British Columbia, 466p.

Dilek, Y. and Altunkaynak, Ş., 2009, Geochemical and temporal evolution of Cenozoic magmatism in western Turkey: mantle response to collision, slab break-off, and lithospheric tearing in an orogenic belt: *Geological Society, London, Special Publications*, v. 311, p. 213-233.

Eldorado, 2019, Technical Report on the Efemçukuru Project, December 2019.

Ersoy, Y.E., Helvacı, C. and Sözbilir, H., 2010, Tectono-stratigraphic evolution of the NE–SW trending superimposed Selendi basin: Implications for late Cenozoic crustal extension in Western Anatolia, Turkey: *Tectonophysics*, v. 488, p. 210-232.

Gessner, K., Markwitz, V. and Güngör, T., 2017, Crustal fluid flow in hot continental extension: tectonic framework of geothermal areas and mineral deposits in western Anatolia: *Geological Society, London, Special Publications*, v. 453, p. 1-23.

JKTech, 2023, SMC Test® Report on Two Samples from Efemçukuru Project, JKTech Job No. 23001/P61., work carried out and reported to Tüpraş Efemçukuru.

Menant, A., Jolivet, L., Tuduri, J., Loiselet, C., Bertrand, G. and Guillou-Frottier, L., 2018, 3D subduction dynamics: A first-order parameter of the transition from copper- to gold-rich deposits in the eastern Mediterranean region: *Ore Geology Reviews*, v. 94, p. 118-135.

Okay, A.İ., Zattin, M. and Cavazza, W., 2010, Apatite fission-track data for the Miocene Arabia Eurasia collision: *Geology*, v. 38, p. 35-38.

Sillitoe, R.H., and Hedenquist, J.W., 2003, Linkages between volcanotectonic settings, ore-fluid compositions, and epithermal precious metal deposits: *Society of Economic Geologists, Special Publication 10*, p. 315–343.

Simmons, S.F., White, N.C., and John, D.A., 2005, Geological characteristics of epithermal precious and base metal deposits: *Economic Geology 100th Anniversary Volume*, p. 485–522.

van Hinsbergen, D.J., 2010, A key extensional metamorphic complex reviewed and restored: the Menderes Massif of western Turkey: *Earth-Science Reviews*, v. 102, p. 60-76.

Wardrop Engineering Incorporated, 2007, Technical Report on the Efemçukuru Project, NI 43-101 Technical Report, August 2007.

SECTION • 28 DATE AND SIGNATURE PAGE

Date and Signature Page

The effective date of this report entitled “Technical Report, Efemçukuru Gold Mine, Turkey” is December 31, 2023. It has been prepared for Eldorado Gold Corporation by David Sutherland, P.Eng., Mike Tsafaras, P.Eng, Peter Lind, P.Eng., Ertan Uludag, P.Geo., and Sean McKinley P.Geo., each of whom are qualified persons as defined by NI 43-101.

Signed the 27th day of March, 2024.

“Signed and Sealed”

David Sutherland

David Sutherland, P. Eng.

“Signed and Sealed”

Mike Tsafaras

Mike Tsafaras, P. Eng.

“Signed and Sealed”

Peter Lind

Peter Lind, P.Eng.

“Signed and Sealed”

Ertan Uludag

Ertan Uludag, P. Geo.

“Signed and Sealed”

Sean McKinley

Sean McKinley, P. Geo.



CERTIFICATE OF QUALIFIED PERSON

David Sutherland, P. Eng.
1188 Bentall 5, 550 Burrard St.
Vancouver, BC
Tel: (604) 601-6658
Fax: (604) 687-4026

Email: david.sutherland@eldoradogold.com

I, David Sutherland, am a Professional Engineer, employed as Senior Manager, Projects and Technical Studies, of Eldorado Gold Corporation located at 1188 Bentall 5, 550 Burrard St., Vancouver in the Province of British Columbia.

This certificate applies to the technical report entitled *Technical Report, Efemçukuru Gold Mine, Türkiye*, with an effective date of December 31, 2023.

I am a member of the Engineers & Geoscientists of British Columbia. I graduated from the Lakehead University with a Bachelor of Science (Physics) in 2003 and a Bachelor of Engineering (Mechanical) in 2005.

I have practiced my profession continuously since 2005. Since receiving my profession designation, I have worked exclusively on the design of mineral processing plants, assisted on numerous NI43-101 studies and have directed engineering and procurement on three mineral processing projects through construction. For 30 years I have been working in heavy industry including operations, maintenance and construction. During this time, I have led the design and construction of major greenfield and brownfield construction projects in Canada, Turkey, and Greece.

As a result of my experience and qualifications, I am a Qualified Person as defined in National Instrument 43-101.

I have visited the Efemçukuru Gold Mine on numerous occasions with my most recent visit occurring on November 8, 2023 (1 day).

I was responsible for the overall preparation of the technical study and sections related to infrastructure and environment of the technical report. I am responsible for the preparation or supervising the preparation of items 1, 2, 3, 4, 5, 6, 18, 20, 24, 25, 26, and 27 in the technical report.

I have had continual prior involvement with the property that is the subject of the technical report.

I am not independent of Eldorado Gold Corporation in accordance with the application of Section 1.5 of National Instrument 43-101.

I have read National Instrument 43-101 and Form 43-101F1 and the items for which I am responsible in the technical report entitled, *Technical Report, Efemçukuru Gold Mine, Türkiye*, with an effective date of December 31, 2023, has been prepared in compliance with same.

As of the effective date of the technical report, to the best of my knowledge, information and belief, the items of the technical report that I was responsible for contain all scientific and technical information that is required to be disclosed to make the technical report not misleading.

Dated at Vancouver, British Columbia, this 27th day of March, 2024.

“Signed and Sealed”

David Sutherland

David Sutherland, P. Eng.

CERTIFICATE OF QUALIFIED PERSON

Peter Lind, P.Eng.
1188 Bentall 5, 550 Burrard St.
Vancouver, BC
Tel: (604) 601-6658
Fax: (604) 687-4026

Email: peter.lind@eldoradogold.com

I, Peter Lind, am a Professional Engineer, employed as Vice President, Technical Services of Eldorado Gold Corporation and reside at 999 West 38th Ave, Vancouver in the Province of British Columbia.

This certificate applies to the technical report entitled *Technical Report, Efemçukuru Gold Mine, Türkiye*, with an effective date of December 31, 2023.

I am a member of the Ordre des ingénieurs du Québec and Engineers & Geoscientists British Columbia. I graduated from Laurentian University with a Bachelor of Engineering in Extractive Metallurgy in 2002, a Bachelor of Commerce from the University of Windsor in 2006, and an MBA from Simon Fraser University in 2017.

I have practiced my profession continuously since 2002 and have been involved with mineral processing and metallurgical operations and development projects in Canada, the United States, Mexico, Chile, Peru, Argentina, Tanzania, Greece, and Türkiye.

As a result of my experience and qualifications, I am a Qualified Person as defined in National Instrument 43-101.

I have visited the Efemçukuru Gold Mine on numerous occasions with my most recent visit occurring on March 30, 2023 (1 day).

I was responsible for the preparation of the sections in the technical report that dealt with metallurgy and process operations, costs and payability. I am responsible for the preparation or supervising the preparation of items 13, 17, 19 and 21 in the technical report.

I have had continual prior involvement with the property that is the subject of the technical report.

I am not independent of Eldorado Gold Corporation in accordance with the application of Section 1.5 of National Instrument 43-101.

I have read National Instrument 43-101 and Form 43-101F1 and the items for which I am responsible in the technical report entitled, *Technical Report, Efemçukuru Gold Mine, Türkiye*, with an effective date of December 31, 2023, has been prepared in compliance with same.

As of the effective date of the technical report, to the best of my knowledge, information and belief, the items of the technical report that I was responsible for contain all scientific and technical information that is required to be disclosed to make the technical report not misleading.

Dated at Vancouver, British Columbia, this 27th day of March, 2024.

“Signed and Sealed”

Peter Lind

Peter Lind, P.Eng.

CERTIFICATE OF QUALIFIED PERSON

Mike Tsafaras, P.Eng.
1188 Bentall 5, 550 Burrard St.
Vancouver, BC
Tel: (604) 601-6658
Fax: (604) 687-4026
Email: mike.tsafaras@eldoradogold.com

I, Mike Tsafaras, am a Professional Engineer, employed as Director, Underground Mine Planning of Eldorado Gold Corporation located at 1188 Bentall 5, 550 Burrard St., Vancouver in the Province of British Columbia.

This certificate applies to the technical report entitled *Technical Report, Efemçukuru Gold Mine, Türkiye*, with an effective date of December 31, 2023.

I am a member of Professional Engineers of Ontario and have graduated from the University of Toronto with a Bachelor of Applied Science and Engineering degree in Mineral Engineering (Mining) in 2007.

I have been practicing mining engineering since 2007 and have been involved with mine planning and mine technical work for operations and development projects in Canada, Australia, Tanzania, Saudi Arabia, Peru, Greece, and Türkiye. My experience includes mine design, scheduling, optimization, cost estimation, cutoff calculations and Reserves estimation for a variety of orebodies (gold, copper, and polymetallic deposits) and mining methods (longhole, alimak, drift and fill, and cut and fill).

As a result of my experience and qualifications, I am a Qualified Person as defined in National Instrument 43-101.

I have visited the Efemçukuru Gold Mine on March 27 to March 30, 2023 (4 days).

I was responsible for the Mineral Reserves and the preparation of related sections on Mineral Reserves calculation, mining methods, and costs of the technical report. I am responsible for the preparation or supervising the preparation of items 15, 16, 21 and 22 in the technical report.

I am not independent of Eldorado Gold Corporation in accordance with the application of Section 1.5 of National Instrument 43-101.

I have read National Instrument 43-101 and Form 43-101FI and the items for which I am responsible in the technical report entitled, *Technical Report, Efemçukuru Gold Mine, Türkiye*, with an effective date of December 31, 2023, has been prepared in compliance with same.

As of the effective date of the technical report, to the best of my knowledge, information and belief, the items of the technical report that I was responsible for contain all scientific and technical information that is required to be disclosed to make the technical report not misleading.

Dated at Vancouver, British Columbia, this 27th day of March, 2024.

“Signed and Sealed”

Mike Tsafaras

Mike Tsafaras, P.Eng.



CERTIFICATE OF QUALIFIED PERSON

Sean McKinley, P.Ge.
1188 Bentall 5, 550 Burrard St.
Vancouver, BC
Tel: (604) 601-6658
Fax: (604) 687-4026
Email: Sean.McKinley@eldoradogold.com

I, Sean McKinley, am a Professional Geoscientist, employed as Manager, Geology & Advanced Projects of Eldorado Gold Corporation and reside at 2231 Bellevue Ave, Coquitlam in the Province of British Columbia.

This certificate applies to the technical report entitled *Technical Report, Efemçukuru Gold Mine, Türkiye*, with an effective date of December 31, 2023.

I am a member of the Engineers & Geoscientists British Columbia (formerly the Association of Professional Engineers and Geoscientists of British Columbia). I graduated from Queen's University in Kingston, Ontario with a Bachelor of Science (Honours) degree in geology in 1992 and subsequently obtained a Master of Science degree in geology from the University of British Columbia.

I have practiced my profession continuously since 1996 and have been involved in: mineral exploration (both greenfields and brownfields), mine geology (underground and open pit settings) and geological modelling on gold, copper, lead, zinc and silver projects in Canada, Ireland, Sweden, China, Mexico, Romania, Greece and Turkey.

As a result of my experience and qualifications, I am a Qualified Person as defined in National Instrument 43-101.

I have visited the Efemçukuru Gold Mine on numerous occasions with my most recent visit occurring on February 3, 2023 (1 day).

I was responsible for the preparation of the sections in the technical report concerned with geological information, exploration, and drilling. I am responsible for the preparation or supervising the preparation of items 7, 8, 9, 10 and 23 in the technical report.

I have had continual prior involvement with the property that is the subject of the technical report.

I am not independent of Eldorado Gold Corporation in accordance with the application of Section 1.5 of National Instrument 43-101.

I have read National Instrument 43-101 and Form 43-101F1 and the items for which I am responsible in the technical report entitled, *Technical Report, Efemçukuru Gold Mine, Türkiye*, with an effective date of December 31, 2023, has been prepared in compliance with same.

As of the effective date of the technical report, to the best of my knowledge, information and belief, the items of the technical report that I was responsible for contain all scientific and technical information that is required to be disclosed to make the technical report not misleading.

Dated at Vancouver, British Columbia, this 27th day of March, 2024.

“Signed and Sealed”

Sean McKinley

Sean McKinley, P.Ge.

CERTIFICATE OF QUALIFIED PERSON

Ertan Uludag, P.Geo.
1188 Bentall 5, 550 Burrard St.
Vancouver, BC
Tel: (604) 601-6658
Fax: (604) 687-4026
Email: ertan.uludag@eldoradogold.com

I, Ertan Uludag, am a Professional Geoscientist, employed as Manager, Resource Geology of Eldorado Gold Corporation and reside at 6779 Kitchener Street V5B2J8 Burnaby in the Province of British Columbia.

This certificate applies to the technical report entitled *Technical Report, Efemçukuru Gold Mine, Türkiye*, with an effective date of December 31, 2023.

I am a member of the Engineers & Geoscientists British Columbia (formerly the Association of Professional Engineers and Geoscientists of British Columbia). I graduated from Middle East Technical University in Ankara Turkey with Bachelor of Science in Geological Engineering in July 1994.

I have practiced my profession continuously since 1996. I have been involved in ore control, mine geology and resource modelling work on gold, copper, zinc, lead and silver underground and open pit properties in Turkey, China, Greece, Canada and Romania, and rock mechanics in South Africa.

As a result of my experience and qualifications, I am a Qualified Person as defined in National Instrument 43-101.

I have visited the Efemçukuru Gold Mine on numerous occasions with my most recent visit occurring on June 21, 2023 (1 days).

I was responsible for the mineral resources and the preparation of related sections on sample preparation and analyses, data verification, and mineral resource estimation for the technical report. I am responsible for the preparation or supervising the preparation of items 11, 12 and 14 in the technical report.

I have had continual prior involvement with the property that is the subject of the technical report.

I am not independent of Eldorado Gold Corporation in accordance with the application of Section 1.5 of National Instrument 43-101.

I have read National Instrument 43-101 and Form 43-101FI and the items for which I am responsible in the technical report entitled, *Technical Report, Efemçukuru Gold Mine, Türkiye*, with an effective date of December 31, 2023, has been prepared in compliance with same.

As of the effective date of the technical report, to the best of my knowledge, information and belief, the items of the technical report that I was responsible for contain all scientific and technical information that is required to be disclosed to make the technical report not misleading.

Dated at Vancouver, British Columbia, this 27th day of March, 2024.

“Signed and Sealed”

Ertan Uludag

Ertan Uludag, P.Geo.