

**NI 43-101 Technical Report
Preliminary Economic Assessment
Gabbs Heap Leach and Mill Project
Nye County, Nevada, USA**

Prepared for:



Prepared by:



Kappes, Cassiday & Associates
7950 Security Circle
Reno, NV 89506



**P&E MINING
CONSULTANTS INC.**
Geologists and Mining Engineers

2 County Court Blvd., Suite 400
Brampton, Ontario, L6W 3W8

Tel: 905-595-0575
www.peconsulting.ca

Report Effective Date: 17 May 2024
Report Signed Date: 03 July 2024
Mineral Resource Effective Date: 29 April 2024

Authors:

Carl E. Defilippi, Kappes, Cassiday & Associates, RM SME.
Eugene Puritch, P&E Mining Consultants Inc., P.Eng., FEC, CET
Andrew Bradfield, P&E Mining Consultants Inc., P.Eng.
William Stone, P&E Mining Consultants Inc., Ph.D., P.Geo.
Jarita Barry, P&E Mining Consultants Inc., P.Geo.
David Burga, P&E Mining Consultants Inc., P.Geo.
Douglas Willis, Welsh Hagen Associates, CPG

CONTENTS

1.0	SUMMARY.....	1-1
1.1	Introduction and Overview	1-1
1.2	Property Description and Ownership	1-1
1.3	Geology and Mineralization	1-2
1.4	Exploration and Drilling.....	1-2
1.5	Sample Preparation Analysis, Security and Verification.....	1-3
1.6	Mineral Processing and Metallurgical Test Work.....	1-3
1.7	Mineral Resource Estimate	1-4
1.8	Mining Methods	1-5
1.9	Recovery Methods.....	1-7
1.9.1	Heap Leaching	1-7
1.9.2	Milling	1-7
1.10	Infrastructure	1-8
1.11	Environmental Studies, Permitting and Social or Community Impact.....	1-8
1.12	Capital and Operating Costs	1-9
1.13	Economic Analysis	1-10
1.13.1	Forward Looking Information.....	1-14
1.13.2	Non-IFRS Measures.....	1-14
1.14	Interpretations and Conclusions	1-14
1.14.1	Conclusions.....	1-14
1.14.2	Opportunities	1-15
1.14.3	Risks.....	1-15
1.14.3.1	Mining.....	1-15
1.14.3.2	Metallurgy and Process.....	1-15
1.14.3.3	Access, Title and Permitting.....	1-15
1.14.3.4	Other Risks.....	1-15
1.15	Recommendations.....	1-16
1.15.1	KCA Recommendations	1-16
1.15.2	P&E Recommendations	1-16
1.16	Welsh Hagen Recommendations	1-17
2.0	INTRODUCTION.....	2-1
2.1	Introduction and Overview	2-1
2.2	Project Scope and Terms of Reference	2-1
2.2.1	Scope of Work.....	2-1
2.2.2	Terms of Reference.....	2-2
2.3	Sources of Information	2-2
2.4	Qualified Persons and Site Visits	2-3
2.5	Frequently Used Acronyms, Abbreviations, Definitions and Units of Measure.....	2-4

3.0	RELIANCE ON OTHER EXPERTS	3-1
4.0	PROPERTY DESCRIPTION AND LOCATION	4-1
4.1	Property Location	4-1
4.2	Property Description and Mineral Concession Status	4-2
4.3	Permits	4-3
4.4	Royalties	4-3
4.5	Other Liabilities	4-3
5.0	ACCESSIBILITY, CLIMATE, LOCAL RESOURCES, AND PHYSIOGRAPHY	5-1
5.1	Accessibility	5-1
5.2	Local Resources and Infrastructure	5-2
5.3	Physiography	5-3
5.4	Climate	5-4
6.0	HISTORY	6-1
6.1	Regional Exploration	6-1
6.2	Historical Exploration of the Gabbs Property	6-2
6.2.1	Newcrest Resources Inc. (2002 to 2008)	6-6
6.2.1.1	Geochemical Exploration	6-6
6.2.1.2	Geophysical Exploration	6-10
6.2.1.3	Drilling Programs 2004 to 2008	6-13
6.2.2	St. Vincent 2011	6-16
6.3	Historical Metallurgy	6-20
6.4	Historical Resource Estimates	6-20
6.5	Recent Historical Mineral Resource Estimate	6-21
6.6	Previous Mineral Resource Estimate	6-22
6.7	Historical Production	6-23
7.0	GEOLOGICAL SETTING AND MINERALIZATION	7-1
7.1	Geological Setting	7-1
7.1.1	Regional and Local Geology	7-1
7.1.2	Property Geology	7-3
7.1.2.1	Triassic Section	7-5
7.1.2.2	Tertiary Section	7-8
7.1.2.3	Post-Tertiary Dykes	7-11
7.2	Structure	7-11
7.3	Alteration	7-18
7.4	Mineralization	7-21
7.4.1	Porphyry Gold-Copper Mineralization	7-21
7.4.1.1	Sullivan, Lucky Strike and Gold Ledge Zones	7-21
7.4.2	Epithermal Gold-Silver Mineralization	7-25

7.4.2.1	Car Body Zone	7-26
7.4.3	Alteration Zonation	7-27
8.0	DEPOSIT TYPES.....	8-1
8.1	Gold-Copper Porphyry Deposits.....	8-2
8.2	Low-Sulphidation Epithermal Deposits.....	8-3
9.0	EXPLORATION	9-1
9.1	Geophysics.....	9-1
9.2	Geochemistry	9-4
9.3	Structure.....	9-7
10.0	DRILLING	10-1
10.1	Phase I Drill Program - 2021	10-1
10.1.1	Sullivan Zone Diamond Drilling	10-1
10.1.2	Reverse Circulation Drilling	10-3
10.2	Phase II Drill Program - 2022	10-19
11.0	SAMPLE PREPARATION, ANALYSES AND SECURITY.....	11-1
11.1	Sample Preparation.....	11-1
11.2	2004 – 2008 Newcrest Mining QA/QC Review.....	11-3
11.3	2011 St. Vincent QA/QC Review.....	11-5
11.3.1	Sample Preparation.....	11-5
11.3.2	QA/QC Samples.....	11-5
11.3.3	Certified Reference Materials and Blanks	11-6
11.3.4	Assay Methods.....	11-6
11.4	P2 Gold Phase 1 And 2 Drilling (2021-2022)	11-7
11.4.1	Sample Preparation and Security.....	11-7
11.4.2	Sample Analyses.....	11-7
11.4.2.1	Fire Assay Fusion, AAS Finish (Au-AA23).....	11-8
11.4.2.2	Fire Assay Fusion, Gravimetric Finish (Au-GRA21)	11-8
11.4.2.3	Ultra-Trace Level Method Using ICP-MS and ICP-AES (ME-MS61m).....	11-8
11.4.2.4	Determination of Oxidized Copper by 5% Sulphuric Acid Leach (Cu-AA05).....	11-8
11.4.2.5	Grade Elements by Four-Acid Digestion/ICP-AES Analysis (ME-OG62).....	11-9
11.4.2.6	Density (OA-GRA08b).....	11-9
11.4.3	Phase I Drilling Quality Assurance / Quality Control Review.....	11-9
11.4.3.1	Performance Of Certified Reference Materials	11-10
11.4.3.2	Performance Of Blanks	11-11
11.4.3.3	Performance Of Duplicates	11-12
11.4.4	Phase 2 Drilling Quality Assurance / Quality Control Review	11-12
11.4.4.1	Performance Of Certified Reference Materials	11-12
11.4.4.2	Performance Of Blanks	11-16

11.4.4.3	Performance Of Duplicates	11-19
11.4.4.4	Check Assaying.....	11-23
11.5	Bulk Density.....	11-25
11.6	Conclusions	11-25
12.0	DATA VERIFICATION.....	12-1
12.1	Drill Hole Database.....	12-1
12.1.1	Assay Verification.....	12-1
12.1.1.1	February 2022 Assay Verification	12-1
12.1.1.2	July 2022 Assay Verification	12-1
12.1.1.3	September 2023 Assay Verification	12-1
12.1.1.4	Database Validation	12-1
12.2	Site Visit and Independent Sampling.....	12-2
12.2.1	2011, 2019 and 2021 P&E Site Visits and Independent Sampling	12-2
12.2.2	2022 Verification Sampling.....	12-7
12.3	Conclusion.....	12-10
12.4	KCA Verification.....	12-10
13.0	MINERAL PROCESSING AND METALLURGICAL TESTING.....	13-1
13.1	Cyprus (1982) – Cymet Laboratory – Flotation and Leach Results.....	13-3
13.1.1	Cyprus (1982) - Gold and Copper Flotation Prior to Cyanidation.....	13-3
13.1.2	Cyprus (1982) - Acid Leaching Prior to Cyanidation	13-4
13.1.3	Cyprus (1982) - Direct Cyanide Leaching	13-4
13.2	PLACER U.S., INC. (1984) - Metallurgy Section Report.....	13-5
13.3	PLACER U.S., INC. (1985) – DB&O Gravity Concentration Test Report.....	13-5
13.4	PLACER U.S., INC. (1985) – KCA Bottle Roll Test.....	13-6
13.5	PLACER (1985) – 1985 Metallurgical Report Section.....	13-8
13.6	CUERVO GOLD, INC. (1988) – MRC Flooded Column Tests	13-8
13.7	GWALIA (1990) – Sullivan Preliminary Economic Assessment	13-9
13.7.1	Gwalia (1990) - Metallurgical Work – Pit Bulk Samples	13-9
13.7.2	Gwalia (1990) - Bulk Sample - Direct Cyanide Bottle Roll and Column Tests	13-10
13.7.3	Gwalia (1990) - Metallurgical Work – Core Samples	13-13
13.7.4	Gwalia (1990) Core Composite Bottle Roll Tests.....	13-13
13.7.5	Gwalia (1990) - Bulk Sample and Core 2-Stage Leach.....	13-14
13.7.6	Gwalia (1990) - Core Composite Flotation	13-16
13.8	Gwalia (1991) – RDi – Sullivan Mine Project.....	13-18
13.8.1	Gwalia (1991) – RDi-Sample Preparation	13-18
13.8.2	Gwalia (1991) - RDi - Bond Work Indices	13-19
13.8.3	Gwalia (1991) - RDi - Heavy Liquid Separation	13-19
13.8.4	Gwalia (1991) – RDi – Flotation	13-20
13.9	Gwalia (April 1992) – NAD – Sullivan Metallurgical Testwork	13-22

13.9.1	Gwalia (April 1992) - NAD - Sample Preparation	13-22
13.9.2	Gwalia (April 1992) – NAD - Bottle Roll Leach Tests	13-23
13.9.3	Gwalia (April 1992) – NAD - Column Leach Tests	13-23
13.10	GWALIA (Nov. 1992) – NAD - Sullivan Project Gold Analysis	13-23
13.11	Gwalia (1994) - NAD - Summary of Sullivan Testwork.....	13-24
13.12	Arimetco (1996) - (KCA) Updates	13-26
13.13	P2 Gold, Inc. (2021) - Base Metallurgical Laboratories LTD. (BML)	13-28
13.13.1	P2 Gold (2021) - BML - Sequential Flotation - Oxide Copper Recovery by Sulphidization.....	13-30
13.13.2	P2 Gold (2021) - BML - Sequential Flotation - Oxide Copper by Alky Hydroxamate 13-30	
13.13.3	P2 Gold (2021) - BML - Bottle Roll Sequential Leach: Sulphuric Acid Leach – Cyanide Leach	13-30
13.13.3.1	P2 Gold (2021) – BML - Composite 1	13-33
13.13.3.2	P2 Gold (2021) – BML - Composite 2	13-33
13.13.4	P2 Gold (2021) – BML - Combined Flotation and 2-Stage Leach.....	13-34
13.13.4.1	P2 Gold (2021) – BML - Composite 1 – Flotation – 2-Stage Leach	13-34
13.13.4.2	P2 Gold (2021) – BML - Composite 2 – Flotation – 2-Stage Leach	13-34
13.14	P2 Gold (2022) – KCA –Metallurgical Test Program on Oxides and Sulphide Composites	13-34
13.14.1	P2 Gold (2022) – KCA – Head Analyses	13-35
13.14.2	P2 Gold (2022) – KCA – Bottle Roll Leach Test Work	13-40
13.14.3	P2 Gold (2022) – KCA – Flotation Test Work	13-43
13.14.4	P2 Gold (2022) – KCA – Agglomeration and Compacted Permeability	13-47
13.14.5	P2 Gold (2022) – KCA – Column Leach Test Work	13-49
13.15	P2 GOLD (2022) – KCA – Metallurgical Test Program on Monzonite and Pyroxenite Composites	13-52
13.15.1	P2 Gold (2022) – KCA – Head Analyses	13-52
13.15.2	P2 Gold (2022) – KCA – Bottle Roll Leach Test Work	13-57
13.15.3	P2 Gold (2022) – KCA – Flotation Test Work	13-59
13.16	Metallurgical Conclusions	13-61
14.0	MINERAL RESOURCE ESTIMATES.....	14-1
14.1	Introduction.....	14-1
14.2	Data Supplied.....	14-1
14.3	Database Validation	14-3
14.4	Economic Assumptions	14-3
14.5	Domain Modeling.....	14-4
14.6	Exploratory Data Analysis	14-6
14.7	Compositing.....	14-8
14.8	Composite Summary Statistics.....	14-8

14.9	Treatment of Extreme Values	14-9
14.10	Variography	14-13
14.11	Block Model	14-16
14.12	Grade Estimation and Classification.....	14-17
14.13	Mineral Resource Estimate	14-18
14.14	Validation.....	14-21
15.0	MINERAL RESERVE ESTIMATE	15-1
16.0	MINING METHODS	16-1
16.1	PIT OPTIMIZATIONS	16-2
16.2	OPEN PIT DESIGNS.....	16-7
16.2.1	Geotechnical Studies	16-10
16.2.2	Hydrogeological Studies.....	16-10
16.2.3	Dilution and Losses	16-10
16.3	POTENTIAL OXIDE AND SULPHIDE FEED	16-10
16.4	PRODUCTION SCHEDULE	16-11
16.5	OPEN PIT MINING PRACTICES	16-15
16.5.1	Equipment Fleet and Personnel	16-15
16.5.2	Waste Rock Storage Facilities	16-18
16.5.3	Mine Support Facilities	16-18
17.0	RECOVERY METHODS	17-1
17.1	Summary	17-1
17.1.1	Heap Leaching	17-1
17.1.2	Milling	17-2
17.2	Process Description.....	17-7
17.2.1	Crushing.....	17-7
17.2.2	Heap Conveying and Stacking	17-8
17.2.3	Heap Leaching	17-8
17.2.4	Heap Leach Facility	17-9
17.2.5	Solution Storage.....	17-10
17.2.6	Primary Grinding	17-10
17.2.7	Flotation and Regrind	17-11
17.2.8	Copper Concentrate Filtering	17-11
17.2.9	Flotation Tails Thickener	17-11
17.2.10	Leach Tanks and Countercurrent Decantation.....	17-11
17.2.11	Cyanide Destruction	17-12
17.2.12	Tails Filtration	17-12
17.2.13	Process Water Balance	17-12
17.2.14	SART.....	17-12

17.2.14.1	Copper and Silver Precipitation.....	17-12
17.2.14.2	Pregnant Solution Acidification	17-13
17.2.14.3	Copper-Silver Recycle Mix Tank.....	17-14
17.2.14.4	Copper-Silver Precipitation Tanks.....	17-14
17.2.14.5	Copper-Silver Sulphide Thickener	17-14
17.2.14.6	Copper-Silver Precipitate Filtration	17-14
17.2.15	Copper-Silver Filter Feed Tank	17-14
17.2.16	Copper-Silver Filtration.....	17-14
17.2.16.1	Filter Cake Conveying.....	17-15
17.2.16.2	Caustic Scrubber Systems.....	17-15
17.2.16.3	On-Line Analysis	17-16
17.2.16.4	Solution Neutralization	17-16
17.2.16.5	Recycle Gypsum Mix Tank	17-16
17.2.16.6	Neutralization Tank	17-16
17.2.16.7	Gypsum Thickener	17-17
17.2.17	Adsorption	17-17
17.2.18	Carbon Acid Wash	17-17
17.2.19	Desorption	17-18
17.2.20	Electrowinning and Refining.....	17-19
17.2.21	Carbon Handling and Regeneration.....	17-20
17.2.22	Reagents	17-20
17.2.22.1	Cyanide	17-20
17.2.22.2	Cement.....	17-20
17.2.22.3	Slaked Lime.....	17-21
17.2.22.4	Sodium Hydroxide (Caustic)	17-21
17.2.22.5	Concentrated Sulphuric Acid.....	17-21
17.2.22.6	Sodium Hydrosulphide (NaHS).....	17-21
17.2.22.7	Flocculant	17-21
17.2.22.8	Antiscalant.....	17-21
17.2.22.9	Hydrogen Peroxide.....	17-21
18.0	PROJECT INFRASTRUCTURE	18-1
18.1	Roads	18-1
18.1.1	Site Roads.....	18-1
18.1.1.1	Haul Roads.....	18-1
18.1.1.2	Service Roads.....	18-1
18.2	Project Buildings.....	18-1
18.3	Power Supply and Distribution	18-2
18.4	Estimated Power Consumption	18-2
18.5	Water Supply and Distribution	18-2
18.5.1	Process Water.....	18-2
18.5.2	Raw and Fire Water	18-3
18.5.3	Potable Water.....	18-3

18.6	Explosive Storage.....	18-3
18.7	Security.....	18-3
18.8	Waste Disposal.....	18-3
18.8.1	Sewage	18-3
18.8.2	Solid Waste	18-3
19.0	MARKET STUDIES AND CONTRACTS.....	19-1
20.0	ENVIRONMENTAL STUDIES, PERMITTING AND SOCIAL OR COMMUNITY IMPACT	
	20-1	
20.1	Federal Authorizations and Permits	20-1
20.2	State of Nevada Required Permits and Statutes.....	20-2
20.3	County Required Permits	20-3
20.4	Reclamation Bonding	20-4
20.5	Environmental Permitting Status	20-5
20.6	Biological Baseline Survey	20-6
20.7	Geochemical Characterization of Mineralized Material and Waste Rock.....	20-7
20.8	Environmental Issues	20-7
20.9	Waters of the United States Jurisdictional Determination	20-7
20.10	Water Supply Permits.....	20-7
20.11	Community Impact.....	20-7
21.0	CAPITAL AND OPERATING COSTS.....	21-1
21.1	Capital Expenditures	21-1
21.1.1	Mining Capital Costs	21-4
21.1.1.1	Open Pit Mining Equipment	21-5
21.1.1.2	Open Pit Pre-production.....	21-5
21.1.1.3	Site Infrastructure for Mining.....	21-6
21.1.1.4	Other Mining Capital Costs	21-6
21.1.1.5	Sustaining Mining Capital Costs	21-6
21.1.2	Process and Infrastructure Capital Cost Estimate.....	21-6
21.1.2.1	Process and Infrastructure Capital Cost Basis	21-6
21.1.2.2	Major Earthworks and Liner	21-8
21.1.2.3	Civils.....	21-9
21.1.2.4	Structural Steel.....	21-9
21.1.2.5	Platework.....	21-9
21.1.2.6	Mechanical Equipment.....	21-9
21.1.2.7	Piping	21-9
21.1.2.8	Electrical.....	21-10
21.1.2.9	Instrumentation.....	21-10
21.1.2.10	Infrastructure & Buildings	21-10
21.1.2.11	Supplier Engineering and Installation Supervision / Commissioning.....	21-10

21.1.2.12	Process Mobile Equipment	21-10
21.1.2.13	Spare Parts	21-11
21.1.2.14	Process & Infrastructure Contingency.....	21-11
21.1.2.15	Process & Infrastructure Sustaining Capital	21-11
21.1.3	Construction Indirect Costs	21-11
21.1.4	Other Owner’s Construction Costs	21-11
21.1.5	Initial Fills Inventory	21-12
21.1.6	Engineering, Procurement & Construction Management	21-12
21.1.7	Working Capital	21-12
21.1.8	Exclusions	21-13
21.2	Operating Costs.....	21-13
21.2.1	Open Pit Mine Operating Costs.....	21-14
21.2.2	Process and G&A Operating Costs.....	21-14
21.2.2.1	Personnel and Staffing.....	21-15
21.2.2.2	Power	21-16
21.2.2.3	Consumable Items	21-16
21.2.2.4	Heap Leach Consumables.....	21-16
21.2.2.5	SART Consumables.....	21-17
21.2.2.6	Recovery Plant Consumables.....	21-18
21.2.2.7	Laboratory	21-18
21.2.2.8	Fuel	21-18
21.2.2.9	Miscellaneous Operating & Maintenance Supplies.....	21-19
21.2.2.10	Mobile / Support Equipment.....	21-19
21.2.2.11	G&A Expenses.....	21-19
21.3	Reclamation & Closure Costs.....	21-20
22.0	ECONOMIC ANALYSIS	22-1
22.1	Summary	22-1
22.2	Methodology	22-4
22.2.1	General Assumptions	22-5
22.3	Capital Expenditures	22-6
22.4	Metal Production.....	22-6
22.5	Royalties.....	22-7
22.6	Operating Costs.....	22-8
22.7	Closure Costs	22-8
22.8	Taxation.....	22-8
22.8.1	Federal Income Tax	22-8
22.8.1	Nevada Mining Excise Tax.....	22-8
22.8.1	Net Proceeds of Mineral Tax.....	22-9
22.8.2	Depreciation	22-9
22.8.3	Depletion	22-9
22.9	Economic Model & Cash Flow.....	22-9

22.10 Sensitivity	22-12
23.0 ADJACENT PROPERTIES	23-1
23.1 Paradise Peak Gold Mine	23-2
23.2 Davis/Paradise Property	23-2
24.0 OTHER RELEVANT DATA AND INFORMATION	24-1
25.0 INTERPRETATIONS AND CONCLUSIONS	25-1
25.1 Conclusions	25-1
25.1.1 Mineral Resource Estimate	25-1
25.1.2 Mining	25-1
25.1.3 Metallurgy and Process	25-1
25.1.4 Environmental Studies, Permits, And Social Or Community Impacts	25-2
25.2 Opportunities	25-3
25.2.1 Mining	25-3
25.2.2 Mineral Resource	25-3
25.2.3 Metallurgy and Process	25-3
25.3 Risks	25-4
25.3.1 Mining	25-4
25.3.2 Metallurgy and Process	25-4
25.3.3 Other Risks	25-4
26.0 RECOMMENDATIONS	26-1
26.1 KCA Recommendations	26-1
26.2 P&E Recommendations	26-1
26.3 Welsh Hagen Recommendations	26-1
26.3.1 Environmental Studies, Permitting, And Social Or Community Impacts	26-1
27.0 REFERENCES	27-1
28.0 DATE AND SIGNATURE PAGE	28-1
29.0 APPENDICES	29-1
29.1 Appendix A - Surface Drill Hole Plans	29-1
29.2 Appendix B - 3-D Domains	29-7
29.3 Appendix C - Block Model Plans	29-9
29.4 Appendix D - Optimized Pit Shells	29-14
29.5 Appendix E – Gabbs Property Claims	29-16

FIGURES

Figure 1-1 General Mine Layout	1-5
Figure 1-2 After-Tax NPV @ 5% vs. Gold Price, Capital Cost & Operating Cost	1-13
Figure 1-3 After-Tax IRR vs. Gold Price, Capital Cost & Operating Cost	1-13
Figure 4-1 Gabbs Property Location, Nevada	4-1
Figure 4-2 Gabbs Property Claim Map	4-4
Figure 5-1 Gabbs Property Access	5-1
Figure 5-2 Gabbs Property Infrastructure	5-2
Figure 5-3 Gabbs Property Physiography – Looking Southeast	5-4
Figure 6-1 Paradise Peak Gold-Silver Mine.....	6-2
Figure 6-2 Original Shaft Collar at Sullivan Mine	6-5
Figure 6-3 Open Pit Excavation at Sullivan Mine.....	6-5
Figure 6-4 Rock Chip Sample Locations and Gold Values in the Gabbs Claim Block	6-7
Figure 6-5 Rock Chip Sample Locations and Copper Values in the Gabbs Claim Block	6-8
Figure 6-6 Soil Sample Locations and Gold Values in the Gabbs Claim Block	6-9
Figure 6-7 Soil Sample Locations and Copper Values in the Gabbs Claim Block.....	6-10
Figure 6-8 Plan Map of the Model Chargeability at 300m and 450m.....	6-12
Figure 6-9 Magnetic Image (rtp) for Gabbs Property, Showing Interpreted Structures.....	6-13
Figure 6-10 Newcrest Drill Hole Locations 2004 to 2008.....	6-15
Figure 6-11 2011 St. Vincent Drill Hole Locations	6-17
Figure 7-1 Regional Geologic Setting of the Gabbs Property.....	7-1
Figure 7-2 Local Geology of the Gabbs Property Area.....	7-2
Figure 7-3 Geologic Map of the Gabbs Property	7-3
Figure 7-4 Gabbs Property Stratigraphic Column.....	7-4
Figure 7-5 Gabbs Triassic Welded Rhyolite Tuff	7-5
Figure 7-6 Gabbs Intrusive Rocks and Textures	7-7
Figure 7-7 Volcanic Rocks at Gabbs	7-9
Figure 7-8 Gabbs Property Cross-Sectional Projection SD 16 – Looking Northwest	7-10
Figure 7-9 Axial Trace of Folds Within Triassic Rocks at Lucky Strike and Car Body.....	7-12
Figure 7-10 Structure in Gabbs Mafic Rocks	7-14
Figure 7-11 Structure at Sullivan Pit	7-14
Figure 7-12 Sullivan Open Pit Structure	7-16
Figure 7-13 Structures in Sullivan Pit.....	7-17
Figure 7-14 Porphyry Style Alteration at the Lucky Strike Deposit	7-19
Figure 7-15 Typical Hydrothermal Alteration at Gabbs.....	7-20
Figure 7-16 Representative Longitudinal Section Through the Sullivan Zone.....	7-22
Figure 7-17 Southwest-Northeast Cross-Sectional Projection Through the Sullivan Zone Showing Interpreted Fault Truncating Monzonite Sill	7-23
Figure 7-18 Southwest-Northeast Cross-Sectional Projection Through Lucky Strike Zone....	7-25

Figure 8-1 Model of Relationship of Low-Sulphidation and High-Sulphidation to Co-Genetic Sub-volcanic Intrusions and Associated Porphyry-Style Mineralization8-1

Figure 8-2 Conceptual Model Illustrating Different Styles of Magmatic Arc Porphyry and Epithermal Cu-Au-Mo-Ag Mineralization.....8-2

Figure 8-3 Model Accounting for Varying Hydrothermal Fluids Contributing to the Development of Banded Low-Sulphidation Epithermal Au-Ag Veins8-4

Figure 9-1 2021 Natural Source Magneto-Telluric Survey Lines9-1

Figure 9-2 3-D Inversion with Plan Section Lines9-2

Figure 9-3 Section Line 415,700E Looking East.....9-3

Figure 9-4 Section Line 417,500E Looking East.....9-3

Figure 9-5 Gold Soil Anomalies9-5

Figure 9-6 Copper Soil Anomalies9-6

Figure 9-7 Structural Mapping9-8

Figure 9-8 Historical Workings9-9

Figure 10-1 Diamond Drill Hole Locations 2021 Drill Program10-3

Figure 10-2 Reverse Circulation Drill Hole Locations 2021 Drill Program – Sullivan Zone.....10-7

Figure 10-3 Sullivan Zone – Cross-Sectional Projection NW1-NW1’10-8

Figure 10-4 Sullivan Zone – Cross-Sectional Projection B-B’10-9

Figure 10-5 Sullivan Zone – Cross-Sectional Projection J-J’10-10

Figure 10-6 Sullivan Zone – Cross-Section Projection L-L’10-11

Figure 10-7 Sullivan Zone – Cross-Section N-N’10-12

Figure 10-8 Sullivan Zone – Cross-Section Projection Q-Q’10-13

Figure 10-9 Reverse Circulation Drill Hole Location 2021 Drill Program – Lucky Strike Zone .10-14

Figure 10-10 Lucky Strike Zone – Sectional Projection A-A’ Looking West10-15

Figure 10-11 Reverse Circulation Drill Hole Locations 2021 Drill Hole Program – Car Body Zone10-16

Figure 10-12 Car Body Zone – Sectional Projection B-B’ Looking North10-17

Figure 10-13 Car Body Zone – Sectional Projection C-C’ Looking North10-18

Figure 10-14 2022 Drill Hole Locations - Sullivan Zone.....10-22

Figure 10-15 Sullivan Zone – Cross-Section B-B’10-23

Figure 10-16 Sullivan Zone – Cross-Section F-F’10-24

Figure 10-17 Sullivan Zone – Cross-Section P-P’10-25

Figure 10-18 2022 Drill Hole Locations – Car Body Zone10-26

Figure 10-19 Car Body Zone – Cross-Section X-X’10-27

Figure 10-20 Car Body Zone – Cross-Section Y-Y’10-28

Figure 10-21 2022 Drill Hole Locations – Lucky Strike Zone10-29

Figure 10-22 Lucky Strike Zone – Cross-Section X-X’10-30

Figure 10-23 Lucky Strike Zone – Cross-Section Y-Y’10-31

Figure 10-24 Lucky Strike Zone – Cross-Section Z-Z’10-32

Figure 11-1 Performance of ME-1409 Au CRM at ALS for Phase 2 Drilling.....	11-13
Figure 11-2 Performance of ME-1409 Cu CRM at ALS for Phase 2 Drilling.....	11-13
Figure 11-3 Performance of ME-1409 Ag CRM at ALS for Phase 2 Drilling.....	11-14
Figure 11-4 Performance of ME-1706 Au CRM at ALS for Phase 2 Drilling.....	11-14
Figure 11-5 Performance of ME-1706 Cu CRM at ALS for Phase 2 Drilling.....	11-15
Figure 11-6 Performance of ME-1706 Ag CRM at ALS for Phase 2 Drilling.....	11-15
Figure 11-7 Performance of Scoria Blanks Au at ALS for Phase 2 Drilling.....	11-16
Figure 11-8 Performance of Scoria Blanks Au at ALS for Phase 2 Drilling.....	11-17
Figure 11-9 Performance of Scoria Blanks Ag at ALS for Phase 2 Drilling.....	11-17
Figure 11-10 Performance of MEG-BLANK.17.11 Au at ALS for Phase 2 Drilling	11-18
Figure 11-11 Performance of MEG-BLANK.17.11 Cu at ALS for Phase 2 Drilling	11-18
Figure 11-12 Performance of MEG-BLANK.17.11 Ag at ALS for Phase 2 Drilling	11-19
Figure 11-13 Scatter Performance of Au Reject Duplicates at ALS for Phase 2 Drilling	11-20
Figure 11-14 Scatter Performance of Cu Reject Duplicates at ALS for Phase 2 Drilling	11-21
Figure 11-15 Scatter Performance of Ag Reject Duplicates at ALS for Phase 2 Drilling	11-21
Figure 11-16 Scatter Performance of Au Pulp Duplicates at ALS for Phase 2 Drilling	11-22
Figure 11-17 Scatter Performance of Cu Pulp Duplicates at ALS for Phase 2 Drilling	11-22
Figure 11-18 Phase 1 & 2 Drilling Umpire Sampling Results for Au	11-24
Figure 11-19 Phase 1 & 2 Drilling Umpire Sampling Results for Cu.....	11-24
Figure 12-1 2011 Site Visit Sample Results Comparison for Gold	12-3
Figure 12-2 2011 Site Visit Sample Results Comparison for Copper	12-4
Figure 12-3 2021 Site Visit DDH Sample Results Comparison for Gold.....	12-4
Figure 12-4 2021 Site Visit DDH Sample Results Comparison for Copper	12-5
Figure 12-5 2021 Site Visit DDH Sample Results Comparison for Silver	12-5
Figure 12-6 2021 Site Visit RC Sample Results Comparison for Gold	12-6
Figure 12-7 2021 Site Visit RC Sample Results Comparison for Copper	12-6
Figure 12-8 2021 Site Visit RC Sample Results Comparison for Silver.....	12-7
Figure 12-9 2022 Phase 2 Verification Sample Results Comparison for Gold	12-8
Figure 12-10 2022 Phase 2 Verification Sample Results Comparison for Copper	12-9
Figure 12-11 2022 Phase 2 Verification Sample Results Comparison for Silver	12-9
Figure 14-1 Collar Locations.....	14-2
Figure 14-2 Modelled Deposits	14-5
Figure 14-3 Isometric Plot of Redox Zones – View Looking North	14-6
Figure 14-4 Au Log-Probability Plots	14-10
Figure 14-5 Cu Log-Probability Plots	14-11
Figure 14-6 Ag Log-Probability Plots	14-12
Figure 14-7 Au Semi-variograms for Sullivan	14-15
Figure 14-8 Cu Semi-variograms for Sullivan	14-16
Figure 16-1 General Mine Layout	16-2
Figure 16-2 Car Body Pit Optimization (NPV vs Revenue Factor)	16-5

Figure 16-3 Gold Ledge Optimization (NPV vs Revenue Factor)	16-5
Figure 16-4 Lucky Strike Pit Optimization (NPV vs Revenue Factor)	16-6
Figure 16-5 Sullivan Pit Optimization (NPV vs Revenue Factor)	16-6
Figure 16-6 Car Body Open Pits	16-8
Figure 16-7 Gold Ledge Open Pit	16-8
Figure 16-8 Lucky Strike Open Pit	16-9
Figure 16-9 Sullivan Open Pit	16-9
Figure 17-1 Gabbs Overall Heap Leach Process Flowsheet	17-4
Figure 17-2 Gabbs Overall Milling Process Flowsheet	17-5
Figure 17-3 Gabbs Overall Site Plan View	17-6
Figure 22-1 Annual Gold Production	22-6
Figure 22-2 Annual Silver Production	22-7
Figure 22-3 Annual Copper Production	22-7
Figure 22-4 After Tax Sensitivity – IRR	22-13
Figure 22-5 After Tax Sensitivity – NPV @ 5%	22-13
Figure 23-1 Location of the Davis/Paradise Valley Property	23-1

TABLES

Table 1-1 Gabbs Project Pit Constrained Mineral Resource Estimate ⁽¹⁻¹⁰⁾	1-4
Table 1-2 Capital Cost Summary	1-9
Table 1-3 LOM Operating Cost Summary	1-10
Table 1-4 Economic Analysis Summary	1-12
Table 4-1 Gabbs Property Claims Summary	4-5
Table 6-1 Summary of Historical Exploration on the Gabbs Property	6-3
Table 6-2 Newcrest 2004 to 2008 Drill Hole Location, Type, Recovery	6-16
Table 6-3 Gabbs Property Significant Drill Intercepts	6-16
Table 6-4 Highlights of Intercepts from 2011 Drill Program ^(1,2)	6-18
Table 6-5 Summary of Historical Resource Estimates*	6-20
Table 6-6 Summary of Pit Constrained Inferred Mineral Resources ⁽¹⁻¹¹⁾ (Effective December 1, 2011).....	6-22
Table 6-7 Summary of Inferred Mineral Resources ⁽¹⁻⁹⁾ (Effective January 13, 2021)	6-23
Table 10-1 2021 Diamond Drill Collar Locations, Orientations and Drill Hole Lengths.....	10-2
Table 10-2 Select Significant Intersections – 2021 Diamond Drill Program	10-2
Table 10-3 2021 Reverse Circulation Drill Hole Collar Locations and Hole Lengths.....	10-5
Table 10-4 Select Significant Intersections: 2021 Reverse Circulation Drill Program.....	10-5
Table 10-5 2022 Reverse Circulation Collar Locations.....	10-20
Table 10-6 Select Significant Intersections – 2022 Reverse Circulation Drill Program.....	10-21
Table 11-1 Analytical Detection Limits.....	11-9
Table 11-2 Summary of CRM Samples Used at Gabbs in Phase I	11-10
Table 11-3 CV _{AVE} Precision Estimation.....	11-23
Table 11-4 Summary of Bulk Density Measurements At Gabbs Project (t/m ³).....	11-25
Table 13-1 Historical and Current Metallurgical Reports	13-2
Table 13-2 Placer USA, Inc. – KCA (1985) Sodium Cyanide Bottle Roll Results – Pulverized Sample.....	13-7
Table 13-3 Placer vs Cyprus Milled Cyanidation Results	13-8
Table 13-4 Bulk Sample Individual Composites and Assays.....	13-10
Table 13-5 Gwalia (1990) – Bulk Sample and Core – Direct Cyanide – Bottle Roll and Column Tests	13-12
Table 13-6 Gwalia (1990) – Core Composites.....	13-13
Table 13-7 Gwalia (1990) – Bulk Sample Core – 2-Stage Sulphuric Acid – Sodium Cyanide – Bottle Roll Tests.....	13-15
Table 13-8 Gwalia (1990) – Core – Mixed Sulphide and Sulphide Composites – Flotation .	13-17
Table 13-9 Gwalia (1991) – RDi Composite Head Analysis	13-18
Table 13-10 Gwalia (1991) – RDi Whole Rock Analysis.....	13-19
Table 13-11 Gwalia (1991) – RDi – Flotation Test Results.....	13-21
Table 13-12 Gwalia (April 1992) – NAD – Composite Head Analysis	13-22

Table 13-13	Gwalia (1994) – NAD – Sequential Leach Column Test Results.....	13-25
Table 13-14	Arimetco (1996) – KCA – Solution Analysis	13-27
Table 13-15	P2 Gold (2021) – BML – Composite 1 – Head Screen Analysis	13-29
Table 13-16	P2 Gold (2021) – BML – Composite 2 – Head Screen Analysis	13-29
Table 13-17	P2 Gold (2021) – BML – Flotation: Sequential	13-31
Table 13-18	P2 Gold (2021) – BML – Sequential Leach: 2-Stage Sulphuric Acid – Sodium Cyanide Bottle Roll Tests.....	13-32
Table 13-19	P2 Gold (2022) – KCA – Head Assays on Oxide and Sulphide Composites....	13-35
Table 13-20	P2 Gold (2022) – KCA – Carbon and Sulphur Analyses on Oxide and Sulphide Composites	13-36
Table 13-21	P2 Gold (2022) – KCA – Copper Sequential Leach on Oxide Composites	13-37
Table 13-22	P2 Gold (2022) – KCA – Copper Sequential Leach on Sulphide Composites..	13-38
Table 13-23	P2 Gold (2022) – KCA – Multielement Analyses on Oxide and Sulphide Composites	13-39
Table 13-24	P2 Gold (2022) – KCA – Whole Rock Analyses on Oxide and Sulphide Composites	13-40
Table 13-25	P2 Gold (2022) – KCA – Bottle Roll Leach Test Work on Oxide and Sulphide Composites	13-42
Table 13-26	P2 Gold (2022) – KCA – Flotation Test Work on Oxide and Sulphide Composites (Gold)	13-44
Table 13-27	P2 Gold (2022) – KCA – Flotation Test Work on Oxide and Sulphide Composites (Silver).....	13-45
Table 13-28	P2 Gold (2022) – KCA – Flotation Test Work on Oxide and Sulphide Composites (Copper).....	13-46
Table 13-29	P2 Gold (2022) – KCA – Compacted Permeability Test Work with Agglomerated Oxide and Sulphide Composites.....	13-48
Table 13-30	P2 Gold (2022) – KCA – Column Leach Test Work of Oxide and Sulphide Composites	13-50
Table 13-31	P2 Gold (2022) – KCA – Column Leach SART Test Work of Oxide and Sulphide Composites	13-51
Table 13-32	P2 Gold (2022) – KCA Head Assays of Monzonite and Pyroxenite Composites .	13-52
Table 13-33	P2 Gold (2022) – KCA – Carbon and Sulphur Analyses on Monzonite and Pyroxenite Composites	13-53
Table 13-34	P2 Gold (2022) – KCA – Copper Sequential Leach on Monzonite and Pyroxenite Composites	13-54
Table 13-35	P2 Gold (2022) – KCA – Multielement Analyses on Monzonite and Pyroxenite Composites	13-55
Table 13-36	P2 Gold (2022) – KCA – Whole Rock Analyses on Monzonite and Pyroxenite Composites	13-56

Table 13-37 P2 Gold (2022) – KCA – Bottle Roll Leach Test Work on Monzonite and Pyroxenite Composites	13-58
Table 13-38 P2 Gold (2022) – KCA – Flotation Test Work on Monzonite and Pyroxenite Composites	13-60
Table 14-1 Database Summary	14-3
Table 14-2 Redox Summary Statistics.....	14-5
Table 14-3 Summary Statistics for Constrained Assays.....	14-7
Table 14-4 Domain Composite Summary Statistics	14-9
Table 14-5 Capping Thresholds.....	14-13
Table 14-6 Sullivan Semi-Variograms	14-14
Table 14-7 Block Model Setup.....	14-17
Table 14-8 Summary of Mineral Resources ⁽¹⁻⁹⁾	14-19
Table 14-9 Volume Reconciliation	14-21
Table 14-10 Domain Validation Statistics	14-22
Table 16-1 Pit Optimization Parameters	16-4
Table 16-2 Open Pit Design Parameters	16-7
Table 16-3 Dilution & Loss Parameters	16-10
Table 16-4 Mine Plan by Mineral Resource Classification.....	16-11
Table 16-5 Tonnage Summary by Deposit (Diluted).....	16-11
Table 16-6 Annual Mine Production Schedule Summary	16-13
Table 16-7 Phase Mining Sequence (Total Tonnes per Year).....	16-13
Table 16-8 Annual Processing Schedule Summary	16-14
Table 16-9 Mine Equipment Fleet (Peak in First Five Years)	16-16
Table 16-10 Mining Personnel List (Peak in First Five Years).....	16-17
Table 17-1 Gabbs Heap Leach Process Design Criteria Summary.....	17-2
Table 20-1 Summary of Major Permits Required.....	20-4
Table 21-1 Capital Cost Summary.....	21-1
Table 21-2 LOM Operating Cost Summary	21-1
Table 21-3 Summary of Pre-Production Capital Costs	21-3
Table 21-4 Summary of Sustaining Capital Costs	21-4
Table 21-5 Mining Capital Costs Summary	21-5
Table 21-6 Summary of Heap Leach Process & Infrastructure Pre-Production Capital Costs by Discipline.....	21-7
Table 21-7 Summary of Mill Capital Costs by Discipline.....	21-8
Table 21-8 Process Mobile Equipment	21-11
Table 21-9 Open Pit Mining Operating Costs	21-14
Table 21-10 Average Process, Support & G&A Operating Cost.....	21-15
Table 21-11 Heap Leach Process and G&A Personnel.....	21-16
Table 21-12 Heap Leach Consumables	21-16
Table 21-13 SART Consumables (Heap Leach)	21-17

Table 21-14 SART Consumables (Mill)	21-18
Table 21-15 Recovery Plant Consumables (Heap Leach).....	21-18
Table 21-16 Recovery Plant Consumables (Mill).....	21-18
Table 21-17 Fixed G&A Expenses.....	21-20
Table 22-1 Key Economic Parameters	22-2
Table 22-2 Economic Analysis Summary	22-3
Table 22-3 LOM Operating Costs	22-8
Table 22-4 Cashflow Model Summary	22-10
Table 22-5 After-Tax Sensitivity Analysis Results	22-12

1.0 SUMMARY

1.1 Introduction and Overview

This Report was prepared to provide a National Instrument 43-101 (“NI 43-101”) Technical Report and Preliminary Economic Assessment (PEA) for the gold, silver and copper mineralization contained in the Gabbs Property (the “Property”) located on the Walker Lane Trend in the Fairplay Mining District, Nye County, Nevada, USA. This Report supersedes the previous Technical Report on the Gabbs Project with an effective Report date of 07 September 2023 and titled “NI 43-101 Technical Report, Preliminary Economic Assessment, Gabbs Heap Leach and Mill Project, Nye County, Nevada, USA”.

In February 2021, P2 Gold Inc. (“P2 Gold”) entered into an agreement with Borealis Mining Company, LLC, an indirect, wholly-owned subsidiary of Waterton Precious Metals Fund II Cayman, LP (“Waterton”) to acquire all the ground that made up the Gabbs Property. The mineralization of interest is contained within four deposits, namely the Sullivan, Lucky Strike, Gold Ledge and Car Body Zones. In July 2021, P2 Gold staked 66 new claims to expand the Property southwards. In February 2022, P2 Gold staked 122 additional lode claims to expand the Gabbs Property primarily northwards. In June 2024, Eskay Mining Corp. (“Eskay”) and P2 Gold entered into a non-binding letter of intent dated 04 June 2024 pursuant to which Eskay agreed to acquire P2 Gold in a business combination transaction.

This Technical Report was prepared by Kappes, Cassidy & Associates (KCA), P&E Mining Consultants Inc. (P&E) and Welsh Hagan Associates at the request of Mr. Ken McNaughton, Chief Exploration Officer of P2 Gold Inc., a Vancouver, British Columbia based resource company. The effective date of this Technical Report is 17 May 2024.

1.2 Property Description and Ownership

The Gabbs Property is located in the Fairplay Mining District, approximately 9 km (5.6 miles) south-southwest of the Town of Gabbs in Nye County, west-central Nevada. The Sullivan Zone near the centre of the Property, is located at UTM WGS84 Zone 11N 417,580m E and 4,292,950m N. The Property is situated in the Walker Lane structural trend and on the southwest flank of the Paradise Range, north-adjacent to the past-producing Paradise Peak Gold Deposit.

The Gabbs Property consists of 543 federal unpatented lode claims and one patented lode claim which constitute an approximately 45.25 km² (4,525 ha or 16 square miles) contiguous claim block. As of the effective date of this Technical Report, the Gabbs claims are owned

100% by P2 Gold. Federal law requires the payment of an annual Maintenance Fee that is currently US\$165 per unpatented lode claim to Bureau of Land Management. The aggregate annual fee for the Gabbs Property is due September 1st of each year for the subsequent assessment year. The patented claim requires payment of an annual tax assessment that is currently US\$50.26 per year. The claims are currently valid and in good standing.

The Property is road accessible via Highway 361, southwest from Gabbs to Pole Line Road, and then 3.5 km (2.2 miles) south to the centre of the Property. It is situated in an area of dry rolling hills bounded to the west by the Gabbs Valley and on the east by the northeast trending Paradise Range. Surface elevations for the Property area range from 1,395m (4,578 ft) on the northwest corner of the claim block, to 1,770m (5,800 ft) on the southeast edge of the Property. Vegetation is sparse, with light coverage by grasses and low shrubs.

1.3 Geology and Mineralization

The Gabbs Property is underlain by a sequence of Triassic intermediate volcanic rocks and shallow marine sedimentary rocks intruded by a large mafic igneous complex consisting of massive equigranular gabbro, melagabbro, pyroxenite, and peridotite. A thick sequence of Tertiary intermediate and felsic volcanic rocks unconformably overlay the older rocks.

Monzonite bodies intrude the Triassic units and mafic complex and host the porphyry style Au-Cu mineralization at the Sullivan, Lucky Strike and Gold Ledge Zones. The Car Body Zone by comparison is a low-sulphidation type epithermal gold deposit hosted in magmatic-hydrothermally brecciated intermediate and felsic volcanic rocks.

1.4 Exploration and Drilling

The Gabbs Property has been explored intermittently by various operators since the 1880s, particularly since the late 1960s. At least 500 drill holes have been completed on the Property, of which approximately half targeted the Sullivan porphyry gold-copper deposit.

Historical exploration and drilling programs have been completed by Newcrest Resources Inc. ("Newcrest") from 2002 to 2008 and St. Vincent Mineral Inc. ("St. Vincent") in 2011. Newcrest completed surface geochemical and geophysical exploration surveys, starting in 2002, to identify targets for follow-up drill testing. Newcrest completed several drilling programs between 2004 and 2008 comprising 87 reverse circulation ("RC") and diamond core holes for a total of 24,765m (81,250 ft). These holes were drilled mainly at the Car Body, Gold Ledge, Sullivan and Lucky Strike Zones.

Subsequently, St. Vincent completed ten RC drill holes totalling 2,400m (7,875 ft). The goal of this drilling was to expand the area of known mineralization at the Lucky Strike area (six holes) and test IP anomalies (four holes) identified previously by Newcrest Resources Inc. Gold mineralization was encountered in seven of the ten drill holes. Drill holes SVM-4 and SVM-5 extended the mineralization 610m (2,000 ft) at Lucky Strike and SVM-6 encountered mineralization in a new area identified by an IP anomaly south of the Sullivan Deposit.

P2 Gold completed a Phase I drilling program in 2021 and a Phase II drilling program in 2022. The Phase I drilling program consisted of four diamond drill holes totalling 580m and 27 reverse circulation holes totalling 4,120m. The objective of the Phase I drill program was to test the full thickness and lateral extent of the mineralization and determine geologic constraints of the Sullivan Zone. The diamond drill holes were completed to confirm the geological model. The reverse circulation drill holes were completed for infill and expansion purposes.

For the Phase II program in 2022, P2 Gold completed 20 reverse circulation drill holes totalling approximately 4,000m (13,123 ft). The Phase II drill program focused on extension of the Sullivan and Car Body Zones and infill and extensions to the Lucky Strike Zone.

In addition to the drilling programs on Gabbs, P2 Gold also completed surface geophysical surveys and surface sampling and geological mapping programs on the Property.

1.5 Sample Preparation Analysis, Security and Verification

In the opinion of the authors of this Technical Report, the sample preparation, analytical procedures, security and QA/QC program meet industry standards, and the data are of good quality and satisfactory for use in the Mineral Resource Estimate reported in this Technical Report. It is recommended that the Company continue with the current sample preparation, security and analytical protocol at the Project, with the exception of modifying to a more suitable laboratory protocol for the Car Body Deposit samples. Recommendation is made to analyse all likely mineralized samples at the Car Body Deposit by metallic screening procedure.

This Technical Report author's independent due diligence sampling shows acceptable correlation with the original assays. It is the opinion of the Technical Report authors that the data are suitable for use in the current Mineral Resource Estimate.

1.6 Mineral Processing and Metallurgical Test Work

The current Mineral Resource Estimate assumes the oxide material will be heap leached during the first five years of production. Sulphide material will be stockpiled during this time. In Year 6, the oxides will continue to be heap leached at a reduced rate and the mill will begin processing

sulphides. This arrangement will continue to the end of mine life. Gold will be recovered as a saleable doré and cyanide-soluble copper and silver will be produced as a saleable copper/silver sulphide concentrate. A saleable copper flotation concentrate will also be produced in the milling operation.

Gold, silver and copper recoveries used for this current Preliminary Economic Assessment are based on historical metallurgical testwork and recently completed metallurgical tests at Kappes, Cassidy & Associates in Reno, Nevada. Heap leached oxide material gold, silver and copper recoveries are estimated to be 78.3%, 45.0% and 54.0%, respectively while milled sulfide material recoveries for gold, silver and copper are estimated at 94.5%, 50% and 79.9%, respectively.

1.7 Mineral Resource Estimate

The authors of Section 14 of this Technical Report prepared a Mineral Resource Estimate based on 547 drill hole records, consisting of 397 “historical” drill holes, 87 drill holes completed by Newcrest as part of a well-documented exploration program at Gabbs, ten RC drill holes completed by St. Vincent Minerals, and four diamond drillholes and 49 reverse circulation drillholes completed by P2 Gold. The current pit-constrained Mineral Resource Estimate for the Gabbs Property is reported using a cut-off of 0.27 g/t gold equivalent (“AuEq”) for oxide material and 0.36 g/t AuEq for sulphide material (Table 1-1).

**Table 1-1
Gabbs Project Pit Constrained Mineral Resource Estimate⁽¹⁻¹⁰⁾**

Mineral Resource Classification	Tonnes (Mt)	Au, (g/t)	Cu, (%)	Ag, (g/t)	Au, (Moz)	Cu (Mlb)	Ag, (Moz)	Au Eq. (g/t)	Au Eq. (Moz)
Indicated	49.8	0.45	0.27	1.36	0.72	297.0	2.2	0.72	1.16
Inferred	112.2	0.35	0.23	0.84	1.28	567.1	3.0	0.63	2.29

1. Mineral Resources, which are not Mineral Reserves, do not have demonstrated economic viability. The estimate of Mineral Resources may be materially affected by environmental, permitting, legal, title, taxation, sociopolitical, marketing, or other relevant issues.
2. The Inferred Mineral Resource in this estimate has a lower level of confidence than that applied to an Indicated Mineral Resource and must not be converted to a Mineral Reserve. It is reasonably expected that the majority of the Inferred Mineral Resource could be upgraded to an Indicated Mineral Resource with continued exploration.
3. The Mineral Resources were estimated using the Canadian Institute of Mining, Metallurgy and Petroleum (CIM), Standards on Mineral Resources and Reserves, Definitions (2014) and Best Practices (2019) prepared by the CIM Standing Committee on Reserve Definitions and adopted by CIM Council.
4. Mineral Resources are reported within a constraining conceptual pit shell.
5. Inverse distance weighting of capped composite grades within grade envelopes was used for grade estimation.
6. Composite grade capping was implemented prior to grade estimation.
7. Bulk density was assigned by domain.
8. A copper price of US\$3.96/lb and a gold price of US\$1,838/oz were used. Silver was not used for calculating revenue and is reported for future consideration.
9. A cut-off grade of 0.27 g/t AuEq for oxide material, and 0.36 g/t AuEq for sulphide material was used.
10. Tables may not sum due to rounding.

1.8 Mining Methods

The Gabbs Project consists of several relatively shallow gold-copper deposits that lend themselves to conventional open pit mining methods. Accordingly, the PEA mine plan entails developing several open pits across the Property to support a combined heap leach and mill (flotation) operation. The PEA mine production plan utilizes Inferred Mineral Resources that are considered too speculative geologically to have the economic considerations applied to them to be categorized as Mineral Reserves. There is no certainty that the Inferred Mineral Resources will be upgraded to a higher Mineral Resource category in the future.

The four deposits being mined are designated as: Car Body (including Car Body North); Gold Ledge; Lucky Strike; and Sullivan. Figure 1-1 provides a general overview of the Project site showing the location of the open pits and associated waste rock storage facilities with the primary crushers.

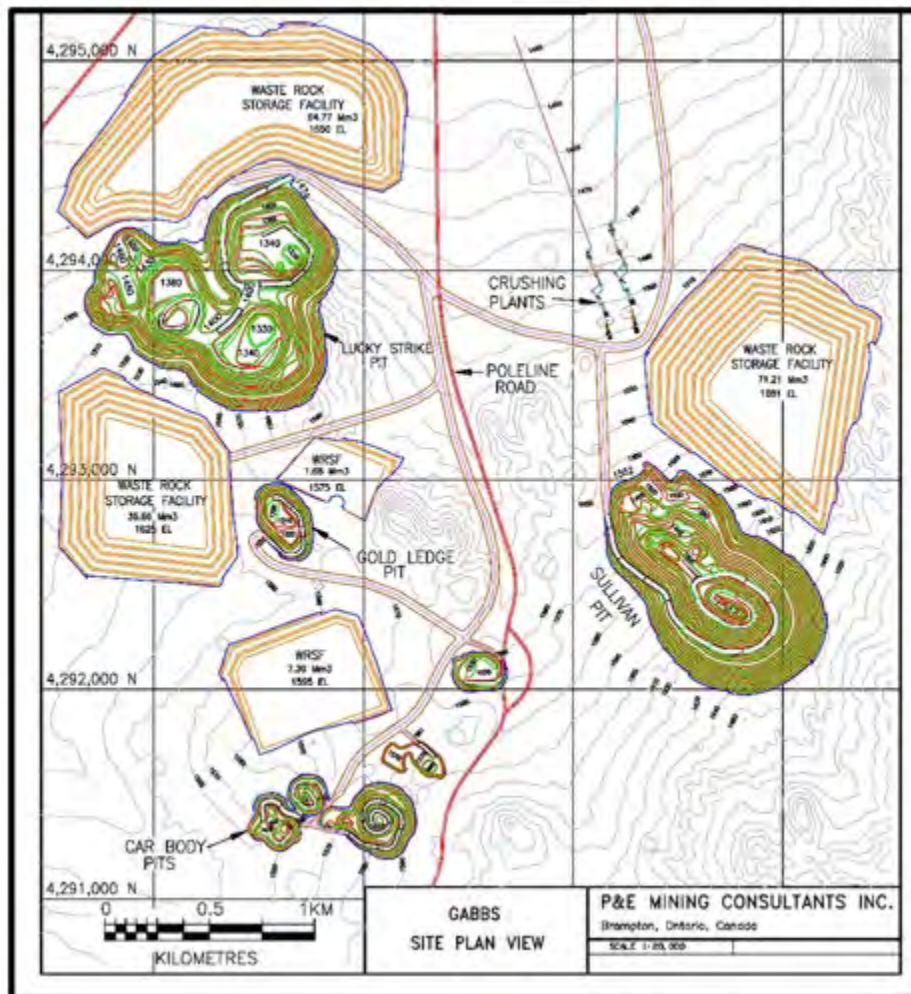

Figure 1-1 General Mine Layout

A series of Lerches-Grossman pit optimizations were completed separately for each deposit using NPV Scheduler™ software. The pit optimization step produced a series of nested pit shells each containing mineralized material that is economically mineable according to a given set of physical and economic parameters. An optimal shell was then selected as the basis for each pit design.

A mine production schedule was developed to supply 9.0 Mtpa (25,000 tpd) of oxide mineralized feed to the heap leach facility during the first five years while sulphide material is stockpiled for later processing. In Year 6, the flotation mill will be commissioned and will be supplied with sulphide feed at 5.0 Mtpa (14,000 tpd). The heap leach throughput will be decreased to 4.0 Mtpa (11,000 tpd) as of Year 6, and total feed crushing will remain at 9.0 Mtpa. The total quantity of oxide material sent to the heap leach facility is estimated at 79.3 Mt grading 0.44 g/t Au, 1.11 g/t Ag and 0.22% Cu, and 46.0 Mt of sulphide mineralization grading 0.43 g/t Au, 1.07 g/t Ag and 0.26% Cu will be sent to the flotation mill. A total of 125.3 Mt of mineralized feed is planned to be mined and processed. 399.3 Mt of waste rock is required to be mined, at a waste to mineralized ratio of 3.2:1. Approximately 37% of the total process plant feed is in the Indicated Mineral Resource classification. Dilution is estimated at 6% and mining recovery losses are estimated at 3%.

One year of pre-production mining is required. Open pit development has been divided into ten phases over the mine life. The production plan utilizes three stockpiles to facilitate processing higher grade material ahead of lower grade feed. The total annual mining rates of leach feed and waste rock combined will peak at approximately 56 Mtpa (150,000 tpd).

It is assumed that the Gabbs mine will be an owner-operated open pit mine. The Company would undertake all drill and blast, loading, hauling, and mine site maintenance activities. The owner will be responsible for mine management and technical services, such as mine planning, grade control, geotechnical, and surveying.

It is planned that the mining operations would be conducted 24 hours per day and 7 days per week throughout the entire year. It is expected that 15-m³ hydraulic excavators (CAT 6030 size) and a diesel-powered front-end loader (CAT 993 size) will be used to excavate the blasted rock. The anticipated truck size is 136 t, similar to the CAT 785. Rotary drills will use 250-mm diameter bits. The primary mining operation will be supported by a fleet of support equipment consisting of dozers, road graders, watering trucks, maintenance vehicles, and service vehicles. The mining personnel will peak at approximately 219 people, including operators, maintenance, supervision, and technical staff.

1.9 Recovery Methods

Test work results have indicated that the Gabbs mineralized material is amenable to heap leaching and milling/flotation for the recovery of gold, silver and copper.

1.9.1 Heap Leaching

The Gabbs mineralized heap leach material is estimated to contain an average of 0.22% copper based on the mine plan used for this study. A portion of this copper is cyanide soluble and is expected to be extracted in the heap leach circuit. The cyanide soluble copper has an effect on the cyanide consumption. A SART (Sulphidization, Acidification, Recovery, Thickening) plant that releases cyanide associated with the copper cyanide complex, allowing it to be recycled back to the leach process as free cyanide is included. The resulting copper precipitate will be sold, bringing additional revenue to the project.

The mineralized material will be mined by standard open-pit mining methods, crushed using a three-stage crusher incorporating a high-pressure grinding roll (HPGR) as the tertiary crushing stage, agglomerated with cement and conveyor stacked on the heap leach pad in 8-m lifts.

The pad will hold approximately 80 million tonnes and will be constructed in four phases. The heap leach pad will have a composite liner consisting of clay and textured HDPE geomembrane. In the first five years of operations, when heap leaching is the only processing method, oxide material will be processed at a rate of 9,000,000 tonnes per year. Upon startup of the mill in Year 6, oxide material will be processed by the heap leach at a rate of 4,000,000 tonnes per year.

Ore will be single-stage leached with a dilute cyanide solution. The gold, silver, and copper bearing solution will be collected in the pregnant solution pond and pumped to the SART plant. Pregnant solution will be acidified with sulphuric acid, then copper and silver will be precipitated as sulphides by the addition of sodium hydrosulphide. The precipitate will be thickened and filtered to produce a copper-silver filter cake for shipment to a smelter. The barren solution from the SART plant will be processed in a carbon adsorption-desorption-recovery (ADR) plant to recover gold. The gold will be periodically stripped from the carbon using a desorption process. The gold will be plated on stainless steel cathodes, removed by washing, filtered, dried and then smelted to produce a doré bar.

1.9.2 Milling

Sulphide material will be treated in a flotation/cyanidation mill at a rate of approximately 5,000,000 tonnes per year. The ROM material will be fine-crushed in a three-stage crushing

circuit, with the third stage being an HPGR. The crushed product will then be conveyed to a ball mill grinding circuit.

The milled sulphide product will be treated in a flotation plant to produce a copper concentrate suitable for sale. The flotation tailings will be thickened, then direct cyanide leached in a cyanidation circuit to dissolve gold, silver and copper. The leached solids will be washed in a countercurrent decantation (CCD) circuit to remove dissolved gold, silver and copper. The dissolved copper and silver will be recovered from the CCD overflow solution in a SART plant as a copper/silver sulphide precipitate. Regenerated sodium cyanide from the SART plant will be recycled to the leach circuit. Gold remaining in the SART plant barren solution will be recovered in an ADR plant and refined to doré.

CCD tails will be treated in a cyanide destruction circuit, filtered, and conveyed to a “dry stack” storage facility.

1.10 Infrastructure

Access to the Project site is by the paved Highway 361, southwest from Gabbs to Pole Line Road, and then 3.5 km (2.2 miles) south to the centre of the Property. A private road will enter the mine property and include a guard house. This road will provide access to the administration offices, mine, process plant and other Project facilities.

The site service roads are connected to the site access road and are used to join the site facilities. The combined service roads join the following areas:

- Administrative area;
- Primary crushing;
- Secondary and tertiary crushing;
- Leach pad;
- Mill;
- SART plant;
- ADR plant;
- Tailings storage facility.

1.11 Environmental Studies, Permitting and Social or Community Impact

The Project includes proposed exploration and potential future mining on unpatented lode mining claims on public U.S. Bureau of Land Management (BLM) lands and on one internal patented mining claim (private land).

In order to develop, operate, and close a mining operation, P2 Gold will be required to obtain a number of environmental and other permits from the BLM, the State of Nevada, and Nye County. Environmental baseline studies will need to be conducted at the Project area to meet federal and state requirements.

The permitting process will require the preparation of an Environmental Assessment (EA) or Environmental Impact Statement (EIS) under the National Environmental Policy Act (NEPA), Council of Environmental Quality (CEQ) regulations, and BLM guidelines and procedures.

Currently, P2 Gold holds two Notices of Intent with the BLM for exploration drilling and bulk sampling on approximately up to a combined 3.2 hectares (8 acres) of disturbance on unpatented mining claims. The Notices of Intent cover disturbance created to establish drill road access and drill sites at the Sullivan, Lucky Strike and Car Body areas. P2 Gold can disturb up to 2.0 hectares (5 acres) under each Notice of Intent.

The Gabbs Project property is located within the Gabbs Valley, and is remote from local communities, ranches, or residences. Residents of the nearby town of Gabbs, the larger town of Hawthorne, somewhat more distal, and the general regional area, have historically been supportive of mineral exploration and mine development projects. A labor workforce of experienced miners and exploration support staff is available regionally.

1.12 Capital and Operating Costs

The total Life of Mine (LOM) capital cost for the Project is US\$864.7 million, including US\$14.2 million in working capital and initial fills but not including reclamation and closure costs which are estimated at US\$56.4 million. Capital costs were based on 2nd Quarter 2024 US dollars and are of +/- 30% accuracy. Table 1-2 presents the capital requirements for the Gabbs Project.

**Table 1-2
Capital Cost Summary**

Description	Cost (US\$)
Pre-Production Capital	\$365,536,000
Working Capital & Initial Fills	\$14,199,000
Sustaining Capital – Mine & Process	\$484,917,000
Reclamation & Closure	\$56,405,000
Total	\$921,058,000

The average life of mine operating cost for the Project is US\$19.24 per tonne processed. Table 1-3 presents the LOM operating cost requirements for the Gabbs Project.

**Table 1-3
LOM Operating Cost Summary**

Description	LOM Cost (US\$/t)
Mine	\$6.73
Process & Support Services	\$11.78
Site G&A	\$0.73
Total	\$19.24

Mining costs were provided by P&E at US\$1.55 per tonne mined including stockpile rehandle (LOM US\$6.73 per tonne processed), and have been estimated from first principles.

Process operating costs have mainly been estimated by KCA from first principles. Labour costs were estimated using project specific staffing, salary and wage and benefit requirements. Unit consumptions of materials, supplies, power, water and delivered supply costs were also estimated. LOM average processing and associated support costs are estimated at US\$11.78 per tonne.

General administrative costs (G&A) have been estimated by KCA with input from P2. G&A costs include project specific labour and salary requirements and operating expenses, including social contributions, land access and water rights. G&A costs are estimated at US\$0.73 per tonne.

Operating costs were estimated based on 1st/2nd Quarter 2024 US dollars and are presented with no added contingency based upon the design and operating criteria present in this report. Operating costs are of +/- 30% accuracy.

The operating costs presented are based upon the ownership of all process production equipment and site facilities, including the onsite laboratory. The owner will employ and direct all process operations, maintenance and support personnel for all site activities.

1.13 Economic Analysis

Based on the estimated production schedule, capital costs and operating costs, a cash flow model was prepared by KCA for the economic analysis of the Gabbs Project. The information used in this economic evaluation has been taken from work completed by KCA and other consultants working on this project.

The project economics were evaluated using a discounted cash flow (DCF) method, which measures the Net Present Value (NPV) of future cash flow streams. The final economic model was based on the following assumptions:

- The mine production schedule from P&E.
- Period of analysis of 17 years including 2 years of investment and pre-production, 14.1 years of production and 1.6 years for reclamation and closure.
- Gold price of US\$1,950/oz.
- Silver Price of US\$25/oz
- Copper price of US\$4.50/lb.
- Processing rate of approximately 24,658tpd over LOM.
- Oxide heap leach recoveries of 78.3% for gold, 45% for silver and 54.0% for copper.
- Sulphide mill recoveries of 94.5% for gold, 50% for silver and 79.9% for copper.
- Capital and operating costs as developed in Section 21.0 of this report.

The Project economics based on these criteria from the cash flow model are summarized in Table 1-4.

**Table 1-4
Economic Analysis Summary**

Production Data		
Life of Mine	14.2	Years
Nominal Throughput per year	9,000,000	Tonnes/year
Operating Days per year	365	Days/Year
Grade Au (Avg.)	0.43	g/t
Grade Ag (Avg.)	1.09	g/t
Grade Cu (Avg.)	0.24	%
Contained Au, oz	1,749,000	Ounces
Contained Ag, oz	4,398,000	Ounces
Contained Cu, tonnes	295,000	Tonnes
Average Annual Gold Production	98,000	Ounces
Average Annual Silver Production	137,000	Ounces
Average Annual Copper Production	13,000	Tonnes
Total Gold Produced	1,472,000	Ounces
Total Silver Produced	2,058,000	Ounces
Total Copper Produced	190,000	Tonnes
LOM Strip Ratio (W:O)	3.19	
Operating Costs (Average LOM)		
Mining (moved)	\$1.55	/Tonne mined
Mining (processed)	\$6.73	/Tonne processed
Processing & Support	\$11.78	/Tonne processed
G&A	\$0.73	/Tonne processed
Total Operating Cost	\$19.24	/Tonne processed
Total By-Product Cash Cost	\$493	/Ounce Au
All-in Sustaining Cost	\$1,234	/Ounce Au
Capital Costs		
Initial Capital	\$377.7	Million
LOM Sustaining Capital	\$484.9	Million
Total LOM Capital	\$850.5	Million
Working Capital & Initial Fills	\$14.2	Million
Closure Costs	\$56.4	Million
Financial Analysis		
Internal Rate of Return (IRR), Pre-Tax	23.1%	
Internal Rate of Return (IRR), After-Tax	21.0%	
NPV @ 5% (Pre-Tax)	\$653.2	Million
NPV @ 5% (After-Tax)	\$550.0	Million
Pay-Back Period (Heap Leach, Years based on After-Tax)	3	Years

A sensitivity analysis was performed on the project economics. Figure 1-2 and Figure 1-3 are charts showing the relative sensitivity to a number of parameters.

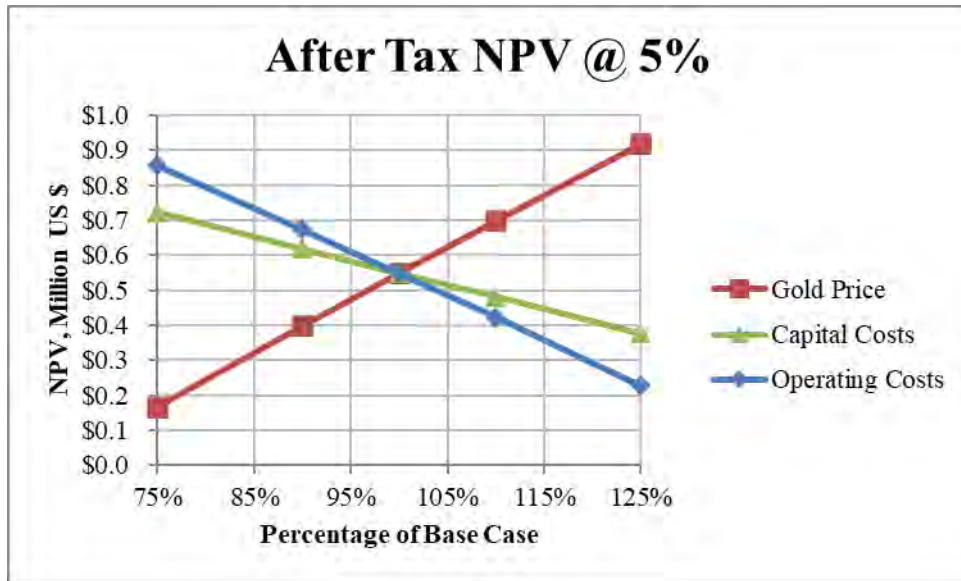

Figure 1-2 After-Tax NPV @ 5% vs. Gold Price, Capital Cost & Operating Cost

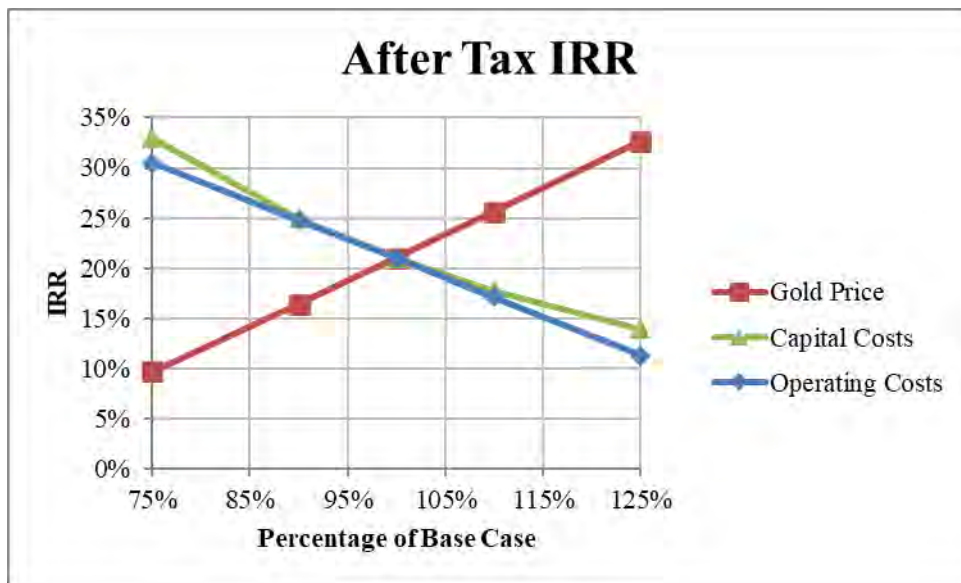

Figure 1-3 After-Tax IRR vs. Gold Price, Capital Cost & Operating Cost

On the effective date of 17 May 2024, based on the spot metal prices at the time, which were US\$2,414/oz, US\$31.48/oz and US\$4.71/lb for gold, silver and copper respectively, the after-tax NPV at 5% discount rate is US\$949.2 million and an after-tax IRR of 33.5%.

1.13.1 Forward Looking Information

This document contains “forward-looking information”.

1.13.2 Non-IFRS Measures

P2 has included certain non-International Financial Reporting Standards (IFRS) performance measures as detailed below. In the gold mining industry, these are common performance measures but may not be comparable to similar measures presented by other issuers and the non-IFRS measures do not have any standardized meaning. Accordingly, it is intended to provide additional information and should not be considered in isolation or as a substitute for measures of performance prepared in accordance with IFRS.

Cash Costs per Ounce – P2 calculated cash costs per ounce by dividing the sum of operating costs, royalty costs, production taxes, refining and shipping costs, net of by-product silver credits, by payable gold ounces. While there is no standardized meaning of the measure across the industry, P2 believes that this measure will be useful to external users in assessing operating performance.

All-In Sustaining Costs (“AISC”) – P2 has disclosed an AISC performance measure that reflects all of the expenditures that are required to produce an ounce of gold from operations. While there is no standardized meaning of the measure across the industry, P2’s definition conforms to the all-in sustaining cost (on a by-product basis) definition as set out by the World Gold Council in its guidance dated 27 June 2013. P2 believes that this measure will be useful to external users in assessing operating performance and the ability to generate free cash flow from current operations.

1.14 Interpretations and Conclusions

1.14.1 Conclusions

The work that has been completed to date has demonstrated that the Gabbs open pit mine with heap leach and mill facilities is a technically feasible and economically viable project. The property is conveniently located with access via Highway 361.

The Project has been designed as a conventional owner-operated open-pit mine with heap leaching of oxide material and milling of sulphide material for recovery of gold, silver and copper with a LOM production of 125.3 million tonnes with an average grade of 0.43 g/t Au, 1.09 gpt Ag and 0.24% Cu. Metallurgical test work on the material to date shows acceptable recoveries for gold, silver and copper with moderate reagent consumptions.

1.14.2 Opportunities

Key opportunities for the Gabbs project include:

- Considering contract mining to decrease capital costs required in Year 0;
- Additional test work to increase recoveries for oxide and sulphide mineralization and evaluate the use of HPGR for potential heap leaching of sulphide mineralization to increase recovery of free gold;
- Expand oxide gold, silver and copper mineralization in the Mineral Resource;
- Evaluate equipment alternatives to reduce capital costs;
- Optimize mine plan sequencing to increase return on capital.

1.14.3 Risks

Risks for the Gabbs project pertaining to mining, metallurgy, process, access, title, and permitting are summarized in the following sections.

1.14.3.1 Mining

The Mineral Resource Estimate is comprised of 37% Indicated Mineral Resources and 63% Inferred Mineral Resources. The Inferred Mineral Resources require in-fill drilling to be potentially converted to Indicated Mineral Resources for greater confidence and eligibility to become Mineral Reserves.

Pit slope geotechnical studies could impact favorably or negatively on the pit designs. Flattening of slopes could have a significant impact on the open pit waste rock quantity.

1.14.3.2 Metallurgy and Process

There is a risk that CIC and/or SART efficiencies may be poor, particularly during initial operations due to low pregnant solution concentrations of gold, silver and copper. This may result in increased reagent consumptions, reduced cyanide recovery and delayed or even lost metal recoveries. The mine production schedule is such that the highest grades are heap leached and milled first and so the most valuable parts of the deposit are at risk during initial operations.

1.14.3.3 Access, Title and Permitting

Changes to the Project assumptions could delay permitting.

1.14.3.4 Other Risks

Geotechnical or hydrogeological considerations during mining being different from what was assumed.

1.15 Recommendations

1.15.1 KCA Recommendations

Based on these results, the following future work is recommended by KCA:

- Comminution testing to establish power consumption and wear rates for conventional crushing and ball milling;
- Additional compacted permeability testing to define the cement addition required to stack different oxide materials to 70 m;
- Additional flotation testing with additional cleaning and locked-cycle testing to provide enough concentrate to determine concentrate penalty elements, and concentrate treatment (i.e., leaching of gold from final cleaner concentrate);
- SART concentrate evaluated for penalty elements, and flotation-SART concentrate blends evaluated to minimize penalty elements;
- Additional HPGR-crushed column leach testing to determine if the leach cycle can be reduced by adjusting the initial solution application rate and initial sodium cyanide concentration;
- Additional drilling completed as required to supply samples for metallurgical development programs.

The estimated cost for the metallurgical work is US\$300,000, not including costs for drilling or shipping of samples.

1.15.2 P&E Recommendations

It is recommended that the Company continue with the current sample preparation, security and analytical protocol at the Project, with the exception of modifying to a more suitable laboratory protocol for the Car Body Deposit samples. Recommendation is made to analyze all likely mineralized samples at the Car Body Deposit by a metallic screening procedure.

It is recommended that the Company complete an additional 12,500 m (41,000 ft) of reverse circulation drilling to further delineate and expand the oxide Mineral Resources. This exploration program is estimated to cost US\$2.0 million.

1.16 Welsh Hagen Recommendations

Initialization of baseline environmental studies is recommended to establish potential environmental permitting constraints associated with a potential future mine development project. Baseline studies that should be started include a Class III cultural resource inventory, and static and kinetic rock characterization of mineralized and waste rock materials.

The preparation of a BLM Exploration Plan of Operations (EPO) and Reclamation Plan will be needed to conduct exploration, geotechnical investigations or other surface disturbance programs that would exceed the maximum 5-acre surface disturbance limit allowed under a BLM Notice of Intent. An environmental assessment will be required before the EPO is approved by the BLM.

The estimated cost for the environmental and permitting work is US\$200,000.

2.0 INTRODUCTION

2.1 Introduction and Overview

This NI 43-101 Technical Report is a Preliminary Economic Assessment on the Gabbs Heap Leach and Mill Project and is in compliance with disclosure and reporting requirements set forth in the Canadian Securities Administrators' current "Standards of Disclosure for Mineral Projects" under the provisions of NI 43-101, Companion Policy NI 43-101 CP and Form NI 43-101F1.

This Technical Report is issued to P2 who is listed on the TSX-V Exchange (TSX-V: PGLD) and OTCQB Market (OTCQB:PGLDF) and holds a 100% interest in the Gabbs deposit. This report was prepared by KCA and P&E with input from other consultant groups and supersedes the previous Report titled "NI 43-101 Technical Report, Preliminary Economic Assessment, Gabbs Heap Leach and Mill Project, Nye County, Nevada, USA" with an effective date of 07 September 2023.

This Preliminary Economic Assessment commenced in February 2024 and was completed during July 2024.

2.2 Project Scope and Terms of Reference

2.2.1 Scope of Work

P2 commissioned KCA to evaluate the Gabbs Project to Preliminary Economic Assessment standards. This Report is led by KCA and incorporates work from other groups including P&E for the property geology, exploration, Mineral Resource Estimate and for mine development and costs, and Welsh Hagen for environmental studies, permitting, and social or community impacts. A more detailed scope description for each group is included below.

KCA's scope of work for the project is summarized as follows:

- Review of new and historical metallurgical tests and interpretation,
- Process design and recovery methods,
- Project access and title (based on Land Status Report)
- Infrastructure and process capital and operating costs,
- General and administrative (G&A) costs with input from P2 mining.
- Economic analysis, and
- Overall report preparation and compilation.

P&E's scope of work for the project is summarized as follows:

- Report on exploration work completed by P2, geological setting and mineralization,
- Audit the drill hole database for the Gabbs deposit,
- Develop the Mineral Resource block model for the deposit,
- Estimate the Mineral Resource,
- Develop an operational mine plan for the open pit, and
- Mining capital and operating costs.

Welsh Hagen's scope of work for the project is summarized as follows:

- Assessment of regulatory requirements and description of the permits for the mine plan described in this report,

The scope of this report also includes a study of information obtained from public documents; other literature sources cited; and cost information from public documents and recent estimates from previous studies conducted by KCA.

This Technical Report is intended to provide a preliminary evaluation of the project's potential economics and to give guidance for future studies on the Gabbs project.

2.2.2 Terms of Reference

The purpose of this Report is to disclose Mineral Resources for the Gabbs Project, and disclose an updated Mineral Resource estimate for the property. This report supports information disclosed in a press release dated 22 May 2024.

The units of measure presented in this report, unless noted otherwise, are in the metric system. The currency used for all costs is presented in US Dollars (US\$ or \$), unless specified otherwise. The costs were estimated based on quotes and cost data as of the 2nd Quarter 2024.

The economic evaluation of the Project has been conducted on a constant dollar basis (Q2 2024) with a gold price of US\$1,950 per ounce, silver price of US\$25 per ounce and a copper price of US\$4.50 per pound for the Base Case. Economic evaluation is done on a Project basis and from the point of view of a private investor, after deductions for government royalties and income taxes.

2.3 Sources of Information

KCA has taken all reasonable care in producing the information contained in this report. The information, conclusions and estimates contained in this report are consistent with information available at the time of preparation, the data supplied by outside sources and assumptions,

conditions and qualifications set forth in this report. The authors of this report are Carl Defilippi, Eugene Puritch, Andrew Bradfield, William Stone, Jarita Barry, David Burga and Douglas Willis each of whom is a Qualified Person as defined under NI 43-101.

The information in this report is not a substitute for independent professional advice before making any investment decisions. Any information in this report cannot be modified without the express written permission of KCA.

The primary sources of information used for this technical report are set out in Section 27, References, and include:

- The digital drillhole database.
- The original assay certificates for the holes.
- Various geologic solids that were developed (interpreted) by P2 geologists.
- Various reports, including previous reports on sampling methodology, quality control and quality assurance (QA/QC), resource modeling, geotechnical and slope stability, mine planning, and economic evaluations. These were developed by KCA, P&E, and various consultants.
- Various new reports for water production and supply and site geotechnical evaluations.
- Various reports on metallurgical testing, process recovery, and mineral processing that were developed by Cymet, Cyprus, Cuervo Gold, Gwalia, Arimetco, KCA, P2 and various consultants.
- Published reports on Nevada taxes and duties.

KCA, P&E and Welsh Hagen reviewed the data and only used data that were deemed reliable for this Report.

2.4 Qualified Persons and Site Visits

There is no affiliation between Mr. Defilippi, Mr. Puritch, Mr. Bradfield, Mr. Stone, Mr. Burga, Ms. Barry, Mr. Willis and P2, except that of an independent consultant / client relationship.

The processing studies, cost estimations, project financial analysis and review of current and historical metallurgical data were conducted by KCA under the auspices of Carl Defilippi, RM SME, of Reno, NV. Mr. Defilippi is an independent Qualified Person under NI 43-101 and is responsible for Sections 1.1, 1.2, 1.6, 1.9, 1.10, 1.12, 1.13, 1.14.1, 1.14.2, 1.14.3.2, 1.15.1, 2, 3, 4, 5, 6, 13, 17, 18, 19, 21.1.2 through 21.1.8, 21.2.2, 21.3, 22, 24, 25.1.3, 25.2.3, 25.3.2, 25.3.3, 26.1, 27, 28 and 29 of the Report. Mr. Defilippi visited the site on 30 September 2023. On this date, Mr. Defilippi inspected the Project site and proposed locations for the process facilities and site infrastructure.

Mr. David Burga, P.Geo., a Qualified Person as defined in NI 43-101, conducted a site visit to the Gabbs Property from 5 October to 6 October 2021. A data verification and sampling program was completed on-site. Confirmation samples from selected drill core intervals were taken by Mr. Burga and submitted to an independent assay laboratory for analysis, as described in Section 12 of this Technical Report. Mr. Burga is not aware of any material changes to the Project since his site visit. Mr. Burga is an independent Qualified Person under NI 43-101 and is responsible for Sections 1.4, 9, 10 and 12.2.1 of the Report.

Mr. Puritch is an independent Qualified Person under NI 43-101 and is responsible for Sections 1.7, 1.15.2, 14, 25.1.1, 25.2.2 and 26.2 of the Report. Mr. Puritch has not visited the Property.

Mr. Bradfield is an independent Qualified Person under NI 43-101 and is responsible for Sections 1.8, 1.14.3.1, 15, 16, 21.1.1, 21.2.1, 25.1.2, 25.2.1 and 25.3.1 of the Report. Mr. Bradfield has not visited the Property.

Mr. Stone is an independent Qualified Person under NI 43-101 and is responsible for Sections 1.3, 7, 8 and 23 of the Report. Mr. Stone has not visited the Property.

Ms. Barry is an independent Qualified Person under NI 43-101 and is responsible for Sections 1.5, 11, 12.1, 12.2.2 and 12.3 of the Report. Ms. Barry has not visited the Property.

The environmental studies, permitting and social or community impact evaluation was conducted by Douglas Willis, CPG of Welsh Hagen Associates. Mr. Willis is an independent Qualified Person under NI 43-101 and is responsible for Sections 1.11, 1.16, 20, 25.1.4 and 26.3 of the Report. Mr. Willis has not visited the site.

The effective date of the Mineral Resource is 29 April 2024. The effective date of this Technical Report is 17 May 2024. The signed date of this Technical Report is 03 July 2024.

2.5 Frequently Used Acronyms, Abbreviations, Definitions and Units of Measure

All costs are presented in United States dollars. Units of measurement are metric. Only common and standard abbreviations were used wherever possible. A list of abbreviations used is as follows:

Distances:	mm	– millimetre
	cm	– centimetre
	inch or in	– inch, US customary unit

	m	– metre
	feet or ft	– foot, US customary unit
	km	– kilometre
	mile or mi	– mile, US customary unit
	mbgl	– metres below ground level
	masl	– metres above sea level
Areas:	m ² or sqm	– square metre
	ha	– hectare
	acre or ac	– acre, US customary unit
	km ²	– square kilometre
	mile ² or mi ²	– square mile, US customary unit
Weights:	oz	– troy ounces
	Koz	– 1,000 troy ounces
	Moz	– 1,000,000 troy ounces
	g	– grams
	kg	– kilograms
	pound or lb	– pound, US customary unit
	T or t	– tonne (1000 kg)
	kt	– 1,000 tonnes
	Mt	– 1,000,000 tonnes
Time :	min	– minute
	h or hr	– hour
	op hr	– operating hour
	d	– day
	yr	– year
	Ma	– Mega-annum (one million years)
Volume/Flow:	m ³ or cu m	– cubic metre
	m ³ /h	– cubic metres per hour
	L/s	– litres per second
Assay/Grade:	g/t	– grams per tonne
	kg/t	– kilograms per tonne
	g/t Au	– grams gold per tonne
	g/t Ag	– grams silver per tonne
	% Cu	– percent copper
	ppm	– parts per million;
	ppm _v	– parts per million (volume basis);
	ppb	– parts per billion
Other:	TPD or tpd	– metric tonnes per day
	ktpy	– 1,000 tonnes per year
	kph	– kilometres per hour

m ³ /h/m ²	– cubic metres per hour per square metre
Lph/m ²	– litres per hour per square metre
L/s/km ²	– litres per second per square kilometres
g/L	– grams per litre
Ag	– silver
As	– arsenic
Au	– gold
Ba	– barium
Cu	– copper
Hg	– mercury
Pb	– lead
Sb	– antimony
Zn	– zinc
US\$ or \$	– United States dollar
C\$	– Canadian dollar
NaCN	– sodium cyanide
TSS	– total suspended solids
TDS	– total dissolved solids
DDH	– diamond drill boreholes
LOM	– life of mine
RAB	– rotary air blast
ROM	– run of mine
RC	– reverse circulation
RQD	- rock quality data
Preg	– pregnant solution
kWh	– kilowatt-hours
V	– volts
kVa	– kilo-volt-ampere
amp	– ampere
TEM	– transient electromagnetic
P ₈₀	– 80% passing
P ₁₀₀	– 100% passing
kN	– kilonewton
°C	– degree Celsius
°F	– degree Fahrenheit, US customary
kPa	– kilopascal
psig	– pounds per square inch (gauge), US customary
CMU	– concrete masonry unit
HLP	– heap leach pad
TSX-V	– TSX Venture Exchange



Owner – P2 Gold Inc.
WGS84 – World Geodetic System (1984) coordinates

3.0 RELIANCE ON OTHER EXPERTS

The author of this Technical Report section has not conducted a review of the status of the Gabbs Property mining claims with the BLM. The author of this Technical Report section has reviewed a Mineral Status Report dated June 20, 2023, provided to P2 Gold Inc. from the firm of Erwin Thompson Faillers, Suite 210, 241 Ridge Street, Reno, Nevada 89501. The letter states that as of June 20, 2023, the 543 unpatented lode mining claims included in the Gabbs Property are valid and in good standing under applicable laws and regulations until September 1, 2023 (which is when the next payments are due to BLM) and that title to the patented mining claim included in the Gabbs Property is vested in P2 Gabbs Inc., a wholly-owned subsidiary of P2 Gold Inc. The above-mentioned reliance on mining claims title supports Section 4 of this Technical Report.

Except for the purposes legislated under provincial securities laws, any use of this report by any third party is at that party's sole risk.

4.0 PROPERTY DESCRIPTION AND LOCATION

4.1 Property Location

The Gabbs Property is located in west-central Nevada, western United States (Figure 4-1). The Property is situated in the Fairplay Mining District, on the southwest flank of the Paradise Range, approximately 238 km (148 miles) east-southeast of Reno and 9 km (5.6 miles) south-southwest of the Town of Gabbs, Nye County, Nevada. The Sullivan Deposit near the centre of the Property, is located at UTM WGS84 Zone 11N 417,580m E, 4,292,950m N or Longitude 117°56'56" W and Latitude 38°46'53" N. The Gabbs Property lies within Sections 28, 29, 30, 31 T11N, R36E, as shown on the USGS Gabbs 7.5-minute quadrangle map.



Source: P2 Gold (Corporate Presentation, January 2022); modified by P&E (February 2022)

Figure 4-1 Gabbs Property Location, Nevada

4.2 Property Description and Mineral Concession Status

The Gabbs Property consists of 543 unpatented lode claims and one patented lode claim which constitute an approximately 45.25 km² (4,525 ha or 16 miles²) contiguous claim block (Figure 4-2 and Table 4-1). A complete list of the 543 staked claims is provided in Appendix F of this Technical Report.

In February 2021, P2 Gold entered into the agreement with Borealis Mining Company, LLC (“Borealis”), an indirect, wholly-owned subsidiary of Waterton Precious Metals Fund II Cayman, LP (“Waterton”) to acquire the original 355 unpatented lode claims and the one patented lode claim comprised the original Gabbs Property. Under the terms of the purchase agreement, P2 Gold agreed to pay: (a) US\$5 million and issue 15 million shares in its capital to Waterton at closing; and (b) an additional US\$5 million to Waterton on the earlier of the announcement of the results of a Preliminary Economic Assessment and the 24-month anniversary of closing.

The purchase agreement was amended in May 2021. Under the amended agreement, P2 Gold agreed to pay US\$1 million and issue 15 million shares in its capital to Waterton at closing. In addition, P2 Gold was required to pay Waterton Nevada Splitter LLC (“Splitter”), an affiliate of Borealis, (a) US\$4 million on the first anniversary of closing; and (b) US\$5 million on the earlier of the announcement of the results of a preliminary economic assessment and the 24-month anniversary of closing. Borealis reserved for itself a 2% net smelter returns royalty on production from the Gabbs Property, of which one percent may be repurchased at any time by P2 Gold for US\$1,500,000 and the remaining one percent of which may be repurchased for US\$5,000,000. The Bill of Sale was issued by Borealis to P2 Gold later that month.

In July 2021, P2 Gold staked 66 additional lode claims to expand the Gabbs Property primarily southwestwards. In February 2022, P2 Gold staked 122 additional lode claims to expand the Gabbs Property primarily northwards (Figure 4.2).

The purchase agreement was amended in April 2022. Under the amended terms, P2 Gold would pay Splitter (a) US\$500,000 on May 31, 2022; (b) US\$500,000 on December 31, 2022, if P2 Gold completed an equity financing in the second half of 2022; and (c) US\$8,000,000 or US\$8,500,000 on May 14, 2023 (depending on whether US\$500,000 was paid on December 31, 2022), provided that if P2 Gold announced the results of a preliminary economic assessment prior to May 14, 2023, all outstanding payments would be due on the earlier of 60 days following the announcement of such results and May 14, 2023, and if P2 Gold sold an interest in the Gabbs Project at any time, including without limitation, a royalty or stream, the proceeds of such sale are to be paid to Splitter up to the amount remaining outstanding.

The purchase agreement was amended in March 2023. Under the amended terms, P2 Gold would pay to Splitter (a) US\$150,000 on or before December 31, 2023, (b) US\$250,000 on or before December 31, 2024, (c) US\$2,000,000 on or before December 31, 2025 and (d) US\$2,400,000 on or before December 31, 2026. If P2 Gold raises, through the issuance of debt or equity, in excess of \$7,500,000 (excluding flow-through funds), 10% of the funds raised will be paid to Splitter against the longest dated milestone payment and on the sale of an interest in, or of, Gabbs Project, the proceeds will be paid to Splitter up to the amount outstanding at the time. In addition, P2 Gold issued to Splitter a US\$4,000,000, zero coupon convertible note with a four-year term convertible at a price of C\$0.30 per share provided that the convertible note cannot be converted if all payments due under the Second Amended Agreement have been made at the time the convertible note is called (other than if a change of control is to occur prior to repayment of the convertible note). The convertible note can be called at any time on payment of 115% in the first year, 130% in the second year and 150% thereafter and is due on maturity, an event of default or a change of control. Under the terms of the convertible note, approval by the shareholders of P2 Gold is required if conversion of the convertible note would make Waterton (including affiliated entities) a control person (as defined in the Exchange's Corporate Finance Manual).

4.3 Permits

Approval from the Bureau of Land Management ("BLM") is required before exploration work can be carried out. The BLM oversees and approves how much of the surface can be disturbed for exploration purposes and manages reclamation bonding.

4.4 Royalties

Waterton will have a 2% net smelter returns royalty on production from the Gabbs Property of which 1% may be re-purchased at any time by P2 Gold for US\$1,500,000 and the remaining 1% of which may be re-purchased for US\$5,000,000.

4.5 Other Liabilities

There are no environmental liabilities associated with the Gabbs Property claims, and there are no other known risks that would affect access, title, or the right or ability to perform work on the Property.

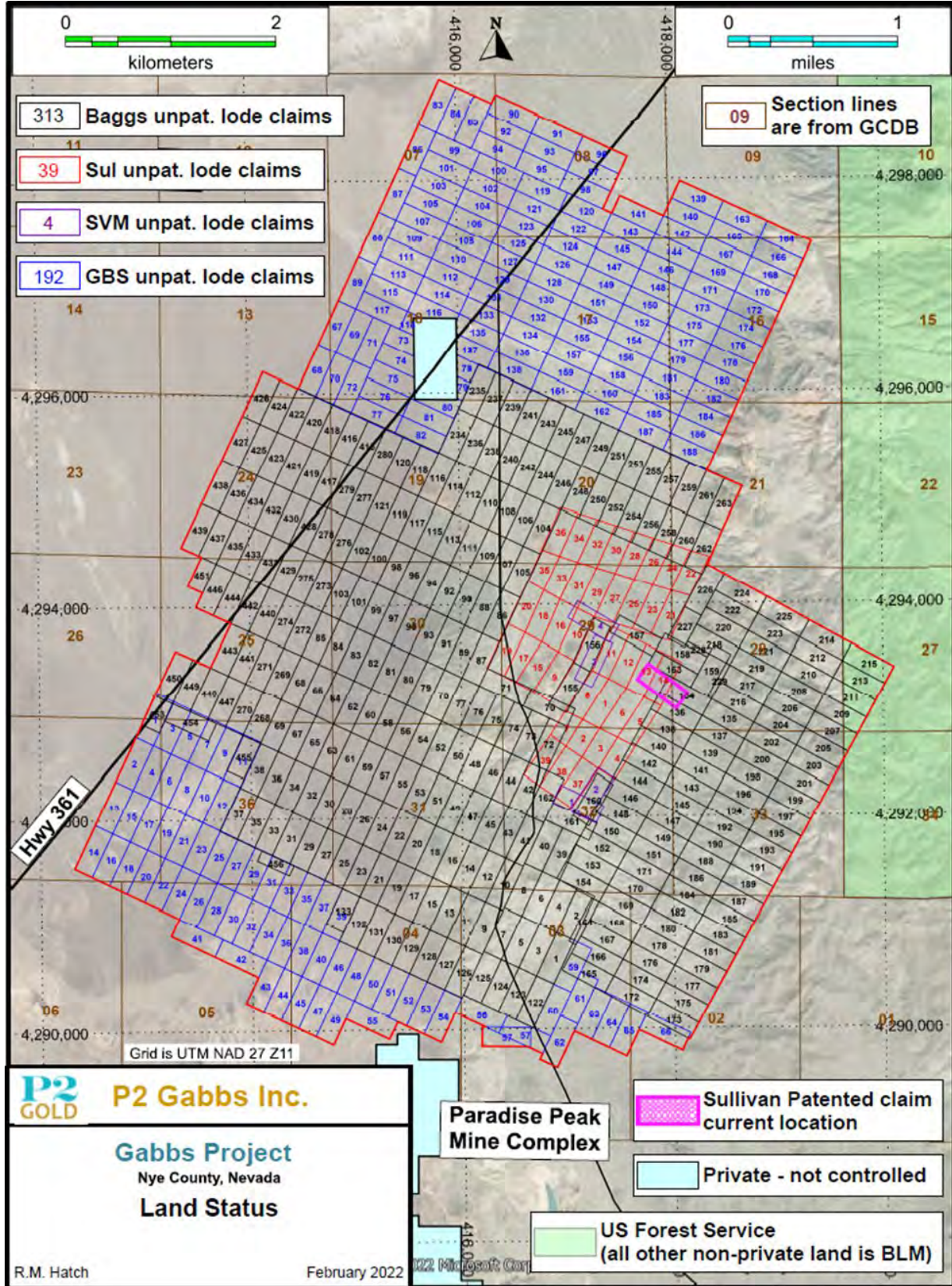

Figure 4-2 Gabbs Property Claim Map

P2 Gold is required to pay an annual Maintenance Fee that is currently US\$165 per unpatented lode claim to Bureau of Land Management. The aggregate annual fee for the Gabbs Property is due September 1st of each year for the subsequent assessment year. The patented claim requires payment of an annual tax assessment that is currently US\$50.26 per year. The claims do not expire as long as the annual fees are remitted to the respective agencies (Table 4-1).

**Table 4-1
Gabbs Property Claims Summary**

Claim Name	Claim No.	Number of Claims	Date of Location	Notes
Sullivan Lode	2156	1	Apr-04	Patent #42614 granted 7 June 1905.
				Mis-located in records
SUL	1-39	39	Aug-1969	Originally located by Omega Resources (Kenneth and Joan Palosky)
BAGGS	1-162	162	Nov-02	Located by Newcrest Resources Inc.
BAGGS	163	1	Feb-04	
BAGGS	164-229	66	Mar-07	
BAGGS	234-263	30	Sep-07	
BAGGS	268-280	13	Sep-07	
BAGGS	415-439	25	Apr-08	
BAGGS	440-444	5	May-08	
BAGGS	446-451	6	May-08	
BAGGS	453-456	4	May-08	
SVM	1-4	4	Mar-11	
GBS	1-66	66	Jul-21	Located by P2 Gabbs Inc.
GBS	67-188	122	Feb-22	Located by P2 Gabbs Inc.

Notes: Tenure information effective January 17, 2022 (BLM Mining Claim Report)

All claims are current and the claim maintenance fees to September 1, 2022 have been filed with the Bureau of Land Management ("BLM").

5.0 ACCESSIBILITY, CLIMATE, LOCAL RESOURCES, AND PHYSIOGRAPHY

5.1 Accessibility

The Gabbs Property is accessible from Reno by driving 56 km (34.8 miles) east on Interstate 80 to Fernley (Exit 48), 118 km (73.3 miles) east on US Highway 50 to Middlegate, and then 50 km (31 miles) south on Nevada State Highway 361 to Gabbs. From Gabbs, continue driving 7 km (4.3 miles) southwest on Highway 361 to Pole Line Rd, and then 3.5 km (2.2 miles) south to the centre of the Property (Figure 5-1 and Figure 5-2).



Source: P2 Gold Inc. (2021); modified by P&E (February 2022)

Figure 5-1 Gabbs Property Access

5.2 Local Resources and Infrastructure

The town of Gabbs has very limited services. However, most services and supplies can be acquired in the town of Fallon, NV (population 8,525), which is 120 km (75 miles) northwest of the site or the town of Hawthorne which is 90 km (55 miles) west-southwest of the site (Figure 5-1 and Figure 5-2). Experienced mining personnel are available from the local communities of Gabbs, Hawthorne and Fallon.

Highway 89, a well-maintained gravel road (also known as the Pole Line Road) with a power transmission line, crosses the Property west of the Sullivan Mine area (Figure 5-2). A major power transmission line is 30 km away.



Source: P2 Gold (Corporate Presentation, February 2022); modified by P&E (2022)

Figure 5-2 Gabbs Property Infrastructure

There is no source of water on the Property at present, however, groundwater could be accessed on approval of a water drilling application. A water permit was obtained historically for

the Gabbs Property. According to the State of Nevada's Division of Water Permit website, Permit #50803 was held by the Omega Resource Company for the Sullivan Property, and the specified use is for processing and mining. Newcrest acquired the water permit along with the Sullivan Property from Arimetco Inc. After field investigation in 2007, it was determined that either no well was drilled, or it was abandoned. Due to the well's location, Newcrest withdrew its interest in maintaining and perfecting a well. The permit's current status is listed as "Withdrawn".

P2 Gold has the legal right, including surface rights, to conduct exploration on its unpatented claims and the right to operate a mine on the completion of the permitting application with the Bureau of Land Management and State of Nevada.

5.3 Physiography

The Property is situated in an area of dry rolling hills cut by shallow, dry drainages and is bounded on the west by the Gabbs Valley, and on the east by the northeast trending Paradise Range. The surface elevations for the Property area range from 1,395 masl (4,578 ft) on the northwest corner of the claim block to 1,770 m asl (5,800 ft) on the southeast edge of the Property (Figure 5-3).

Vegetation is sparse, with approximately 25% coverage by grasses and low shrubs of greasewood, sage, shad scale, and rabbit brush. Animals observed during visits to the Property include various lizards, snakes, rabbits, ground squirrels, insects, and the occasional deer, antelope and wild horse.



Source: P2 Gold (website February 2022)

Figure 5-3 Gabbs Property Physiography – Looking Southeast

5.4 Climate

The climate is typical for the arid high Great Basin Desert, with temperatures ranging from a July average daily high of 33°C (95°F), with an average daily low of 13°C (56°F) and a January daily high at 7°C (45°F) with an average daily low of -7°C (20°F). The extreme temperatures reported for the Gabbs Property are 42°C (107°F) and -27°C (-37°F). Annual precipitation is 14.8 cm (5.84 in). The wettest month is normally May, but precipitation can occur throughout the year.

The Gabbs Property is accessible for exploration and mining for most of the year, although temporary weather delays can occur during the winter months of January through March.

6.0 HISTORY

6.1 Regional Exploration

The Gabbs Property is situated in the north-western end of the Fairplay Mining District, an area that has been extensively explored by several companies and individuals since the late 1800s.

The mining potential in the area is demonstrated by the Paradise Peak Deposit, a high-sulphidation epithermal gold-silver-mercury deposit discovered in 1983 and mined by FMC Corporation from 1985 to 1993. Total production was 1.46 million ounces gold, 38.9 million ounces silver, and 457 tonnes of mercury. The Paradise Peak Mine is adjacent to the south boundary of the Gabbs Property (Figure 6-1).

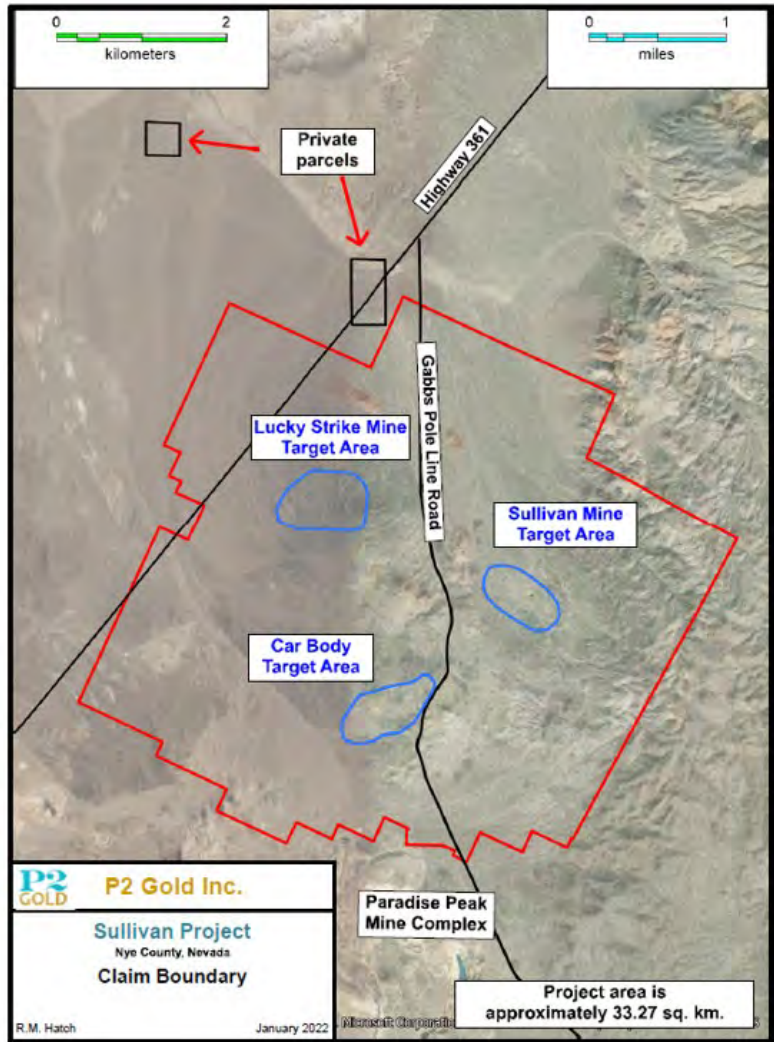

Source: P2 Gold (January 2022)

Figure 6-1 Paradise Peak Gold-Silver Mine

6.2 Historical Exploration of the Gabbs Property

The Gabbs Property has been explored intermittently by various operators since the 1880s, particularly since the late 1960s. At least 500 drill holes have been completed on the Property, of which approximately half targeted the Sullivan porphyry gold-copper deposit. A brief summary of the exploration history of the Gabbs Property is given in Table 6-1.

Table 6-1
Summary of Historical Exploration on the Gabbs Property

Year(s)	Ownership	Historical Exploration Description
Late 1880s to early 1900s	John Sullivan	The earliest recorded work in the Gabbs Property area was at the Sullivan Mine area with the location of the Sullivan Lode Claim, recorded on January 9, 1888 after John Sullivan discovered a ledge of gold more than 366m in length and from 61m to 123 in width. A shaft 30m deep with an accompanying crosscut was dug at Sullivan during this period. The Sullivan claim was patented as the Sullivan Lode on June 7, 1905 (Danner, 1992).
1905-1967	N/A	Little recorded history on the Property was available during this period.
1967-1969	Omega Resources	In 1969, the Property was acquired by Kenneth and Joan Palosky.
1970	McIntyre Mines	In 1970, McIntyre Mines optioned the Sullivan Property, and completed 16 drill holes (a mixture of rotary and drill core), targeting a porphyry copper-style system.
1971	Homestake Mining	Homestake Mining completed 16 additional drill core and rotary holes at the Sullivan Deposit in 1971.
1974-1976	Cominco	Between 1974 and 1976, Cominco completed 11 drill holes (rotary and drill core) in the Sullivan, Gold Ledge and Lucky Strike areas.
1977	Seremex	Seremex completed four drill core holes in the Sullivan area in 1977.
1978	UV Industries	In 1978, UV Industries completed two diamond holes in the Sullivan area.
1978-1979	Omega Resources	From 1978-1979, the Palosky's completed five RC drill holes at Sullivan.
1980-1983	Cyprus/Amoco Dee Gold	Cyprus/Amoco joint-venture completed 65 rotary drill holes between 1980 and 1983 at Sullivan, and one near Lucky Strike. Validation drilling conducted by Dee Gold in 1983 involved drilling four "twin" holes to confirm prior drill results.
1984-1986	Placer American	Between 1984 and 1986, Placer American (Placer Dome) completed four reverse circulation ("RC") drill holes at Sullivan, 99 RC drill holes at Car Body, 13 reverse-circulation drill holes at Lucky Strike, eight reverse-circulation drill holes at Gold Ledge, and 32 reverse-circulation drill holes elsewhere on or near the Property.
1987-1989	Glamis Gold/ Cuervo Gold	Glamis Gold/Cuervo Gold completed 117 air track drill holes at Sullivan and excavated a 30,000-ton test leach open pit.
1990	Gwalia Gold Mining	In 1990, Gwalia Gold Mining completed 14 drill holes (reverse-circulation and drill core) at Sullivan and produced a Pre-Feasibility Study.
1991-1992	FMC Gold	From 1991-1992, FMC Gold completed 74 reverse-circulation drill holes south of Sullivan and east of Paradise Peak Mine on the Gabbs Property.
1995	Arimetco	Arimetco acquired the Property in 1995 and completed four drill core holes at Sullivan and produced a Pre-Feasibility Study and Plan of Operations with expectations to mine the Sullivan resource. Arimetco filed for bankruptcy on the Property, due to lack of funding and low metal prices.
1996-2001	No activity	Exploration activities on the Property ceased until 2002, when Newcrest staked the Property.
2002-2008	Newcrest Resources	Newcrest staked the Property in 2002 (excluding the Sullivan area), and subsequently bought the Sullivan area in 2005 from Arimetco in bankruptcy court. Newcrest completed 24,765m (81,250 ft) of reverse-circulation and core in 87 drill holes through 2008. Newcrest performed petrographic studies (Mason, 2008 and Thompson, 2006), extensive rock and soil geochemical sampling, mapping ground magnetics, and induced polarization across the Property. Newcrest also produced a Mineral Resource Estimate for the Sullivan that took in consideration of historical and current Newcrest drilling.
2009-2010	Newcrest/St. Vincent	Newcrest decided in 2009 to divest all remaining properties in the U.S. St. Vincent acquired the Property in October 2010.

According to Fierst (2009), the earliest recorded work in the Gabbs Project area was at the Sullivan Mine (Figure 6-1). Discoveries in the area in the early 1880s led to a new mining district called the Globe district in 1883 (Danner, 1992). The Sullivan Lode Claim was recorded on January 9, 1888 by James D. Sullivan of San Francisco, following the discovery of a ledge of gold >366 m long and 61m to 122 m wide (Danner, 1992). At least one shaft was dug at Sullivan during this time (Figure 6-2), up to 30 m deep with an accompanying crosscut. The Sullivan Mine was patented as the Sullivan Lode on June 7, 1905 by the Nevada Company (Danner, 1992). Little is known of activities from then until the late 1960s.

In 1969, the Property was acquired by Kenneth and Joan Palosky, who then leased it to several companies during the following two decades. In 1970 McIntyre Mines optioned the Sullivan property, and completed 16 drill holes (rotary and core) looking for a porphyry copper system. Homestake completed 16 drill holes (rotary and core) in 1971. Between 1974 and 1976, Cominco completed eleven drill holes (rotary and core) in the Sullivan, Gold Ledge and Lucky Strike areas. In 1977, Seremex completed four core drill holes in the Sullivan area. In 1978, UV Industries completed two diamond drill holes in the Sullivan area. From 1978-1979, the Paloskys completed five RC drill holes at Sullivan. Cyprus/Amoco completed 65 rotary drill holes between 1980 and 1983 at Sullivan, and one near Lucky Strike. In 1983, Dee Gold completed four “twin” drill holes to validate previous drilling. Between 1984 and 1986, Placer American (Placer Dome) completed four RC drill holes at Sullivan, 99 RC drill holes at Car Body, 13 RC drill holes at Lucky Strike, eight RC drill holes at Gold Ledge, and 32 RC drill holes elsewhere on or near the Property. Between 1987 and 1989, Glamis Gold/Cuervo Gold completed 117 air track drill holes at Sullivan and excavated a 30,000-ton test leach open pit (Figure 6-3). In 1990, Gwalia completed 14 drill holes (RC and core) at Sullivan. From 1991 - 1992, FMC completed 74 RC drill holes south of Sullivan (east of Paradise Peak Mine). Finally, in 1995 Arimetco completed four core drill holes at Sullivan.



Source: Fierst (2009)

Figure 6-2 Original Shaft Collar at Sullivan Mine



Source: Fierst (2009)

Figure 6-3 Open Pit Excavation at Sullivan Mine

Recent historical exploration on the Gabbs Property was performed by Newcrest Resources (“Newcrest”) from 2002 to 2008 and St. Vincent Mineral Inc. (“St. Vincent”) in 2011. The exploration work completed by Newcrest and by St. Vincent is summarized below.

6.2.1 Newcrest Resources Inc. (2002 to 2008)

Newcrest exploration work on the Gabbs Property consisted of geochemical surveys, geophysical surveys, and drilling programs. These surveys and programs are summarized below from Fierst (2009).

6.2.1.1 Geochemical Exploration

Between 2002 and 2008, Newcrest collected approximately 900 surface rock chip samples from the Gabbs Property. Sampling was concentrated around zones of known mineralization and, unsurprisingly, anomalous to potentially economic gold and, to a lesser extent, copper values are concentrated in these zones (Figure 6-4 and Figure 6-5). Sampling outside the mineralized zones mostly returned low values and no deposit scale geochemical zoning is apparent. A soil survey was undertaken on the Gabbs claim block in March and April of 2008. A total of 1,383 soil samples were collected at 50m spacing along lines 200m apart. Following an orientation survey of 30 samples that were analysed for a suite of 30 elements, it was determined that the remainder of the survey could be done for gold and copper only since no anomalous pathfinder elements appeared to correlate with gold and copper mineralization. (Figure 6-6 and Figure 6-7). Anomalous copper and, to a lesser extent, gold values are concentrated around the Sullivan, Gold Ledge and Lucky Strike porphyry gold-copper zones. Samples taken outside these mineralized zones mostly returned low values and no deposit scale geochemical zoning is apparent. The Car Body Deposit was not covered by the soil survey.

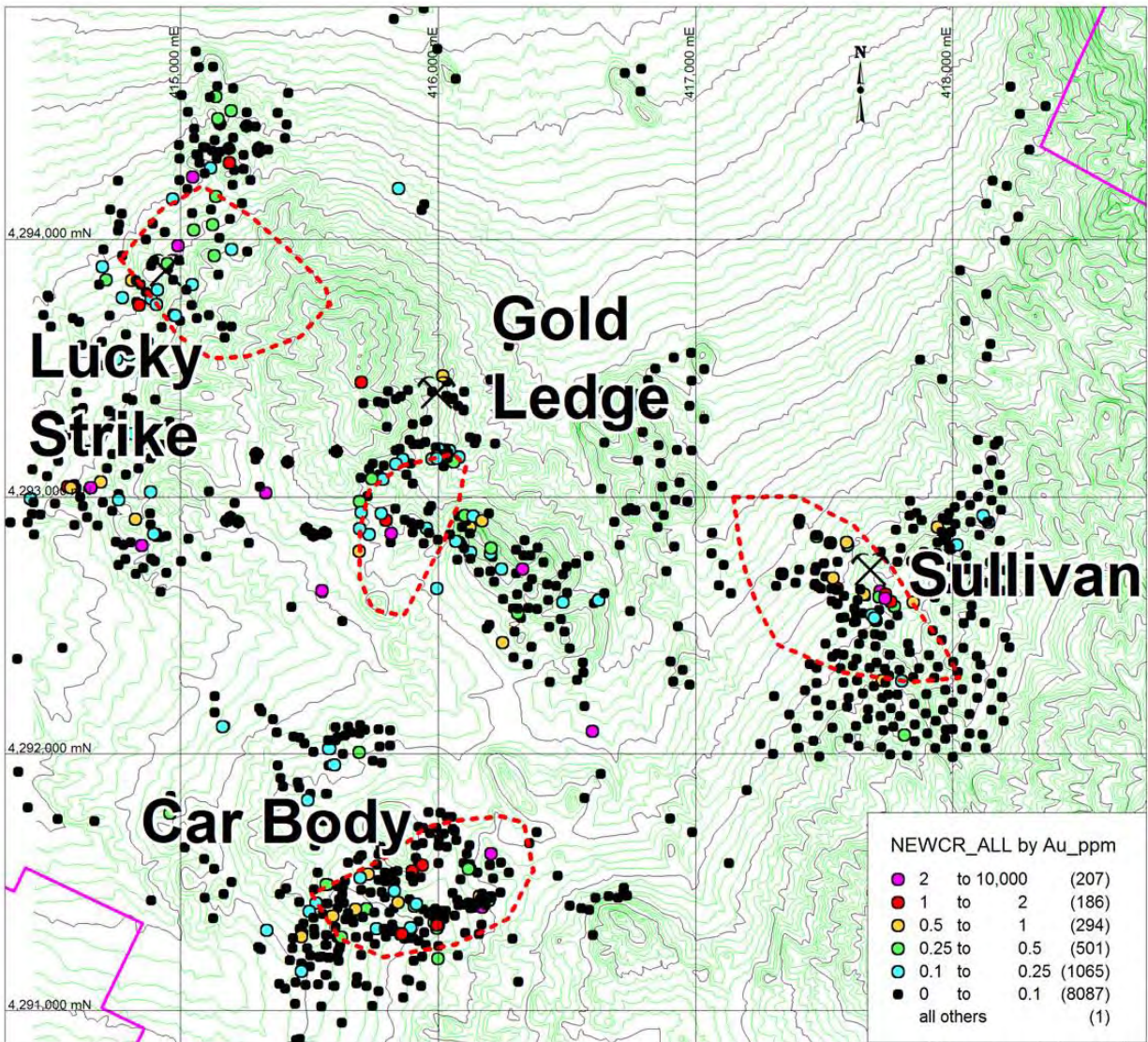

Source: Fierst (2009)

Figure 6-4 Rock Chip Sample Locations and Gold Values in the Gabbs Claim Block

In Figure 6-4, sampling is concentrated around zones of known mineralization. Anomalous to potentially economic gold values are concentrated in these zones.

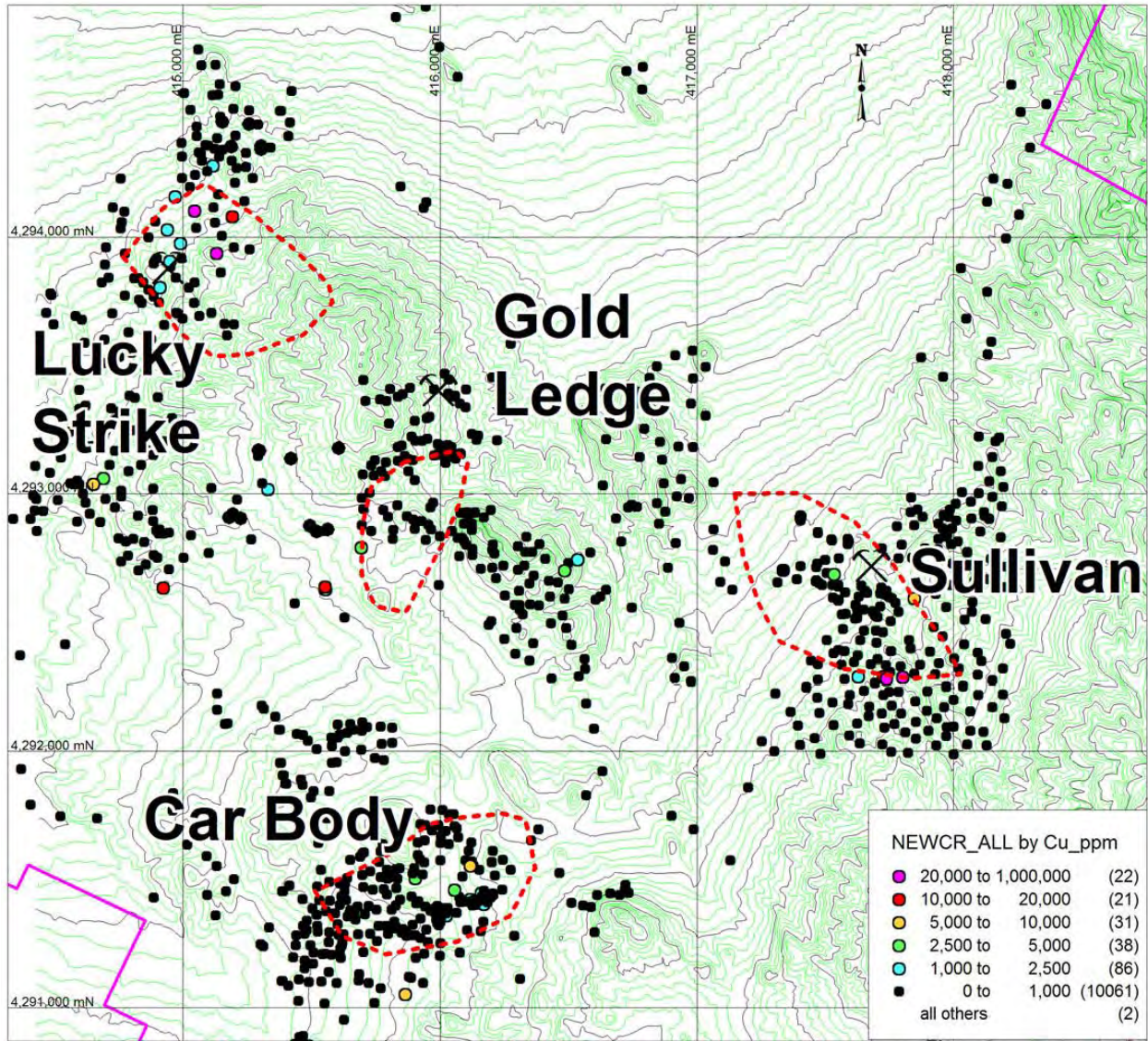

Source: Fierst (2009)

Figure 6-5 Rock Chip Sample Locations and Copper Values in the Gabbs Claim Block

In Figure 6-5, sampling is concentrated around zones of known mineralization. Anomalous to potentially economic copper values are concentrated in these zones.

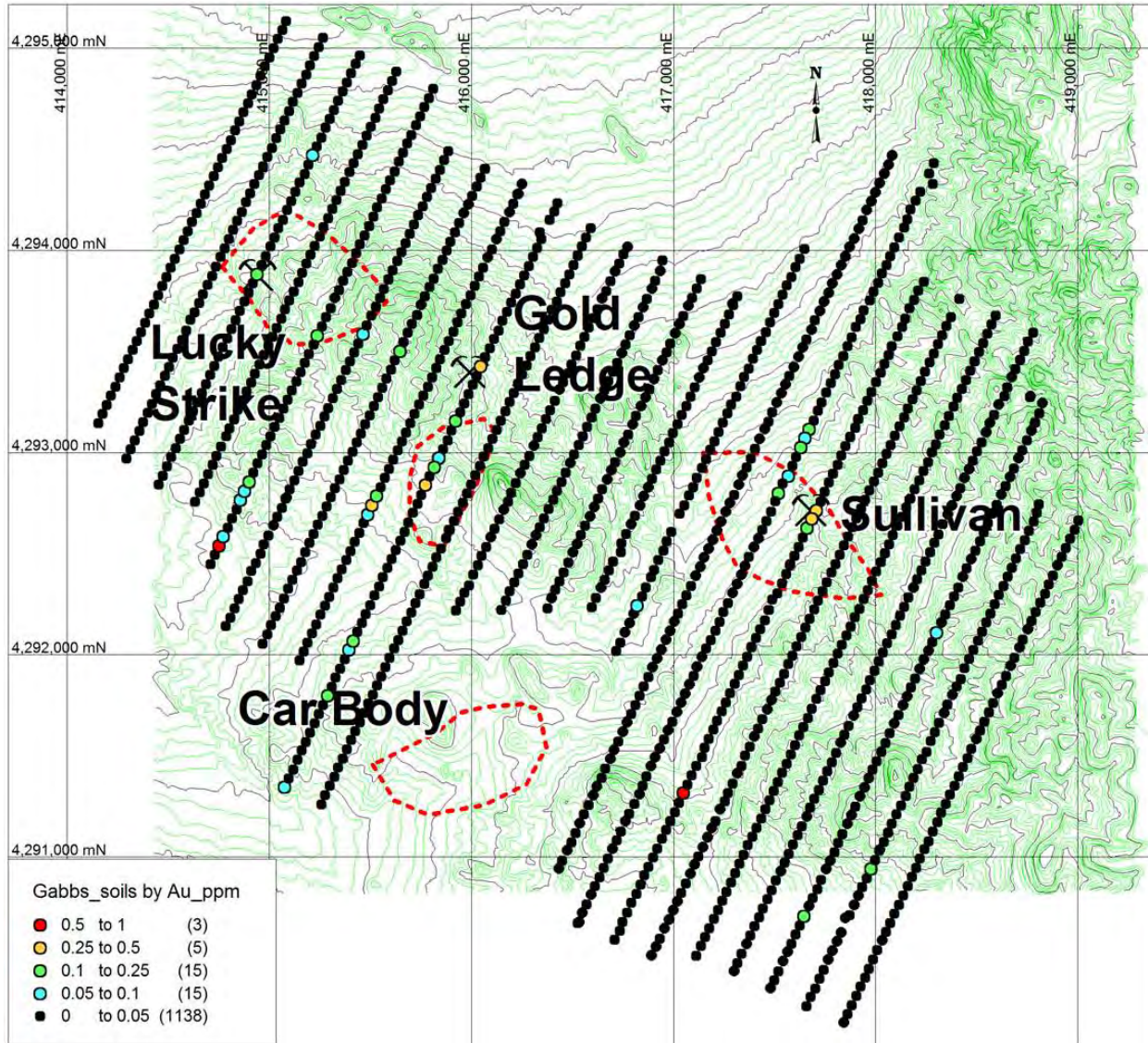

Source: Fierst (2009)

Figure 6-6 Soil Sample Locations and Gold Values in the Gabbs Claim Block

In Figure 6-6, anomalous to potentially economic gold values are mostly concentrated around zones of known mineralization. Anomalous gold values outside these zones are likely related to isolated mesothermal quartz veins with associated gold and copper mineralization.

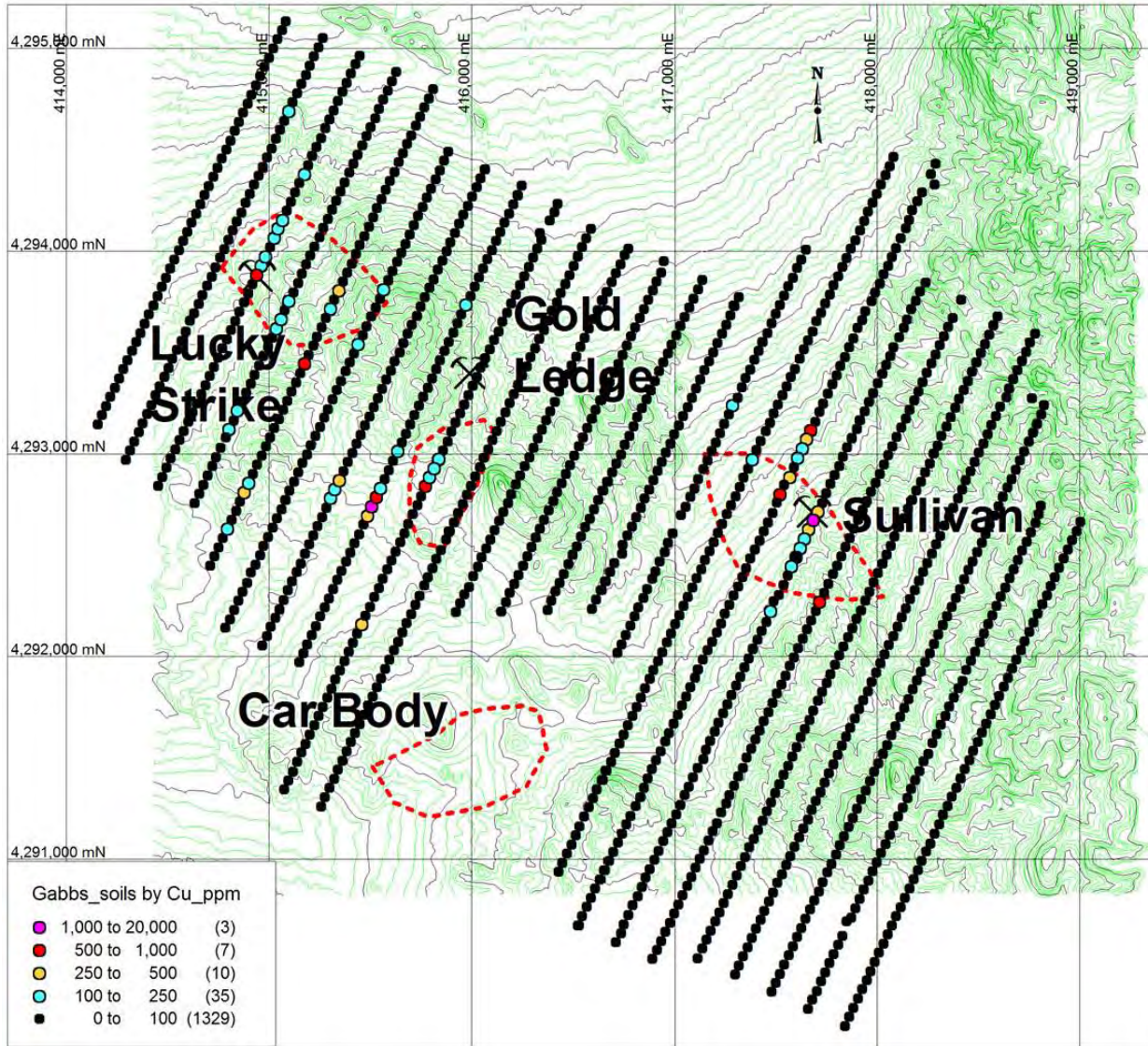

Source: Fierst (2009)

Figure 6-7 Soil Sample Locations and Copper Values in the Gabbs Claim Block

In Figure 6-7, anomalous to potentially economic copper values are mostly concentrated around zones of known mineralization. Anomalous copper values outside these zones are likely related to isolated mesothermal quartz veins with associated gold and copper mineralization.

6.2.1.2 Geophysical Exploration

Combined magnetic and induced polarization (“IP”) and resistivity geophysics can be effective in identifying and characterising porphyry gold-copper deposits. These deposits commonly have a gold-copper mineralized, potassic altered, magnetite-rich core centred on a porphyry stock and characterized by a magnetic high anomaly. This is commonly surrounded by an annular zone of

barren or weakly gold-copper mineralized, pyrite-rich, phyllic alteration characterized by magnetic low/conductivity high anomalies.

Ground magnetic surveying was undertaken at the Gabbs Property in 2007 and induced polarization (IP) and resistivity surveying done in 2008. The geophysical surveys identified anomalous areas, but no clear bulls-eye anomalies typical of large, mineralized porphyries were detected. The data were recently reviewed by a consulting geophysicist, reprocessed and approved for interpretation. A deep source for the mineralized quartz monzonite porphyries is postulated to exist west of the Sullivan Deposit and east of the Lucky Strike and Gold Ledge Deposits, which may be indicated by the existence of a broad chargeability anomaly on the 450m depth slice (Figure 6-8).

A broad east-west magnetic low anomaly between Lucky Strike and Gold Ledge separates individual magnetic highs (Figure 6-9) the latter thought to reflect Jurassic gabbro/pyroxenite and to some extent Triassic meta-andesite (basement). The magnetic lows may indicate a thrust fault that controlled intrusion or tectonic emplacement of non-magnetic quartz monzonite. Alternatively, the magnetic lows may identify magnetite destructive alteration in basement rocks. Support for the latter interpretation is the east-west elongate magnetic low that corresponds with the pyrite-mineralized, phyllic-altered, Tertiary volcanics at Car Body. Two major north-northwest-striking lineaments flank the Gold Ledge Zone in the magnetic image (Figure 6-6) and have been interpreted as the margins of a “volcanic” rift (Fierst, 2009) perhaps related to “basin and range” tectonics.

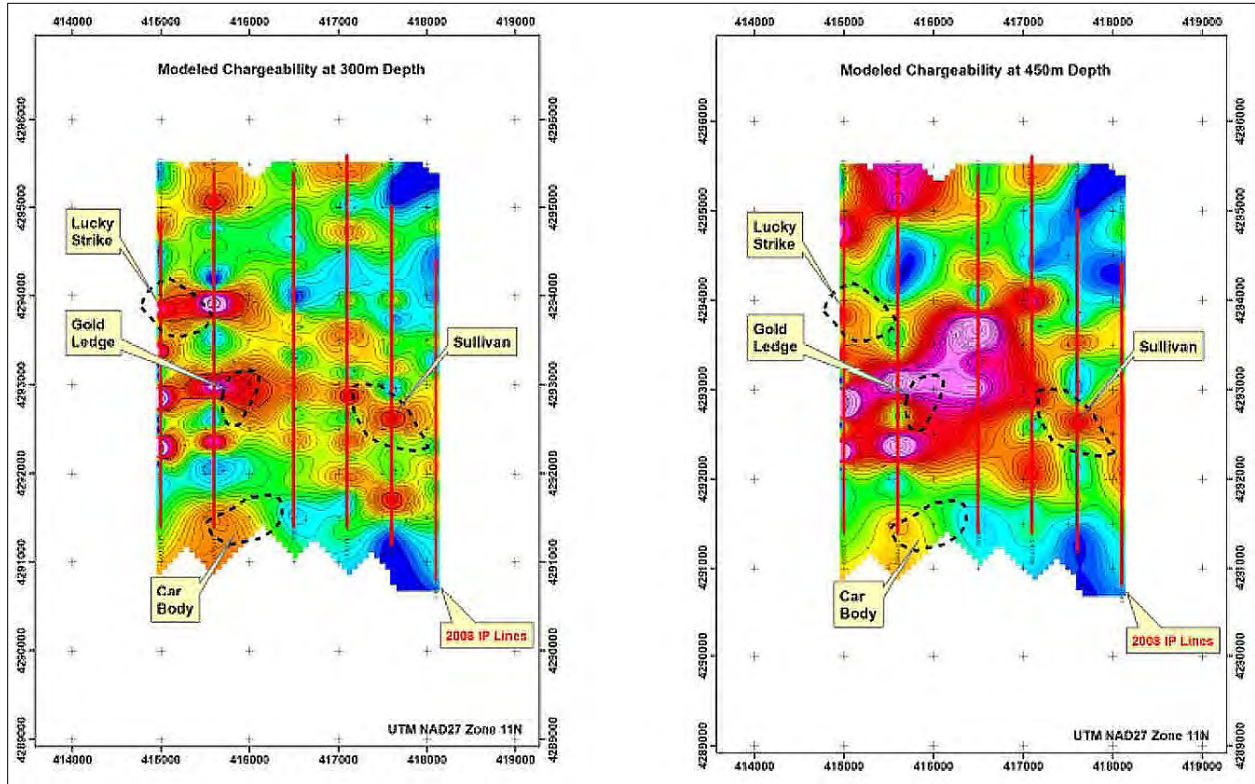
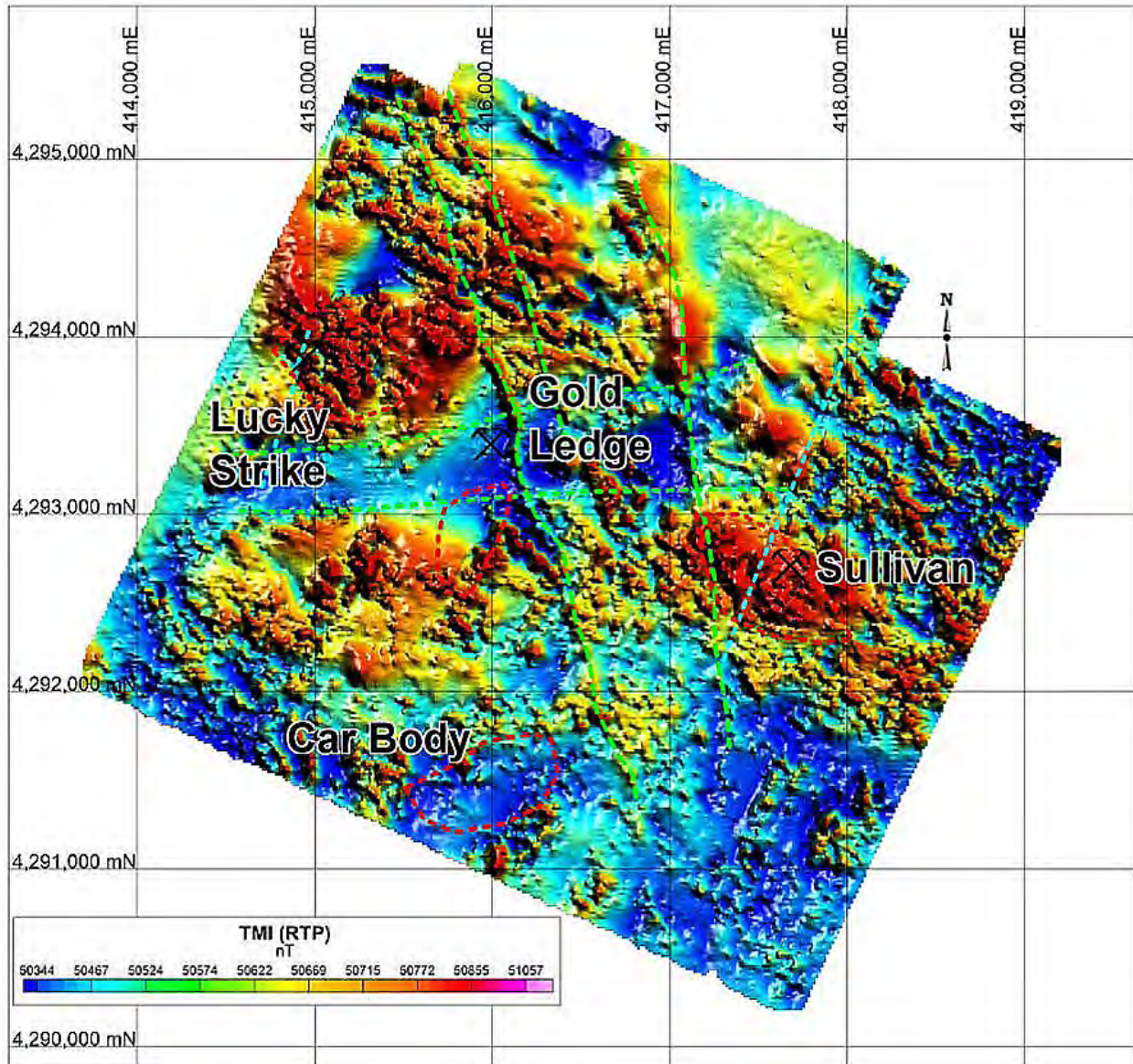

Figure 6-8 Plan Map of the Model Chargeability at 300m and 450m

Figure 6-8 is based on the 2008 Gradient Geophysics IP survey; the 2-D inversion modelling is considered to have been performed by Newcrest (Ellis, 2011).



Note: RTP = reduced to pole magnetic image.

Figure 6-9 Magnetic Image (rtp) for Gabbs Property, Showing Interpreted Structures

In Figure 6-9, note the east-west striking magnetic low from south of Lucky Strike to Gold Ledge and north-south striking structures flanking Gold Ledge. These were interpreted to be a “volcanic-filled rift” (Fierst, 2009).

6.2.1.3 Drilling Programs 2004 to 2008

Newcrest completed several drilling programs between 2004 and 2008 comprising 87 RC and diamond core drill holes for a total of 24,765m (81,250 ft). The drill program locations are shown in Figure 6-10 and listed in Table 6-2. The initial drill target was the Car Body Deposit,

based on historical drilling by Placer U.S. Inc. and reconnaissance mapping and sampling by Newcrest. Car Body is a nuggety epithermal gold vein target hosted in Tertiary volcanic rocks. The Car Body Deposit was drill-tested in 2004 and again in early 2006-2007. Afterwards, emphasis gradually shifted to the Sullivan and Gold Ledge Deposits.

2004. Drill testing of the Car Body Deposit in May 2004 consisted of 10 RC drill holes (G-1 to G-10 in Figure 6-10). Average depth of the drill holes was 183m and none were surveyed down-hole. Among the mineralized intercepts was 22.6 g/t Au over 3.05m in drill hole G-2. Re-assay of several of the mineralized intercepts yielded widely varying gold values.

2005-2007. From December 2005 to June 2006, 29 RC drill holes (G-11 to G-39) were completed in the Car Body (21 drill holes) and Gold Ledge areas (eight drill holes) (Figure 6-10). None of these drill holes were surveyed downhole for deviation. The Car Body drill holes confirmed the existence of coarse, “nuggety” gold (Thompson, 2006). Although many drill holes encountered gold mineralization, it was difficult to locate continuous mineralization and emphasis was shifted from the Car Body area to Sullivan. Completing the eight drill holes totalling 1,472m in the Gold Ledge area encountered copper-gold mineralization associated with felsic intrusive rocks. Low-level gold and copper were encountered in seven of the eight drill holes, and warranted future drilling.

In mid-2006, data from the previous drilling at Sullivan were compiled and it became apparent that a porphyry gold-copper target was present, and that potential existed both at depth and laterally to expand the existing oxide Mineral Resource. From September 2006 to September 2007, 13 diamond drill holes (SD-1 to SD-13) totalling 4,842 m were completed at the Sullivan Deposit, and two diamond “twins” of RC holes were drilled at the Car Body Deposit (Figure 6-10). All drill holes in this program were surveyed by downhole gyroscope. The first 2 Sullivan drill holes confirmed previously outlined oxide mineralization in the Sullivan “sill.” SD-3 discovered sulphide mineralization offset from the oxide mineralization to the southeast across an inferred fault. The remaining drill holes of the program sought to extend mineralization away from the oxide zone. Although the two diamond “twin” drill holes in the Car Body area encountered mineralization at many of the same locations as the initial RC drill holes, they failed to accurately reproduce the grades.

2008. From April to August 2008, seven RC drill holes, including one RC pre-collar (SR-1 to SR-5 and SRD-14 to SRD-15) and seven diamond drill holes SD-16 to SD-21 and SRD-15) were completed at the Sullivan Deposit, and 16 RC drill holes (G-40 to G-55) and four diamond drill holes (GD-3 to GD-6) were completed in the Lucky Strike-Gold Ledge area (Figure 6-10). All drill holes in this program were surveyed by down hole gyroscope. At Gold Ledge, a mineralized monzonite “sill” similar to the one at Sullivan, was encountered in and delineated by RC drilling (G-40 to G-48). Efforts to significantly increase mineralization at Sullivan were

unsuccessful. However, unexpected shallow mineralization, beginning at 21m in monzonite, was discovered to the southwest of Sullivan in RC drill hole SRD-14, later completed with drill core by hole SD-21.

A list of some of the significant drill core intercepts is provided in Table 6-3.

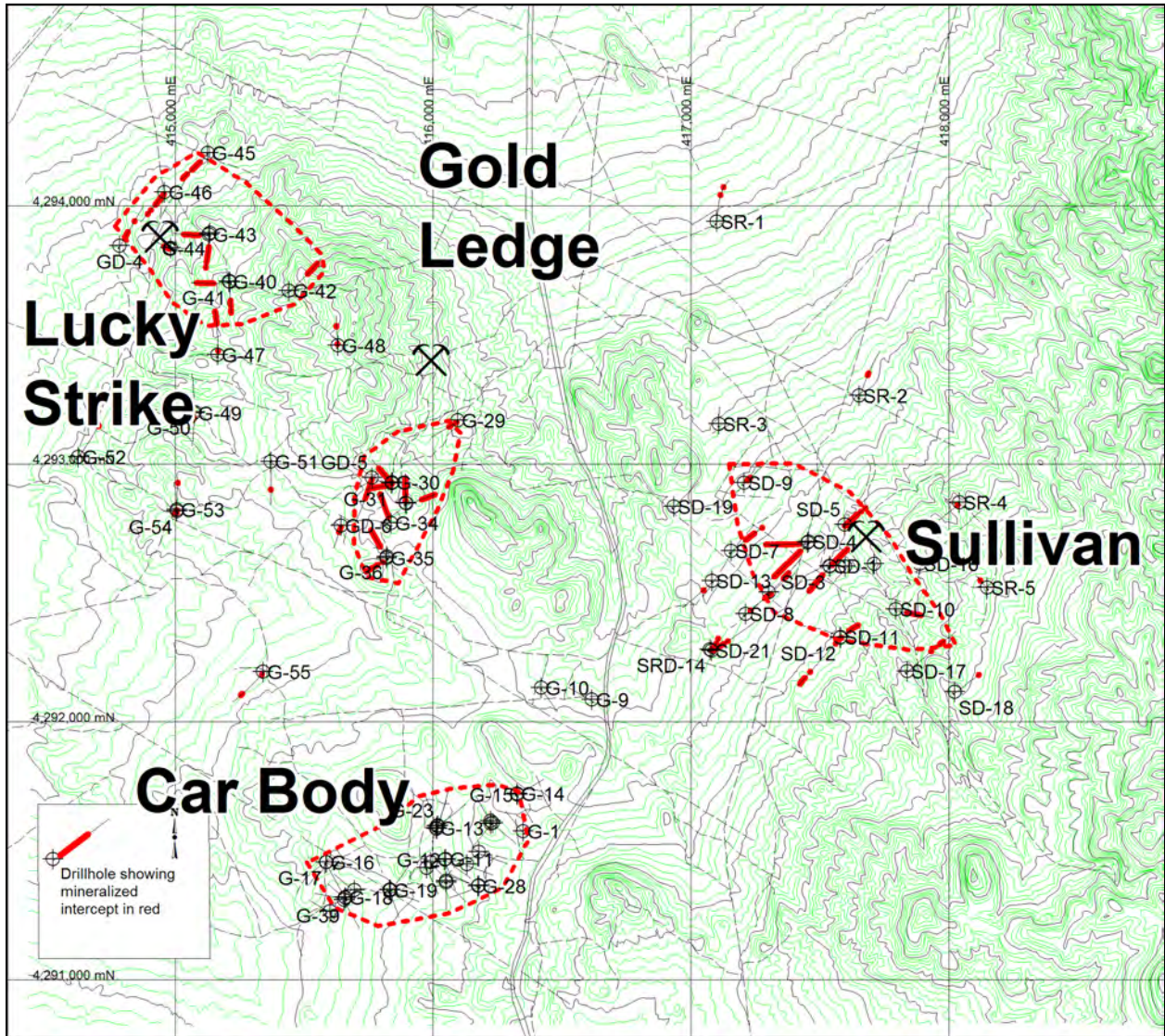

Source: Fierst (2009)

Figure 6-10 Newcrest Drill Hole Locations 2004 to 2008

Table 6-2
Newcrest 2004 to 2008 Drill Hole Location, Type, Recovery

Year	Drill Type	Location	Holes	Avg. Core Recovery (%)	RC Drilling
2004	RC	Car Body	G 1-10	78	centre-return hammer
2006	RC	Car Body	G 11-28, 37-39	75	centre-return hammer
2006	RC	Gold Ledge	G 29-36	84	centre-return hammer
2006-2007	Core	Sullivan	SD 1-13	92	
2006-2007	Core	Car Body	GD 1-2	97	
2008	RC	Lucky Strike, Gold Ledge	G 40-55	52	RC crossover/interchange
2008	RC	Sullivan	SR 1-5, SRD 14-15	42	RC crossover/interchange
2008	Core	Sullivan	SRD 15, SD 16-21	78	
2008	Core	Lucky Strike, Gold Ledge	GD 3-6	87	

Table 6-3
Gabbs Property Significant Drill Intercepts

Zone	Hole	Intercept
Sullivan	SD-1	88.0m @ 1.43 g/t Au and 0.28% Cu from 56 m
Sullivan	SD-2	89.7m @ 0.76 g/t Au, 0.29% Cu
Sullivan	SD-4	100m @ 0.40 g/t Au and 0.29% Cu from 93 m
South Gold Ledge	GD-5	154m @ 0.16 g/t Au and 0.14% Cu from 12 m
Lucky Strike	G-43	54.8m @ 0.52 g/t Au, 0.26% Cu
Lucky Strike	G-44	53m @ 0.80 g/t Au and 0.34% Cu from 108 m
Car Body	G-4	39.7m @ 0.80 g/t Au
Car Body	G-17	38.0m @ 0.49 g/t Au from 96 m
Car Body	G-28	41.1m @ 1.12 g/t Au

6.2.2 St. Vincent 2011

St. Vincent completed 10 RC drill holes totalling 2,400 m (7,875 ft) in March to April 2011. Drill hole locations are shown in Figure 6-11 and Table 6-4. The goal of this drilling was to expand the area of known mineralization at the Lucky Strike area (6 holes) and test IP anomalies (four holes) identified by Newcrest.

Overall, seven of ten holes encountered gold mineralization. RC drill holes SVM-4 and SVM-5 extended the mineralization 610 m (2,000 ft) at Lucky Strike. RC drill hole SVM-6 encountered

mineralization in a new area identified by an IP anomaly south of the Sullivan mineralized zone. A summary of significant intersections from the 2011 drill program is presented in Table 6-4. All of the samples were analysed at the ALS Chemex laboratories in Reno and Vancouver. Quality assurance/quality control (“QA/QC”) protocol was followed using geochemical certified reference materials, blanks, and pulp replicate samples (duplicates), and randomization of the submittal prior to sample preparation and analysis by a third-party laboratory.

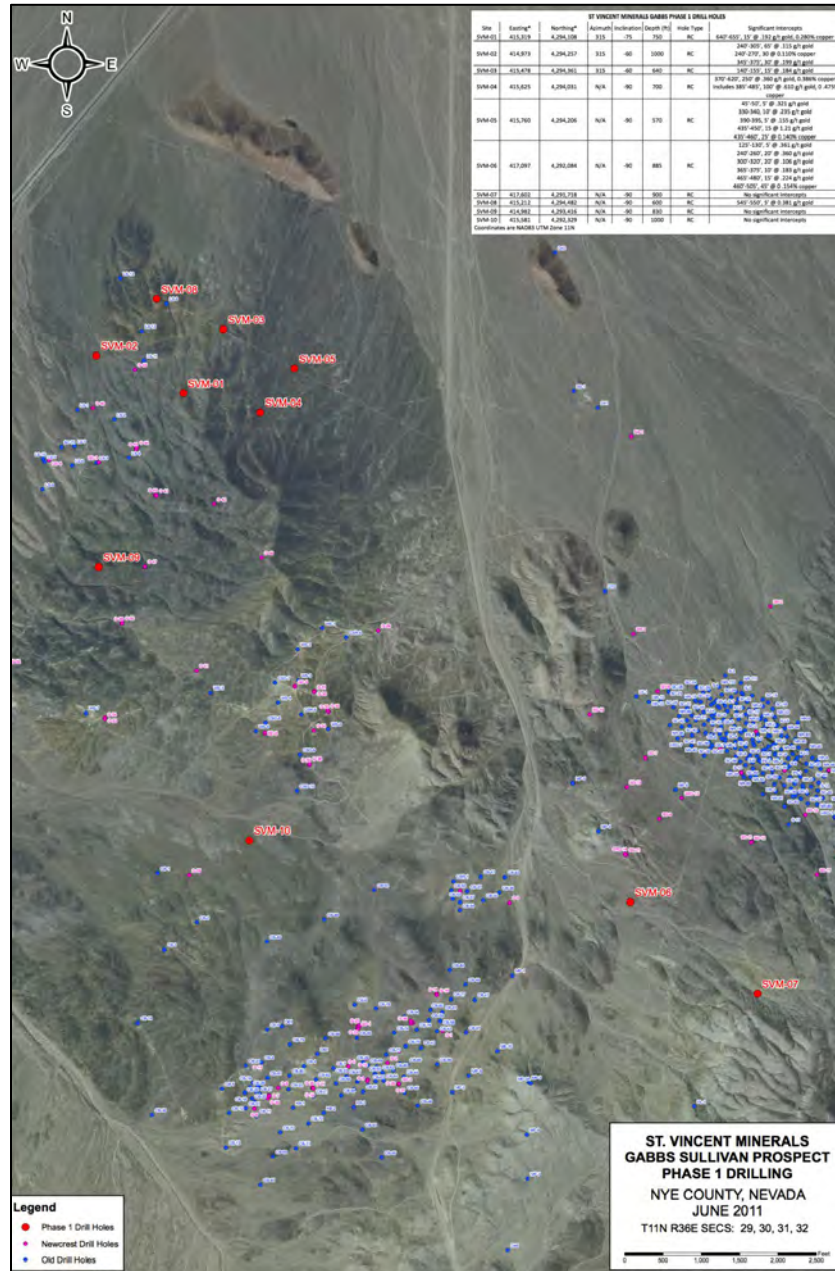

Source: St. Vincent Minerals Inc. (2011)
Note: St. Vincent drill hole collar locations shown in red.

Figure 6-11 2011 St. Vincent Drill Hole Locations

Table 6-4
Highlights of Intercepts from 2011 Drill Program ^(1,2)

Borehole ID	Easting UTM*	Northing UTM*	Azimuth (°)	Dip (°)	From (ft)	To (ft)	Interval (ft)	Au (g/t)	Cu (%)	AuEq (g/t)
SVM-01LS	415,319	4,294,108	315	-75	640	660	20	0.154	0.23	0.703
SVM-02LS	414,973	4,294,257	315	-60	230	310	80	0.104	0.08	0.297
Including					245	250	5	0.268	0.14	0.610
					345	350	5	0.214	0.01	0.236
					360	375	15	0.303	0.03	0.362
					370	375	5	0.724	0.02	0.760
SVM-03LS	415,478	4,294,361	315	-60	140	155	15	0.184	0.04	0.288
					205	215	10	0.022	0.06	0.167
SVM-04LS	415,625	4,294,031	0	-90	105	110	5	0.390	0.38	1.283
					160	170	10	0.260	0.18	0.685
Including					165	170	5	0.504	0.32	1.250
					240	245	5	0.045	0.07	0.217
					370	625	255	0.354	0.40	1.290
Including					390	525	135	0.516	0.49	1.679
And					400	435	35	0.987	0.75	2.766
					630	640	10	0.041	0.06	0.174
					645	655	10	0.042	0.04	0.148
					660	700	40	0.046	0.06	0.192
SVM-05LS	415,760	4,294,206	0	-90	40	50	10	0.182	0.03	0.247
					190	200	10	0.025	0.04	0.126
					275	280	5	0.095	0.07	0.270
					330	345	15	0.170	0.01	0.198
					380	390	10	0.072	0.05	0.182
					390	395	5	0.155	0.02	0.200
					430	470	40	0.083	0.11	0.341
Including					445	450	5	0.148	0.19	0.598
SVM-06SUL	417,097	4,292,084	0	-90	125	130	5	0.361	0.00	0.363
					240	260	20	0.360	0.01	0.385
					265	280	15	0.088	0.03	0.159

Borehole ID	Easting UTM*	Northing UTM*	Azimuth (°)	Dip (°)	From (ft)	To (ft)	Interval (ft)	Au (g/t)	Cu (%)	AuEq (g/t)
					300	320	20	0.106	0.01	0.137
					365	410	45	0.058	0.06	0.188
Including					370	375	5	0.244	0.04	0.339
					430	440	10	0.039	0.07	0.202
					460	505	45	0.115	0.15	0.479
Including					465	470	5	0.395	0.25	0.992
					540	545	5	<0.005	0.09	0.217
					795	800	5	0.171	0.02	0.223
					820	830	10	0.055	0.03	0.133
SVM-07SUL	417,602	4,291,718	0	-90	No Significant Intersections					
SVM-08SUL	415,212	4,294,482	0	-90	545	555	10	0.223	0.03	0.286
SVM-09LS	414,982	4,293,416	0	-90	No Significant Intersections					
SVM-10LS	415,581	4,292,329	0	-90	5	15	10	0.122	0.00	0.126

Notes:

* Easting and Northing coordinates are in UTM WGS84 Zone 11N.

1) The conversion factor for AuEq is: $AuEq = Au + (Cu \times 1.67/10,000)$.

2) The intervals reported are sample lengths.

6.3 Historical Metallurgy

Historical mineral processing and metallurgical testwork is described in Section 13 of this Technical Report in order to provide better context for the more recently completed testwork by P2 Gold.

6.4 Historical Resource Estimates

This section is summarized from P&E (2011). Primary sources of the information are referenced where possible.

The historical resource estimates summarized below and in Table 6-5 below are historical in nature and, as such, are based on prior data and reports prepared by previous operators and are not in compliance with NI 43-101. A Qualified Person has not done the work necessary to verify the historical estimates as current estimates under NI 43-101 and the estimates should not be relied upon. There can be no assurance that any of the resources, in whole or in part, will ever become economically viable. P2 Gold is not treating the historical estimates as current Mineral Resources or Mineral Reserves. The Company has completed the necessary work to establish a current Mineral Resource on the Gabbs Property as presented in Section 14 of this Technical Report.

**Table 6-5
Summary of Historical Resource Estimates***

Company	Year	Zone	Tonnage (tons)	Au (oz/t)	Au (g/t)	Cu (%)	Remarks
Gwalia	1990	Sullivan	12,680,000	0.0267	0.834	0.34	
Arimetco	1996	Sullivan	17,162,000	0.0255	0.798	0.34	oxide material with an additional 8,549,000 Tons grading 0.31% Cu
Newcrest	2009	Sullivan	33,102,000	0.0176	0.550	0.25	utilized a 0.3 /t Au cut-off. An oxide resource of 12.7 million tonnes of 0.91 g/t Au and 0.34% Cu was previously estimated

* It should be noted that the resource estimates summarized above in Table 6-5 are historical in nature and as such are based on prior data and reports prepared by previous operators. The work necessary to verify the classification of the historical resource estimates has not been completed and the resource estimates therefore, cannot be treated as NI 43-101 defined resources verified by a Qualified Person. The historical resource estimates should not be relied upon and there can be no assurance that any of the resources, in whole or in part, will ever become economically viable. The Company is not treating the historical resource estimates as current Mineral Resources or Mineral Reserves.

In 1990, Gwalia Gold Mining produced a Pre-Feasibility Study based on 14 drill holes, which stated that the Sullivan Deposit contained 12,680,000 tonnes at 0.0267 ounces per tonne (0.834 g/t) Au and 0.34% Cu (Fierst, 2009).

In 1995, Arimetco acquired the Property and produced a Pre-Feasibility Study and Plan of Operations to mine the Sullivan Deposit. Arimetco stated that Sullivan is a copper/gold deposit containing approximately 17,162,000 tons of oxidized mineralized material grading 0.34% Cu and 0.0255 ounces per ton Au. The Deposit also hosts an additional 8,549,000 tons of oxidized mineralized material grading 0.31% Cu (Arimetco, 1995).

Newcrest began work on the Gabbs Property in 2002 and, after extensive drilling through 2008, estimated the resource at Sullivan to be 33,102,000 tonnes grading 0.55 g/t Au and 0.25% Cu at a 0.3 g/t Au cut-off. Contained metal contents were 585,000 ounces of gold and 82,755 tonnes of copper (Maxlow, 2009). An oxide resource of 12.7 million tonnes of 0.91 g/t Au and 0.34% Cu was previously estimated (Job and Singh, 2010).

A Qualified Person has not done sufficient work to classify the above historical estimates as current Mineral Resources. The Issuer is not treating the historical estimated as current Mineral Resources and they should not be relied upon.

6.5 Recent Historical Mineral Resource Estimate

In 2011, St. Vincent contracted P&E to prepare an Inferred Mineral Resource Estimate based on 494 drill hole records, consisting of the ten RC drill holes completed by St. Vincent, 87 drill holes completed by Newcrest, and 397 “historical” drill holes (P&E, 2011a). The historical drill holes did not meet NI 43-101 and CIM guidelines for the public reporting of a Mineral Resource. Historical drill holes were therefore used only to define the extent of the mineralized deposits, and historical assay grades were not incorporated into the mineral resource estimate. The P&E Mineral Resource Estimate for the Gabbs Property was reported at a cut-off grade of 0.40 g/t Au for the oxide deposits and 0.30 g/t Au for the non-oxide deposits (Table 6-6).

Table 6-6
Summary of Pit Constrained Inferred Mineral Resources⁽¹⁻¹¹⁾ (Effective December 1, 2011)

Deposit	Au Cut-off (g/t)	Tonnage (kt)	Au (g/t)	Au (koz)	Cu (ppm)	AuEq (g/t)	AuEq (koz)
Sullivan Oxide	0.4	9,935	0.80	254.5	2,463	0.80	254.5
Sullivan Non-Oxide	0.3	10,782	0.47	161.6	2,185	0.83	288.1
Car Body Oxide	0.4	836.5	1.44	38.6	-----	1.44	38.6
Car Body Non-Oxide	0.3	44.4	0.78	1.1	-----	0.78	1.1
Gold Ledge Oxide	0.4	108.2	0.47	1.6	2,691	0.47	1.6
Gold Ledge Non-Oxide	0.3	760.6	0.61	15.0	1,800	0.91	22.3
Lucky Strike Oxide	0.4	243.5	0.52	4.1	2,479	0.52	4.11
Lucky Strike Non-Oxide	0.3	34,489	0.50	552.6	2,427	0.90	1,002
Total		57,199	0.56	1,029	2,342	0.88	1,612

Notes 1 – 11:

- 1) Mineral Resources, which are not Mineral Reserves, do not have demonstrated economic viability. The estimate of Mineral Resources may be materially affected by environmental, permitting, legal, title, taxation, socio-political, marketing, or other relevant issues.
 - 2) The quantity and grade of reported Inferred Mineral Resources are uncertain in nature and there has been insufficient exploration to define these Inferred Mineral Resources as an Indicated or Measured Mineral Resource, and it is uncertain if further exploration will result in upgrading them to an Indicated or Measured Mineral Resources classification.
 - 3) Mineral Resources were estimated using the Canadian Institute of Mining, Metallurgy and Petroleum (“CIM”), CIM Standards on Mineral Resources and Reserves, Definitions and Guidelines prepared by the CIM Standing Committee on Reserve Definitions and adopted by CIM Council.
 - 4) Mineral Resources are reported within a conceptual pit shell.
 - 5) Inverse distance weighting of capped composite grades within grade envelopes was used for estimation.
 - 6) Composite grade capping of 5.00 g/t Au and 9,000 ppm Cu was implemented prior to estimation.
 - 7) A bulk density of 2.70 t/m³ was used for tonnage calculations.
 - 8) A two-year, November 30, 2011, trailing average copper price of US\$3.70/lb and a gold price of US\$1,350.00/oz were used along with an oxide process cost of US\$6.50/t, a sulphide process cost of US\$9.50/t and G&A costs of US\$2.25/t.
 - 9) An oxide Au recovery of 50% and a sulphide Au recovery of 90% were used.
 - 10) Mineral Resources were estimated within an optimized pit shell utilizing pit slopes of 45° and mining costs of US\$1.50/t of rock.
 - 11) The conversion factor for AuEq is: AuEq=Au + Cu x 1.67/10,000.
- The P&E (2011a) Mineral Resource Estimate was superseded by the previous Mineral Resource, which is summarized below.

6.6 Previous Mineral Resource Estimate

In 2021, P2 Gold contracted P&E to prepare an Updated Mineral Resource Estimate for the Gabbs Property. The Inferred Mineral Resource Estimate was based on the same 494 drill hole records, consisting of 397 “historical” drill holes, 87 drill holes completed by Newcrest and ten RC drill holes completed by St. Vincent, but incorporating updated economic assumptions. The Pit-constrained Mineral Resource Estimate for the Gabbs Property was reported using a cut-off of 0.24 g/t Au for oxide material and 0.30 g/t AuEq for sulphide material (Table 6-7). The Gabbs Property contains 26.2 Mt of oxide mineralization at an average grade of 0.72 g/t AuEq and 46.9 Mt of sulphide mineralization at an average grade of 0.82 g/t AuEq, for a total of 1.84 Moz of AuEq.

Table 6-7
Summary of Inferred Mineral Resources⁽¹⁻⁹⁾ (Effective January 13, 2021)

Deposit	Zone	Tonnes (kt)	Au (g/t)	Au (koz)	Cu (ppm)	AuEq (g/t)	AuEq (koz)
Sullivan	Oxide	21,900	0.65	460	2,810	0.65	460
Car Body	Oxide	2,700	1.4	120	10	1.4	120
Gold Ledge	Oxide	100	0.76	0	1,500	0.76	0
Lucky Strike	Oxide	1,500	0.52	20	2,070	0.52	20
Total	Oxide	26,200	0.72	610	2,480	0.72	610
Sullivan	Sulphide	15,600	0.48	240	2830	0.88	440
Car Body	Sulphide	100	1.28	10	10	1.28	10
Gold Ledge	Sulphide	0	0	0	0	0	0
Lucky Strike	Sulphide	31,100	0.4	400	2640	0.79	790
Total	Sulphide	46,900	0.43	650	2700	0.82	1,240
Sullivan	Oxide & Sulphide	37,600	0.58	700	2,820	0.75	900
Car Body	Oxide & Sulphide	2,800	1.39	130	10	1.39	130
Gold Ledge	Oxide & Sulphide	100	0.76	0	1,500	0.76	0
Lucky Strike	Oxide & Sulphide	32,600	0.41	430	2,620	0.77	810
Total	Oxide & Sulphide	73,100	0.53	1,260	2,620	0.79	1,840
Total	Oxide	26,200	0.72	610	2,480	0.72	610
Total	Sulphide	46,900	0.43	650	2,700	0.82	1,240
Total	Oxide & Sulphide	73,100	0.54	1,260	2,620	0.79	1,840

Notes: 1-9

- 1) Mineral Resources were estimated using the Canadian Institute of Mining, Metallurgy and Petroleum (CIM), CIM Standards on Mineral Resources and Reserves, Definitions (2014) and Best Practices (2019) prepared by the CIM Standing Committee on Reserve Definitions and adopted by CIM Council.
 - 2) The Inferred Mineral Resource in this estimate has a lower level of confidence that that applied to an Indicated Mineral Resource and must not be converted to a Mineral Reserve. It is reasonably expected that the majority of the Inferred Mineral Resource could be upgraded to an Indicated Mineral Resource with continued exploration.
 - 3) Mineral Resources are reported within a constraining conceptual pit shell.
 - 4) Inverse distance weighting of capped composite grades within grade envelopes was used for grade estimation.
 - 5) Composite grade capping was implemented prior to grade estimation.
 - 6) A bulk density of 2.50 t/m³ was used for oxide material and 2.70 t/m³ for sulphide material.
 - 7) A copper price of US\$3/lb and a gold price of US\$1,600/oz were used.
 - 8) A cut-off grade of 0.24 g/t Au for oxide material, and 0.30 g/t AuEq for sulphide material was used.
 - 9) Tables may not sum due to rounding.
- This P&E (2021) Mineral Resource Estimate is superseded by the current Mineral Resource Estimate described in Section 14 of this Technical Report.

6.7 Historical Production

The author of this Technical Report section is not aware of any mine production from the Gabbs Property.

7.0 GEOLOGICAL SETTING AND MINERALIZATION

7.1 Geological Setting

The geological setting of the Gabbs Property is summarized below from Newcrest reports by Candee (2004), Wood (2005), Fierst (2009) and Maxlow (2009), and from papers in the scientific literature (John *et al.*, 1989).

7.1.1 Regional and Local Geology

The Gabbs Property is located on or near the boundary between the Walker Lane Structural Trend to the west and the Great Basin region of the Basin and Range Province to the east, in west-central Nevada (Figure 7-1). The Gabbs Property region consists of alternating linear north to north-northeast trending narrow ranges and broad alluvial basins formed during later Cenozoic crustal extension (John *et al.*, 1989) (Figure 7-2).

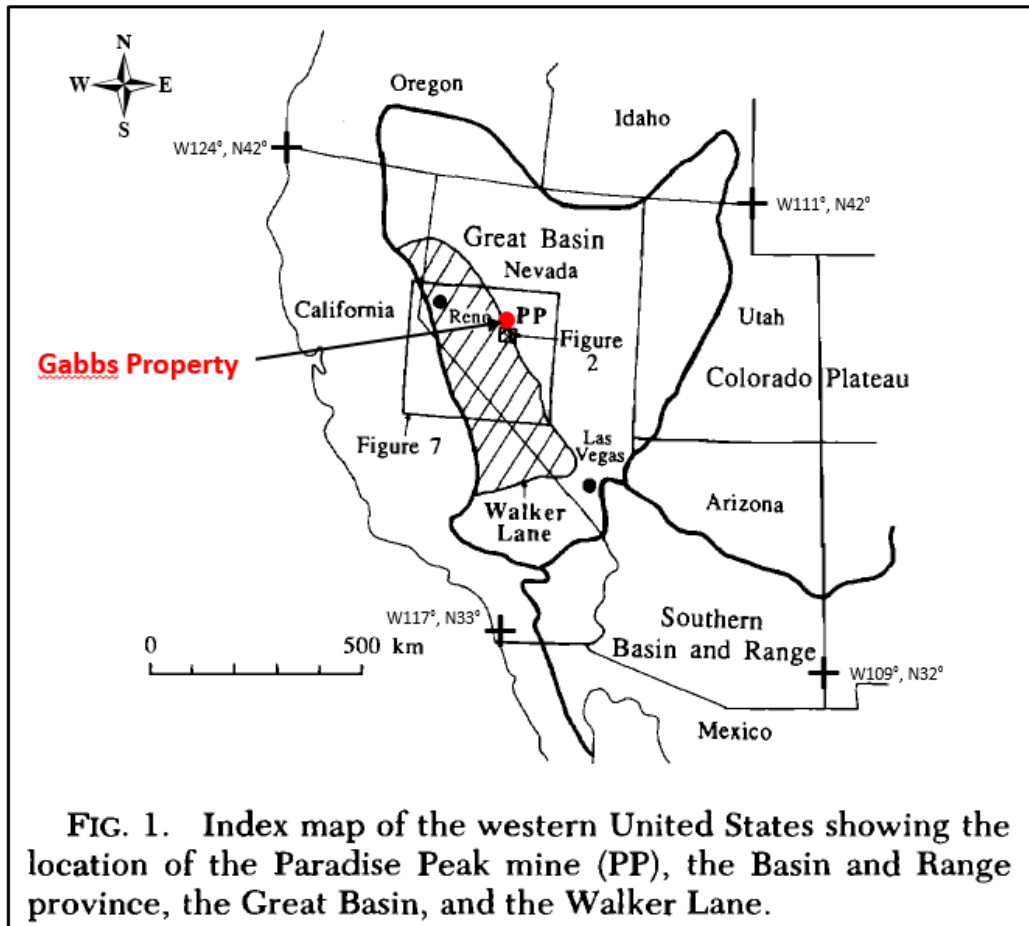
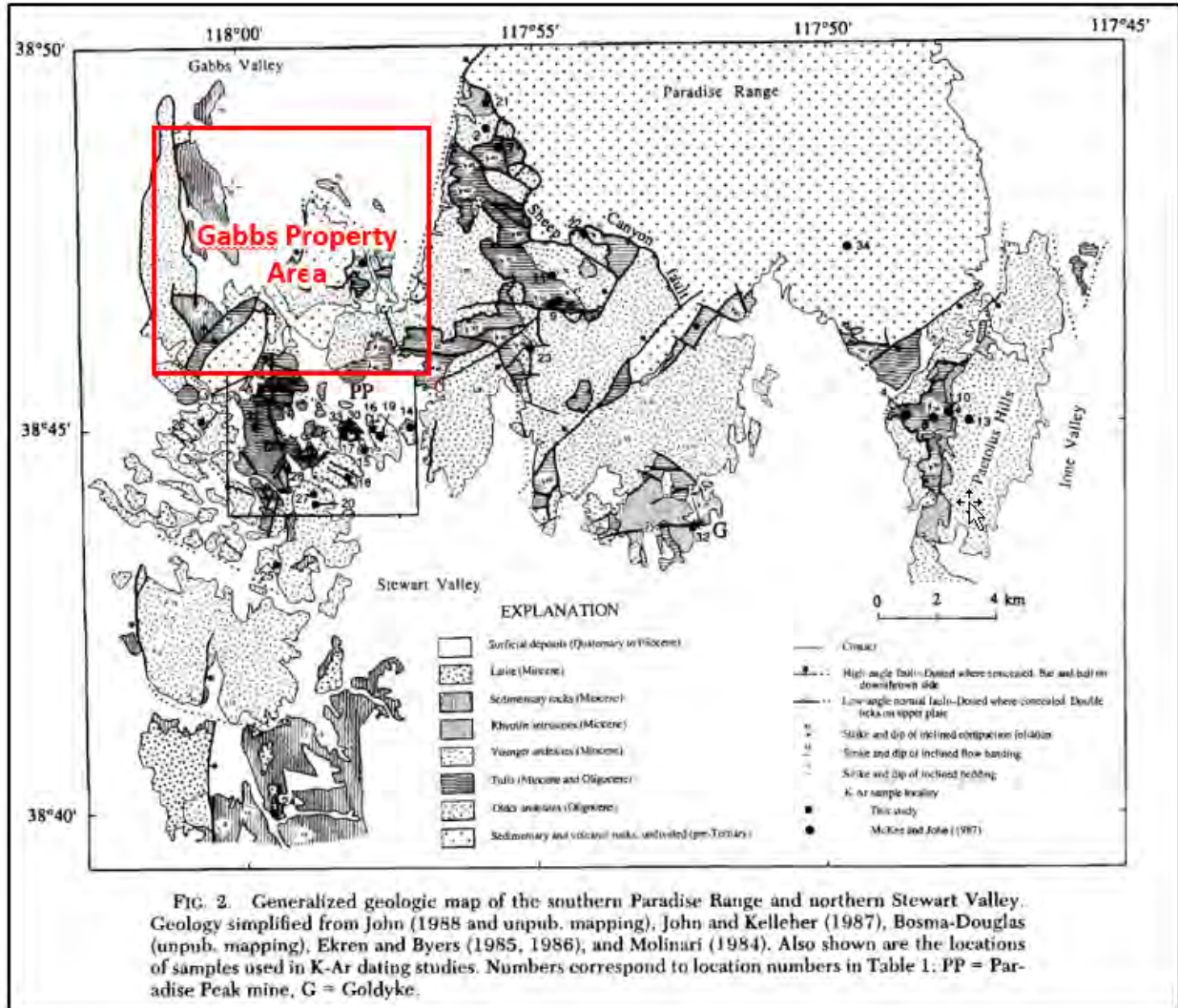

FIG. 1. Index map of the western United States showing the location of the Paradise Peak mine (PP), the Basin and Range province, the Great Basin, and the Walker Lane.

Source: John *et al.* (1989); modified by P&E (February 2022)

Figure 7-1 Regional Geologic Setting of the Gabbs Property



Source: John et al. (1989)

Figure 7-2 Local Geology of the Gabbs Property Area

The oldest rocks exposed in the Fairplay Mining District are metasedimentary rocks of the Excelsior Formation. These rocks range in age from Triassic to late Jurassic and consist of sedimentary and volcanic rocks deposited along an island arc. The island arc formed within the centre of an orthogeosyncline that developed along the continental margin and traversed central Nevada, separating deep water marine rocks to the west from shallow water shelf carbonates to the east (Wood, 2005). Local Triassic and Jurassic rocks consist of subaqueous andesite flows, tuffaceous rocks, and associated diorite and gabbro intrusions, locally interbedded with conglomerate and deltaic deposits of pelitic and clastic rocks with minor limestone. In the Jurassic, the first large intrusions were emplaced as the ancestral Sierra-Nevada Batholith and the Walker Lane Structural Zone formed. During this time, smaller plutons were emplaced throughout central Nevada. Several large Jurassic thrust faults developed, along which terrestrial rocks of the volcanic highland were emplaced over the carbonate shelf rocks to the

east. During the Cretaceous, much of Nevada was below a shallow sea and only a few scattered remnants of volcanic and sedimentary rocks are preserved, due to uplift and erosion. Intrusive activity reached its peak during the Nevadan Orogeny (90 Ma to 60 Ma), with formation of the Sierra-Nevada Batholith and many smaller, equigranular to porphyritic plutons.

7.1.2 Property Geology

The Gabbs Property geology consists of a Triassic age volcano-sedimentary rock sequence overlain unconformably by a Tertiary intermediate-felsic volcanic sequence. The Triassic geological section is intruded by a gabbro complex and monzonite and quartz-phyrific intrusions. The Tertiary geological section is intruded by felsic/rhyolite dykes. A geological map and stratigraphic column for the Gabbs Property area are shown in Figure 7-3 and Figure 7-4, respectively.

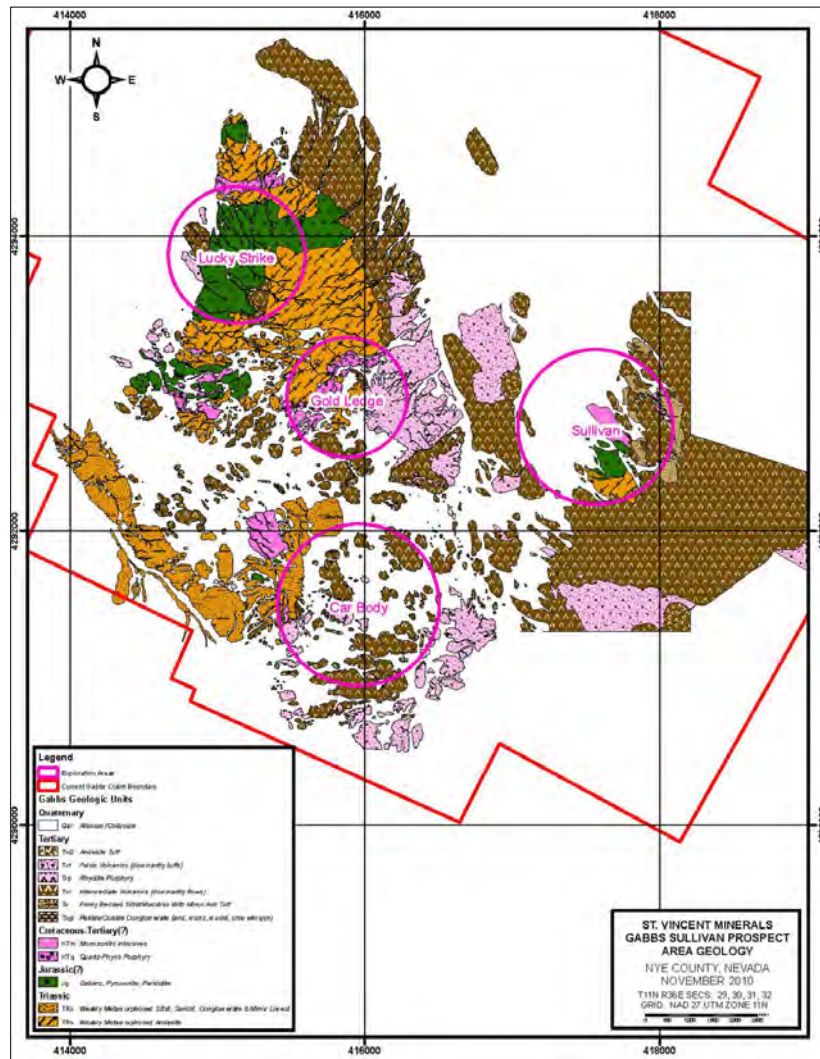

Source: Fierst (2009)

Figure 7-3 Geologic Map of the Gabbs Property

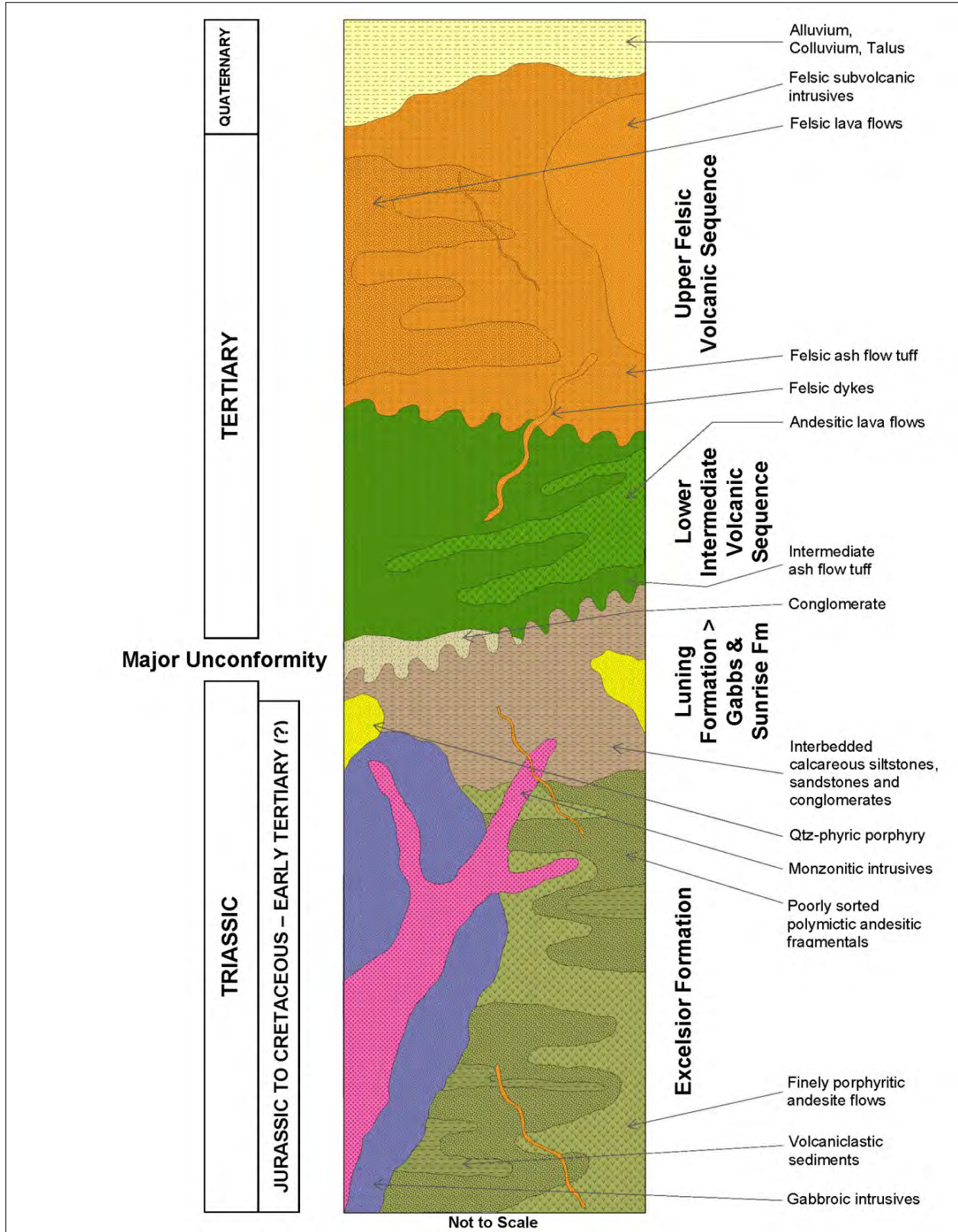

Source: Fierst (2009)

Figure 7-4 Gabbs Property Stratigraphic Column

7.1.2.1 Triassic Section

The oldest rocks exposed in the Property area are Triassic age andesite and rhyolite volcanics and shallow marine sedimentary rocks. The andesites are porphyritic flows and poorly sorted tuffs and breccias intercalated with finer-grained volcanoclastic sedimentary rocks. The rhyolites occur as a foliated brownish grey rock with dispersed quartz grains in a very fine-grained groundmass at Gold Ledge (Figure 7-5). The presence of small white pumice fragments indicate that this rock was probably a welded rhyolite tuff. This unit is considered to be correlative to the intermediate volcanic sequence unit recognized by the United States Geological Survey (“USGS”) as the Triassic Excelsior Formation, 5 km (3 miles) southwest of the Gabbs Property.



Source: Pratt and Ponce (2011)

Figure 7-5 Gabbs Triassic Welded Rhyolite Tuff

Interbedded calcareous siltstones, sandstones and conglomerate overlie the intermediate volcanic sequence. These sedimentary rocks are found throughout the Property area, but are particularly abundant in the Car Body Zone area. Scattered outcrops of sedimentary rocks also occur between the Lucky Strike and Gold Ledge Zones (see Figure 7-3). USGS mapping suggests that the sedimentary rocks largely belong to the Luning Formation. The sedimentary rocks are considered to have been deposited in an offshore, marine subtidal environment, as part of early Mesozoic volcanic arc terrain development (Kleinhampl and Ziony, 1984).

The intermediate volcanic sequence and shallow marine sedimentary rocks are intruded by a large mafic to ultramafic igneous complex composed of massive equigranular gabbro, melagabbro, pyroxenite, and peridotite. Gabbro outcrops extensively in the Lucky Strike and Sullivan areas (see Figure 7-3). Elsewhere on the Property, the gabbro is covered by talus and colluvium, which obscures contacts and structural relations. Historical drilling indicates that the

gabbro complex continues under cover and coincides with large magnetic highs in the Sullivan and Lucky Strike areas. The gabbro complex is interpreted as being a differentiated mafic to ultramafic intrusion, where the earlier formed pyroxene, olivine and magnetite minerals accumulated and formed the ultramafic rocks in the lower part and melagabbro and gabbro in the middle to upper parts of the intrusion (Mason, 2008). The contact between upper mafic and lower ultramafic rocks has not been observed in outcrop. The gabbro complex has not been age dated. However, stratigraphic relationships with older and younger units imply intrusion during the Jurassic and Cretaceous (see Figure 7-4).

Many monzonite bodies intrude the Triassic units and the gabbro complex. These intrusive bodies host the porphyry-style Au-Cu mineralization at the Sullivan, Lucky Strike and Gold Ledge Zones. The monzonites are variable in composition and texture, and range from fine-grained feldspar monzonite porphyry, fine-medium grained equigranular quartz monzonite, and medium-grained equigranular monzodiorite (Mason, 2008) (Figure 7-6).

The monzonite bodies have extensive sill-like geometry, variable thickness (~1 to <100 m) and diverse orientations. Based on interpretations of drilling intercepts, the monzonite sill in the Lucky Strike area has an average orientation of N46°E/25°SE with distinct and sharp contacts with adjacent rocks. In the Sullivan area, orientations of the monzonite sill interpreted from drilling show differing orientations of the upper and lower contacts. The upper contact has an average orientation of S40°E/31° SW, whereas the lower contact has an average orientation of S86°E/24° SW. Whether the bodies are sills, rotated dykes or structurally transported slices remains to be determined. Monzonite bodies host the gold-copper mineralization at Sullivan, Gold Ledge and Lucky Strike.

Pratt and Ponce (2011) propose that the gold-copper mineralized monzonite bodies are unlikely to be fragments or slices of a dismembered porphyry system stock, but instead are composed of a series of widely distributed sills, dykes or plugs. They further propose that the Sullivan Sill could extend beneath the volcanic cover at Gold Ledge westward to the Kona Prospect, west of the Gabbs Property. Petrographic descriptions from drill core at Sullivan suggest the different monzonite bodies are genetically related. The monzonite intrusives are considered to be Jurassic-Cretaceous in age and, locally, appear to intrude the overlying Tertiary volcanic rocks, which may suggest continuation of intrusive activity into the Tertiary.



Source: Pratt and Ponce (2011)

Figure 7-6 Gabbs Intrusive Rocks and Textures

7.1.2.2 Tertiary Section

Tertiary volcanic units unconformably overlie the Triassic section (Figure 7-4). These units are thick sequences of Tertiary intermediate and felsic volcanic rocks (Figure 7-7). The Tertiary volcanic rocks consist of an older sequence of dark-brown to grey porphyritic andesite flows and tuffs overlain by a younger sequence of rhyolite ash flow tuffs and ignimbrites. The latter rock type is locally black and obsidian-like where least-altered. Major breccias in ignimbrites near Gabbs are probably phreatic, caused by steam explosion soon after deposition of the ignimbrite on a wet surface.

The volcanic rocks were subject to contemporaneous extensional (and compressional?) faulting and show lateral facies changes, internal unconformities and draping of incised topography. Wedges of coarse clastic material ('Boulder Beds') are developed locally. The Boulder Beds are a coarse, epiclastic or conglomerate unit up to 20m thick, which lies at the base of the Tertiary section directly on the erosional unconformity, particularly at Sullivan (Figure 7-8). Boulder Beds at Sullivan contain chalcopyrite-bearing vein quartz pebbles, which represents erosion of the host mineralized Triassic porphyry intrusion at Sullivan.

Tertiary volcanic and volcanoclastic rocks host the epithermal gold mineralization in the Car Body area and at the adjacent, Paradise Peak Deposit, which abuts the Gabbs Property to the south. The Paradise Peak Mine hosts a high sulphidation epithermal system from which 1.46 Moz Au, 38.9 Moz Ag, and 457 t Hg were produced in an open pit-heap leach operation from 1985 to 1993.



Source: Pratt and Ponce (2011)

Figure 7-7 Volcanic Rocks at Gabbs

7.1.2.3 Post-Tertiary Dykes

The youngest rocks found on the Property are east-west trending rhyolite dykes that cut all Triassic and Tertiary rocks. They vary from rhyolite to latite in composition and are generally >20m wide with sharp contacts. The dykes have a similar orientation to a large east-west trending linear feature observed in the magnetics.

7.2 Structure

Many interpreted folds exist within the Triassic Section, particularly at the Car Body, Gold Ledge and Lucky Strike Zones (Figure 7-9). The origin of these folds may be related to emplacement of the Mesozoic age Luning-Fencemaker allochthon. Folding also appears to be related to intrusion, as indicated by Triassic sedimentary rocks at Car Body forming a southeast-facing, synclinal fold that wraps around a large monzodiorite-quartz monzonite body. The sedimentary rocks also have a weak penetrative cleavage best developed south of Sullivan, in limestones and calcareous siltstones and strikes approximately east-west and dips steeply south.

Low-angle faults, including thrust faults in the Gabbs Property area, are likely associated with the Luning-Fencemaker event, and possibly later deformation events. Low-angle detachment faulting has been interpreted at the Paradise Peak Mine and areas to the south of the Gabbs Property. High-angle faulting occurs primarily in two orientations: north-northeast and west-northwest. The northeast trending faults are assumed to be associated with Basin and Range extension. Northwest trending faults sub-parallel the Walker Lane structures and appear to be associated with mineralized quartz \pm carbonate veins. A detailed structural study of the mineralization at the Gabbs Property indicates that the Triassic basement and Cretaceous porphyries were faulted prior to and during deposition of the Tertiary volcanic rocks (Pratt and Ponce, 2011). The Tertiary volcanics display contemporaneous fault control, lateral facies changes, and draping over strong fault-controlled (listric and half-graben) topography.

Mapping and logging by Pratt and Ponce (2011), confirm widespread shear zones and faults in the gabbros and porphyries. The shear zones are better developed in the mafic rocks, particularly those with olivine (now talc). Sinuous S-C fabrics and light-green, microscopic breccias (cataclasites) are widespread in these shear zones (Figure 7-10 and Figure 7-11). The strongest foliation occurs in gabbro adjacent to contacts with porphyry. Foliated gabbros are best exposed around the southeast end of the Sullivan Pit, where they dip parallel to the contact with the porphyry.

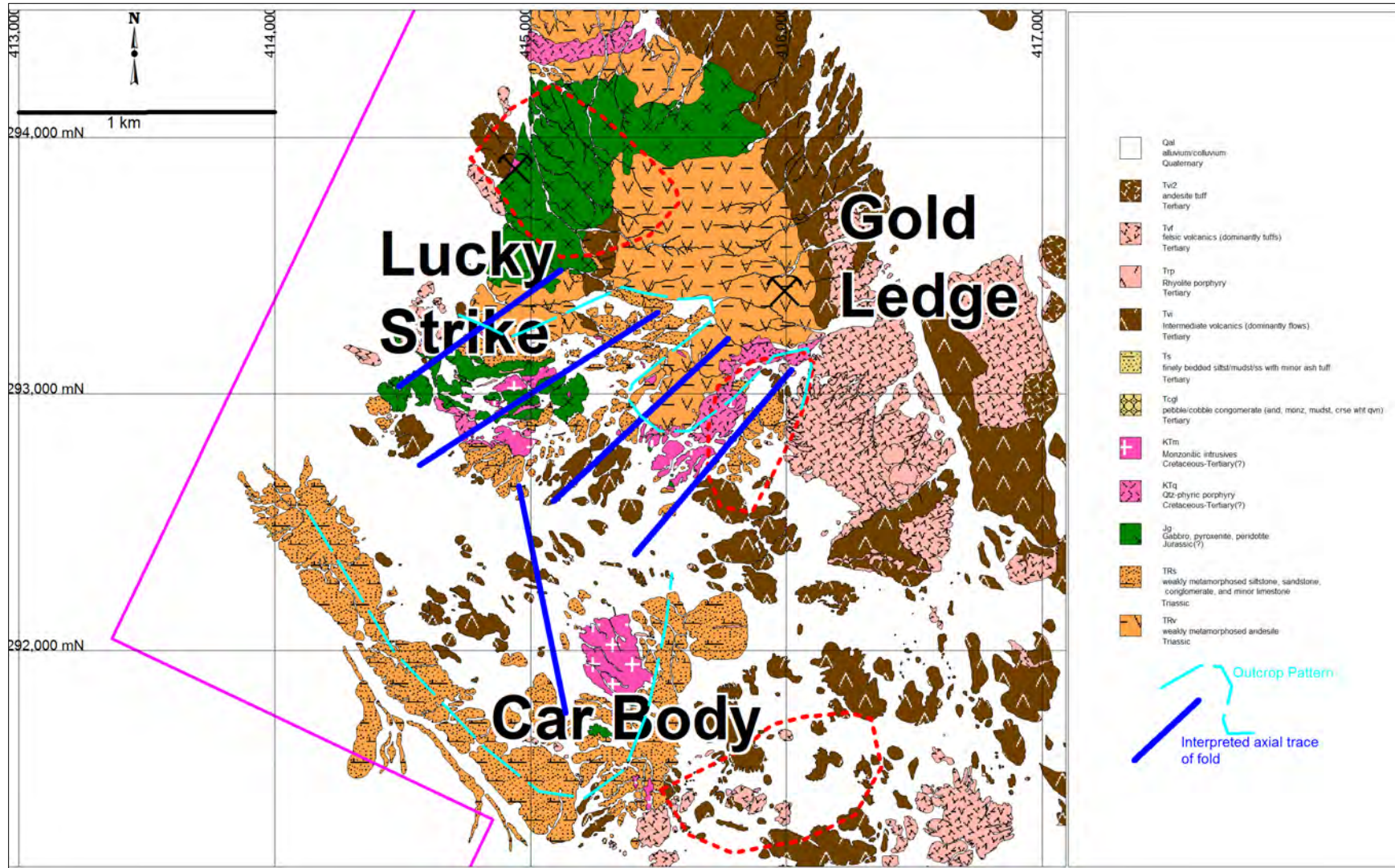

Source: Fierst (2009)

Figure 7-9 Axial Trace of Folds Within Triassic Rocks at Lucky Strike and Car Body



Source: Pratt and Ponce (2011)

Figure 7-10 Structure in Gabbs Mafic Rocks

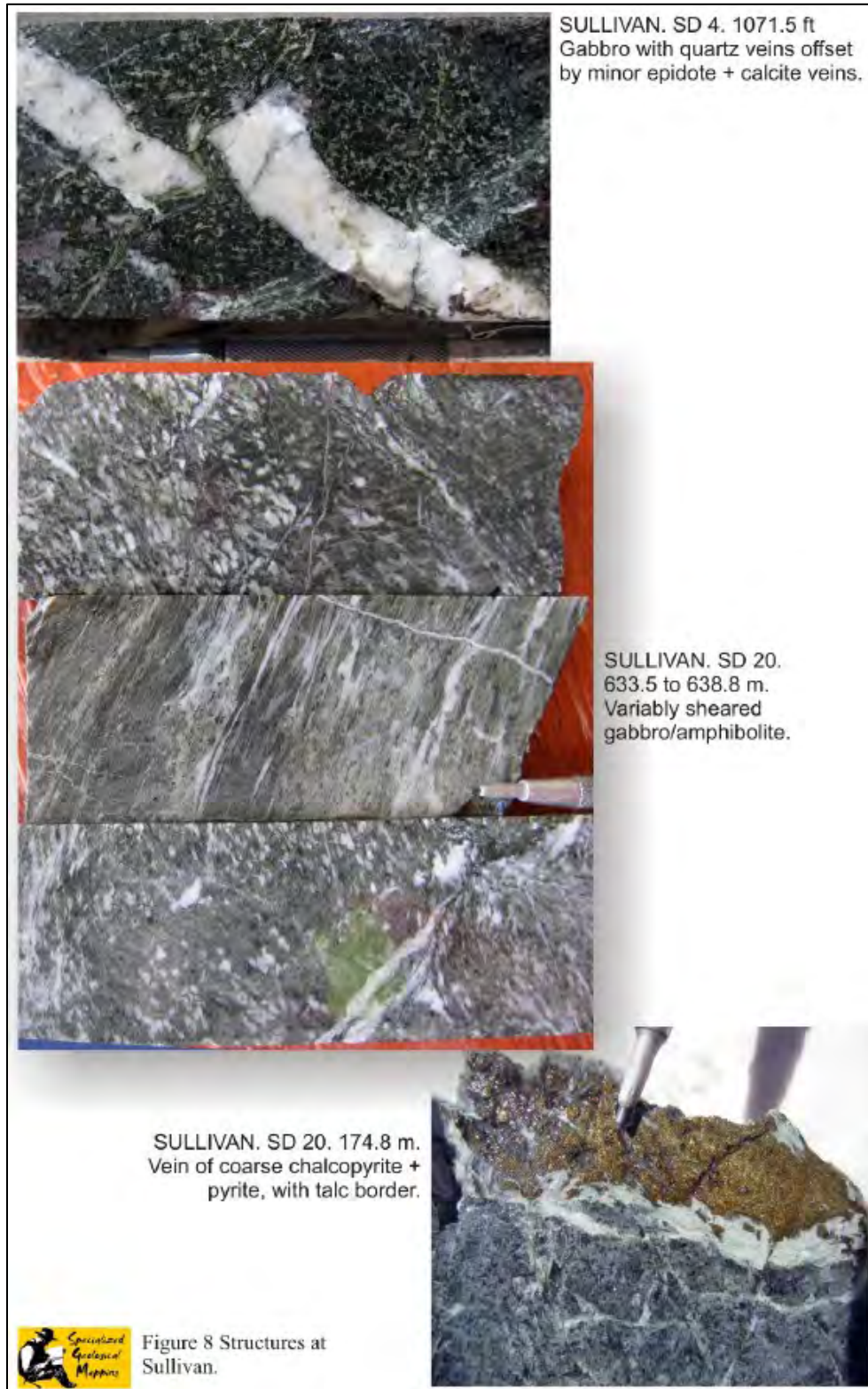

Source: Pratt and Ponce (2011)

Figure 7-11 Structure at Sullivan Pit

The porphyries were much more brittle than the gabbros. They are generally faulted and calcite-veined rather than sheared, particularly at Sullivan. The open pit at Sullivan shows similar widespread fracturing and faulting (Figure 7-12 and Figure 7-13), in various orientations. Some fault gouges and breccia zones attain 1-m width. Where offset can be determined, it is extensional/normal. At Gold Ledge the porphyritic monzonites and rhyolites are also cut by ductile shear zones

Despite the widespread fracturing and shearing, most porphyry bodies at Gabbs appear to have intrusive contacts and are not significantly dismembered by faulting. Some contacts are modified by shearing, as they represent strong competence contrasts. The strong foliation at major contacts is interpreted as the result of shearing and strain partitioning where more competent rock (porphyry) is in contact with more ductile rock (gabbro). However, none of the apparently major faults at Sullivan, which seem significant because of their wide gouges, offset the porphyry more than a few metres. Furthermore, many contacts observed in drill core are intrusive, though the core tends to break at contacts.

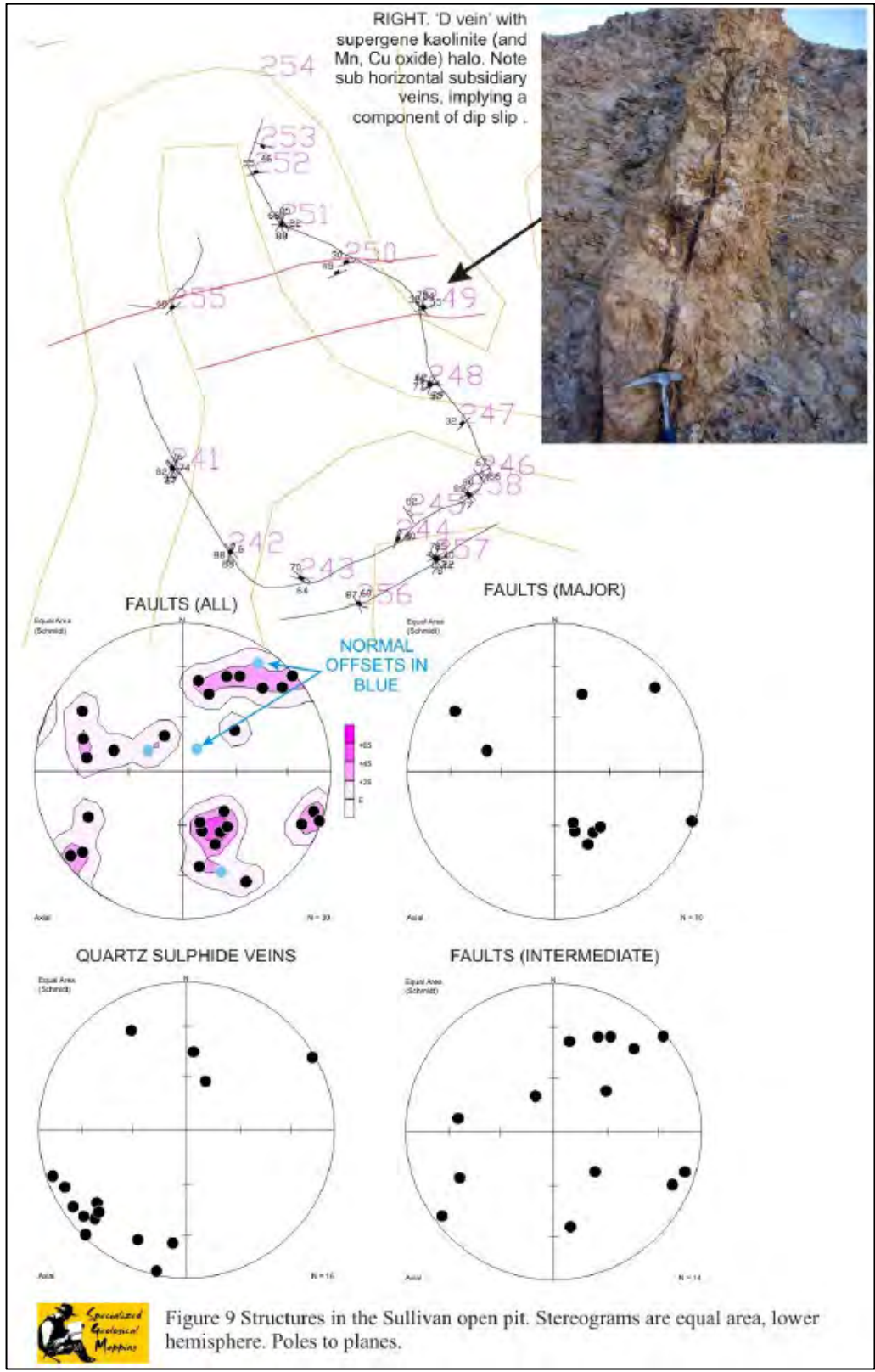

Source: Pratt and Ponce (2011)

Figure 7-12 Sullivan Open Pit Structure

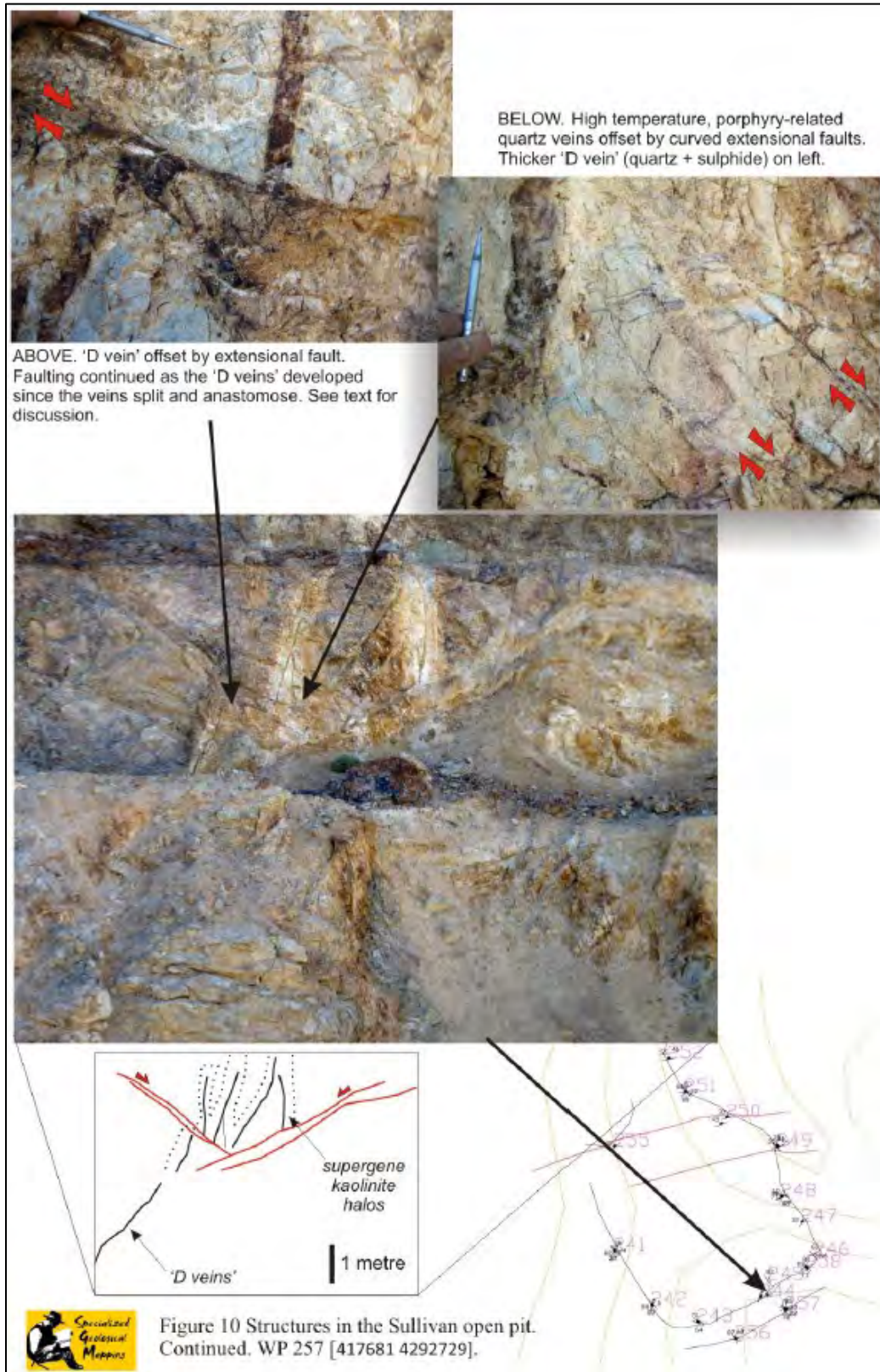

Source: Pratt and Ponce (2011)

Figure 7-13 Structures in Sullivan Pit

7.3 Alteration

The Triassic rocks are pervasively metamorphosed to the lower greenschist facies.

The metamorphism and alteration in the Property area is mostly localized and largely found to be contact-related near mafic intrusions. Sericitization and local silicification are the alteration type most commonly found in the Triassic rocks. The Triassic volcanic sequence also shows evidence of metasomatism and minor calc-silicate alteration (skarn). This is very apparent in the

Lucky Strike area, where the large gabbro complex is exposed. Calc-silicate alteration in this area is characterized by massive epidote, magnetite and minor actinolite localized around intrusive contacts. Elsewhere, the intermediate volcanic sequence is weakly to moderately recrystallized.

Similar to the volcanic sequence, metasomatism also affected the sedimentary rocks, from simple recrystallization to several metres of marblization along the intrusive contacts. The sedimentary rocks appear to lack sufficient calcium carbonate to form true skarn.

Alteration associated with porphyry-style mineralization includes potassic, phyllic and possibly sodic-calcic at Lucky Strike and Sullivan (Figure 7-14 and Figure 7-15). Monzonite porphyries are potassic, phyllic, and sodic-calcic altered. Mineral assemblages are sericite-pyrite (\pm chlorite, tourmaline, calcite, albite, rutile), interpreted to be phyllic and (or) sodic-calcic alteration, or albite-K-feldspar-biotite-sericite (\pm calcite, chlorite, epidote, titanite, rutile), interpreted to be potassic alteration. Primary ferromagnesian minerals have been largely replaced by biotite, chlorite and (or) sericite, plagioclase by albite or sericite, and the groundmass by potassium feldspar and (or) sericite.

Mafic-ultramafic intrusive rocks are interpreted to be either sodic-calcic or potassic altered. Mafic-ultramafic intrusive rocks are dominated by actinolite/tremolite-biotite-epidote-albite-calcite-chlorite (\pm tal, serpentine, titanite) alteration, interpreted as either sodic-calcic or potassic alteration. Pyroxene completely altered to actinolite or tremolite (and locally biotite) and plagioclase to albite and (or) epidote. Olivine in peridotite altered to serpentine and chlorite \pm talc. In highly strained ultramafic rocks, primary minerals entirely altered to talc-calcite-biotite (Mason, 2008). Mafic intrusive rocks contain both primary and secondary magnetite.

The Tertiary volcanic rocks are sericitized, propylitically, and argillically altered, with minor silicification. Intermediate Tertiary volcanic units contain minor primary magnetite (responsible for a stippled pattern in magnetic images), and mafic minerals altered to chlorite.

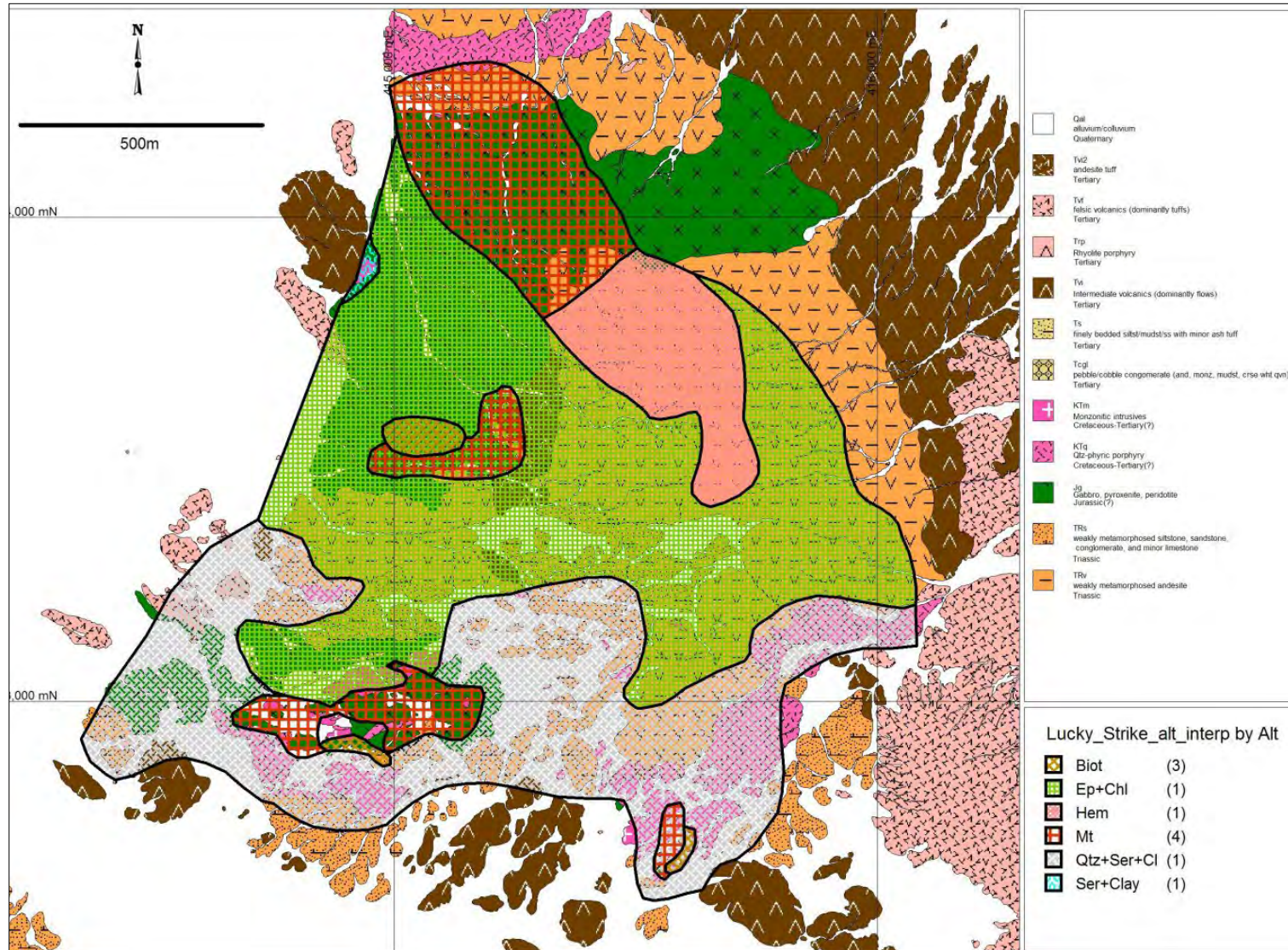

Source: Fierst (2009)

Figure 7-14 Porphyry Style Alteration at the Lucky Strike Deposit

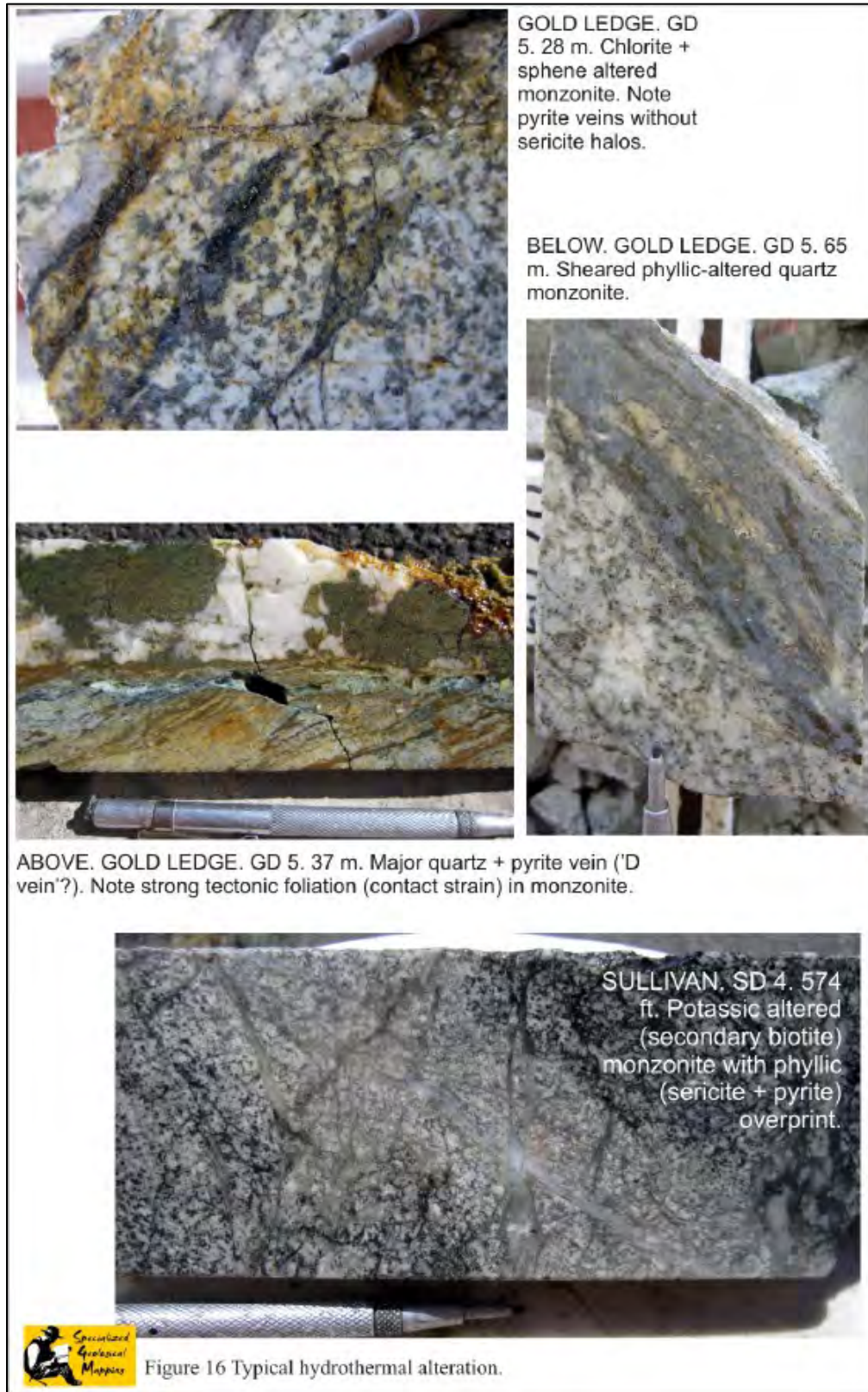

Source: Pratt and Ponce (2011)

Figure 7-15 Typical Hydrothermal Alteration at Gabbs

7.4 Mineralization

Mineralization and hydrothermal alteration at the Gabbs Property occurs in two principal styles:

- 1) Porphyry gold-copper-molybdenum mineralization with associated potassic, phyllic and propylitic alteration; and
- 2) Volcanic-hosted gold-mineralized hydrothermal breccias with associated phyllic and argillic alteration.

There are four separate mineral deposits, three of which (Gold Ledge, Lucky Strike and Sullivan) are considered to be porphyry gold-copper deposits. The Car Body Deposit is considered to be a nuggety epithermal gold deposit.

7.4.1 Porphyry Gold-Copper Mineralization

Porphyry copper deposits are among the largest and most valuable mineral-deposit types on earth and are the most important source of global copper supply. The deposits typically contain hundreds of millions of tons of mineralized rock and millions of tons of copper, with smaller amounts of molybdenum, gold, and (or) silver.

Porphyry copper deposits form in subduction-related magmatic arcs and northern Nye County contains parts of at least three such arcs: 1) Late Triassic to Jurassic age; 2) Cretaceous to Palaeocene age; and 3) Oligocene and Miocene age. Although large porphyry copper deposits are not known in the northern Nye County region, at least two sites provide specific analogues to deposits that may exist. The Royston Deposit is 40 km northwest of Tonopah, on the Nye-Esmeralda County line, and the Sullivan Deposit occurs on the Gabbs Property. The Lucky Strike and Gold Ledge Deposits are also considered to host porphyry-style mineralization.

7.4.1.1 Sullivan, Lucky Strike and Gold Ledge Zones

The Sullivan Deposit, also known as Cuervo, is located approximately four km northeast of the Paradise Peak epithermal gold deposit (Ludington *et al.*, 2009), and is exposed at the surface where the monzonite “sill” outcrops. The Deposit is a vein stockwork hosted in Late Cretaceous monzonite porphyry. The veins contain copper and gold. Glamis Gold Ltd. excavated 30,000 tons of mineralized material from a surface pit for test leaching purposes in the late 1980s.

Porphyry gold-copper-molybdenum mineralization occurs in two shallow dipping sill-like monzonite porphyry bodies at the Sullivan and Lucky Strike Deposits, and a vertically continuous body, possibly a plug, at Gold Ledge. The “sills” range from 1 to >100m thick and are laterally extensive. Average orientation at Lucky Strike is N46°E dip 25°SE and Sullivan varies from N140°E dip 31°SW (upper contact) to N94°E dip 24°SW (lower contact). The “sills” may be rotated dykes or tectonically emplaced slabs of a porphyry stock. A longitudinal section

through the Sullivan Deposit is shown in Figure 7-16 and a representative cross-sectional projection in Figure 7-18.

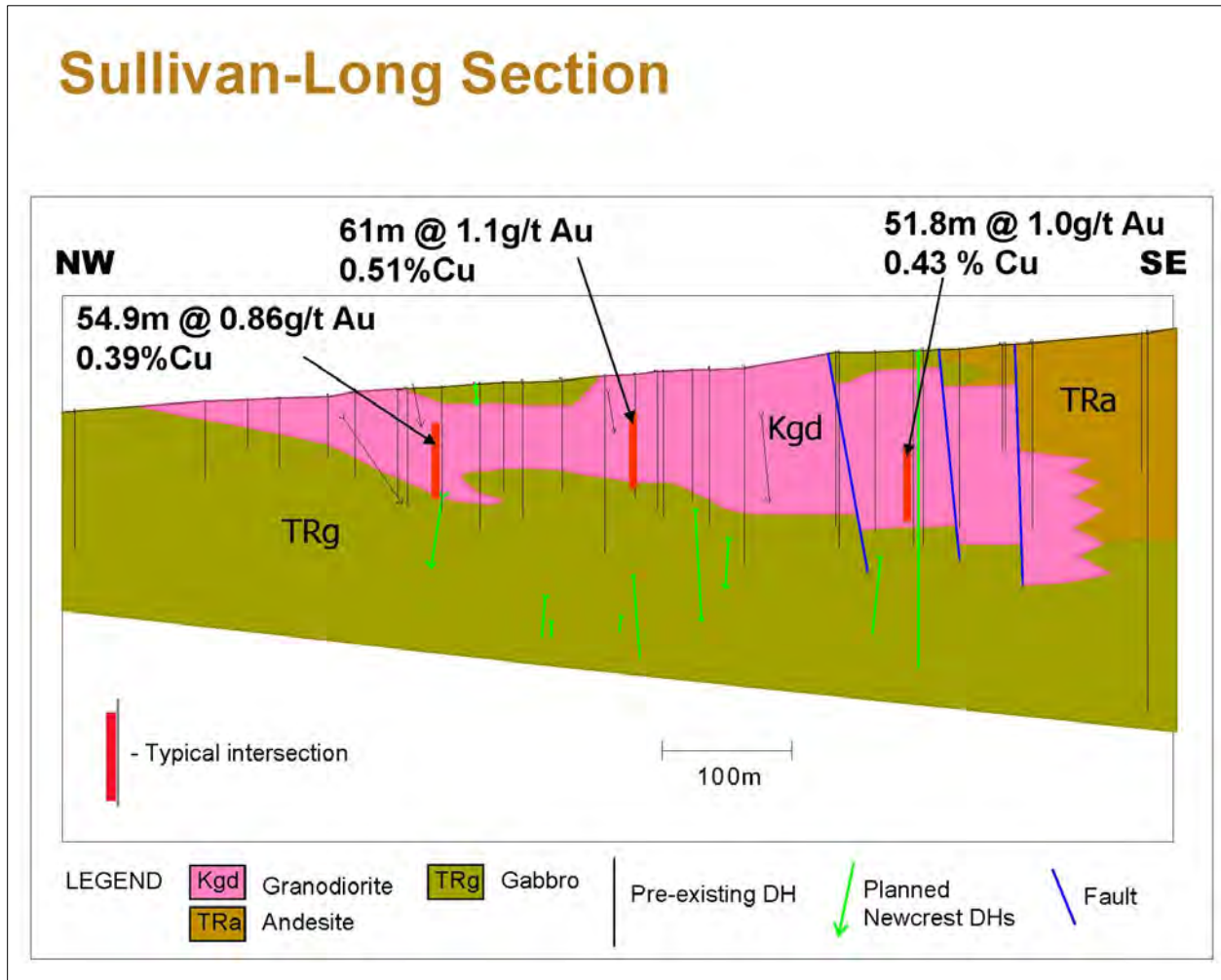

Source: Newcrest Mining Limited Exploration Presentation (September 2006)

Figure 7-16 Representative Longitudinal Section Through the Sullivan Zone

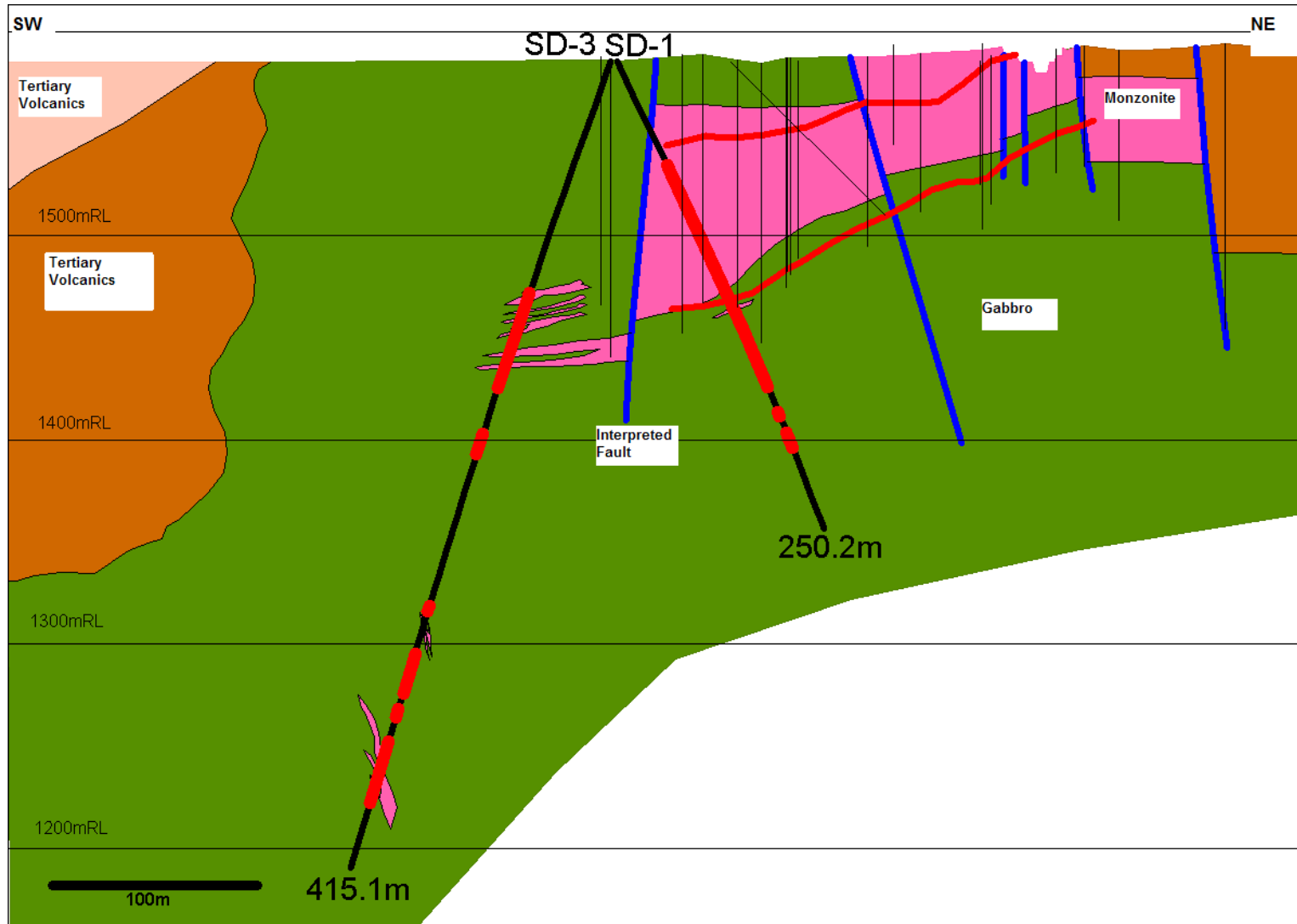

Source: Fierst (2009)

Figure 7-17 Southwest-Northeast Cross-Sectional Projection Through the Sullivan Zone Showing Interpreted Fault Truncating Monzonite Sill

Porphyry-style mineralization at Gabbs is characterized by stockworks, grain boundary filling and disseminations of early sulphide ± biotite veinlets. These bodies are mostly cut by quartz-chalcopyrite “A” veins and less common “B” veins accompanied by potassic alteration (biotite and K-feldspar). Quartz-sericite-pyrite (phyllic) alteration is common and generally accompanied by thick, quartz-pyrite-chalcopyrite-molybdenite “D” veins (see Figure 7-12 and Figure 7-13 above). Thick, massive to coarsely crystalline, sometimes ribbon-textured, pinching and swelling, mesothermal quartz-chalcopyrite-chalcocite “D” veins occur in monzonite porphyries and in surrounding Triassic metavolcanic and metasedimentary country rocks. Visible gold was observed in one such vein. Late veins of pink manganoan calcite cut mineralized monzonite porphyry in places and selenite (after anhydrite) was observed at Lucky Strike. The textures, mineralogies and compositions of the monzonite porphyry, gabbro and associated ultramafic lithologies and hydrothermal alteration assemblages at the Gabbs Property have been confirmed in thin-section petrographic studies.

Results from three drill core holes at the Sullivan Zone are summarized below:

Drill hole SD-04: From 100m to 208m (306-635 ft), gold ranges up to 1.75 g/t Au, but most values are between 0.1 g/t and 1 g/t Au. Other intersections include 0.1 g/t to 0.2 g/t Au at 283m to 330m (864 ft to 1,005 ft) and 364m to 418m (1,110 ft to 1,275 ft) in variably sheared and intercalated gabbro and monzonite. Copper ranges between 0.1% and 0.4% at 100m to 333m (306 ft to 1,015 ft) and 364m to 418m (1,110 ft to 1,275 ft), and molybdenum ranges between 1 ppm to 192 ppm at 98m to 420m (300 ft to 1,280 ft);

Drill hole SD-05: From 0m to 44m (0 ft to 144 ft), gold ranges up to 0.05 opt Au. However, most values are between 0.005 opt to 0.02 opt Au. From 0m to 111m (0 ft to 364 ft) copper grades are up to 2.3% Cu. However, most copper values range between 0.1% to 0.4% Cu. From 9m to 41m (27 ft to 125 ft), there is a 32m (98 ft) intersection of 0.02 opt Au and 0.40% Cu; and

Drill Hole SD-20: From 14m to 134m (46 ft to 440 ft), gold is up to 0.04 opt Au. However, most values between 0.003 opt and 0.020 opt Au. Copper grades are up to 0.22% Cu. However, most copper grades are between 0.02% to 0.01% Cu.

Results from one drill core hole at the Lucky Strike Zone are summarized below.

Drill Hole GD-03: Gold ranges between 0.1 g/t to 1 g/t Au from 36m to 76m (118 ft to 249 ft) and between 0.004 opt to 0.02 opt Au from 82m to 94m (269 ft to 308 ft) in monzonite. Copper ranges between 0.10% to 0.44% Cu from 36m to 158m (118 ft to 518 ft) in monzonite and gabbro (Figure 7.18).

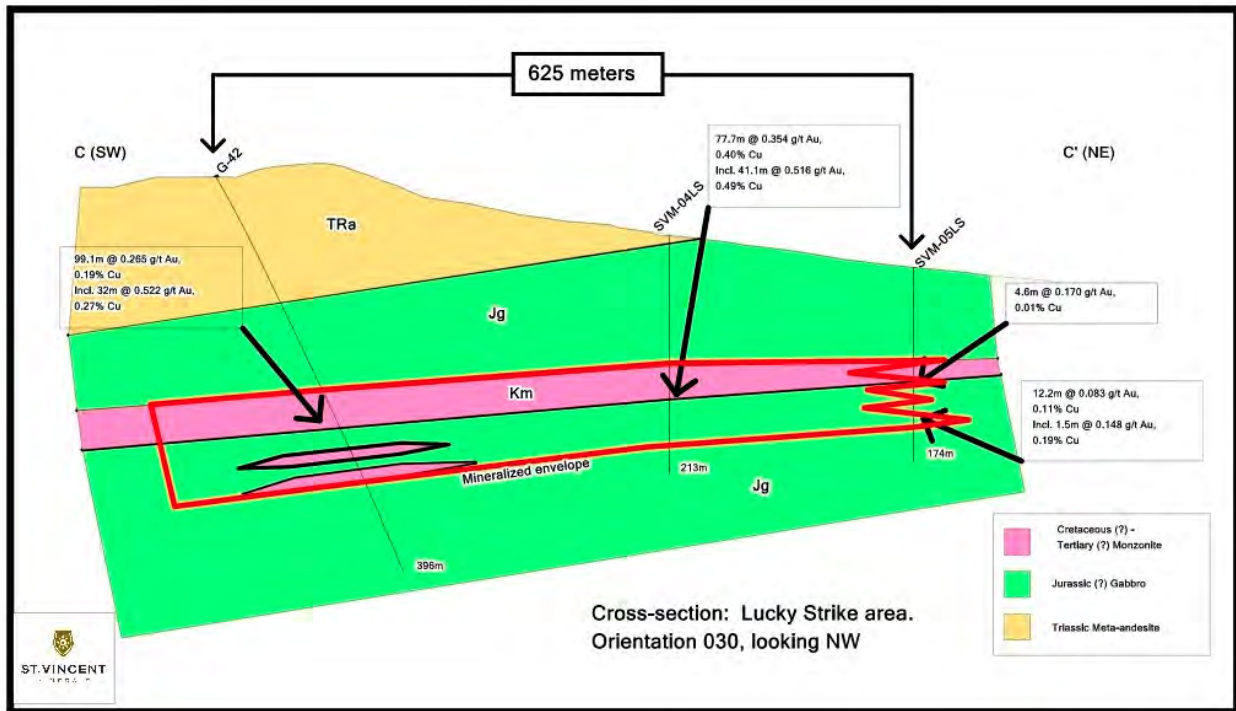

Source: St. Vincent Minerals Inc. (2011)

Figure 7-18 Southwest-Northeast Cross-Sectional Projection Through Lucky Strike Zone

Results from two drill core holes at the Gold Ledge Zone are summarized below.

Drill Hole GD-05: From 0m to 166m (0 ft to 544 ft), gold is up to 1.4 g/t Au. However, most grades are between 0.1 g/t Au to 0.5 g/t Au. Copper values are from 0.002% Cu to 0.760% Cu in phyllic-altered monzonite; and

Drill Hole GD-06: From 6m to 86m (20 ft to 282 ft), gold is from 0.1 g/t Au to 0.6 g/t Au and copper is from 0.1% Cu to 1.4% Cu. Mineralization only occurs in monzonite (Jemielita, 2009).

7.4.2 Epithermal Gold-Silver Mineralization

Epithermal gold-silver deposits are important sources of gold and silver worldwide (Simmons and others, 2005). They form at depths of <1.5 km depth and temperatures of <300°C, mainly in subaerial hydrothermal systems (Henley and Ellis, 1983; Hedenquist and Lowenstern, 1994). These hydrothermal systems developed in association with calc-alkaline, alkaline and, less commonly, tholeiitic magmatism, generally in volcanic arcs at convergent plate margins, and also in intra-arc, back-arc, and post-collisional rift settings. In addition, some non-magmatically heated epithermal deposits formed by deep circulation of meteoric water along steep extensional faults are present in northern Nevada.

Epithermal gold-silver deposits have highly variable characteristics, including mineralized material and alteration mineralogy and gold, silver, and base metal (Cu, Pb, Zn) contents, and formed in diverse geologic environments (Hedenquist and others, 2000; Sillitoe and Hedenquist, 2003; Simmons *et. al.*, 2005). Two principal types of deposits are low-sulphidation deposits (also called quartz-adularia or adularia-sericite type deposits) and high-sulphidation deposits (also called quartz-alunite or acid-sulphate deposits).

Epithermal deposits have been the largest producers of gold-silver in northern Nye County since discovery of silver-rich veins in the Tonopah District in 1900. Round Mountain has the largest total production and is the largest current producer in the region. It has produced >373,000 kg of gold and 311,000 kg of silver since 1907.

In northern Nye County, isotopically dated epithermal gold-silver mineralizing systems range in age from approximately 26 Ma to 17 Ma. High-sulphidation deposits generally form in or proximal to eruptive/intrusive centres and have a larger magmatic component than low-sulphidation deposits. Their formation is related to degassing of shallow, oxidized magma bodies and circulation of acidic hydrothermal fluids released from these magmas. Paradise Peak, a deposit south-adjacent to the Gabbs Property, is the only significant high-sulphidation deposit in the Gabbs region. Several additional large deposits occur nearby in Esmeralda and Mineral Counties.

Low-sulphidation deposits are common in the western half of northern Nye County and are widespread throughout much of the northern Great Basin. On the Gabbs Property, the Car Body Deposit is an epithermal gold deposit hosted in similar Tertiary volcanic rocks to the Paradise Peak Deposit. Whereas Paradise Peak was a high-sulphidation epithermal gold deposit, Car Body is of the low-sulphidation type. The Gold Ledge area also has potential to contain an epithermal gold deposit.

7.4.2.1 Car Body Zone

The Car Body Zone at the Gabbs Property is hosted in intrusive, magmatic-hydrothermal breccias. The breccias occur in Miocene upper andesite-dacite and middle rhyolite volcanic and intrusive lithologies best exposed in the adjacent Paradise Peak Mine. Breccia textures were recognised previously in petrographic studies of RC drill hole chips from the Car Body Deposit. Coarse gold is reported in RC drill chips from Car Body. However, the gold values are variable and difficult to reproduce between RC and drill core, which indicates a strong gold “nugget effect”. Results from two core holes are summarized below:

Drill Hole GD-01: From 0m to 244m (0 ft to 801 ft), gold values are mostly at detection limit to weakly anomalous (<10 ppb). From 37m to 94m (121 ft to 308 ft) gold values are moderately to

strongly anomalous (>10 ppb) up to a maximum 0.4 opt gold. The intersection is dominated by phyllic-altered andesite-rhyolite intrusive breccias; and

Drill Hole GD-02: Gold ranges up to 5.691 g/t Au. From 20m to 41m (65 ft to 135 ft) is 21m (70 ft) of 0.02 g/t Au, including 4.2m (13.7 ft) of 0.05 opt Au. The intersection is dominated by quartz-sericite-pyrite- (phyllic-) altered, andesite-rhyolite intrusive breccias.

7.4.3 Alteration Zonation

Mineralization lacks clear zonation of alteration and (or) geochemistry that might be utilized as a vector towards a central source porphyry stock. The apparent alteration zonation at Lucky Strike is considered to be lithologically controlled.

8.0 DEPOSIT TYPES

Metalliferous mineral deposits are an important component of the economy in Nevada. Many of these mineral deposits have a close spatial and temporal association with intrusive centres and several different types of genetically related deposits can occur in clusters around these centres. Important mineral resources of Cu, Mo, W, Au, Ag, Pb and Zn may exist in deposits related to intrusive rocks, such as porphyry deposits, skarn deposits, polymetallic vein and replacement deposits, distal disseminated Ag-Au deposits, and some types of epithermal Au-Ag deposits.

There are currently four separate mineralized zones known on the Gabbs Property: the Sullivan, Lucky Strike, Gold Ledge and Car Body Zones. The Sullivan, Lucky Strike and Gold Ledge Zones are considered to be gold-copper porphyry deposits, whereas the Car Body Zone is considered to be a low-sulphidation epithermal gold deposit. A schematic diagram of a porphyry system and associated epithermal mineralization types is shown in Figure 8-1.

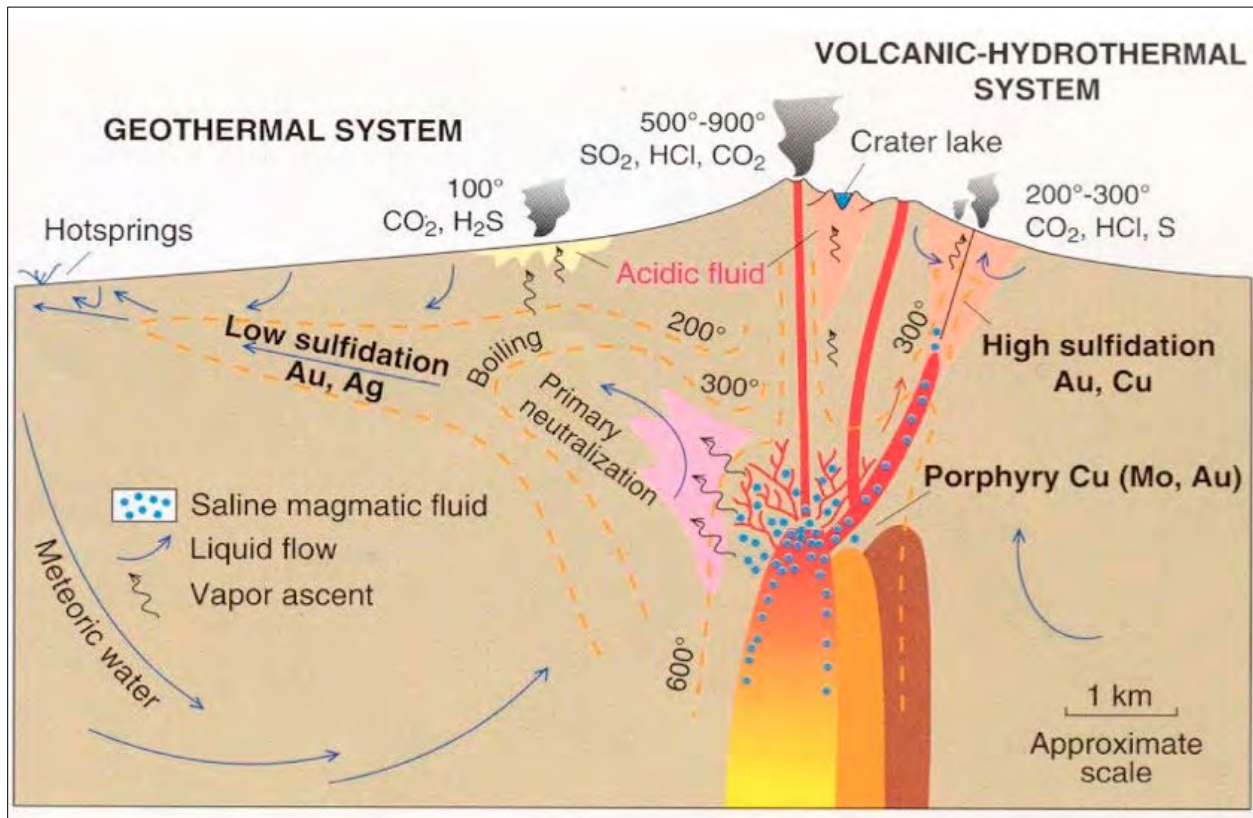

Source: Saunders and Hames (2006)

Figure 8-1 Model of Relationship of Low-Sulphidation and High-Sulphidation to Co-Genetic Sub-volcanic Intrusions and Associated Porphyry-Style Mineralization

8.1 Gold-Copper Porphyry Deposits

Gold-copper porphyry deposits are emplaced in a variety of subduction-related settings and are underlain by both oceanic and cratonic crust in either extensional or compressional tectonic regimes. This type of mineral deposit is associated with composite porphyry stocks of steep, cylindrical form that commonly intrude coeval volcanic piles. Stocks and associated volcanic rocks range in composition from low-potassium calc-alkaline through high-potassium calc-alkaline to potassic alkaline (Figure 8-2). Much of the copper and gold is introduced during potassium-silicate alteration, with or without amphibole and other calcic minerals.

Gold-copper porphyry deposits contain many of the geological features of typical copper porphyry deposits. The gold occurs in veinlet stockworks and as disseminations within or immediately contiguous to porphyry stocks. These porphyry stocks are the centre of more extensive hydrothermal systems and may host other types of gold deposits, particularly high- and low-sulphidation epithermal veins. The Car Body Zone is a low-sulphidation deposit on the Gabbs Property. The Paradise Peak Deposit, located on the property south-adjacent to the Gabbs Property, is a high-sulphidation epithermal deposit.

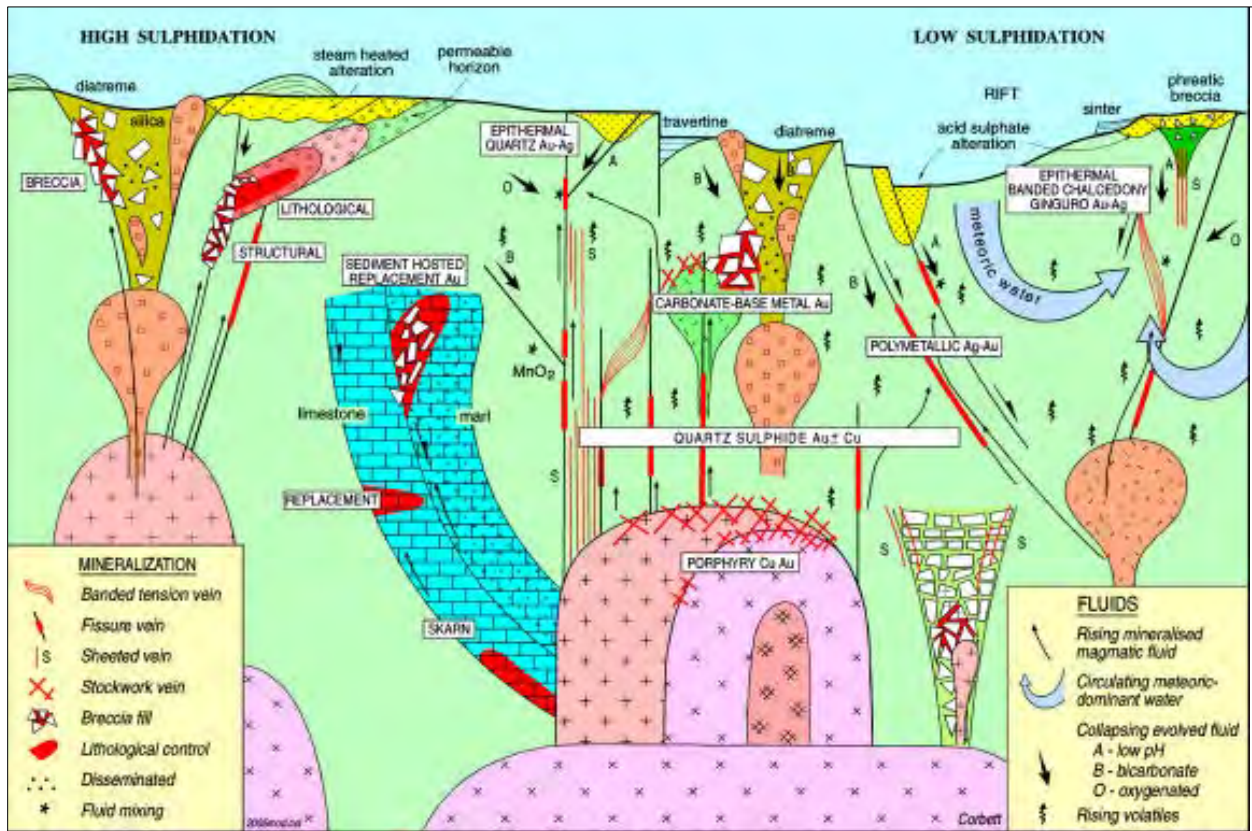

Source: Corbett (2009)

Figure 8-2 Conceptual Model Illustrating Different Styles of Magmatic Arc Porphyry and Epithermal Cu-Au-Mo-Ag Mineralization

8.2 Low-Sulphidation Epithermal Deposits

Low-sulphidation epithermal Au-Ag deposits are distinguished from high-sulphidation by the sulphide mineralogy, location more distally from causative magma bodies, and formation by geothermal fluids (reduced, diluted, with neutral pH) mixed with ground water. Low-sulphidation deposits form in dilational, rift-style structural settings. The mineralizing fluids in a low-sulphidation epithermal systems generally contain a smaller magmatic component. Pyrite, sphalerite, galena, and chalcopyrite typically occur quartz veins with local carbonate and associated near-neutral wall rock alteration (illite clays), deposited from dilute hydrothermal fluids. Low-sulphidation veins are typically well banded, with each band representing a separate episode of hydrothermal mineral deposition. Three main types of hydrothermal fluids contribute to low-sulphidation vein formation (Figure 8-3):

- 1) Meteoric-dominated fluid that commonly forms shallow circulating cells and deposit barren quartz, which has not come into contact with intrusion sources of metals, and therefore are commonly barren;
- 2) Magmatic-meteoric fluid developed where meteoric waters migrate sufficiently deep to come in contact with intrusion sources of metals. The resulting mineralized veins contain low-grade mineralization within disseminated sulphides; and
- 3) Magmatic-dominant fluid derived from magmatic metal sources at depth. The resulting sulphide veins contain the highest precious metal values associated with sulphides.

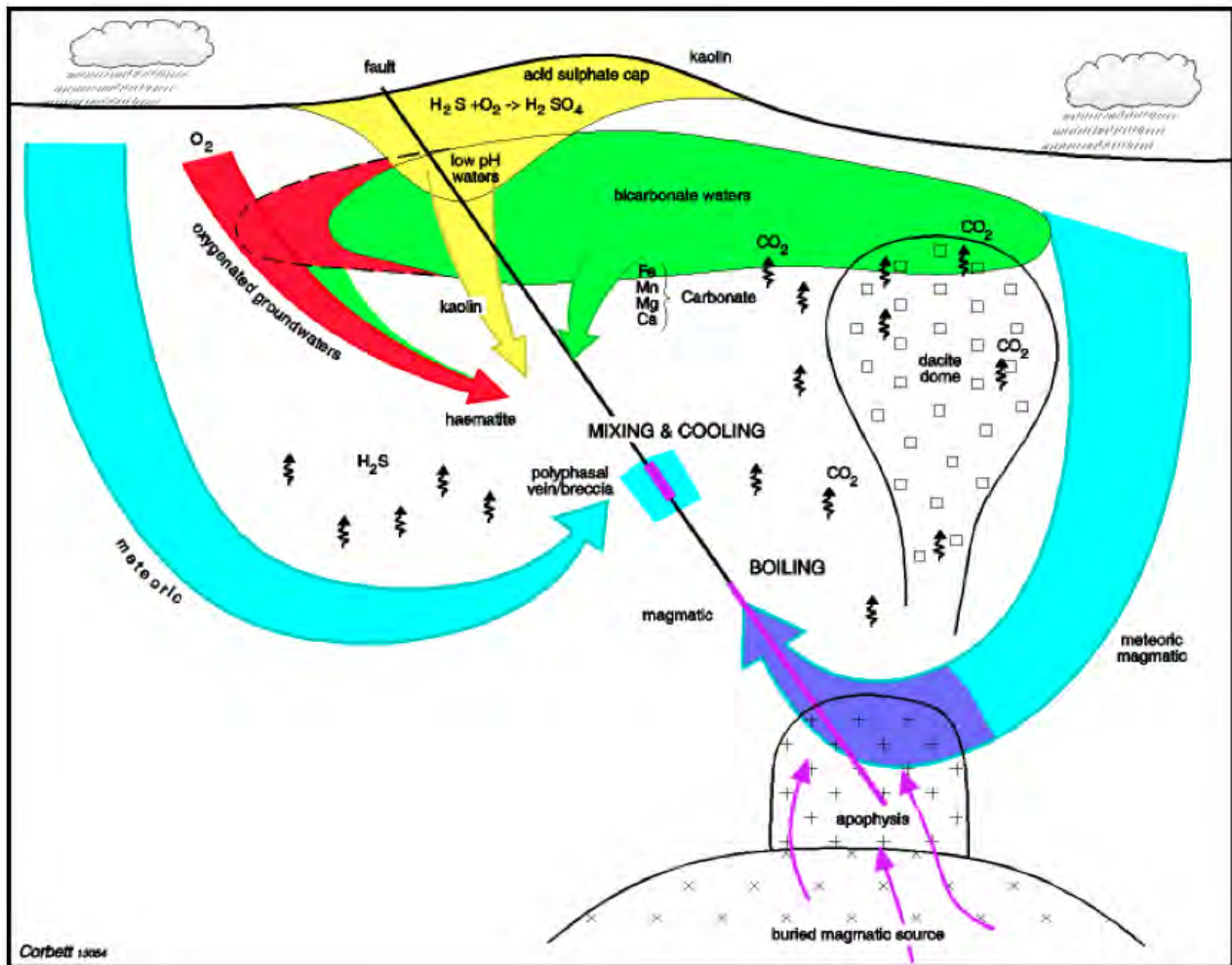

Source: Corbett (2009)

Figure 8-3 Model Accounting for Varying Hydrothermal Fluids Contributing to the Development of Banded Low-Sulphidation Epithermal Au-Ag Veins

Low-sulphidation epithermal Au-Ag mineralization is best developed in geological settings where factors such as lithology, structure and the mechanisms of Au deposition have a great influence. Lithological control occurs mainly as competent or brittle host rocks that develop through-going fractures to host veins. Host rock permeability is locally important. In interlayered volcanic sequences, epithermal veins may be confined to only the competent rocks, whereas interlayered and less competent rocks host only fault structures.

Structures act as fluid pathways, such that the more dilational parts of the host structures may represent sites of enhanced fluid flow and promote the development of more continuous mineralization in many low-sulphidation vein systems. Fault intersections that host mineralized material shoots may represent fluid mixing sites.

The mechanisms of Au deposition can greatly affect the grade, as outlined below:

- Cooling produces many coarse-grained sulphides with low-grade Au contents;
- Rapid cooling of magmatic fluids producing fine-grained sulphides or by the mixing of metal-bearing fluids with deep circulating meteoric waters;
- Mixing of oxygenated ground waters with metal-bearing fluids at elevated crustal settings produces elevated Au grades with hypogene hematite in the mineral assemblage;
- Mixing of low pH waters, created by the condensation of H₂S volatiles above the water table, is responsible for the development of near-surface acid sulphate caps and provides the highest Au grades. This mechanism of Au deposition is characterized by the presence of hypogene kaolin, including halloysite, within the mineral assemblage; and
- Styles of low-sulphidation Au are distinguished according to mineralogy and relation to intrusion source rocks and influence precious metal grade, Ag:Au ratio, metallurgy, and Au distribution.

The Gabbs Property exhibits quartz-sulphide Au ± Cu style mineralization, which is characterized by quartz and by pyrite as the main sulphide phase. Quenched, very-fine grained pyrite locally exhibits difficult metallurgy, whereas coarser sulphides are typically associated with the near-surface supergene Au enrichment.

Geophysical surveys can help identify certain deposit characteristics. Gravity surveys are designed to find geological structures and differences in subsurface density. Induced polarization surveys are designed to find subsurface material, such as mineralized or alteration zones. The phyllic alteration present at the North Sullivan area should yield a high chargeability response in an IP survey. The geophysical surveys produce anomalous zones that can subsequently be drill tested.

9.0 EXPLORATION

9.1 Geophysics

A gradient induced polarization (“IP”) geophysical survey was completed over the Sullivan, Lucky Strike and Gold Ledge Zones, the Car Body Zone, and the South Sullivan area (south of drill holes SVM-6, SRD-14 and SD-21). The objective of the survey was to develop a signature profile of the known mineralization and to highlight potential extensions of the Sullivan mineralization, as that Zone remains open. A gradient IP geophysical survey is especially well suited for defining near surface mineralization that can be exploited by open pit mining methods. The survey consisted of 16-line km (10-line miles) covering an area measuring 1 km by 1.5 km (0.6 mile by 0.9 mile).

In the field, a 48.3-line km (30.0-line miles) Natural Source Magneto-Telluric (“NSMT”) survey was completed over all four known mineralized Zones and prospective source copper porphyry locations between the Zones (Figure 9-1).

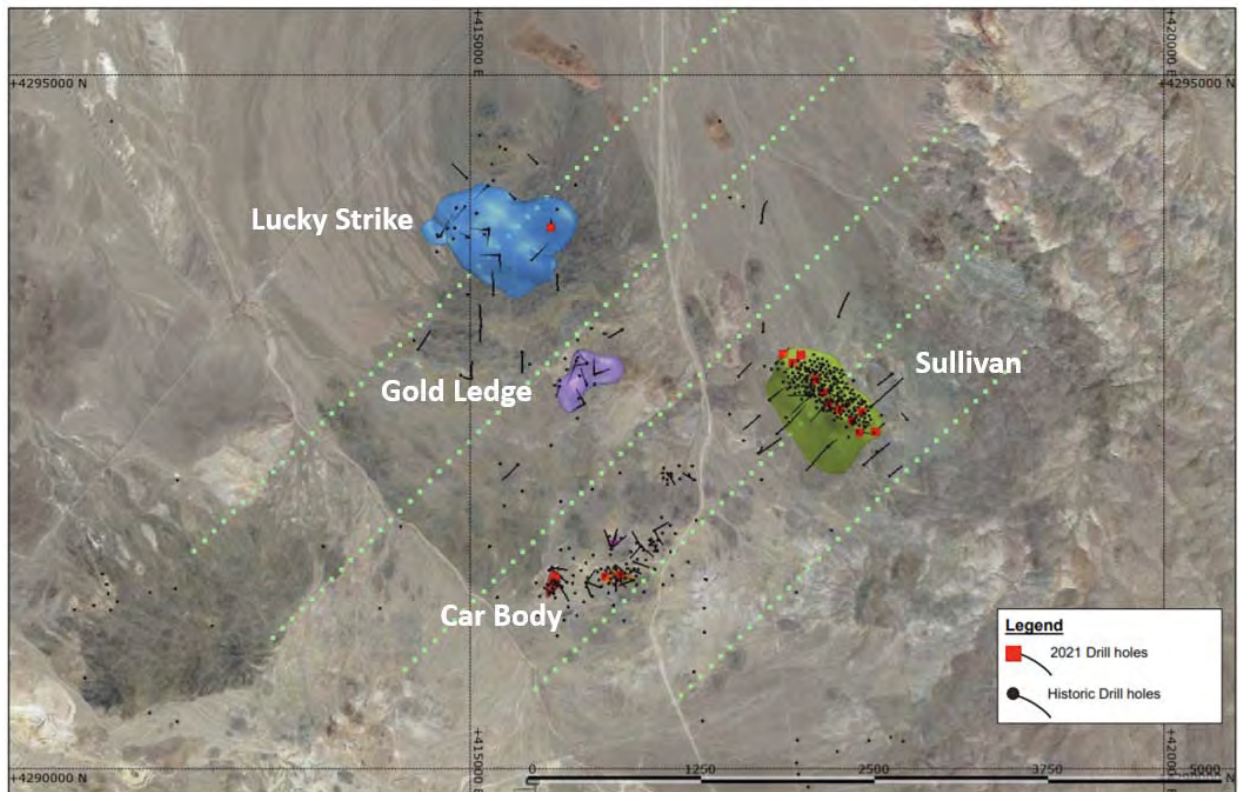

Source: P2 Gold (press release dated October 19, 2021)

Figure 9-1 2021 Natural Source Magneto-Telluric Survey Lines

In 2023, Computational Geosciences created 3-D electrical conductivity, inversion models of the NSMT survey data. A high priority gold-copper porphyry exploration target was identified in the centre of the Property below the Gold Ledge Zone. The Company requires an additional permit in order to drill the exploration target. A plan view and sections from the 3-D inversion model are presented in Figure 9-2 through Figure 9-4.

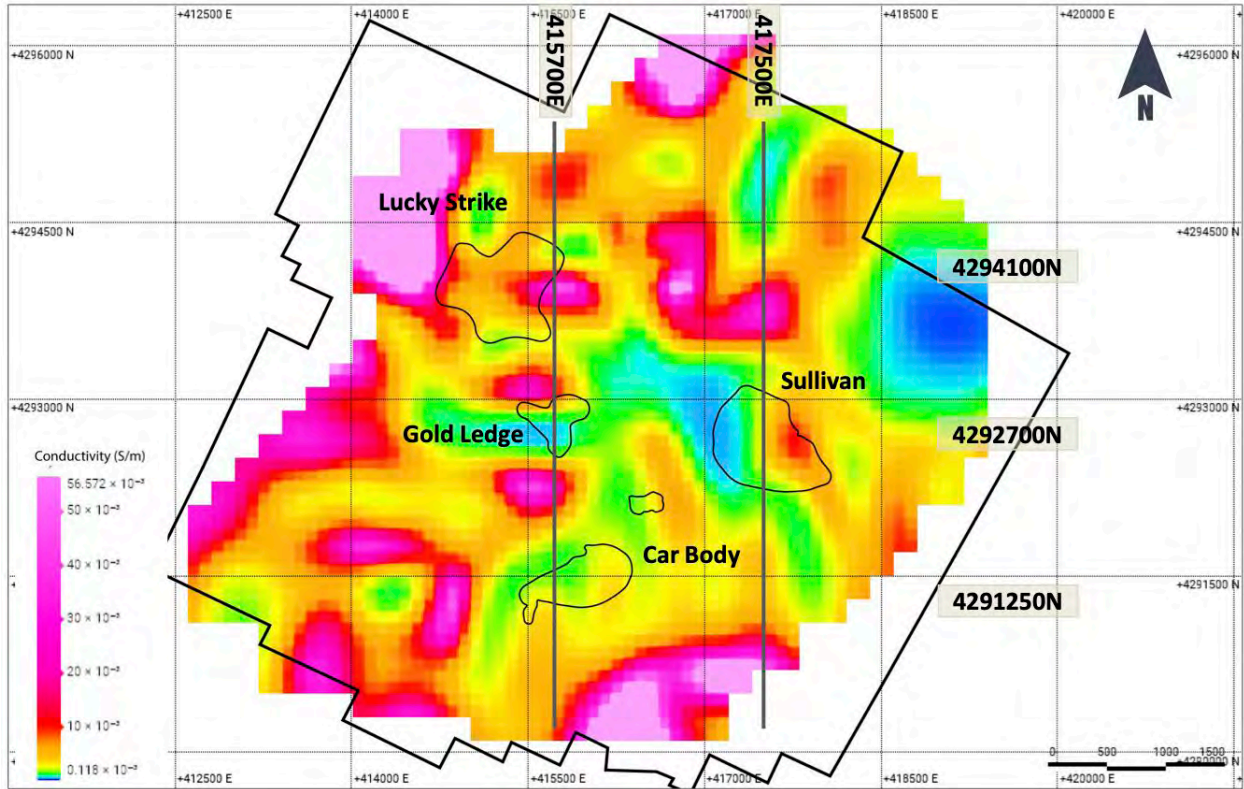

Source: P2 Gold (press release dated March 29, 2023)

Figure 9-2 3-D Inversion with Plan Section Lines

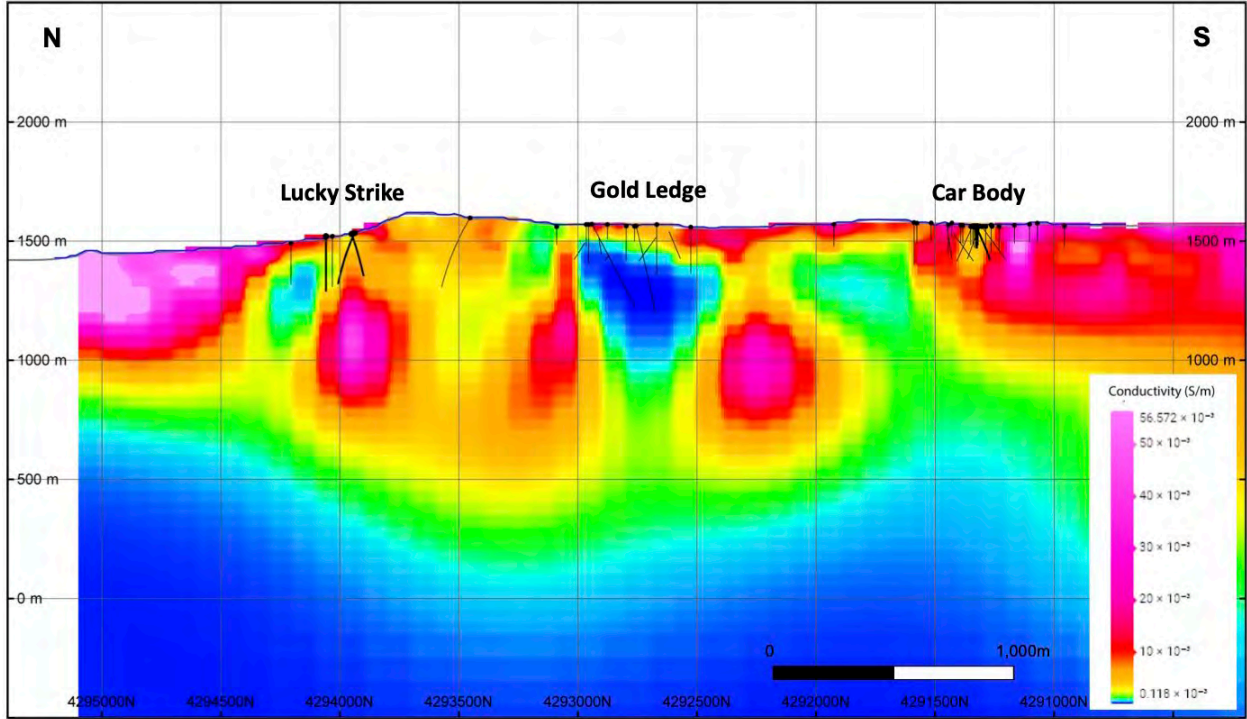

Source: P2 Gold (press release dated March 29, 2023)

Figure 9-3 Section Line 415,700E Looking East

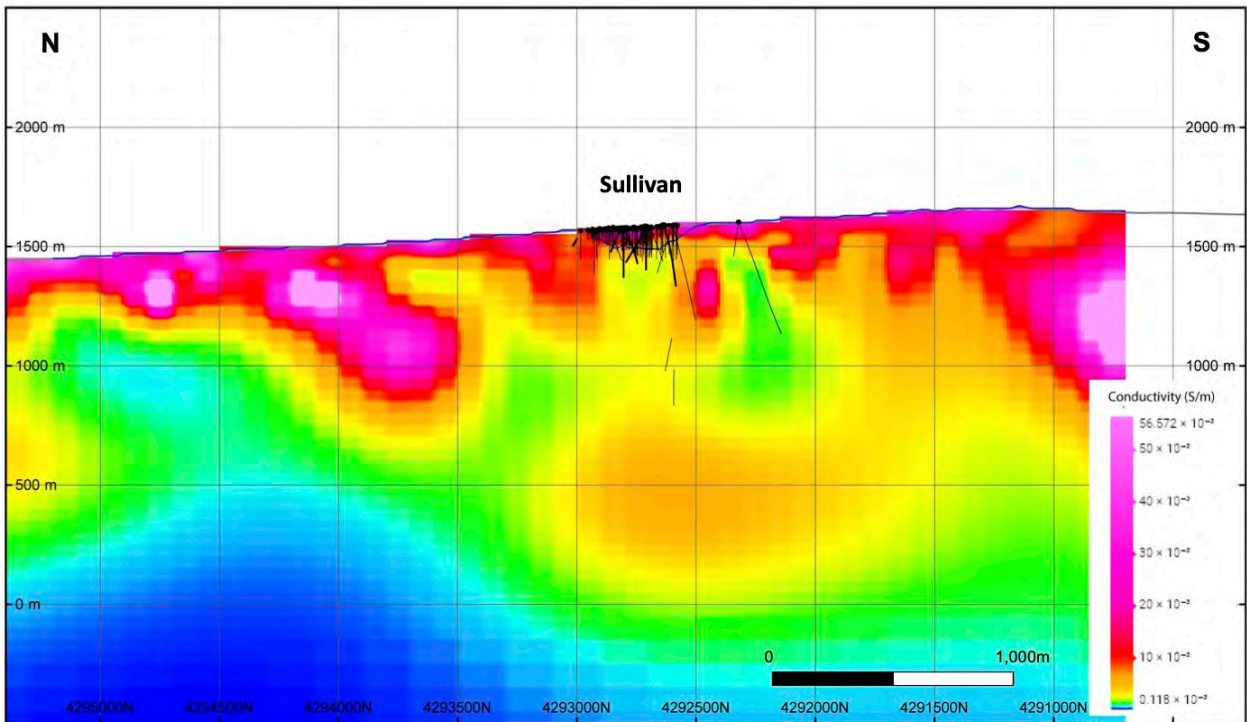

Source: P2 Gold (press release dated March 29, 2023)

Figure 9-4 Section Line 417,500E Looking East

9.2 Geochemistry

Between July 2021 and November 2021, P2 collected 614 soil samples, extending the existing soil sample coverage south and across the Car Body Zone, as well as infilling selected areas. The results confirmed existing soil anomalies and defined additional prospective areas for investigation for Au (Figure 9-5) and Cu (Figure 9-6).

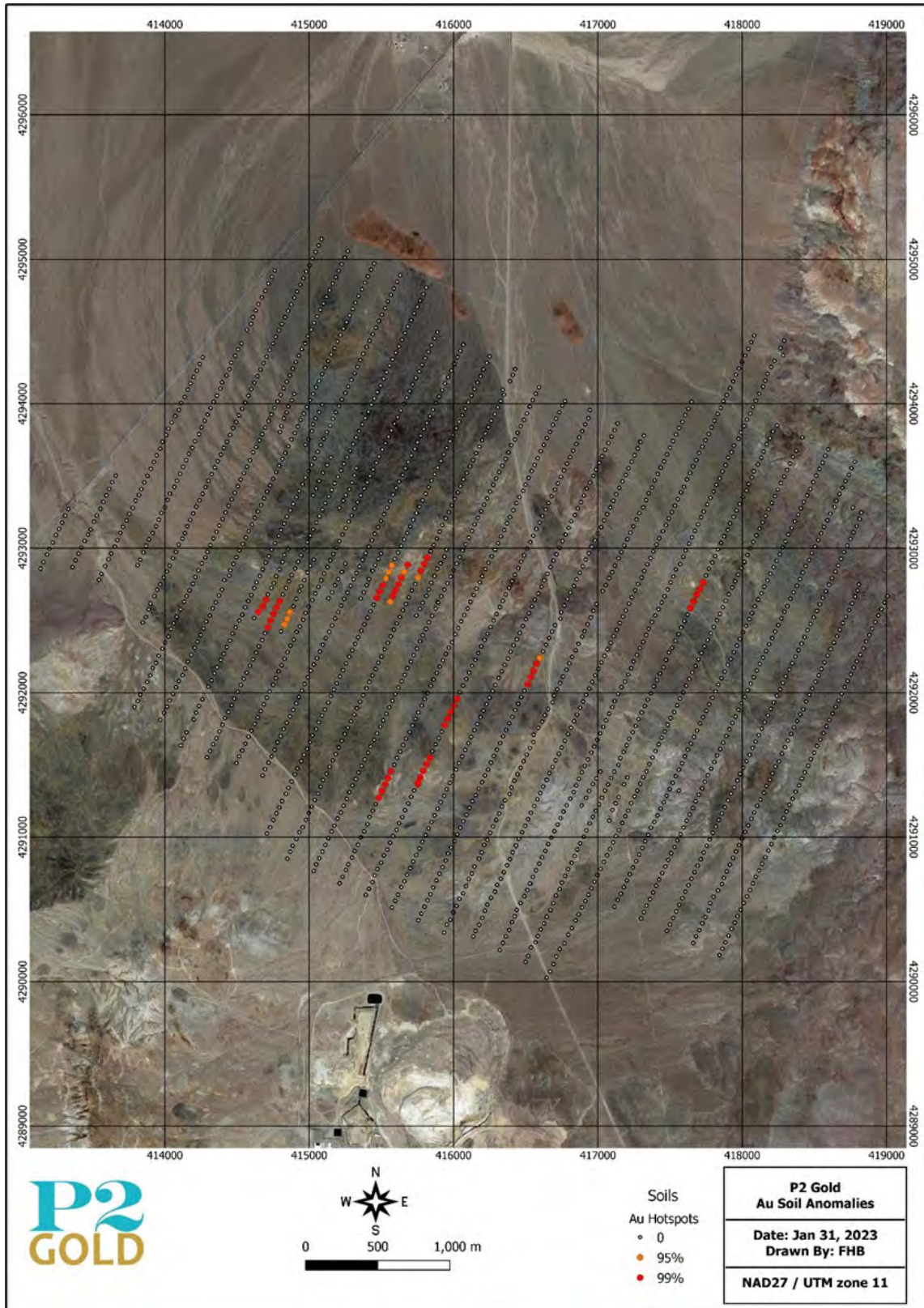

Source: P2 Gold (2023)

Figure 9-5 Gold Soil Anomalies

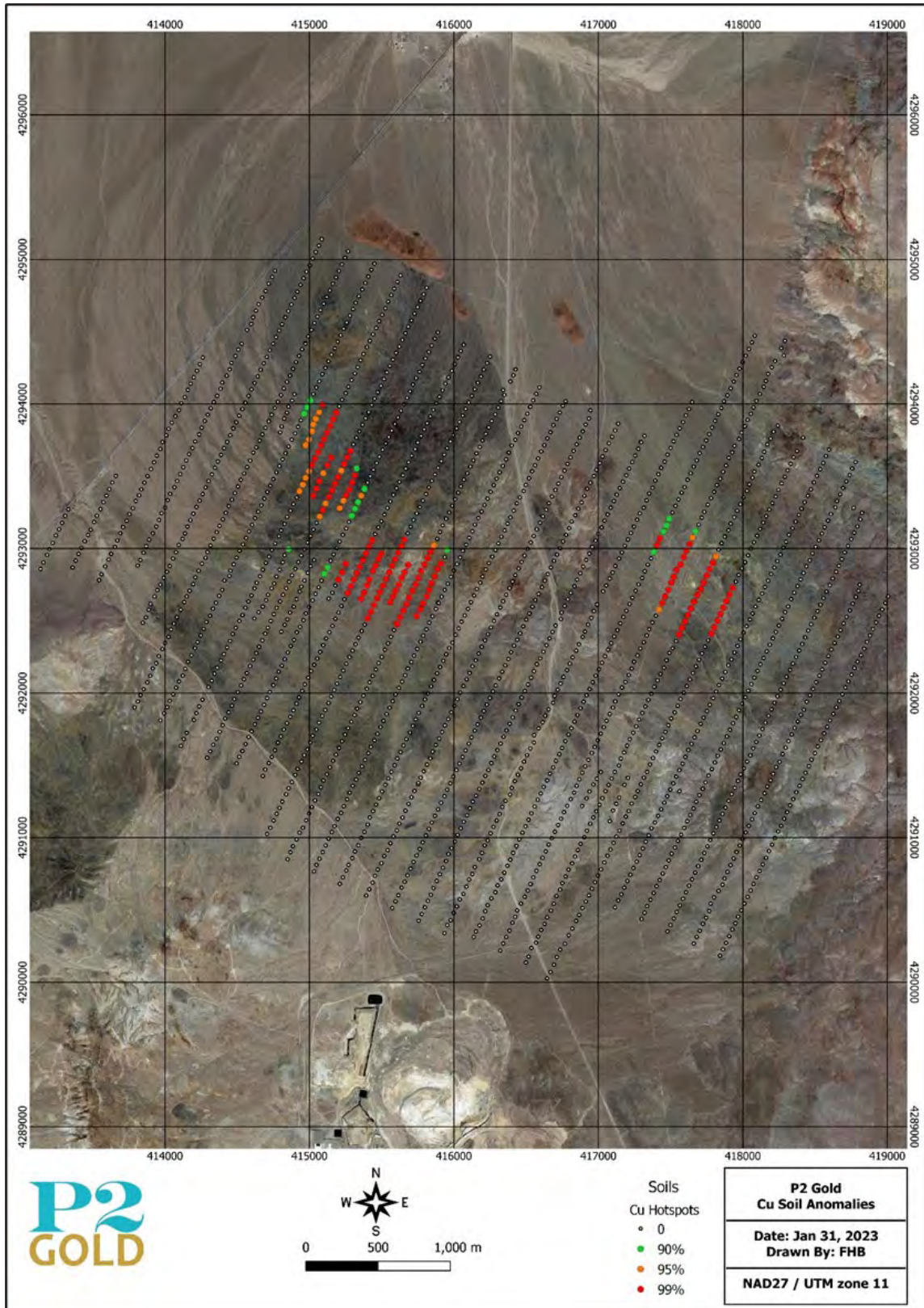

Source: P2 Gold (2023)

Figure 9-6 Copper Soil Anomalies

9.3 Structure

In 2021 and 2022 P2 also began detailed structural mapping across the Project area, identifying several prominent shear zones (Figure 9-7). During the same period an inventory of historical sampling pits and trenches, excavations and underground workings was also compiled (Figure 9-8).

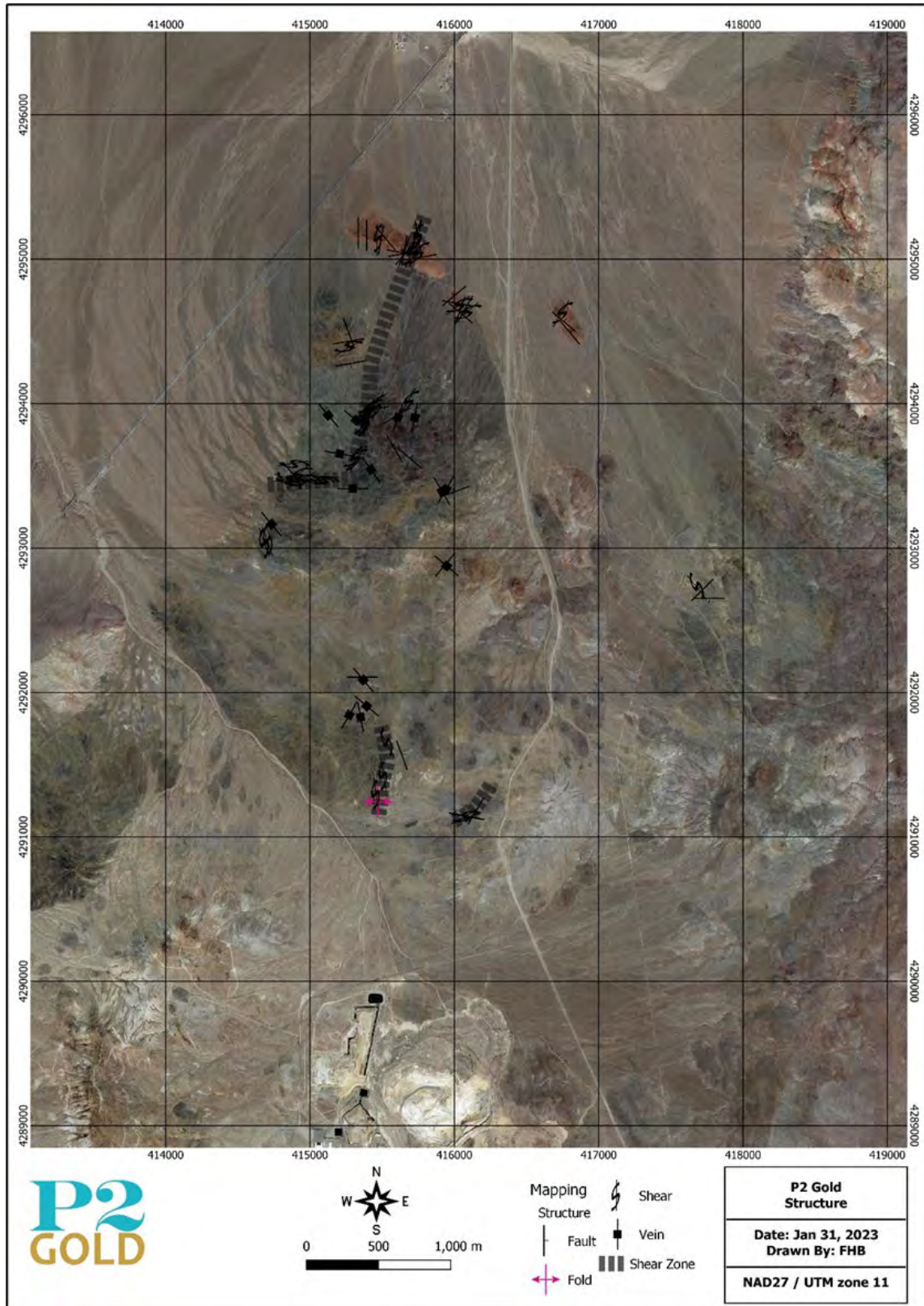

Source: P2 Gold (2023)

Figure 9-7 Structural Mapping

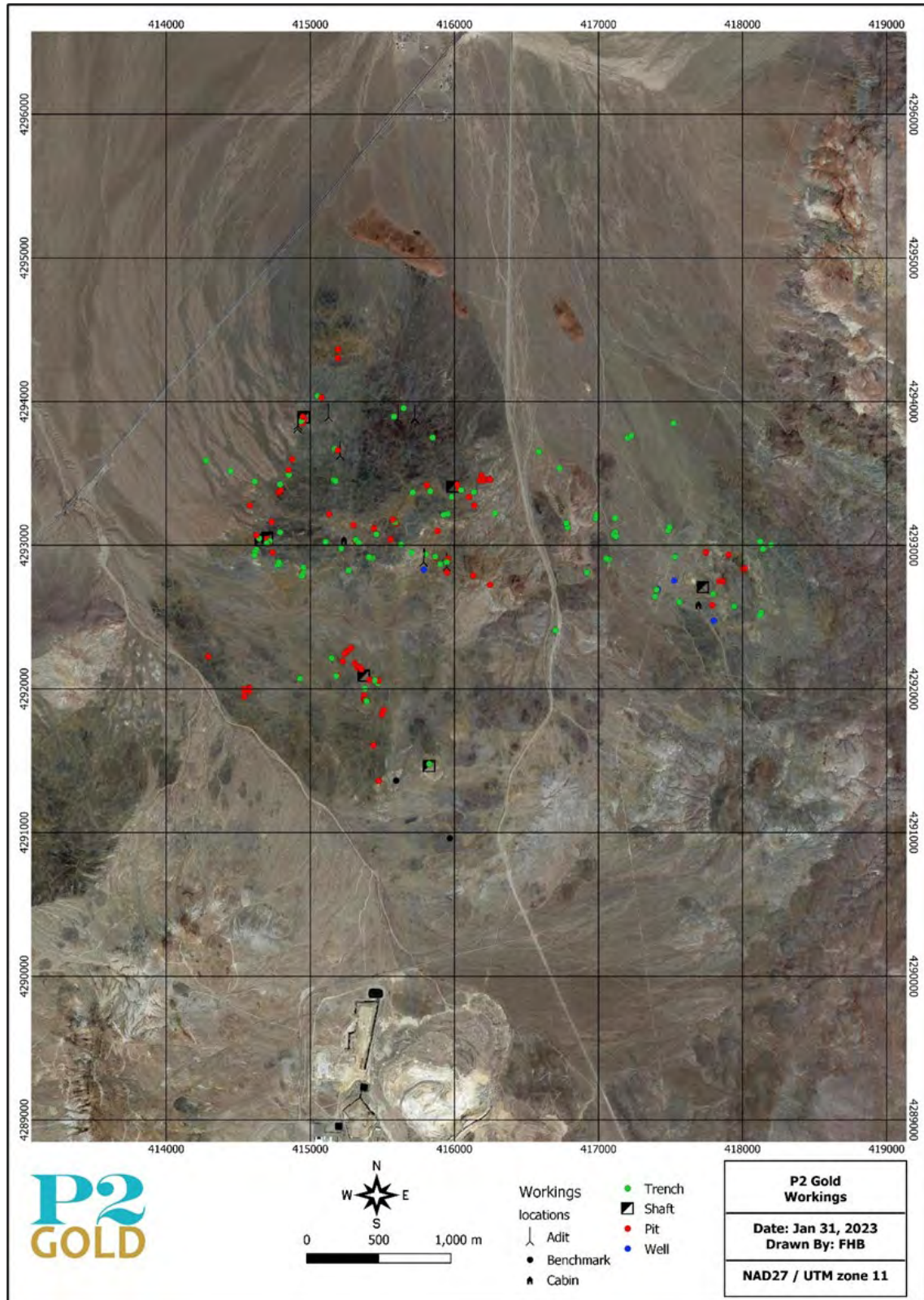

Source: P2 Gold (2023)

Figure 9-8 Historical Workings

10.0 DRILLING

Historical drilling at Gabbs generally extended to <100m below surface, penetrating only the upper half of the interpreted mineralization, because the drilling was concentrated on the oxide mineralization. Also, depending on the historical operator and their metal focus, a significant proportion of drill hole samples were assayed for either copper or gold, not both metals. At the Sullivan Zone, historical drilling identified a near-surface, higher grade gold-copper layer measuring 30m to 50m in thickness, and 200m long on section. This higher-grade layer was not “domained” for the 2021 Inferred Mineral Resource.

In 2021 and 2022, P2 Gold undertook two significant phases of drilling on the Gabbs Property. The drilling program and assay results for the Phase I and Phase II drilling programs are described below.

10.1 Phase I Drill Program - 2021

The Phase I drilling program consisted of four diamond drill holes totalling 580m (1,903 ft) and 27 reverse circulation (“RC”) holes totalling 4,120m (13,517 ft). The objective of the Phase I drill program was to test the full thickness and lateral extent of the mineralization and determine geologic constraints of the Sullivan Zone. The diamond drill holes were completed to confirm the geological model. The reverse circulation drill holes were completed for infill and expansion purposes.

10.1.1 Sullivan Zone Diamond Drilling

Drill hole GBD-001 was completed in the centre of the Sullivan Zone to test the full width of the zone and confirm the higher-grade gold–copper mineralization encountered by historical operators. Drill hole GBD-001 did intersect the near-surface higher-grade gold-copper mineralization identified in historical drilling. However, the mineralization intersected in this drill hole is approximately 70m thicker than defined in the historical drilling, almost doubling the historically calculated thickness of the mineralized zone and at higher average grades. Drill hole GBD-002 extended the gold-copper mineralization to the northwest.

Drill holes GBD-003 and GBD-004, stepped out on either side of drill hole GBD-001, intersected the near-surface, higher-grade gold-copper domain identified in historical drilling at the Sullivan Zone. Drill hole GBD-003 was completed approximately 85m (279 ft) northwest of drill hole GBD-001 and drill hole GBD-004 was completed approximately 95m (312 ft) southeast of drill hole GBD-001. Both drill holes GBD-003 and GBD-004 were designed to test the full width of the Sullivan Zone and confirm the mineralization controls on the higher-grade gold–copper domain encountered by historical operators. Drill hole GBD-004 ended in mineralization, due to

mechanical issues with the drill. The mineralization intersected in drill hole GBD-003 is approximately 40m (131 ft) thicker than defined by historical drilling and in drill hole GBD-004 is at least 60m (197 ft) thicker than defined by historical drilling. These intersections are thicker than the historical intersections and at higher average grades. Oxide mineralization was encountered down to approximately 120m (394 ft) in drill hole GBD-003 and in the entire length of drill hole GBD-004.

Diamond drill hole collar locations are presented on Table 10-1 and Figure 10-1. Select significant intersections are presented on Table 10-2 and cross-sectional projections are presented in Figure 10-4 through Figure 10-6.

**Table 10-1
2021 Diamond Drill Collar Locations, Orientations and Drill Hole Lengths**

Drill Hole ID	Coordinates		Elevation (m)	Length (m)	Azimuth (°)	Dip (°)
	Easting ¹	Northing ¹				
GBD-001	417,585	4,292,636	1,588	194	45	-45
GBD-002	417,333	4,292,927	1,563	132	45	-45
GBD-003	417,539	4,292,707	1,582	134	45	-50
GBD-004	417,662	4,292,584	1,595	119	45	-65

Source: P2 Gold (press releases dated September 8 and October 13, 2021)

Note: ¹ Coordinates UTM WGS84 ZONE 11N.

**Table 10-2
Select Significant Intersections – 2021 Diamond Drill Program**

Drill Hole ID	From (m)	To (m)	Interval (m) ¹	Gold (g/t)	Silver (g/t)	Copper (%)	AuEq (g/t) ²
GBD-001	27.43	168.10	140.67	0.81	1.92	0.30	1.15
Including	48.46	87.78	39.32	2.12	4.50	0.51	2.71
GBD-002	12.50	58.83	46.33	0.12	0.78	0.23	0.39
Including	12.50	40.54	28.04	0.14	0.48	0.29	0.47
GBD-003	24.08	98.57	74.49	0.48	1.83	0.26	0.78
Including	42.06	57.30	15.24	0.86	3.61	0.36	1.27
GBD-004	33.16	118.87	85.71	1.00	2.01	0.36	1.41
Including	51.76	92.51	40.75	1.56	2.96	0.50	2.14

Source: P2 Gold (press releases dated September 8 and October 13, 2021)

1) True thickness to be determined.

2) Gold Equivalent calculation based on the previous Sullivan Zone Mineral Resource (press release dated February 23, 2021), which used US\$1,600/oz gold, US\$3.00/lb copper, and gold and copper recoveries of 80% and 90%, respectively.

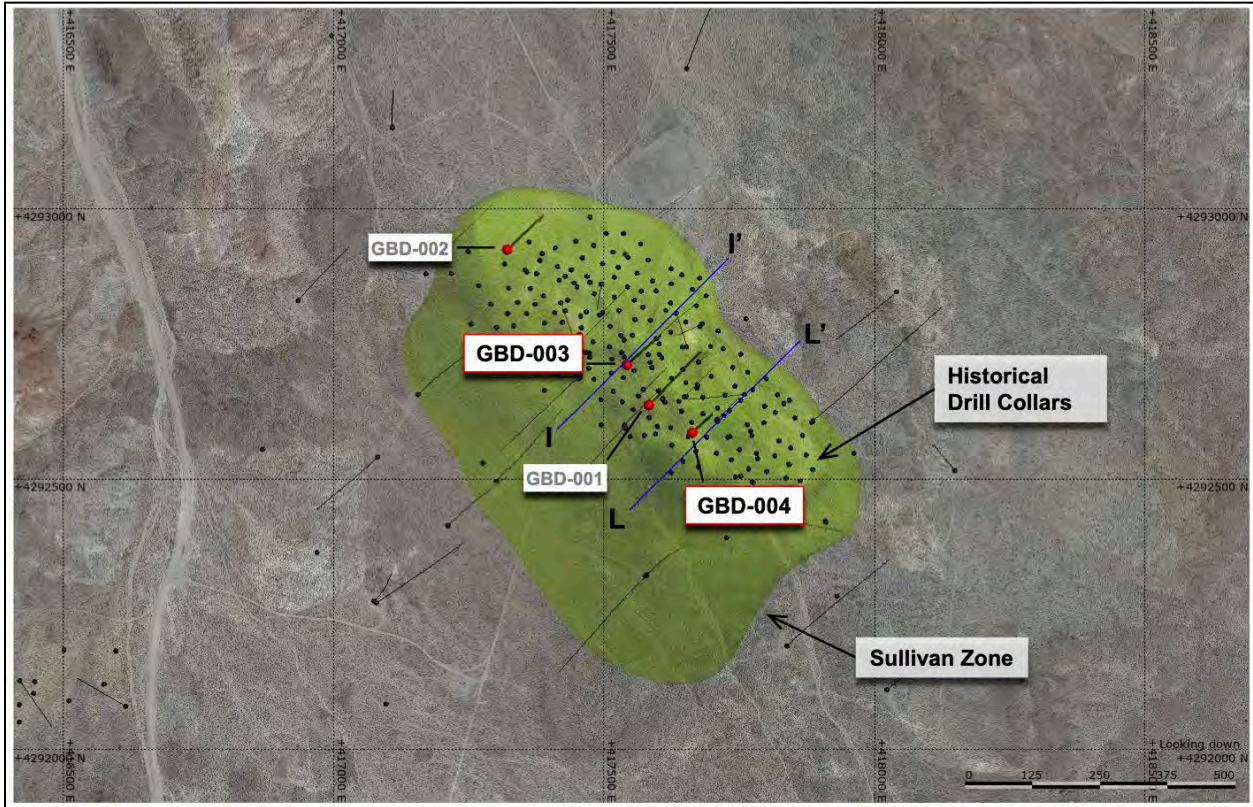

Source: www.p2gold.com (2022)

Figure 10-1 Diamond Drill Hole Locations 2021 Drill Program

10.1.2 Reverse Circulation Drilling

The RC program commenced at the northwest extent of the Sullivan Zone, with drill holes GBR-001 to GBR-007 intersecting the footwall lithology where the monzonite host of the high-grade mineralization has been eroded off. Drill holes GBR-008 to GBR-012 intersected the intensely sericite-altered monzonite with copper–gold mineralization extending well into the underlying chlorite altered pyroxenites. As also observed in the diamond drilling results, the grade and thickness of the mineralization in the RC drill holes increase to the southeast. Drill holes GBR-011 and GBR-012, drilled the farthest to southeast of these drill holes, ended in gold-copper mineralization, which indicates that the Sullivan Zone is thicker than interpreted from the historical drilling.

Drill holes GBR-013 to GBR-018 were designed to test the southeastern half of the Sullivan Zone. Drill holes GBR-014 and GBR-015, completed along the edge of the previously defined limit of the Sullivan Zone mineralization, confirmed that the Zone remains open to the southeast. Drill hole GBR-013 ended prior to planned depth, and along with drill hole GBR-016, did not intersect the monzonite or footwall mineralization. There were no significant results in drill holes GBR-013 and GBR-016.

Drill holes GBR-019 and GBR-020 expanded on the mineralization encountered in drill holes GBD-004 and GBR-010 and in drill hole GBD-003, respectively. Drill holes GBR-021 to GBR-023 extended the higher-grade mineralization to the northwest of drill hole GBD-003.

The mineralization intersected in Phase I drilling at the Sullivan Zone is thicker and higher-grade than defined in historical drilling, which consisted of mainly vertical drill holes. An analysis of the assays from the Phase One drill program and historical drilling suggests that the gold mineralization may be controlled in part by a subvertical sheeted structure. The Phase I angle drill holes are interpreted to have cut a more representative amount of the sheeted structure, which resulted in them generally having higher average gold values than the historical, vertical drill holes. Overall, drilling continued to intersect an intensely altered package of volcanic rocks that includes a monzonite sill, which hosts the higher-grade gold mineralization, along with copper–gold mineralization extending well into the underlying altered pyroxenites.

Drill holes GBR-024 to GBR-026 were designed to test the mineralization at the Car Body Zone, which is the smallest tonnage, highest-grading gold zone on the Gabbs Property. The gold mineralization at Car Body is interpreted to be low-sulphidation epithermal mineralization and is open in all directions. Drill hole GBR-027 confirmed the continuity of the gold-copper mineralization to the northeast at the Lucky Strike Zone, and that the zone remains open to the east. The gold-copper mineralization at Lucky Strike, as with the Sullivan and Gold Ledge Zones, is hosted in volcanic rocks and is interpreted to be related to an alkaline gold/copper porphyry system.

Drill hole collar locations for the Sullivan Zone RC drill holes are presented in Table 10-3 and represented in Figure 10-2. Cross-sections through the Sullivan Zone, looking northwest, are presented in Figure 10-3 through Figure 10-8. The single drill hole on the Lucky Strike Zone is presented in Figure 10-9 and a cross-sectional projection is presented in Figure 10-10. The drill holes on the Car Body Zone are presented in Figure 10-11 and cross sections are presented in Figure 10-12 and Figure 10-13. Select significant intersections are presented on Table 10-4.

Table 10-3
2021 Reverse Circulation Drill Hole Collar Locations and Hole Lengths

Drill Hole ID	Coordinates		Elevation (m)	Length (m)
	Easting ¹	Northing ¹		
GBR-001	417,256	4,292,986	1,556	91
GBR-002	417,258	4,292,988	1,556	91
GBR-003	417,382	4,292,980	1,561	99
GBR-004	417,385	4,292,982	1,561	79
GBR-005	417,379	4,292,977	1,561	110
GBR-006	417,331	4,292,923	1,563	120
GBR-007	417,328	4,292,921	1,563	101
GBR-008	417,583	4,292,634	1,588	264
GBR-009	417,585	4,292,640	1,588	136

Source: P2 Gold (press releases dated November 9, 2021; December 1, 2021; January 13, 2022.
Note: ¹ Coordinates UTM WGS84 ZONE 11N.

Table 10-4
Select Significant Intersections: 2021 Reverse Circulation Drill Program

Drill Hole ID	From (m)	To (m)	Interval (m) ¹	Gold (g/t)	Silver (g/t)	Copper (%)	AuEq (g/t) ²	CuEq (%) ²
Sullivan Zone								
GBR-001	6.10	22.86	16.76	0.07	0.58	0.11	0.20	0.17
GBR-002	9.14	33.53	24.39	0.09	0.63	0.14	0.25	0.21
GBR-003	6.10	47.24	41.14	0.15	0.55	0.20	0.38	0.32
GBR-004	4.57	39.62	35.05	0.21	0.65	0.21	0.45	0.37
GBR-005	9.14	50.29	41.15	0.23	1.04	0.25	0.52	0.43
GBR-006	9.14	56.39	47.25	0.16	0.72	0.24	0.44	0.37
GBR-007	13.72	89.92	76.20	0.28	1.36	0.29	0.61	0.51
Including	59.44	85.34	25.90	0.54	2.81	0.38	0.99	0.81
GBR-008	32.00	195.07	163.07	0.56	1.11	0.23	0.82	0.66
Including	105.16	131.06	25.90	1.20	1.58	0.26	1.50	1.19
GBR-009	32.00	128.02	96.02	0.70	1.83	0.36	1.12	0.90
Including	51.82	79.25	27.43	1.72	4.25	0.46	2.25	1.79
GBR-010	45.72	149.35	103.63	1.19	1.79	0.37	1.62	1.29
Including	94.49	143.26	48.77	1.76	2.39	0.46	2.30	1.83
GBR-011	47.24	190.50	143.26	0.65	1.13	0.27	0.97	0.78
Including	118.87	147.83	28.96	1.07	1.42	0.33	1.44	1.16
and	184.40	190.50	6.10	0.40	1.20	0.79	1.31	1.10
GBR-012	35.05	137.16	102.11	1.00	2.12	0.44	1.51	1.22
Including	76.20	114.30	38.10	1.74	4.27	0.77	2.63	2.12
and	131.06	137.16	6.10	0.62	1.59	0.56	1.27	1.04

Drill Hole ID	From (m)	To (m)	Interval (m) ¹	Gold (g/t)	Silver (g/t)	Copper (%)	AuEq (g/t) ²	CuEq (%) ²
GBR-014	103.63	185.93	82.30	0.77	1.53	0.35	1.18	0.95
Including	141.73	163.07	21.34	1.71	3.09	0.51	2.31	1.85
GBR-015	117.35	172.21	54.86	0.74	1.95	0.35	1.14	0.92
Including	128.02	146.30	18.28	1.30	3.14	0.50	1.88	1.51
GBR-017	32.00	131.06	99.06	0.45	1.19	0.26	0.75	0.61
Including	53.34	70.10	16.76	1.35	3.00	0.53	1.96	1.58
GBR-018	67.06	118.87	51.81	0.57	1.38	0.34	0.96	0.79
Including	68.58	91.44	22.86	1.03	1.85	0.39	1.48	1.19
GBR-019	42.67	135.64	92.97	0.66	1.24	0.27	0.98	0.79
Including	70.10	102.11	32.01	1.34	2.15	0.35	1.74	1.39
GBR-020	35.05	120.40	85.35	0.40	1.27	0.32	0.78	0.64
Including	44.20	56.39	12.19	1.02	2.82	0.41	1.49	1.20
GBR-021	6.10	92.96	86.86	0.63	2.03	0.32	1.01	0.82
Including	19.81	45.72	25.91	1.06	1.98	0.44	1.57	1.26
GBR-022	13.72	167.64	153.92	0.60	2.00	0.36	1.01	0.82
Including	50.29	92.96	42.67	1.02	3.63	0.44	1.53	1.24
GBR-023	35.05	117.35	82.30	0.61	2.64	0.31	0.96	0.78
Including	38.10	67.06	28.96	1.31	5.84	0.34	1.70	1.36
Car Body Zone								
GBR-024	53.34	82.30	28.96	1.13	0.69	-	-	-
Including	53.34	65.53	12.19	2.35	1.27	-	-	-
GBR-025	0.00	19.81	19.81	0.78	0.33	-	-	-
Including	10.67	18.29	7.62	1.46	0.32	-	-	-
GBR-026	16.76	62.48	45.72	1.09	0.53	-	-	-
Including	22.86	38.10	15.24	1.57	0.82	-	-	-
and	50.29	62.48	12.19	1.39	0.57	-	-	-
Lucky Strike Zone								
GBR-027	140.21	199.64	59.43	0.41	1.35	0.34	0.81	0.66
Including	140.21	169.16	28.95	0.56	1.42	0.43	1.06	0.87

Source: P2 Gold (press releases dated November 9, 2021; December 1, 2021; January 13, 2022).

Notes: 1) True thickness to be determined.

2) Gold Equivalent and Copper Equivalent calculations based on the previous Sullivan Zone Mineral Resource (press release dated February 23, 2021), which used US\$1,600/oz gold, US\$3.00/lb copper, and gold and copper recoveries of 80% and 90%, respectively.

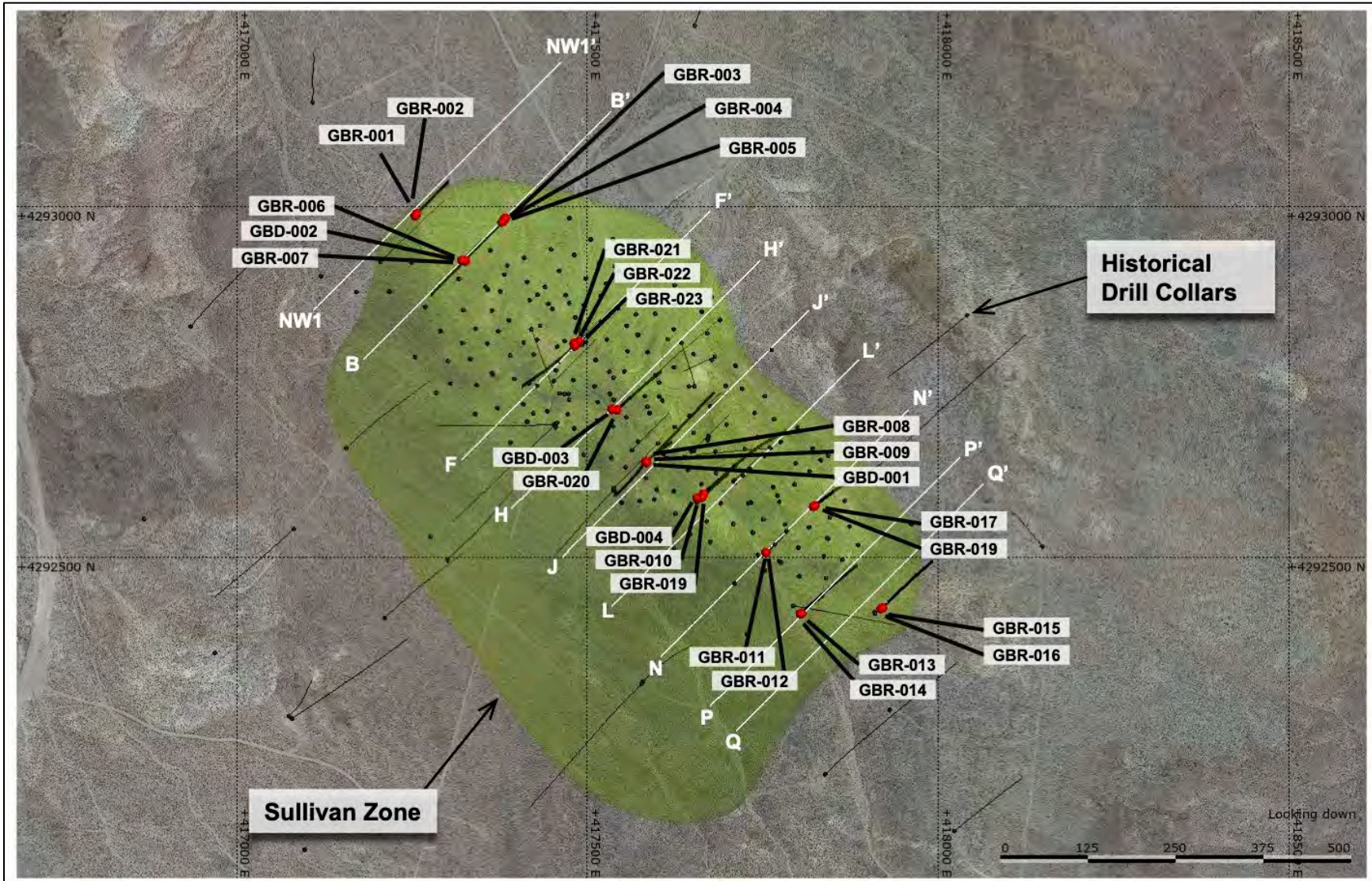

Source: www.p2gold.com (2022)

Figure 10-2 Reverse Circulation Drill Hole Locations 2021 Drill Program – Sullivan Zone

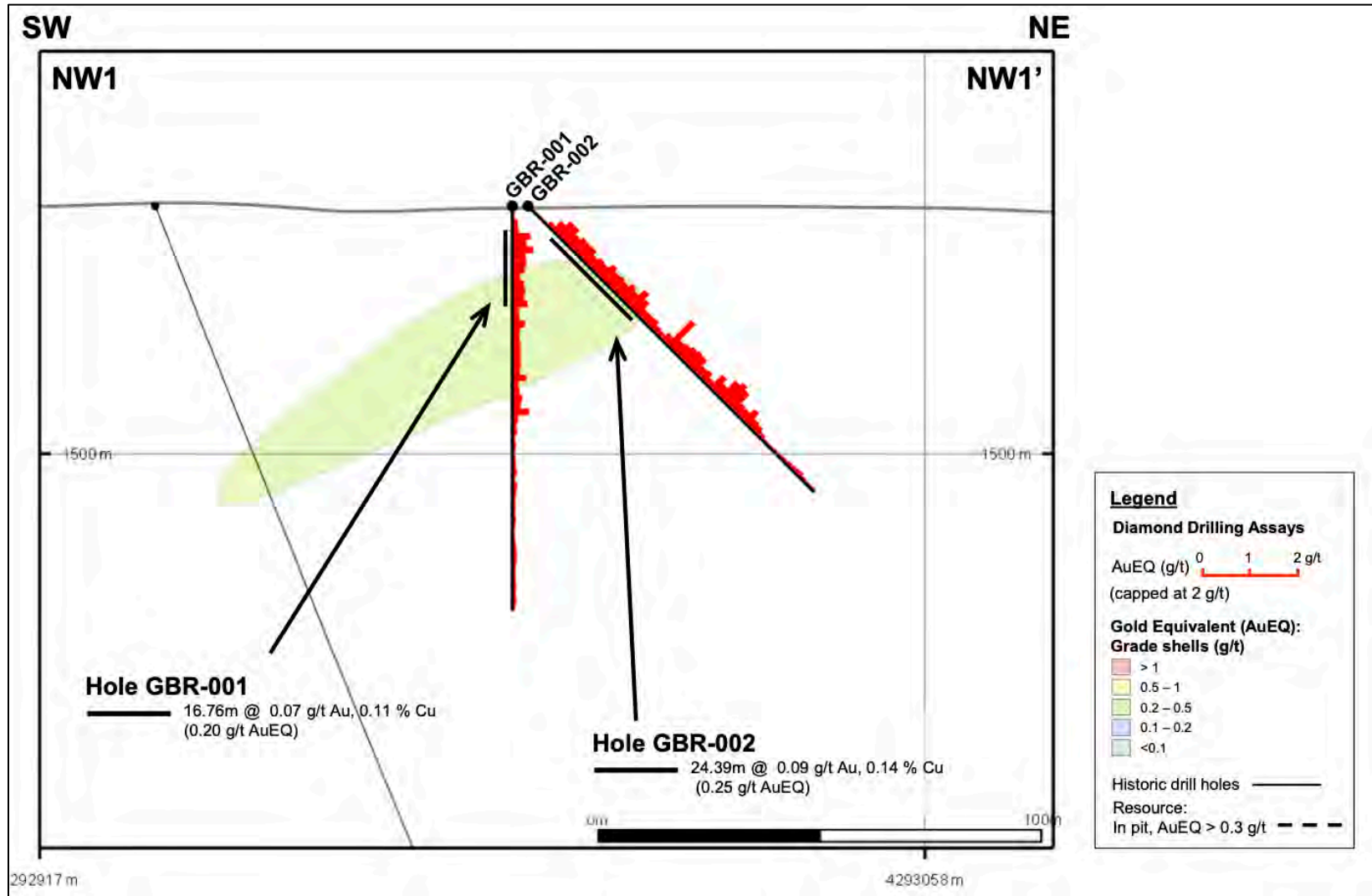

Source: www.p2gold.com (2022)

Figure 10-3 Sullivan Zone – Cross-Sectional Projection NW1-NW1'

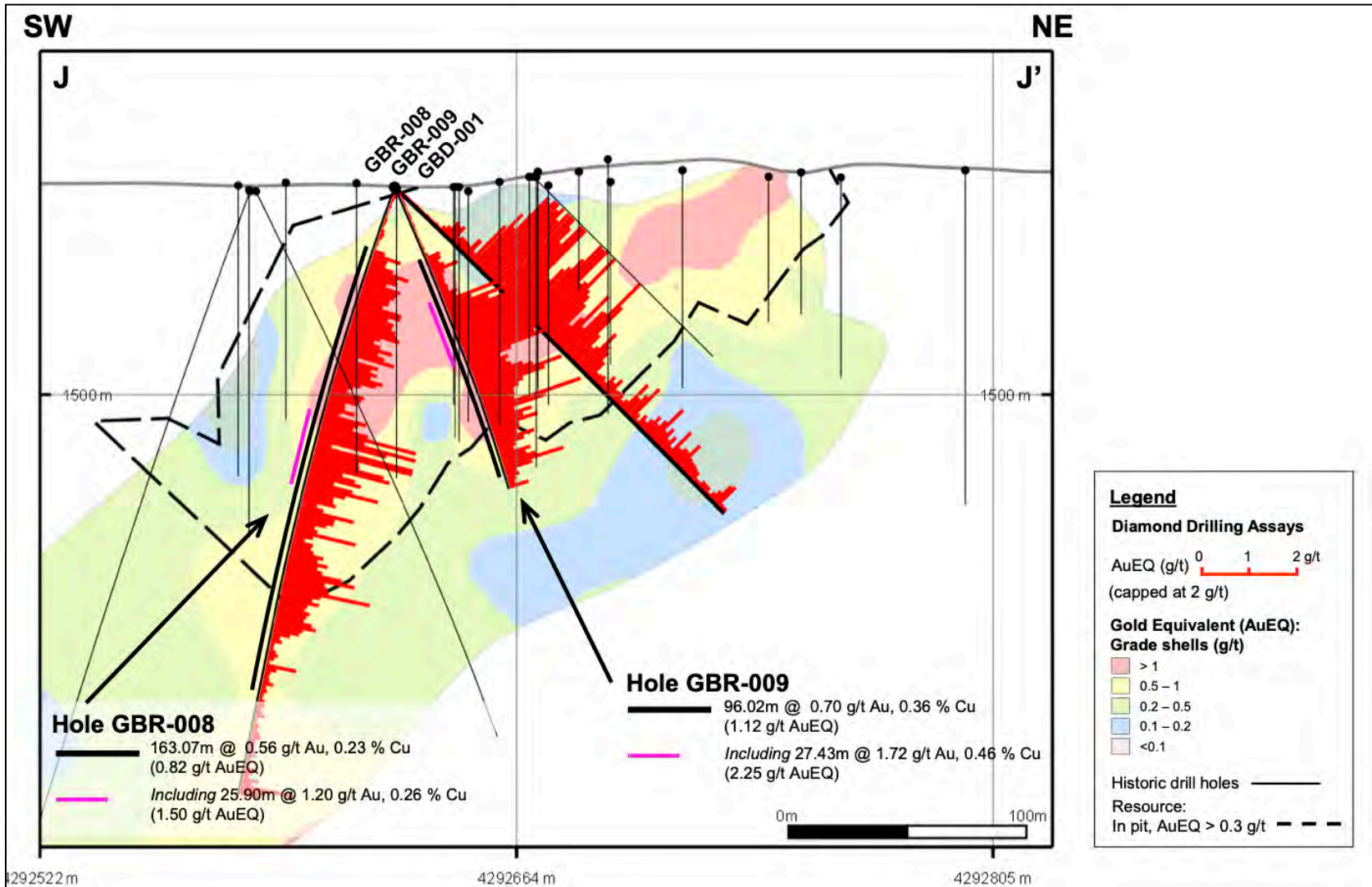

Source: www.p2gold.com (2022)

Figure 10-5 Sullivan Zone – Cross-Sectional Projection J-J'

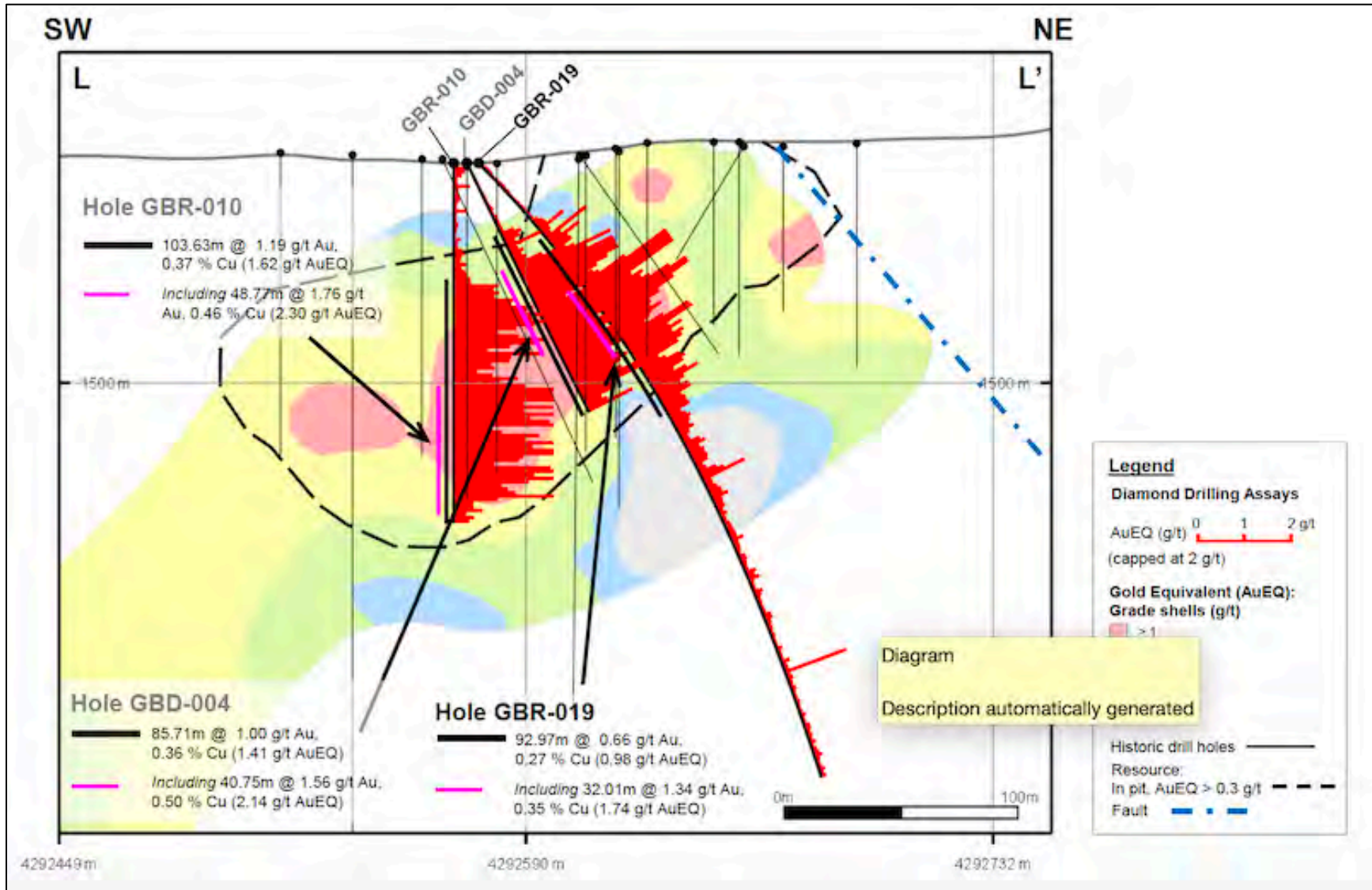

Source: www.p2gold.com (2022)

Figure 10-6 Sullivan Zone – Cross-Section Projection L-L'

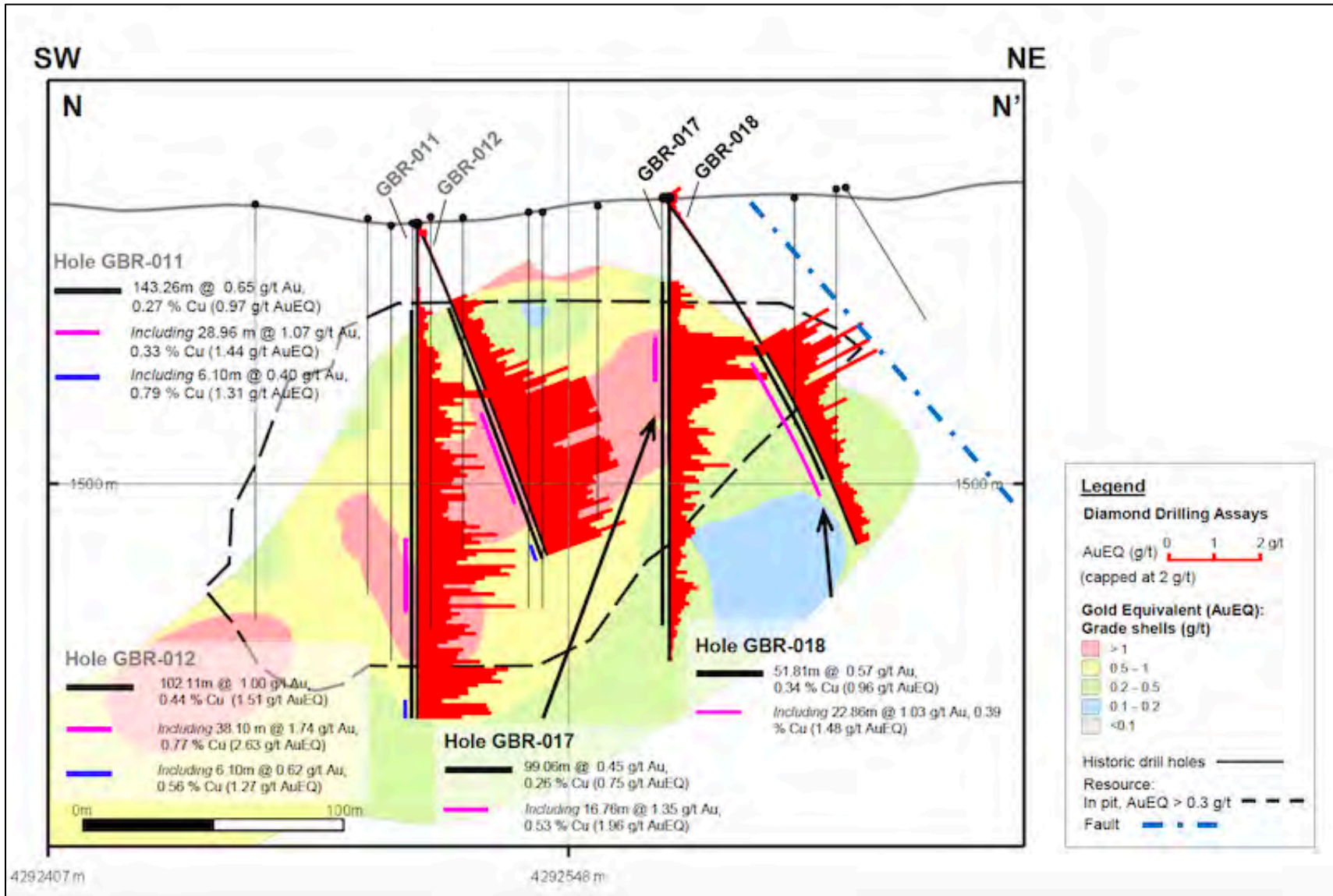

Source: www.p2gold.com (2022)

Figure 10-7 Sullivan Zone – Cross-Section N-N'

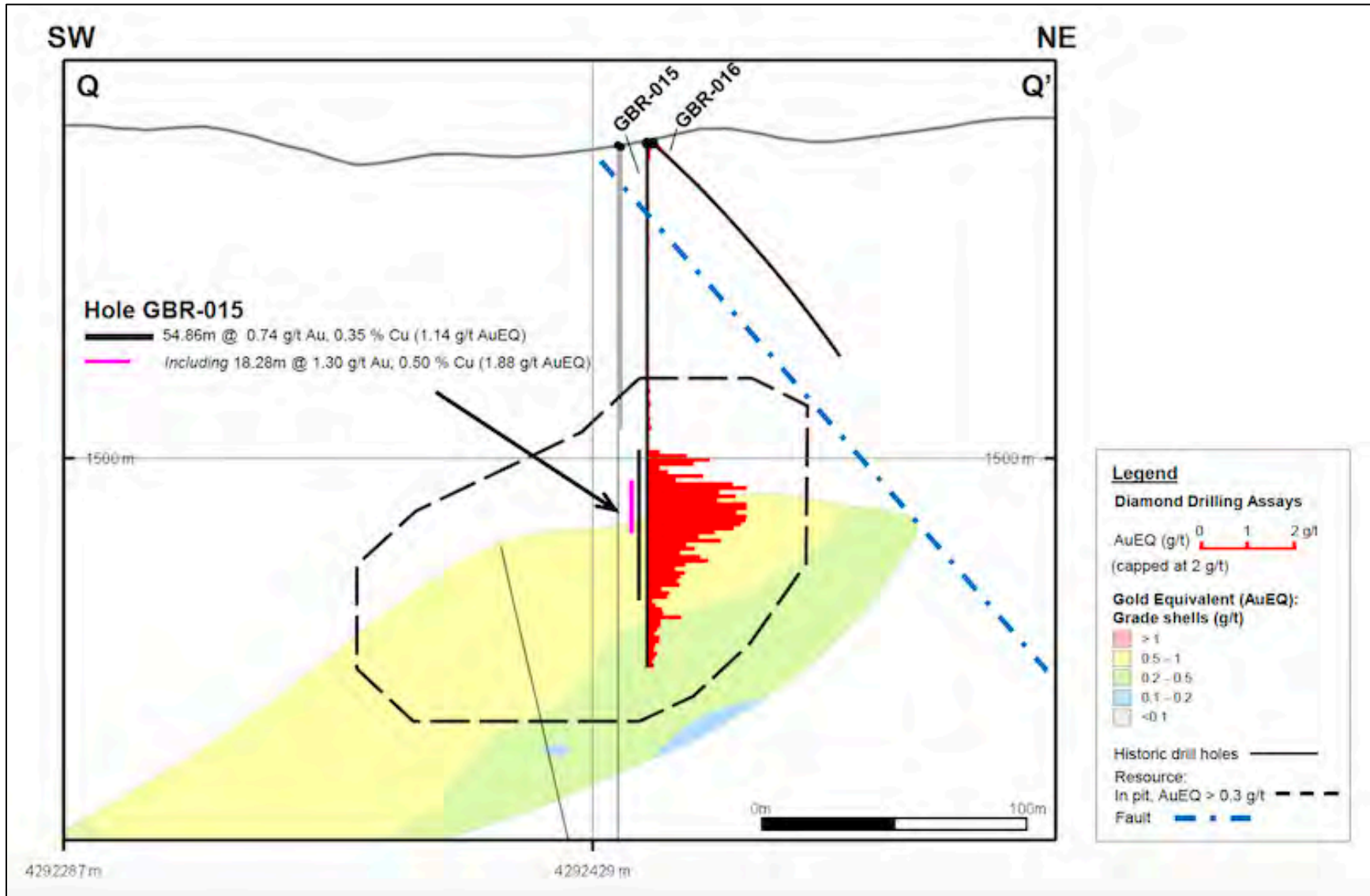

Source: www.p2gold.com (2022)

Figure 10-8 Sullivan Zone – Cross-Section Projection Q-Q'

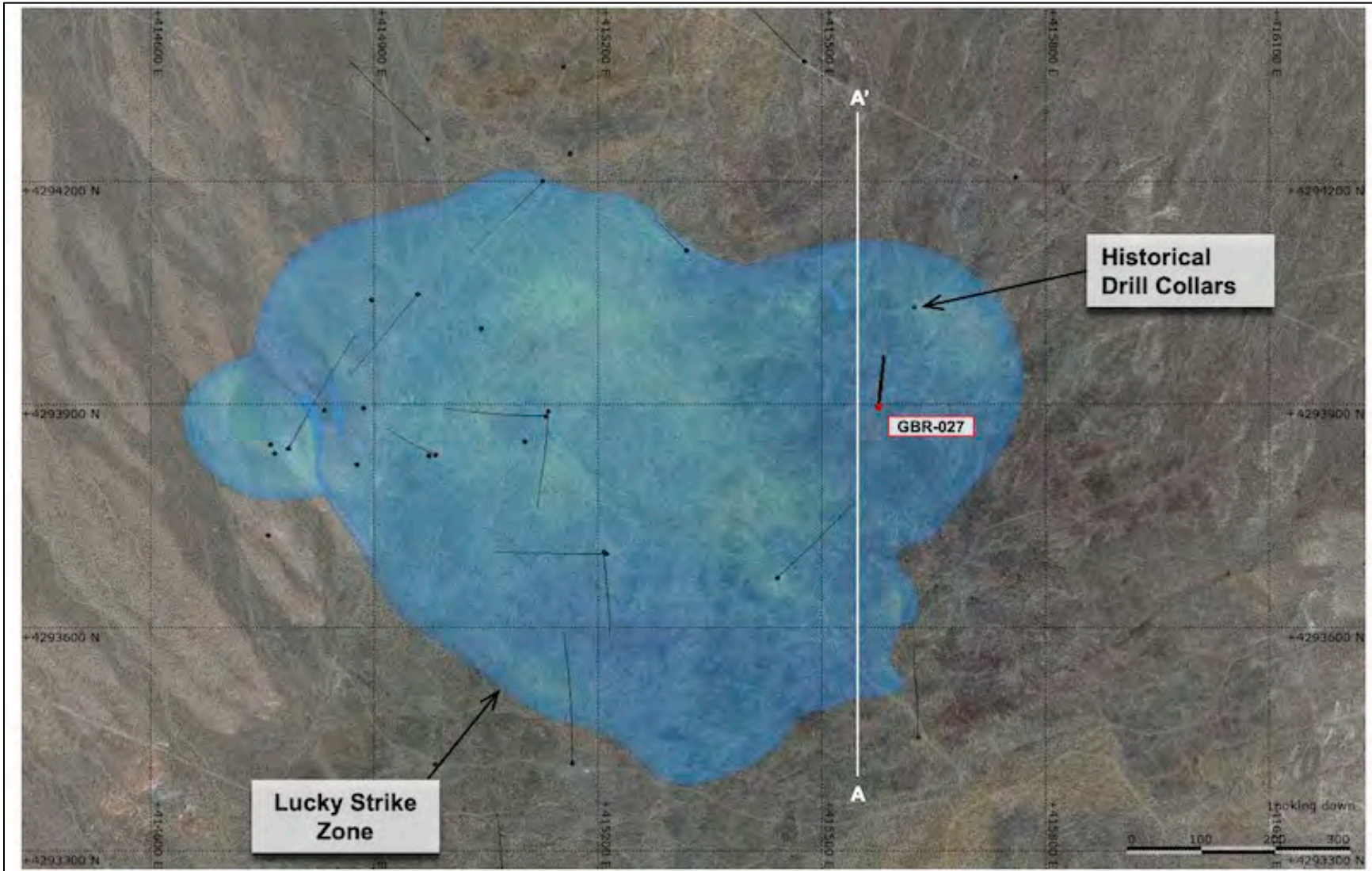

Source: www.p2gold.com (2022)

Figure 10-9 Reverse Circulation Drill Hole Location 2021 Drill Program – Lucky Strike Zone

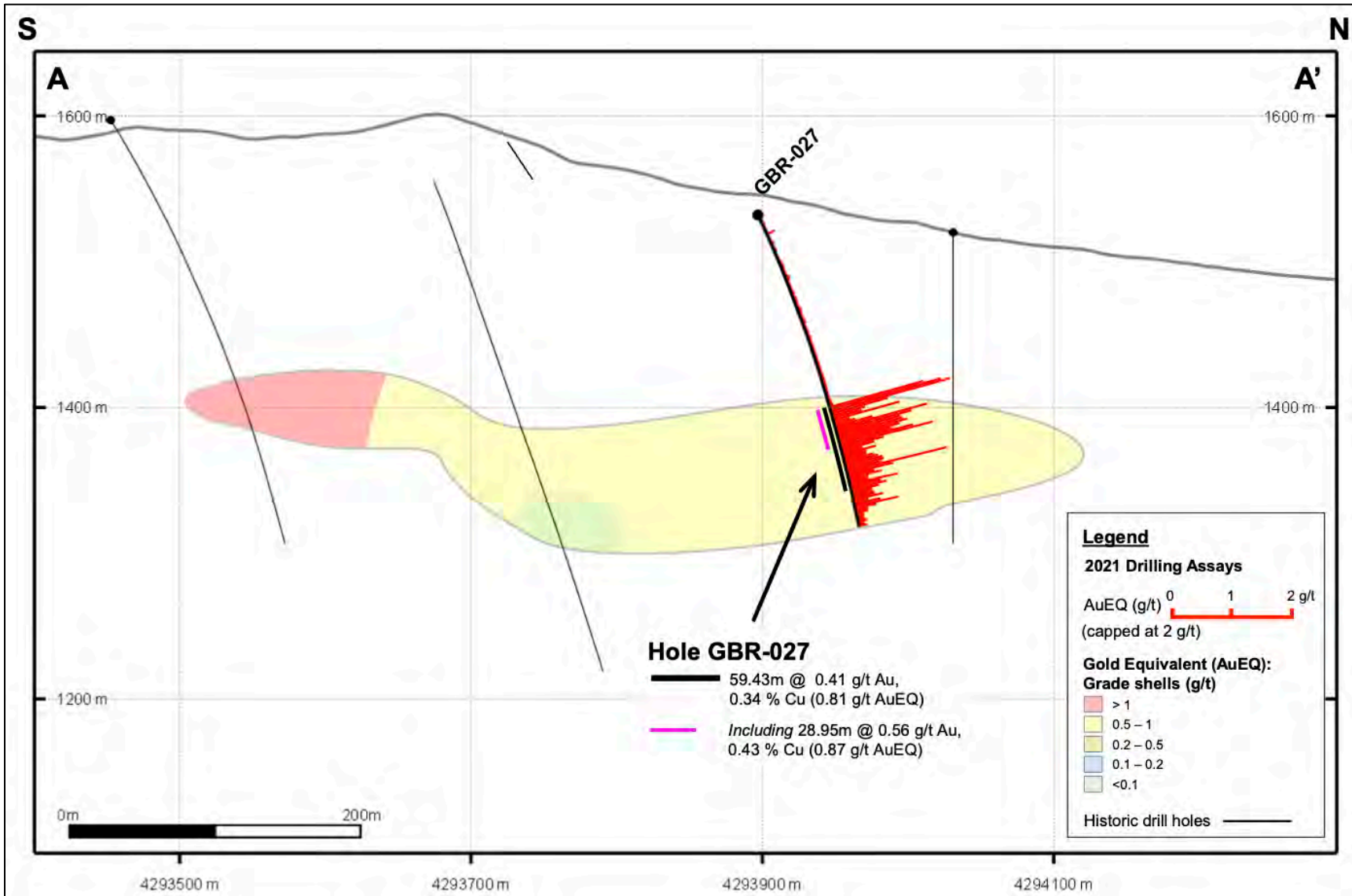

Source: www.p2gold.com (2022)

Figure 10-10 Lucky Strike Zone – Sectional Projection A-A' Looking West

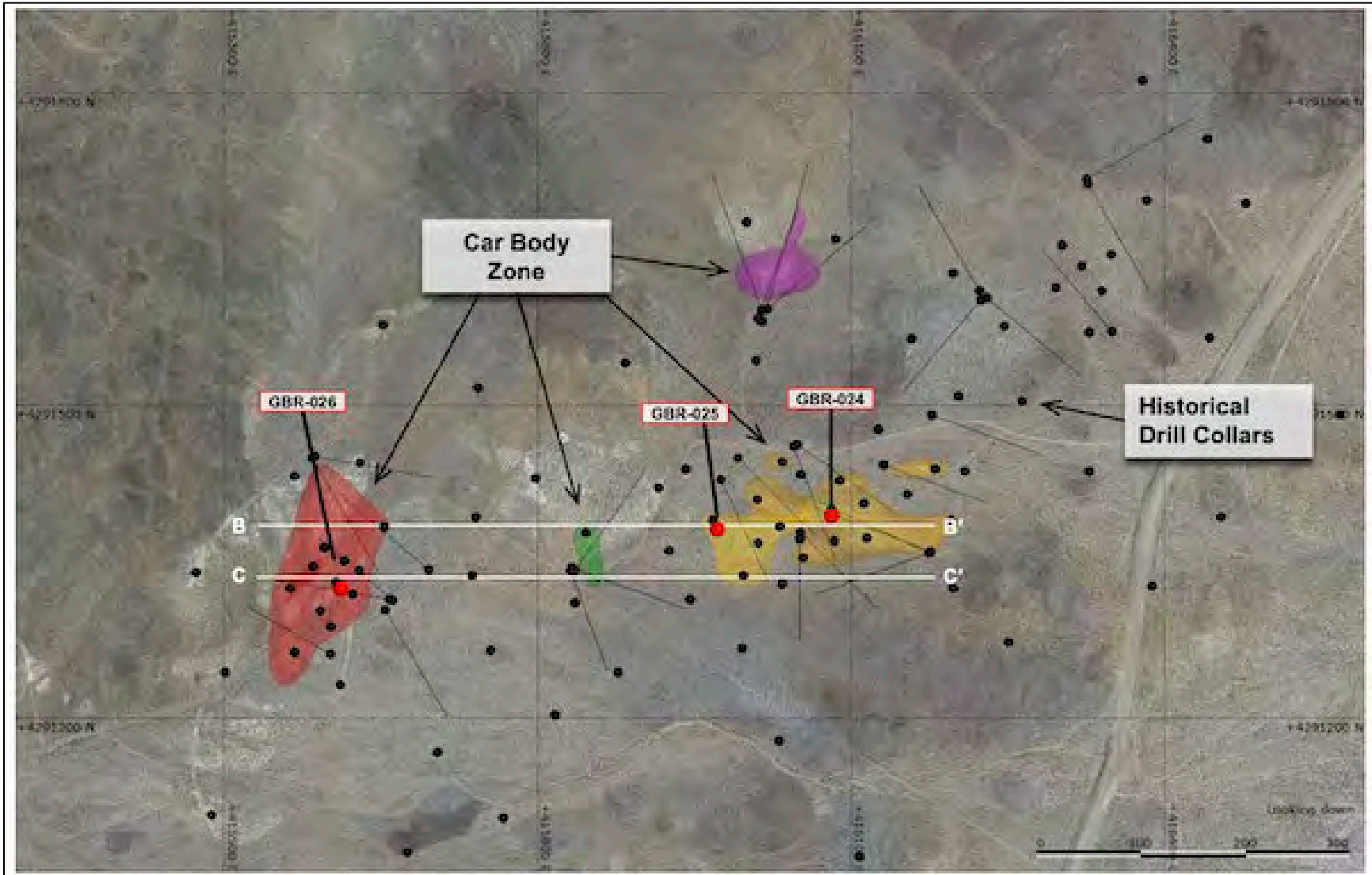

Source: www.p2gold.com (2022)

Figure 10-11 Reverse Circulation Drill Hole Locations 2021 Drill Hole Program – Car Body Zone

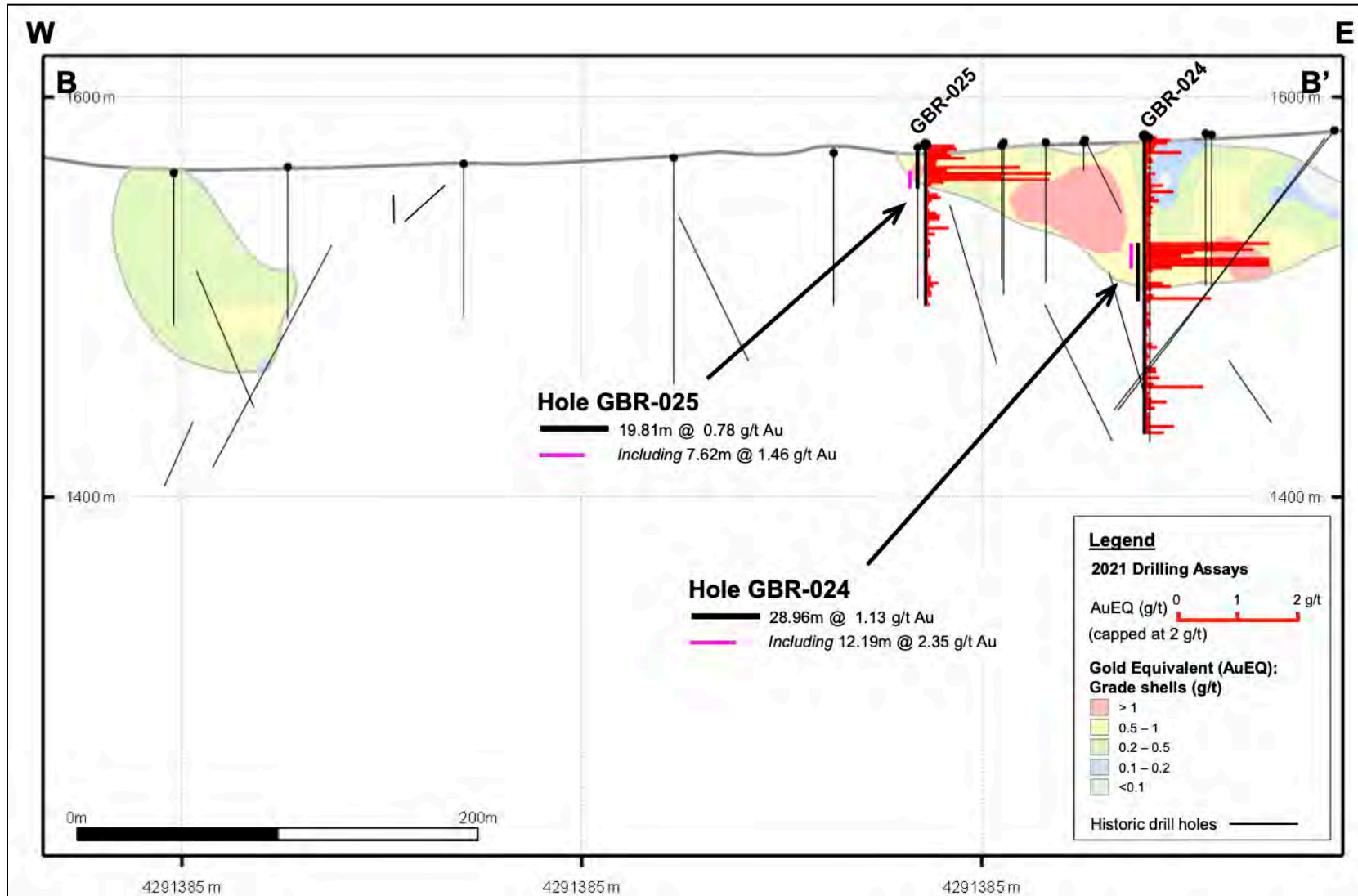

Source: www.p2gold.com (2022)

Figure 10-12 Car Body Zone – Sectional Projection B-B' Looking North

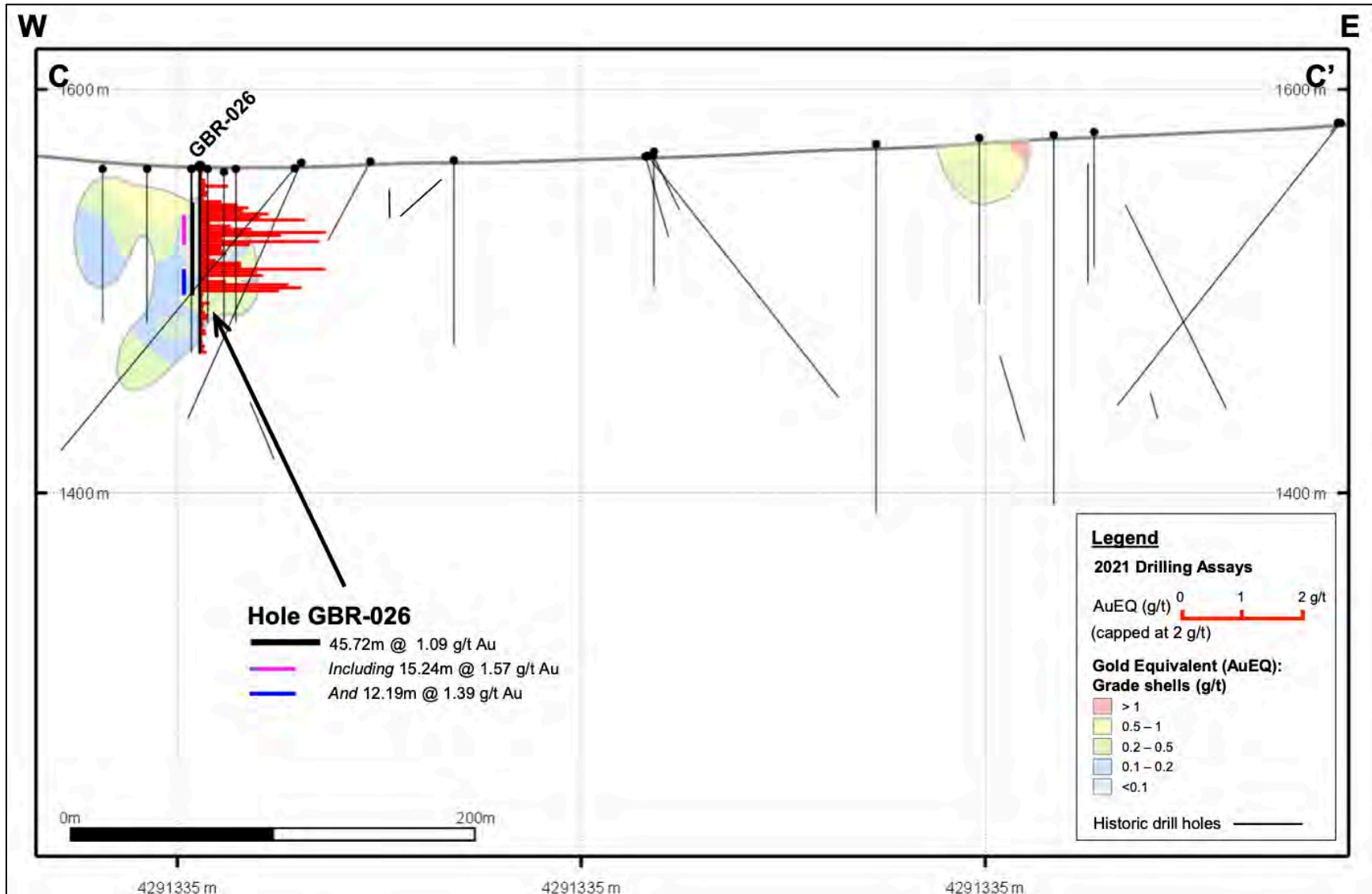

Source: www.p2gold.com (2022)

Figure 10-13 Car Body Zone – Sectional Projection C-C' Looking North

10.2 Phase II Drill Program - 2022

The Phase II drill program consisted of 20 RC holes totalling approximately 4,000m of drilling and was completed during the first quarter of 2022. The Phase II drill program focused on extension of the Sullivan and Car Body Zones and infill and extensions to the Lucky Strike Zone. Collar locations for the Phase II drill holes are presented on Table 10-5 and select significant intersections are presented on Table 10-6.

At the Sullivan Zone, drill holes GBR-028 through GBR-031 were designed to test the down-dip extension along the southern flank. All four holes intersected gold-copper mineralization extending the Sullivan Zone to the south. A plan view of the 2022 drill holes on the Sullivan Zone is presented on Figure 10-14 and cross-sections are presented on Figure 10-15 through Figure 10-17.

Drill holes GBR-032 to 035 were designed to test for structural controls on the mineralization at the Car Body Zone. The gold at Car Body is interpreted to be low-sulphidation epithermal mineralization and is open in all directions. Drill holes GBR-032 to GBR-035 have confirmed the results from the historical drilling at Car Body and have locally expanded the mineral intersections. The mineralization controls appear to be related to a set of steeply-dipping, east-west quartz stock work typical of the Walker Lane Trend. Two north-south oriented holes were completed at the end of the program to test for this stockwork. No significant values were encountered in drill hole GBR-032. Drill holes GBR-048 and 049 were drilled to test the host geology of the zone. A plan view of the 2022 drill holes on the Car Body Zone is presented on Figure 10-18 and cross-sections are presented on Figure 10-19 and Figure 10-20.

Drill holes GBR-036 through 047 were designed to infill and test extensions of the Lucky Strike Zone. Drill holes GBR-037 and 042 failed to reach the mineralization envelope due to ground conditions. Drill holes GBR-044 and 045 ended in mineralization for the same reason. These holes will be redrilled in the future with a diamond core drill or heavier RC drill. Near surface mineralization in the Lucky Strike Zone was thicker and oxidized deeper than projected from the historical drilling. In addition, mineralization at Lucky Strike is hosted in both structural and lithological zones. Future drilling will target both styles of mineralization. Drill holes GBR-039 and GBR-047 did not return any significant values. A plan view of the 2022 drill holes on the Lucky Strike Zone is presented in Figure 10-21 and cross-sections are presented in Figure 10-22 through Figure 10-24.

The Author is not aware of any drilling, sampling, or recovery factor that could materially impact the accuracy and reliability of the results.

Table 10-5
2022 Reverse Circulation Collar Locations

Hole-ID	Coordinates		Elevation (m)	Length (m)	Azimuth (°)	Dip (°)
	Easting ¹	Northing ¹				
GBR-028	417,392	4,292,709	1,574	215	0	-90
GBR-029	417,269	4,292,871	1,561	184	0	-90
GBR-030	417,805	4,292,415	1,608	245	45	-75
GBR-031	417,396	4,292,711	1,575	184	45	-50
GBR-032	415,613	4,291,330	1,562	101	90	-50
GBR-033	415,610	4,291,329	1,561	101	250	-45
GBR-034	415,980	4,291,386	1,577	76	90	-45
GBR-035	416,085	4,291,400	1,580	125	270	-45
GBR-036	415,647	4,294,055	1,519	232	360	-90
GBR-037	415,596	4,293,928	1,539	184	180	-65
GBR-038	415,334	4,293,793	1,551	247	360	-90
GBR-039	415,292	4,293,874	1,537	251	360	-90
GBR-040	415,258	4,293,796	1,539	219	360	-90
GBR-041	415,025	4,293,976	1,511	162	170	-70
GBR-042	415,219	4,293,703	1,551	163	360	-65
GBR-043	414,788	4,293,844	1,505	125	360	-70
GBR-044	415,349	4,293,660	1,565	229	180	-65
GBR-045	415,451	4,293,669	1,579	268	180	-65
GBR-046	414,910	4,293,854	1,510	126	180	-65
GBR-047	415,702	4,293,957	1,529	285	115	-50
GBR-048	415,615	4,291,326	1,562	154	180	-60
GBR-049	415,975	4,291,383	1,577	117	180	-60

Source: P2 Gold (press releases dated March 29, April 19, and August 4, 2022)

Note: ¹ Coordinates UTM WGS84 ZONE 11N.

Table 10-6
Select Significant Intersections – 2022 Reverse Circulation Drill Program

Drill Hole ID	From(m)	To (m)	Interval (m)*	Gold (g/t)	Silver (g/t)	Copper(%)	AuEq (g/t)	CuEq (%)
Sullivan Zone								
GBR-028	85.34	147.83	62.49	0.19	0.57	0.16	0.35	0.27
Including	85.34	117.35	32.01	0.26	0.58	0.12	0.38	0.27
GBR-029	7.62	64.01	56.39	0.13	0.77	0.22	0.36	0.30
Including	15.24	32.00	16.76	0.17	0.65	0.26	0.44	0.36
GBR-030	118.87	231.65	112.78	0.67	1.03	0.27	0.94	0.66
Including	173.74	193.55	19.81	1.29	1.71	0.40	1.70	1.15
GBR-031	57.91	140.21	82.30	0.52	2.26	0.32	0.85	0.63
Including	73.15	91.44	18.29	0.85	4.48	0.39	1.25	0.89
Car Body Zone								
GBR-033	12.19	35.05	22.86	2.96	0.62	-	-	-
Including	19.81	32.00	12.19	5.00	0.78	-	-	-
GBR-034	19.81	30.48	10.67	0.43	0.58	-	-	-
Including	39.62	44.20	4.58	0.33	0.99	-	-	-
GBR-035	0.00	39.62	39.62	1.13	0.34	-	-	-
Including	19.81	33.53	13.72	2.73	0.61			
	96.01	124.97	28.96	0.51	0.96			
GBR-048	91.44	102.11	10.67	0.78	0.90			
	111.25	115.82	4.57	0.39	1.05			
GBR-049	0	39.62	39.62	0.45	2.31			
	25.91	35.05	9.14	0.94	0.55			
	59.44	62.48	3.04	0.79	0.39			
Lucky Strike Zone								
GBR-038	118.87	134.11	15.24	0.21	0.90	0.2	0.42	0.33
GBR-40	138.68	146.3	7.62	0.53	1.05	0.25	0.78	0.56
GBR-041	36.58	74.68	38.1	0.74	2.31	0.35	1.1	0.78
GBR-043	92.96	106.68	13.72	0.12	0.55	0.18	0.3	0.25
GBR-044	195.07	228.6	33.53	0.37	0.39	0.25	0.62	0.46
GBR-045	155.45	268.22	112.77	0.62	1.94	0.18	0.81	0.54
	156.97	181.36	24.39	1.33	5.26	0.24	1.57	1.01
GBR-046	13.72	71.63	57.91	0.57	1.56	0.23	0.8	0.55
	27.43	42.67	15.24	1.11	1.75	0.36	1.48	1
	71.63	126.49	54.86	0.12	0.45	0.17	0.29	0.23

*True thickness to be determined.

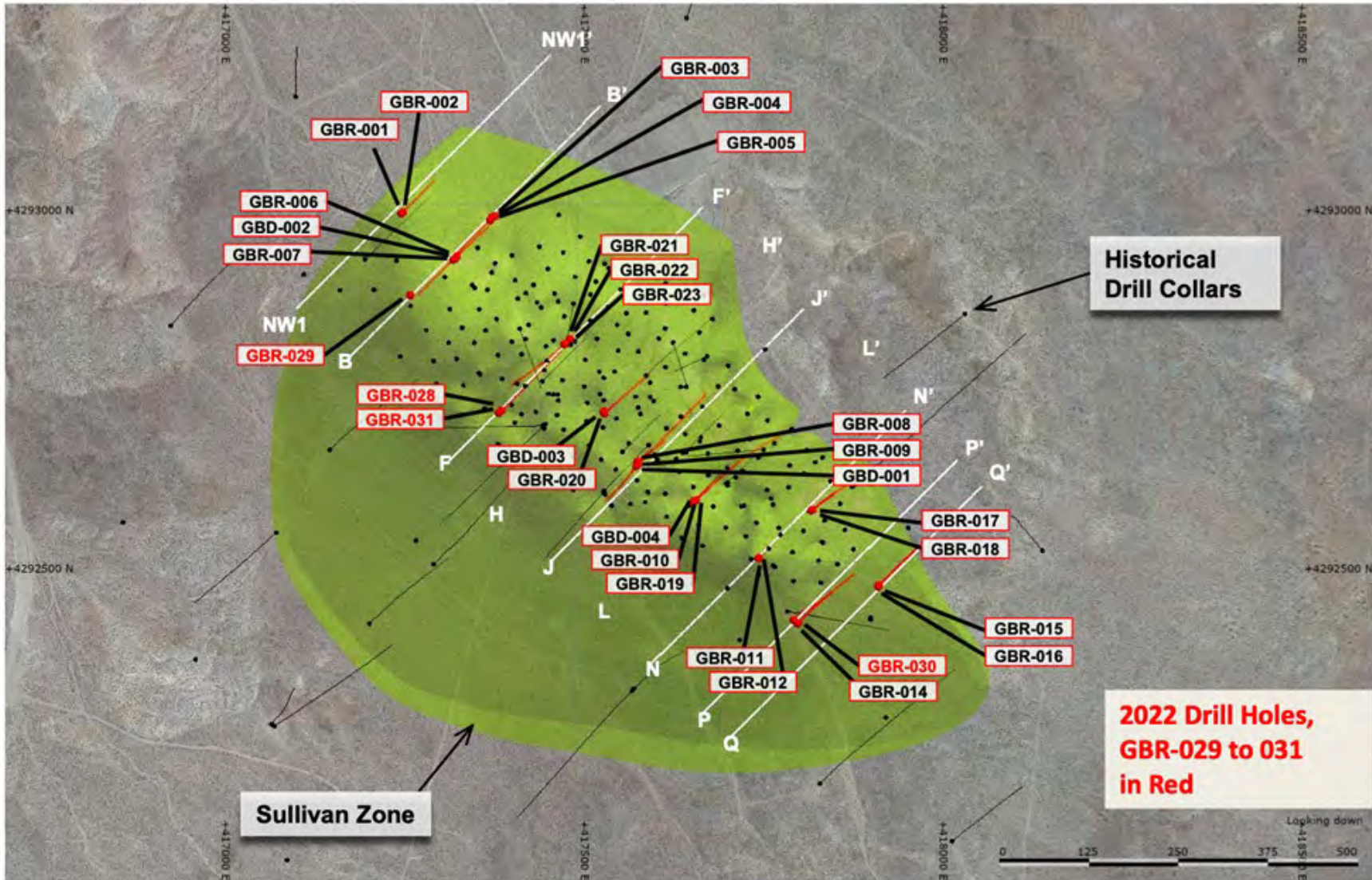

Source: www.p2gold.com (2022)

Figure 10-14 2022 Drill Hole Locations - Sullivan Zone

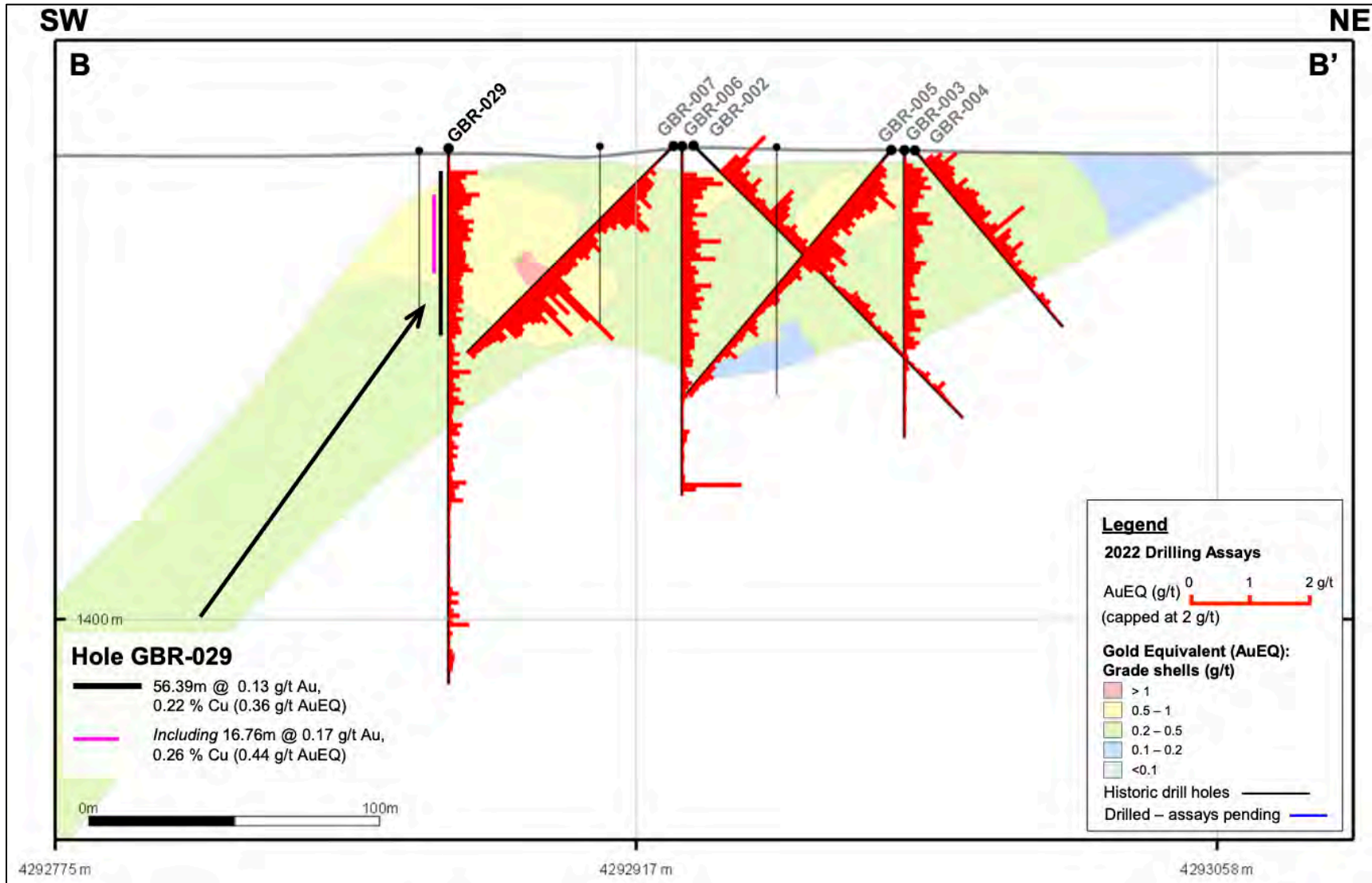

Source: www.p2gold.com (2022)

Figure 10-15 Sullivan Zone – Cross-Section B-B'

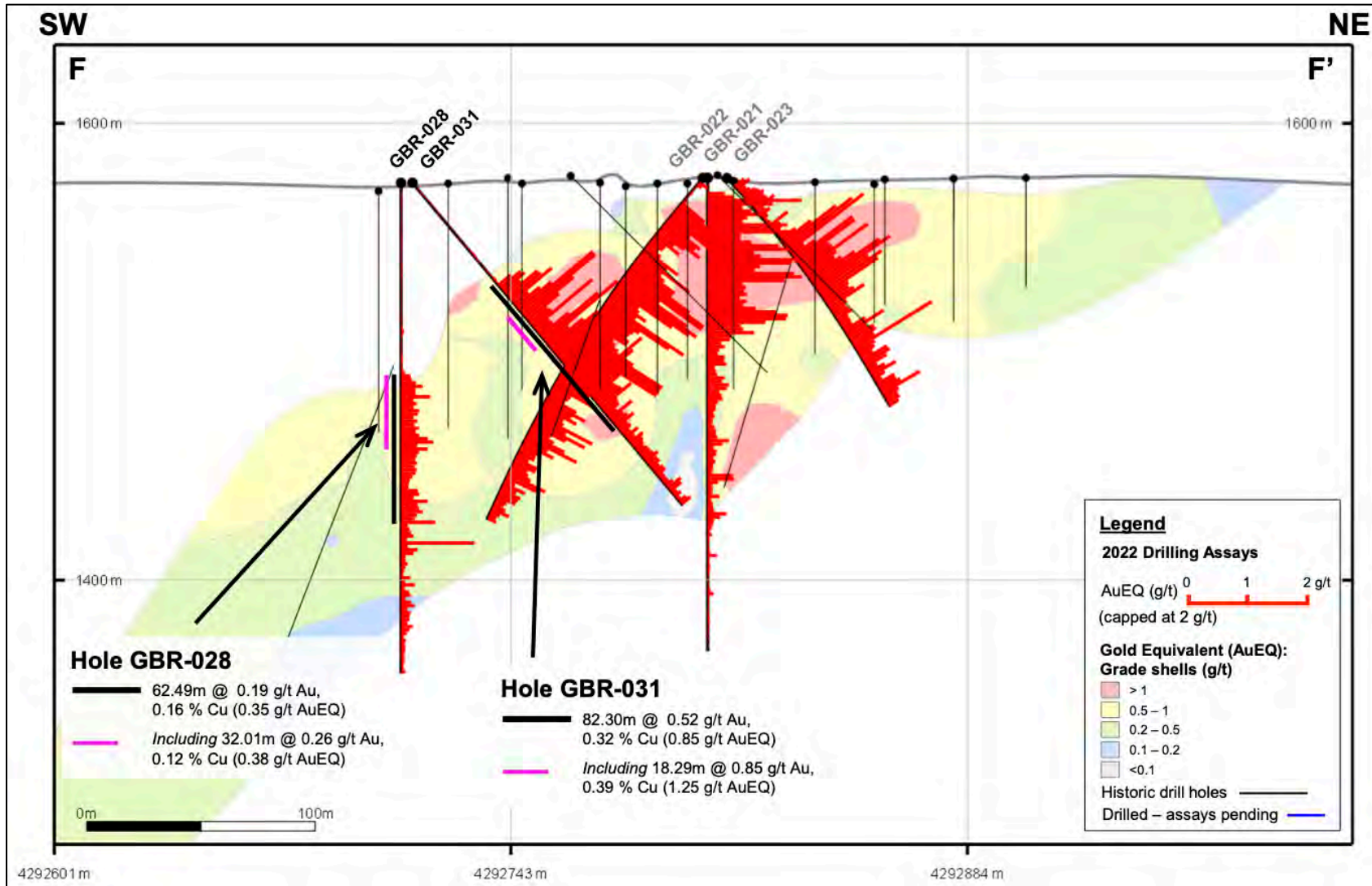

Source: www.p2gold.com (2022)

Figure 10-16 Sullivan Zone – Cross-Section F-F'

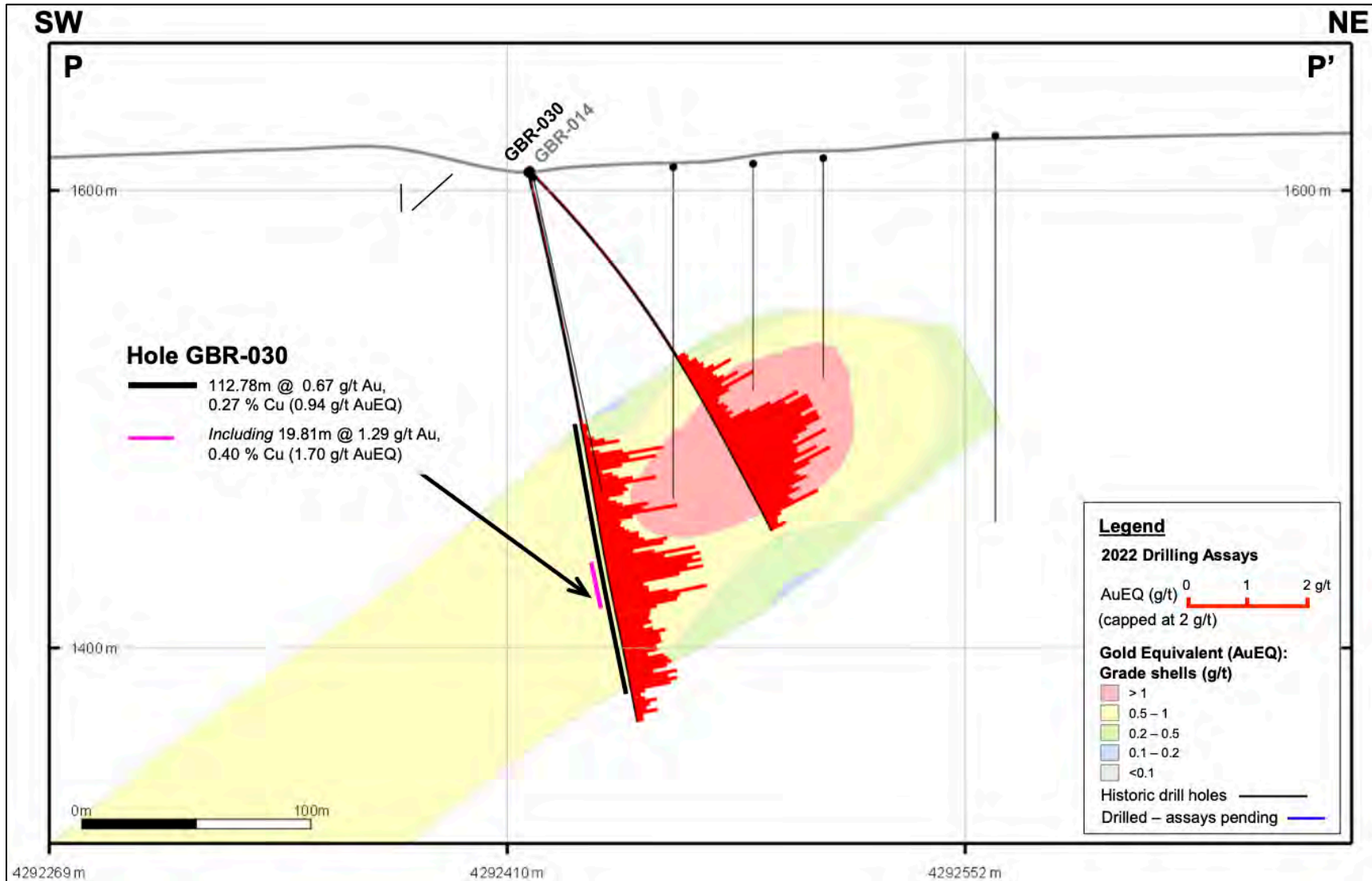

Source: www.p2gold.com (2022)

Figure 10-17 Sullivan Zone – Cross-Section P-P'

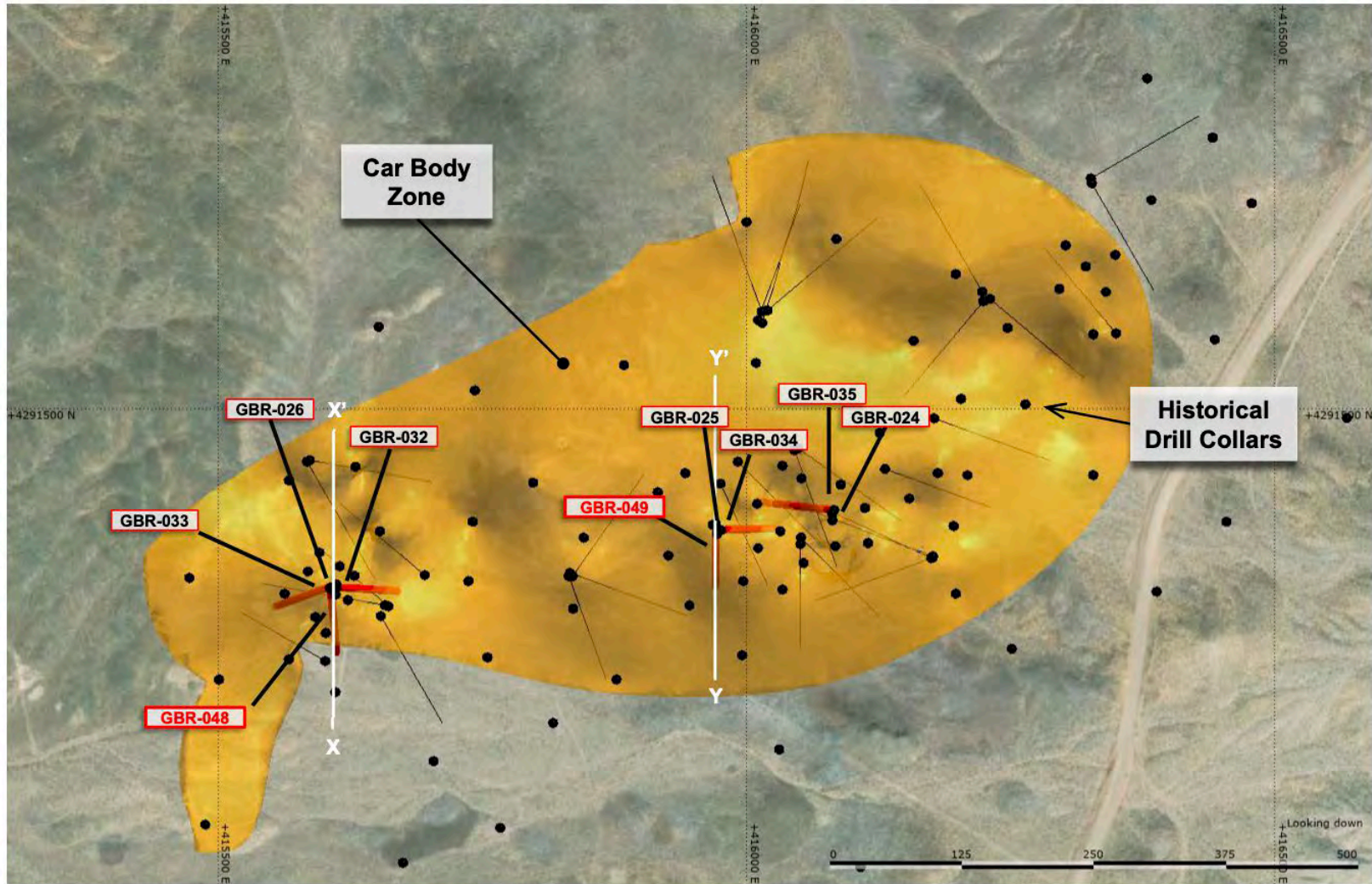

Source: www.p2gold.com (2022)

Figure 10-18 2022 Drill Hole Locations – Car Body Zone

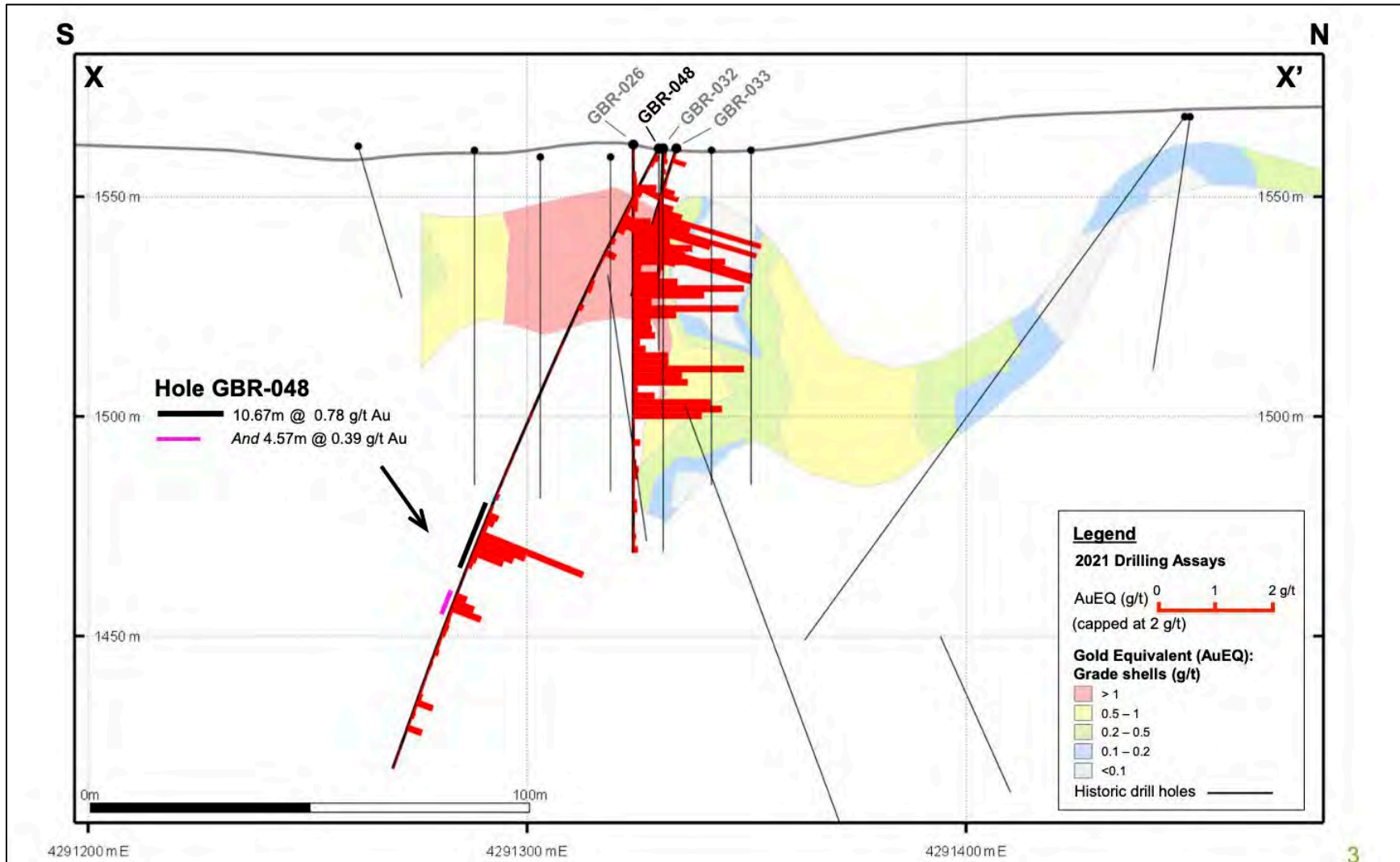

Source: www.p2gold.com (2022)

Figure 10-19 Car Body Zone – Cross-Section X-X'

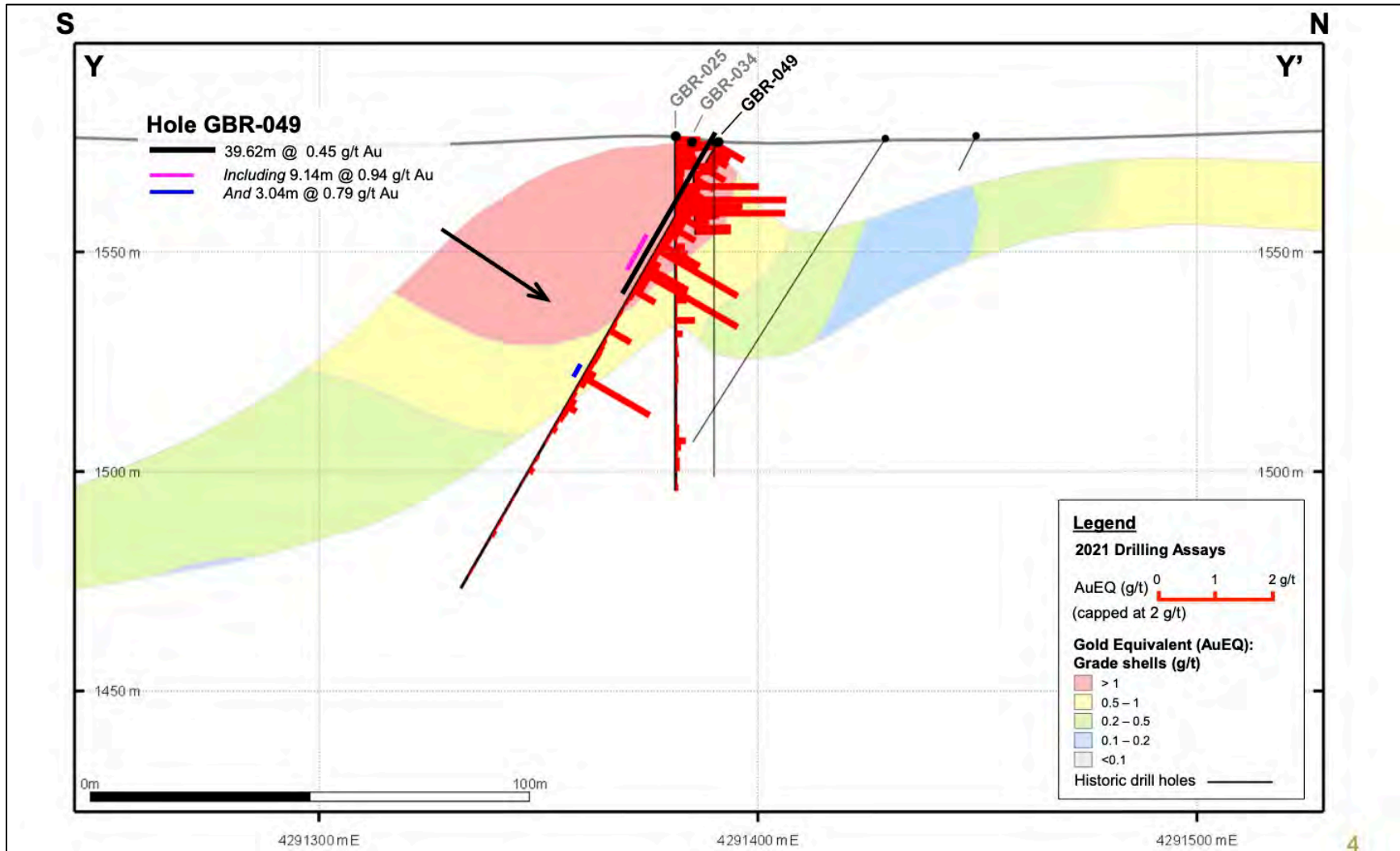

Source: www.p2gold.com (2022)

Figure 10-20 Car Body Zone – Cross-Section Y-Y'

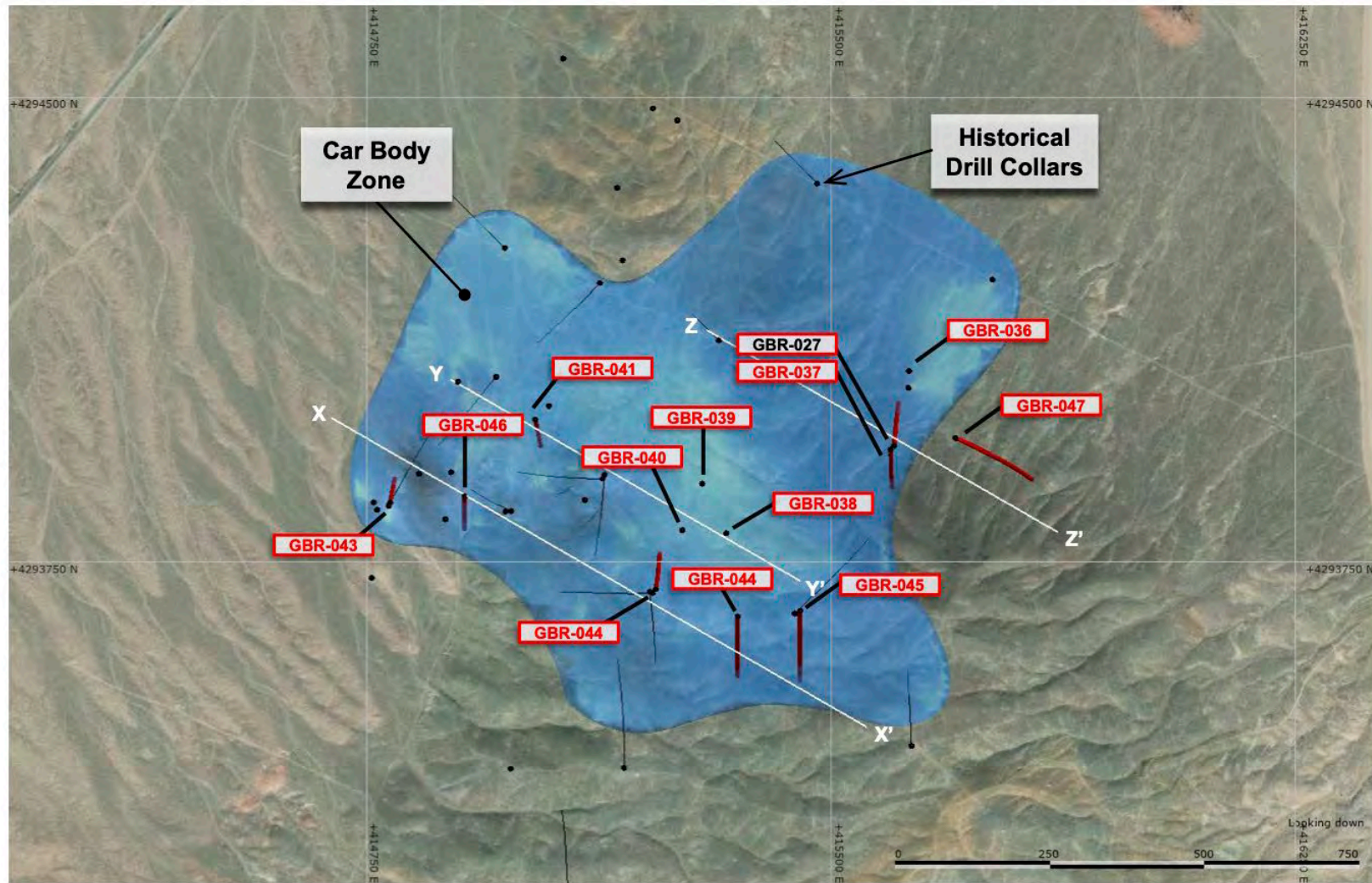

Source: www.p2gold.com (2022)

Figure 10-21 2022 Drill Hole Locations – Lucky Strike Zone

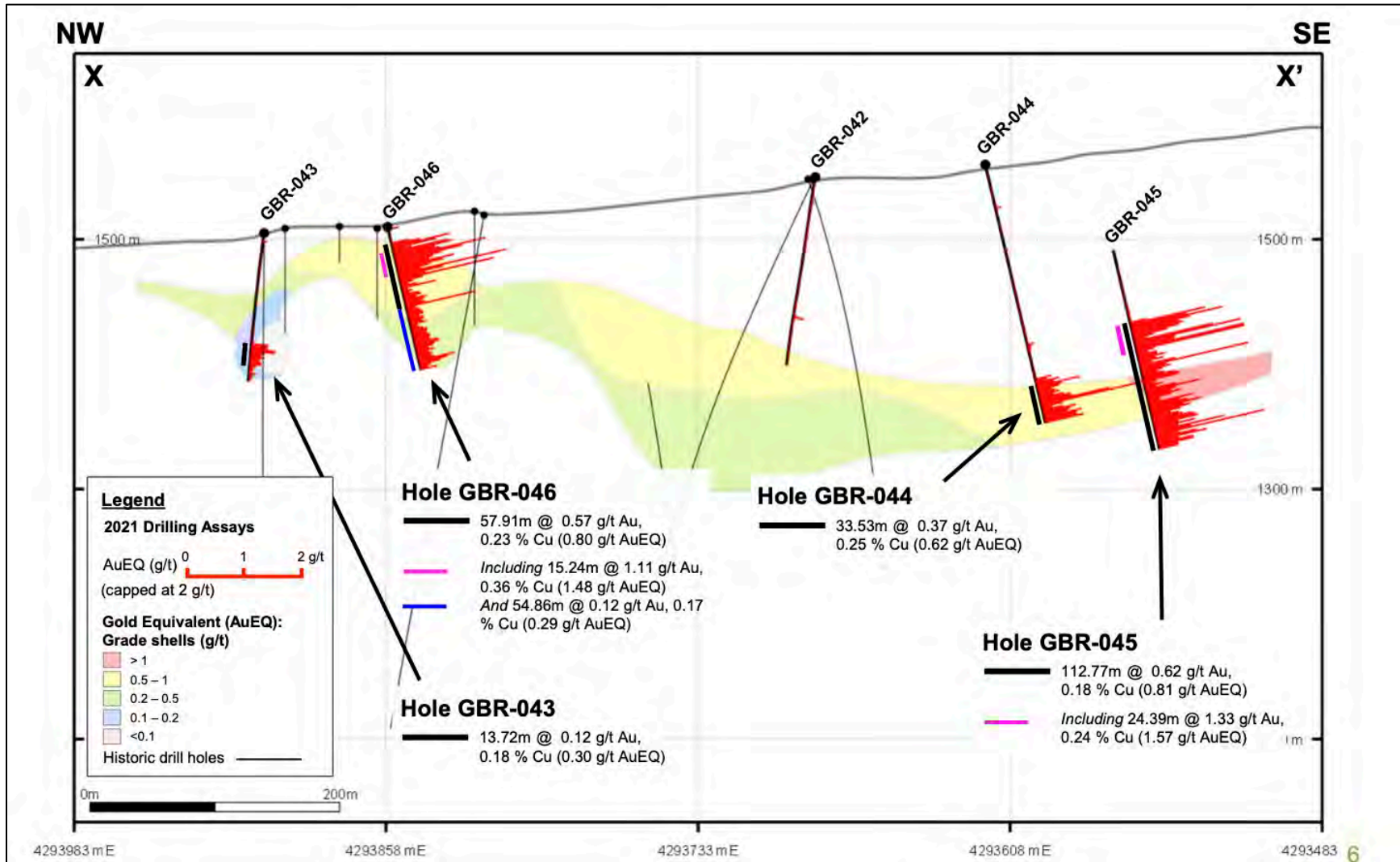

Source: www.p2gold.com (2022)

Figure 10-22 Lucky Strike Zone – Cross-Section X-X'

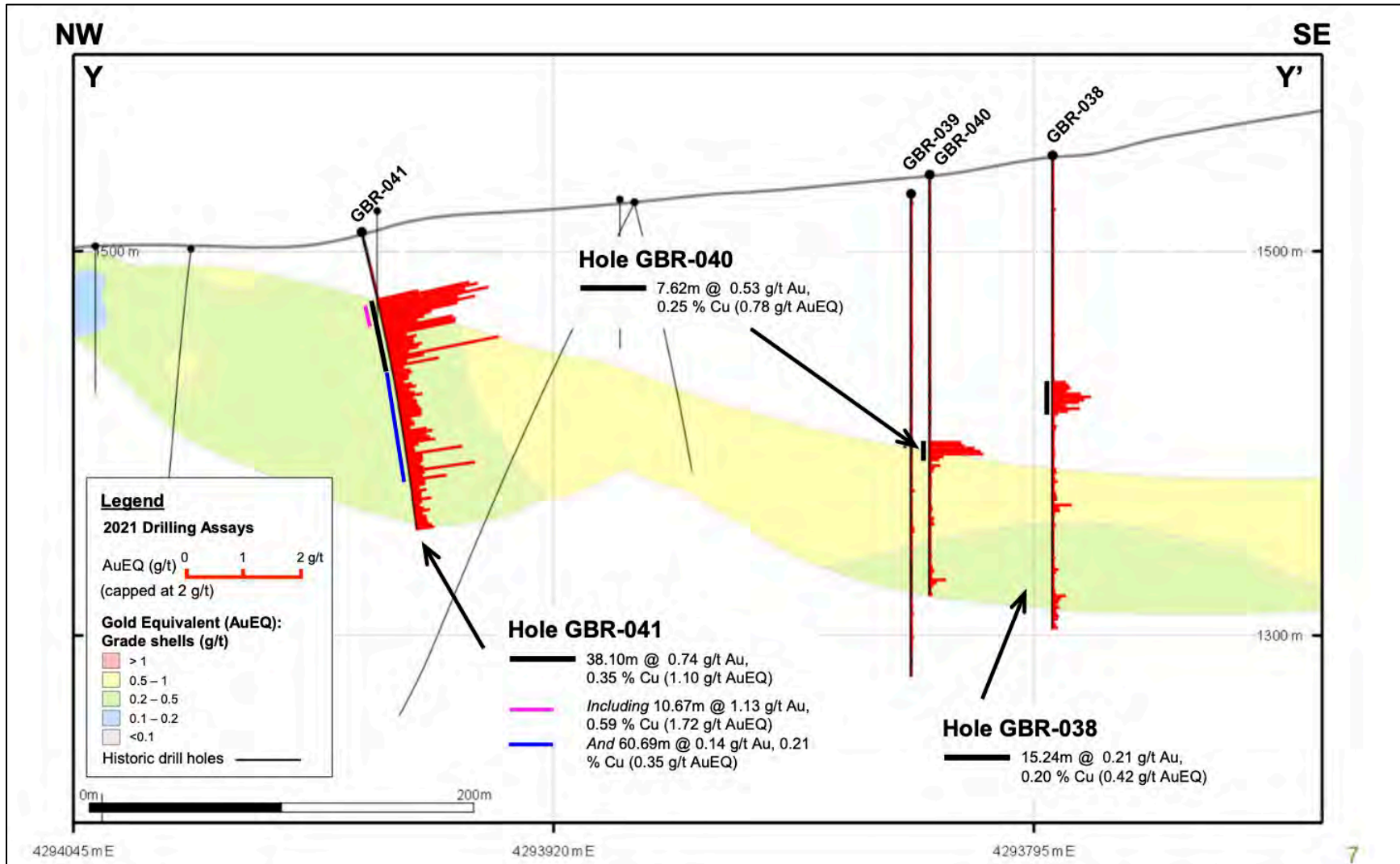

Source: www.p2gold.com (2022)

Figure 10-23 Lucky Strike Zone – Cross-Section Y-Y'

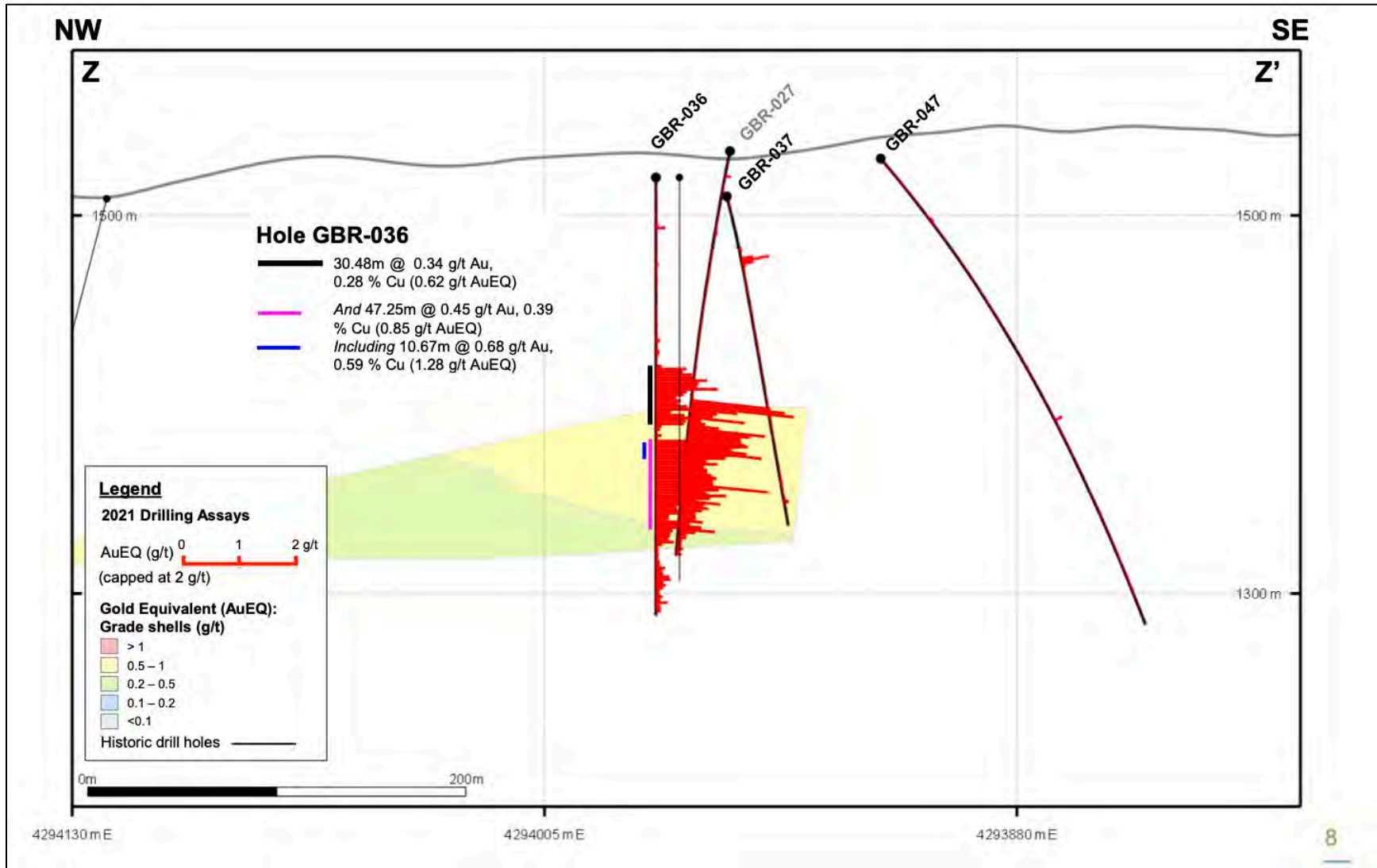

Source: www.p2gold.com (2022)

Figure 10-24 Lucky Strike Zone – Cross-Section Z-Z'

11.0 SAMPLE PREPARATION, ANALYSES AND SECURITY

The following section discusses the recent sample preparation, analyses, and security measures undertaken by P2 Gold at the Project from 2021 to 2022, and also summarizes the previous sample preparation, analyses, and security undertaken on the Property by Newcrest between 2004 and 2008 and St. Vincent during its 2011 drill program.

11.1 Sample Preparation

Sample procedures followed industry standards. Particular attention was given to checking and verifying the recording of sample data as compared to the actual samples on a daily basis, to ensure all numbering sequences and samples were correct. Following the drill core logging, sample boxes were marked for sampling and moved to a secured storage room. Following sampling, all drill core boxes were placed in consecutive order in secured areas, adjacent to the logging and storage room.

Newcrest Core Drilling: drill core was boxed on-site by drillers and picked up every one to two days by Newcrest personnel and stored in a secure location until it was logged. Drill core was cut with a drill core saw on 1.52m (5 ft) intervals for the first phase of drilling (drill hole SD-1 through SD-13 and GD-1 and GD-2) and 2m (6.6 ft) intervals for the remainder of the drill holes (SRD-15, SD-16 through SD-21; and GD-3 through GD-6). Samples were stored in a secured storage room prior to being packed in rice bags.

Newcrest RC Drilling: drill core samples were bagged on the drill site, sampled on 1.52m (5 ft) intervals, supervised at all times by a Newcrest geologist for sample accuracy (footage numbering, sample quality, etc.). Drill core samples were picked up from the drill site by the lab (ALS Minerals for drill holes G-1 through G-39; Inspectorate for drill holes G-40 through G-55, SR-1 through SR-5, and SRD-15 and SRD-15).

St. Vincent RC Drilling: drill core samples were bagged on the drill site, sampled at 1.52m (5 ft) intervals, supervised at all times by a St. Vincent representative for sample accuracy. Drill core samples were moved by St. Vincent personnel at the end of each day to a secure location on the Property for pickup by a representative of Shea Clark Smith.

The Quality Assurance/Quality Control (“QA/QC” or “QC”) procedures for the 2011 drill program were set out by Shea Clark Smith, who independently prepared the samples for analysis and inserted certified reference material (“CRMs”), blanks and duplicates into the sampling stream. Approximately 5% of the samples submitted were CRMs. The drill core samples were submitted to the ALS Minerals (“ALS”) laboratory in Reno, Nevada.

ALS is independent of P2 Gold and has developed and implemented strategically designed processes and a global quality management system at each of its locations, that meets all requirements of International Standards ISO/IEC 17025:2017 and ISO 9001:2015. All ALS geochemical hub laboratories are accredited to ISO/IEC 17025:2017 for specific analytical procedures.

The 2004 and 2006 drill program used non-certified gold reference materials, whereas the 2006-2007 and subsequent drill programs used gold and copper CRMs. All Newcrest drill programs included the insertion of pulp CRMs and blanks into the sample stream. Blanks made from decorative landscaping rock (marble or scoria) were inserted into the sampling program to test for contamination at the laboratory. The presence of coarse nugget gold was suspected by Placer due to poor reproducibility of gold grades during drilling in the Car Body Zone area. Due to this 'nugget effect,' the 2004 and 2006 RC drill programs used a centre-return RC drill hammer that collected 100% of the drill sample. RC samples were collected on 0.76m (2.5 ft) intervals and combined at ALS into 1.52m (5 ft) intervals for analysis. At least 10% of the samples sent for analysis were control samples (Au CRM pulps or blanks). A program of check assays was completed on the original pulps, including 213 check assays of 185 intervals. Eight samples over 2 g/t Au were metallic screened.

The 2006 to 2007 drill programs used a minimum of 10% control samples (10% Au-Cu CRM pulps and 2% blanks.) In 2006, Newcrest switched labs from ALS to Inspectorate America (subsequently acquired by and rebranded to Bureau Veritas). Bureau Veritas is a leading provider of laboratory testing, inspection, and certification, operating in 1,430 offices and laboratories in 140 countries. Bureau Veritas is ISO 9001 compliant and for selected methods, ISO 17025 compliant and has an extensive QA/QC program to ensure that clients receive consistently high-quality data. Bureau Veritas is independent of P2 Gold.

CRM gold or copper values falling outside an 80%-120% accepted value range were flagged and, in extreme cases, were re-analysed for all samples falling half-way between inserted control samples on either side of the flagged CRM. All 2006-2007 drilling utilized diamond drilling coring rigs. The drill core was cut with a water-cooled drill core saw. Half drill cores were sampled and the other half was retained. No quarter core re-split or re-assay was performed; however, re-split and pulp re-assays were performed where CRM values fell outside the accepted range.

The 2008 drill program utilized drill core and RC drilling. QC procedures for drill core were similar to those used for the 2006-2007 drilling, except a minimum 5% control sample rate was used (5% Au-Cu CRM pulps, 2% blanks). Sampling for RC drilling was done utilizing a rotary wet splitter, collecting an average 10.5 kg sample. Control samples were inserted with a

minimum of 5% controls (5% Au-Cu CRM pulps, 2% blanks). Rig duplicate samples were collected for RC drilling on an average of 2% of the drill samples.

11.2 2004 – 2008 Newcrest Mining QA/QC Review

In 2004, 2006, 2006-2007 and 2008, the Minerals Division of Newcrest Mining, under the direction of Roger Jones, conducted an examination of the Gabbs Property QA/QC data from four Newcrest drilling programs, one soil sampling program and a drilling program carried out prior to Newcrest's involvement in the Property.

Two laboratories were used: 1) ALS for the 2004 and 2006 programs and 2) Inspectorate for the 2006-2007 and 2008 programs. During the first two programs, samples were analysed for gold only. In the latter two programs, copper analyses were also performed. A summary of the QA/QC examination conclusions and recommendations by the Author is presented below:

- Even though individual results are unreliable, the CRMs have been shown to be homogeneous, which suggests that there were precision issues at the laboratories. Inspectorate appeared to be worse than ALS (28% and 18% out of control results failed, respectively). It is recommended that Mineral Resource calculation blocks should be large enough to include sufficient samples to reduce the variance due to this imprecision;
- Median bias figures for the drilling programs were acceptable at -3.3%, -2.3%, +1.8% and -1.3% for gold in the 2004, 2006, 2006-2007 and 2008 programs, respectively. Copper median bias was significantly worse at +8.1% and +4.5% for 2006-2007 and 2008, respectively. Some analytical batches showed a consistent bias over and above the average bias. It is recommended to routinely examine data sets for this batch-scale bias and take the issue up with the laboratory at the time should the bias become excessive in either amplitude or duration. This action would require an up-to-date control chart;
- Copper results for the CRMs are worse than gold results. Three in four results were outside the preferred value ± 2 standard deviation limits. In fairness, two of the CRMs are gold CRMs and the copper results have not been proven to be homogeneous to the same extent and do not have certified copper values. Others (including all the CRMs used in the 2008 drilling) are copper-gold CRMs in which the copper concentration has been shown to be homogeneous and has been certified. It is recommended that these results should be brought to the attention of Inspectorate. Depending on their response, consideration should be given to changing laboratories;

- Results for the highest-grade copper CRM (certified value 1.55% Cu) were consistently overestimated by 20-30%. Only three times in 130 assays did Inspectorate report results for this CRM inside the certified value ± 2 standard deviation limits. No other laboratory analysed CRM 54Pa for this Property. From these facts, it appeared that the few samples reporting in excess of 1% copper (the lowest grade at which this assay method is used) may be 20% or more high. This was a copper-gold CRM and has a certified value for copper. Screen (metallics) fire assays showed that there is a coarse gold problem at Car Body. On average, 55% of the gold reported in the coarsest 6% of the sample. Duplicate fire assays of the passing fraction also suggested a lack of precision in that fraction. Other deposits also show some evidence of coarse gold problems. It is recommended that gold particle size distribution studies should be carried out. Initially this could be a statistical study, but mineralogical studies are likely to be necessary in the near future. Results from existing replicates were not suitable, due to laboratory imprecision;
- Precision was difficult to estimate, since very few routine field splits or pulp splits were analysed in the same batch as the original sample. Pulp and coarse splits done at a later time show very poor precision, with an underlying precision generally no better than about $\pm 50\%$ at the 95% confidence limit. There were likely to be a number of sources of this poor precision, including coarse gold problems, poor laboratory precision and possibly inadequate sample preparation (although this was not established beyond the existence of a nugget problem). It is recommended that size analysis be undertaken for a minimum of 2% of samples, including the first sample of every batch. Until proven to be excessive, the standard should be 95% passing 75 μm . If any sample failed, the sample was to be re-pulverized and one in every three samples between the failed sample and the last passing sample was to have a size analysis carried out. In the event of further failures in that group, all samples between a failed sample and the last passing sample were to have a size analysis carried out; and
- Additional recommendations are that at least 5% of all samples should be replicated at the earliest possible stage (i.e., at the first mass reduction stage) and re-analysed in the same batch as the original, and that a sample preparation orientation study should be carried out before any further drilling to determine minimum appropriate standards for this Property.

The Author completed a detailed review of the Newcrest QA/QC data and agreed with the examination conclusions. There were many issues outlined, particularly with the CRMs and precision at the pulp level and recommendations were made to St. Vincent in 2011 to address the issues.

11.3 2011 St. Vincent QA/QC Review

St. Vincent completed ten RC drill holes 2,400m (7,875 ft) in the vicinity of the Sullivan and Lucky Strike Deposits at the Gabbs Property, Nevada in March - April 2011. Previous work in this area of the Property by Newcrest Mining encountered QA/QC problems, due to nuggety gold at the Car Body Deposit, and due to various laboratory preparation and analysis issues. To address these issues, a QA/QC protocol was followed by St. Vincent, involving the use of geochemical CRMs, blanks, and pulp replicate samples (duplicates), and randomization of the submittal prior to sample preparation and analysis. Additionally, a third-party prep lab (MEG Labs, Carson City, Nevada) was used to effectively blind QA/QC samples from the assay laboratory. Mr. Shea Clark Smith of Minerals Exploration & Environmental Geochemistry of Reno, NV was retained by St. Vincent in June 2011 to outline, implement and monitor the QC program. The results of the QA/QC program were reviewed by the Author, as well as all raw data in Excel format.

The procedures for the QA/QC program are summarized by the Author and are presented in this section.

11.3.1 Sample Preparation

All samples were prepared at MEG Labs with the following minimum requirements:

- Dry weight of each sample to account for variable recovery at the drill rig;
- Randomization of the samples that comprise one hole prior to sample preparation;
- Initial crushing of the entire sample to 90% pass 1,600 μm (10 mesh) with gravel wash between each sample;
- Riffle split to 250 grams; and
- Pulverize 250 grams to 90% pass 75 μm (200 mesh) with barren sand wash between each sample.

11.3.2 QA/QC Samples

QA/QC samples were identified as "QAQC 1, QAQC 2, QAQC 3", etc. The contents were blind to the assay lab, including: 1) CRMs of known Au, Ag, Cu, and Mo concentration; 2) preparation-blanks that went through the sample preparation circuit; and 3) pulp duplicates that were made from splits in the preparation laboratory. CRMs were placed in the analytical stream to measure the accuracy of the data, whereas preparation duplicates measure the precision of the data. Preparation-blanks test for background contamination and contamination from previous samples. All of these QA/QC samples were vital monitors of the sample preparation and analytical process. QA/QC samples were placed in the submittal at irregular intervals, and at a rate of approximately one for every 20 samples.

Additionally, the down-hole sample order was randomized prior to sample preparation and analysis. This procedure is proven to be one of the most effective ways of revealing systematic error, the idea for which was first introduced by A.T. Miesch (CIM Special Volume 11, p. 582-584, 1982). Systematic error results from repetitive procedures during sample preparation and analysis. Patterns in plots of the randomized data reveal preparation issues such as (however, not limited to) carry over from contaminated equipment and mis-calibration during assay.

11.3.3 Certified Reference Materials and Blanks

The following CRMs and blanks were used for this Property. The 95% Confidence interval is indicated for certified elements.

- MEG-Prep Blank: about 0.005 ppm Au.
- MEG-S106011X (MEG-Mo-1) 95% Confidence = 0.195-0.246% Mo.
- MEG-S108004X 0.544 ppm Au, 0.0215% Cu: 95% Confidence = 0.401-0.688 ppm Au; 0.018 – 0.025 % Cu.
- MEG-S108005X 0.432 ppm Au, 0.414% Cu: 95% Confidence = 0.366-0.497 ppm Au; 0.35- 0.48 % Cu.”

11.3.4 Assay Methods

Analysis and assay work was done at ALS. Gold assays were undertaken in Reno, whereas multi-element methods were completed in Vancouver using the following codes:

- Gold: Au-AA23 (30 g/FA/AAS), Over limits = Au-GRA21.
- Copper & Molybdenum: ME-ICP61 (4-acid digestion).

The Author obtained the raw data in Excel format from the St. Vincent drill program. An examination of the performance of the two CRMs and the blank material was completed.

There were 17 data points for CRM MEG S108004X for gold and copper. The Author utilized ± 2 standard deviations from the mean for the warning limits and ± 3 standard deviations from the mean for the tolerance limits. All 17 data points plotted within the warning limits, indicating acceptable accuracy.

There were 18 data points for CRM MEG S108005X for gold and copper. All except one data point remained within $+2$ standard deviations from the mean for Au. However, 100% of the data points were above the mean, indicating bias at the lab. All data points for copper remained within ± 2 standard deviations from the mean.

There were ten blank samples analysed and all returned very low values, indicating no contamination at the preparation level.

11.4 P2 Gold Phase 1 And 2 Drilling (2021-2022)

11.4.1 Sample Preparation and Security

Drill core from P2 Gold's Phase 1 and 2 drill programs at the Gabbs Project was boxed on site by the drillers and wooden depth markers were inserted by the drillers at 1.52m (5 ft) intervals. Drill core was retrieved daily by P2 Gold geologists, who transported the boxed drill core to the P2 Gold office in Hawthorne, Nevada. Drill core was logged and photographed daily, and then split with a manual drill core splitter on 1.52m (5 ft) intervals, with additional sample breaks at distinct lithological boundaries as required. One-half of the drill core was bagged in numbered cloth sample bags and the remaining one-half of the drill core was returned to the drill core box for storage. Drill core logging included RQD, lithology, observed mineralization, structural and alteration features.

Samples from P2 Gold's 2021 to 2022 RC drilling were collected with an airstream cyclone and bagged in cloth sample bags at the drill site on 1.52m (5 ft) intervals, and supervised at all times by a Company geologist for sample accuracy. Rock chip samples were collected for each sample interval and logged on-site for observed lithology, mineralization, and hand-held XRF measurements for Cr, Cu and S.

Blanks and CRMs were inserted at a rate of 5%. Blanks were inserted into the sample stream whenever sample numbers end in 10, 30, 50, 70 and 90. CRMs were inserted at every sample number ending in 00, 20, 40, 60 and 80. A coarse duplicate sample was split from every sample ending in 06, 26, 46, 66 or 86 by the receiving laboratory.

All drill samples were assigned an individual sample tag number from a pre-numbered sample book. All information was transcribed in a standard format Excel spreadsheet. Samples were stored in a secured sample room and delivered by commercial driver to the ALS Laboratory in Elko, Nevada.

11.4.2 Sample Analyses

All drill core and chip samples were submitted for preparation by ALS at its facilities in Elko, Nevada and the analysis completed at ALS facilities in Reno, Nevada and North Vancouver, British Columbia.

Once samples were received at the ALS preparation facility, they were registered, dried, crushed to 75% passing 2 mm and then split with a riffle splitter. A 1,000 g split from each sample was then pulverized to 85% minus 75 µm. All pulverized splits were submitted for gold content determination by fire assay with Atomic Absorption Spectroscopy (“AAS”) finish and samples with over 10 g/t Au were fire assayed with a gravimetric finish. Copper content was assayed by sulphuric acid leach with AAS finish and samples returning results of ≥10% were further analysed by four-acid digestion with ICP finish. Silver content was assayed using four-acid super trace analysis with ICP-AES finish and samples returning results of ≥100 ppm were further analysed by four-acid digestion with ICP-AES finish. Samples were also analysed for an array of elements using four-acid super trace analysis and density was also determined on select samples. Following is a description of the methods used at the Project and the detection limits for each method is given in Table 11-1.

11.4.2.1 Fire Assay Fusion, AAS Finish (Au-AA23)

A prepared sample is fused with a mixture of lead oxide, sodium carbonate, borax, silica and other reagents as required, inquarted with 6 mg of gold-free silver and then cupelled to yield a precious metal bead. The bead is digested in 0.5 mL dilute nitric acid in the microwave oven, 0.5 mL concentrated hydrochloric acid is then added and the bead is further digested in the microwave at a lower power setting. The digested solution is cooled, diluted to a total volume of 4 ml with de-mineralized water, and analysed by AAS against matrix-matched CRMs.

11.4.2.2 Fire Assay Fusion, Gravimetric Finish (Au-GRA21)

A prepared sample is fused with a mixture of lead oxide, sodium carbonate, borax, silica and other reagents in order to produce a lead button. The lead button containing the precious metals is cupelled to remove the lead. The remaining gold and silver bead is parted in dilute nitric acid, annealed and weighed as gold.

11.4.2.3 Ultra-Trace Level Method Using ICP-MS and ICP-AES (ME-MS61m)

A prepared sample (0.250 g) is digested with perchloric, nitric, and hydrofluoric acids to near dryness. The sample is then further digested in a small amount of hydrochloric acid. The solution is made up to a final volume of 12.5 ml with 11% hydrochloric acid, homogenized, and analysed by inductively coupled plasma-atomic emission spectrometry (ICP-AES).

11.4.2.4 Determination of Oxidized Copper by 5% Sulphuric Acid Leach (Cu-AA05)

This method is suitable for the determination of Cu oxide or soluble Cu in mineralized material and any other samples analysed by AAS for non-sulphide Cu. The sample (~ 1.0 g) is shaken (in automatic shaker) in 5% sulphuric acid at room temperature for an hour. The solution is

subsequently filtered into a flask ensuring the residue is well washed with warm water. The filtrate is diluted to volume with water, mixed and copper content is measured by AAS.

11.4.2.5 Grade Elements by Four-Acid Digestion/ICP-AES Analysis (ME-OG62)

A prepared sample is digested with nitric, perchloric, hydrofluoric, and hydrochloric acids, and then evaporated to incipient dryness. Hydrochloric acid and de-ionized water are added for further digestion, and the sample is heated for an additional allotted time. The sample is cooled to room temperature and transferred to a volumetric flask (100 ml). The resulting solution is diluted to volume with de-ionized water, homogenized and the solution is analysed by ICP-AES or by AAS. Results are corrected for spectral interelement interferences.

11.4.2.6 Density (OA-GRA08b)

A prepared sample (3.0 g) is weighed into an empty pycnometer. The pycnometer is filled with a solvent (either methanol or acetone) and then weighed. From the weight of the sample and the weight of the solvent displaced by the sample, the density is calculated according to the equation below.

$$\text{Specific Gravity} = \frac{\text{Weight of sample (g)}}{\text{Weight of solvent displaced (g)}} \times \text{Specific Gravity of Solvent}$$

**Table 11-1
Analytical Detection Limits**

Method Code	Element	Units	Sample Weight (g)	Lower Limit	Upper Limit
Au-AA23	Gold	ppm	30	0.005	10.0
Au-GRA21	Gold	ppm	30	0.05	10,000
ME-MS61	Copper	ppm	0.250	0.2	10,000
Cu-AA05	Copper	%	~1.0	0.001	10
ME-OG62	Copper	%	--	0.001	50
ME-MS61	Silver	ppm	0.250	0.01	100
ME-OG62	Silver	ppm	--	1	1,500
OA-GRA08b	Specific Gravity	Unity	3.0	--	--

Source: P&E (2023)

11.4.3 Phase I Drilling Quality Assurance / Quality Control Review

P2 Gold implemented and monitored a thorough QA/QC program for the Phase 1 drilling undertaken at the Gabbs Project in 2021. QC protocol included the insertion of QC material into every batch sent for analysis, including CRMs, blanks and coarse reject duplicates. CRMs and

blanks were inserted approximately every 1 in 20 samples, and one in 20 samples had a sample cut from assay rejects assayed as a field duplicate.

11.4.3.1 Performance Of Certified Reference Materials

CRMs were inserted into the analysis stream approximately every 20 samples. Two CRMs were used during the 2020 drill program to monitor for gold and copper performance: 1) ME-1409 and 2) ME-1706. Both CRMs were purchased from CDN Resource Laboratories Ltd., (“CDN”) of Langley, BC, and are certified for gold, silver and copper.

Criteria for assessing CRM performance are based as follows. Data falling outside ± 3 standard deviations from the accepted mean value, or two consecutive data points falling between ± 2 and ± 3 standard deviations on the same side of the mean, fail. A single data point falling between ± 2 and ± 3 standard deviations of the mean is considered a warning. Data falling within ± 2 standard deviations from the accepted mean value pass.

A total of 169 CRM samples were submitted during the Phase 1 drill program. Ongoing QC assessment detected a total of 16 instances where CRM values for Au and Cu fell outside ± 3 standard deviations from the accepted mean value. All failures were followed up by Company personnel, with significant failures triggering the re-run of five samples before and after the failed CRM. Re-assay results replace the original results in the Project database, provided the re-assayed control sample passes QC assessment. P2 Gold keep up-to-date detailed records of all failed QC samples, sample re-runs and which assays have been approved for import into the Project database. A summary of results for the CRM data are presented in Table 11-2.

**Table 11-2
Summary of CRM Samples Used at Gabbs in Phase I**

CDN CRM	Au					
	CRM Mean (ppm)	2SD	n	No. Fails	% Fails	Mean of Results (ppm)
ME-1409	0.646	0.07	91	6	6.6	0.650
ME-1706	2.062	0.156	78	3	3.8	2.025
TOTAL			169	9	5.3	
CDN CRM	Cu					
	CRM Mean (ppm)	2SD	n	No. Fails	% Fails	Mean of Results (ppm)

ME-1409	2,420	100	91	2	2.2	2,421
ME-1706	8,310	240	78	5	6.4	8,326
TOTAL			169	7	4.1	
CDN CRM	Ag					
	CRM Mean (ppm)	2SD	n	No. Fails	% Fails	Mean of Results (ppm)
ME-1409	11.6	1.6	91	0	0	12.0
ME-1706	11.9	1.2	78	2	2.6	11.9
TOTAL			169	2	1.2	

Source: P&E (2023)

The Author considers that the CRM data demonstrate acceptable accuracy in the 2021 Phase 1 drilling at the Gabbs Project.

11.4.3.2 Performance Of Blanks

The blank material used at the Project during 2021 was a locally sourced scoria, purchased from a garden supply business in Reno. Blanks were inserted every 20 samples and all blank data for Au, Ag and Cu were reviewed by the Author.

An upper warning limit of three times the detection limit and a tolerance limit of five times the lower detection limit (“LLD”) were set. A blank returning a value greater than five times the LLD is considered a failure. A blank returning a value greater than three times the LLD is considered a warning and two consecutive warnings constitute a failure. All blank failures are re-assayed, with five samples before and five samples after the failure reanalysed. Re-assay results replace the original results in the Project database, provided the re-assayed control sample passes QC assessment.

There were 170 blank data points to examine within the Phase 1 drill program data. There were four instances where the assay value for gold exceeded 5 x LLD and re-assay was requested for ± 5 samples above and below the failed blank samples. There were 20 instances where the assay value for silver exceeded 5 x LLD, however, all instances except one were 0.06 ppm from the 5 x LLD warning limit. A single sample returned a value of 0.85 ppm silver. Copper blank performance indicate the presence of copper within the scoria blank material, with results ranging from 24 ppm to 269 ppm copper detected and an average of 47.2 ppm copper. P2 Gold is in the process of sourcing a more suitable blank material as a result. Re-assays on copper failures were not considered necessary, considering the elevated results indicated copper being present within the blank material.

11.4.3.3 Performance Of Duplicates

Preparation duplicate data for gold and copper were examined for the 2021 Phase 1 drill program at the Gabbs Property. P2 Gold automated the duplication process with ALS, by requesting the lab to cut a second split for every sample ending in 06, 26, 46, 66, and 86. The Company established a failure criterion whereby 90% of the pairs have <10% relative difference between the original and duplicate assay.

A total of 170 prep duplicate samples were assessed for the Phase 1 drill program. Data were plotted on scatter and ARD and the coefficient of determination (“R²”) value for the gold duplicates estimated at 0.836, 1.0 for the silver duplicates and 0.998 for the copper duplicates.

Copper and silver precision evaluation illustrates excellent correlation between primary and duplicate results with an R² very near to 1 for both, and with around 90% of paired copper duplicates having <10% relative difference. Gold precision, on the other hand, shows poor precision and a great deal of variability in scatter performance and only around a third of the data has <10% relative difference. The average coefficient of variation (“CV_{AVE}”) for gold was also calculated by the Author and estimated to be about 32%.

The laboratory’s pulp duplicate pairs were not available to the Author to examine, and it is recommended that this be undertaken to assess precision at the pulp level.

11.4.4 Phase 2 Drilling Quality Assurance / Quality Control Review

11.4.4.1 Performance Of Certified Reference Materials

The same CRMs and insertion rate utilized in the Phase 1 drilling program, were used in Phase 2 and criteria for assessing CRM performance is described in Section 11.4.3.1.

A total of 144 CRM samples were submitted during the Phase 2 drill program. Ongoing QC assessment detected a total of 20 instances where CRM values for Au, Ag and Cu fell outside ±3 standard deviations from the accepted mean value. All failures were followed up by Company personnel, with significant failures triggering the re-run of five samples before and after the failed CRM. Re-assay results replace the original results in the Project database, provided the re-assayed control sample passes QC assessment. Results for the CRM data are presented in Figure 11-1 through Figure 11-6.

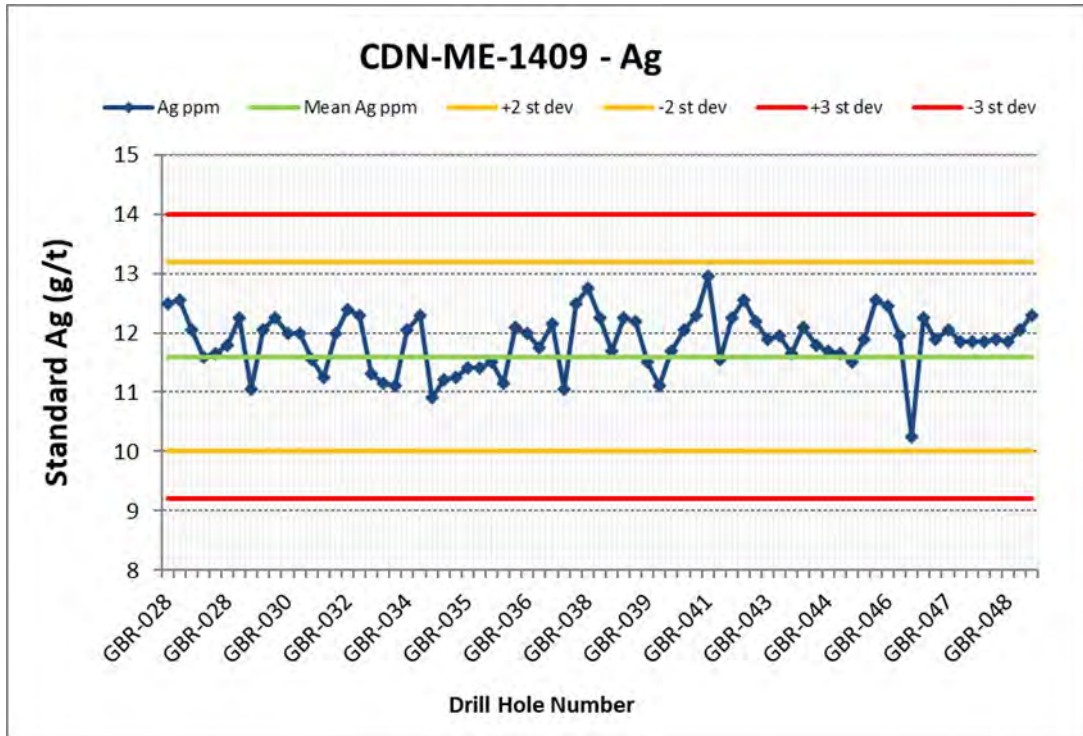

Source: P&E (2023)

Figure 11-3 Performance of ME-1409 Ag CRM at ALS for Phase 2 Drilling

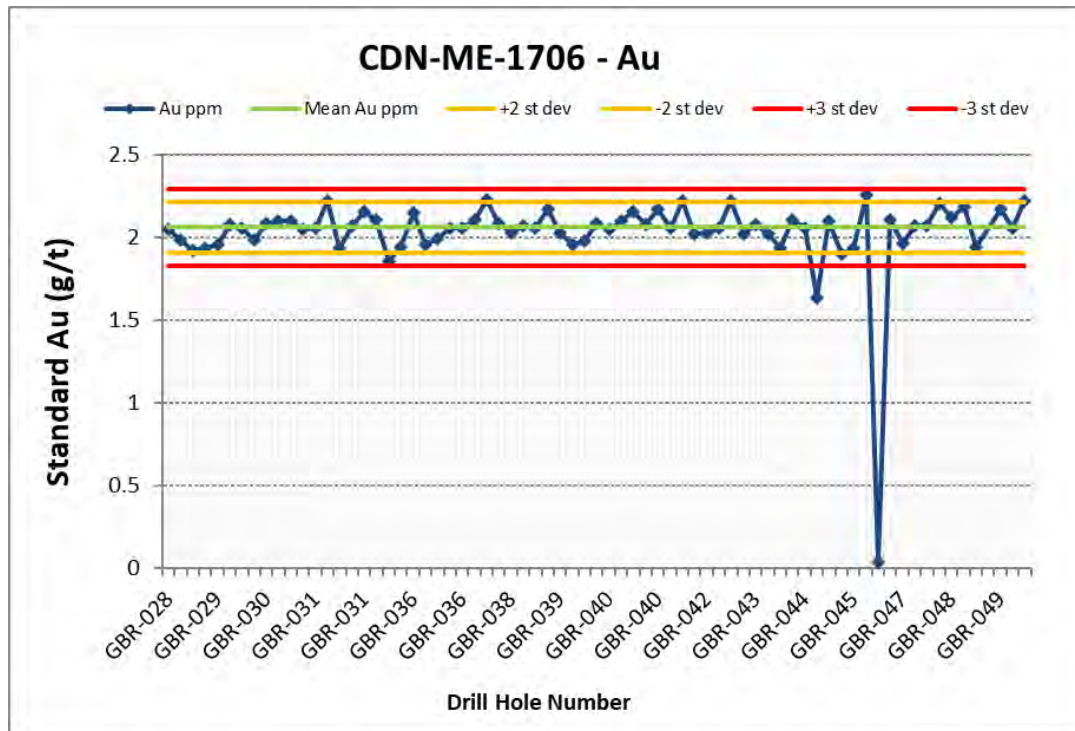

Source: P&E (2022)

Figure 11-4 Performance of ME-1706 Au CRM at ALS for Phase 2 Drilling

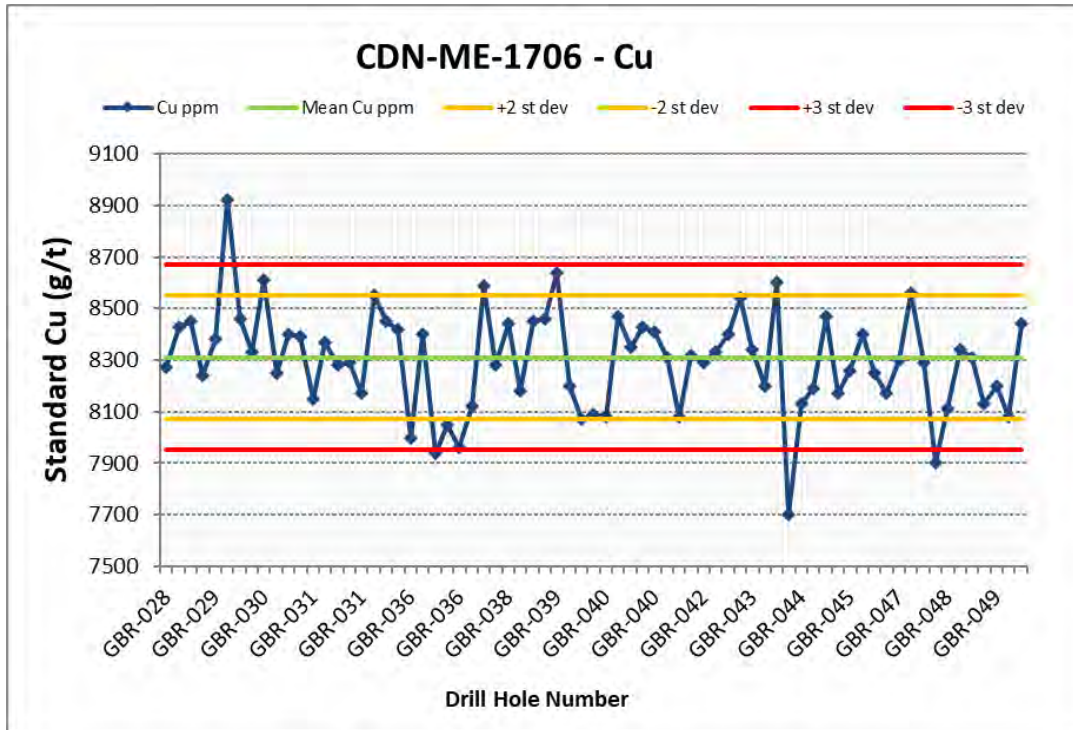

Source: P&E (2022)

Figure 11-5 Performance of ME-1706 Cu CRM at ALS for Phase 2 Drilling

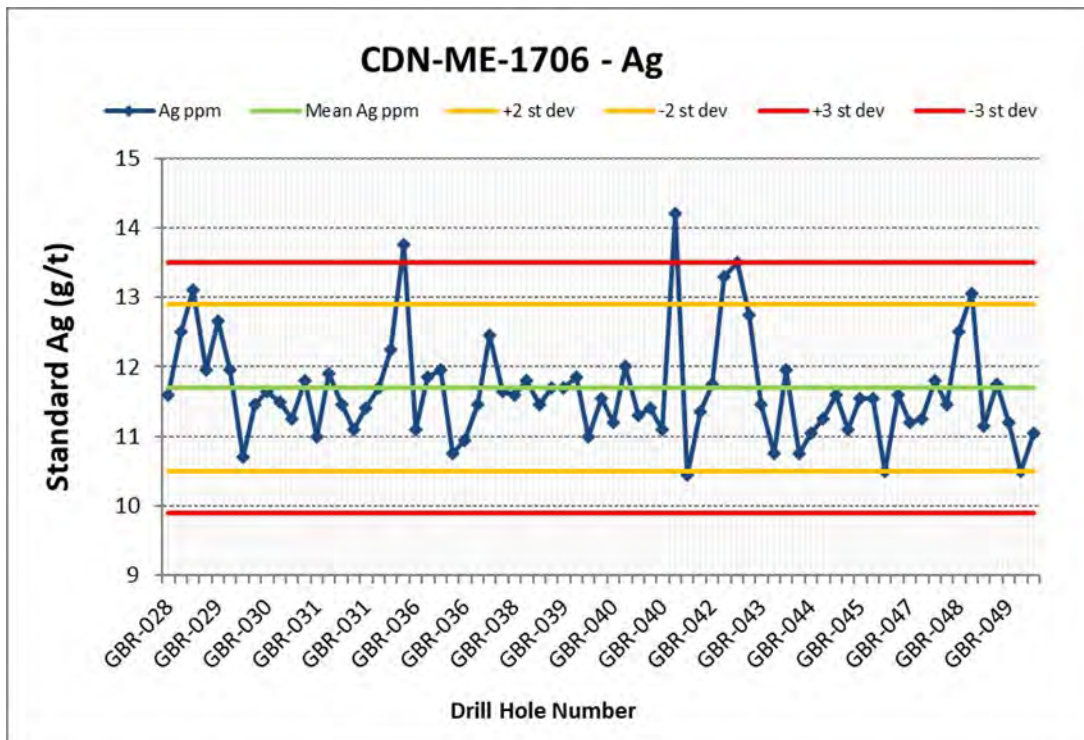

Source: P&E (2022)

Figure 11-6 Performance of ME-1706 Ag CRM at ALS for Phase 2 Drilling

The Author considers that the CRM data demonstrates acceptable accuracy in the Phase 2 drilling at the Gabbs Project.

11.4.4.2 Performance Of Blanks

Two blanks were used during Phase 2 drilling: the same locally sourced scoria used in Phase 1 and the MEG-BLANK.17.11 blank (certified for Au only) sourced from Moment Exploration Geochemistry LLC of Lamoille, Nevada. The same insertion rate utilized in the Phase 1 drilling program was used in Phase 2, and criteria for assessing blank performance is described in section 11.4.3.2. The new MEG-BLANK.17.11 is certified for Au only and was observed to return very low grades of Cu marginally above LDL levels. Warning and tolerance limits are therefore based upon the calculated mean and standard deviation of all Phase 2 results.

There were 115 scoria blank data points and 36 MEG-BLANK.17.11 data points to examine within the Phase 2 drill program data. No failures exceeding 5 x LLD were observed for gold in either blank, and no material concerns with contamination were observed in the silver and copper data.

Results for the blank data are presented in Figure 11-7 through Figure 11-11.

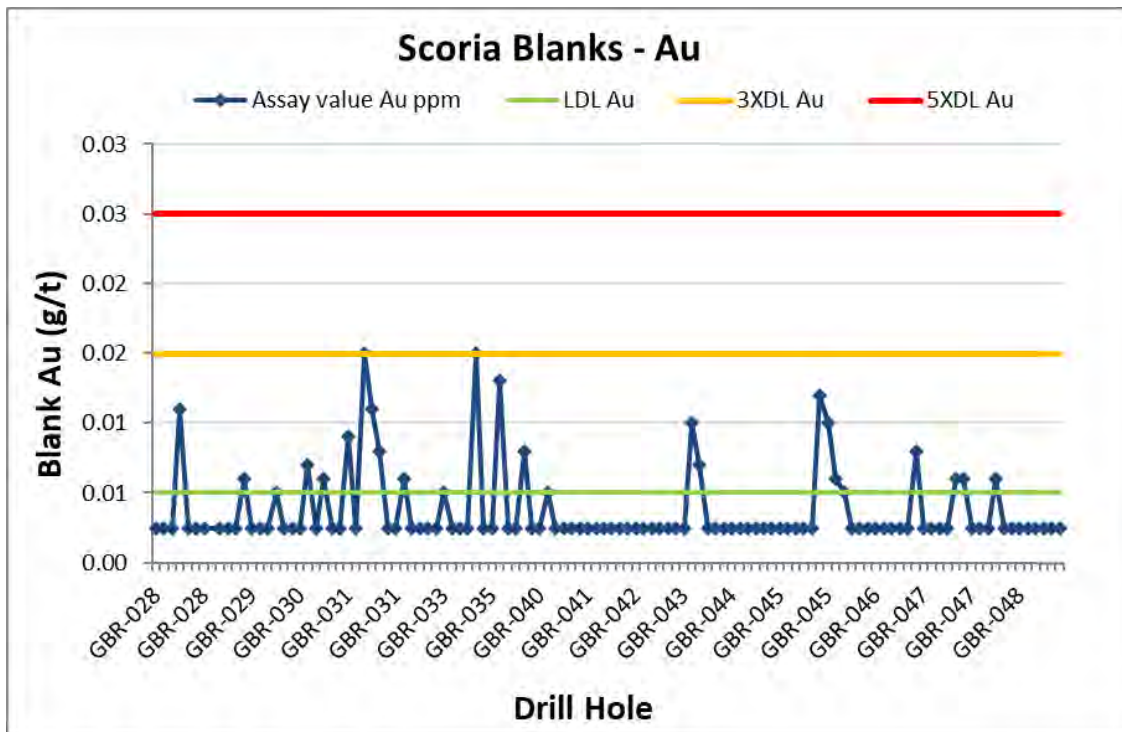

Source: P&E (2022)

Figure 11-7 Performance of Scoria Blanks Au at ALS for Phase 2 Drilling

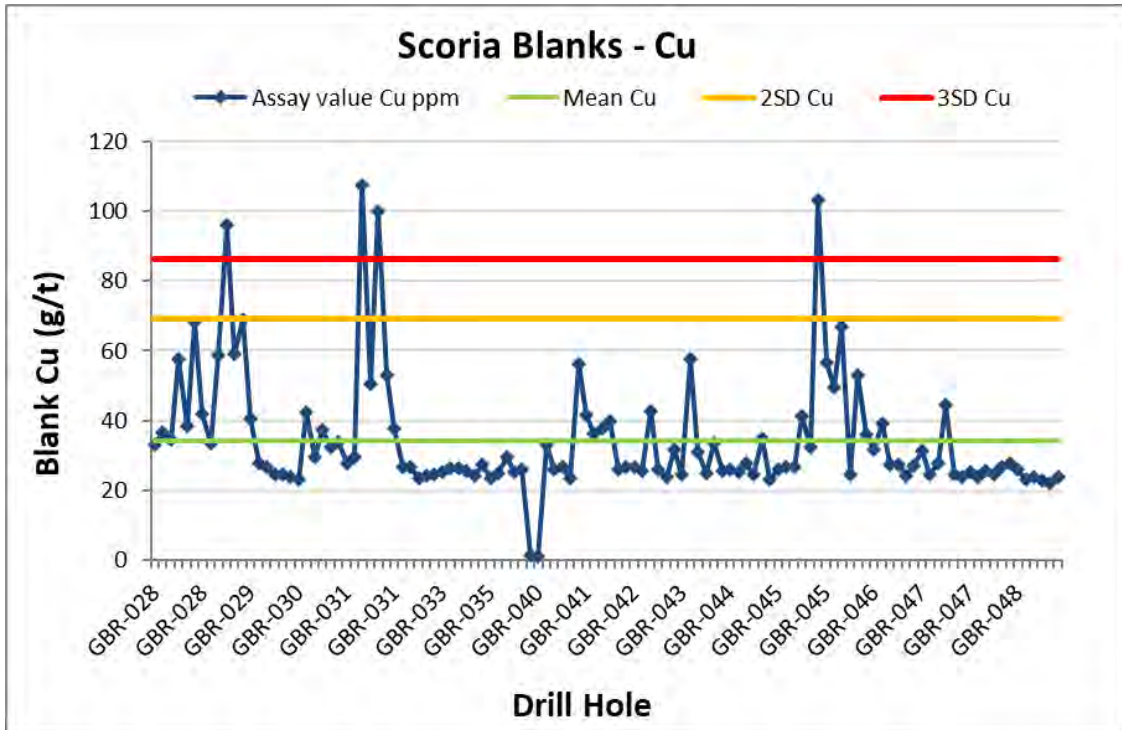

Source: P&E (2022)

Figure 11-8 Performance of Scoria Blanks Au at ALS for Phase 2 Drilling

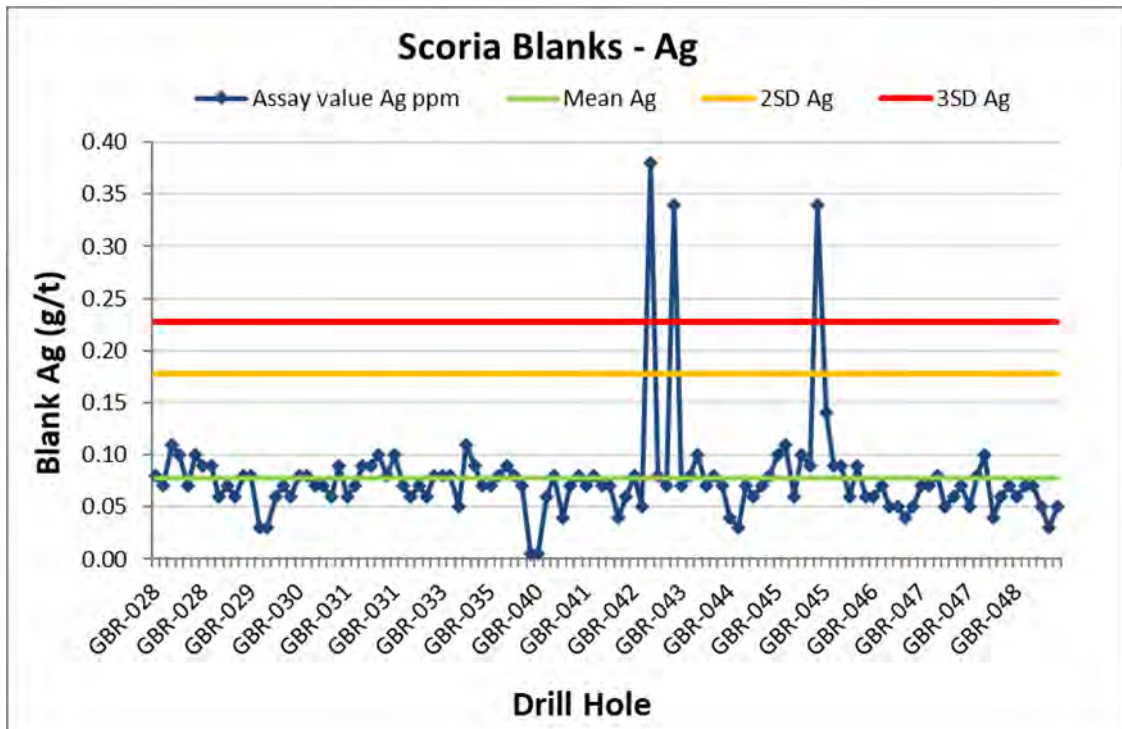

Source: P&E (2023)

Figure 11-9 Performance of Scoria Blanks Ag at ALS for Phase 2 Drilling

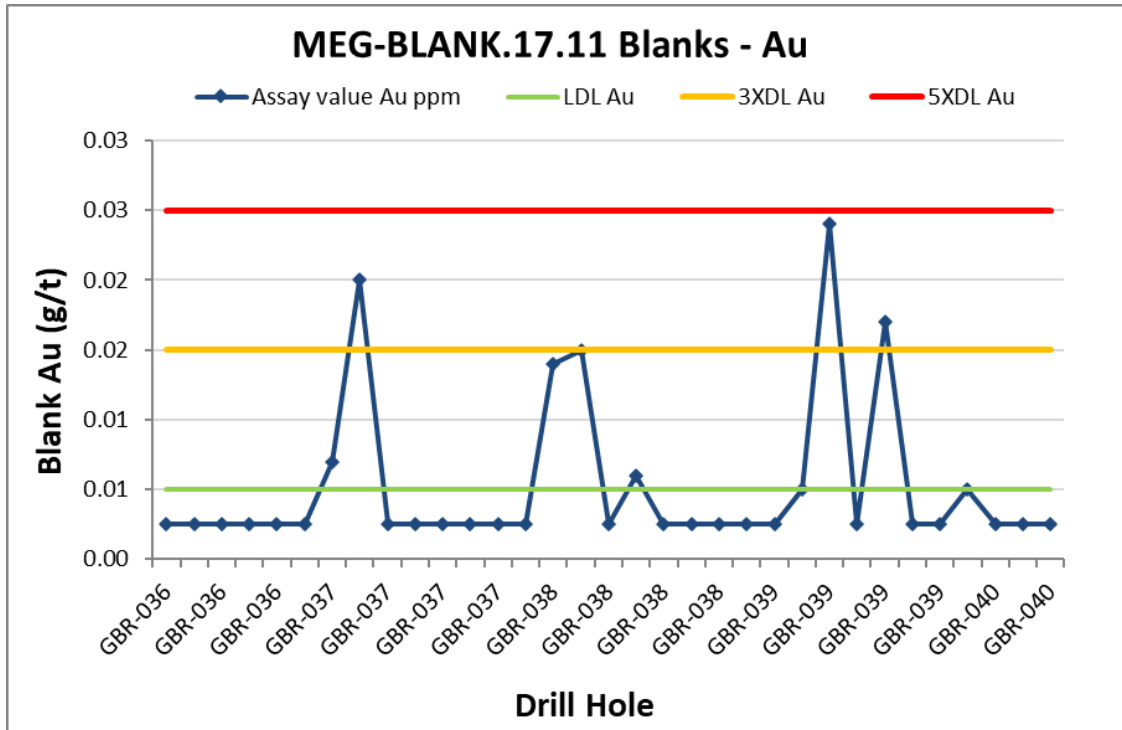

Source: P&E (2022)

Figure 11-10 Performance of MEG-BLANK.17.11 Au at ALS for Phase 2 Drilling

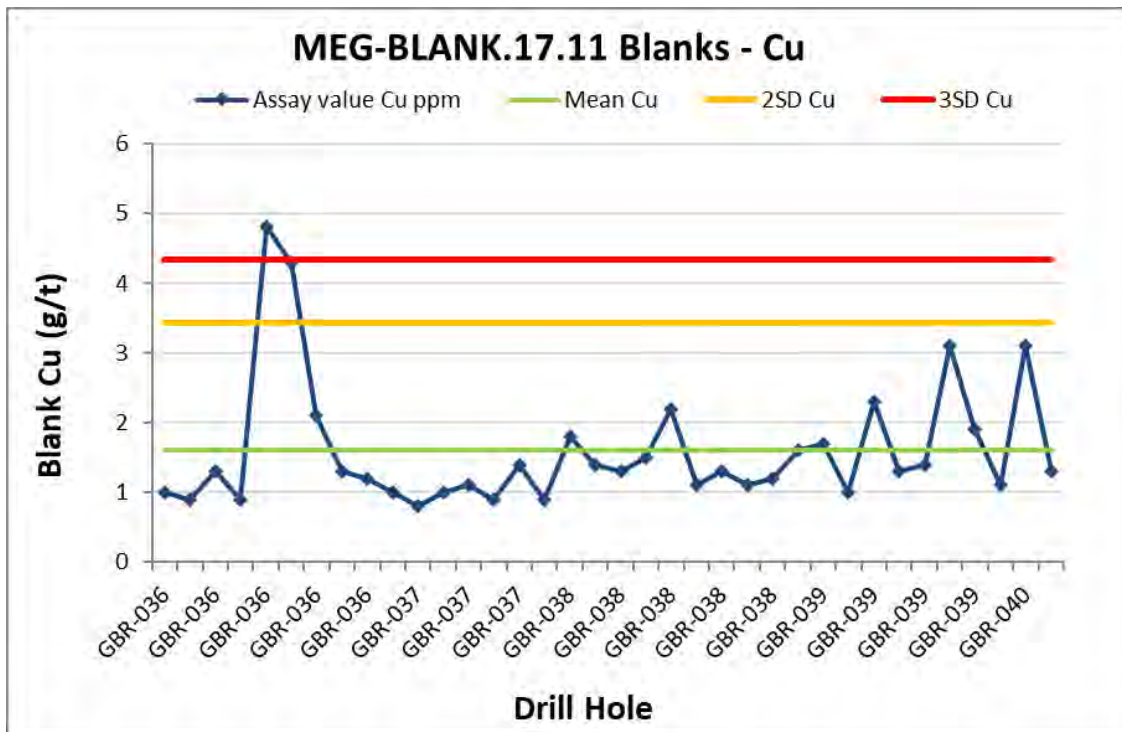

Source: P&E (2022)

Figure 11-11 Performance of MEG-BLANK.17.11 Cu at ALS for Phase 2 Drilling

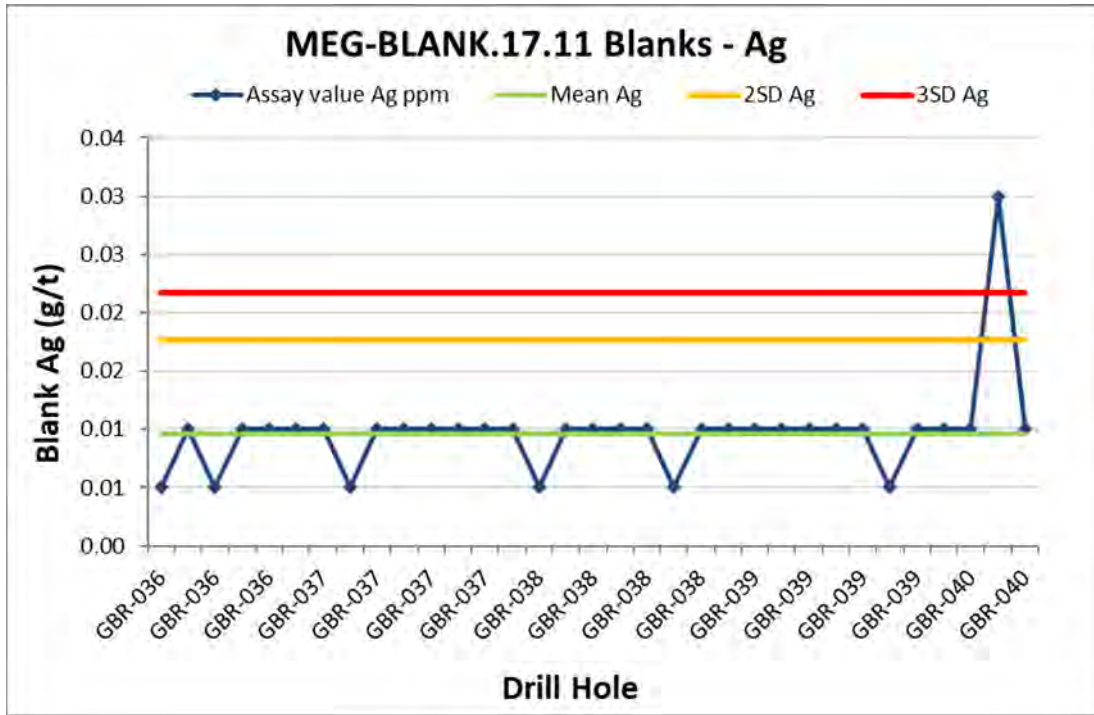

Source: P&E (2022)

Figure 11-12 Performance of MEG-BLANK.17.11 Ag at ALS for Phase 2 Drilling

11.4.4.3 Performance Of Duplicates

Preparation and pulp duplicate data for gold and copper were examined for the 2021/22 Phase 2 drill program at the Gabbs Property. P2 Gold automated the preparation stage sample duplication process with ALS, by requesting the lab to cut a second split for every sample ending in 06, 26, 46, 66, and 86. The Company established a failure criterion whereby 90% of the pairs have <10% relative difference between the original and duplicate assay.

A total of 148 gold, silver and copper prep duplicates and 264 gold pulp duplicates and 130 copper pulp duplicates were assessed for the Phase 2 drill program. Data were plotted on scatter charts (Figure 11-13 through Figure 11-17) and the “R² value for the gold duplicates estimated at 0.708 and 0.999 respectively, 0.998 for the silver prep duplicates, and 0.999 and 1 respectively for the copper duplicates.

Copper precision evaluation again illustrates excellent correlation between primary and duplicate copper results with an R² very near to 1 for both the prep and pulp duplicates, and an R² of 0.998 for the silver prep duplicates also indicates excellent precision. Gold samples again show poor precision and a great deal of variability in scatter performance (Figure 11-13). The CV_{AVE} for gold and copper were also calculated by the Author, with gold precision separated by deposit for all gold samples. Table 11-3 details CV_{AVE} values for the prep and pulp duplicates and indicate excellent precision for copper, with CV_{AVE} estimated at 5.2% and 4.1% for the prep

and pulp duplicates, respectively. Due to the poor precision in the gold data shown at the prep duplicate level, data were calculated separately for each deposit. The Sullivan and Lucky Star Deposits reveal significant improvement from prep to pulp level, with CV_{AVE} values in the acceptable range. The Carbody Deposit displays less improvement from prep to pulp level, with a CV_{AVE} of 32.9% for the prep duplicates and 28.6% for pulp duplicates, indicating that current laboratory protocol might be improved. The Author recommends follow up with the lab and modifying to a more suitable protocol (as discussed in earlier phases of the Project). Recommendation is also made to analyse all likely mineralized samples at the Carbody Deposit by metallic screening procedure.

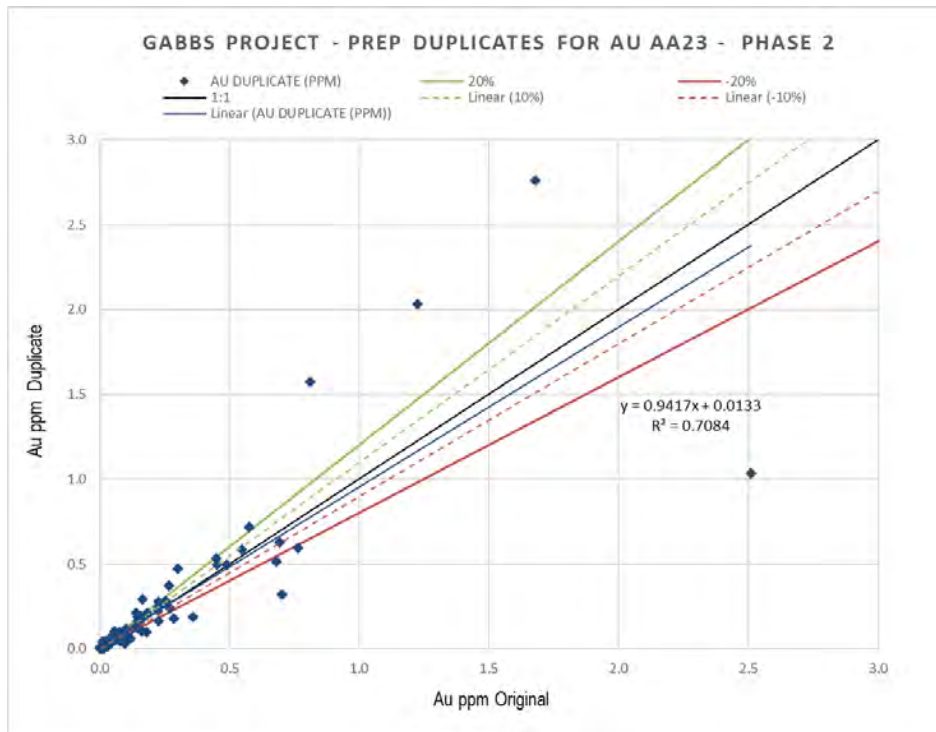

Source: P&E (2022)

Figure 11-13 Scatter Performance of Au Reject Duplicates at ALS for Phase 2 Drilling

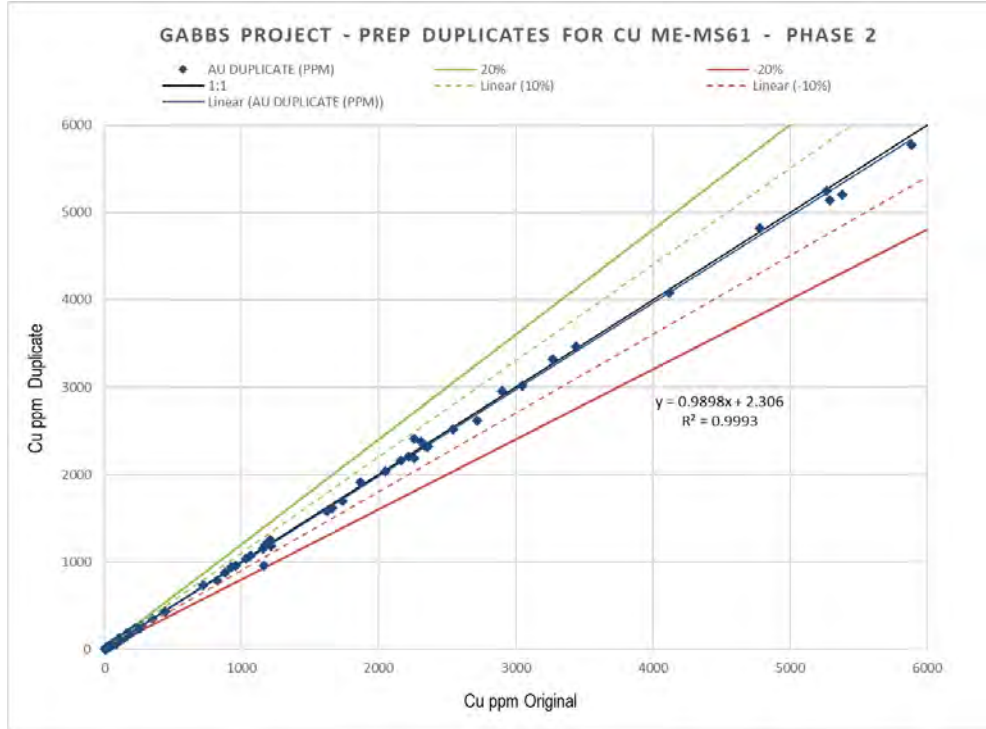

Source: P&E (2022)

Figure 11-14 Scatter Performance of Cu Reject Duplicates at ALS for Phase 2 Drilling

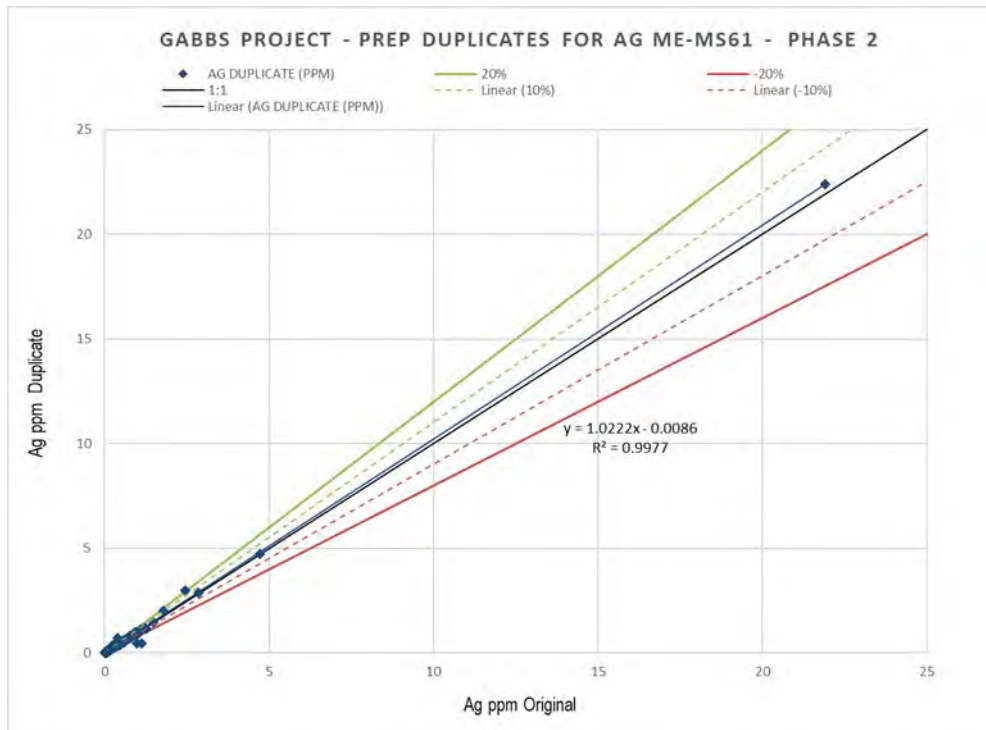

Source: P&E (2023)

Figure 11-15 Scatter Performance of Ag Reject Duplicates at ALS for Phase 2 Drilling



Source: P&E (2022)

Figure 11-16 Scatter Performance of Au Pulp Duplicates at ALS for Phase 2 Drilling

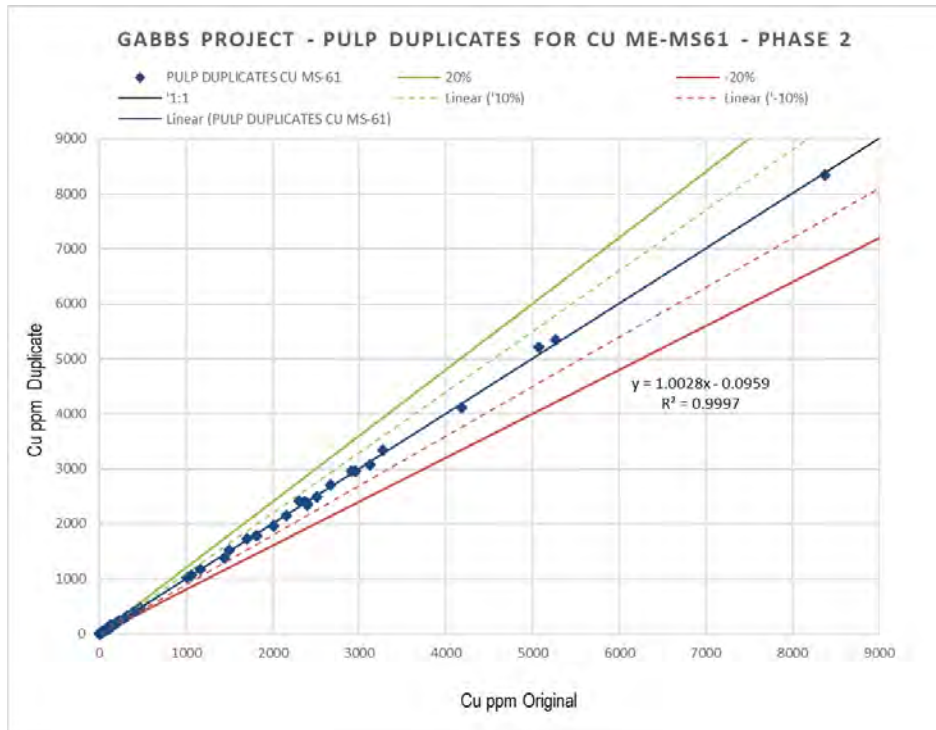

Source: P&E (2022)

Figure 11-17 Scatter Performance of Cu Pulp Duplicates at ALS for Phase 2 Drilling

Table 11-3
CV_{AVE} Precision Estimation

DUPLICATE TYPE	Au AA-23			Cu ME-MS61
	SULLIVAN	LUCKY STRIKE	CARBODY	DEPOSITS COMBINED
PREP	19.0	25.5	32.9	5.2
PULP	12.5	8.1	28.6	4.1

Source: P&E (2022)

11.4.4.4 Check Assaying

P2 Gold carried out an umpire sampling program on a selection of the 2021 to 2022 Phase 1 and 2 drill samples, to verify the primary lab’s (ALS) results. Samples from all 54 Phase 1 and 2 drill holes were chosen. A total of 319 pulp samples (from 20 partial drill core samples and 299 chip samples) from the 2021/22 drilling were umpire assayed at American Assay Laboratories of Sparks, Nevada (“AAL”) using equivalent techniques. The umpire assays represent 5.6% of the Phase 1 and 2 drill samples.

The Author reviewed the umpire assay results, and comparisons were made between the primary lab results and the umpire lab results with the aid of scatter plots (Figure 11-18 and Figure 11-19). The copper samples display excellent repeatability with an R² value of 0.9963 and data that plots close to the 1:1 line. As expected, check assay results for gold display less reproducibility than the copper results and return a reasonable R² value of 0.7914 (with results 15 times the lower detection limit and lower removed from the data). The AAL results confirm the tenor of the original gold mineralization and show acceptable reproducibility on a global scale, however, there is potential for material impacts locally given the poor reproducibility.

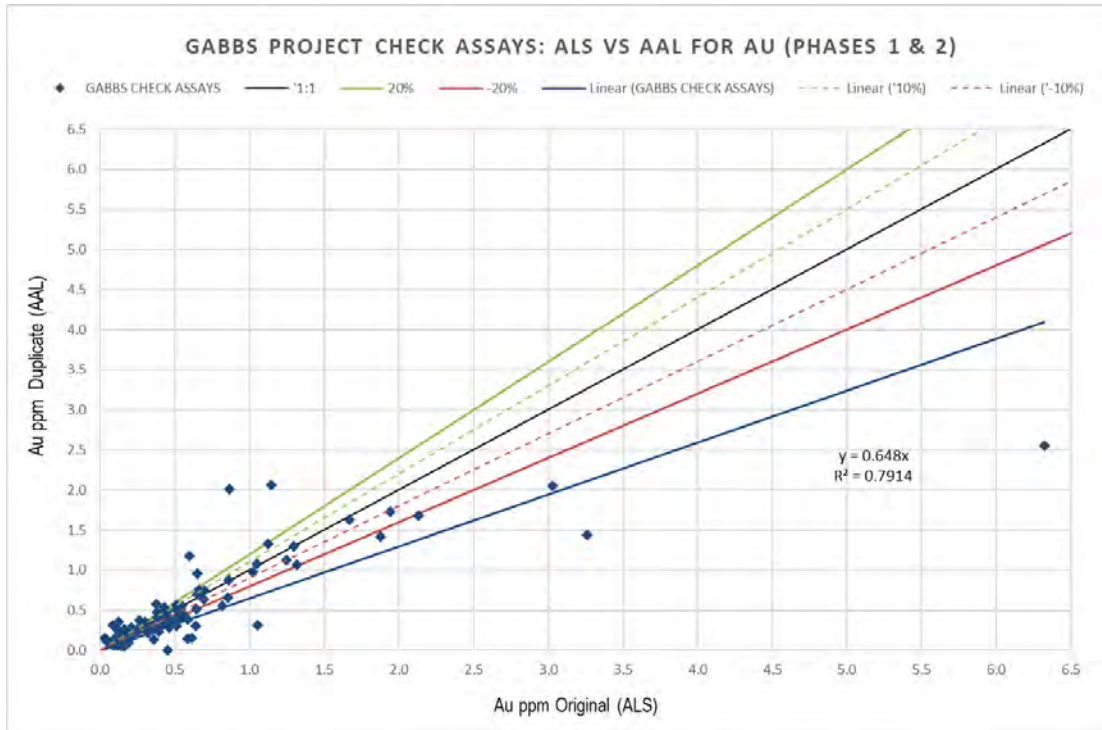

Source: P&E (2022)

Figure 11-18 Phase 1 & 2 Drilling Umpire Sampling Results for Au

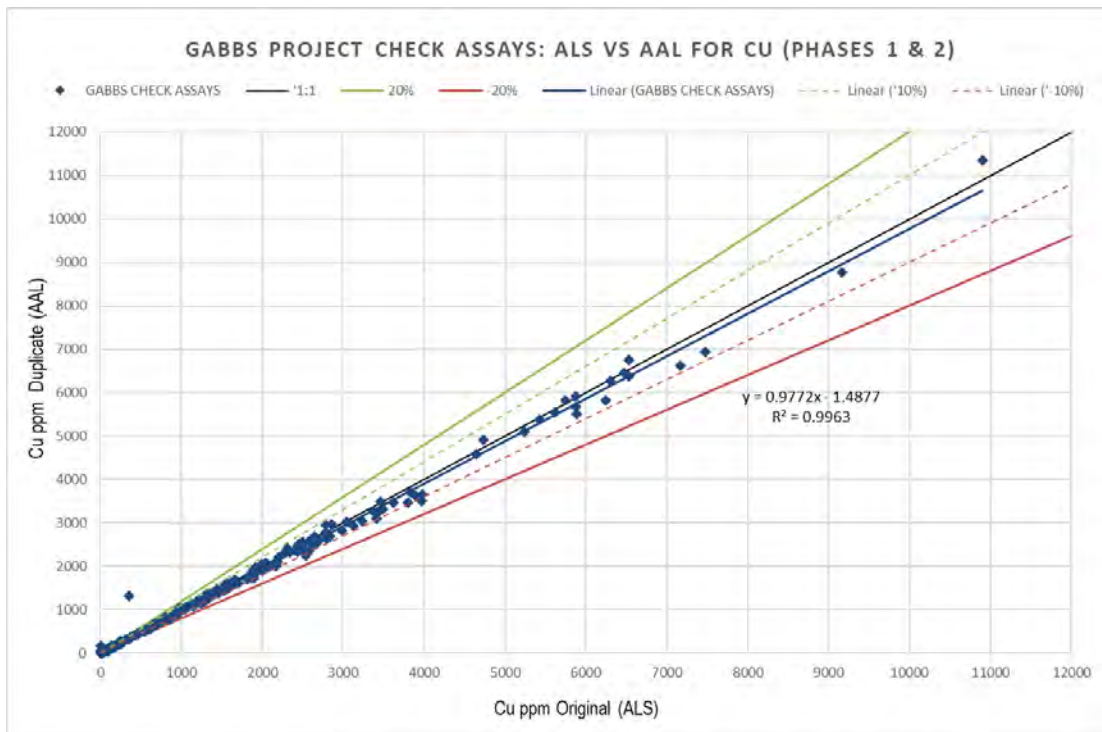

Source: P&E (2022)

Figure 11-19 Phase 1 & 2 Drilling Umpire Sampling Results for Cu

11.5 Bulk Density

P2 Gold collected a total of 253 bulk density samples from drill core and RC chips by laboratory pycnometry from the Sullivan, Lucky Strike and Car Body Deposits. The bulk density measurements ranged from 2.32 t/m³ to 3.16 t/m³ with an average of 2.75 t/m³. Average values by domain are as follows:

- Sullivan: 2.80 t/m³
- Lucky Strike: 2.72 t/m³
- Car Body: 2.64 t/m³

No measurements were taken for the Gold Ledge Domain, and a value of 2.70 t/m³ was used for Gold Ledge, which corresponds to the monzonite bulk density used previously by Newcrest.

A total of 85 independent verification samples were collected by the Authors during two separate site visits to the Property in October 2021 and June 2022 and bulk density measurements were undertaken on all samples at either Actlabs or ALS. A comparison between P2 Gold’s database results and the Author's independent verification samples is given in Table 11-4. The Author considers there to be good correlation between the two data sets, with the verification samples averaging marginally higher than the original samples, except at Car Body where verification sampling consisted of two samples only.

**Table 11-4
Summary of Bulk Density Measurements At Gabbs Project (t/m³)**

DEPOSIT	P2 GOLD DATABASE				AUTHOR’S SITE VISIT SAMPLES			
	NO. OF SAMPLES	MINIMUM	MAXIMUM	AVERAGE	NO. OF SAMPLES	MINIMUM	MAXIMUM	AVERAGE
ALL	253	2.32	3.16	2.75	85	2.48	3.23	2.83
SULLIVAN	176	2.32	3.16	2.80	63	2.48	3.23	2.85
LUCKY STRIKE	49	2.48	2.99	2.72	20	2.59	3.08	2.77
CAR BODY	28	2.45	2.83	2.64	2	2.7	2.76	2.73

Source: P&E (2022)

11.6 Conclusions

It is the opinion of the Author that sample preparation, security and analytical procedures for the Gabbs Property drill programs were adequate and that the data are satisfactory for use in the current Mineral Resource Estimate.

The Author recommends continuing all current sample preparation, security and analytical protocol at the Project, with the exception of modifying to a more suitable laboratory protocol for the Car Body Deposit samples. Recommendation is made to analyse all likely mineralized samples at the Car Body Deposit by metallic screening procedure.

12.0 DATA VERIFICATION

12.1 Drill Hole Database

12.1.1 Assay Verification

12.1.1.1 February 2022 Assay Verification

The Authors conducted verification of the Gabbs Project drill hole assay database for gold, silver and copper by comparison of the database entries with assay certificates, downloaded directly from the ALS Webtrieve™ site, in comma-separated values (csv) format.

Assay data from 2021 Phase 1 drilling were verified for the Gabbs Project. All 1,898 constrained samples were verified for gold and copper. No errors were encountered during the verification process.

12.1.1.2 July 2022 Assay Verification

The Authors again conducted verification of the Gabbs Project drill hole assay database for gold, silver and copper in July 2022. Assay certificates were again downloaded in comma-separated values (csv) format, directly from the ALS Webtrieve™ site, and comparison of the database entries were made against the downloaded certificates.

A total of 3,787 samples from the 2022 Phase 2 drilling were imported into the database subsequent to the February 2022 verification undertaken by the Author. All 3,787 samples were verified for gold and copper and no errors were encountered in the Phase 2 data.

12.1.1.3 September 2023 Assay Verification

In September of 2023, the Authors undertook verification of the Gabbs Project Phase 1 and 2 drill hole assay database for silver by comparison of the database entries against the ALS Webtrieve™ downloaded certificates. All 2,818 Phase 1 and 2 constrained samples were verified for silver, with some minor discrepancies, of no material impact, observed in the data.

12.1.1.4 Database Validation

As described in Section 14 of this Technical Report, the drill hole database was reviewed with P2 Gold staff. The Authors reviewed original drill hole logs, assay results and internal reports against the compiled database. Multiple drill hole collars were also located in the field. For the historical Amoco series of drill holes, the original geological logs were not located; however, assay results and maps showing drill hole collar locations were available. The general tenor of

mineralization for these drill holes was compared to later stage drilling results and found to be comparable.

Industry standard validation checks were completed on the client supplied databases. The Author typically validates a Mineral Resource database by checking for inconsistencies in naming conventions or analytical units, duplicate entries, interval, length or distance values less than or equal to zero, blank or zero-value assay results, out-of-sequence intervals, intervals or distances greater than the reported drill hole length, inappropriate collar locations, and missing interval and coordinate fields. No significant validation errors were observed.

As a further check on the supplied drill hole database, the Authors recompiled Newcrest, St. Vincent Minerals and P2 Gold assay data from the original assay certificates.

12.2 Site Visit and Independent Sampling

12.2.1 2011, 2019 and 2021 P&E Site Visits and Independent Sampling

Mr. Fred Brown, P.Geo., on behalf of P&E, visited the Gabbs Property from May 31 to June 2, 2011, for the purpose of completing a site visit that included viewing drilling sites and outcrops, GPS location verifications, discussions, and independent verification sampling. The drill core from the Property was examined and 19 samples were taken from 11 drill holes during the 2011 site visit. Drill core was sampled by taking the remaining half drill core in the box and effort was made to sample a range of grades. Mr. Brown also visited the Property area on September 13, 2019, on behalf of P&E, however, he did not undertake further verification sampling since no new drilling had occurred since his last site visit.

The Gabbs Property was visited by Mr. David Burga, P.Geo., of P&E, on October 5, 2021, for the purpose of completing a site visit that included viewing drilling sites and outcrops, GPS location verifications, discussions, and independent verification sampling. During the October 2021 visit, Mr. Burga took 11 drill core samples from four of the 2021 diamond drill holes. Seven of the 11 drill core samples were sampled by taking the remaining half drill core in the drill core box and four were sampled from stored coarse reject samples. Mr. Burga also took 34 chip samples from 15 of the 2021 RC drill holes, which were split from the remaining bagged reject material.

At no time were any Project employees advised as to the identification of the samples to be chosen during the site visits. The samples selected by Mr. Brown and Mr. Burga were placed into sample bags, which were sealed with tape and placed in rice bags. The 2011 drill core samples were brought by Mr. Brown to ALS in Reno, Nevada for analysis. The 2021 drill core and RC chip samples were brought by Mr. Burga to Actlabs in Ancaster, Ontario (Canada) for analysis.

ALS has developed and implemented strategically designed processes and a global quality management system at each of its locations that meets all requirements of International Standards ISO/IEC 17025:2017 and ISO 9001:2015. All ALS geochemical hub laboratories are accredited to ISO/IEC 17025:2017 for specific analytical procedures.

The Actlabs Quality System is accredited to international quality standards through ISO/IEC 17025:2017 and ISO 9001:2015. The accreditation program includes ongoing audits, which verify the QA system and all applicable registered test methods. Actlabs is also accredited by Health Canada.

Both ALS and Actlabs are independent of P&E and P2 Gold.

Gold samples at ALS were fire assayed and analysed using ICP finish. Copper was digested using four acids with an ICP analysis. Gold samples at Actlabs were analysed by fire assay with gravimetric finish. Silver and copper samples were analysed by total digestion with ICP-OES finish. Specific gravity measurements were also undertaken on all of the 2021 site visit samples. A comparison of the results is presented in Figure 12-1 through Figure 11-8.

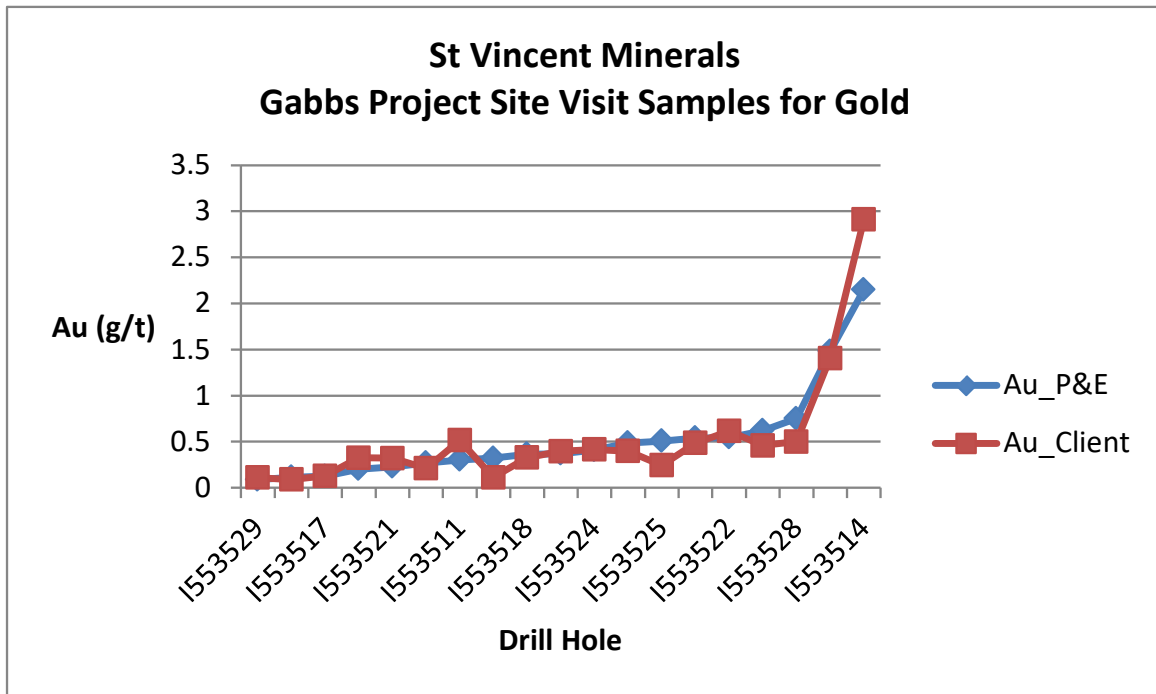

Source: P&E (2011)

Figure 12-1 2011 Site Visit Sample Results Comparison for Gold

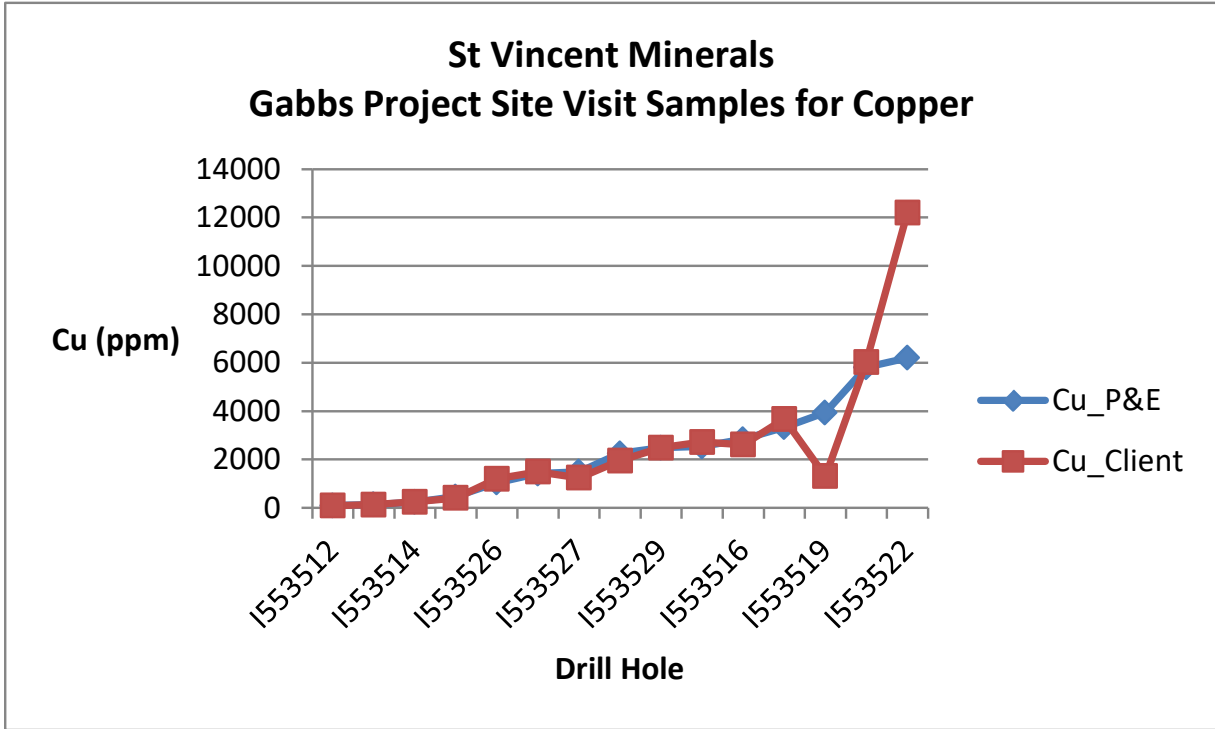

Source: P&E (2011)

Figure 12-2 2011 Site Visit Sample Results Comparison for Copper

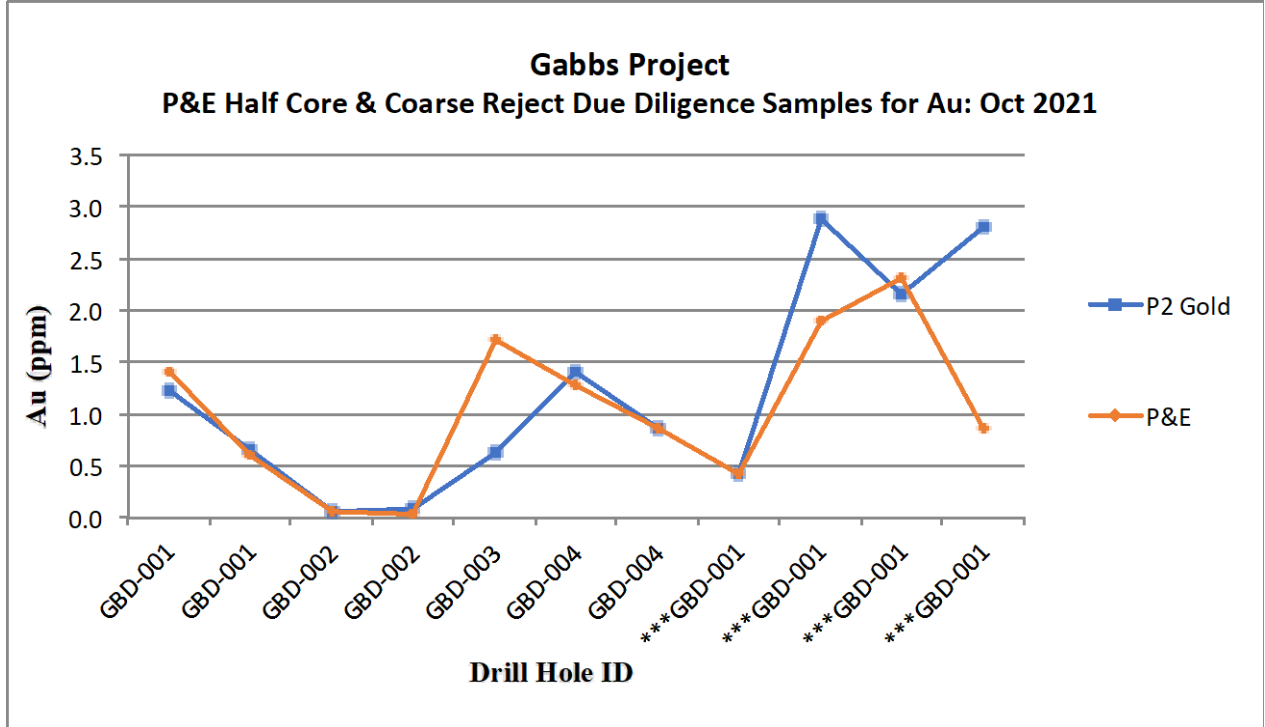

*** Course reject sample.

Source: P&E (2022)

Figure 12-3 2021 Site Visit DDH Sample Results Comparison for Gold

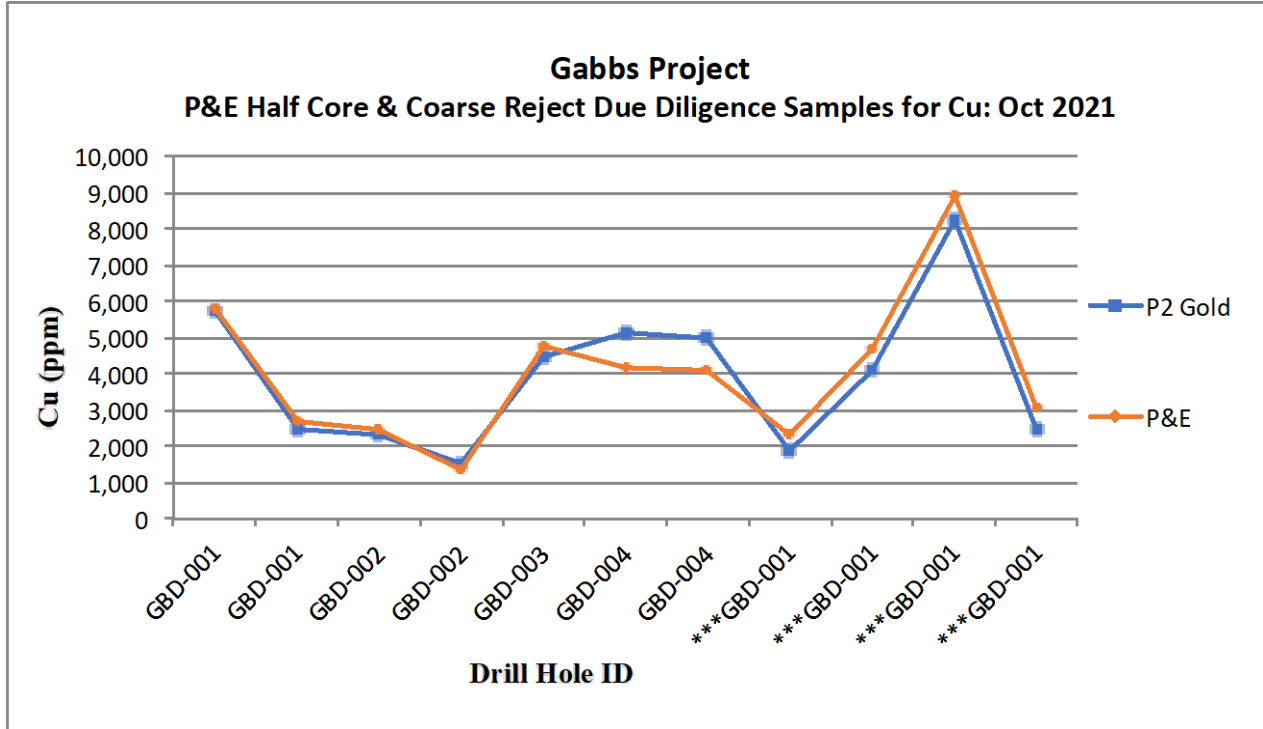

*** Course reject sample.
Source: P&E (2022)

Figure 12-4 2021 Site Visit DDH Sample Results Comparison for Copper

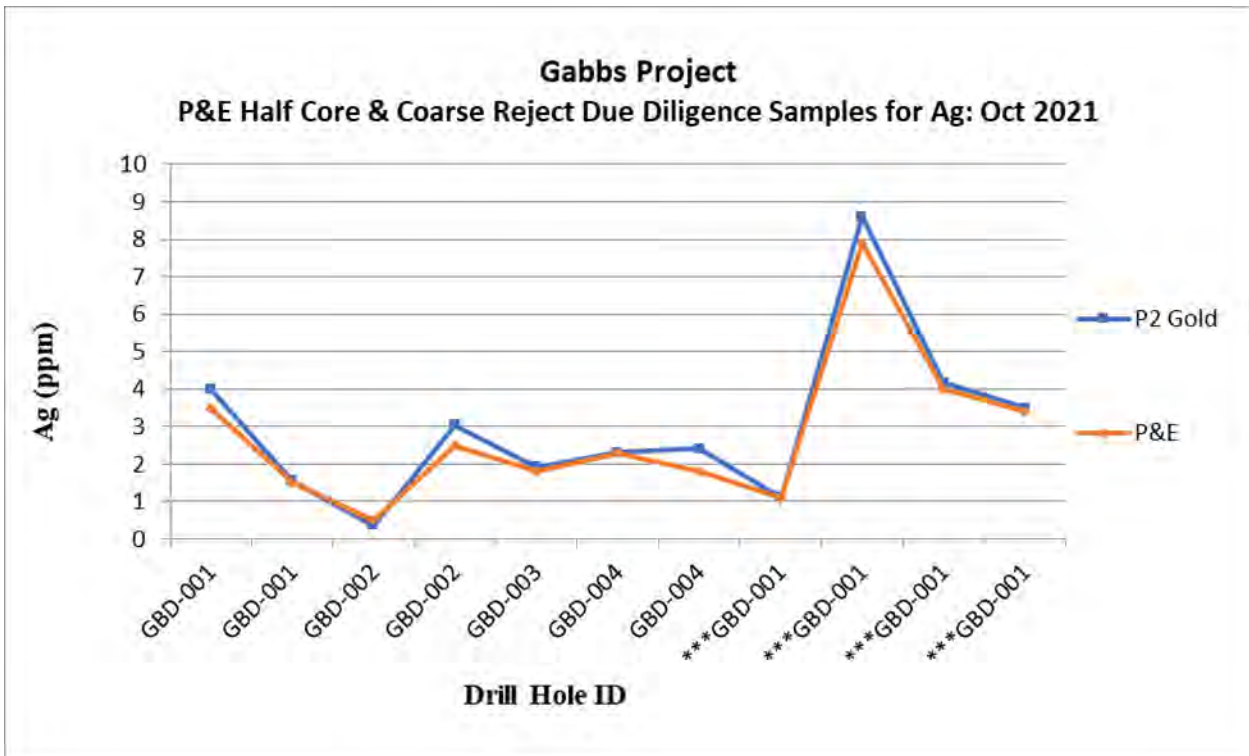

Source: P&E (2022)

Figure 12-5 2021 Site Visit DDH Sample Results Comparison for Silver

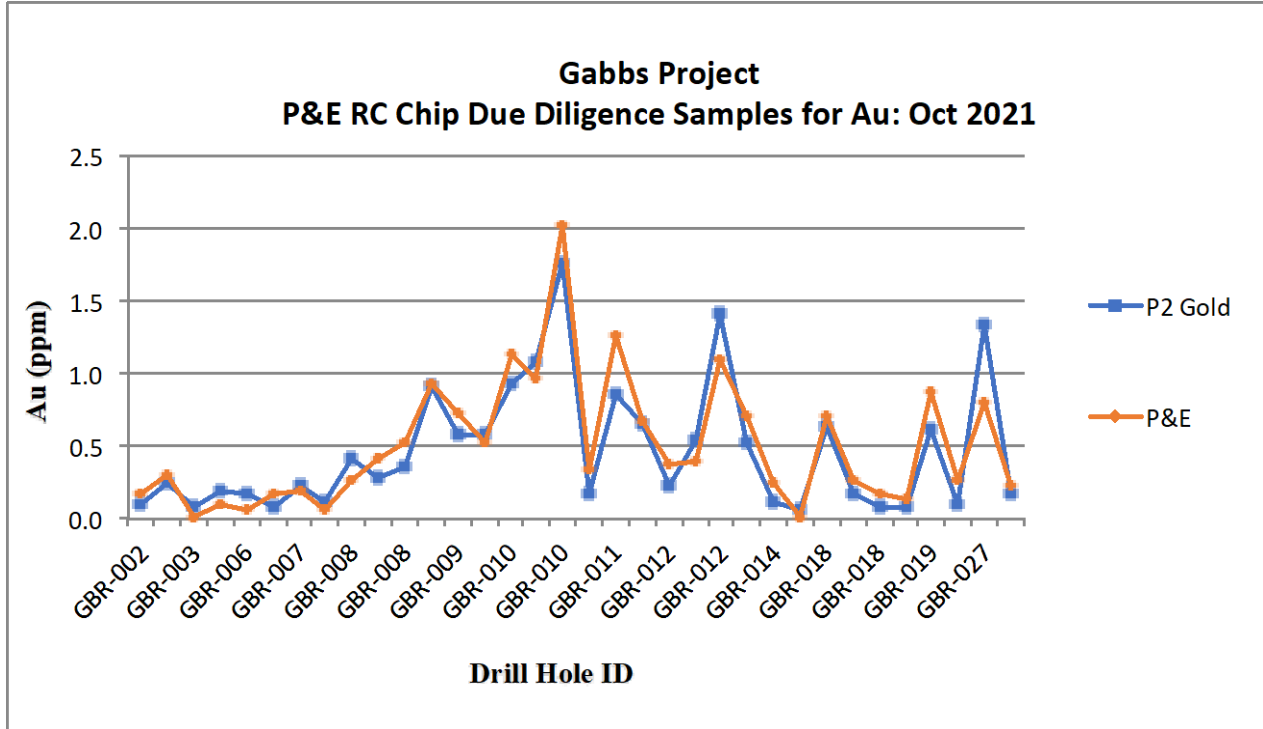

Source: P&E (2022)

Figure 12-6 2021 Site Visit RC Sample Results Comparison for Gold

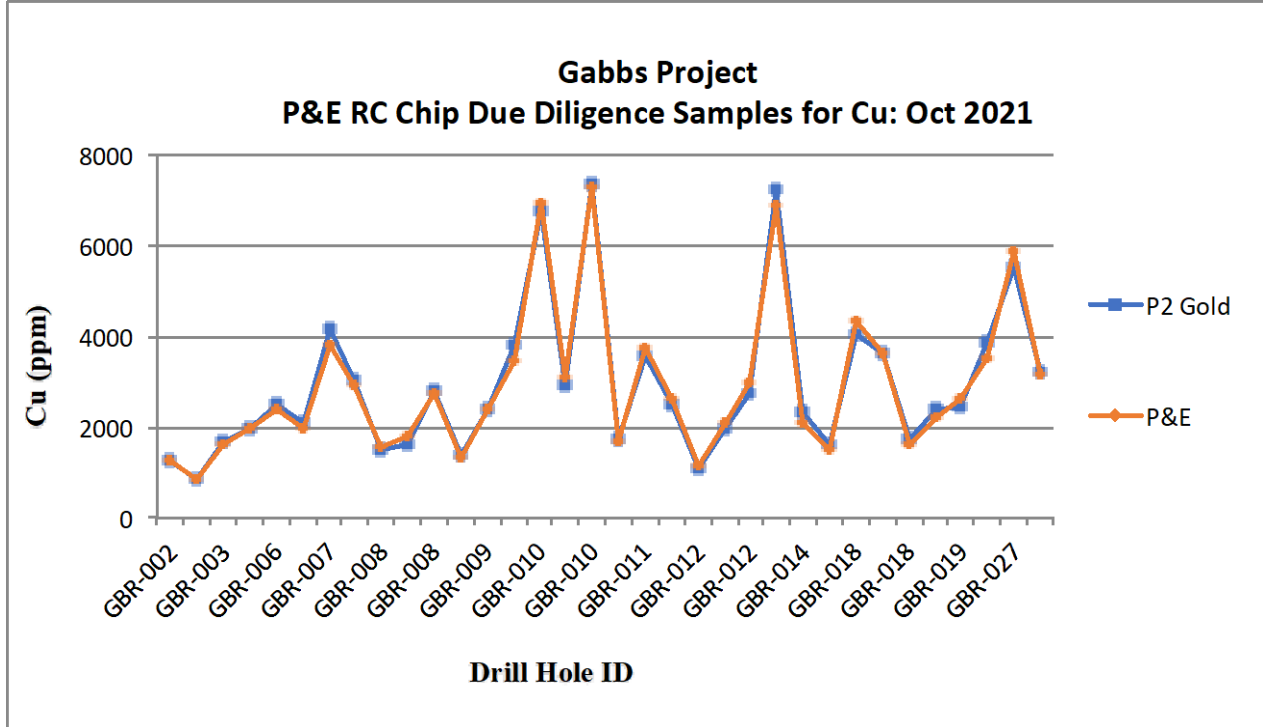

Source: P&E (2022)

Figure 12-7 2021 Site Visit RC Sample Results Comparison for Copper

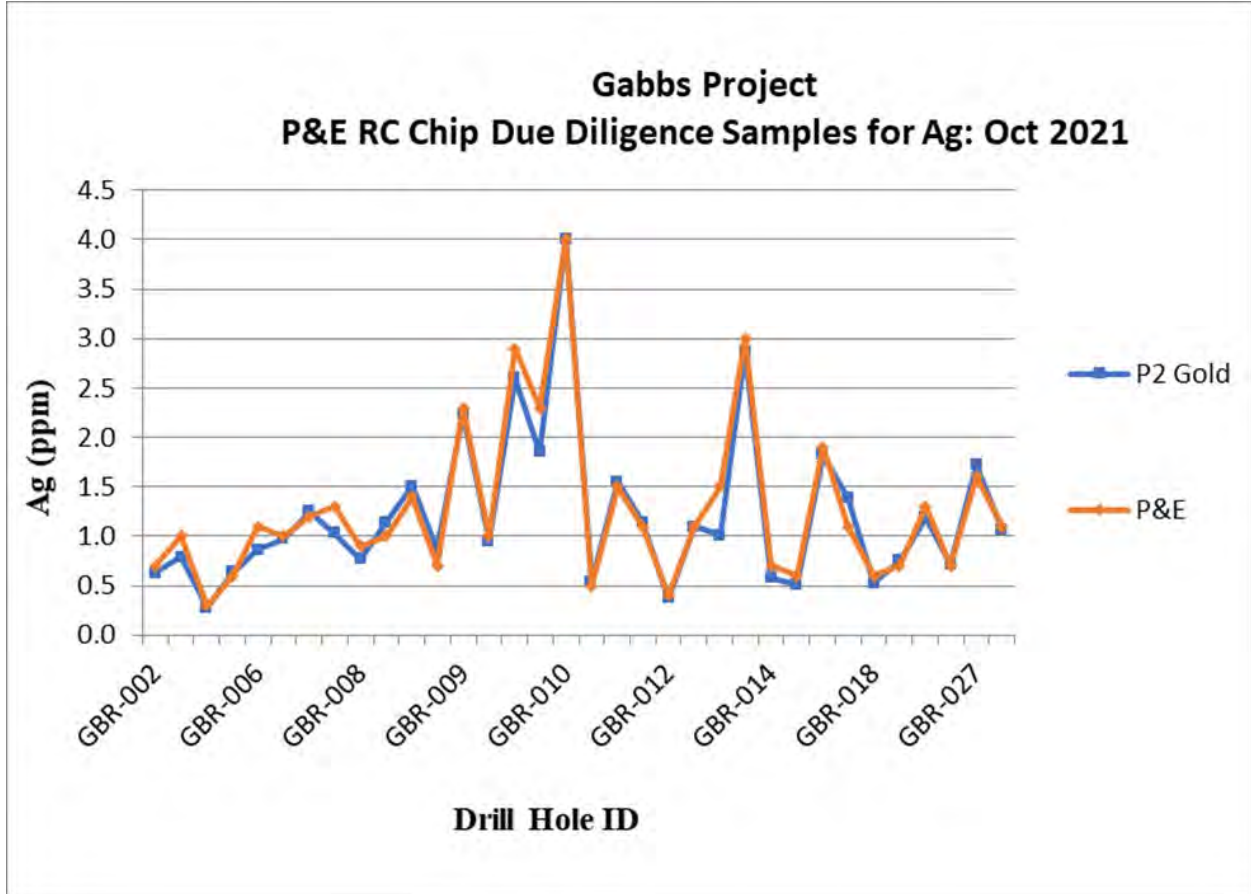

Source: P&E (2022)

Figure 12-8 2021 Site Visit RC Sample Results Comparison for Silver

12.2.2 2022 Verification Sampling

In June of 2022, the Author undertook verification sampling of a select subset of P2 Gold’s 2022 Phase 2 sampling data. The Author selected a total of 40 samples from 12 Project RC drill holes, from three deposit areas, including Sullivan, Lucky Strike and Car Body.

Final sample selection, covering a range of grades, was communicated to P2 Gold, who then instructed ALS to transfer the prepared pulp samples to Actlabs in Ancaster, Ontario, for comparative geochemical analysis.

The Actlabs’ Quality System is accredited to international quality standards through ISO/IEC 17025:2017 and ISO 9001:2015. The accreditation program includes ongoing audits, which verify the QA system and all applicable registered test methods. Actlabs is also accredited by Health Canada.

Gold samples at Actlabs were analysed by fire assay with gravimetric finish. Copper and silver samples were analysed by total digestion with ICP-OES finish. Density measurements were

also undertaken on all Phase 2 pulp samples, using ASTM D854 Specific Gravity on pulp by water pycnometer method. Comparison between the Authors verification results versus P2 Gold's pulp samples are presented in Figure 12-9 through Figure 12-11.

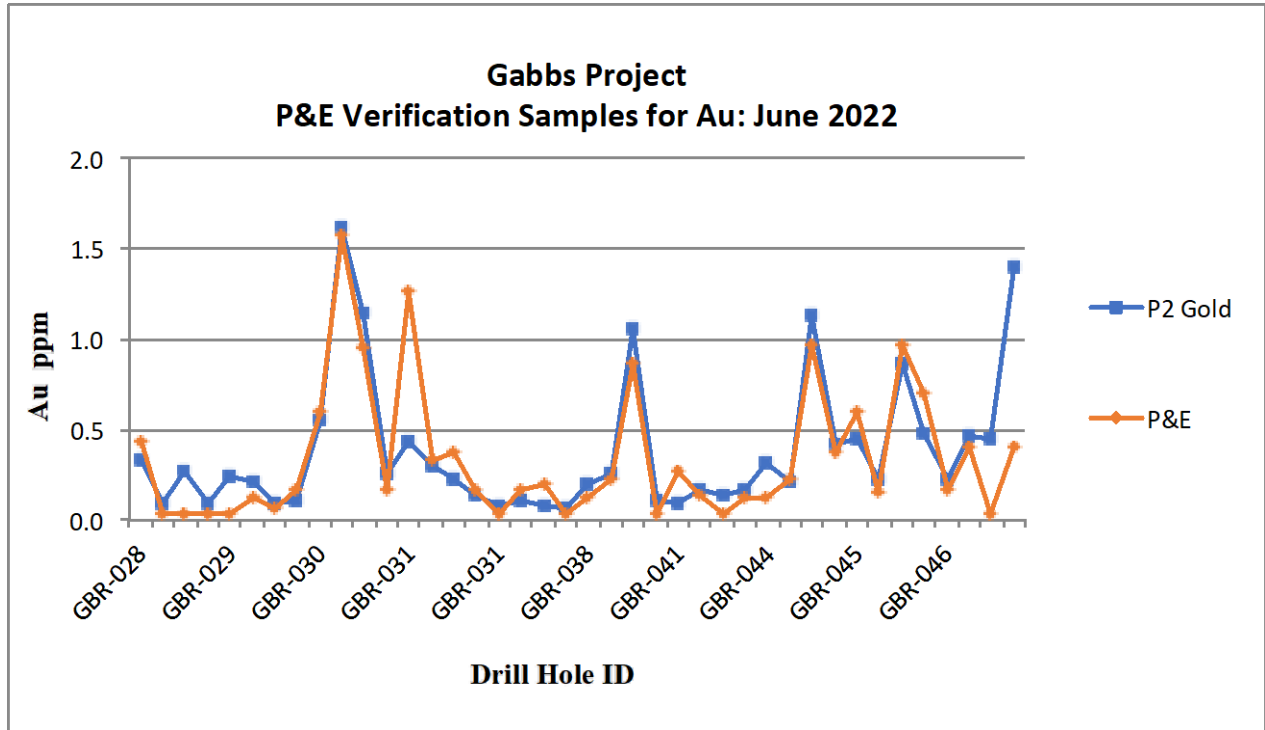

Source: P&E (2022)

Figure 12-9 2022 Phase 2 Verification Sample Results Comparison for Gold

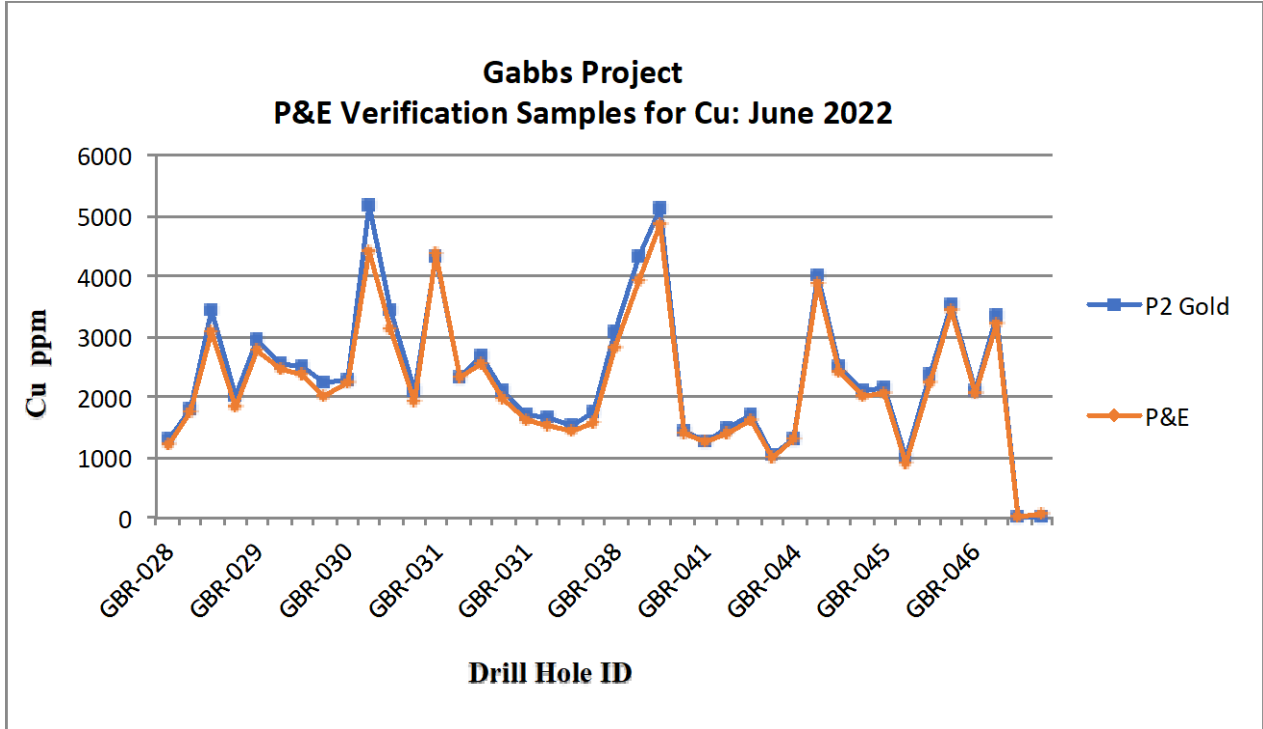

Source: P&E (2022)

Figure 12-10 2022 Phase 2 Verification Sample Results Comparison for Copper

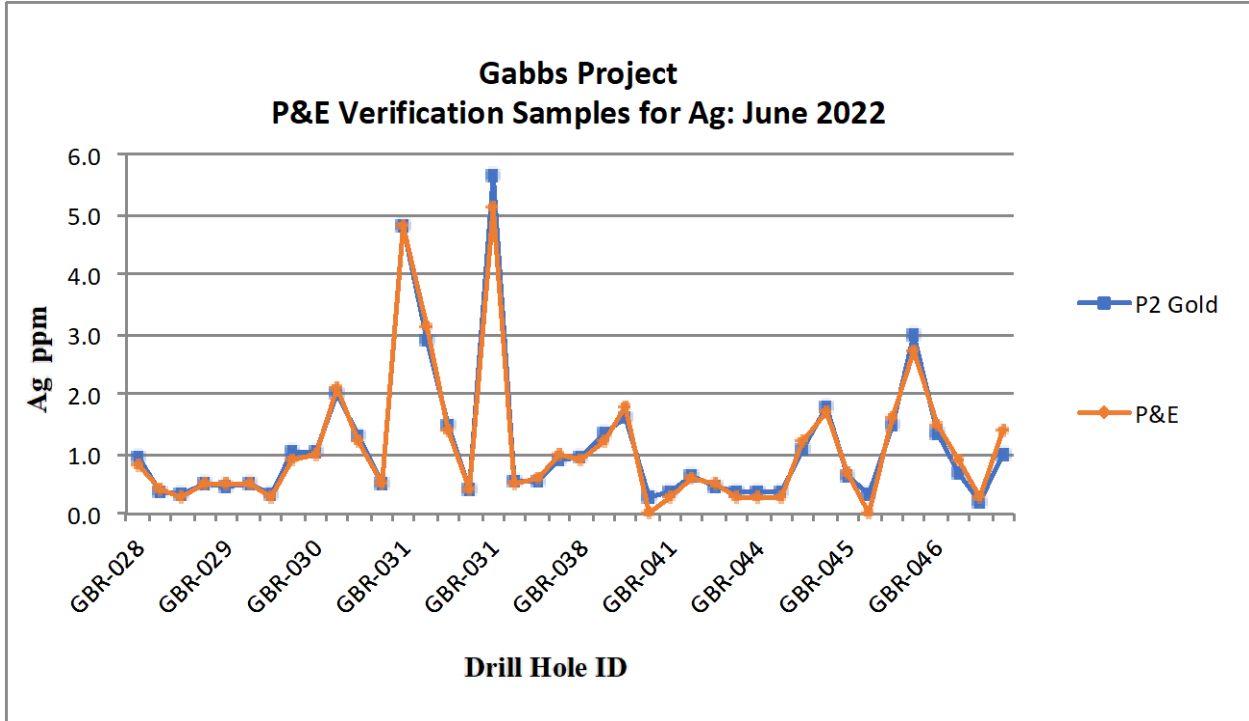

Source: P&E (2022)

Figure 12-11 2022 Phase 2 Verification Sample Results Comparison for Silver

12.3 Conclusion

The Authors consider that there is excellent correlation between the Cu and Ag assay values in the Gabbs Property database and the independent site visit and verification samples collected by the Authors that were analysed at ALS and Actlabs. The Authors also consider there to be acceptable correlation between the P2 Gold and the Authors Au assay data, considering the reproducibility issues encountered at the Project. The Authors are satisfied that sufficient verification of the Newcrest, St. Vincent Minerals and P2 Gold drill hole data has been undertaken and that the supplied data are of good quality and suitable for use in the current Mineral Resource Estimate for the Gabbs Property.

12.4 KCA Verification

KCA checked the metallurgical test procedures and results to ensure they met industry standards. Metallurgical sample locations were reviewed to ensure that there was material from the resource area and that the samples were reasonably representative with regards to material type and grade with the material planned to be processed so as to support the selected process method and assumptions regarding recoveries and costs.

13.0 MINERAL PROCESSING AND METALLURGICAL TESTING

KCA conducted a metallurgical review and summarized historical metallurgy for the Gabbs Project located in Nye County, Nevada, USA. A list of test reports, studies, and programs by various companies are presented in Table 13-1.

Historical testing on oxide, mixed oxide/sulphide, and sulphide materials were conducted on samples and composites made from bulk surface samples, reverse circulation, and core drill holes. The following were investigated:

- Direct cyanide heap leaching;
- Ground mineralized material cyanidation;
- Gold recovery by gravity separation;
- Gold and copper recovery by heavy liquid separation;
- Sequential/dual two-stage leach process; sulphuric acid leaching to remove copper with copper recovery by solvent extraction-electrowinning (SX-EW) followed by cyanide leaching to remove gold with gold recovery by activated carbon;
- Flotation of copper oxides and copper sulphides;
- Sequential flotation of copper sulphides followed by flotation of copper oxides;
- Cyanide leaching of ground material followed by flotation of cyanide tails for copper recovery;
- Non-traditional treatment by cyanidation with ammonia or ammonium salts, or thiocyanate leaching; and,
- Acid leaching copper.

Historically, very high cyanide consumptions were observed when cyanide soluble copper was leached and historical processes did not recover cyanide soluble copper. Therefore, direct cyanide leaching was not considered to be an economically viable process.

The Sulphidization, Acidification, Recycle, Thickening (“SART”) process was developed after 1996, and is the modern commercially established process for recovery of cyanide soluble copper. In the SART process, the solution is acidified with sulphuric acid and copper is precipitated as a saleable copper sulphide concentrate with sodium sulphide. The clarified solution is neutralized with lime, and cyanide is recovered for recycle to the leaching process. The recycle of regenerated cyanide has the potential to make gold recovery from high copper containing gold/copper materials economically viable.

Relevant historical and current metallurgy is summarized in the sections below and form the metallurgical basis for this Preliminary Economic Assessment.

**Table 13-1
Historical and Current Metallurgical Reports**

Reference No.	Company	Year	Lab	File Name (.pdf)
1	Cyprus	1982	Cymet	Cyprus_Flotation and leach testing
2		1983	Cyprus	Cyprus_Project termination report_metallurgy section
3	Placer U.S., Inc.	1984	Placer	Metallurgy section in 1984 report
4		1985	DB&O Inc.	DB&O_Gravity concentration test
5		1985	Kappes, Cassidy & Assoc.	Kappes bottle roll tests
6		1985	Placer	Metallurgy section in 1985 report
7		1986	Placer	Metallurgy section in 1986 report
8	Glamis/Cuervo	1988	Cuervo	Cuervo Sullivan Executive Summary Preliminary Economic Assessment
9		1988	Cuervo	Cuervo Sullivan Plan of Operations 1988
10		1988	Metals Research Corp. (MRC)	MRC_Flooded column leach tests
11		1988	Cuervo	Sullivan Environmental Assessment 1988
12	Gwalia	1990	GUSA	GUSA_Bottle roll tests
13		1990	Pincock, Allen & Holt	PAH_metallurgy tests
14		1990	GUSA	Review of previous work_Cyprus_Placer_Glamis
15		1990	GUSA	Gwalia_Sullivan Pre-Preliminary Economic Assessment_1990
16		1991	Mineral Resource Development, Inc. (RDI)	RDI_Heavy liquid, grind, flotation, gravity tests
17		1992	N.A. Degerstrom (NAD)	NAD_Met tests
18		1992	N.A. Degerstrom (NAD)	NAD_Sullivan Ore Metallurgical Testwork_1992
19		1994	N.A. Degerstrom (NAD)	NAD_Met tests_1994
20		Arimetco	1995	Kappes, Cassidy & Assoc.
21	1995		Arimetco	Arimetco_Sullivan Pre-Preliminary Economic Assessment_1995
22	1996		Kappes, Cassidy & Assoc.	Kappes head screen and bottle roll results
23	1996			Kappes large acid leach column results
24	1996			Kappes met reports correspondence
25	1996			Kappes small acid column leach test results
26	1996			Kappes small column test results
27	1996		Mineral Resource Development, Inc. (RDI)	MRDI prelim met testing
28	1996		Arimetco	Arimetco_Sullivan Plan of Operations_1996
29	1996		Arimetco	Arimetco_Sullivan POO_Appendix E and F_Metallurgy
30	P2 Gold Inc.	2021	Base Metallurgical Laboratory Ltd.	Excel Files
31		2022	Kappes, Cassidy & Assoc.	KCA0210121_GAB01_03

13.1 Cyprus (1982) – Cymet Laboratory – Flotation and Leach Results

Cyprus Metallurgical Processes Corporation, (“Cyprus”), evaluated:

- Flotation of copper oxide by sulphidization followed with cyanidation of flotation tails to recover gold;
- Sequential copper sulphide flotation followed by copper oxide flotation with cyanidation of flotation tails;
- Sulphuric acid leaching of copper followed by cyanide leaching for gold; and,
- Direct cyanide leaching of gold.

The first sample received was designated Lot 31882 (Sample 1). After compositing, the sample was stage crushed to minus 1,700 µm and a sample split for head analysis. The second sample received was designated Lot 61082 (Sample 2). The sample was stage crushed to minus 12,700 µm with a jaw crusher. Sample 1 assayed 0.95 g/t Au, 3.8 g/t Ag, 0.39% Cu, and 0.24% Cu oxide. Sample 2 assayed 0.6 g/t Au, 2.0 g/t Ag, 0.29% Cu, and 0.25% Cu oxide. Microscopic examination of Sample 1 revealed the presence of the copper minerals malachite and native copper, which are soluble in sodium cyanide.

13.1.1 Cyprus (1982) - Gold and Copper Flotation Prior to Cyanidation

Flotation tests were conducted on Sample 1 at a grind P₈₀ 150 µm with the flotation reagents potassium amyl xanthate (“PAX”), methyl isobutyl carbinol (“MIBC”), and sodium bisulphide (“NaHS”) for oxide copper sulphidization. The rougher tails were cyanide leached for additional gold recovery. Overall gold and copper recoveries were 95.8% and 71.1%, respectively. Sodium cyanide consumption was 0.92 kg/t.

Sample 1 was subsequently tested at three grinds of P₈₀ 300 µm, 150 µm and 106 µm. Gold grades in rougher concentrate ranged from 10.0 g/t to 14.1 g/t Au, gold recovery ranged from 60.9% to 80.6%, and the highest gold recovery was at a grind of P₈₀ 300 µm.

The final Sample 1 flotation test evaluated a sequential copper sulphide followed by copper oxide flotation with cyanidation of the flotation tails. The test results were as follows:

- Gold and copper rougher flotation resulted in a gold recovery of 77.0% and copper recovery of 81.3%. Cleaning the sulphide copper and oxide copper concentrates gave a combined concentrate grade of 54.9 g/t Au and 19.0% Cu. Gold and copper recoveries were 67.4% and 61.6%, respectively;
- Cyanidation of the flotation tails resulted in an additional 18.4% gold recovery; and

- Combined rougher flotation and cyanidation overall gold recovery was 95.4%, based on the calculated head of 0.99 g/t Au.

13.1.2 Cyprus (1982) - Acid Leaching Prior to Cyanidation

In a sequential/dual 2-stage leach process, sulphuric acid leaching to remove copper followed by cyanide leaching to remove gold was completed on the three samples.

Sample 1 was ground to P₈₀ 1,700 µm and leached for 6 hours at a pH of 1.5 with sulphuric acid. Sulphuric acid consumption was 52.5 kg/t. Copper dissolution was 58.5% in the acid leach. The leach residue was washed and leached with sodium cyanide for 48 hours. Gold dissolution was 86.5% in the cyanide leach. Sodium cyanide and lime consumptions were 1.8 kg/t and 3.9 kg/t, respectively.

Sample 1 ground to P₈₀ 150 µm was leached for 6 hours at a pH of 1.5-1.7 with sulphuric acid. Sulphuric acid consumption was 72 kg/t. Copper dissolution was 60.1% in the acid leach. Leach residue was washed and leached with sodium cyanide for 24 hours. Gold dissolution was 98.0%. Sodium cyanide and lime consumptions were 1.4 kg/t and 3.7 kg/t, respectively.

Sample 2 tested at P₈₀ 12,700 µm was leached for 96 hours with sulphuric acid. Copper dissolutions at 24 hours and 96 hours were 57.3% and 67.6%, respectively. Sulphuric acid consumption at 96 hours was 45.3 kg/t. The acid leach residue was washed and leached with sodium cyanide. Gold dissolution was ~50%. Sodium cyanide and lime consumptions were 3.4 kg/t and 3.8 kg/t, respectively.

13.1.3 Cyprus (1982) - Direct Cyanide Leaching

Three direct cyanide leach tests were completed on Sample 1 and one test on Sample 2. Sample 1 material crushed to P₈₀ 1,700 µm was leached for 24 hours. The initial cyanide concentration was 1,250 ppm, and the pH was adjusted to 12.3 with lime. Gold and copper dissolutions were 75.4% and 64.9%, respectively. Sodium cyanide and lime consumptions were 5.2 kg/t and 4.6 kg/t, respectively.

Sample 1 material P₈₀ 150 µm was leached for 24 hours. The initial cyanide concentration was 1,500 ppm and the pH was adjusted to 10.0 with lime. Gold and copper dissolutions were 25.1% and 37.6%, respectively. Sodium cyanide and lime consumptions were 2.9 kg/t and 2.4 kg/t, respectively.

Sample 1 material ground to P₈₀ 150 µm was leached for 24 hours. The initial cyanide concentration was 2,500 ppm, and the pH was adjusted to 11.8 with lime. Gold and copper

dissolutions were 95.1% and 52.5%, respectively. Sodium cyanide and lime consumptions were 4.7 kg/t and 2.4 kg/t, respectively.

Sample 2 material crushed to P₈₀ 12,700 µm material was leached for 96 hours. The initial cyanide concentration was 5,000 ppm, and the pH was adjusted to 12.6 with lime. Gold dissolution was 66.7%. Sodium cyanide and lime consumptions were 3.4 kg/t and 3.8 kg/t, respectively.

13.2 PLACER U.S., INC. (1984) - Metallurgy Section Report

Placer U.S., Inc. (“Placer”) contracted PDL Research Laboratory (“PDL”) for gravity testing and direct cyanide leaching. A surface rock sample, Trench No. 5, was shipped to PDL.

PDL concluded gravity separation was not an option and obtained similar direct cyanide leach results as reported in the 1982 Cyprus report.

13.3 PLACER U.S., INC. (1985) – DB&O Gravity Concentration Test Report

Placer contracted with DB&O Inc. (“DB&O”) for gravity testing. The objective of the test work was to determine the applicability of gravity concentration for the recovery of free and liberated gold values in the material.

One gold-bearing sample was received weighting 23.1 kg. This sample was utilized for gravity concentration tests using a shaking table. The feed slimes fraction and the slime fractions generated when screening and milling were not assayed.

DB&O concluded gravity concentration did partially concentrate the gold and copper minerals. The true weight fractions and gold recoveries cannot be determined from the historical test report.

13.4 PLACER U.S., INC. (1985) – KCA Bottle Roll Test

Placer contracted with Kappes, Cassiday & Associates (“KCA”) to complete sodium cyanide bottle roll tests. A sample of drill hole cuttings from Placer No. MSR 170-175 was received and crushed. Splits of the crushed material were pulverized. The pulverized material was utilized for sodium cyanide leach tests. Four series of pulverized leach tests were completed as shown in Table 13-2.

Series 5777 bottle roll leach tests were pulverized and leached in four different individual bottle roll leach tests for 0.5, 1, 2, and 4 hours. The initial sodium cyanide concentration was 5 g/L. The gold dissolution increased from 66.7% to 75.3% as the leach time increased from 0.5 to 4 hours. The gold dissolution averaged 72.9% . Sodium cyanide consumption averaged 10.9 kg/t. The average calculated head grade was 2.76 g/t.

Series 5680 bottle roll leach tests were pulverized and leached in four different individual bottle roll leach tests for 0.5, 1, 2, and 4 hours. The initial sodium cyanide concentration was 10 g/L. The gold dissolution increased from 60.8% to 89.2% as the leach time increased from 0.5 to 4 hours. The gold dissolution averaged 76.5%. Sodium cyanide consumption averaged 12.0 kg/t. The average calculated head grade was 1.92 g/t.

Series 6150 bottle roll leach tests were pulverized and leached in four different individual bottle roll leach tests for 0.5, 1, 2, and 4 hours. The initial sodium cyanide concentration was 5 g/L. The gold dissolution increased from 43.6% to 54.4% as the leach time increased from 0.5 to 4 hours. The gold dissolution averaged 51.3%. Sodium cyanide consumption averaged 9.2 kg/t. The average calculated head grade was 3.06 g/tAu.

Series 6150 bottle roll leach tests were pulverized and leached in four different individual bottle roll leach tests for 0.5, 1, 2, and 4 hours. The initial sodium cyanide concentration was 10 g/L. The gold dissolution increased from 63.2% to 94.3% as the leach time increased from 0.5 to 4 hours. The gold dissolution averaged 82.3%. Sodium cyanide consumption averaged 14.5 kg/t. The average calculated head grade was 2.57 g/t.

**Table 13-2
Placer USA, Inc. – KCA (1985) Sodium Cyanide Bottle Roll Results – Pulverized Sample**

No.	KCA Test No.	Time	Initial NaCN	Final NaCN	Calculated Head		Assay Tail		Gold Dissolution	Silver Dissolution	NaCN Consumed
					Au (gpt)	Ag (gpt)	Au (gpt)	Ag (gpt)	%	%	kg/tonne
1	5777 A	0.5	5	0.74	2.68	3.09	0.89	1.03	66.7%	66.7%	8.5
2	5680 C		10	3.85	1.75	3.09	0.69	0.69	60.8%	77.8%	12.3
3	5777 B	1.0	5	0.73	2.74	3.43	0.72	1.37	73.8%	60.0%	12.3
4	5680 B		10	3.50	1.44	3.09	0.24	0.69	83.3%	77.8%	8.6
5	5777 C	2.0	5	0.69	2.57	2.74	0.62	0.69	76.0%	75.0%	13.0
6	5680 D		10	3.55	2.26	5.83	0.62	3.09	72.7%	47.1%	12.9
7	5777 D	4.0	5	0.18	3.05	5.15	0.75	3.09	75.3%	40.0%	9.7
8	5680 E		10	2.90	2.23	6.86	0.24	4.12	89.2%	40.0%	14.2
	Average		5	0.59	2.76	3.60	0.75	1.54	72.9%	60.4%	10.9
	Standard Deviation			0.27	0.21	1.07	0.11	1.07	4.3%	14.9%	2.1
	Average		10	3.45	1.92	4.72	0.45	2.14	76.5%	60.7%	12.0
	Standard Deviation			0.40	0.40	1.93	0.24	1.73	12.5%	20.0%	2.4
1	6150 A	0.5	5	0.4	3.46	3.77	1.96	1.37	43.6%	63.6%	9.2
2	6150 E		10	2.8	2.61	3.43	0.96	0.34	63.2%	90.0%	14.5
3	6150 B	1.0	5	0.55	2.74	2.40	1.30	0.34	52.5%	85.7%	8.9
4	6150 F		10	2.85	2.54	4.80	0.51	1.72	79.7%	64.3%	14.3
5	6150 C	2.0	5	0.35	2.95	3.09	1.34	0.69	54.7%	77.8%	9.3
6	6150 G		10	2.6	2.16	5.15	0.17	1.72	92.1%	66.7%	14.8
7	6150 D	4.0	5	0.35	3.09	2.40	1.41	0.34	54.4%	85.7%	9.3
8	6150 H		10	2.85	2.98	3.43	0.17	0.34	94.3%	90.0%	14.3
	Average		5	0.41	3.06	2.92	1.50	0.69	51.3%	78.2%	9.2
	Standard Deviation			0.09	0.30	0.66	0.31	0.49	5.2%	10.4%	0.2
	Average		10	2.78	2.57	4.20	0.45	1.03	82.3%	77.7%	14.5
	Standard Deviation			0.12	0.34	0.90	0.37	0.79	14.3%	14.2%	0.2

13.5 PLACER (1985) – 1985 Metallurgical Report Section

Placer compared their cyanide leach test results to the Cyprus (1982) test results.

The following can be noted:

**Table 13-3
Placer vs Cyprus Milled Cyanidation Results**

	Gold Extraction, %		NaCN Consumption, kg/t	
	High	Low	High	Low
Cyprus	95.1%	25.1%	4.7	2.9
Placer	94.3%	43.6%	14.8	8.5

Placer concluded the following:

- Gold dissolution increased with increasing sodium cyanide consumption and leach time;
- The results indicated wide variations in the calculated head grades indicating some coarse gold may be present; and
- Copper leached as fast as the gold.

13.6 CUERVO GOLD, INC. (1988) – MRC Flooded Column Tests

Cuervo Gold, Inc. (“Cuervo”), through its parent company Glamis Gold, Inc., contracted Metals Resource Corp. (“MRC”) to complete flooded column tests. The purpose of the test program was to eliminate or reduce the negative effects of copper content of the Cuervo material on leach recoveries, chemical consumption, and carbon loading by the addition of ammonia, ammonium carbonate, and ammonium nitrate salts. The test program included:

- A series of six flooded column leach tests conducted on the copper bearing material;
- Eight agitated vat leach tests; and
- Six adsorption tests conducted to determine the limit of copper adsorption.

The material, as received, was crushed to minus 25,400 µm. A screen analysis showed most of the gold occurred in the fine fractions.

Six head assays of the material showed a variation in gold assays from 0.62 g/t to 1.44 g/t. An average of the six assays were used for calculating the leach recoveries (1.03 g/t Au, 2.06 g/t Ag and 0.38% Cu).

The following observations were made:

- Leaching with normal cyanide solutions was slow and resulted in gold recoveries of 50% or less;
- The six columns were leached from 6 to 19 days. The addition of 7-190 g/L of ammonium nitrate to the leach solutions increased gold recovery. Gold dissolution varied from 26.7% to 96.7%, silver dissolution varied from 50% to 70%, and copper dissolution varied from 15.2% to 30.3%;
- Initial tests indicated ammonium nitrate achieved higher leach recoveries than tests that contained other ammonium salts, or ammonia;
- The use of ammonia or ammonium carbonate did not have a beneficial effect on leaching;
- Leaching copper from the mineralized material with ammonium salts prior to cyanide leaching did not decrease the amount of copper leached during the cyanide leach;
- Copper loading on activated carbon will be minimized by maintaining a minimum of 250 ppm free sodium cyanide at a pH >10; and
- Ammonium nitrate addition to the cyanide leach solution had no noticeable effect on the leaching of silver or copper.

13.7 GWALIA (1990) – Sullivan Preliminary Economic Assessment

Gwalia (U.S.A.) Ltd. (“Gwalia”) contracted Pincock, Allen, and Holt (“PAH”) to complete a Preliminary Economic Assessment. PAH coordinated the metallurgical test program with Gwalia and third-party laboratories.

Gwalia collected eight bulk samples from the Glamis pit to generate two oxide composites and drilled four core holes to generate two oxide composites, one mixed oxide/sulphide composite, and one sulphide composite. The bulk sample and core composites were subjected to direct cyanide leaching, two-stage leaching: sulphuric acid followed by sodium cyanide leaching, and the core mixed oxide/sulphide and sulphide composites were tested by direct flotation, and flotation of cyanide leached tails.

13.7.1 Gwalia (1990) - Metallurgical Work – Pit Bulk Samples

Gwalia collected eight samples from the Glamis pit forming metallurgical composites MET 1 to MET 8. These were blended and analysed for gold, silver and copper. The sample description and average metal grades are shown in Table 13-4.

The laboratory blended two composites: Composite 1 was a blend of Met-1, Met-2 and Met-8; and Composite 2 was a blend of Met-3 and Met-4. Composites Met-5, Met-6, and Met-7 were tested individually.

**Table 13-4
Bulk Sample Individual Composites and Assays**

Sample	Description	Distance Below Surface	Average Au	Average Cu	Average Ag
		m	gpt	gpt	gpt
Met-1	Highly fractured, moderate to strong argillization, heavy limonite on fractures, moderate manganese oxides, moderate copper oxides	8	1.2	5167	< 3.4
Met-2	Highly silicification, moderate argillization, moderate limonite staining, weak manganese oxides, weak copper oxide,	12	1.3	4867	< 3.4
Met-3	Steeply dipping zone fracturing brecciation and veining (0.9m wide), moderate silicification, weak manganese oxides, weak copper oxide, weak limonite	17	1.3	4833	< 3.4
Met-4	6.1m zone fracturing and silicification, moderate to strong limonite, manganese oxides, moderate to strong copper oxides	15	1.2	4567	< 3.4
Met-5	Fractured and argillized halo adjacent to silicified fracture zone, limonite and manganese oxide, Copper oxide locally strong, but generally weak	6	0.5	3067	< 3.4
Met-6	Moderate argillization with locally silicified zones, moderate to weak limonite and manganese oxides, weak copper oxides	5	0.9	3367	< 3.4
Met-7	Heavily fractured, moderate argillization, weak to moderate silicification, heavily limonite stained and heavy manganese oxides, nil to weak copper oxides	2	0.6	2733	< 3.4
Met-8	Intensely argillized, locally strong limonite, and copper oxide, otherwise moderate	3	1.4	5100	< 8.5

13.7.2 Gwalia (1990) - Bulk Sample - Direct Cyanide Bottle Roll and Column Tests

Direct cyanide bottle roll and column leach tests were completed on Composites 1 and 2. Test results are presented in Table 13-5 and discussed below.

Direct cyanide bottle roll tests were completed on the Bulk Sample Composite 1 and Composite 2 at sizes P₈₀ 25,400, 12,700, 6,350 and 150 µm. Gold dissolutions ranged from 43% to 91%. Copper dissolutions ranged from 11% to 50%. Cyanide consumption averaged 2.7 kg/t. Lime consumption averaged 2.6 kg/t.

Direct cyanide column leach tests were completed on the Bulk Sample Composite 1 at sizes P₈₀ 12,700 µm and 6,350 µm. Gold dissolutions were 74% and 77%, respectively. Copper dissolutions were 11% and 36%, respectively. Cyanide consumption averaged 2.9 kg/t. Lime consumption averaged 2.5 kg/t.

Direct cyanide column leach tests were completed on Bulk Sample Composite 2 at size P₈₀ 12,700 µm and 6,350 µm. Gold dissolutions were 75% and 79%, respectively. Copper dissolutions were 34% and 23%, respectively. Cyanide consumption averaged 3.2 kg/t. Lime consumption averaged 2.5 kg/t.

**Table 13-5
Gwalia (1990) – Bulk Sample and Core – Direct Cyanide – Bottle Roll and Column Tests**

Company/ Units	Year	Sample Description	Test Type	Size, P80	Calc. Au Head	Calc. Cu Head	Gold Dissolution	Copper Dissolution	Cyanide Consumption	Lime Consumption	
				um	gpt	gpt	%	%	kg/tonne	kg/tonne	
Gwalia (U.S.A.) Ltd.	1990	Bulk Sample	Comp. 1 - Oxide	Bottle Roll- Direct Cyanide	25,400	1.4	4,800	66%	13%	1.7	2.2
					12,700	1.3	4,700	62%	11%	1.5	2.5
					6,350	1.4	4,200	76%	35%	3.2	2.9
					150	1.1	4,400	88%	18%	2.1	3.6
			Comp. 2 - Oxide	Bottle Roll- Direct Cyanide	25,400	1.5	5,050	43%	25%	3.7	1.5
					12,700	1.3	4,050	51%	21%	3.3	1.8
					6,350	1.4	4,500	74%	17%	2.6	3.3
					150	1.1	4,800	91%	50%	3.8	3.3
		Core	Comp. 1 - Oxide	Column Test- Direct Cyanide	12,700	1.2	4,000	74%	11%	2.8	2.5
					6,350	1.2	4,400	77%	36%	2.9	2.5
					12,700	1.5	3,900	75%	34%	3.8	2.5
					6,350	1.5	3,900	79%	23%	2.6	2.5
		Core	Comp. 1 - Oxide	Bottle Roll- Direct Cyanide	6,350	0.7	2,650	55%	79%	3.8	0.5
					150	0.5	4,050	88%	78%	3.5	3.3
					6,350	0.8	3,500	26%	49%	6.4	1.8
					150	1.1	4,550	19%	75%	7.2	3.0
			Comp. 3 - Mixed Oxide/Sulphide	Bottle Roll- Direct Cyanide	6,350	0.8	4,150	46%	20%	2.2	1.7
					150	0.6	4,350	88%	26%	2.7	1.6
					6,350	0.9	3,950	32%	10%	1.1	2.1
					150	0.8	4,350	96%	18%	1.5	1.5

13.7.3 Gwalia (1990) - Metallurgical Work – Core Samples

Gwalia drilled four core holes. Portions from the core holes were utilized to generate four separate composites for metallurgical test work. The composites were chosen to represent two oxide samples, a mixed oxide/sulphide sample, and a unoxidized sample. Geology and assay grade for the four core composites are summarized in Table 13-6.

**Table 13-6
Gwalia (1990) – Core Composites**

Sample/ Units	Description	Composite Drill Holes	Composite Weight	Minimum Depth	Maximum Depth	Average Depth	Weighted Average Au Assay	Weighted Average Cu Assay
			kg	m	m	m	gpt	gpt
Core Composite 1	Weakly to moderately silicified, oxidized material	GS-1, GS-2, GS-4	70	5	79	40	1.0	3141
Core Composite 2	Strongly silicified, oxidized material	GS-1, GS-2, GS-4	115	35	72	54	1.4	3944
Core Composite 3	Weakly to moderately silicification, mixed oxide-sulphide material	GS-3	58	91	133	114	0.8	2811
Core Composite 4	Unoxidized material	GS-3	60	133	152	142	1.0	5436

13.7.4 Gwalia (1990) Core Composite Bottle Roll Tests

Core bottle rolls on oxide Composites 1 and 2 were completed at sizes P₈₀ 6,350 µm and 150 µm (Table 13-5). Gold dissolution ranged from 19% to 88% and copper dissolution ranged from 49% to 79%. Cyanide consumption averaged 5.2 kg/t and lime consumption averaged 2.2 kg/t.

Core bottle rolls on Mixed Oxide/Sulphide Composites 3 and Sulphide Composite 4 were completed at sizes P₈₀ 6,350 µm and 150 µm. Gold dissolution ranged from 32% to 96% and copper dissolution ranged from 10% to 26%. Cyanide consumption averaged 1.9 kg/t and lime consumption averaged 1.7 kg/t.

13.7.5 Gwalia (1990) - Bulk Sample and Core 2-Stage Leach

Two-stage leaching was completed on bulk sample and core composites with sulphuric acid to remove copper, followed by sodium cyanide leaching to remove gold. Bulk sample and core composites were tested in sizes ranging from P₈₀ 25,400 to 150 µm. Reference tabulated test results in Table 13-7.

Oxide bulk sample and core composites gold dissolution ranged from 47% to 91%. Copper dissolution ranged from 45% to 86%. Sodium cyanide, lime, and sulphuric acid consumptions averaged 0.8 kg/t, 11.3 kg/t and 25.1 kg/t, respectively.

Core mixed oxide/sulphide Composite 3 gold dissolution ranged from 50% to 93% and copper dissolution ranged from 20% to 33%. Sodium cyanide, lime and sulphuric acid consumptions averaged 0.9 kg/t, 4.7 kg/t, and 56.3 kg/t, respectively.

Core sulphide Composite 4 gold dissolution ranged from 39% to 84% and copper dissolution ranged from 23% to 47%. Sodium cyanide, lime, and sulphuric acid consumptions averaged 1.4 kg/t, 4.4 kg/t, and 61.2 kg/t, respectively.

Table 13-7
Gwalia (1990) – Bulk Sample Core – 2-Stage Sulphuric Acid – Sodium Cyanide – Bottle Roll Tests

Sample Description		Test Type		Size, P80	Calc. Au Head	Calc. Cu Head	Gold Dissolution	Copper Dissolution	Cyanide Consumption	Lime Consumption	Sulphuric Acid Consumption
				um	gpt	gpt	%	%	kg/tonne	kg/tonne	kg/tonne
Bulk Sample	Comp. 1 - Oxide	Bottle Roll	2-Stage: Acid, Cyanide	25,400	1.2	4,900	52.8%	44.9%	0.980	9.700	15.9
				12,700	1.4	5,700	62.5%	57.9%	1.060	9.950	17.5
				12,700	1.4	4,450	61.0%	64.0%	0.485	12.150	25.0
				6,350	1.1	4,800	69.7%	75.0%	0.370	12.950	25.0
				150	1.2	4,750	91.4%	86.3%	0.355	19.300	41.3
Core	Comp. 1 - Oxide	Bottle Roll	2-Stage: Acid, Cyanide	6,350	0.7	3,550	55.0%	74.8%	0.245	6.700	49.3
				600	0.7	3,050	85.0%	85.2%	0.060	8.900	58.7
				425	0.6	1,550	77.8%	74.2%	0.305	5.150	64.2
				300	0.6	3,550	78.8%	90.1%	0.350	13.650	69.7
				212	1.7	3,100	94.0%	88.7%	0.235	8.500	73.8
				150	0.9	3,100	76.0%	88.7%	0.735	7.000	69.5
Bulk Sample	Comp. 2 - Oxide	Bottle Roll	2-Stage: Acid, Cyanide	25,400	0.9	4,650	55.6%	61.3%	1.420	7.500	17.4
				12,700	1.2	4,050	47.2%	63.0%	1.575	7.850	19.0
				12,700	1.4	4,650	56.1%	71.0%	0.455	8.800	25.0
				6,350	1.3	4,450	62.2%	77.5%	0.485	9.350	26.9
				150	1.2	4,250	91.4%	85.9%	0.305	15.200	37.5
Core	Comp. 2 - Oxide	Bottle Roll	2-Stage: Acid, Cyanide	6,350	1.1	5,200	48.5%	84.6%	0.375	4.100	38.7
				600	1.0	4,450	89.7%	93.3%	0.215	4.300	58.7
				425	1.0	4,800	90.0%	90.6%	0.215	6.500	64.2
				300	1.1	3,850	87.1%	90.9%	0.350	6.250	69.7
				212	1.0	3,050	85.7%	88.5%	0.740	9.600	73.8
				150	2.9	4,450	69.4%	89.9%	0.675	7.200	56.8
	Comp. 3 - Mixed Oxide/Sulphide	Bottle Roll	2-Stage: Acid, Cyanide	6,350	0.6	3,500	50.0%	20.3%	1.535	3.250	30.5
				600	0.8	2,900	83.3%	29.3%	0.520	4.800	63.3
				425	0.6	4,100	82.4%	32.9%	0.610	4.850	54.9
				300	0.7	3,700	85.0%	23.0%	0.910	4.850	60.4
				212	1.4	2,900	92.7%	31.0%	0.745	4.800	66.9
				150	0.8	3,900	91.7%	33.3%	1.195	5.900	61.7
	Comp. 4 - Sulphide	Bottle Roll	2-Stage: Acid, Cyanide	6,350	1.0	4,450	39.3%	24.7%	0.900	0.950	42.3
				600	0.8	2,900	78.3%	25.9%	0.520	4.800	70.2
				425	0.9	2,200	84.0%	22.7%	0.610	4.850	58.8
				300	0.6	2,750	82.4%	23.6%	0.910	4.850	56.5
				212	0.8	2,800	81.8%	33.9%	0.745	4.800	77.6
				150	0.8	1,700	62.5%	47.1%	4.800	5.900	61.8

13.7.6 Gwalia (1990) - Core Composite Flotation

Flotation results are presented in Table 13-8.

Core Composites 3 and 4 were subjected to direct flotation at size P₈₀ 300 µm. Concentrate mass pulls ranged from 3% to 4% of the feed weight. Concentrate grade ranged from 9 g/t to 13 g/t Au and 5.1% to 7.1% Cu. Gold and copper concentrate recoveries ranged from 57% to 59% and 65% to 69%, respectively.

Core Composites 3 and 4 were subjected to flotation of cyanide leached tails at P₈₀ 300 µm. Concentrate mass pulls ranged from 3% to 4% of the feed weight. Concentrate grade ranged from 0.5 g/t to 0.7 g/t Au and 4.1% to 4.5% Cu. Gold and copper concentrate recoveries ranged from 25% to 27% and 69% to 70%, respectively.

Combined gold and copper recoveries from sodium cyanide leaching followed by flotation of cyanide leach tails were estimated to be 88% and 78%, respectively.

Table 13-8
Gwalia (1990) – Core – Mixed Sulphide and Sulphide Composites – Flotation

Sample Description		Test Type	Size, P80	Test Product	Weight	Assay Au Head	Assay Cu Head	Gold Distribution	Silver Distribution	Copper Distribution
					wt %	gpt	gpt	%	%	%
Core	Comp. 3 - Mixed Oxide/Sulphide	Flotation	300	Concentrate	3.8%	8.9	51,600	59.4%	75.5%	64.9%
				Tail	96.2%	0.2	1,100	40.6%	24.5%	35.1%
				Total	100.0%	0.6	3,019	100.0%	100.0%	100.0%
	Comp. 4 - Sulphide	Flotation	300	Concentrate	3.0%	13.0	71,000	56.6%	74.8%	68.7%
				Tail	97.0%	0.3	1,000	43.4%	25.2%	31.3%
				Total	100.0%	0.7	3,100	100.0%	100.0%	100.0%
	Comp. 3 - Mixed Oxide/Sulphide	Flotation of Cyanide Tail	300	Concentrate	3.3%	0.7	44,800	25.4%	57.1%	68.6%
				Tail	96.7%	0.1	700	74.6%	42.9%	31.4%
				Total	100.0%	0.1	2,155	100.0%	100.0%	100.0%
	Comp. 4 - Sulphide	Flotation of Cyanide Tail	300	Concentrate	4.4%	0.5	41,400	26.9%	60.3%	70.4%
				Tail	95.6%	0.1	800	73.1%	39.7%	29.6%
				Total	100.0%	0.1	2,586	100.0%	100.0%	100.0%

13.8 Gwalia (1991) – RDi – Sullivan Mine Project

Gwalia (1991) through Minproc Engineers contracted Resource Development Inc. (“RDi”) to conduct bench-scale tests for the Sullivan Mine (now known as the Gabbs Project). The objective of the program was to determine the level of gold and copper recoveries that could be achieved in the flotation process. RDi completed head analyses, Bond rod mill and Bond ball mill indices, evaluated heavy liquid separation, and conducted eighteen bench-scale flotation tests on two composites.

13.8.1 Gwalia (1991) – RDi-Sample Preparation

Two composites of Sullivan Mine drill core were generated: an oxide composite (Composite A) and a sulphide composite (Composite B). Analytical results are found in Table 13-9 and Table 13-10.

**Table 13-9
Gwalia (1991) – RDi Composite Head Analysis**

Composite	Assay Au Head	Assay Cu(Ox)	Assay Cu(S ⁻²)	Assay Cu(Ox)	Assay Cu(S ⁻²)	Total Cu	Assay S	Assay Fe	Assay SiO ₂
	gpt	wt%	wt%	gpt	gpt	gpt	gpt	gpt	%
Composite A	1.4	0.298%	0.088%	2,980	880	3,860	<200	20,000	66.3%
Composite B	0.5	0.109%	0.143%	1,090	1,430	2,520	7,300	35,000	62.9%

Table 13-10
Gwalia (1991) – RDi Whole Rock Analysis

Composite	Units	Average Composite A	Average Composite B
Fe	%	1.25	2.5
Ca	%	0.75	1.25
Mg	%	0.3	1.5
Ag	ppm	<1	<1
As	ppm	<200	<200
B	ppm	10	12.5
Ba	ppm	600	850
Be	ppm	<2	<2
Bi	ppm	<10	<10
Cd	ppm	<50	<50
Co	ppm	<5	<5
Cr	ppm	20	<10
Cu	ppm	6000	6000
Ga	ppm	20	35
Ge	ppm	<20	<20
La	ppm	<20	<20
Mn	ppm	100	175
Mo	ppm	25	10
Nb	ppm	<20	<20
Ni	ppm	5	7
Pb	ppm	<10	<10
Sb	ppm	<100	<100
Sc	ppm	<10	<10
Sn	ppm	<10	<10
Sr	ppm	<100	175
Ti	ppm	850	2000
V	ppm	125	500
W	ppm	<50	<50
Y	ppm	<10	<10
Zn	ppm	<200	<200
Zr	ppm	60	60

13.8.2 Gwalia (1991) - RDi - Bond Work Indices

Composite A rod mill index (RWi) closed at 1,180 µm was 14.9 kW/mt. Composites A and B ball mill indices closed at 425 µm were 16.0 kW/mt and 17.1 kW/mt, respectively.

13.8.3 Gwalia (1991) - RDi - Heavy Liquid Separation

Composite A was ground in a rod mill to give a size P₈₀ 300 µm, screened into six fractions and each fraction subjected to a heavy liquid separation at a specific gravity of 2.95. Based on the

assay feed and flotation tail weight fractions, the gold results did not balance due to the low weight of the sink fraction and possible gold “nugget” effects.

13.8.4 Gwalia (1991) – RDi – Flotation

Sixteen bench scale flotation tests were performed on Composite A and two tests on Composite B. The Composite B tests evaluated gravity separation followed by sand/slimes separation and flotation. The Composite B test results were not successful and are omitted from this review.

Table 13-11 summarizes ten of the eighteen tests. In these tests, Composite A gold recovery ranged from 17% to 82%. Copper oxide recovery ranged from 42.9% to 79.1% and copper sulphide recovery ranged from 54% to 70%. The concentrate mass pull ranged from 3% to 35%. Gold and copper concentrate grades ranged from 0.6 g/t to 25 g/t Au and 0.1% to 8% Cu, respectively.

The following additional observations were made:

- The recovery of gold increased with increasing Na₂S or increasing potential;
- The weight recovery decreases with increasing potential;
- The majority of mineral values were recovered in the first 3 to 5 minutes;
- Sulphide copper recovery decreased with increasing sulphidization;
- Recovery by size data and sand/slimes tests were not successful;
- The use of dithiophosphate as a collector recovered 60% to 70% of the gold values with less than 10% of the sulphide copper values;
- Sulphidization with 1-1.5 kg/t Na₂S recovered 70% to 75% of the oxide copper;
- Copper oxide recovery was independent of potential from -120 to -200 mV;
- The concentrate recovery was high, >10%, and was reduced by using pine oil instead of MIBC as a frother;
- The best results were obtained at a grind P₈₀ 300 µm;
- Sodium silicate reduced over-frothing with a reduction in weight recovery to less than 10%;
- The initial pH significantly influenced recovery, a pH of 10.4 indicated the best recovery for oxide copper; and
- Gravity separation and flotation of gravity tails did not enhance recovery.

Table 13-11
Gwalia (1991) – RDi – Flotation Test Results

Test No.	Test Type	Size, P80	Test Parameter	Float Time	Concentrate Mass Pull	Concentrate Au Recovery	Concentrate Cu(Ox) Recovery	Concentrate Cu(Sulph) Recovery	Concentrate Assay Au	Concentrate Total Cu Assay
		um		min	wt%	%	%	%	gpt	wt%
1	Flotation	212	NaHS 1.23 kg/tonne, pH 11.4, -220 mV	30	16.0%	77.9%	79.1%		5.7	0.1%
2	Flotation	150	NaHS 15 kg/tonne, pH 12.0, -253 mV	30	34.5%	16.5%	42.9%		0.6	0.5%
3	Flotation	300	NaS ₂ 0.625 kg/tonne, pH 9.5, -115 mV, dithiophosphate prior to sulphidization	27	14.0%	53.7%	75.7%	64.0%	4.2	2.1%
4	Flotation	300	NaS ₂ 0.875 kg/tonne, pH 9.7, -130 mV, dithiophosphate prior to sulphidization	27	11.6%	53.7%	75.7%	59.6%	6.2	2.3%
5	Flotation	300	NaS ₂ 1 kg/tonne, pH 10.4, -170 mV, dithiophosphate prior to sulphidization	27	10.9%	64.7%	73.4%	56.9%	9.8	2.6%
9	Flotation	300	NaS ₂ 0.625 kg/tonne, pH 10.2, -151 mV, dithiophosphate prior to sulphidization	30	18.1%	82.0%	77.9%		5.6	1.3%
12	Flotation	150	NaS ₂ 1.5 kg/tonne, pH 10.9, -202 mV, dithiophosphate prior to sulphidization	14	9.5%	77.5%	73.9%	70.2%	9.8	2.7%
16	Flotation - Large Cell -	212	NaS ₂ 1.25 kg/tonne, pH 10.2, -162 mV, dithiophosphate prior to sulphidization	14	5.4%	72.2%	69.6%	57.0%	12.5	4.9%
19	Flotation - Large Cell -	300	NaS ₂ 1.5 kg/tonne, pH 10.9, -202 mV, dithiophosphate prior to sulphidization	31	3.8%	65.8%	67.8%	54.3%	18.2	6.4%
20	Flotation - Large Cell -	300	NaS ₂ 1.5 kg/tonne, pH 10.9, -202 mV, dithiophosphate prior to sulphidization	32	2.9%	64.3%	69.9%	55.3%	24.7	7.7%

13.9 Gwalia (April 1992) – NAD – Sullivan Metallurgical Testwork

Gwalia (April 1992) contracted N.A. Degerstrom (“NAD”) to conduct bench-scale tests for the Sullivan Mine Project. The objective of the program was to determine gold and copper recoveries achieved from sequential leaching; sulphuric acid leaching followed by cyanide leaching of the acid leached material, and direct cyanide leaching.

NAD completed head analysis, direct cyanide bottle roll tests and sequential sulphuric acid – cyanide bottle roll tests at size passing 150 µm, and sequential leach and direct cyanide column tests at size P₈₀ 18,300 µm.

13.9.1 Gwalia (April 1992) - NAD - Sample Preparation

NAD received a bulk sample from the Sullivan pit. The average head analysis is shown in Table 13-12.

**Table 13-12
Gwalia (April 1992) – NAD – Composite Head Analysis**

Composite	Units	Average Bulk Composite
Au	gpt	1.61
Ag	gpt	5.28
Total Cu	%	0.64%
Cu (Oxide)	%	0.61%
Al	%	0.28
Ca	%	0.8
Mg	%	0.12
As	ppm	55
Co	ppm	5
Hg	ppm	0.3
Mn	ppm	251
Ni	ppm	11
Pb	ppm	10
Sb	ppm	56
Zn	ppm	76

13.9.2 Gwalia (April 1992) – NAD - Bottle Roll Leach Tests

Two bottle roll leach tests were completed on the composite sample. In the first bottle roll test, material was direct cyanide leached for 48 hours. Copper recovery was 28.2% and gold recovery was 93.3%. Consumption of sodium cyanide was 5.5 kg/t and lime was 1.7 kg/t.

In the second test, material was pulverized to minus 150 µm, and copper leached with sulphuric acid for 48 hrs. Copper recovery was 94.3%. Sulphuric acid consumption was 20.6 kg/t. The rinsed solids were subsequently cyanide leached for 48 hrs. Gold recovery was 92.1%. Sodium cyanide consumption was 1.0 kg/t. Lime consumption was 5.4 kg/t.

13.9.3 Gwalia (April 1992) – NAD - Column Leach Tests

Mineralized material was crushed to minus 18,300 µm, then leached with sulphuric acid to leach copper. The material was rinsed with water and agglomerated with 5 kg/t cement and cyanide leached. In the other test, the mineralized material was leached with cyanide after agglomeration with 5 kg/t cement.

In the first column test, a copper recovery of 84% was achieved after 30 to 34 days of leaching. Sulphuric acid consumption was 18 kg/t. The rinsed column was cyanide leached and gold recovery was 77% after 80 days. Sodium cyanide consumption was 1.2 kg/t.

In the second column test, the material was direct cyanide leached. The copper recovery of 10.6% was achieved after 38 days. Gold recovery was 35%. Sodium cyanide consumption was 2.5 kg/t.

A screen analysis of the direct cyanide leach tails material indicated the crush size range from minus 25,400 µm to 1,180 µm, gold recoveries ranged from 37.5% to 58.3%. In the size ranges from 850 µm to -75 µm, the gold dissolution ranged from 60.5% to 76.6%, indicating increased gold dissolution with decreasing material size.

The material from the sequential leach was also analysed by screen fraction and fractional assay. The data indicated gold dissolution may be improved if the material is crushed from 6,350 µm to 9,525 µm and copper dissolution would not improve by crushing finer.

13.10 GWALIA (Nov. 1992) – NAD - Sullivan Project Gold Analysis

A study was initiated on how to accurately sample and analyse gold on the Sullivan Project. The testwork indicated the material sample must be finely pulverized and homogenized. The free gold easily segregates, and energy must be expended to smear the gold and evenly distribute it in the material mass.

13.11 Gwalia (1994) - NAD - Summary of Sullivan Testwork

Samples of underground and surface material from the Sullivan Mine were crushed to 12,700 μm and 6,350 μm , acid leached for copper recovery, and then cyanide leached for gold and silver recovery. The results are tabulated in Table 13-13.

Table 13-13
Gwalia (1994) – NAD – Sequential Leach Column Test Results

Test No.	Test Type	Size, P80	Au Calculated Head	Cu Calculated Head	Au Recovery	Cu Recovery	Sulphuric Acid	Sodium Cyanide	Lime
		um	gpt	gpt	%	%	kg/tonne	kg/tonne	kg/tonne
1	Surface	12,700	1.3	3,690	61.0%	84.6%	23.7	0.7	Not Reported
2	Surface	12,700	1.3	3,940	65.4%	86.9%	24.4	0.8	
3	Underground	12,700	0.8	1,470	72.2%	71.2%	33.7	0.6	
4	Underground	12,700	1.1	1,420	57.4%	73.6%	32.3	0.6	
5	Surface	6,350	1.4	3,510	66.4%	87.4%	22.9	0.8	
9	Surface	6,350	1.5	3,790	70.3%	91.4%	27.2	0.8	
12	Underground	6,350	1.0	1,570	74.6%	77.7%	35.4	0.8	
16	Underground	6,350	1.0	1,590	74.1%	80.5%	35.5	0.6	

13.12 Arimetco (1996) - (KCA) Updates

In 1996, Arimetco, Inc. (Arimetco) contracted KCA for metallurgical tests. The historical information was sent as periodic updates to Arimetco and is presented below.

In February 1996, KCA reported copper recovery from 12 small acid leach column tests. Acid addition in agglomerated material ranged from 0 kg/t to 30 kg/t. Sulphuric acid concentration in the leach solution was 10 g/L for 10 tests and 100 g/L in two tests. Ferric iron was 0 g/L to 3 g/L in agglomeration solution and 0 g/L to 15 g/L in leach solutions. Copper dissolution ranged from 16.5% to 95.3% and averaged 72.0%.

In April 1996, KCA reported natural degradation of weak acid dissociable (“WAD”) cyanide in the heap effluents from three heaps identified as K. Flat, P. Peak, and County Line, as follows:

- K. Flat began on 16 July 1995 with a WAD cyanide concentration of 43 mg/L and pH of 8.2. WAD cyanide decreased to 0.21 mg/L by 27 February 1996 and pH was 7.7;
- P. Peak began on 16 July 1995 with a WAD cyanide concentration of 46 mg/L and pH of 8.4. WAD cyanide decreased to 1.96 mg/L by 15 November 1995 and pH was 8.2; and
- County Line began on 18 March 1994 with a WAD cyanide concentration of 2.1 mg/L and pH of 8.1. WAD cyanide decreased to 0.043 mg/L by 27 February 1996 and pH was 6.7.

In July 1996, KCA reported on four large column acid leach tests all crushed to P₈₀ 12,700 µm. Copper recovery ranged from 77.3% to 81.5%, and averaged 79.5% after 102 days of leaching.

In August 1996, KCA reported moisture content for four large column acid leach tests, all crushed to P₈₀ 12,700 µm. Active moisture under leach ranged from 135 to 143 kg/t, the drain down moisture (96-hour) ranged from 17 to 20 kg/t, and the residual moisture ranged from 117 kg/t to 123 kg/t.

In October 1996, KCA reported analytical results on a pregnant leach solution (“PLS”) composite and on leach effluent after caustic neutralization. The Profile II analysis, less WAD cyanide, are presented in Table 13-14.

Table 13-14
Arimetco (1996) – KCA – Solution Analysis

Composite	Units	Acid Leach Pregnant Leach Solution	Neutralized Leach Solution (Caustic Added)
pH		1.44	6.8
Alkalinity	mg/L as CaCO ₃	0.00	56
Bicarbonate	mg/L as CaCO ₃	0.0	68
Carbonate	mg/L as CaCO ₃	0	0
Chloride	ppm	<625	*
Fluoride	ppm	<0.1	3.9
Sulphate	ppm	92,900	33,100
Nitrate Nitrogen	ppm	*	*
Total Dissolved Solids	ppm	74,000	57,000
Ag	ppm	<0.1	<0.05
Al	ppm	2,200	0.18
As	ppm	6.9	<0.25
B	ppm	<0.5	<0.5
Ba	ppm	<0.06	0.055
Be	ppm	0.29	0.95
Bi	ppm	33	<0.5
Ca	ppm	550	470
Cd	ppm	2.0	<0.02
Co	ppm	3.6	<0.5
Cr	ppm	65	<0.05
Cu	ppm	370	0.15
Fe	ppm	10,900	0.24
Ga	ppm	5.5	<0.5
Hg	ppm	0.0090	0.0082
K	ppm	12	110
Li	ppm	2.4	<0.5
Mg	ppm	2,000	4.4
Mn	ppm	730	0.21
Mo	ppm	<0.25	<0.25
Na	ppm	160	16,600
Ni	ppm	2.2	<0.05
P	ppm	220	<0.5
Pb	ppm	1.5	<0.2
Sb	ppm	3.9	<0.5
Sc	ppm	<0.5	<0.5
Se	ppm	<0.05	<0.025
Sn	ppm	15	<0.5
Sr	ppm	2.3	1.6
Tl	ppm	*	<0.025
Ti	ppm	3.35	<0.1
V	ppm	9.2	<0.15
Zn	ppm	28	<0.05

* Unable to quantify due to high sulphate interference

13.13 P2 Gold, Inc. (2021) - Base Metallurgical Laboratories LTD. (BML)

P2 Gold contracted Base Metallurgical Laboratories Ltd. (“BML”) for a Phase One Metallurgical Program. The Phase One Metallurgical Program included testing for the recovery of copper and gold from oxide mineralization by sequential leach using heap leach or conventional processing, and flotation of oxide minerals followed by sequential leaching of flotation tails.

Two composites were made from four bulk samples. Composite 1 samples, labelled GS Bulk 1–A and GS Bulk 1-B, were combined to create a single composite weighing 38.5 kg and crushed to passing 12,700 µm. Composite 2 samples, labelled GS Bulk 2–A and GS Bulk 2-B, were combined to create a single composite weighing 38.0 kg and crushed to passing 12,700 µm. Splits from each composite were screened and the size fractions assayed for gold and copper. Composite 1 and Composite 2 head screen analysis and assays are shown in Table 13-15 and Table 13-16.

Table 13-15
P2 Gold (2021) – BML – Composite 1 – Head Screen Analysis

Particle Size		Weight	Weight Retained	Cumulative Weight Retained	Cumulative Weight Passing	Head Assay	Gold Distribution Retained	Cumulative Au Distribution Retained	Cumulative Au Distribution Passing	Head Assay	Cu Distribution Retained	Cumulative Cu Distribution Retained	Cumulative Au Passing	Cumulative Cu Distribution Passing
Mesh	µm	(g)	wt. %			Au, gpt	Au, %			Cu, %	Cu, %			
1/2 inch	12500	304	12.7%	12.7%	87.3%	0.95	12.3%	12.3%	87.7%	0.37	9.6%	9.6%	90.4%	90.4%
3 Mesh	6700	598.3	25.0%	37.7%	62.3%	0.80	20.3%	32.6%	67.4%	0.38	19.4%	29.0%	71.0%	71.0%
6 Mesh	3360	433.6	18.1%	55.8%	44.2%	1.45	26.7%	59.3%	40.7%	0.41	15.2%	44.2%	55.8%	55.8%
10 Mesh	1700	312.8	13.1%	68.8%	31.2%	0.85	11.3%	70.6%	29.4%	0.48	12.8%	57.0%	43.0%	43.0%
100 Mesh	150	599.6	25.0%	93.9%	6.1%	0.68	17.3%	87.9%	12.1%	0.58	29.7%	86.7%	13.3%	13.3%
200 Mesh	75	72.89	3.0%	96.9%	3.1%	1.69	5.2%	93.2%	6.8%	0.92	5.7%	92.4%	7.6%	7.6%
-200 Mesh	-75	73.81	3.1%	100.0%	0.0%	2.18	6.8%	100.0%	0.0%	1.20	7.6%	100.0%	0.0%	0.0%
Feed (calc)		2395	100.0%			0.98	100.0%			0.49	100.0%			
Feed (direct)						0.88				0.50				

Table 13-16
P2 Gold (2021) – BML – Composite 2 – Head Screen Analysis

Particle Size		Weight	Weight Retained	Cumulative Weight Retained	Cumulative Weight Passing	Head Assay	Gold Distribution Retained	Cumulative Au Distribution Retained	Cumulative Au Passing	Head Assay	Cu Distribution Retained	Cumulative Cu Retained	Cumulative Au Passing	Cumulative Cu Passing
Mesh	µm	(g)	wt. %			Au, gpt	Au, %			Cu, %	Cu, %			
1/2 inch	12500	600.4	29.1%	29.1%	70.9%	1.07	27.7%	27.7%	72.3%	0.37	25.7%	25.7%	74.3%	74.3%
3 Mesh	6700	754	36.6%	65.7%	34.3%	0.88	28.6%	56.3%	43.7%	0.36	31.4%	57.1%	42.9%	42.9%
6 Mesh	3360	331.1	16.1%	81.8%	18.2%	1.26	18.0%	74.3%	25.7%	0.34	13.0%	70.1%	29.9%	29.9%
10 Mesh	1700	147.5	7.2%	88.9%	11.1%	1.83	11.6%	85.9%	14.1%	0.54	9.2%	79.3%	20.7%	20.7%
100 Mesh	150	175.1	8.5%	97.4%	2.6%	1.09	8.2%	94.2%	5.8%	0.66	13.4%	92.7%	7.3%	7.3%
200 Mesh	75	23.6	1.1%	98.6%	1.4%	2.23	2.3%	96.4%	3.6%	1.04	2.8%	95.5%	4.5%	4.5%
-200 Mesh	-75	29.3	1.4%	100.0%	0.0%	2.83	3.6%	100.0%	0.0%	1.32	4.5%	100.0%	0.0%	0.0%
Feed (calc)		2061	100.0%			1.13	100.0%			0.42	100.0%			
Feed (direct)						1.32				0.54				

13.13.1 P2 Gold (2021) - BML - Sequential Flotation - Oxide Copper Recovery by Sulphidization

Two sequential flotation tests evaluated recovery of sulphide copper minerals with PAX as a collector, followed by flotation of copper oxide minerals by sulphidization with sodium bisulphide (NaHS), and collection with PAX and Areo3477.

Composite 1 was ground to a P₈₀ 100 µm. Composite 1 combined sulphide and oxide concentrate weighed 15.1% of the feed weight. Concentrate gold recovery was 75.1%. Concentrate copper recovery was 33.3%. Concentrate gold grade was 4.6 g/t Au. Concentrate copper grade was 1.0% (Table 13-17).

Composite 2 was ground to P80 100 µm. Composite 2 combined sulphide and oxide concentrate weights 6.2% of the feed weight. Concentrate gold recovery was 78.5%. Concentrate copper recovery was 25.1%. Composite gold grade was 16.1 g/t. Concentrate copper grade was 2.2% (Table 13-17).

13.13.2 P2 Gold (2021) - BML - Sequential Flotation - Oxide Copper by Alky Hydroximate

Two sequential flotation tests evaluated sulphide copper recovery with PAX as a collector followed by flotation copper oxide minerals by the addition of PAX and Areo 6494, an alkyl hydroximate collector.

Composite 1 and Composite 2 were ground to a P₈₀ 100 µm. Composite 1 combined sulphide and oxide concentrate weighed 20.6% of the feed mass weight. Concentrate gold recovery was 72.4%. Concentrate copper recovery was 36.7%. Concentrate gold grade was 2.5 g/t. Concentrate copper grade was 0.8% (Table 13-17).

Composite 2 combined sulphide and oxide concentrate weighed 8.3% of the feed weight. Concentrate gold recovery was 71.9%. Concentrate copper recovery was 29.8%. Concentrate gold grade was 10.7 g/t Au. Concentrate copper grade was 1.8% (Table 13-17).

13.13.3 P2 Gold (2021) - BML - Bottle Roll Sequential Leach: Sulphuric Acid Leach – Cyanide Leach

Two-stage sequential leaching with sulphuric acid followed by sodium cyanide bottle roll tests were completed on both composites at sizes P₈₀, 12,700 µm, 6,350 µm, and 100 µm, test results are summarized in Table 13-18 and described below.

Table 13-17
P2 Gold (2021) – BML – Flotation: Sequential

Composite	BML Test No.	Test Type		Size, P80	Test Parameter	Float Time	Combined Concentrate Mass	Combined Concentrate Au Recovery	Combined Concentrate Cu Recovery	Combined Concentrate Au Grade	Combined Concentrate Cu Grade
				um		min	% Feed	%	%	gpt	%
Composite 1	1	Sequential: Cu(Sul)-Cu(Ox) Flotation	Sulphidization	100	PAX, NaHS, Aero 3477, MIBC, pH 9.0 -10.4, Eh 164 to -322 mV	11	15.1%	75.1%	33.3%	4.6	1.0%
Composite 2	2	Sequential: Cu(Sul)-Cu(Ox) Flotation	Sulphidization		PAX, NaHS, Aero 3477, MIBC, pH 8.8 - 10.3, Eh 204 to -335 mV	9	6.2%	78.5%	25.1%	16.1	2.2%
Composite 1	3	Sequential: Cu(Sul)-Cu(Ox) Flotation	Alkyl Hydroxiamate	100	PAX, Aero 6496, MIBC, pH 8.8 -10.3, Eh 204 to -335 mV	11	20.6%	72.4%	36.7%	2.5	0.8%
Composite 2	4	Sequential: Cu(Sul)-Cu(Ox) Flotation	Alkyl Hydroxiamate		PAX, Aero 6496, MIBC pH 8.6 -9.1, Eh 219 to 156 mV	11	8.3%	71.9%	29.8%	10.7	1.8%

Table 13-18

P2 Gold (2021) – BML – Sequential Leach: 2-Stage Sulphuric Acid – Sodium Cyanide Bottle Roll Tests

Sample	Test Type		Size, P ₈₀	Calc. Au Head	Calc. Cu Head	Gold Dissolution	Copper Acid Dissolution	Copper Cyanide Dissolution	Total Copper Dissolution	Cyanide Consumption	Lime Consumption	Sulphuric Acid Consumption
			um	gpt		%	%			kg/tonne		
Composite 1	Bottle Roll	2-Stage: Acid, Cyanide	12,700	1.16	4,310	66.0%	74.5%	33.7%	83.1%	0.7	3.3	36.6
			6,350	0.87	4,872	70.0%	83.0%	36.4%	89.2%	0.9	6.4	40.3
			100	0.88	4,906	97.7%	89.8%	11.6%	91.0%	0.4	5.3	51.2
Composite 2	Bottle Roll	2-Stage: Acid, Cyanide	12,700	1.10	4,800	55.9%	64.4%	47.0%	81.1%	0.8	4.0	N/A
			6,350	1.19	4,824	79.0%	78.5%	29.8%	84.9%	1.1	4.0	71.4
			100	1.08	4,697	95.8%	86.2%	11.0%	87.7%	0.5	4.2	86.0

13.13.3.1 P2 Gold (2021) – BML - Composite 1

Composite 1 material, crushed to P₈₀ 12,700 µm was leached in sulphuric acid for 8 days. Copper dissolution was 74.5%. Sulphuric acid addition was 36.6 kg/t. Composite 1 acid leached tails were washed and neutralized and remaining gold and copper cyanide leached for 8 days. Gold and copper dissolutions were 66.0% and 33.7%, respectively. Sodium cyanide and lime consumptions were 0.7 kg/t and 3.3 kg/t, respectively. Combined copper dissolution was 83.1%.

Composite 1 material was crushed to P₈₀ 6,350 µm and leached in sulphuric acid for 8 days. Copper dissolution was 83.0%. Sulphuric acid addition was 40.3 kg/t. Composite 1 acid leached tails were washed and neutralized and remaining gold and copper cyanide leached for 8 days. Gold and copper dissolutions were 70.0% and 36.4%, respectively. Sodium cyanide and lime consumptions were 0.9 kg/t and 6.4 kg/t, respectively. Combined copper dissolution was 89.2%.

Composite 1 material, crushed to P₈₀ 100 µm, was leached in sulphuric acid for 24 hours. Copper dissolution was 89.8%. Sulphuric acid addition was 51.2 kg/t. Composite 1 acid leached tails were washed and neutralized and remaining gold and copper cyanide leached for 48 hours. Gold and copper dissolutions were 97.7% and 11.6%, respectively. Sodium cyanide and lime consumptions were 0.4 kg/t and 5.3 kg/t, respectively. Combined copper dissolution was 91.0%.

13.13.3.2 P2 Gold (2021) – BML - Composite 2

Composite 2 material, crushed to P₈₀ 12,700 µm was leached in sulphuric acid for 8 days. Copper dissolution was 64.4%. Sulphuric acid addition was not determined. Composite 2 acid leached tails were washed and neutralized and remaining gold and copper cyanide leached for 8 days. Gold and copper dissolutions were 55.9% and 47.0%, respectively. Sodium cyanide and lime consumptions were 0.8 kg/t and 4.0 kg/t, respectively. Combined copper dissolution was 81.1%.

Composite 2 material, crushed to P₈₀ 6,350 µm, was leached in sulphuric acid for 8 days. Copper dissolution was 78.5%. Sulphuric acid addition was 71.4 kg/t. Composite 2 acid leached tails were washed and neutralized and remaining gold and copper cyanide leached for 8 days. Gold and copper dissolutions were 79.0% and 29.8%, respectively. Sodium cyanide and lime consumptions were 1.1 kg/t and 4.0 kg/t, respectively. Combined copper dissolution was 84.9%.

Composite 2 material, crushed to P₈₀ 100 µm, was leached in sulphuric acid for 24 hours. Copper dissolution was 86.2%. Sulphuric acid addition was 86.0 kg/t. Composite 2 acid

leached tails were washed and neutralized and remaining gold and copper cyanide leached for 48 hours. Gold and copper dissolutions were 95.8% and 11.0%, respectively. Sodium cyanide and lime consumptions were 0.5 kg/t and 4.2 kg/t, respectively. Combined copper dissolution was 87.7%.

13.13.4 P2 Gold (2021) – BML - Combined Flotation and 2-Stage Leach

Combined flotation and 2-stage leaching tests were completed on each composite. Composites 1 and 2 were ground to size a P₈₀ 100 µm, and sulphide copper floated with PAX. The flotation tails were sequentially leached in two stages with sulphuric acid followed by sodium cyanide in bottle roll tests.

13.13.4.1 P2 Gold (2021) – BML - Composite 1 – Flotation – 2-Stage Leach

Composite 1 sulphide concentrate weighed 4.3% of the feed mass. Gold and copper recoveries were 68% and 4.6%, respectively. Gold and copper sulphide concentrate grades were 36.9 g/t Au and 0.9% Cu, respectively.

Composite 1 flotation tails were leached in sulphuric acid for 24 hours. Copper dissolution was 90%. Sulphuric acid addition was 43.2 kg/t. Composite 1 acid leached flotation tails were washed and neutralized and remaining gold and copper cyanide leached for 48 hours. Gold and copper dissolutions were 89% and 9%, respectively. Sodium cyanide and lime consumptions were 0.4 kg/t and 7.4 kg/t, respectively.

13.13.4.2 P2 Gold (2021) – BML - Composite 2 – Flotation – 2-Stage Leach

Composite 2 sulphide concentrate weighed 4.2% of the feed mass. Gold and copper recoveries were 68% and 9%, respectively. Gold and copper sulphide concentrate grades were 20.5 g/t Au and 1.0% Cu, respectively.

Composite 2 flotation tails were leached in sulphuric acid for 24 hours. Copper dissolution was 84%. Sulphuric acid addition was 86.0 kg/t. Composite 2 acid leached flotation tails were washed and neutralized and remaining gold and copper cyanide leached for 48 hours. Gold and copper dissolutions were 89% and 7%, respectively. Sodium cyanide and lime consumptions were 0.6 kg/t and 6.4 kg/t, respectively.

13.14 P2 Gold (2022) – KCA –Metallurgical Test Program on Oxides and Sulphide Composites

On 12 October 2021, KCA received drill core samples to make three oxide composites designated Low, Medium, and High grade, and one sulphide composite. The composites were utilized in head analyses, cement agglomeration and compaction, bottle roll leach, flotation

(rougher and cleaner), flotation tails acid and cyanide leach, and column leach test work. The oxide composites were HPGR crushed for the test work, while the sulphide composite was conventionally crushed.

The head analyses included gold analysis by standard fire assay methods with FAAS finish, silver analysis by wet chemistry methods (four-acid digestion) with FAAS finish, cyanide soluble copper by shake-tests, carbon and sulphur speciation, multi-element analysis by ICAP-OES, and whole-rock constituent analysis by LMF-ICAP. Tests completed on the composites included sequential copper analyses to determine acid soluble and cyanide soluble copper, and acid consumption test work.

13.14.1 P2 Gold (2022) – KCA – Head Analyses

The results of the direct head assays for gold ranged from 0.238 to 1.215 g/t for the composite samples. Copper assays ranged from 2,538 to 4,732 mg/kg. Oxide composites were screened and assayed by size fraction. The weighted averages for the head assays ranged from 0.165 to 1.283 g/t for gold, and 2,465 to 4,295 mg/kg for copper. The results of the head assays are presented in Table 13-19.

**Table 13-19
P2 Gold (2022) – KCA – Head Assays on Oxide and Sulphide Composites**

Head Assays

KCA Sample No.	Description	Average Assay, gms Au/MT	Average Assay, gms Ag/MT	Total Copper Assay, mg/kg
92908 A	High Grade Composite	1.215	2.41	4732
92909 A	Medium Grade Composite	0.555	1.63	3027
92910 A	Low Grade Composite	0.366	0.97	2538
92904 A	Sulphide Composite	0.238	0.69	2566

Head Screen Assays

KCA Sample No.	Description	Weighted Avg. Head Assay, gms Au/MT	Weighted Avg. Head Assay, gms Ag/MT	Weighted Avg. Head Assay, mgs Cu/kg
92908 A	High Grade Composite	1.283	2.96	4295
92909 A	Medium Grade Composite	0.601	0.80	2905
92910 A	Low Grade Composite	0.165	0.21	2465
92904 A	Sulphide Composite	--	--	--

The total carbon content of the composites ranged from 0.43% to 0.82%, with a majority inorganic carbon. The total sulphur content of the sulphide composite was measured at 1.74%, while the oxide composites (Low, Medium, and High) ranged from 0.03% and 0.06%. The results of the carbon and sulphur analyses are presented in Table 13-20.

**Table 13-20
P2 Gold (2022) – KCA – Carbon and Sulphur Analyses on Oxide and Sulphide Composites**

KCA Sample No.	Description	Total Carbon, %	Organic Carbon, %	Inorganic Carbon, %
92908 A	High Grade Composite	0.43	0.08	0.35
92909 A	Medium Grade Composite	0.80	0.10	0.70
92910 A	Low Grade Composite	0.82	0.07	0.75
92904 A	Sulphide Composite	0.59	0.14	0.45

KCA Sample No.	Description	Total Sulphur, %	Sulphide Sulphur, %	Sulphate Sulphur, %
92908 A	High Grade Composite	0.06	0.01	0.05
92909 A	Medium Grade Composite	0.03	0.01	0.02
92910 A	Low Grade Composite	0.04	0.02	0.02
92904 A	Sulphide Composite	1.74	1.01	0.73

The sequential copper leach test work is presented in Table 13-21. The oxide composite results indicated a copper leach amenability by both sodium cyanide and acid, but stronger with the acid solution. The direct sodium cyanide leach was able to recover between 31% and 68% of the copper, while the acid solution (sulphuric acid/iron(III) sulphate) recovered between 80% and 90% of the copper. The sulphide composite results recovered about 25% of the copper with a direct sodium cyanide leach, while the acid solution (sulphuric acid/iron(III) sulphate) recovered about 8% of the copper.

Table 13-21
P2 Gold (2022) – KCA – Copper Sequential Leach on Oxide Composites

Description	High Grade Composite		Medium Grade Composite		Low Grade Composite		Notes
	Assay mg Cu/kg	% Ext	Assay mg Cu/kg	% Ext	Assay mg Cu/kg	% Ext	
KCA Sample No.	92908 A		92909 A		92910 A		
Head Assay							
Total Copper	4,732	--	3,027	--	2,538	--	4-Acid digestion
Direct Cyanide							
Total Copper	4,732	100%	3,027	100%	2,538	100%	4-Acid digestion
CN Sol. Copper	3,160	67%	2,070	68%	785	31%	5 gpL NaCN Solution
Sequential Copper							
Total Copper	4,450	--	3,025	--	2,600	--	4-Acid digestion
Calc. Copper Head	4,350	100%	2,968	100%	2,489	100%	Calculated
Acid Sol. Copper	3,920	90%	2,648	89%	1,984	80%	H ₂ SO ₄ /Fe ₂ (SO ₄) ₃ Solution
CN Sol. Copper	78	2%	52	2%	73	3%	5 gpL NaCN Solution
Residual Copper	352	8%	268	9%	432	17%	4-Acid digestion

Table 13-22
P2 Gold (2022) – KCA – Copper Sequential Leach on Sulphide Composites

Description	Sulphide Composite		Notes
KCA Sample No.	92904 A		
	Average mg Cu/kg	% Ext	
Head Assay			
Total Copper	2,566	--	4-Acid digestion
Direct Cyanide			
Total Copper	2,566	100%	4-Acid digestion
CN Sol. Copper	647	25%	5 gpL NaCN Solution
Sequential Copper			
Total Copper	2,738	--	4-Acid digestion
Calc. Copper Head	2,914	100%	Calculated
Acid Sol. Copper	246	8%	H ₂ SO ₄ /Fe ₂ (SO ₄) ₃ Solution
CN Sol. Copper	184	6%	5 gpL NaCN Solution
Residual Copper	2,484	85%	4-Acid digestion

The results of the multielement and whole rock analyses are presented in Table 13-23 and Table 13-24.

Table 13-23
P2 Gold (2022) – KCA – Multielement Analyses on Oxide and Sulphide Composites

Constituent	Unit	High Grade Composite KCA Sample No. 92908 A	Medium Grade Composite KCA Sample No. 92909 A	Low Grade Composite KCA Sample No. 92910 A	Sulphide Composite KCA Sample No. 92904 A
Al	%	7.79	6.68	3.05	3.71
As	mg/kg	35	38	4	4
Ba	mg/kg	1151	758	133	136
Bi	mg/kg	<2	<2	<2	<2
C _(total)	%	0.43	0.80	0.82	0.59
C _(organic)	%	0.08	0.10	0.07	0.14
C _(inorganic)	%	0.35	0.70	0.75	0.45
Ca	%	1.45	4.26	8.47	8.09
Cd	mg/kg	2	<1	2	2
Co	mg/kg	12	11	40	63
Cr	mg/kg	58	205	598	664
Cu _(total)	mg/kg	4732	3027	2538	2566
Fe	%	2.39	2.92	8.87	8.82
Hg	mg/kg	10.38	11.18	12.96	1.90
K	%	4.62	4.03	1.17	1.70
Mg	%	0.72	2.90	9.08	8.73
Mn	mg/kg	246	424	832	1013
Mo	mg/kg	6	10	15	34
Na	%	1.79	1.73	0.42	0.54
Ni	mg/kg	28	30	132	215
Pb	mg/kg	21	<10	<10	<10
S _(total)	%	0.06	0.03	0.04	1.74
S _(sulphide)	%	0.01	0.01	0.02	1.01
S _(sulphate)	%	0.05	0.02	0.02	0.73
Sb	mg/kg	80	81	22	19
Se	mg/kg	5	5	<5	5
Sr	mg/kg	144	166	104	102
Te	mg/kg	6	6	11	13
Ti	%	0.10	0.12	0.24	0.29
V	mg/kg	183	163	236	178
W	mg/kg	<10	<10	<10	10
Zn	mg/kg	95	13	62	29

Table 13-24
P2 Gold (2022) – KCA – Whole Rock Analyses on Oxide and Sulphide Composites

Constituent	Unit	High Grade Composite KCA Sample No. 92908 A		Medium Grade Composite KCA Sample No. 92909 A		Low Grade Composite KCA Sample No. 92910 A		Sulphide Composite KCA Sample No. 92904 A	
SiO ₂	%	65.20		59.53		46.07		48.27	
Si	%		30.48		27.83		21.54		22.57
Al ₂ O ₃	%	14.60		12.35		5.77		6.97	
Al	%		7.73		6.54		3.05		3.69
Fe ₂ O ₃	%	3.18		4.15		11.75		12.29	
Fe	%		2.22		2.90		8.22		8.59
CaO	%	2.05		5.74		11.66		9.90	
Ca	%		1.47		4.10		8.33		7.08
MgO	%	1.15		4.79		14.32		13.80	
Mg	%		0.69		2.89		8.64		8.32
Na ₂ O	%	2.36		2.36		0.50		0.59	
Na	%		1.75		1.75		0.37		0.44
K ₂ O	%	5.72		4.83		1.38		1.80	
K	%		4.75		4.01		1.15		1.49
TiO ₂	%	0.36		0.33		0.45		0.48	
Ti	%		0.22		0.20		0.27		0.29
MnO	%	0.03		0.07		0.13		0.14	
Mn	%		0.02		0.05		0.10		0.11
SrO	%	0.02		0.02		0.01		0.01	
Sr	%		0.02		0.02		0.01		0.01
BaO	%	0.13		0.09		0.01		0.02	
Ba	%		0.12		0.08		0.01		0.02
Cr ₂ O ₃	%	0.01		0.04		0.11		0.12	
Cr	%		0.01		0.03		0.08		0.08
P ₂ O ₅	%	0.01		0.03		0.02		0.01	
P	%		0.00		0.01		0.01		0.00
LOI _{1090°C}	%	3.79		4.94		6.22		5.25	
SUM	%	98.61		99.27		98.40		99.65	

Note: The SUM is the total of the oxide constituents and the loss on ignition.

13.14.2 P2 Gold (2022) – KCA – Bottle Roll Leach Test Work

The bottle roll tests were completed on the oxide composites (Low, Medium, and High) and sulphide composite. The oxide composites included both milled and HPGR crushed samples,

and the sulphide composite only included a milled sample. Bottle roll tests utilized 1 and 3 g/L NaCN with leach times of 48 (milled) or 240 (HPGR) hours.

For the High-Grade Composite, gold extractions ranged from 41% to 97% based on calculated heads which ranged from 0.957 to 1.995 g/t. Silver extractions ranged from 51% to 84% based on calculated heads ranging from 2.39 to 3.17 g/t. Copper extractions ranged from 50% to 79% based on calculated heads ranging from 3,848 to 4,244 mg/kg. The sodium cyanide consumptions ranged from 5.43 to 7.30 kg/t. The composites required between 0.50 and 0.75 kg/t hydrated lime to maintain an appropriate leaching pH.

For the Medium Grade Composite, gold extractions ranged from 73% to 94% based on calculated heads which ranged from 0.603 to 0.699 g/t. Silver extractions ranged from 39% to 83% based on calculated heads ranging from 1.29 to 1.47 g/t. Copper extractions ranged from 55% to 77% based on calculated heads ranging from 2,637 to 2,715 mg/kg. The sodium cyanide consumptions ranged from 4.35 to 5.25 kg/t. The material utilized in leaching required between 0.50 and 1.00 kg/t hydrated lime to maintain an appropriate leaching pH.

For the Low-Grade Composite, gold extractions ranged from 90% to 93% based on calculated heads which ranged from 0.213 to 0.287 g/t. Silver extractions ranged from 70% to 83% based on calculated heads ranging from 0.37 to 0.61 g/t. Copper extractions ranged from 20% to 24% based on calculated heads ranging from 2,405 to 2,564 mg/kg. The sodium cyanide consumptions ranged from 1.36 to 2.01 kg/t. The material utilized in leaching required between 0.75 and 1.00 kg/t hydrated lime to maintain an appropriate leaching pH.

For the Sulphide Composite, the gold extraction ranged from 50% to 89% based on a calculated head of 0.201 to 0.223 g/t. Silver extractions ranged from 20% to 30% based on calculated heads ranging from 1.08 to 1.78 g/t. Copper extractions ranged from 11% to 12% based on calculated heads ranging from 2,827 to 3,414 mg/kg. The sodium cyanide consumption ranged from 1.20 to 1.99 kg/t. The material utilized in leaching required 0.5 to 0.75 kg/t hydrated lime to maintain an appropriate leaching pH.

The bottle roll leach test work results are presented in Table 13-25.

Table 13-25
P2 Gold (2022) – KCA – Bottle Roll Leach Test Work on Oxide and Sulphide Composites

KCA Sample No.	Description	Target Free NaCN, gpL	p80 Size, mm	Gold	Silver	Copper	Calculated Head, gms Ag/MT	Extracted, gms Ag/MT	Ag Extracted, %	Calculated Head, mg Cu/kg	Extracted, mg Cu/kg	Cu Extracted, %	Leach Time, hours	Consumption NaCN, kg/MT	Addition Ca(OH) ₂ , kg/MT
				Calculated Head, gms Au/MT	Extracted, gms Au/MT	Au Extracted, %									
92908 A	High Grade Composite	1.0	6.4	1.253	0.913	73%	2.39	1.21	51%	3,848	1,909	50%	240	5.72	0.50
92908 A	High Grade Composite	3.0	6.2	1.281	1.039	81%	2.94	1.60	54%	3,873	2,255	58%	240	7.30	0.50
92908 A	High Grade Composite	1.0	0.075	0.957	0.396	41%	2.93	1.71	58%	4,113	2,119	52%	48	5.43	0.75
92908 A	High Grade Composite	3.0	0.075	1.995	1.932	97%	3.17	2.66	84%	4,244	3,358	79%	48	6.94	0.75
92909 A	Medium Grade Composite	1.0	5.5	0.603	0.440	73%	1.36	0.53	39%	2,704	1,484	55%	240	4.35	0.75
92909 A	Medium Grade Composite	3.0	5.4	0.620	0.499	81%	1.29	0.71	55%	2,715	1,671	62%	240	5.25	0.50
92909 A	Medium Grade Composite	1.0	0.075	0.699	0.659	94%	1.47	1.02	70%	2,709	1,779	66%	48	4.63	1.00
92909 A	Medium Grade Composite	3.0	0.075	0.648	0.594	92%	1.38	1.14	83%	2,637	2,041	77%	48	4.74	0.75
92910 A	Low Grade Composite	1.0	5.1	0.223	0.201	90%	0.37	0.26	70%	2,405	515	21%	240	1.36	1.00
92910 A	Low Grade Composite	3.0	4.7	0.213	0.198	93%	0.53	0.43	81%	2,564	614	24%	240	2.01	0.75
92910 A	Low Grade Composite	1.0	0.075	0.287	0.268	93%	0.61	0.50	83%	2,520	501	20%	48	1.43	1.00
92904 A	Sulphide Composite	3.0	6.0	0.201	0.100	50%	1.78	0.35	20%	3,414	393	12%	240	1.99	0.50
92904 A	Sulphide Composite	1.0	0.075	0.223	0.199	89%	1.08	0.33	30%	2,827	303	11%	48	1.20	0.75

13.14.3 P2 Gold (2022) – KCA – Flotation Test Work

Flotation test work was performed on each of the oxide and sulphide composites. Rougher flotation was performed on the High, Medium and Low Grade Composites for either the purpose of product analyses or product leaching. Rougher and cleaner flotation was performed on the Sulphide Composite for either the purpose of product analyses or product leaching. The flotation concentrates of the oxide composites were further leached in two stages with sodium cyanide and sulphuric acid. The flotation tails were also leached with sodium cyanide. The overall results of the flotation test work with the additional stages of leaching are as follows:

- For the High Grade Composite, the leaching of flotation products extracted 95% of the gold, 80% of the silver and 77% of the copper utilizing 6.03 kg/t NaCN and 2.45 kg/t H₂SO₄.
- For the Medium Grade Composite, the leaching of flotation products extracted 90% of the gold, 82% of the silver and 75% of the copper utilizing 3.45 kg/t NaCN and 10.41 kg/t H₂SO₄.
- For the Low Grade Composite, the leaching of flotation products extracted 90% of the gold, 63% of the silver and 34% of the copper utilizing 1.34 kg/MT NaCN and 6.55 kg/t H₂SO₄.
- For the Sulphide Composite, the leaching of flotation products extracted 77% of the gold, 51% of the silver and 77% of the copper utilizing 0.72 kg/ MT NaCN.

The results of the flotation test work, with additional stages of leaching, are presented in Table 13-26 through Table 13-28.

Table 13-26
P2 Gold (2022) – KCA – Flotation Test Work on Oxide and Sulphide Composites (Gold)

KCA Sample No.	Description	Flotation Product	Weight Fraction	Au Distrib.	Leach Type	Leach Time, hours	Calculated Head, gms Au/MT	Extracted, gms Au/MT	Au Ext. (Ov'all), %	Consump. H ₂ SO ₄ , kg/MT	Consump. NaCN, kg/MT	Addition Ca(OH) ₂ , kg/MT
92908 A	High Grade Composite	Ro. Con.	2.9%	59%	pH 2, H ₂ SO ₄	6	25.569	0.182	0%	85.33	--	--
					5 gpL, NaCN	24	25.387	25.166	58%	--	9.23	3.16
		Ro. Tail	97.1%	41%	3 gpL, NaCN	48	0.529	0.471	37%	--	5.93	0.76
		Overall		--	1.248	1.185	95%	2.45	6.03	0.83		
92909 A	Medium Grade Composite	Ro. Con.	5.2%	50%	pH 2, H ₂ SO ₄	6	6.084	0.000	0%	201.63	--	--
					5 gpL, NaCN	24	6.084	5.911	49%	--	9.58	1.95
		Ro. Tail	94.8%	50%	3 gpL, NaCN	48	0.331	0.276	42%	--	3.12	0.76
		Overall		--	0.628	0.567	90%	10.41	3.45	0.82		
92910 A	Low Grade Composite	Ro. Con.	5.9%	40%	pH 2, H ₂ SO ₄	6	1.697	0.000	0%	111.67	--	--
					5 gpL, NaCN	24	1.697	1.663	39%	--	6.45	2.41
		Ro. Tail	94.1%	60%	3 gpL, NaCN	48	0.161	0.137	51%	--	1.02	0.76
		Overall		--	0.251	0.226	90%	6.55	1.34	0.86		
92904 A	Sulphide Composite	Cl. 2 Con.	1.1%	63%	--	--	6.998	--	63%	--	--	--
		Ro. Tail	92.7%	17%	3 gpL, NaCN	48	0.119	0.097	14%	--	0.72	0.50
		Overall		--	--	--	77%	--	0.72	0.50		

Table 13-27
P2 Gold (2022) – KCA – Flotation Test Work on Oxide and Sulphide Composites (Silver)

KCA Sample No.	Description	Flotation Product	Weight Fraction	Ag Distrib.	Leach Type	Leach Time, hours	Calculated Head, gms Ag/MT	Extracted, gms Ag/MT	Ag Ext. (Ov'all), %	Consump. H ₂ SO ₄ , kg/MT	Consump. NaCN, kg/MT	Addition Ca(OH) ₂ , kg/MT
92908 A	High Grade Composite	Ro. Con.	2.9%	38%	pH 2, H ₂ SO ₄	6	43.15	0.00	0%	85.33	--	--
					5 gpL, NaCN	24	43.15	37.37	33%	--	9.23	3.16
		Ro. Tail	97.1%	62%	3 gpL, NaCN	48	2.09	1.57	47%	--	5.93	0.76
		Overall		--	3.27	2.60	80%	2.45	6.03	0.83		
92909 A	Medium Grade Composite	Ro. Con.	5.2%	38%	pH 2, H ₂ SO ₄	6	10.12	0.00	0%	201.63	--	--
					5 gpL, NaCN	24	10.12	7.30	28%	--	9.58	1.95
		Ro. Tail	94.8%	62%	3 gpL, NaCN	48	0.88	0.78	54%	--	3.12	0.76
		Overall		--	1.36	1.12	82%	10.41	3.45	0.82		
92910 A	Low Grade Composite	Ro. Con.	5.9%	51%	pH 2, H ₂ SO ₄	6	6.35	0.00	0%	111.67	--	--
					5 gpL, NaCN	24	6.35	3.33	27%	--	6.45	2.41
		Ro. Tail	94.1%	49%	3 gpL, NaCN	48	0.39	0.28	36%	--	1.02	0.76
		Overall		--	0.74	0.46	63%	6.55	1.34	0.86		
92904 A	Sulphide Composite	Cl. 2 Con.	1.1%	13%	--	--	45.26	--	13%	--	--	--
		Ro. Tail	92.7%	76%	3 gpL, NaCN	48	0.21	0.10	38%	--	0.72	0.50
		Overall		--	--	--	51%	--	0.72	0.50		

Table 13-28
P2 Gold (2022) – KCA – Flotation Test Work on Oxide and Sulphide Composites (Copper)

KCASample No.	Description	FlotationProduct	Weight Fraction	Cu Distrib.	LeachType	Leach Time, hours	Calculated Head, mg Cu/kg	Extracted, mg Cu/kg	Cu Ext. (Ov'all), %	Consump. H ₂ SO ₄ , kg/MT	Consump. NaCN, kg/MT	Addition Ca(OH) ₂ , kg/MT
92908 A	High Grade Composite	Ro. Con.	2.9%	20%	pH 2, H ₂ SO ₄	6	28,708	27,034	19%	85.33	--	--
					5 gpL, NaCN	24	1,674	111	0%	--	9.23	3.16
		Ro. Tail	97.1%	80%	3 gpL, NaCN	48	3,310	2,385	57%	--	5.93	0.76
		Overall					--	4,039	3,095	77%	2.45	6.03
92909 A	Medium Grade Composite	Ro. Con.	5.2%	32%	pH 2, H ₂ SO ₄	6	15,597	14,693	30%	201.63	--	--
					5 gpL, NaCN	24	904	31	0%	--	9.58	1.95
		Ro. Tail	94.8%	68%	3 gpL, NaCN	48	1,840	1,219	45%	--	3.12	0.76
		Overall					--	2,550	1,916	75%	10.41	3.45
92910 A	Low Grade Composite	Ro. Con.	5.9%	18%	pH 2, H ₂ SO ₄	6	5,567	4,135	14%	111.67	--	--
					5 gpL, NaCN	24	1,432	30	0%	--	6.45	2.41
		Ro. Tail	94.1%	82%	3 gpL, NaCN	48	1,559	390	20%	--	1.02	0.76
		Overall					--	1,794	612	34%	6.55	1.34
92904 A	Sulphide Composite	Cl. 2 Con.	1.1%	71%	--	--	186,000	--	71%	--	--	--
		Ro. Tail	92.7%	16%	3 gpL, NaCN	48	389	152	6%	--	0.72	0.50
		Overall					--	--	--	77%	--	0.72

13.14.4 P2 Gold (2022) – KCA – Agglomeration and Compacted Permeability

Preliminary agglomeration test work along with compacted permeability test work was conducted on portions of the oxides and sulphide composites.

The purpose of the preliminary agglomeration tests was to examine the permeability of the material under various cement agglomeration levels. The composites were loaded into a column and subjected to loads equivalent to 0, 35 and 70 meters of overall heap height (assuming a heap density equivalent to 1.6 tonnes per cubic meter).

The results of the compaction permeability test work with agglomerated composites are presented in Table 13-29.

For the High Grade Composite, the test completed at 4 kg/t cement failed the KCA criteria at 70 meters due to insufficient flow and the test at 2 kg/t cement passed the KCA criteria at all elevations.

For the Medium Grade Composite, the test completed at 4 kg/t cement failed the KCA criteria at 35 and 70 meters due to insufficient flow rate. The test completed at 8 kg/t cement passed the KCA criteria at all elevations.

For the Low Grade Composite, the test completed at 4 kg/t cement failed the KCA criteria at 0, 35 and 70 meters due to insufficient flow rate. The test completed at 12 kg/t cement failed the KCA criteria at 70 meters due to insufficient flow rate. The remaining heap heights passed the KCA criteria (0 and 35 meters).

**Table 13-29
P2 Gold (2022) – KCA – Compacted Permeability Test Work with Agglomerated Oxide and Sulphide Composites**

KCA Sample No.	KCA Test No.	Sample Description	Ore Size, mm	Test Phase	Cement Added, kg/MT	Effective Height, meter	Flow Rate, L/hr/m ²	Flow Result Pass/Fail	Saturated Permeability, cm/sec	Incremental Slump, %	Cum. Slump, % Slump	Slump Result Pass/Fail	% Pellet Breakdown	Breakdown Result Pass/Fail	Overall Pass/Fail
92908 A	92911 A	High Grade Composite	HPGR Crushed	Primary	4	0	4,465	Pass	0.124	0%	0%	Pass	--	--	Pass
				Stage Load		35	170	Pass	0.005	4%	5%	Pass	--	--	Pass
				Stage Load		70	30	Fail	0.001	5%	9%	Pass	>15%	Fail	Fail
92908 A	92912 A	High Grade Composite	HPGR Crushed	Primary	2	0	5,630	Pass	0.156	0%	0%	Pass	--	--	Pass
				Stage Load		35	2,382	Pass	0.066	6%	6%	Pass	--	--	Pass
				Stage Load		70	568	Pass	0.016	4%	9%	Pass	>15%	Fail	Fail
92909 A	92911 B	Medium Grade Composite	HPGR Crushed	Primary	4	0	4,631	Pass	0.129	0%	0%	Pass	--	--	Pass
				Stage Load		35	45	Fail	0.001	6%	6%	Pass	--	--	Fail
				Stage Load		70	11	Fail	0.000	4%	10%	Pass	>15%	Fail	Fail
92909 A	92912 B	Medium Grade Composite	HPGR Crushed	Primary	8	0	6,305	Pass	0.175	0%	0%	Pass	--	--	Pass
				Stage Load		35	560	Pass	0.016	7%	6%	Pass	--	--	Pass
				Stage Load		70	102	Pass	0.003	5%	12%	Pass	>15%	Fail	Fail
92910 A	92911 C	Low Grade Composite	HPGR Crushed	Primary	4	0	86	Fail	0.002	1%	1%	Pass	--	--	Fail
				Stage Load		35	14	Fail	0.000	5%	6%	Pass	--	--	Fail
				Stage Load		70	15	Fail	0.000	4%	10%	Pass	>15%	Fail	Fail
92910 A	92912 C	Low Grade Composite	HPGR Crushed	Primary	12	0	6,130	Pass	0.170	0%	0%	Pass	--	--	Pass
				Stage Load		35	256	Pass	0.007	6%	6%	Pass	--	--	Pass
				Stage Load		70	21	Fail	0.001	7%	12%	Pass	5%	Pass	Fail

Note: Primary Pass/Fail Criteria

1. In KCA's compacted agglomeration tests, a slump of over 15% is generally an indication of failure. One item also examined is the consistency of results with regard to slump. If things worked perfectly, a lower slump with higher cement levels could be expected.
2. A typical heap leach solution application rate of 10 to 12 litres per hour per square meter is utilized when examining the agglomeration data. When examining results from this type of agglomeration test a measured flow of ten times (10X) the heap design rate is considered a "pass". A measured flow less than 10X the heap design flow is not necessarily a failure. If there are enough tests with enough consistency between tests, and all other points indicate a "pass," and then sometimes a test will pass with less than the 10X flow. However, a test will not likely pass at 1X and probably not at 4X.
3. In examining the Pellet Breakdown, about 10% is marginally acceptable and anything higher is a failure. In general, a higher range is allowable in Pellet Breakdown as this is a subjective value based on the visual observation of the pellets after the test by the technicians performing the test. When the samples tested are not agglomerated using cement, this test is not applicable.
4. Solution colour and clarity typically is an indicator of agglomerate failure and fines migration. This information is utilized in coordination with both slump as well as Pellet Breakdown to determine if the test passes.

13.14.5 P2 Gold (2022) – KCA – Column Leach Test Work

Column leach tests were conducted utilizing HPGR crushed material blended with cement. During testing, the material was leached for 126, 141 or 150 days with a sodium cyanide solution. Throughout the testing, SART was performed intermittently on the pregnant solution collected each day.

Gold extractions ranged from 74% to 89% based on calculated heads which ranged from 0.239 to 1.323 g/t. The sodium cyanide consumptions ranged from 3.62 to 8.83 kg/t. The material utilized in leaching was agglomerated with 2.01 to 11.79 kg/t cement.

The SART test work was performed in order to remove silver and copper from the leach solution and liberate the associated cyanide. Gold cyanide complexes remained largely unchanged throughout the SART process. The silver extraction from SART accounted for 93% of the total silver, and the copper extraction from SART accounted for 98% of the total copper extraction of the High Grade Composite. It should be noted that the Medium and Low Grade Composites were only SART treated for 58 and 26 days, respectively versus 88 days of SART treatments for the High Grade Composite.

The results of the column leach test work are presented in Table 13-30, and the results of the SART test work in Table 13-31.

Table 13-30
P2 Gold (2022) – KCA – Column Leach Test Work of Oxide and Sulphide Composites

KCA Sample No.	KCA Test No.	Description	Crush Type	Calculated Head, gms Au/MT	SART Extracted, gms Au/MT	Carbon Extracted, gms Au/MT	Weighted Avg. Tail Screen, gms Au/MT	Total Extracted, % Au	Calculated Tail p80 Size, mm	Days of Leach	Consumption NaCN, kg/MT	Addition Cement, kg/MT
92908 A	92918	High Grade Composite	HPGR	1.323	0.021	1.153	0.149	89%	6.7	150	8.83	2.01
92909 A	92921	Medium Grade Composite	HPGR	0.620	<0.001	0.456	0.164	74%	5.3	142	5.95	7.86
92910 A	92924	Low Grade Composite	HPGR	0.239	<0.001	0.201	0.038	84%	5.2	126	3.62	11.79

KCA Sample No.	KCA Test No.	Description	Crush Type	Calculated Head, gms Ag/MT	SART Extracted, gms Ag/MT	Carbon Extracted, gms Ag/MT	Weighted Avg. Tail Screen, gms Ag/MT	Total Extracted, % Ag	Calculated Tail p80 Size, mm	Days of Leach	Consumption NaCN, kg/MT	Addition Cement, kg/MT
92908 A	92918	High Grade Composite	HPGR	3.30	1.63	0.13	1.54	53%	6.7	150	8.83	2.01
92909 A	92921	Medium Grade Composite	HPGR	1.77	0.10	0.50	1.17	34%	5.3	142	5.95	7.86
92910 A	92924	Low Grade Composite	HPGR	0.56	0.05	0.26	0.25	55%	5.2	126	3.62	11.79

KCA Sample No.	KCA Test No.	Description	Crush Type	Calculated Head, mg Cu/kg	SART Extracted, mg Cu/kg	Carbon Extracted, mg Cu/kg	Weighted Avg. Tail Screen, mg Cu/kg	Total Extracted, % Cu	Calculated Tail p80 Size, mm	Days of Leach	Consumption NaCN, kg/MT	Addition Cement, kg/MT
92908 A	92918	High Grade Composite	HPGR	4,291	2,604	61	1,626	53%	6.7	150	8.83	2.01
92909 A	92921	Medium Grade Composite	HPGR	2,813	1,384	196	1,233	34%	5.3	142	5.95	7.86
92910 A	92924	Low Grade Composite	HPGR	2,553	711	123	1,719	55%	5.2	126	3.62	11.79

**Table 13-31
P2 Gold (2022) – KCA – Column Leach SART Test Work of Oxide and Sulphide
Composites**

KCA Sample No.	KCA Test No.	Description	Days of SART Treatment	SART Extracted, % Ag	Total Extracted, % Ag	SART % of Total Extraction
92908 A	92918	High Grade Composite	88	49%	60%	82%
92909 A	92921	Medium Grade Composite	58	6%	34%	17%
92910 A	92924	Low Grade Composite	26	9%	55%	16%

KCA Sample No.	KCA Test No.	Description	Days of SART Treatment	SART Extracted, % Cu	Total Extracted, % Cu	SART % of Total Extraction
92908 A	92918	High Grade Composite	88	61%	62%	98%
92909 A	92921	Medium Grade Composite	58	49%	56%	88%
92910 A	92924	Low Grade Composite	26	28%	33%	84%

13.15 P2 GOLD (2022) – KCA – Metallurgical Test Program on Monzonite and Pyroxenite Composites

On 18 November 2021, KCA received RC drill cuttings from three (3) separate drill holes. The intervals from each drill hole were sorted by rock type into two (2) groups (monzonite and pyroxenite). The monzonite and pyroxenite composites were then utilized for metallurgical test work, including head analyses, bottle roll leach test work and flotation test work.

13.15.1 P2 Gold (2022) – KCA – Head Analyses

For the monzonite composite, the results of the head assays averaged 1.291 g/t for gold, 2.01 g/t for silver, and 4,663 mg/kg for copper.

For the pyroxenite composite, the results of the head assays averaged 0.494 g/t for gold, 1.03 g/t for silver, and 4,947 mg/kg for copper.

The results of the head assays for gold, silver and copper are presented in Table 13-32.

**Table 13-32
P2 Gold (2022) – KCA Head Assays of Monzonite and Pyroxenite Composites**

KCA Sample No.	Description	Assay 1, gms Au/MT	Assay 2, gms Au/MT	Average Assay, gms Au/MT
92937 A	Monzonite Composite	1.318	1.263	1.291
92938 A	Pyroxenite Composite	0.516	0.471	0.494

KCA Sample No.	Description	Assay 1, gms Ag/MT	Assay 2, gms Ag/MT	Average Assay, gms Ag/MT
92937 A	Monzonite Composite	2.01	2.01	2.01
92938 A	Pyroxenite Composite	1.06	0.99	1.03

KCA Sample No.	Description	Assay 1, mg Cu/kg	Assay 2, mg Cu/kg	Average Assay, mg Cu/kg
92937 A	Monzonite Composite	4652	4713	4663
92938 A	Pyroxenite Composite	4962	4875	4947

The total carbon content of the composites ranged from 0.69% to 1.32%, with a majority inorganic carbon. The total sulphur content ranged from 0.68% and 0.86%. The results of the carbon and sulphur analyses are presented in Table 13-33.

Table 13-33
P2 Gold (2022) – KCA – Carbon and Sulphur Analyses on Monzonite and Pyroxenite Composites

KCA Sample No.	Description	Total Carbon, %	Organic Carbon, %	Inorganic Carbon, %
92937 A	Monzonite Composite	0.69	0.15	0.54
92938 A	Pyroxenite Composite	1.32	0.10	1.22

KCA Sample No.	Description	Total Sulphur, %	Sulphide Sulphur, %	Sulphate Sulphur, %
92937 A	Monzonite Composite	0.86	0.39	0.47
92938 A	Pyroxenite Composite	0.68	0.24	0.44

The sequential copper leach test work is presented in Table 13-34. The direct sodium cyanide leach of the monzonite composite was able to recover about 15% of the copper, while the acid solution (sulphuric acid/iron(III) sulphate) recovered about 4% of the copper. The pyroxenite composite result recovered about 14% of the copper with a direct sodium cyanide leach, while the acid solution (sulphuric acid/iron(III) sulphate) recovered about 3% of the copper.

**Table 13-34
P2 Gold (2022) – KCA – Copper Sequential Leach on Monzonite and Pyroxenite Composites**

Description	Monzonite Composite		Pyroxenite Composite		Notes
KCA Sample No.	92937 A		92938 A		
	Assay mg Cu/kg	% Ext	Assay mg Cu/kg	% Ext	
Head Assay					
Total Copper	4,663	--	4,947	--	4-Acid digestion
Direct Cyanide					
Total Copper	4,652	100%	4,962	100%	4-Acid digestion
CN Sol. Copper	712	15%	680	14%	5 gpL NaCN Solution
Sequential Copper					
Total Copper	4,652	--	4,962	--	4-Acid digestion
Calc. Copper Head	4,517	100%	5,080	100%	Calculated
Acid Sol. Copper	169	4%	171	3%	H ₂ SO ₄ /Fe ₂ (SO ₄) ₃ Solution
CN Sol. Copper	220	5%	221	4%	5 gpL NaCN Solution
Residual Copper	4,128	91%	4,688	92%	4-Acid digestion

The results of the multielement and whole rock analyses are presented in Table 13-35 and Table 13-36.

Table 13-35

P2 Gold (2022) – KCA – Multielement Analyses on Monzonite and Pyroxenite Composites

Constituent	Unit	Monzonite Composite KCA Sample No. 92937 A	Pyroxenite Composite KCA Sample No. 92938 A
Al	%	8.07	1.55
As	mg/kg	5	<2
Ba	mg/kg	1,194	190
Bi	mg/kg	<2	<2
C _(total)	%	0.69	1.32
C _(organic)	%	0.15	0.10
C _(inorganic)	%	0.54	1.22
Ca	%	2.39	10.37
Cd	mg/kg	2	3
Co	mg/kg	6	30
Cr	mg/kg	46	975
Cu _(total)	mg/kg	4,663	4,947
Fe	%	2.60	6.33
Hg	mg/kg	1.10	1.18
K	%	4.96	0.88
Mg	%	1.06	9.78
Mn	mg/kg	268	1326
Mo	mg/kg	12	39
Na	%	2.25	0.44
Ni	mg/kg	8	110
Pb	mg/kg	<10	<10
S _(total)	%	0.86	0.68
S _(sulphide)	%	0.39	0.24
S _(sulphate)	%	0.47	0.44
Sb	mg/kg	9	12
Se	mg/kg	12	10
Sr	mg/kg	291	215
Te	mg/kg	6	8
Ti	%	0.17	0.17
V	mg/kg	212	232
W	mg/kg	<10	<10
Zn	mg/kg	20	32

Table 13-36

P2 Gold (2022) – KCA – Whole Rock Analyses on Monzonite and Pyroxenite Composites

Constituent	Unit	Monzonite Composite KCA Sample No. 92937 A		Pyroxenite Composite KCA Sample No. 92938 A	
SiO ₂	%	62.77		49.18	
Si	%		29.35		22.99
Al ₂ O ₃	%	15.65		3.94	
Al	%		8.28		2.09
Fe ₂ O ₃	%	3.29		7.78	
Fe	%		2.30		5.44
CaO	%	3.28		13.94	
Ca	%		2.34		9.96
MgO	%	1.68		15.95	
Mg	%		1.01		9.62
Na ₂ O	%	2.90		0.48	
Na	%		2.15		0.36
K ₂ O	%	5.63		0.98	
K	%		4.67		0.81
TiO ₂	%	0.38		0.30	
Ti	%		0.23		0.18
MnO	%	0.03		0.17	
Mn	%		0.02		0.13
SrO	%	0.03		0.02	
Sr	%		0.03		0.02
BaO	%	0.12		0.19	
Ba	%		0.11		0.17
Cr ₂ O ₃	%	0.01		0.14	
Cr	%		0.01		0.10
P ₂ O ₅	%	<0.01		<0.01	
P	%		<0.01		<0.01
LOI _{1090°C}	%	4.23		6.97	
SUM	%	100.00		100.04	

Note - The SUM is the total of the oxide constituents and the loss on ignition.

13.15.2 P2 Gold (2022) – KCA – Bottle Roll Leach Test Work

The bottle roll tests were completed on the monzonite and pyroxenite composites. Portions of the composites were both milled to a target size of 80% passing 0.106 mm. The bottle roll leach tests utilized 1 g/L NaCN and leached for a period of 48 hours.

For the monzonite composite, gold extractions were about 91% based on a calculated head of 1.361 g/t. Silver extraction was about 33% based on a calculated head of 1.32 g/t. Copper extraction was about 12% based on a calculated head of 3,002 mg/kg. The sodium cyanide consumption was measured at 1.57 kg/t, and the hydrated lime consumption was 0.5 kg/t.

For the pyroxenite composite, gold extractions were about 94% based on a calculated head of 0.754 g/t. Silver extraction was about 43% based on a calculated head of 0.79 g/t. Copper extraction was about 6% based on a calculated head of 3,179 mg/kg. The sodium cyanide consumption was measured at 1.44 kg/t, and the hydrated lime consumption was 1.00 kg/t.

The bottle roll leach test work results are presented in Table 13-37.

Table 13-37
P2 Gold (2022) – KCA – Bottle Roll Leach Test Work on Monzonite and Pyroxenite Composites

KCA Sample No.	KCA Test No.	Description	Target Free NaCN, gpL	Target p80 Size, mm	Head Average, gms Au/MT	Calculated Head, gms Au/MT	Extracted, gms Au/MT	Avg. Tails, gms Au/MT	Au Extracted, %	Leach Time, hours	Consumption NaCN, kg/MT	Addition Ca(OH) ₂ , kg/MT
92937 A	92954 A	Monzonite Composite	1.0	0.106	1.291	1.361	1.241	0.120	91%	48	1.57	0.50
92938 A	92954 B	Pyroxenite Composite	1.0	0.106	0.494	0.754	0.710	0.045	94%	48	1.44	1.00

KCA Sample No.	KCA Test No.	Description	Target Free NaCN, gpL	Target p80 Size, mm	Head Average, gms Ag/MT	Calculated Head, gms Ag/MT	Extracted, gms Ag/MT	Avg. Tails, gms Ag/MT	Ag Extracted, %	Leach Time, hours	Consumption NaCN, kg/MT	Addition Ca(OH) ₂ , kg/MT
92937 A	92954 A	Monzonite Composite	1.0	0.106	2.01	1.32	0.43	0.89	33%	48	1.57	0.50
92938 A	92954 B	Pyroxenite Composite	1.0	0.106	1.03	0.79	0.34	0.45	43%	48	1.44	1.00

KCA Sample No.	KCA Test No.	Description	Target Free NaCN, gpL	Target p80 Size, mm	Head Average, mg Cu/kg	Calculated Head, mg Cu/kg	Extracted, mg Cu/kg	Avg. Tails, mg Cu/kg	Cu Extracted, %	Leach Time, hours	Consumption NaCN, kg/MT	Addition Ca(OH) ₂ , kg/MT
92937 A	92954 A	Monzonite Composite	1.0	0.106	4,663	3,002	352	2,650	12%	48	1.57	0.50
92938 A	92954 B	Pyroxenite Composite	1.0	0.106	4,947	3,179	204	2,975	6%	48	1.44	1.00

13.15.3 P2 Gold (2022) – KCA – Flotation Test Work

Flotation test work (rougher and cleaner) was performed on the monzonite and pyroxenite composites for either the purpose of product analyses or product leaching.

The flotation concentrates were assayed for gold, silver and copper without any additional leaching, while the flotation tails were leached with NaCN for a period of 48 hours.

The overall results of the flotation test work with the additional stages of leaching are as follows:

- For the monzonite composite, the concentrate contained about 76% of the gold, 17% of the silver and 74% of the copper. The leaching of flotation tails extracted about 13% of the gold, 15% of the silver and 3% of the copper utilizing 0.87 kg/t NaCN and 0.50 kg/t hydrated lime. An overall metal extraction was calculated at 89% gold, 32% silver, and 77% copper.
- For the pyroxenite composite, the concentrate contained about 69% of the gold, 19% of the silver and 63% of the copper. The leaching of flotation tails extracted about 15% of the gold, 20% of the silver and 4% of the copper utilizing 1.52 kg/t NaCN and 0.50 kg/t hydrated lime. An overall metal extraction was calculated at 84% gold, 40% silver, and 67% copper.

The results of the flotation test work, with additional stages of leaching, are presented in Table 13-38.

Table 13-38
P2 Gold (2022) – KCA – Flotation Test Work on Monzonite and Pyroxenite Composites

KCA Sample No.	Description	Target p80, mm	KCA Flotation Sample No.	Flotation Product	Weight Fraction	Flot. Au Distrib.	KCA Leach Test No.	Leach Type	Leach Time, hours	Calculated Head, gms Au/MT	Extracted, gms Au/MT	Tails, gms Au/MT	Au Ext. (Stage), %	Au Ext. (Ov'all), %	Consump. NaCN, kg/MT	Addition Ca(OH) ₂ , kg/MT
92937 A	Monzonite Composite	0.106	92952 A	Cl. 2 Con.	1.2%	76%	--	--	--	87.943	--	--	100%	76%	--	--
			92952 D	Ro. Tail	95.4%	15%	92957 A	3 gpL, NaCN	48	0.599	0.518	0.081	87%	13%	0.87	0.50
Overall									--	--	--	--	89%	89%	0.87	0.50
92938 A	Pyroxenite Composite	0.106	92953 A	Cl. 2 Con.	2.0%	69%	--	--	--	16.286	--	--	100%	69%	--	--
			92953 D	Ro. Tail	91.4%	18%	92957 B	3 gpL, NaCN	48	0.215	0.182	0.033	85%	15%	1.52	0.50
Overall									--	--	--	--	84%	84%	1.52	0.50

KCA Sample No.	Description	Target p80, mm	KCA Flotation Sample No.	Flotation Product	Weight Fraction	Flot. Ag Distrib.	KCA Leach Test No.	Leach Type	Leach Time, hours	Calculated Head, gms Ag/MT	Extracted, gms Ag/MT	Tails, gms Ag/MT	Ag Ext. (Stage), %	Ag Ext. (Ov'all), %	Consump. NaCN, kg/MT	Addition Ca(OH) ₂ , kg/MT
92937 A	Monzonite Composite	0.106	92952 A	Cl. 2 Con.	1.2%	17%	--	--	--	89.38	--	--	100%	17%	--	--
			92952 D	Ro. Tail	95.4%	77%	92957 A	3 gpL, NaCN	48	0.90	0.18	0.72	20%	15%	0.87	0.50
Overall									--	--	--	--	32%	32%	0.87	0.50
92938 A	Pyroxenite Composite	0.106	92953 A	Cl. 2 Con.	2.0%	19%	--	--	--	33.74	--	--	100%	19%	--	--
			92953 D	Ro. Tail	91.4%	67%	92957 B	3 gpL, NaCN	48	0.64	0.20	0.45	31%	20%	1.52	0.50
Overall									--	--	--	--	40%	40%	1.52	0.50

KCA Sample No.	Description	Target p80, mm	KCA Flotation Sample No.	Flotation Product	Weight Fraction	Flot. Cu Distrib.	KCA Leach Test No.	Leach Type	Leach Time, hours	Calculated Head, mg Cu/kg	Extracted, mg Cu/kg	Tails, mg Cu/kg	Cu Ext. (Stage), %	Cu Ext. (Ov'all), %	Consump. NaCN, kg/MT	Addition Ca(OH) ₂ , kg/MT
92937 A	Monzonite Composite	0.106	92952 A	Cl. 2 Con.	1.2%	74%	--	--	--	273,300	--	--	100%	74%	--	--
			92952 D	Ro. Tail	95.4%	18%	92957 A	3 gpL, NaCN	48	1,008	193	815	19%	3%	0.87	0.50
Overall									--	--	--	--	77%	77%	0.87	0.50
92938 A	Pyroxenite Composite	0.106	92953 A	Cl. 2 Con.	2.0%	63%	--	--	--	146,000	--	--	100%	63%	--	--
			92953 D	Ro. Tail	91.4%	20%	92957 B	3 gpL, NaCN	48	1,265	260	1,005	21%	4%	1.52	0.50
Overall									--	--	--	--	67%	67%	1.52	0.50

13.16 Metallurgical Conclusions

The following are concluded from the historical and recent metallurgical testwork:

- Historical metallurgical tests are sufficient to establish oxide material gold, silver and copper recovery ranges for a direct cyanide heap leach processing operation;
- Additional metallurgical tests are needed to establish grades and recoveries for sulphide material with cleaner concentrate produced for sale and cyanide leaching of flotation tails;
- There is a fairly wide range of recoveries for the oxides, transition, and sulphide materials within the same processing method, possibly due to free gold, the “nugget” effect;
- The heap leach resource recovery for oxide material for gold, silver and copper recoveries are estimated to be 78.3%, 45% and 54.0%, respectively. These values were used for heap leach recovery in the cash flow;
- Heap leach cyanide consumption was based on the low grade, HPGR column leach results, the field cyanide consumption was assumed to be 1.0 kg/t;
- Compacted permeability tests showed cement consumptions varying between 2 and 12 kg/t and averaged 6 kg/t. This value was chosen for the cash flow;
- Historical column leach tests indicated 23 to 36% copper dissolution with oxide material size P₈₀ 6.3 mm with conventionally crushed material. Direct cyanide bottle roll leach tests on oxide materials sized P₈₀ 5.2 mm to 6.7 mm and crushed by high-pressure grinding roll (HPGR) indicated copper dissolution range from 33% to 62%;
- Recent direct cyanide bottle roll leach tests on oxide and sulfide composites ground to 0.075 mm resulted in oxide gold recoveries ranging from 92% to 97%, oxide copper recoveries ranging from 20% to 79% and sulfide gold and copper recoveries of 89% and 11%, respectively;
- The mill resource recoveries for oxide material for gold, silver and copper are estimated to be 95.2%, 83% and 74%, respectively; these values were used for oxide mill recoveries in the cash flow;
- The resource sulphide material weighted gold recovery from copper flotation and from rougher flotation tails cyanide leaching was assumed to be 94.5%. The resource sulphide resource material weighted silver recovery from flotation and from cyanide soluble silver precipitation was assumed to be 50%. The resource sulphide material weighted copper recovery from flotation and from cyanide soluble copper precipitation was assumed to be 79.9%. These values were used for sulphide mill recovery in the cash flow;
- KCA recently completed flotation tests with cyanidation of flotation tails that indicate copper recoveries of 63% to 74% to the cleaner concentrate and 67% to 77% recovery

when the rougher tails are leached. Second cleaner concentrate grades ranged from 14.6% to 27.6% Cu; and

- Metallurgical tests have not been completed to establish penalty elements in the flotation or SART concentrates. Arsenic distribution in oxide and sulphide feed materials to copper concentrates should be determined. In KCA (2021 to present) testwork, the oxide material arsenic concentration ranges from 4 ppm to 34 ppm, and the sulphide material arsenic concentration ranges from 4 ppm to 5 ppm. Mercury is assayed at grades between 2 and 13 ppm in Table 13-22. It is assumed dissolved mercury will report to the sulphide SART concentrate.

14.0 MINERAL RESOURCE ESTIMATES

14.1 Introduction

The Mineral Resource Estimate presented herein is reported in accordance with the Canadian Securities Administrators' National Instrument 43-101 and is consistent with generally accepted CIM "Estimation of Mineral Resource and Mineral Reserves Best Practices" guidelines (2019). Mineral Resources are not Mineral Reserves and do not have demonstrated economic viability. There is no guarantee that all or any part of the Mineral Resource will be converted into a Mineral Reserve. Confidence in the estimate of Inferred Mineral Resources is insufficient to allow the meaningful application of technical and economic parameters or to enable an evaluation of economic viability worthy of public disclosure. Mineral Resources may be affected by further infill and exploration drilling that may result in increases or decreases in subsequent Mineral Resource Estimates.

All Mineral Resource estimation work reported herein was carried out or supervised directly by Eugene Puritch, P.Eng., FEC, CET, an independent Qualified Person in terms of NI 43-101. The effective date of this Mineral Resource Estimate is April 29, 2024. A draft copy of this Technical Report has been reviewed by P2 Gold for factual errors.

Mineral Resource modeling and estimation was carried out using GEOVIA GEMS™, Leapfrog™ and Snowden Supervisor™ software. Pit optimisation was carried out using NPV Scheduler™.

14.2 Data Supplied

Drilling and sampling data were supplied by P2 Gold in digital format. The database as implemented by the Author contains 547 drill hole records, consisting of 397 "historical" drill holes, 87 drill holes completed by Newcrest as part of a well-documented exploration program at Gabbs, ten RC drill holes completed by St. Vincent Minerals, and four diamond drillholes and 49 reverse circulation drillholes completed by P2 Gold (Figure 14-1).

The supplied database contains collar, survey, assay, lithology and bulk density tables (Table 14-1). The Property coordinate reference system is NAD27 UTM Zone 11N (EPSG 26711). Plan views of the drill hole projections at surface by deposit are shown in Appendix A.

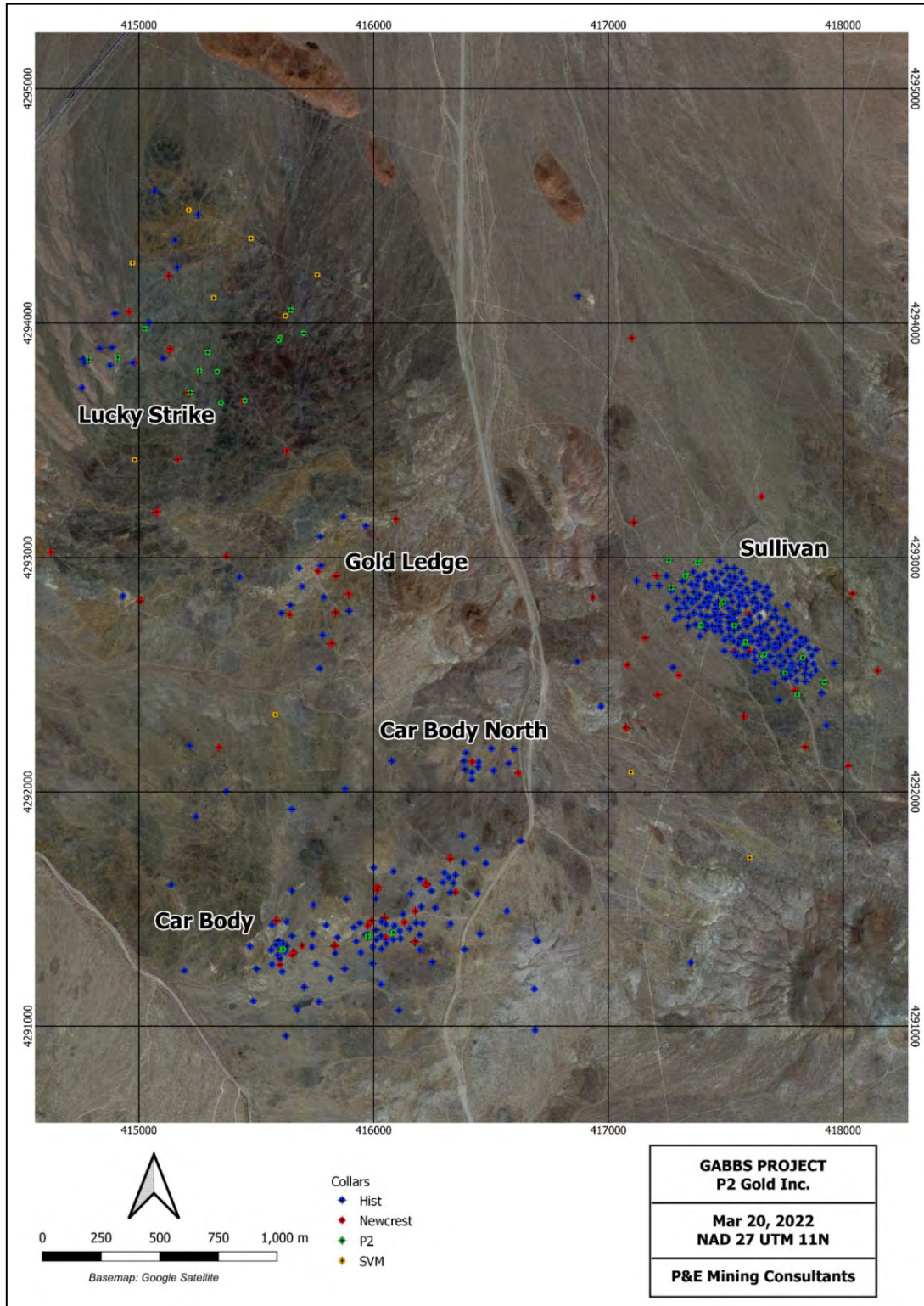

Figure 14-1 Collar Locations

Table 14-1
Database Summary

Drill Hole Type	Record Count	Total Metres
Historical	397	37,219.8
Newcrest DDH	26	10,246.9
Newcrest RC	61	14,517.9
St. Vincent Minerals RC	10	2,400.3
P2 Gold DDH	4	579.7
P2 Gold RC	49	8,115.3
Total	547	73,079.9

Note: DDH = diamond drill hole, RC = reverse circulation.

14.3 Database Validation

The drill hole database was reviewed with P2 Gold staff. The Author reviewed original drill hole logs, assay results and internal reports against the compiled database. Multiple drill hole collars were also located in the field. For the historical Amoco series of drill holes the original geological logs were not located; however, assay results and maps showing drill hole collar locations were available. The general tenor of mineralization for these drill holes was compared to later stage drilling results and found to be comparable.

Industry standard validation checks were completed on the supplied databases. The Author typically validates a Mineral Resource database by checking for inconsistencies in naming conventions or analytical units, duplicate entries, interval, length or distance values less than or equal to zero, blank or zero-value assay results, out-of-sequence intervals, intervals or distances greater than the reported drill hole length, inappropriate drill hole collar locations, and missing interval and coordinate fields. No significant validation errors were noted.

As a further check on the supplied drill hole database, the Author recompiled Newcrest, St Vincent Minerals and P2 Gold assay data from the original assay certificates. The Author is of the opinion that the data is suitable for Mineral Resource estimation.

14.4 Economic Assumptions

As part of the update of the Gabbs Mineral Resource Estimate, the Author reviewed the economic assumptions used previously. The Updated Mineral Resource Estimate incorporates the following economic assumptions:

- Au Price: US\$1,838 per ounce.
- Cu Price: US\$3.96 per pound.
- Leach Processing Cost: US\$11.40 per tonne.

- Sulphide Processing Cost: US\$19.60 per tonne.
- G&A Cost: US\$1.00 per tonne.
- Leach Oxide Au Recovery: 78.3%.
- Leach Oxide Cu Recovery: 48.0%.
- Sulphide Au Recovery: 95.2%
- Sulphide Cu Recovery: 78.0%
- Leach Cut-off: 0.27 g/t AuEq.
- Sulphide Cut-off: 0.36 g/t AuEq.
- Mining Cost: US\$1.60 per tonne.
- Pit Slopes: 50 degrees.

Gold equivalent (“AuEq”) grades have been calculated for oxide and sulphide material using the following formulas:

Oxide: $\text{AuEq (g/t)} = \text{Au (g/t)} + \text{Cu (\%)} \times 1.092$

Sulphide: $\text{AuEq (g/t)} = \text{Au (g/t)} + \text{Cu (\%)} \times 1.338$

Silver was also modelled, however, does not contribute to the gold equivalent calculation.

14.5 Domain Modeling

A topographic surface across the Property was generated from USGS 10 metre contour data incorporating surveyed drill hole collars.

Five distinct deposits have been identified at Gabbs; namely the Sullivan, Car Body, Car Body North, Gold Ledge and Lucky Strike (Figure 14-2). A mineralization domain was modelled for each individual deposit, based on reasonably continuous drill hole assay grades greater than 0.20 AuEq g/t. Where necessary to maintain zonal continuity, lower grade intervals were also included. Three-dimensional domain wireframes linking drill hole intervals were subsequently constructed using the Leapfrog™ Radial Basis Function, with hanging wall and footwall surfaces snapped directly to the selected drill hole intercepts. The resulting domains were used for block coding, statistical analysis, compositing limits and grade estimation. The final 3-D domains are shown in Appendix B.

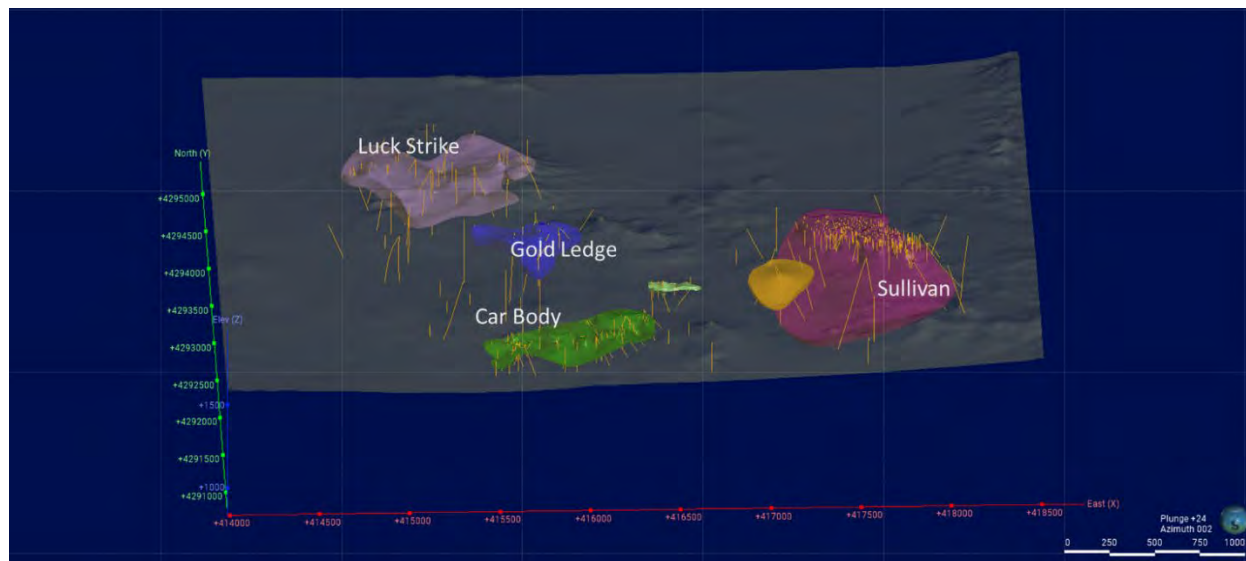

Figure 14-2 Modelled Deposits

Using the available lithological and mineralogical data, three oxidation zones were modelled across the Property (Figure 14-3):

- Zone 10: very low S and intermediate As values. Stratigraphically highest.
- Zone 15: low As and intermediate S value. Stratigraphically lowest.
- Zone 20: high As and S values.

Zone 10 is interpreted as an oxide zone, while Zone 20 and Zone 15 are classified as sulphide zones (Table 14-2).

Table 14-2
Redox Summary Statistics

Variable	Zone	Count	Mean	StDev	Minimum	Median	Maximum
As ppm	10	6,595	22.84	46.11	1.8	13	1,000
	20	2,591	26.47	44.64	2.0	13.8	693.0
	15	1,912	18.94	20.68	2.0	14.0	317.0
Fe %	10	6,595	5.02	2.30	0.31	4.58	18.80
	20	2,591	5.38	2.52	0.68	4.82	14.45
	15	1,912	5.49	2.65	0.48	5.975	16.30
S %	10	6,595	0.08	0.20	0.001	0.02	3.41
	20	2,591	0.96	0.96	0.010	0.62	6.30
	15	1,912	0.23	0.41	0.001	0.12	5.84

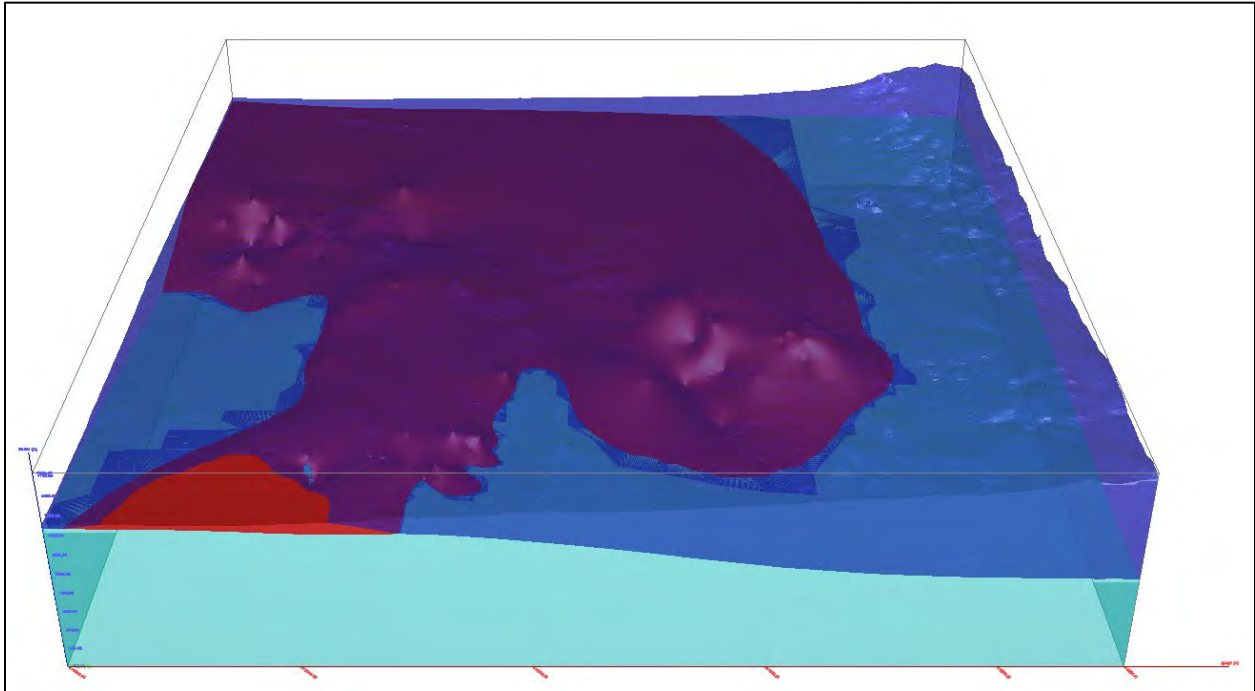

Note: Blue = oxide. Red = sulphide. Cyan = lower sulphide. View looking north. Field of view 4,500m.

Figure 14-3 Isometric Plot of Redox Zones – View Looking North

14.6 Exploratory Data Analysis

The overall mean nearest neighbour collar distance for the Gabbs Property is 55.6m. For the Sullivan Deposit the mean nearest neighbour collar distance is 20.2m; for the Car Body Deposit the mean nearest neighbour collar distance is 27.3m; for the Gold Ledge Deposit the mean nearest neighbour collar distance is 55.6m; and for the Lucky Strike Deposit the mean nearest neighbour collar distance is 71.5m. Silver assays are only available for the Sullivan, Car Body and Lucky Strike Deposits.

The average length of all diamond drill holes is 360.9m, and the average length of all reverse circulation drill holes is 208.6m. The average length of all historical drill holes is 97.8m. Summary statistics for the constrained assay data are listed in Table 14-3.

Table 14-3
Summary Statistics for Constrained Assays

Au Assays	Sullivan	Car Body	Car Body North	Gold Ledge	Lucky Strike	Total
Count	11,001	1,395	47	716	1,248	14,407
Minimum (g/t)	0.0001	0.0010	0.0010	0.0010	0.0010	0.0001
Maximum (g/t)	46.90	30.10	2.71	4.18	26.40	46.90
Average (g/t)	0.50	0.45	0.50	0.16	0.34	0.47
Standard Deviation	0.78	1.54	0.52	0.24	1.09	0.86
CoV	1.56	3.42	1.04	1.47	3.17	1.87
Cu Assays	Sullivan	Car Body	Car Body North	Gold Ledge	Lucky Strike	Total
Count	11,001	1,395	NA	716	1,248	14,360
Minimum (ppm)	1	1	NA	2	5	1
Maximum (ppm)	23,100	312	NA	14,300	9,000	23,100
Average (ppm)	2,481	28	NA	1,262	2,009	2,141
Standard Deviation	1,868	37	NA	1,039	1,484	1,616
CoV	0.75	1.34	NA	0.82	0.74	0.81
Ag Assays	Sullivan	Car Body	Car Body North	Gold Ledge	Lucky Strike	Total
Count	2,038	322	NA	NA	458	2,818
Minimum (g/t)	0.005	0.07	NA	NA	0.02	0.005
Maximum (g/t)	19.1	13.1	NA	NA	23.0	23.0
Average (g/t)	1.83	0.81	NA	NA	1.79	1.70
Standard Deviation	2.92	1.79	NA	NA	3.28	2.90
CoV	0.16	2.21	NA	NA	1.84	1.70

14.7 Bulk Density

P2 Gold collected a total of 253 bulk density measurements from drill core and RC chip samples by laboratory pycnometry, ranging from 2.32 t/m³ to 3.16 t/m³, with an average value of 2.78 t/m³.

No bulk density measurements were taken for the Gold Ledge domain, and a value of 2.70 t/m³ was subsequently used, which corresponds to the monzonite bulk density previously used by Newcrest. A bulk density value of 2.82 t/m³ was used for the Sullivan domain, 2.75 t/m³ for the Car Body domain, 2.89 t/m³ for the Lucky Strike domain, and 2.70 t/m³ for Gold Ledge.

14.8 Compositing

Constrained assay sample lengths for the Gabbs drill holes range from 0.15 to 15.24m, with an average sample length of 1.76m and a median sample length of 1.52m. A total of 48% of the samples have a length of 1.52m, and an additional 32% have a length of 1.53m. In order to ensure equal sample support a compositing length of 1.52m was therefore selected for use for Mineral Resource estimation.

Length-weighted composites were calculated within the defined domains for Au and Cu. The compositing process started at the first point of intersection between the drill hole and the domain intersected, and halted upon exit from the domain wireframe. The wireframes that represented the interpreted domains were also used to back-tag a rock code field into the drill hole workspace. Assays and composites were assigned a domain rock code value based on the domain wireframe that the interval midpoint fell within. A nominal grade of 0.001 was used to populate a small number of un-sampled intervals for Au. Due to the irregularity of the Cu sampling, unsampled Cu intervals were treated as nulls. Residual composites that were less than half of the compositing length were discarded so as to not introduce a short sample bias into the grade estimation process. The composite data were then exported to extraction files for analysis and grade estimation.

14.9 Composite Summary Statistics

The Author generated summary statistics for the composited samples within the defined mineralization domains (Table 14-4). There are no significant Cu assays or Cu composites from the Car Body North Deposit.

Table 14-4
Domain Composite Summary Statistics

Au Composites	Sullivan	Car Body	Car Body North	Gold Ledge	Lucky Strike	Total
Count	12,954	2,165	110	842	1,270	17,435
Minimum (g/t)	0.001	0.001	0.001	0.001	0.001	0.001
Maximum (g/t)	44.46	25.00	2.71	4.13	26.05	44.46
Average (g/t)	0.46	0.35	0.24	0.16	0.35	0.42
Standard Deviation	0.73	1.28	0.44	0.23	1.07	0.83
CoV	1.59	3.63	1.82	1.44	3.10	1.98
Cu Composites	Sullivan	Car Body	Car Body North	Gold Ledge	Lucky Strike	Total
Count	12,040	309	NA	736	1,141	14,320
Minimum (ppm)	1	1.5	NA	2.6	10	1
Maximum (ppm)	21,823	291	NA	14,300	8,766	21,823
Average (ppm)	2,492	28	NA	1,289	2,034	2,334
Standard Deviation	1,751	36	NA	1,037	1,432	1,733
CoV	0.70	1.29	NA	0.80	0.70	0.74
Ag Composites	Sullivan	Car Body	Car Body North	Gold Ledge	Lucky Strike	Total
Count	2,039	320	NA	NA	459	2,818
Minimum (g/t)	0.001	0.003	NA	NA	0.001	0.001
Maximum (g/t)	19.1	4.08	NA	NA	21.8	21.8
Average (g/t)	1.22	0.34	NA	NA	0.98	1.08
Standard Deviation	1.51	0.48	NA	NA	2.06	1.57
CoV	1.24	1.40	NA	NA	2.10	1.44

14.10 Treatment of Extreme Values

Capping thresholds were determined by the decomposition of individual composite log-probability distributions (Figure 14-4, Figure 14-5 and Figure 14-6). Composites were capped to the defined threshold prior to grade estimation (as shown in Table 14-5).

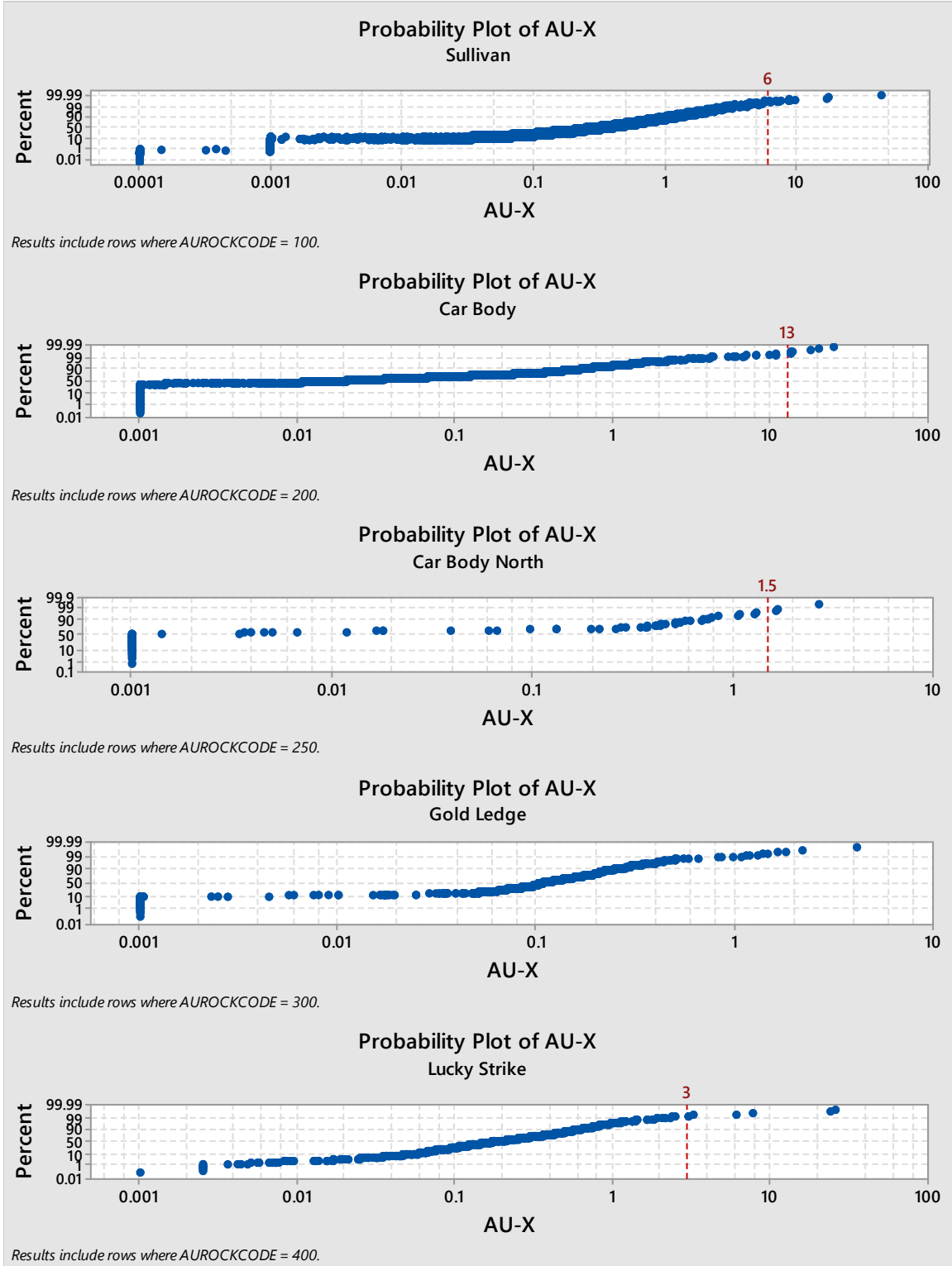

Figure 14-4 Au Log-Probability Plots

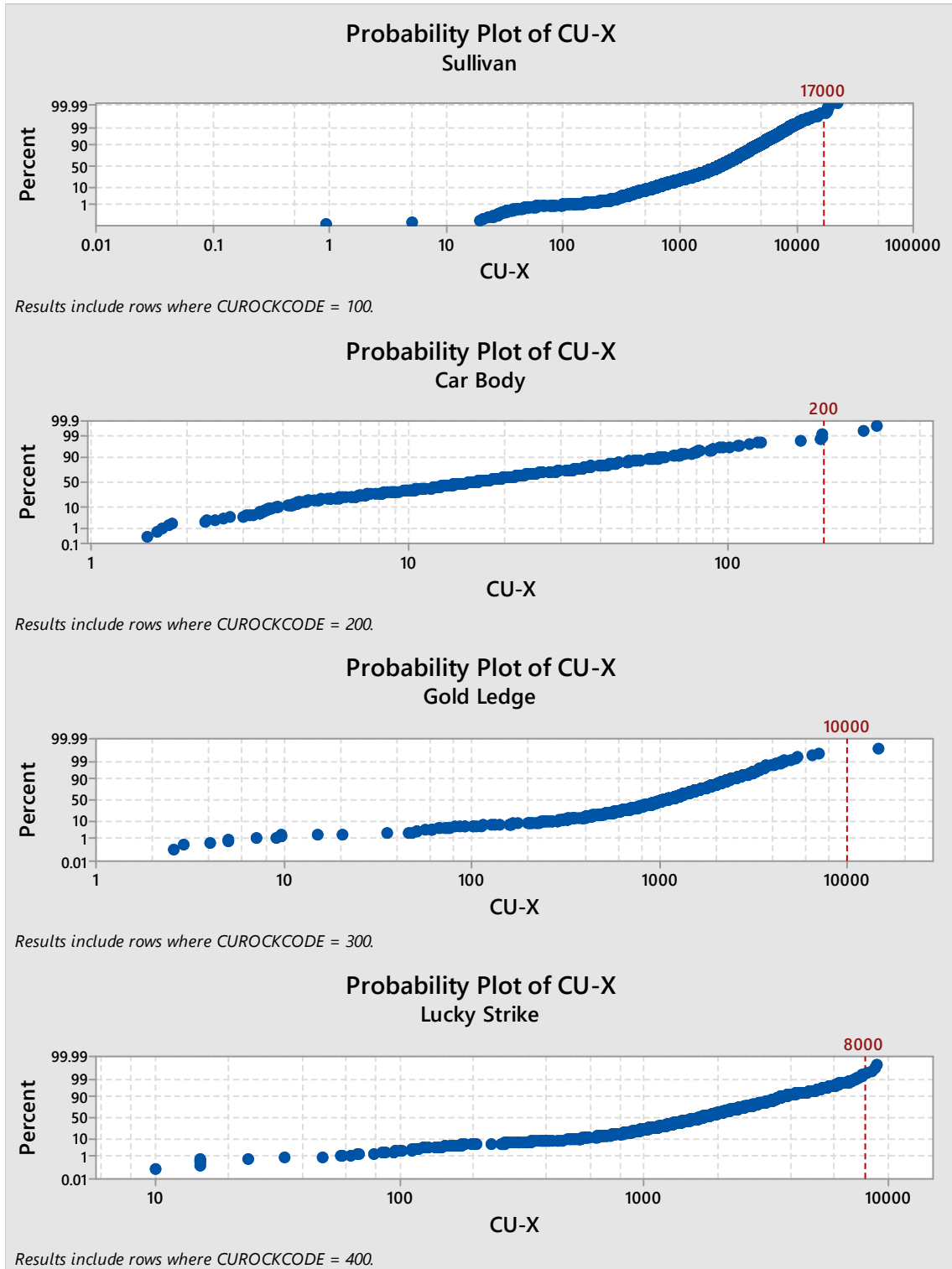

Figure 14-5 Cu Log-Probability Plots

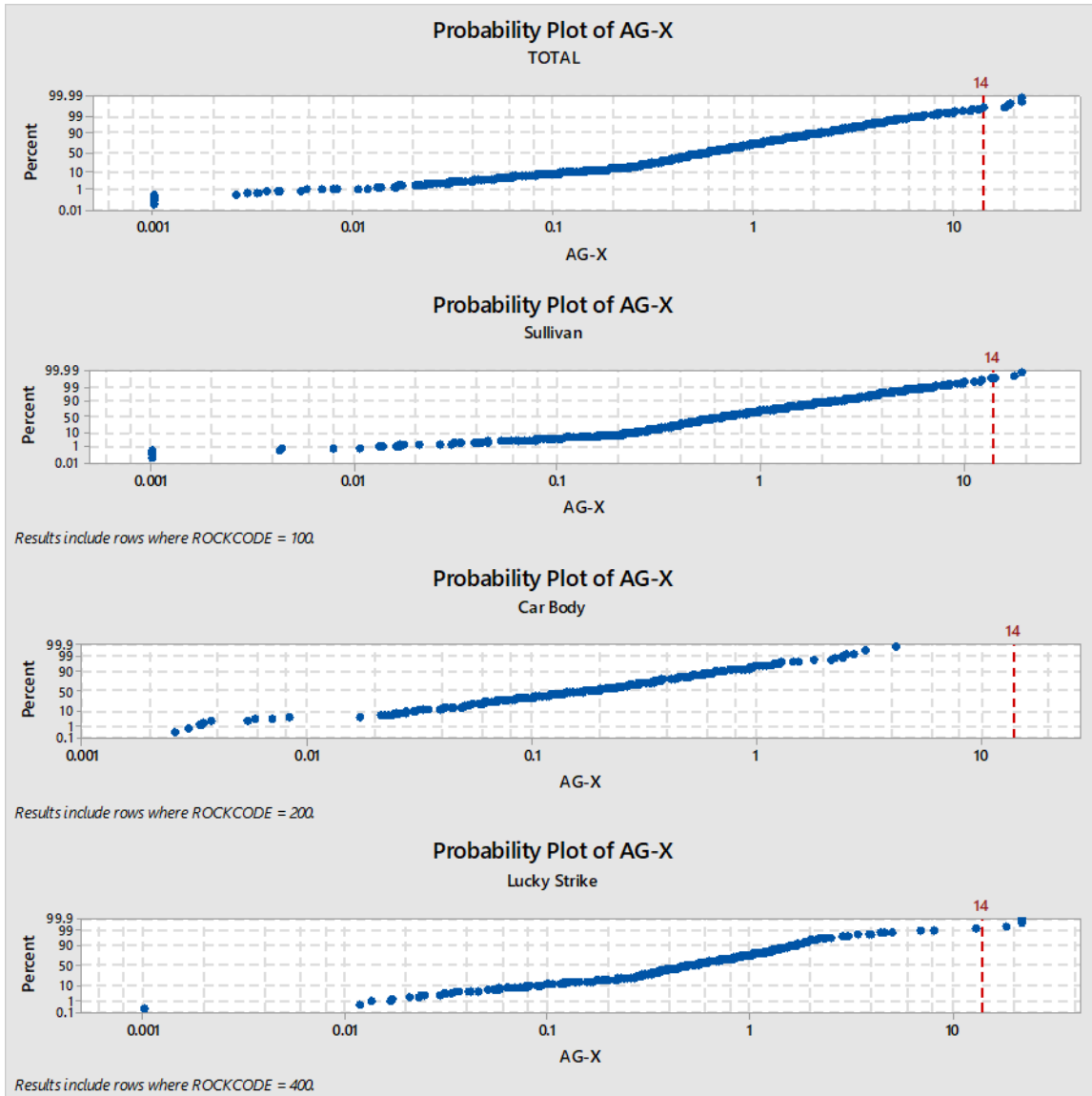

Figure 14-6 Ag Log-Probability Plots

**Table 14-5
Capping Thresholds**

Element	Sullivan	Car Body	Car Body North	Gold Ledge	Lucky Strike
Au Threshold (g/t)	6.00	13.00	1.50	NA	3.00
Au Mean (g/t)	0.46	0.35	0.24	0.16	0.35
Number Capped	16	8	3	0	7
Au Capped Mean (g/t)	0.45	0.34	0.23	0.16	0.30
Cu Threshold (ppm)	17,000	200	NA	10,000	8,000
Cu Mean (ppm)	2,492	28	NA	1,289	2,034
Number Capped	5	2	NA	1	4
Cu Capped Mean (ppm)	2,491	28	NA	1,283	2,032
Ag Threshold (g/t)	14	14	NA	NA	14
Ag Mean (g/t)	1.22	0.34	NA	NA	0.98
Number Capped	2	0	NA	NA	4
Ag Capped Mean (g/t)	1.22	0.34	NA	NA	0.93

14.11 Variography

Three-dimensional continuity analysis (variography) was conducted on the domain-coded uncapped composite data using a normal-scores transformation. In general, an acceptable semi-variogram could only be developed for the Sullivan Domain, primarily due to the small number of data points available for the other domains. A down-hole variogram was viewed at a 1.52m lag spacing (equivalent to the composite length) to assess the nugget variance contribution. Standardized spherical models were used to model the experimental semi-variograms in normal-score transformed space (Figure 14-7 and Figure 14-8).

Semi-variogram model ranges were checked and iteratively refined for each model relative to the overall nugget variance, and the back-transformed variance contributions were then calculated (Table 14-6). Both Au and Cu semi-variograms display reasonable continuity within the plane of the deposit.

**Table 14-6
Sullivan Semi-Variograms**

Au Composites	Direction 1	Direction 2	Direction 3
Vector	0 > 135	-25 > 225	-65 > 45
C0	0.07	0.07	0.07
C1	0.72	0.72	0.72
C2	0.21	0.21	0.21
R1	10	40	30
R2	200	200	40
Cu Composites	Direction 1	Direction 2	Direction 3
Vector	0 > 135	-25 > 225	-65 > 45
C0	0.06	0.06	0.06
C1	0.49	0.49	0.49
C2	0.45	0.45	0.45
R1	22	11	11
R2	150	120	35

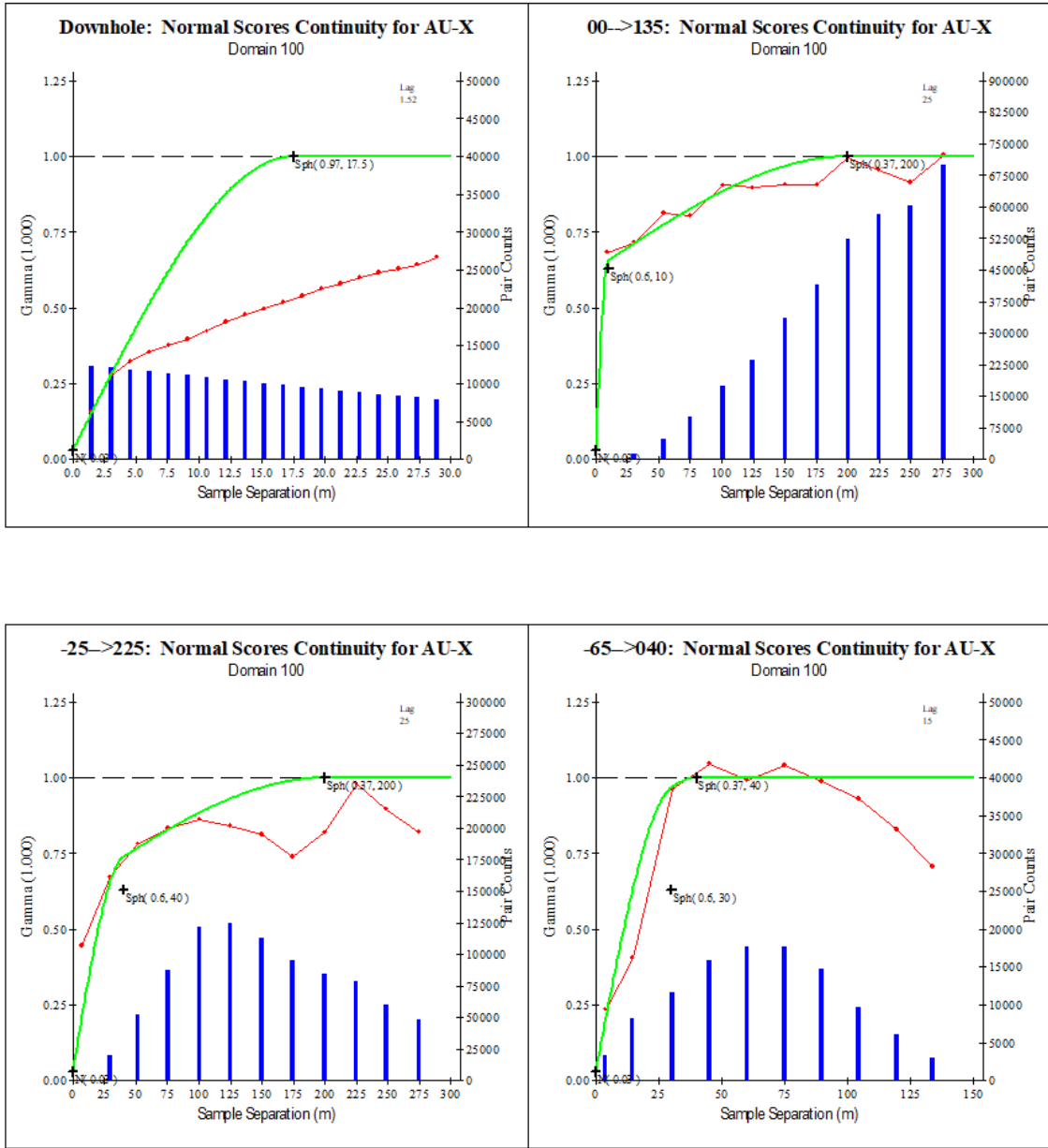

Figure 14-7 Au Semi-variograms for Sullivan

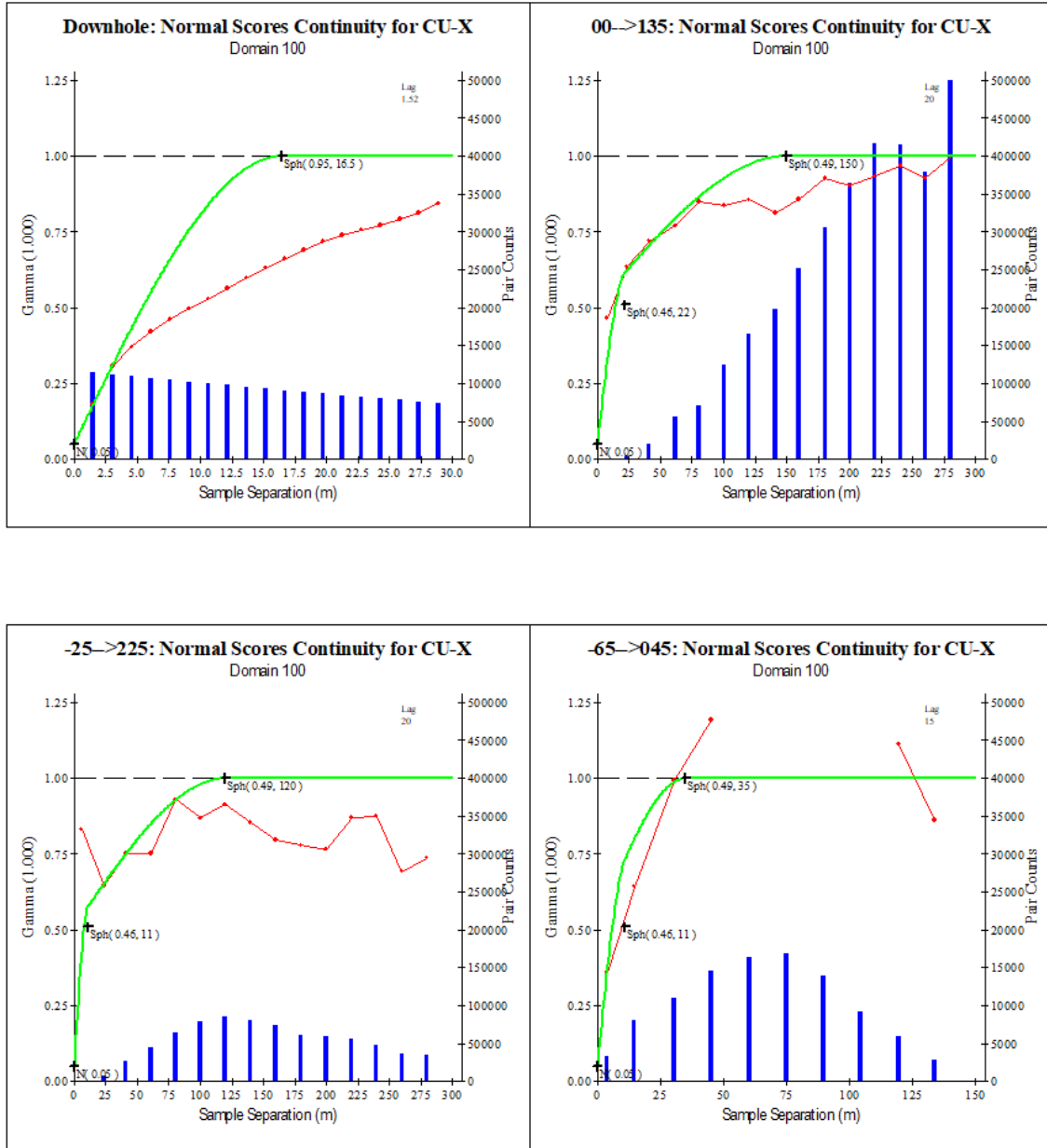

Figure 14-8 Cu Semi-variograms for Sullivan

14.12 Block Model

An orthogonal block model was established across the Property with the block model limits selected so as to cover the extent of the mineralized domains, and the block size reflecting the scattered and irregular drill hole spacing (Table 14-7). The block model consists of separate attributes for estimated grade, rock code, volume percent, bulk density and classification attributes. The volume percent block model was used to accurately represent the volume and tonnage that was contained within the constraining grade domains. As a result, the Mineral Resource boundaries were properly represented by the volume percent model's capacity to

measure infinitely variable inclusion percentages. Plan views of the block model are shown in Appendix C.

Table 14-7
Block Model Setup

Dimension	Minimum	Maximum	Number	Size (m)
X	414,000	418,500	900	5
Y	4,290,700	4,295,200	900	5
Z	700	1,900	240	5
Rotation	0°			

14.13 Grade Estimation and Classification

Block grades for Au and Ag were estimated using inverse distance cubed (ID³) linear weighting of capped composites, and block grades for Cu were estimated using inverse distance squared (ID²) linear weighting of capped composites. Between four and twelve composites from two or more drill holes were required for block grade estimation. Candidate composite samples were selected from within a search ellipse extended to cover the modelled domain and rotated parallel to the modelled domain. Subsequent to grade estimation, AuEq block grades were calculated from the estimated Au and Cu block grades.

Blocks within 50m of three or more drill holes at Sullivan were classified as Indicated, corresponding to 25% of the modelled range for Au and 33% for Cu. All other estimated blocks were classified as Inferred.

The Author is of the opinion that the current level of information available is sufficient to classify the Mineral Resource as Indicated and Inferred Mineral Resources. Mineral Resources were classified in accordance with definitions established by the Canadian Institute of Mining, Metallurgy and Petroleum (2014):

An Indicated Mineral Resource is that part of a Mineral Resource for which quantity, grade or quality, densities, shape and physical characteristics are estimated with sufficient confidence to allow the application of Modifying Factors in sufficient detail to support mine planning and evaluation of the economic viability of the deposit. Geological evidence is derived from adequately detailed and reliable exploration, sampling and testing and is sufficient to assume geological and grade or quality continuity between points of observation. An Indicated Mineral Resource has a lower level of confidence than that applying to a Measured Mineral Resource and may only be converted to a Probable Mineral Reserve.

An Inferred Mineral Resource is that part of a Mineral Resource for which quantity and grade or quality are estimated on the basis of limited geological evidence and sampling. Geological evidence is sufficient to imply but not verify geological and grade or quality continuity. An Inferred Mineral Resource has a lower level of confidence than that applying to an Indicated Mineral Resource and must not be converted to a Mineral Reserve. It is reasonably expected that the majority of Inferred Mineral Resources could be upgraded to Indicated Mineral Resources with continued exploration.

14.14 Mineral Resource Estimate

National Instrument 43-101 incorporates by reference the definition of, among other terms, Mineral Resource from the Canadian Institute of Mining, Metallurgy and Petroleum Definition Standards for Mineral Resources & Mineral Reserves (the “CIM Definition Standards (2014)”) and Best Practices Guidelines (2019). Under the CIM Definition Standards, a Mineral Resource must have “reasonable prospects for eventual economic extraction”. In order to meet this criterion, the Author generated constraining conceptual pit shells and calculated separate cut-offs for the oxide and sulphide zones, based on the economic parameters listed in Section 14.4 and shown in Appendix D. The results from the constraining pit shell are used solely for the purpose of reporting Mineral Resources and include Inferred Mineral Resources. Little information is available on historical mining at Gabbs, and therefore historical mining has not been depleted from the modelled domains and is considered to be minimal. Pit-constrained Mineral Resources are reported using a cut-off of 0.27 g/t AuEq for oxide material, and 0.36 g/t AuEq for sulphide material (Table 14-8).

Table 14-8
Summary of Mineral Resources ⁽¹⁻⁹⁾

DOMAIN	GROUP	Cut-off	Tonnes	Au	Cu	Au	Cu	AuEq	AuEq	Ag	Ag
		AuEq g/t	M	g/t	%	M ozs	M lbs	g/t	M ozs	g/t	M ozs
TOTAL	Indicated Oxide	0.27	33.7	0.46	0.26	0.502	196.6	0.70	0.763	1.43	1.6
	Inferred Oxide	0.27	52.0	0.39	0.21	0.656	243.8	0.62	1.037	0.81	1.4
	Indicated Sulphide	0.36	16.1	0.43	0.28	0.220	100.4	0.77	0.397	1.21	0.6
	Inferred Sulphide	0.36	60.2	0.32	0.24	0.622	323.3	0.65	1.249	0.87	1.7
	Total Indicated	0.27 & 0.36	49.8	0.45	0.27	0.721	297.0	0.72	1.160	1.36	2.2
	Total Inferred	0.27 & 0.36	112.2	0.35	0.23	1.278	567.1	0.63	2.285	0.84	3.0
SULLIVAN	Indicated Oxide	0.27	33.7	0.46	0.26	0.502	196.6	0.70	0.763	1.43	1.6
	Inferred Oxide	0.27	6.2	0.37	0.23	0.073	31.3	0.58	0.114	0.88	0.2
	Indicated Sulphide	0.36	16.1	0.43	0.28	0.220	100.4	0.77	0.397	1.21	0.6
	Inferred Sulphide	0.36	19.9	0.38	0.28	0.242	122.9	0.72	0.459	1.19	0.8
CAR BODY	Indicated Oxide	0.27	0.0	0.00	0.00	0.000	0.0	0.00	0.000	0.00	0.0
	Inferred Oxide	0.27	3.2	0.93	0.00	0.096	0.2	0.94	0.096	0.35	0.0
	Indicated Sulphide	0.36	0.0	0.00	0.00	0.000	0.0	0.00	0.000	0.00	0.0
	Inferred Sulphide	0.36	1.1	0.75	0.00	0.027	0.0	0.75	0.027	0.37	0.0
CAR BODY NORTH	Indicated Oxide	0.27	0.0	0.00	0.00	0.000	0.0	0.00	0.000	N/A	N/A
	Inferred Oxide	0.27	0.8	0.00	0.00	0.000	0.0	0.50	0.013	N/A	N/A
	Indicated Sulphide	0.36	0.0	0.00	0.00	0.000	0.0	0.00	0.000	N/A	N/A
	Inferred Sulphide	0.36	0.0	0.00	0.00	0.000	0.0	0.98	0.001	N/A	N/A
GOLD LEDGE	Indicated Oxide	0.27	0.0	0.00	0.00	0.000	0.0	0.00	0.000	N/A	N/A
	Inferred Oxide	0.27	2.7	0.00	0.23	0.000	13.8	0.41	0.036	N/A	N/A
	Indicated Sulphide	0.36	0.0	0.00	0.00	0.000	0.0	0.00	0.000	N/A	N/A

DOMAIN	GROUP	Cut-off	Tonnes	Au	Cu	Au	Cu	AuEq	AuEq	Ag	Ag
		AuEq g/t	M	g/t	%	M ozs	M lbs	g/t	M ozs	g/t	M ozs
	Inferred Sulphide	0.36	4.3	0.00	0.17	0.000	16.3	0.50	0.068	N/A	N/A
LUCKY STRIKE	Indicated Oxide	0.27	0.0	0.00	0.00	0.000	0.0	0.00	0.000	0.00	0.0
	Inferred Oxide	0.27	35.9	0.42	0.24	0.488	187.1	0.64	0.736	0.99	1.1
	Indicated Sulphide	0.36	0.0	0.00	0.00	0.000	0.0	0.00	0.000	0.00	0.0
	Inferred Sulphide	0.36	33.3	0.33	0.24	0.352	177.5	0.63	0.670	0.85	0.9

Notes:

- 1) Mineral Resources were estimated using the Canadian Institute of Mining, Metallurgy and Petroleum (CIM), CIM Standards on Mineral Resources and Reserves, Definitions (2014) and Best Practices (2019) prepared by the CIM Standing Committee on Reserve Definitions and adopted by CIM Council.
- 2) The Inferred Mineral Resource in this estimate has a lower level of confidence that that applied to an Indicated Mineral Resource and must not be converted to a Mineral Reserve. It is reasonably expected that the majority of the Inferred Mineral Resource could be upgraded to an Indicated Mineral Resource with continued exploration.
- 3) Mineral Resources are reported within a constraining conceptual pit shell.
- 4) Inverse distance weighting of capped composite grades within grade envelopes was used for grade estimation.
- 5) Composite grade capping was implemented prior to grade estimation.
- 6) Bulk density was assigned by domain.
- 7) A copper price of US\$3.96/lb and a gold price of US\$1,838/oz were used. Silver was not used for calculating revenue and is reported for future consideration.
- 8) A cut-off grade of 0.27 g/t AuEq for oxide material, and 0.36 g/t AuEq for sulphide material was used.
- 9) Tables may not sum due to rounding.

14.15 Validation

The block model was validated visually by the inspection of successive cross-sections in order to confirm that the model correctly reflects the distribution of high-grade and low-grade samples. Contained volumes and calculated tonnage for each domain wireframe were also compared to estimated tonnage per domain at a 0.001 g/t AuEq cut-off (Table 14-9). No discrepancies were noted.

Table 14-9
Volume Reconciliation

Domain	Volume (k m³)	Model Estimate (k m³)
Sullivan	56,294	56,294
Car Body	6,399	6,799
Car Body North	616	616
Gold Ledge	9,802	9,802
Lucky Strike	34,339	34,338
Total	107,450	107,849

As a further check on the model the average model block grade was compared to the Nearest Neighbour block average as well as to the average of the uncapped composite data. No significant bias between the block model and the input data was noted (Table 14-10).

Table 14-10
Domain Validation Statistics

Domain	Model Average Au (g/t)	NN Average Au (g/t)	Composite Average Au (g/t)
Sullivan	0.25	0.24	0.46
Car Body	0.30	0.30	0.35
Car Body North	0.33	0.66	0.24
Gold Ledge	0.17	0.16	0.16
Lucky Strike	0.30	0.29	0.35
Total	0.26	0.25	0.42
Domain	Model Average Cu (ppm)	NN Average Cu (ppm)	Composite Average Cu (ppm)
Sullivan	2,060	2,105	2,492
Car Body	24	25	28
Car Body North	1	1	NA
Gold Ledge	1,268	1,225	1,289
Lucky Strike	1,999	1,954	2,034
Total	1,823	1,825	2,334

Note: NN = Nearest Neighbour

15.0 MINERAL RESERVE ESTIMATE

There is no Mineral Reserve Estimate stated for the Gabbs Project. This section is not applicable to this Technical Report.

16.0 MINING METHODS

The Gabbs Project consists of several relatively shallow gold-copper deposits that lend themselves to conventional open pit mining methods. Accordingly, this Preliminary Economic Assessment (PEA) mine plan entails developing several open pits across the Property to support a combined heap leach and mill (flotation) operation. No underground mining is considered in the PEA mining plan.

The PEA mine production plan utilizes Inferred Mineral Resources that are considered too speculative geologically to have the economic considerations applied to them to be categorized as Mineral Reserves. There is no certainty that the Inferred Mineral Resources will be upgraded to a higher Mineral Resource category in the future.

The gold deposits being mined are designated as:

- Car Body;
- Gold Ledge;
- Lucky Strike; and
- Sullivan.

Figure 16-1 provides a general overview of the Project site showing the location of the open pits, the primary crushers, and proposed waste rock storage facilities.

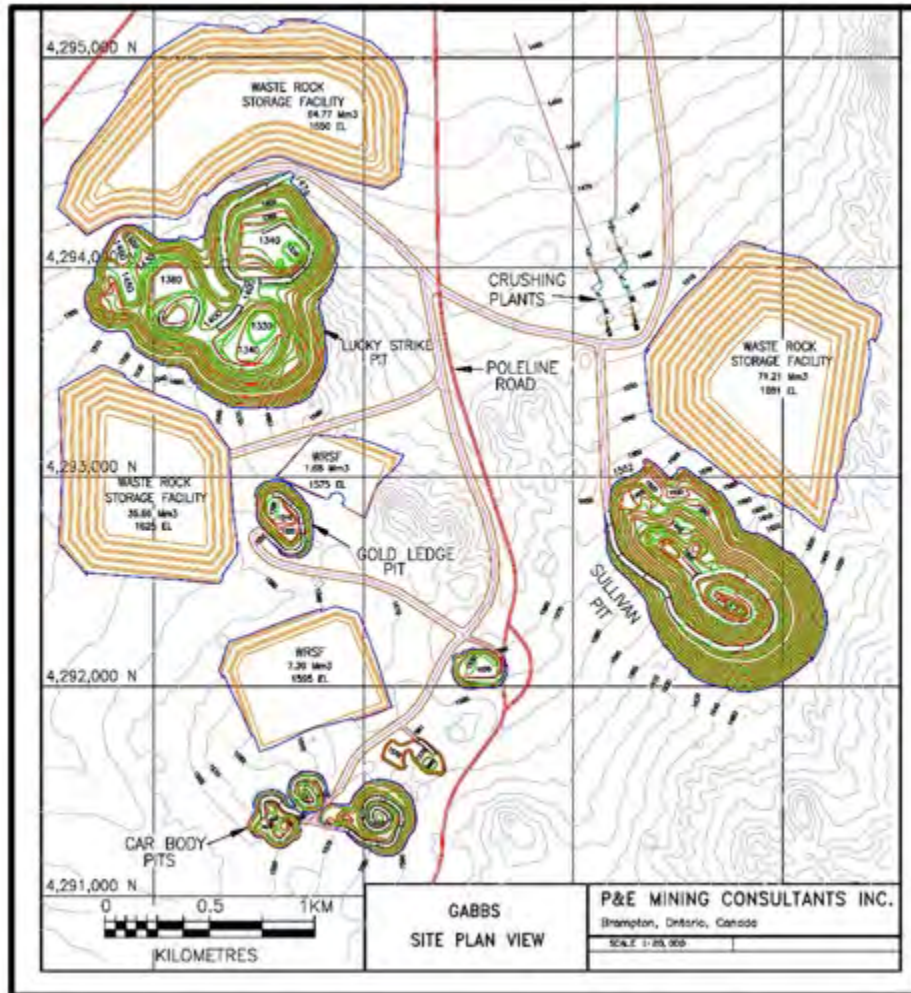

Figure 16-1 General Mine Layout

The engineering design of the open pits and the development of a mine production schedule requires several technical steps. These are:

- Complete individual Lerches-Grossman pit optimizations to select the optimal shells to be used for open pit design.
- Design operational pits (with ramps and catch benches) based on the optimal pit shells.
- Develop a life-of-mine mine production schedule, supplying 6.0 million tonnes per annum (Mtpa) (16,000 tonnes per day) of mineralized feed to the crushing plant.

16.1 PIT OPTIMIZATIONS

A series of Lerches-Grossman pit optimizations were completed separately for each deposit using NPV Scheduler™ software. The pit optimization step produced a series of nested shells each containing mineralized material that is economically mineable according to a given set of

physical and economic parameters. An optimal shell was then selected as the basis for the actual pit design.

The pit optimizations were run using the parameters shown in Table 16-1. For pit optimization, a base case gold price of \$US1,950/oz was used along with an overall open pit slope of 43°. The optimization analysis included Indicated and Inferred Mineral Resources and was based on the gold equivalent (AuEq) parameter. AuEq incorporates Ag and Cu grades in the formula as described in Section 14 of this report.

Each deposit could contain up to three mineralized feed types; an upper oxide zone (Rock Code 10); a transitional zone (Code 15); and an underlying sulphide zone (Code 20). Table 16-1 summarizes the heap leach and milling plant recoveries assumed for each of the three feed types.

The results of optimization are shown graphically in Figure 16-2, Figure 16-3, Figure 16-4 and Figure 16-5, showing the calculated Net Present Value (NPV) versus the Revenue Factor (RF). Note that 100% RF corresponds to US\$1,950/oz. Also highlighted in the graphs are the RFs (shells) that were selected for the open pit designs as related to the shell NPV curve. The 100% RF shell was selected for each deposit.

The shape of the individual NPV curve is dependent on the insitu metal grades and the orientation of the mineralized zones. Hence the NPV curves are unique for each deposit.

For optimization, the transition zone (Code 15) was considered as sulphide feed for the flotation mill facility. This transition feed tonnage is approximately 1% of the total plant feed.

Table 16-1
Pit Optimization Parameters

Rock Codes		Upper Oxide 10	Upper Sulphide Transitional 15	Sulphide 20
Classifications to use		Indicated/Inferred	Indicated/Inferred	Indicated/Inferred
AuEq attribute to use		AUEQ3	AUEQ3	AUEQ3
Process Method		Heap Leach	Flotation	Flotation
Throughput Rate	tpy	8,000,000	6,000,000	6,000,000
Gold Price	US\$/oz	1,950	1,950	1,950
Cu Price	US\$/lb	in AuEq	in AuEq	in AuEq
Operating Costs				
Waste Mining & Haulage	\$/t	2.00	2.00	2.00
Mineralized Mining & Haulage	\$/t	2.20	2.20	2.20
Processing (Heap Leach)	\$/t	11.76	n/a	n/a
Processing (Flotation + Tailings)	\$/t	n/a	23.66	23.66
G&A	\$/t	0.50	0.67	0.67
Total Opex (for cut-off grades)	\$/t	12.26	24.33	24.33
Process Recovery				
Heap Leach Recovery – Au	%	78	n/a	n/a
Heap Leach Recovery – Cu	%	in AuEq	n/a	n/a
Flotation Recovery – Au	%	n/a	94	94
Flotation Recovery – Cu	%	n/a	in AuEq	in AuEq
Cut-off Grades				
Incremental Operating Cost	\$/t	12.26	24.33	24.33
Cut-off Grade (AuEq)	g/t	0.25	0.41	0.41
Open Pit Slopes	0-360°	43 deg	43 deg	43 deg
Overburden	0-360°	33 deg	33 deg	33 deg

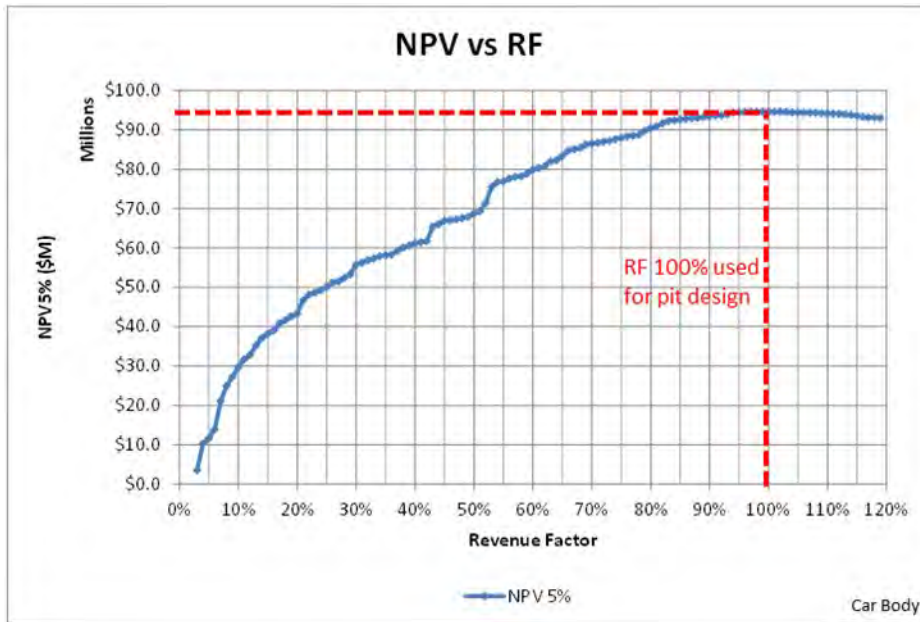

Figure 16-2 Car Body Pit Optimization (NPV vs Revenue Factor)

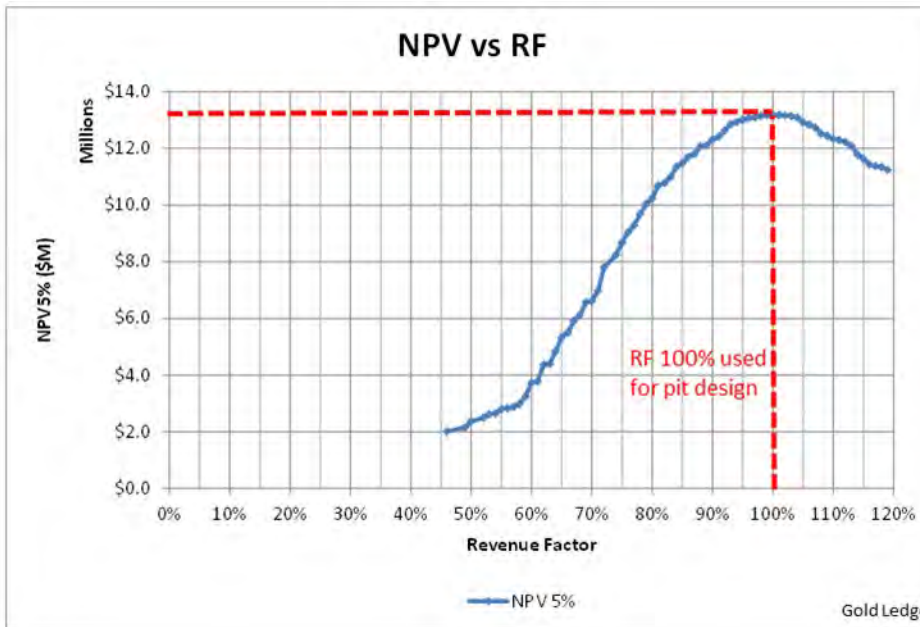

Figure 16-3 Gold Ledge Optimization (NPV vs Revenue Factor)

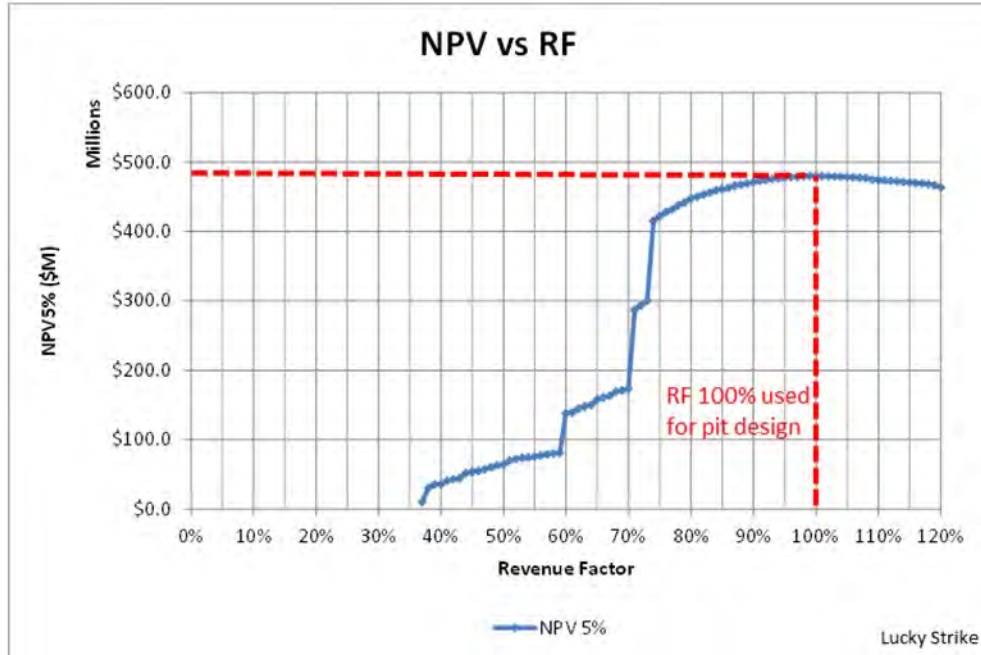

Figure 16-4 Lucky Strike Pit Optimization (NPV vs Revenue Factor)

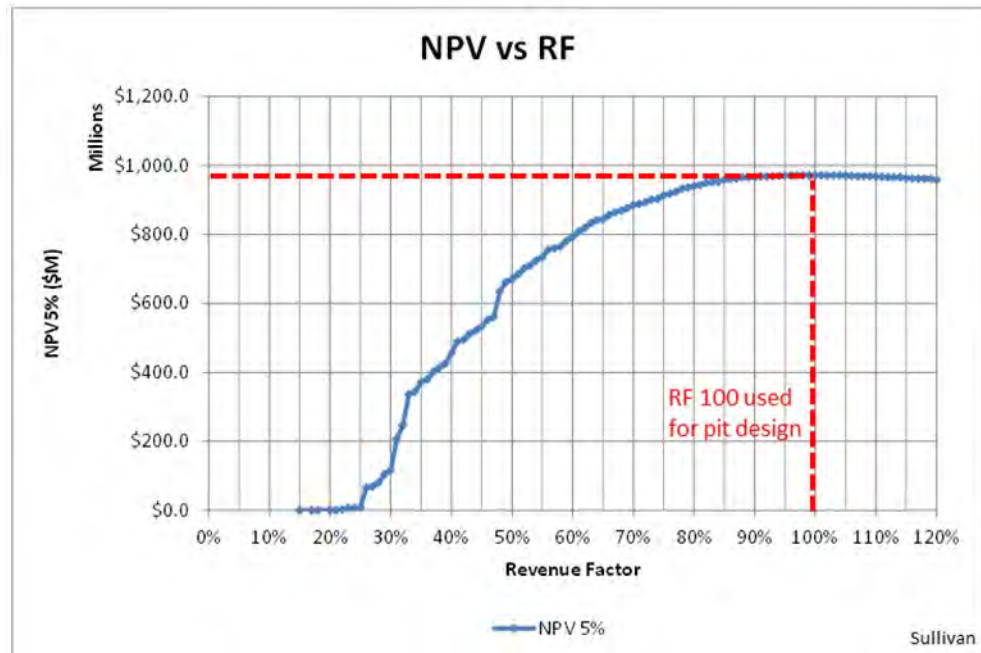

Figure 16-5 Sullivan Pit Optimization (NPV vs Revenue Factor)

16.2 OPEN PIT DESIGNS

The open pit designs were developed using the selected optimized shells as templates for defining the pit depths.

The preparation of the open pit layouts examined preferred access points along the pit periphery, and then incorporating benches, ramps and haul roads according to the parameters shown in Table 16-2.

Single lane haul roads were used in several of the shallow open pits to minimize the addition of excess waste rock from expanding the pit walls outwards more than required.

The larger open pits were sub-divided into phases for scheduling purposes. As well some of the smaller distinct pits were nominated as separate phases for scheduling. A total of ten phases were designed and scheduled.

The various open pit layouts are shown in Figure 16-6, Figure 16-7, Figure 16-8 and Figure 16-9.

Table 16-2
Open Pit Design Parameters

		Oxide	Sulphide
Mining Height	m	5.0	5.0
Benching	No.	3	3
Final Bench Height	m	15.0	15.0
Bench Face Angle	deg	65	75
Berm Width	m	8.0	8.6
Inter-Ramp Angle	deg	45.0	50.0
Haul Road Width	Double	26 m	
	Single	18 m	



Figure 16-6 Car Body Open Pits



Figure 16-7 Gold Ledge Open Pit



Figure 16-8 Lucky Strike Open Pit



Figure 16-9 Sullivan Open Pit

16.2.1 Geotechnical Studies

No open pit slope geotechnical site investigations have been completed for this PEA. Pit slopes used for open pit design are based on experience with similar rock mass conditions.

16.2.2 Hydrogeological Studies

No hydrogeological studies have been completed for this PEA to evaluate the groundwater conditions at site.

16.2.3 Dilution and Losses

Process plant feed waste dilution and losses will occur during mining. It is assumed that some waste rock surrounding the mineralized zones would be mixed with the plant feed during mining, thereby causing dilution.

In order to estimate the amount of dilution, a 1 metre thick dilution “skin” was assumed around the outside perimeter of the mineralized zone and this was modelled on several of the open pit benches. The volume of this skin relative to the volume of the mineralized zone subsequently determines the percent dilution. This is averaged over several benches in each open pit to derive the overall average dilution percentage. Each deposit could have a different amount of dilution depending on the specific geometry of the mineralized zone. However, for the purposes of this PEA, a single dilution and a mining loss factor have been determined for all deposits.

A 3D solid was created for the dilution “skin” surrounding the mineralized zone, and the diluting grades were estimated within that 3D solid. The diluting grades are summarized in Table 16-3. A 3% mining loss has been applied.

**Table 16-3
Dilution & Loss Parameters**

Feed Loss	Dilution	Au (g/t)	Cu (g/t)	AuEq (g/t)
3%	6%	0.22	0.01	0.23

16.3 POTENTIAL OXIDE AND SULPHIDE FEED

After the open pit designs are completed and the dilution and feed loss factors are applied to the tonnage contained within, the potential process plant feed and waste tonnages are reported inside each pit. A total of 125.3 Mt of plant feed is planned to be mined and processed.

Table 16-4 presents the PEA production plan tonnage as Indicated and Inferred Mineral Resource classifications. There is no Measured Mineral Resource. Approximately 43% of the oxide material is in the Indicated category while 28% of sulphide material is Indicated. Overall,

37% of the total feed tonnage is Indicated Mineral Resource and the remainder is Inferred Mineral Resource.

Table 16-4
Mine Plan by Mineral Resource Classification

Mineral Resource	Feed (Mt)	Au (g/t)	Ag (g/t)	Cu (%)	AuEq (g/t)
Oxide (>0.25 g/t AuEq)					
Indicated	34.0	0.44	1.40	0.25	0.71
Inferred	45.2	0.44	0.89	0.21	0.66
Sulphide (>0.41 g/t AuEq)					
Indicated	12.7	0.45	1.20	0.28	0.82
Inferred	33.4	0.42	1.02	0.24	0.74

Table 16-5 presents the waste rock and feed tonnages for the four deposits. The largest pit is the Lucky Strike pit, while the smallest is Gold Ledge. The diluted tonnages are used as the planning basis for the PEA production schedule.

Table 16-5
Tonnage Summary by Deposit (Diluted)

Item	Total	Car Body	Gold Ledge	Lucky Strike	Sullivan
Total Material (Mt)	524.7	20.9	6.6	276.8	220.4
Total Waste (Mt)	399.3	16.7	3.8	222.4	156.5
Strip Ratio	3.19	3.93	1.32	4.09	2.45
Total Feed (Mt)	125.3	4.3	2.8	54.4	63.9
AuEq (g/t)	0.71	0.85	0.45	0.68	0.74
Au (g/t)	0.43	0.85	0.19	0.41	0.44
Cu (%)	0.24	0.00	0.23	0.23	0.25
Ag (g/t)	1.09	0.31	-	0.99	1.28

16.4 PRODUCTION SCHEDULE

The mine production schedule consists of one year of pre-production stripping and just over 13 years of mine production. With mineralized stockpiles built up over the life-of-mine, processing will be carried out over 14.2 years.

The target crushing rate is 9.0 Mtpa, or approximately 25,000 tpd. The total annual mining rates of leach feed and waste rock combined will peak at approximately 56 Mtpa (150,000 tpd). Table

16-6 presents the life-of-mine mine production schedule. Table 16-7 shows the sequence and duration of the ten pit phases mined.

In most years, mining will excavate both oxide and sulphide feed. In the first five years, oxide will be sent to the heap leach facility while sulphide is stockpiled for later processing. In Year 6, the flotation mill is commissioned. Table 16-8 presents the processing schedule for both heap leaching and flotation milling.

Heap Leaching: Heap leaching operates for the first five years at a rate of 9 Mtpa. The economic cut-off grade for oxide feed is 0.25 g/t AuEq. During the five-year heap leaching period, sulphide feed will be stockpiled. By Year 6, a stockpile of approximately 3.9 Mt will be available for mill commissioning.

Mill Processing. In Year 6, the 5.0 Mtpa flotation mill will be commissioned using the stockpiled sulphide feed. After Year 6, the process plant will be supplied with sulphide feed. The heap leach will continue to operate, at a reduced rate of 4.0 Mtpa (down from 9.0 Mtpa initially). The total feed crushing capacity will remain at 9.0 Mtpa.

16.4.1 Plant Feed Stockpiles

The production plan utilizes three stockpiles to facilitate processing higher grade material ahead of lower grade feed. These stockpiles are:

Low Grade Oxide Stockpile: This stockpile is for heap leach feed between the grades of 0.25 g/t and 0.45 g/t AuEq. The lower grade oxide is stockpiled and only processed when there are shortfalls in mining of higher grade oxide.

Oxide Surge Stockpile: This surge stockpile is for heap leach feed above 0.45 g/t AuEq. It is a live stockpile that is used to mitigate fluctuations in heap leach feed. Excess oxide tonnes mined are placed into the stockpile. When there are temporary oxide mining shortfalls, material is withdrawn from the stockpile to feed the crusher. When excess tonnes are mined, the lower grade portions are placed into the stockpile and higher grade is sent directly to the crusher.

Sulphide Surge Stockpile: This surge stockpile is for flotation plant feed. It is a live stockpile that is used to mitigate fluctuations in mill feed. Excess sulphide tonnes mined are placed into the stockpile. When there are temporary mining shortfalls, material is withdrawn from the stockpile to feed the crusher. When excess tonnes are mined, the lower grade portions are placed into the stockpile and higher grade is sent directly to the crusher.

Table 16-6
Annual Mine Production Schedule Summary

MINING		Y-1	Y1	Y2	Y3	Y4	Y5	Y6	Y7	Y8	Y9	Y10	Y11	Y12	Y13	Y14
Total Material (Mt)	524.7	16.0	48.0	48.0	56.0	56.0	56.0	56.0	24.0	24.0	24.0	24.0	36.0	36.0	20.0	0.7
Total Waste (Mt)	399.3	14.6	34.7	37.0	47.2	48.4	48.9	43.3	17.0	13.4	11.1	18.1	29.1	30.5	6.0	0.0
Strip Ratio	3.19	10.37	2.61	3.36	5.39	6.34	6.84	3.41	2.43	1.27	0.87	3.09	4.22	5.51	0.42	0.07
Total Feed (Mt)	125.3	1.4	13.3	11.0	8.8	7.6	7.1	12.7	7.0	10.6	12.9	5.9	6.9	5.5	14.0	0.6
AuEq (g/t)	0.71	1.19	0.81	0.72	0.68	0.54	0.64	0.71	0.59	0.70	0.76	0.66	0.70	0.76	0.77	0.53
Au (g/t)	0.42	-	0.57	0.44	0.39	0.27	0.36	0.42	0.34	0.41	0.44	0.35	0.32	0.49	0.53	0.20
Cu (%)	0.24	0.00	0.22	0.25	0.26	0.24	0.25	0.24	0.21	0.24	0.25	0.26	0.31	0.22	0.19	0.25
Ag (g/t)	1.09	0.32	1.62	1.01	1.04	1.20	1.24	1.27	0.78	1.02	0.97	0.63	0.83	1.34	1.03	0.65
Oxide Feed (Mt)	79.3	1.4	12.7	10.1	7.1	7.6	6.4	6.7	4.5	4.7	4.1	4.0	3.0	2.7	4.3	
Transition Feed (Mt)	1.5		0.1					0.0	0.0	0.6	0.7			0.0	0.0	
Sulphide Feed (Mt)	44.5		0.5	0.9	1.7		0.7	6.0	2.5	5.2	8.0	1.9	3.9	2.8	9.7	0.6

Note: the potential leach feed tonnages utilized in the PEA contain both Indicated and Inferred Mineral Resources. The reader is cautioned that Inferred Mineral Resources are considered too speculative geologically to have the economic considerations applied to them that would enable them to be categorized as Mineral Reserves, and there is no certainty that value from such Mineral Resources will be realized either in whole or in part.

Table 16-7
Phase Mining Sequence (Total Tonnes per Year)

Pit Phase of Waste + Feed Tonnages	Mt	Y-1	Y1	Y2	Y3	Y4	Y5	Y6	Y7	Y8	Y9	Y10	Y11	Y12	Y13	Y14
PHASE-1 SULLIVAN PIT#1	47.8	9.5	31.0	3.0	4.3											
PHASE-2 LUCKY STRIKE PIT#1	32.4		8.0	24.4												
PHASE-3 LUCKY STRIKE PIT#2	151.7				6.0	24.5	33.5	33.5	18.7	8.2	7.9	8.1	7.2	4.0		
PHASE-4 GOLD LEDGE	6.6		2.0	3.8	0.9											
PHASE-5 CAR BODY MAIN	12.2	5.2	7.1													
PHASE-6 CAR BODY NW#1&2	4.9	0.2										1.5		3.0	0.2	
PHASE-7 CAR BODY NE#1	1.2	1.2														
PHASE-8 CAR BODY NE#2	2.6												0.8	1.2	0.6	
PHASE-9 LUCKY STRIKE PIT#3	92.6										2.7	14.4	28.0	27.7	19.1	0.7
PHASE-10 SULLIVAN PIT#2	172.6			16.8	44.8	31.5	22.5	22.5	5.3	15.8	13.5					

**Table 16-8
Annual Processing Schedule Summary**

PROCESSING		Y-1	Y1	Y2	Y3	Y4	Y5	Y6	Y7	Y8	Y9	Y10	Y11	Y12	Y13	Y14	Y15
LEACH Feed (Mt)	79.3		9.0	9.0	9.0	9.0	9.0	4.0	4.0	4.0	4.0	4.0	4.0	4.0	4.0	2.3	
AuEq (g/t)	0.68	-	1.03	0.82	0.61	0.51	0.54	0.76	0.55	0.68	0.75	0.64	0.50	0.68	0.89	0.36	-
Au (g/t)	0.44	-	0.78	0.54	0.35	0.26	0.31	0.52	0.35	0.43	0.47	0.36	0.25	0.51	0.67	0.20	-
Cu (%)	0.22	-	0.23	0.26	0.24	0.22	0.21	0.22	0.19	0.23	0.26	0.25	0.23	0.16	0.21	0.14	-
Ag (g/t)	1.11	-	1.68	1.28	0.96	1.17	1.16	1.40	0.72	0.89	0.72	0.60	0.55	1.21	1.39	0.64	-
Mill Feed (Mt)	46.0							5.0	5.0	5.0	5.0	5.0	5.0	5.0	5.0	5.0	1.0
AuEq (g/t)	0.77	-	-	-	-	-	-	0.90	0.75	0.78	0.83	0.71	0.80	0.71	0.74	0.70	0.72
Au (g/t)	0.43	-	-	-	-	-	-	0.52	0.41	0.43	0.47	0.36	0.37	0.36	0.49	0.42	0.45
Cu (%)	0.26	-	-	-	-	-	-	0.29	0.26	0.26	0.27	0.26	0.33	0.26	0.18	0.21	0.20
Ag (g/t)	1.07	-	-	-	-	-	-	1.27	1.09	1.20	1.20	0.90	1.08	1.11	0.95	0.85	0.88

Note: the potential leach feed tonnages utilized in the PEA contain both Indicated and Inferred Mineral Resources. The reader is cautioned that Inferred Mineral Resources are considered too speculative geologically to have the economic considerations applied to them that would enable them to be categorized as Mineral Reserves, and there is no certainty that value from such Mineral Resources will be realized either in whole or in part.

16.5 OPEN PIT MINING PRACTICES

It is assumed that the Gabbs mine will be an owner-operated open pit mine. While contract mining may be an option, this was not considered in this PEA.

The owner's mining team would undertake all drill and blast, loading, hauling, and mine site maintenance activities. The owner will also be responsible for overall mine management and technical services, such as mine planning, grade control, geotechnical, and surveying services.

It is anticipated that the mining operations would be conducted 24 hours per day and 7 days per week throughout the entire year.

It is assumed that most of the materials mined will require drilling and blasting to some degree, except for the gravel overburden that will be free digging.

16.5.1 Equipment Fleet and Personnel

It is expected that 15 cu.m hydraulic excavators and a diesel-powered front-end loader will be used to excavate the blasted rock. The anticipated truck size is 136 t and the fleet will peak at 19 trucks.

The primary mining operation will be supported by a fleet of equipment consisting of dozers, road graders, watering trucks, maintenance vehicles, and service vehicles.

The deeper open pits will likely experience groundwater seepage. No quantitative information was available to adequately predict the expected water inflow into the pits but it is expected to be minimal. Table 16-9 summarizes the expected mining equipment fleet for the first five years of peak production.

The mining personnel will peak at approximately 219 people, including operators, maintenance, supervision, and technical staff. The breakdown by role is presented in Table 16-10.

**Table 16-9
Mine Equipment Fleet (Peak in First Five Years)**

Equipment Type	Number of Units
Drill, 250 mm, Crawler, Rotary	3
Stemming Truck, 15 t	1
Transport for Detonators	1
Hydraulic Excavator, 15.3 cu.m	4
Wheel Loader 12 cu.m	2
Haul Truck 136 t	19
Personnel Van/Bus	1
Dump Truck, 10 t	1
Skid Steer	1
Dozer D10	4
Welding Truck	1
Excavator, (4 cu.m)	1
Fuel Truck	1
Grader 16H-class 16' blade	2
Flat Deck	1
Lighting plant	4
Lube Truck	2
Mechanic Truck	1
Pickup Truck	8
Pit Dewater Pumps Diesel	2
Flat Deck with Hiab	1
Forklift	1
Welding Truck	1
Water Truck (40 ton 8,000 gallon)	1
Drill, 90 mm, Crawler, Percussion, Trailer, Lowboy	1

Table 16-10
Mining Personnel List (Peak in First Five Years)

Title	Number of Personnel
Driller	9
Driller Helper	9
Blasting Foreman	1
Blaster	1
Laborer	2
Truck Drivers	71
Shovel Operator	15
Loader Operator	4
Heavy Duty Mechanic	56
Pit Services (dewatering)	2
Grader Operator	4
Dozer Operator	6
Water Truck Operator	4
Utility Operators	2
Mine Superintendent	1
Mine General Foremen	1
Mine Foremen	4
Mine Clerk	1
Maintenance General Foreman	1
Maintenance Foreman	4
Planner	1
Welder	2
Gas Mechanic	2
Tireman	1
Partsman	1
Laborer	4
Equipment Trainer	1
Chief Engineer	1
Senior Mine Engineer	1
Mine Engineer	1
Geologist	1
Surveyor	1
Survey Technician	1
Mine Technician	1
Grade Control Technician	2
Total	219

16.5.2 Waste Rock Storage Facilities

Each of the open pits will require the development of one or more waste rock storage facilities. Some of the waste will be placed into hillside waste storage facilities adjacent to the open pit and, depending upon the mining sequences, it may also be possible to backfill mined-out pits if there is no likelihood of re-mining those open pits in the future. The waste rock storage facility locations are shown in Figure 16-1.

At this stage of the PEA, the waste rock storage facilities were not designed in detail, however, potential sites were identified and field reconnaissance will be done at the next stage of study to confirm the preferred locations.

16.5.3 Mine Support Facilities

The Gabbs open pit operation will require mine offices, maintenance facilities, warehousing, lube and fueling station, and cold storage areas.

17.0 RECOVERY METHODS

17.1 Summary

Test work results have indicated that the Gabbs mineralized material is amenable to both heap leaching and milling/flotation for the recovery of gold, silver and copper. The first five years of mine life will be a heap leach operation treating oxide material. Starting in year 6 when additional sulphide resources become available, the sulphide materials will be processed through the mill. Oxide materials will continue to be processed via the heap leach at a reduced throughput rate. The heap leach and milling facility will use the same crushing, SART and ADR circuits.

17.1.1 Heap Leaching

The Gabbs heap leach material is estimated to contain an average of 0.44 g/t gold, 1.11 g/t Ag and 0.22% copper based on the mine plan used for this study. A portion of this copper is cyanide soluble and is expected to be extracted in the heap leach circuit. The cyanide soluble copper has an effect on the cyanide consumption. A SART plant that releases cyanide associated with the copper cyanide complex, allowing it to be recycled back to the leach process as free cyanide is included. The resulting copper and silver precipitate will be sold, bringing additional revenue to the project.

The material will be mined by standard open-pit mining methods, crushed using a three-stage crushing system incorporating a high-pressure grinding roll (HPGR) crusher as the tertiary stage, agglomerated with cement and conveyor stacked on the heap leach pad in 8-metre lifts.

The pad will be constructed in four phases and will hold approximately 80 million tonnes. The heap leach pad will have a composite liner consisting of clay and textured HDPE geomembrane.

Heap material will be single-stage leached with a dilute cyanide solution for a total leach cycle of 150 days. The gold, silver, and copper bearing solution will be collected in the pregnant solution pond and pumped to the SART plant. Pregnant solution will be acidified with sulphuric acid, then copper and silver will be precipitated as sulphides by the addition of sodium hydrosulphide. The precipitate will be thickened and filtered to produce a copper-silver filter cake for shipment to a smelter. The barren solution from the SART plant will be neutralized with slaked lime and processed in a carbon adsorption-desorption-recovery (ADR) plant to recover gold. The gold will be periodically stripped from the carbon using a desorption process. The gold will be plated on stainless steel cathodes, removed by washing, filtered, dried and then smelted to produce a doré bar.

The criteria for the design of the heap leach processing circuit are summarized in Table 17-1 and an overall heap leach process flowsheet is presented in Figure 17-1 Gabbs Overall Heap Leach Process Flowsheet.

The heap leach material throughput will be 6,000,000 tonnes per year in Years 1 through 5, reduce to 5,000,000 tonnes per year in Years 5 through 14 and be 4,316,829 tonnes in Year 14.

**Table 17-1
Gabbs Heap Leach Process Design Criteria Summary**

ITEM	DESIGN CRITERIA
Annual Tonnage Processed (Average LOM)	
Average LOM	8,356,000 tonnes
Crushing Production Rate for Heap Leach	
Years 1 to 5	24,658 tonnes per day
Years 6 to 14	10,959 tonnes per day
Crusher Availability	75%
Crushing Product Size	80% -6.3 mm
Conveyor Stacking System Availability	75%
Leaching Cycle, days (Total)	150
Average Sodium Cyanide Consumption, kg/t	0.35
Average Cement Consumption, kg/t	6.23
Gold Recovery	78.3%
Silver Recovery	45.0%
Copper Recovery	54.0%

17.1.2 Milling

Up until the mill becomes operational, all mined sulphide material will be stockpiled. Upon startup of the mill, the stockpiled material will be fed to the mill along with mined sulphide material.

The ROM sulphide material will be crushed to P₈₀ 6.3 mm, (1/4 inch) in a three-stage crushing circuit, with the third-stage being an HPGR. The ore will be conveyed to a ball mill circuit to produce a primary grind P₈₀ 0.075 mm.

The milled sulphide product will be treated in a flotation plant to produce a copper concentrate suitable for sale. The flotation tailings will be thickened, then direct cyanide leached to dissolve gold, silver and copper. The leached solids will be washed in a CCD circuit to remove dissolved gold, silver and copper. The dissolved silver and copper will be recovered from the CCD overflow solution in a SART plant as a copper-silver sulphide precipitate. Regenerated sodium cyanide from the SART plant will be recycled to the leach circuit. Gold in the SART plant barren solution will be recovered in an ADR plant and refined to produce doré bars.

The CCD tails are treated in a cyanide destruction circuit, filtered, and conveyed to a “dry stack” storage facility.

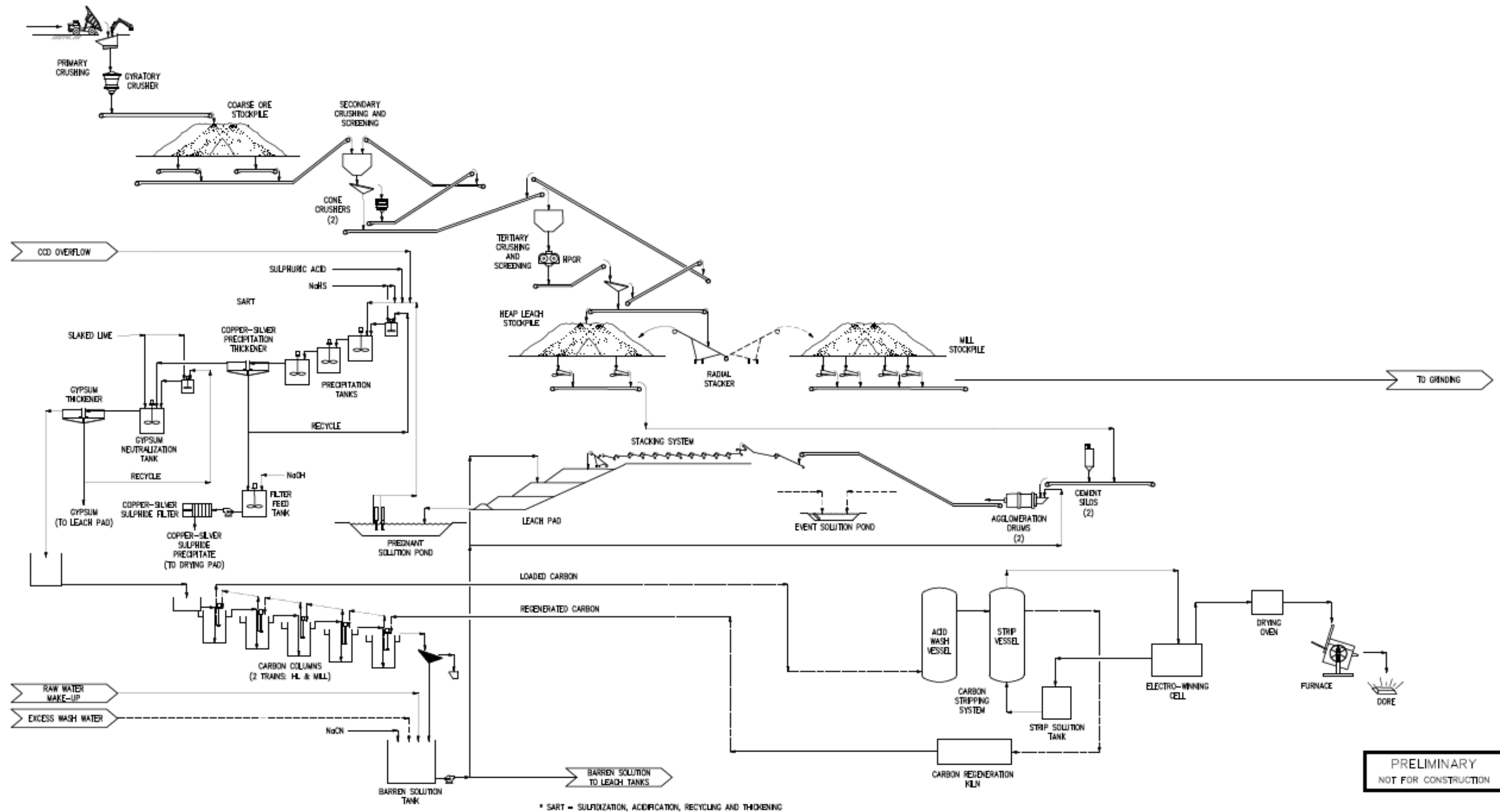

PRELIMINARY
NOT FOR CONSTRUCTION

Figure 17-1 Gabbs Overall Heap Leach Process Flowsheet

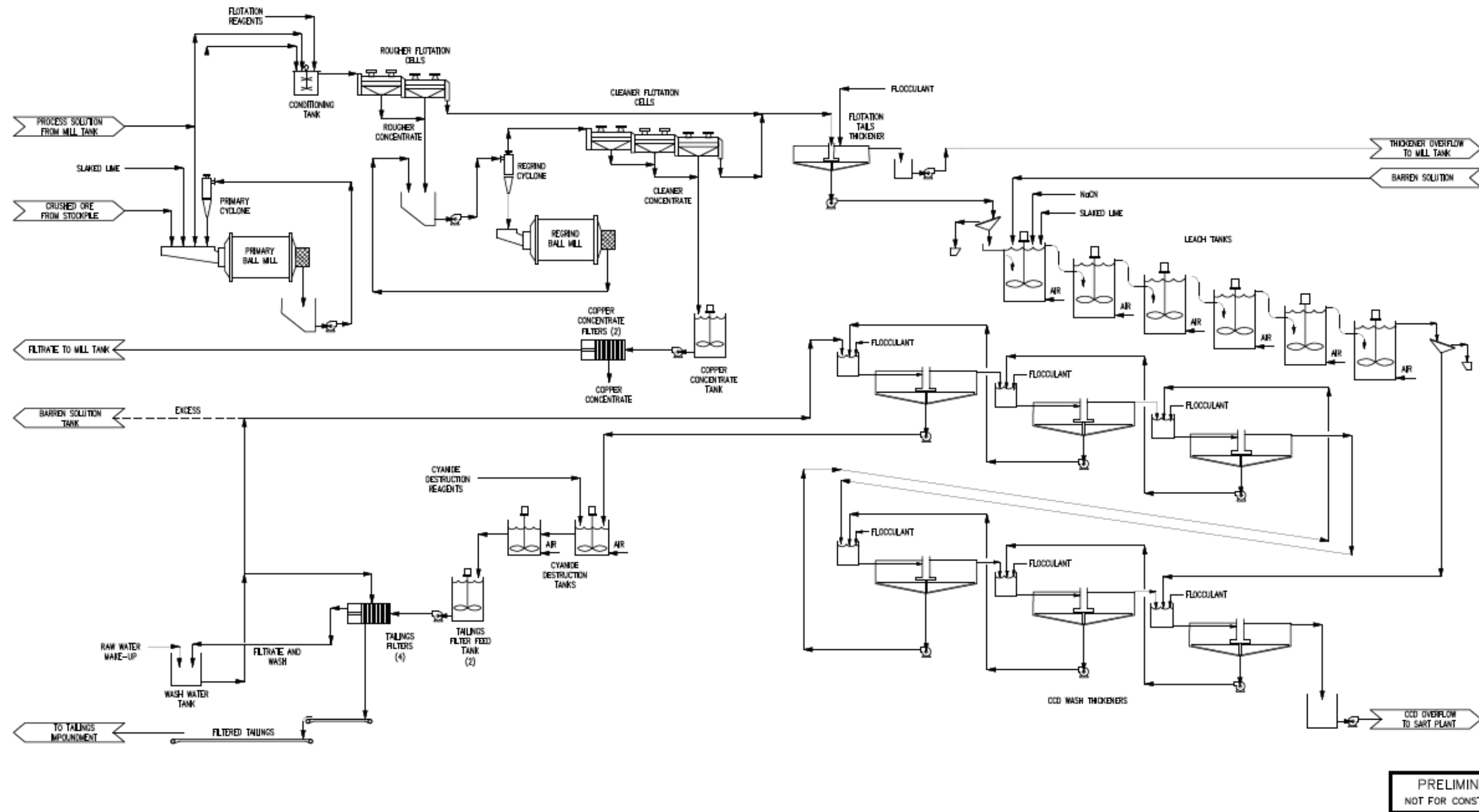
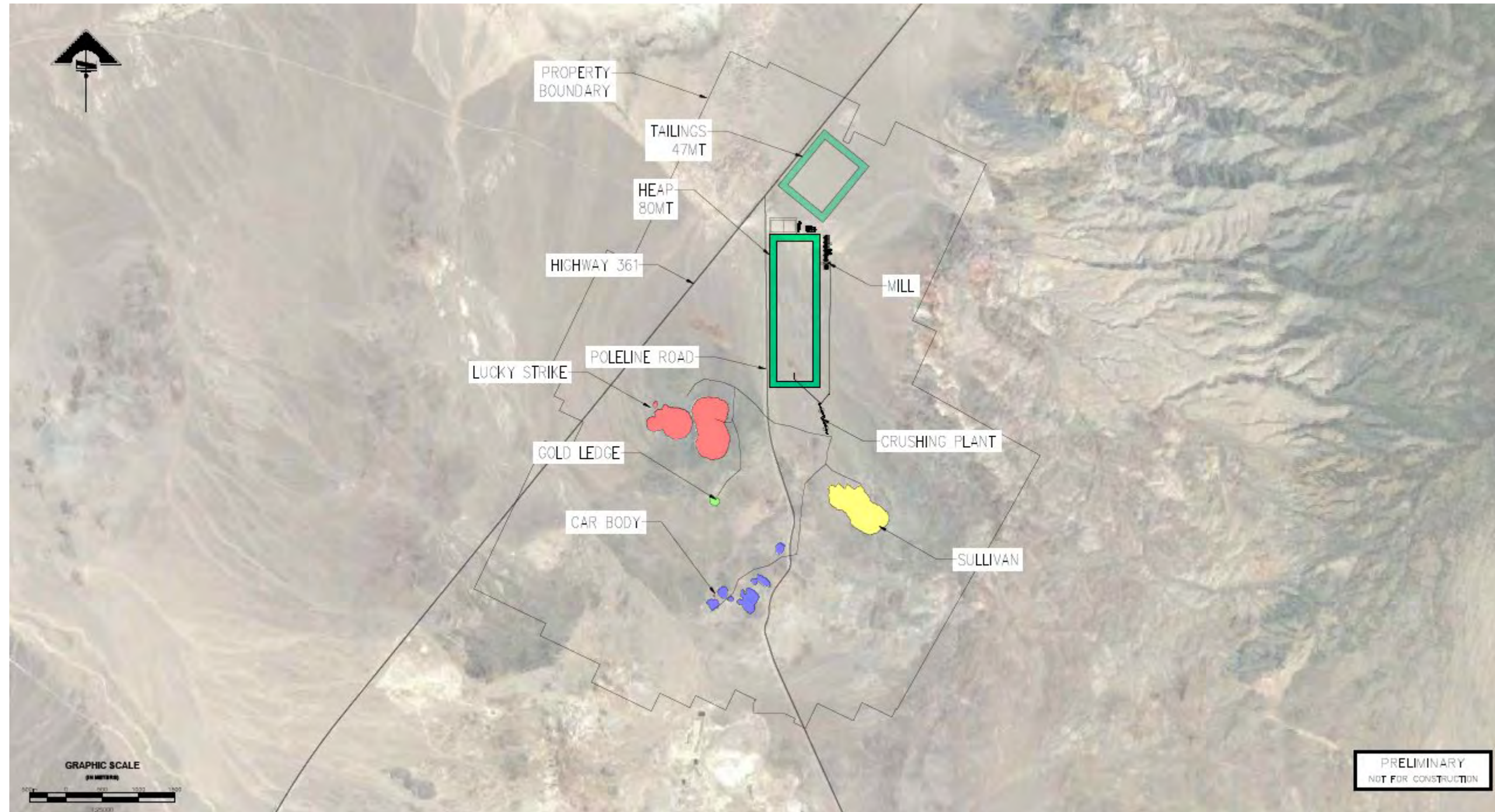

Figure 17-2 Gabbs Overall Milling Process Flowsheet



source KCA 2023

Figure 17-3 Gabbs Overall Site Plan View

17.2 Process Description

Processing of ore at the Gabbs Project will take place on a seven-day, 24-hour operating schedule for all operational circuits, with the exception of maintenance downtime. The site plan for the process plant is found insource KCA 2023

Figure 17-3.

17.2.1 Crushing (Heap Leach)

Crushing for the Gabbs project will be accomplished by a three-stage crushing system with an open primary crushing circuit, closed secondary, and closed tertiary crushing circuits operating seven days per week, 24 hours per day. Material will be crushed using a primary gyratory crusher which will discharge on to a primary crusher discharge conveyor. The primary crushing products will be stockpiled by a stacker conveyor.

Material from the primary crushed stockpile will be reclaimed using subterranean feeders and will be conveyed to the secondary screen feed conveyor. The secondary crushing circuit will include two double deck vibrating screens and two cone crushers. The secondary screen oversize will be transferred to the secondary cone crusher surge bin by conveyors and will be fed to the secondary cone crushers by belt feeders. The secondary cone crusher discharge will recycle back to the secondary screen.

Secondary screen undersize material will be conveyed to the tertiary crusher feed bin, reclaimed using a belt feeder to the tertiary crusher. The tertiary crushing circuit will consist of an HPGR crusher operated in closed circuit with a fine screening plant. The design for the final crushed product is 80% passing 6.3 mm.

The tertiary screen oversize will be transferred to the HPGR recycle conveyor and recirculated to the Tertiary Crusher Feed Bin. The tertiary screen undersize will be stockpiled by a stacking conveyor.

Material from the crushed material stockpile will be reclaimed using two (2) subterranean feeders and conveyed to the agglomeration circuit. The reclaim conveyor will discharge to a splitting chute to feed two parallel agglomeration feed conveyors. Cement will be added to the crushed product on the agglomeration feed conveyors from the cement silos. The cement addition rate will be controlled by weightometers mounted on the individual agglomeration feed conveyors. The agglomeration feed conveyors will feed two parallel agglomeration drums where barren process solution will be added and cement is blended in. The agglomeration drums will discharge onto the agglomeration discharge conveyor and the material will be transported to the stacking system.

17.2.2 Heap Conveying and Stacking

Two (2) overland conveyors will transfer the material from the agglomeration discharge conveyor to the mobile conveyor stacking system. The stacking system includes ramp conveyors, grasshopper conveyors, index feed conveyor, horizontal index conveyor and a radial stacker. As the radial stacker retreats uphill, the system will be periodically stopped to remove grasshopper conveyors, as needed.

Stacked material will consist of crushed, agglomerated material. Once a lift has finished leaching, and is sufficiently drained, a new lift can be stacked over the top of the old lift. The old lift will be cross-ripped with a dozer prior to stacking the new lift to break up any compacted heap leach material and to redistribute material that may have been winnowed by the irrigation solution or rainfall. Additional lifts will be placed on top of the previously leached material.

17.2.3 Heap Leaching

Following stacking, the material will be irrigated with a dilute sodium cyanide barren leach solution and the resulting gold, silver and copper bearing solution will be collected in the pregnant solution pond. The heap will be irrigated using a drip-tube irrigation system for solution application. HDPE or PVC pipes will be used to distribute the solution to the drip-tubes on top of the heap. Antiscalant will be added to the suction of the barren and pregnant solution pumps to reduce the potential for scaling problems within the system.

The total leach cycle of 150 days has been designed for the heap leach system, which is based upon metallurgical test work completed to-date. Two horizontal centrifugal pumps, operating in parallel at the barren tank, will be used for the barren solution application to the heap.

The two (2) process solution and two (2) agglomeration solution pumps will provide barren solution, from the barren tank, to the process areas. Sodium cyanide solution and an antiscalant will be added to the suction side of the barren leach solution pumps by metering pumps. The combined nominal flow to the heap will be 2,200 m³/h during the initial years of operation. When the heap operates at the lower throughput from Year 6 onwards, the nominal flow to the heap will be 1,000 m³/h.

Gold, silver and copper bearing solution draining from the leach pad will be collected by a network of perforated drainage pipes that are directed to the pregnant solution pond. Pregnant solution will be pumped from the pregnant solution pond by submersible pump to the SART circuit.

17.2.4 Heap Leach Facility

Ore from the Gabbs deposit will be processed by heap leaching. A single heap leach facility has been designed for the site. The Heap Leach Facility (HLF) will have a final material capacity of approximately 80 million tonnes. The HLF will provide a total lined leach pad surface area of approximately 1,482,000 square metres.

The Preliminary Economic Assessment design of the leach pad meets or exceeds North American standards. North American construction standards are intended to mitigate environmental impacts to surface and subsurface water sources. Actual standards used in subsequent stages should be carefully considered and implemented to ensure that environmental impacts are mitigated to the extent required under prevailing laws, regulations and international standards.

Crushed material is designed to be stacked at a rate of 24,658 tonnes per day (tpd). Material will be crushed and agglomerated, then placed on the leach pad using a portable stacking system. Crushed material will be stacked in approximately 8-metre lifts with benches provided between lifts to create an average overall slope of 2.5H:1V (horizontal to vertical), which is necessary to provide geotechnical stability and minimize grading during reclamation.

The drainage layer overliner material placed above the leach pad geomembrane will be a free-draining crushed durable gravel with a minimum permeability of 1×10^{-1} cm/sec. The minimum permeability requirement of the overliner is designed to prevent the maximum head on the liner from exceeding 0.7 m. A small portable crusher operated by a contractor is planned to manufacture the overliner material by crushing and processing durable mine waste rock, low-grade mineralized material that has been mined from the mine pit, or durable rock developed through on-site excavation within the footprint of the leach pad or process facilities.

During leaching, solution will be collected above the composite liner system by a network of perforated collection pipes within the overliner material layer. The perforated solution collection piping network will convey the pregnant solution to the Pregnant Pond located at the lower end of the leach pad.

Barren solution will be applied to the leach pad at a rate of 8 litres per hour per square metre (L/hr/m²). The barren solution will be pumped and applied to the crushed material at a maximum total volumetric flowrate of 2,200 m³/hr during initial heap operations. At the lower throughput in Year 6 onwards, the flowrate will be 1,000 m³/hr.

During operations, a gypsum slurry will be produced as a by-product of the SART operations. Gypsum slurry will be disposed of on an unirrigated section of the heap.

Storm water diversion channels are sized to contain the runoff from upstream basins resulting from the 1 in 100-year, 24-hour storm event that is a typical industry standard. The diversion channels around the HLF and process ponds are designed to convey this runoff in riprap-lined diversion channels. Sediment control structures are designed in drainages downstream of the facility to control sediment from runoff conveyed in diversion channels and underdrain flows.

17.2.5 Solution Storage

The HLF is designed to be a zero-discharge facility during a wet year. The HLF utilizes Pregnant and Event ponds to collect and store solution. The process ponds are designed to contain the pregnant solution and stormwater runoff from the heap during the 1 in 100 year storm event.

Pregnant and Event Ponds will utilize a composite lining system with double 2-mm HDPE geomembrane and geonet layers above the soil bedding layer. These additional layers provide a synthetic dual-containment and leak detection system.

17.2.6 Crushing (Mill)

Crushing for the mill will use the same equipment as used for the heap leach. Sulphide material will be loaded to the primary crusher sourced directly from the open pit or from previously mined and stockpiled material. The crushed material will be to the same product size specifications as the heap leach material (80% passing 6.3 mm) and stockpiled. Material from the crushed material stockpile will be reclaimed using four (4) subterranean feeders and conveyed to the mill area into the primary ball mill feed chute.

17.2.7 Primary Grinding

The primary ball mill will operate in closed circuit with hydrocyclones to produce a 75-micron P80 overflow product. Lime will be added to the ball mill feed for pH adjustment and process solution from the mill tank will also be added as dilution water. The ball mill will discharge over a trommel screen before flowing into the cyclone feed pumpbox. The cyclone feed pump will pump the ball mill discharge to the hydrocyclones. Underflow from the cyclones will be returned to the primary ball mill feed chute.

The cyclone overflow will be directed to one of two locations depending on the material type being campaigned at the time. Overflow will flow to the flotation conditioning tank..

17.2.8 Flotation and Regrind

Cyclone overflow will be directed to the agitated conditioning tank where collector and frother will be added to condition the slurry before it is introduced to the rougher flotation cells for copper recovery. The rougher concentrate will collect in a pump box and be pumped to regrind cyclones classification. Coarse underflow will be directed to the regrind ball mill, the discharge will be passed over a trommel screen before being returned to the pump box. The overflow from the regrind cyclones will flow by gravity to the cleaner flotation cells to produce the copper cleaner concentrate. Cleaner concentrate will flow by gravity to the agitated concentrate tank. The tails from the cleaner flotation circuit will combine with the tails from the rougher flotation circuit and flow by gravity to the flotation tails thickener.

17.2.9 Copper Concentrate Filtering

The copper concentrate from cleaner flotation will be pumped to be dewatered by two (2) horizontal, recessed plate filter presses. The filtered concentrate, after being dropped from the press will be stored for sale.

17.2.10 Flotation Tails Thickener

The flotation tails thickener will thicken the tails from flotation to the target leach feed density in the underflow. Flocculant will be added at the center feedwell for settling purposes. The underflow will be pumped by the thickener underflow pump to the leach circuit. The overflow from the thickener will flow into the mill tank for mill water usage.

17.2.11 Leach Tanks and Countercurrent Decantation

The leach circuit consists of six agitated air-sparged tanks in series which flow by gravity, cascading from one tank to the next. Sodium cyanide will be added in the first tank along with slaked lime for pH control, to leach gold, silver and cyanide-soluble copper. Upon exiting the final leach tank, the slurry will flow to the countercurrent decantation circuit to wash the leached metal values from the leached slurry.

The countercurrent decantation (CCD) circuit will consist of a series of six wash thickeners with mixing stages prior to each. Wash solution will flow by gravity from one thickener to the next, countercurrent to slurry, as entrained gold, silver and copper are washed from the slurry. The solution will overflow into the CCD overflow tank upon exiting the final thickener. This solution will proceed to the SART circuit. The slurry on the other hand, after being washed of the entrained metal values as it is pumped upstream, will be pumped as underflow from the first thickener to the cyanide destruction circuit. Flocculant will be added at each mixing stage to provide effective solid-liquid separation in the thickeners.

17.2.12 Cyanide Destruction

The cyanide destruction circuit will incorporate the air/SO₂ process to reduce WAD cyanide levels in the slurry from the CCD circuit to below permissible discharge limits. It will consist of an agitated tank where air, lime, sodium metabisulfite and copper sulphate are added. The now-detoxified slurry will flow into the filter feed tank.

17.2.13 Tails Filtration

Automated, recessed plate filter presses will be used to dewater the detoxified tailings in the filter feed tank. The dewatered tailings will drop on to a series of conveyor belts to be transported to the tailings impoundment. The filtrate from the filter press will collect in the wash water tank. The filtrate will be used as wash water in the CCD circuit. Raw water will be added to the wash water tank as needed to supplement the wash water supply.

17.2.14 Process Water Balance

The Project area is in a relatively dry region which makes solution management fairly simple. Due to the limited site rainfall, storm water control will rely on the available volume in the pregnant and event ponds.

The Project will be in a water deficit and makeup water will be required. Makeup water requirements will vary minimally between average, wet, and dry years due to the minimal overall precipitation at the Project site. Average year makeup water demands are estimated to range from 165 to 250 m³/hr for the heap leach and mill.

17.2.15 SART

Pregnant solution will be treated in a SART plant prior to entering the ADR plant for recovery of gold. Copper and silver precipitation will occur in the SART circuit to produce a saleable copper-silver product.

17.2.15.1 Copper and Silver Precipitation

Copper and silver precipitation operations will include acidification of pregnant solution, precipitation of copper and silver with sodium hydrosulphide in agitated tanks, thickening copper and silver precipitate, recycling thickener underflow solids to the precipitation tanks, neutralizing acidified thickener underflow prior to filtration and filtration. Filter cake will be conveyed to one of two drying pads with four days of capacity. The filter cake will be dried with air and propane heaters, if required. The dried copper-silver precipitate will be sized to pass a 5 mm vibrating screen and loaded in plastic lined 20-tonne containers or 1-tonne bulk bags for shipment.

17.2.15.2 Pregnant Solution Acidification

Concentrated sulphuric acid, 98 wt.%, will be diluted to 30 wt.% in a dilution tank. Pregnant solution will flow through an in-line mixer and be combined with 30 wt.% sulphuric acid to acidify the incoming pregnant solution to pH 4.0-4.5.

17.2.15.3 Copper-Silver Recycle Mix Tank

Thickener U/F recycle slurry, at 10-25 wt.% solids, will be combined with fresh sodium hydrosulphide solution in the Copper-Silver Recycle Mix Tank before entering the first precipitation reactor. Sodium hydrosulphide, 25 wt.%, will be added to the Copper-Silver Recycle Mix Tank to condition the sulphide surface before entering the precipitation tank.

17.2.15.4 Copper-Silver Precipitation Tanks

The acidified pregnant solution will be combined with recycled, conditioned copper-silver precipitate in the first of three agitated precipitation tanks. The solution will overflow from the precipitation tanks into the Copper-Silver Sulphide Thickener.

17.2.15.5 Copper-Silver Sulphide Thickener

Solution overflowing the third precipitation tank will be combined with flocculent in the Copper-Silver Sulphide Thickener. Copper-Silver Sulphide Thickener overflow solution will gravity flow to the Neutralization Reactor. Copper-Silver Sulphide Thickener underflow will be recycled to the Copper-Silver Rapid Mix Tank, and advanced to the Filter Feed Tank. The slurry will be flocculated and thickened to an underflow percent solid from 10 to 25% solids. The design thickener rise rate is 3.0 m/hr. Flocculant will be delivered dry and mixed in a standard mixing system and stored at a concentration of 0.5%. Flocculant will be diluted at the feed well to 0.02 wt.%.

17.2.15.6 Copper-Silver Precipitate Filtration

The Copper-Silver Thickener underflow will be pumped to the Filter Feed Tank and be filtered by the Copper-Silver Filters. The wet filter cake is conveyed to drying pads, dry material sizing, and conveyed to containers for bulk shipment to a smelter.

17.2.16 Copper-Silver Filter Feed Tank

Copper-Silver Thickener underflow slurry advancing at 10-25 wt.% solids will be stored in Copper-Silver Filter Feed Tank. The slurry at pH 4.0-4.5 will be neutralized with caustic solution 20 wt%, to pH 7-8. The Copper-Silver Filter Feed Tank provides a residence time of 12 hours.

17.2.17 Copper-Silver Filtration

Copper-silver precipitate filters will cycle manually every 4 to 8 hours. The batch cycle will be initiated by the operator, followed by a core blow. The filter cake be subjected to a blow cycle and will discharge with a cake moisture of 40 wt.%. A specific filtration rate of 33 kg/m²/hr, 15.9 mm per recessed plate, 30 mm cake thickness, and 10-16 bar operating pressure. Two filters will be installed and filtrate will be returned to the Neutralization Tank.

17.2.17.1 Filter Cake Conveying

Copper-silver filter cake will have approximately 40 wt.% moisture. Copper-silver filter cake batches will be conveyed away from the filter press over a 15–30-minute period to one of two drying pads. One drying pad will provide 4 days of residence time. Filter cake moisture will be reduced from 40 to about 20 wt.%. The drying pads will be partially covered, with fans to blow air over the filter cake. The dried filter cake will be sized to 100% minus 5 mm with a roll crusher/lump breaker and vibrating screen. The screen underflow product will be conveyed to 20-tonne containers. The copper-silver concentrate will be sampled from the conveyors as they fill the containers for concentrate settlement purposes.

17.2.17.2 Caustic Scrubber Systems

The Copper-Silver Recycle Mix Tank, Copper-Silver Precipitation Tanks, Copper-Silver Sulphide Thickener, Copper-Silver Filter Feed Tank, NaHS Storage Area sumps and Copper-Silver Area sumps will be ventilated to a caustic scrubbing system. The caustic scrubbing system will consist of two scrubbers, both packed towers with integral pumps, instrumentation and fan on UPS and emergency power. All motors will have VFD drives. The scrubbing system will remove hydrogen sulphide and hydrogen cyanide from the vent gases with approximately 15 wt.% caustic solution.

The scrubbing system design allows for a normal operating case and an emergency operating case. The normal operating case will treat 6,800 Nm³/hr (4,000 scfm) with assumed HCN and H₂S concentrations of 100 ppm_v. The scrubber efficiency of 99.8% will discharge 0.2 ppm_v HCN and H₂S.

The emergency scrubber system will operate with caustic solution circulating to the top of the packing and back to the pump, but not through the packing. Continuous hydrogen cyanide and hydrogen sulphide monitors will divert Normal Scrubber Discharge gas to the emergency scrubber when a high concentration of either gas is detected and simultaneously open the valve to distribute solution to the emergency column packing. The emergency scrubber is designed to treat a burst of gas at 17,100 Nm³/hr (10,000 scfm), 76,800 ppm_v H₂S, and 61,300 ppm_v HCN for 5 minutes. The scrubber will discharge 10 ppm_v HCN and 15 ppm_v H₂S. The quantity and concentrations of gas for the emergency release case are based on complete acidification of one precipitation tank as a batch process, with release of all reactive gases. The gas burst duration was based on review of plant operating data in a metal sulphide leach process with concentrated sulphuric acid that generated large pulses of hydrogen sulphide gas.

17.2.17.3 On-Line Analysis

In order to minimize operator exposure to process streams containing HCN and H₂S, an on-line analyser is provided.

On-line analysis of Cu, Zn, Cd, Ag, pH, redox and sulphuric acid will be determined from five streams, the pregnant solution, the acidified pregnant solution, and the discharge from each precipitation tank. The system includes stream sampling with a multiplexer, primary and secondary sample filtration, XRF analysis of Cu, Zn, Cd, and Ag, and analysis of pH, redox potential, and sulphuric acid with an automatic titrator.

Sump pumps in the sodium hydrosulphide area, and all acidic solution areas will be vented to the caustic scrubber system. The ventilated sumps will minimize accumulation of hydrogen sulphide gas in the sump areas. Hydrogen peroxide, 10 wt.%, solution will be provided to sump areas and sample points in a ring-main type system to destroy hydrogen cyanide and hydrogen sulphide during upset process conditions.

17.2.17.4 Solution Neutralization

Solution from the Copper-Silver Sulphide thickener will overflow by gravity to the Neutralization Tank. The acidified thickener overflow will be neutralized with slaked lime and recycled gypsum thickener underflow slurry. Slurry from the Neutralization Tank will discharge to the Gypsum Thickener. Gypsum Thickener overflow solution will gravity flow to the ADR plant. Gypsum Thickener underflow will be recycled and advanced to a storage pond the first year of operation and unused areas of the heap leach pad for the life of the mine.

17.2.17.5 Recycle Gypsum Mix Tank

Recycle Gypsum Thickener underflow solids will be conditioned with slaked lime in the recycle mix tank to simulate a high-density sludge (HDS) process and achieve higher underflow solids densities than typically generated by direct neutralization, which generates a low-density sludge. The recycle Gypsum Thickener underflow, 25 wt.% solids will be mixed with slaked lime, 20 wt.% solids in the Gypsum Thickener Recycle Mix Tank. The carbon steel/rubber lined tank will provide five (5) minutes retention time.

17.2.17.6 Neutralization Tank

The acidified pregnant solution from the copper thickener is combined with recycled conditioned gypsum solids and slaked lime in the Gypsum Neutralization Tank. The solution overflows the Neutralization Tank through an upcomer to the Gypsum Thickener. The Neutralization Tank is sized for a residence time of five (5) minutes.

17.2.17.7 Gypsum Thickener

Solution overflowing the Neutralization Tank will be combined with flocculent in the Gypsum Thickener. Gypsum Thickener overflow solution will gravity flow to the ADR plant. Gypsum Thickener underflow will be recycled to the Recycle Gypsum Mix Tank, and advanced to a Gypsum Filter Press and placed on unused areas of the heap leach pad thereafter.

17.2.18 Adsorption

The adsorption section of the ADR will consist of a single train of carbon columns consisting of five cascade type open-top up-flow carbon adsorption columns. Pregnant solution will be pumped to the carbon adsorption columns by submersible pumps in the pregnant solution pond. Antiscalant will be added at the pump suctions to prevent scaling of the carbon that can affect carbon loading. Barren solution exiting the last carbon column will flow through a screen to separate and capture any floating carbon from the solution.

Adsorption of gold from the pregnant solution will be a continuous process. Periodically, the carbon contained in the lead column in the series will become loaded with gold and transferred to the acid wash and desorption circuit as a batch using carbon transfer pumps. On average, approximately 1.1 tonnes of carbon per day are expected to be loaded and treated. However, higher grade sections of the resource will require larger quantities of carbon to be stripped more often.

Carbon in the remaining columns will then advance, one at a time, and a batch of new (or stripped/regenerated) carbon will be transferred into the final empty column from the unloaded carbon storage tank.

Generally, the stripping of carbon will occur about two (2) to four (4) times each week with each strip lasting approximately 18 hours.

17.2.19 Carbon Acid Wash

Acid washing will consist of circulating a dilute acid solution through the bed of carbon to dissolve and remove scale from the carbon. Acid washing will be performed on a batch basis.

After carbon is transferred into the acid wash column, but before any acid is introduced, fresh water will be circulated through the bed of carbon to remove any entrained caustic cyanide solution. This rinse solution will be pumped to a waste collection pipe with the acid wash circulation pump where it will be transferred to the barren tank. A dilute acid solution will then be prepared in the mix tank and circulated through the acid wash vessel and back to the acid mix tank. Concentrated acid will be injected into the recycle stream to maintain a pH below 2.0.

Completion of the cycle will be indicated when the pH stabilizes around 2.0 without acid addition for a minimum of one full hour of circulation.

After acid washing has been completed, the acid wash pump will transfer spent acid solution from the acid mix tank and wash vessel either to the acid recovery tank or directly to the waste collection pipe. The carbon will then be rinsed with raw water followed by rinsing with dilute caustic solution to neutralize any residual acid. Total time required for acid washing a 5-tonne batch of carbon will be four to six hours. After acid washing is complete, a carbon transfer pump will transfer the carbon to the desorption section.

17.2.20 Desorption

A Zadra pressure elution circuit has been selected for the Gabbs Project. This type of circuit will require 18 about hours to complete a cycle and, for this reason, each strip batch will be sized for five tonnes of carbon. Each desorption cycle will require the transfer of a 5-tonne batch from the acid wash circuit to the strip vessel.

The desorption circuit will be sized to elute, or “strip,” the gold from a five-tonne batch of carbon into pregnant strip solution. During the elution cycle, gold will be continuously recovered by electrowinning from the pregnant eluate concurrently with desorption. A complete desorption cycle will require approximately 18 hours.

After a batch of carbon has been transferred to the elution vessel, barren strip solution (eluant) containing sodium hydroxide and sodium cyanide will be pumped through the heat recovery and primary heat exchangers and introduced to the elution vessel at a temperature of 135°C and a nominal operating pressure of approximately 340 kPa (50 psig).

Under normal operating conditions, barren eluant solution from the solution storage tank will pass through the heat recovery exchanger to be preheated by hot pregnant eluant leaving the elution column. The barren eluant solution will then pass through the primary heat exchanger to raise the temperature up to 149 °C using pressurized hot water from the boiler system.

The elution column will contain internal stainless steel inlet screens to hold carbon in the column and to distribute incoming stripping solution evenly in the column. Pregnant eluant solution leaving the elution column will pass through external stainless-steel screens before passing the cooling heat exchanger to reduce the eluate temperature to about 75°C (to prevent boiling). The cooled pregnant eluate solution will be sent to the electrowinning cells.

After desorption is complete, half of the stripped carbon will be pumped to carbon reactivation dewatering screens to remove water and carbon fines and transferred to carbon regeneration.

The other half of the carbon will be screened to remove fines and transferred to the carbon storage tank.

17.2.21 Electrowinning and Refining

The electrowinning circuit will be operated in series with the elution circuit. Solution will be pumped continuously from the barren eluant tank through the elution vessel, then through the electrowinning cells, and back to the barren eluant tank in a continuous closed loop process.

The gold-laden solution exiting the elution column will be screened to trap any carbon escaping from the column and will pass through the heat recovery exchanger and the cooling exchanger to reduce the solution temperature to 75°C and then will flow to the electrowinning circuit.

Gold will be electrowon from the eluant in the electrowinning cells using stainless steel cathodes and a current density of approximately 50 amps per square metre of anode surface.

Caustic soda (sodium hydroxide) in the eluate solution will act as an electrolyte to encourage free flow of electrons and promote the precious metal electrowinning from solution. To keep the electrical resistance of the solution low during desorption and the electrowinning cycle, make-up caustic soda will sometimes be added to the barren eluant tank. Barren eluate solution leaving the electrolytic cells will discharge to the E-cell discharge pump box where it will be pumped back to the eluate storage tank for recycle through the elution column.

Periodically, all or part of the barren eluant will be bled to the barren tank and new solution will be added to the eluate storage tank. Typically, about one-third of the barren eluant will be discarded after each elution or strip cycle. Sodium hydroxide and sodium cyanide will be added as required from the reagent handling systems to the barren eluant tank during fresh solution make-up.

The precious metal-laden cathodes in the electrolytic cells will be removed about once or twice per week and processed to produce the final doré product. Loaded cathodes will be transferred to a cathode wash box where precipitated precious metals will be removed from the cathodes with a high-pressure washer. The resulting sludge will be pumped to a plate-and-frame filter press to remove water and the filter cake will be loaded into an electric dryer to remove moisture from the filter cake.

After drying, the gold sludge will be mixed with fluxes and smelted in an electric furnace to produce doré bullion.

Periodically, slag produced from the smelting operation will be re-smelted on a batch basis to recover residual metal values or will be crushed and manually added to the heap leach pad.

A hood will collect the furnace fumes which will pass through a bag house to remove particulates, then through an induced draft fan. The system will be designed to remove over 99.5% of the particulates present in the exhaust fumes.

17.2.22 Carbon Handling and Regeneration

Thermal regeneration will consist of drying the carbon thoroughly and heating it to approximately 750°C for ten minutes. It is expected that thermal reactivation will be performed after every elution cycle to maintain carbon activity levels.

The 5-tonne carbon batch to be thermally reactivated will be dewatered on a static screen, transferred to the regeneration kiln feed hopper and fed to the regeneration kiln by a screw feeder. Hot, regenerated carbon leaving the kiln will fall into a water-filled quench tank for cooling and storage. Carbon in the carbon quench tank will be pumped to a vibrating screen; screen oversize will be sent to the carbon storage tank and the screen undersize will be collected in the carbon fines tank, where periodically the carbon fines will be dewatered using a filter press and stored in bulk bags. Ultimately, quenched regenerated carbon will be pumped to the adsorption circuit dewatering screen to remove any fines and the coarse carbon will be added to the adsorption circuit.

New carbon will be first added to the carbon conditioning tank which is equipped with an agitator and will be used for attriting new carbon. After attriting, the new carbon will be transferred to the unloaded carbon tank from which it will be transferred to the adsorption circuit by a carbon transfer pump.

17.2.23 Reagents

17.2.23.1 Cyanide

Sodium Cyanide will be delivered as briquettes in 1,000 kg bulk bags stored in a covered storage area with approximately 30 days of storage. Sodium cyanide will be used to leach the gold, silver and copper from the material on the heap.

17.2.23.2 Cement

Cement will be delivered in bulk truckloads. Cement storage will be in two 150-tonne silos with an estimated cement consumption in the range of 66 to 110 tonnes per day depending on the clay content, with a LOM average of 68 tonnes per day. Cement from the silos will be metered directly onto the agglomeration feed conveyors through variable speed feeders based on weightometer measurements. The cement silos will be equipped with bin activators and dust collectors.

17.2.23.3 Slaked Lime

Pebble lime will be delivered and stored in a 150-tonne lime silo. The lime will be conveyed from the silo to a lime slaker system. Slaked lime will be stored in an agitated tank with 12 hours residence time at a solids density of 20 wt%. Slaked lime will be pumped to the Gypsum Thickener Mix tank.

17.2.23.4 Sodium Hydroxide (Caustic)

Sodium hydroxide will arrive as 50% solution in 10,000-litre containers. The caustic will be diluted to 20 wt% for storage. Storage will take place at the SART plant in a stainless tank. Caustic will be distributed from the SART plant to the ADR in a 55-gallon drum, or similar sized day tank.

17.2.23.5 Concentrated Sulphuric Acid

Concentrated sulphuric acid, 98 wt%, will arrive by truck in 20-tonne batches. The truck will be unloaded into a single carbon steel tank with storage capacity for 3 days.

17.2.23.6 Sodium Hydrosulphide (NaHS)

Sodium hydrosulphide will arrive in tanker truck at a 40 wt.% solution. The tanker truck will be unloaded into the Sodium Hydrosulphide Dilution Tank. The tanker contents will be sampled and diluted to 25 wt% with diluted storage for approximately 9 days.

17.2.23.7 Flocculant

Flocculant will arrive as a dry powder in 25 kg bags. Flocculant will be mixed in a flocculant mixing system and transferred to a storage tank as 0.5 wt% solution. The flocculant storage tank will provide 16 hours residence time.

17.2.23.8 Antiscalant

Antiscalant will be received in drums or plastic tote containers. Antiscalant will be added by metering pumps at the barren solution and pregnant solution pump suction inlets. Antiscalant will be used to prevent carbonate scaling in pumps, piping and on the carbon.

17.2.23.9 Hydrogen Peroxide

Hydrogen peroxide, 10 wt.%, will be delivered to the SART plant in 10,000-litre containers and transferred into a 304 SS storage tank and provide 5-days of storage. Hydrogen peroxide will be fed by pumps to sump areas and sample points in the SART plant area via a ring-main to destroy hydrogen cyanide and hydrogen sulphide as required.

18.0 PROJECT INFRASTRUCTURE

18.1 Roads

Access to the Project site is by the paved Highway 361, southwest from Gabbs to Pole Line Road, and then 3.5 km (2.2 miles) south to the centre of the Property. A private road will enter the mine property, it will include a guard house. This road will provide access to the administration offices, mine, process plant and other Project facilities.

18.1.1 Site Roads

Internal site roads are established to serve as mine haul roads, service roads and in-plant roads which connect the facilities for access purposes.

18.1.1.1 Haul Roads

The main production haul road will be finished during the construction phase to support pre-stripping and pre-production activities. There will be multiple branches off the main haul road from the open pits, including access to the mine truck shop, waste rock storage facilities and low-grade stockpiles.

18.1.1.2 Service Roads

The site service roads are connected to the site access road and are used to join the site facilities. The combined service roads join the following areas:

- Administrative area;
- Primary crushing;
- Secondary and tertiary crushing;
- Leach pad;
- Mill;
- SART plant;
- ADR plant.

18.2 Project Buildings

Site buildings for the Gabbs Project will primarily be prefabricated steel or concrete masonry unit buildings. Site buildings include:

- Administration Offices;
- Mill;
- ADR Facility;
- SART Facility;

- Refinery;
- Laboratory;
- Process Maintenance Workshop;
- Reagent Storage Building;
- Mine Truck Shop;
- Contractor Mine Office Building;
- Fuel Stations;
- Warehouse;
- Explosives Magazine; and
- Guard House.

18.3 Power Supply and Distribution

Power supply at 115 kV will be available by NV Energy. Site power will be distributed using overhead power lines, with the main substation be located near the largest power consumption area which will be the mill area. Power from the main substation will be stepped down connected to the site distribution power line. Two of the temporary generators and their associated fuel tanks will remain at the project to be utilized as emergency power backup for the process plants.

18.4 Estimated Power Consumption

Average power demand for the heap leach operation is approximately 13 MW and for the mill is 39 MW. Estimated average power consumptions for the heap leach and mill are 12 kWh/t and 24 kWh/t, respectively.

18.5 Water Supply and Distribution

The project will require water supply for the following uses:

- Mining operations for dust control, drilling, etc.;
- Crushing for dust control;
- Makeup water for the heap leach pad;
- Process plant and laboratory;
- Modular offices and other site facilities.

18.5.1 Process Water

The heap leach process water balance considers the water consumed by the Project and the water collected from precipitation events on the Project components in addition to seasonal evaporation.

Solution from the heap leach pad will drain to the Pregnant Pond, where it will be pumped through the processing facility to recover precious metals and then pumped back to the leach pad in a continuous cycle. The Event Pond will be located adjacent to the pregnant solution pond to allow containment of excess process solution during precipitation events which will add additional water to the closed system. Heap leach process water make-up requirements will be met by well water at an estimated rate of 123 m³/hr. Upon startup of the mill, total make up water requirements required for the process facilities has been estimated at 215 m³/hr.

18.5.2 Raw and Fire Water

The raw water tank located near the administration area will be dual-purpose tank, a portion of this tank will be designated for fire water use.

18.5.3 Potable Water

Potable water will be bottled and delivered to the project site.

18.6 Explosive Storage

Facilities for the proper storage and safekeeping of explosives are included. These facilities will be designed and located in compliance with Federal regulations.

18.7 Security

Access to the project will be limited by perimeter fencing around the entire site. A guard house at the primary entry point to the project will serve as a security check point that will be manned 24 hours per day, seven (7) days a week for identification control, random checks, drug and alcohol monitoring and vehicle check-in/out. A security contractor will be used for general site security and protection of mine assets.

18.8 Waste Disposal

18.8.1 Sewage

Wastewater and sewage will be handled by subsurface local septic tanks or third-party waste disposal contractors.

18.8.2 Solid Waste

Special wastes such as waste oil, glycol coolant, solvent fluids, used oil filters, used batteries, and contaminated fuel, will be handled, stored, transported, and disposed of in accordance with appropriate Hazardous Waste Regulations. A certified transport and disposal company will collect all waste to transport offsite for final disposal.

A fenced temporary storage facility for hazardous waste will be included. A roofed storage area will be designated for used batteries, used lubricants, coolant and other miscellaneous fluids, and used tires.

A site for temporary storage of recyclable materials will be established. Such items as scrap metal, tires, glass, recyclable plastics and drink containers will be separated, containerized as appropriate, and temporarily stored until sufficient volumes are available for shipment to a recycling point. Non-recyclable and non-hazardous waste will be managed with a dedicated local company and waste sent to the municipal landfill on a weekly basis.

A location on the mine site will be designated as an outdoor storage or 'boneyard' area for placement of items that are not yet ready for disposal, but which may still be of use for spare parts. These items are likely to include equipment parts, vehicles, and pieces of equipment, and metal components. As much of this material as possible will be utilized during the mine life. Materials remaining in the boneyard at the end of mine life will either be shipped off site for salvage value, recycled, or disposed of in the landfill if they meet the criteria for disposal at that location.

19.0 MARKET STUDIES AND CONTRACTS

No market studies for gold were completed and no gold contracts are in place in support of this Technical Report. Gold production can generally be sold to any of several financial institutions or refining houses and therefore no market studies are required.

As of the effective date (17 May 2024) of this Technical Report, the spot prices for gold, silver and copper were US\$2,414/oz, US\$31.48/oz, and US\$4.71/lb, respectively.

Potential buyers were contacted for other KCA studies for the potential purchase of SART precipitate. Based on potential buyers, the terms used for this study are as follows:

Metal Payments

- Copper – 96.5% of the concentrate content;
- Silver – 96.5% of the concentrate content;
- Gold – 99.9% of the concentrate content.

Deductions

- Treatment Charge – US\$213.85 per dry tonne of concentrate;
- Copper Refining Charge – US\$170 per tonne of the payable copper;
- Silver Refining Charge – US\$1.00 per troy ounce
- Gold Refining Charge – US\$1.40 per troy ounce of the payable gold.

20.0 ENVIRONMENTAL STUDIES, PERMITTING AND SOCIAL OR COMMUNITY IMPACT

The project includes proposed exploration and potential future mining on unpatented lode mining claims on public U.S. Bureau of Land Management (BLM) lands and on one internal patented mining claim (private land). The following describes the major permits and environmental studies that would be required prior to initiation of mining operations at the Gabbs Project.

20.1 Federal Authorizations and Permits

The BLM authorizes mining on public or mixed public/private land as required by the 43 Code of Federal Regulations (CFR) Subpart 3809. In accordance with 43 CFR Subpart 3809, future mining on the project unpatented claims would require P2 Gold to submit a Mine Plan of Operations (MPO) for review by the BLM, Stillwater Field Office of the Carson City District, and the Nevada Division of Environmental Protection – Bureau of Mining Regulation and Reclamation. The MPO would include the activities proposed on the unpatented and patented claim and will serve as an overall plan for the entire project. Following their review, the BLM will determine whether an Environmental Assessment (EA) or an Environmental Impact Statement (EIS) is required for compliance with the National Environmental Policy Act of 1969 (NEPA). The EA or EIS will be prepared in accordance with BLM guidelines, NEPA, and the Council on Environmental Quality (CEQ) regulations (40 CFR 1500-1508) for implementing NEPA. Since the EA or EIS will analyze the activities proposed in the MPO, the NEPA analysis would include the activities proposed on the unpatented claims and the activities occurring or proposed on the patented claim. Federal authorizations that will be required for development on public lands are listed on Table 20-1. A summary of required Federal authorizations follows:

- Bureau of Land Management Plan of Operations – required under 43 CFR 3809 regulations. A Finding of No Significant Impact, through review of an environmental assessment, or a Record of Decision, through review of an environmental impact statement, are required prior to initiation of mining operations.
- Bureau of Alcohol, Tobacco, Firearms and Explosives (ATF) – authorization to store and use explosives.
- Environmental Protection Agency (EPA) – registration as a small-quantity generator of wastes regulated as hazardous is required for all operations that generate regulated hazardous wastes such as lab wastes, etc.
- The anticipated timeline for completion of an EA is 12 to 24 months and an EIS may take 2 to 4-years after development of the MPO.

In addition to NEPA, the BLM must also ensure the Project is compliant with other federal statutes, including the Endangered Species Act (ESA), the National Historic Preservation Act (NHPA) and all applicable federal orders, directives, and regulations pertaining to the development of BLM lands. Compliance with the applicable federal statutes and regulations must be considered in the NEPA analysis. Wildlife and plant surveys are required in the unpatented portions of the Project area.

A Class III Cultural Resource Assessment will need to be conducted within the project area boundary and findings submitted to the Nevada State Historic Preservation Office (SHPO) for concurrence. Any resources determined to be significant by SHPO will need to be managed through avoidance or approved mitigation during development.

The culmination of the EA process, following other federal agency and public review and comment, may result in a Finding of No Significant Impact (FONSI) and subsequent approval of the Plan of Operations by the BLM. If the BLM determines that there would be a significant impact due to the proposed mining operation P2 Gold will be required to complete an EIS. The culmination of the EIS process would most likely result in a Record of Decision (ROD) and subsequent approval of the Plan of Operations by the BLM.

20.2 State of Nevada Required Permits and Statutes

The regulatory permitting requirements of the State are primarily administered by several bureaus of the Nevada Division of Environmental Protection (NDEP). The NDEP bureaus that will have regulatory oversight of the project include the Bureau of Mining Regulation and Reclamation (BMRR), and the Bureau of Air Pollution Control (BAPC). These bureaus work cooperatively to ensure mining activities in Nevada are compliant with the Clean Water Act (CWA), the Clean Air Act (CAA), and several other federal and state statutes. The potential permits and plans that each NDEP bureau will potentially require and the statute mandating each permit are listed below and shown on Table 20-1. The potential permits are based on the activities envisioned by P2 Gold at this time.

Bureau of Mining Regulation and Reclamation (BMRR)

- Water Pollution Control Permit – required by Sections 445A.300 through 445A.730 of the Nevada Revised Statutes (NRS) and Sections 445A.350 through 445A.447 of the Nevada Administrative Code (NAC).
- Reclamation Permit (disturbance more than 5 acres) – required by Sections 519A.010 through 519A.280 of the NRS and Sections 519A.010 through 519A.415 of the NAC.

Bureau of Air Pollution Control (BAPC)

- Facilities Operating Permit (Air Quality Permit) – required by the CAA (42 USC §7401 et seq.) and by Nevada air quality rules and regulations (Chapters 445B of the NRS and 445B of the NAC).
- Surface Area Disturbance Permit and Dust Control Plan – required by the CAA and by Nevada air quality rules and regulations.

Nevada Department of Wildlife (NDOW)

- Industrial Artificial Pond Permit – required under NRS 502.390 regulations.

Nevada Division of Water Resources

- Permit to Appropriate Water – required under NRS Chapter 533 and 534.

20.3 County Required Permits

Development of the project unpatented and patented claims must also comply with Nye County regulations which require a Special Use Permit (SUP) for mining activities at the Project. In accordance with the requirement, P2 Gold must apply for and obtain a SUP before mining could commence on the Project. Under normal conditions, issuance of a SUP may require up to 180 days from the date the application is filed.

**Table 20-1
Summary of Major Permits Required**

Agency	Permit Name	Permit Status
<i>Nevada Division of Environmental Protection</i>		
Bureau of Mining Regulation and Reclamation	Water Pollution Control Permit Reclamation Permit (Mining and Exploration)	Not submitted or received
Bureau of Air Pollution Control	Air Quality Operating Permit	Not submitted or received
<i>Nevada Division of Water Resources</i>		
State Engineer	Permit to Appropriate Water	Not submitted or received
<i>Nevada Department of Wildlife</i>		
Nevada Department of Wildlife	Industrial Artificial Pond Permit	Not submitted or received
<i>Federal Authorizations</i>		
Bureau of Land Management – Stillwater Field Office	Plan of Operations Decision Record/Finding of No Significant Impact	Not submitted or received
Bureau of Alcohol, Tobacco, Firearms, and Explosives	Federal Explosives License/Permit	Not submitted or received
Environmental Protection Agency	Hazardous Waste ID No. (large quantity generator)	Not submitted or received

20.4 Reclamation Bonding

In accordance with Federal and state law, P2 Gold must post reclamation surety before development of the project would be authorized. A reclamation cost estimate must be prepared and submitted to the NDEP and BLM in order to quantify the amount of the surety bond required. Once a cost is calculated and a reclamation surety is posted, the amount of the surety must be reviewed at least once every three years thereafter to determine if it is still adequate for reclamation costs with inflation considered. The NDEP and BLM accept several instruments for reclamation surety, including surety bonds, cash, certified checks or bank drafts, irrevocable letters of credit, and certificates of deposit.

A reclamation surety that is adequate for the reclamation of the entire project, which includes development of the patented and unpatented claims, must be posted before P2 Gold would be authorized to proceed with mining activities.

20.5 Environmental Permitting Status

The only permitting activities that have been undertaken to date are for exploration activities. There are two active Notices of Intent for Exploration Activities (Notice) on file with the BLM within the Gabbs Project area. The Notices are designated as the Sullivan Project and the Lucky Strike Project.

P2 Gold submitted the Sullivan Notice to conduct exploration drilling on unpatented lode mining claims to the BLM in June 2021. The Notice was approved in late June 2021 for a 2-year period of time, and covers planned disturbances associated with 50 drill hole sites, 1 bulk sample site and access routes to the exploration sites. The Sullivan Notice includes exploration sites at the Sullivan and Car Body areas covering an initial estimated disturbance of 3.65 acres. P2 Gold amended the Notice in October 2021 and a new bond in the amount of US\$22,693 was posted. P2 Gold again extended the Notice for a new two-year term in September 2023 and the reclamation bond amount was reduced to US\$17,800. The reduction of the bond amount was the result of a recalculation of the reclamation cost estimate. According to BLM records, disturbance created to date under the Sullivan Notice remains at approximately 1 acre, well below the 5-acre disturbance limit of the Notice of Intent level of activity. The expiration date for the Sullivan Notice is September 20, 2025.

An original Notice for the Lucky Strike area of the Project for the planned disturbance of 4.49 acres associated with 27 drill sites and drill site access was approved by the BLM in July, 2021. According to BLM records, a total of 2.1 acres had been disturbed, well below the 5-acre disturbance limit for Notice level exploration activities. The expiration date for the Lucky Strike Notice was July 13, 2023 and the obligated bond amount was US\$18,055. Following expiration of the original Notice for Lucky Strike, P2 Gold submitted a new Notice to the BLM. The planned disturbance of the Notice was identical to the original Notice of 4.49 acres, which includes the disturbance generated under the original Notice. The new Lucky Strike Notice was approved by the BLM in September 2023, and the reclamation bond amount was determined to be US\$19,514. The Notice expires in September 2025.

P2 Gold may submit a new Notice to the BLM that includes the existing disturbance for a new 2-year term at any time. The practice of amending and extending Notices to modify the proposed disturbance areas or extending the expiration dates is common on BLM administered land and should not pose a detriment to exploration plans so long as the disturbance areas do not exceed 5 acres. However, in the case of two Notices within the same Project area, the discrete Notices, according to BLM policy, must not be closer than 1 mile apart.

20.6 Biological Baseline Survey

In anticipation of a potential future submittal of an Exploration Plan of Operations for expanded exploration disturbance authorization from the BLM, in April, 2022 P2 Gold contracted with Western Biological (WB) to complete a biological baseline survey of the Gabbs Project area and surrounding areas. WB provided a scope of work which complied with the BLM protocols for plant and wildlife surveys. WB in consultation with the BLM and the U.S. Fish and Wildlife Service identified the following resources to be included in the baseline survey: soils, ecological sites, vegetation, general wildlife, migratory birds, raptors, and special status species plants and wildlife. The special status species evaluated in the survey included federally threatened or endangered species and proposed threatened or endangered species. An additional passive acoustic survey was conducted to evaluate the presence of bats that may occupy historical adits and mine shaft openings within the Project area. The field surveys were conducted in 2022 (Walch, 2023).

Ten wildlife species were observed, including 7 reptilian species and 3 mammalian species. Of the 10 wildlife species observed, 3 are categorized as special status species, including: Long-nosed Leopard Lizard, Great Basin Collared Lizard and Desert horned lizard. The mammalian species observed consisted of Black-tailed Jackrabbit, Coyote, and Pronghorn antelope. There were 4 species of migratory birds observed. No special status migratory bird species were observed during the ground surveys.

Aerial raptor surveys were conducted within a 2-mile radius buffer of the Project area in April and May, 2022 (Walch, 2022). One common raven, one red-tailed hawk and one prairie falcon active nests were confirmed within the 2-mile buffer. A 2-mile radius for raptor surveys is standard BLM protocol for exploration activities. However, for mining activities, the standard protocol is to conduct the survey over a 10-mile radius.

The results of the bat survey indicated that 20 bat species were identified from 3 survey sites within the Project area. Of the 20 bat species identified, 9 species are classified as a special status species. Mitigation measures for the potential impact to bat species typically includes locating and assessing potential mitigation bat roosts outside the Project area and constructing bat gates at the sites. At the sites of active bat occupation that would be impacted by renewed mining activities, installation of wire mesh over all openings and encouragement of abandonment of bat roosts with smoke bombs would occur, followed by final closure of the underground openings before the commencement of mining activities.

A query of the Nevada Division of Natural Heritage database conducted by WB revealed no records of endangered, threatened, or at-risk animal taxa within the Project area. Historic records of Eastwood milkweed and Tonopah milkvetch exist one and five miles outside of the

Project Area, respectively. Historic records of Pale kangaroo mouse exist >5 miles outside of the Project area. None of these species were observed during the baseline surveys.

20.7 Geochemical Characterization of Mineralized Material and Waste Rock

Geochemical characterization of mineralized material, waste rock, and beneficiation processed material to determine potential environmental mitigation measures and engineering design for placement of the mined material has not yet been initiated by P2 Gold. A rock characterization program will be needed to complete Federal and state mine permitting at the site.

20.8 Environmental Issues

At this early stage of environmental studies at the Project site, the QP is not aware of any environmental issues that would preclude development on a potential mine operation.

20.9 Waters of the United States Jurisdictional Determination

The U.S. Army Corp of Engineers (Corps) may require a jurisdictional determination of waters of the United States prior to development. An approved jurisdictional determination (AJD) is a document provided by the Corps stating the presence or absence of “waters of the United States” on a parcel or a written statement and map identifying the limits of “waters of the United States” on a parcel. Under existing Corps’ policy, AJDs are generally valid for five years unless new information warrants revision prior to the expiration date. Given that the Project is within a closed hydrographic basin, the presence of waters of the United States is not anticipated.

20.10 Water Supply Permits

According to Nevada Division of Water Resources records and communications with P2 Gold, the company does not currently have the right to appropriate water at the Project site. Water rights would need to be secured for any potential future mine development.

20.11 Community Impact

The Gabbs Project property is located within the Gabbs Valley, and is remote from local communities, ranches, or residences. The Gabbs Project area is located approximately 9 km (5.6 miles) south-southwest of the Town of Gabbs in Nye County. Gabbs is the local support center for the Premier Magnesium open pit mine and processing facility, which is located immediately outside of the town of Gabbs. The town of Gabbs relies on the economic benefits derived from employment at the Premier Magnesium operation and supports mining. The next nearest community offering housing, grocery, amenities and fuel services is Hawthorne, located in Mineral County approximately 90 km (40 miles) southwest of the Gabbs Project property. The citizens of both communities, and Nye and Mineral counties in general, have historically

been supportive of mineral exploration and mining projects. A labor workforce of experienced miners and exploration support staff is available regionally.

21.0 CAPITAL AND OPERATING COSTS

Capital and operating costs for the process and general and administration components of the Gabbs Project were estimated by KCA with input from P2. Costs for the mining components were provided by P&E. The estimated costs are considered to have an accuracy of +/-30% and are discussed in greater detail in this Section.

The total Life of Mine (LOM) capital cost for the Project is US\$864.7 million, including US\$14.2 million in working capital and initial fills but not including reclamation and closure costs which are estimated at US\$56.4 million. Table 21-1 presents the capital requirements for the Gabbs Project.

**Table 21-1
Capital Cost Summary**

Description	Cost (US\$)
Pre-Production Capital	\$365,536,000
Working Capital & Initial Fills	\$14,199,000
Sustaining Capital – Mine & Process	\$484,917,000
Total^a	\$864,652,000

a. Total does not include credits or reclamation costs

The average life of mine operating cost for the Project is US\$19.24 per tonne processed. Table 21-2 presents the LOM operating cost requirements for the Gabbs Project.

**Table 21-2
LOM Operating Cost Summary**

Description	LOM Cost (US\$/t)
Mine	\$6.73
Process & Support Services	\$11.78
Site G&A	\$0.73
Total	\$19.24

Numbers do not sum due to rounding

21.1 Capital Expenditures

The required capital cost estimates have been based on the design outlined in this report. The scope of these costs includes all expenditures for process facilities, infrastructure, construction indirect costs, contractor mobilization and owner mining capital costs for the Project.

The costs presented have primarily been estimated by KCA with input from P&E on owner mining mine infrastructure. Preliminary estimates for earthworks, concrete and major piping have been estimated by KCA. All equipment and material requirements are based on design information described in previous sections of this Report. Capital costs estimates have been made primarily using reasonable estimates or allowances made based on recent quotes in KCA/P&E's files.

All capital cost estimates are based on the purchase of equipment quoted new from the manufacturer or estimated to be fabricated new.

Pre-production and LOM capital costs required for the Gabbs Project are presented in Table 21-3 and Table 21-4.

Table 21-3
Summary of Pre-Production Capital Costs

Capital Item	Pre-production Cost (\$US)
Mining Direct Costs	\$28,570,000
Freight & Spares, EPCM	\$1,140,000
Infrastructure	\$6,810,000
Pre-stripping	\$25,740,000
Contingency	\$6,230,000
Mine Subtotal	\$68,500,000
Major Earthworks	\$25,780,000
Liner / Materials	\$9,850,000
Civils (Supply & Install)	\$16,110,000
Structural Steel (Supply & Install)	\$4,490,000
Platework (Supply)	\$4,484,000
Platework (Install)	\$1,350,000
Mechanical Equipment (Supply)	\$77,320,000
Mechanical Equipment (Install)	\$22,190,000
Piping (Supply & Install)	\$7,080,000
Electrical (Supply)	\$7,250,000
Electrical (Install)	\$10,660,000
Instrumentation (Supply & Install)	\$3,240,000
Infrastructure (Supply & Install)	\$5,020,000
Spare Parts	\$9,100,000
Process Contingency	\$45,170,000
EPCM	\$23,590,000
Commissioning & Supervision	\$130,000
Supplier Engineering	\$1,720,000
Indirect Costs (incl. contingency)	\$14,460,000
Owner's Costs (incl. contingency)	\$7,130,000
Process & Infrastructure Subtotal	\$297,040,000
Direct & Indirect Costs Total	\$365,540,000
Working Cap + Initial Fills	\$12,190,000
Total	\$377,730,000

Table 21-4
Summary of Sustaining Capital Costs

Capital Item	Sustaining Capital (\$US)
Mining Direct Costs	\$116,760,000
Freight & Spares	\$4,670,000
Infrastructure	\$7,410,000
Contingency	\$12,884,000
Mine Subtotal	\$141,720,000
Major Earthworks	\$24,370,000
Liner / Materials	\$26,220,000
Civils (Supply & Install)	\$5,740,000
Structural Steel (Supply & Install)	\$7,280,000
Platework (Supply)	\$0
Platework (Install)	\$0
Mechanical Equipment (Supply)	\$106,780,000
Mechanical Equipment (Install)	\$31,110,000
Piping (Supply & Install)	\$6,460,000
Electrical (Supply)	\$6,640,000
Electrical (Install)	\$10,460,000
Instrumentation (Supply & Install)	\$7,010,000
Infrastructure (Supply & Install)	\$5,770,000
Spare Parts	\$6,410,000
Process Contingency	\$61,050,000
EPCM	\$24,420,000
Commissioning & Supervision	\$0
Supplier Engineering	\$0
Indirect Costs (incl. contingency)	\$13,480,000
Owner's Costs (incl. contingency)	\$0
Process & Infrastructure Subtotal	\$343,200,000
Direct & Indirect Costs Total	\$484,920,000
Working Cap + Initial Fills	\$2,010,000
Total	\$486,930,000

21.1.1 Mining Capital Costs

Initial capital costs are all costs incurred in Year -2 and Year -1. As presented in Table 21-5, initial mining capital costs are estimated at US\$68.5 million including 10% contingency. Initial

capital costs consist of downpayments and lease payments for major mining equipment, purchases of support equipment, pre-production mining of the Sullivan open pit, preparation of the site and roads, and installation of site infrastructure.

No provision for future escalation has been included in the capital cost. Costs have been estimated using Q1 2024 US dollars.

**Table 21-5
Mining Capital Costs Summary**

Area	Initial Capital Costs (US\$M)	Sustaining Capital Costs (US\$M)	Total Capital Costs (US\$M)¹
Open Pit Mining Equipment	28.6	116.7	145.3
Open Pit Pre-Production	25.7		25.7
Site Infrastructure for Mining	5.0	3.4	8.4
Maintenance Shop and Fuel Station	1.5	4.0	5.5
Explosives Storage and Pit Dewatering	0.3		0.3
Freight, Spares, EPCM	1.2	4.7	5.8
Subtotal	62.3	128.8	191.1
Contingency @ 10%	6.2	12.9	19.1
Total	68.5	141.7	210.2

Note: ¹. Totals may not sum due to rounding.

21.1.1.1 Open Pit Mining Equipment

Major mining equipment such as excavators, haul trucks, rotary drills and wheel loaders are planned to be leased in five-year terms over the LOM. Lease terms assume a 10% downpayment and a 9% interest rate. Support equipment is planned to be purchased outright in Yr -2 so that it is ready to operate in Yr -1. Initial equipment required for pre-production mining is estimated to cost US\$28.6 million.

21.1.1.2 Open Pit Pre-production

16.0 Mt of waste rock have been planned to be mined from the Sullivan and Car Body open pits during the pre-production period, at a unit cost of US\$1.61/t mined, for an estimated capitalized cost of US\$25.7 million.

21.1.1.3 Site Infrastructure for Mining

Site infrastructure includes initial roads between the open pits and the primary crusher and the waste rock storage facilities, clearing and grubbing of the initial open pits and waste rock storage areas, and constructing drainage ditches and settling ponds. It also includes purchasing a mine dispatch system, survey equipment, computers, office equipment and radio communications for the mining technical team and is estimated to total US\$5.0 million.

21.1.1.4 Other Mining Capital Costs

Other capital costs include a mobile equipment maintenance shop, fuelling station, explosives storage and open pit dewatering system. Additional capital is required for items such as freight, spare parts, a minor amount of EPCM, and owner's costs. These items are estimated at US\$1.5 million.

21.1.1.5 Sustaining Mining Capital Costs

Sustaining capital costs are estimated to total US\$141.7 million over the LOM (Table 21 4) and include a 10% contingency. Most of the cost is for ongoing equipment lease payments over the LOM, with minor support equipment replacement, and site infrastructure costs for the two open pits that were not developed during the pre-production period.

21.1.2 Process and Infrastructure Capital Cost Estimate

21.1.2.1 Process and Infrastructure Capital Cost Basis

Process and infrastructure costs have been estimated by KCA. All equipment and material requirements are based on the design information described in previous sections of this Report. Capital costs have been estimated based on reasonable estimates or allowances made from recent quotes in KCA's files. All capital cost estimates are based on the purchase of equipment quoted new from the manufacturer or to be fabricated new.

Each area in the process cost build-up has been separated into the following disciplines, as applicable:

- Major earthworks & liner;
- Civil (concrete);
- Structural steel;
- Platework;
- Mechanical equipment;
- Piping;
- Electrical;

- Instrumentation;
- Infrastructure & Buildings;
- Supplier Engineering; and
- Commissioning & Supervision.

Pre-production process and infrastructure costs by discipline are presented in Table 21-6.

**Table 21-6
Summary of Heap Leach Process & Infrastructure Pre-Production Capital Costs by
Discipline**

Discipline Totals	Cost @ Source	Freight	Nevada Sales Taxes	Total Supply Cost	Install	Grand Total
	US\$	US\$	US\$	US\$	US\$	US\$
Major Earthworks				\$3,910,000	\$15,745,000	\$19,655,000
Civils (Supply & Install)	\$16,107,000			\$16,107,000	\$0	\$16,107,000
Structural Steelwork (Supply & Install)	\$4,494,000			\$4,494,000	\$0	\$4,494,000
Platework (Supply & Install)	\$4,484,000			\$4,484,000	\$1,353,000	\$5,837,000
Mechanical Equipment	\$69,172,000	\$4,156,000	\$3,995,000	\$77,323,000	\$22,189,000	\$99,512,000
Piping	\$4,899,000	\$104,000	\$98,000	\$5,101,000	\$1,973,000	\$7,075,000
Electrical	\$6,754,000	\$256,000	\$243,000	\$7,253,000	\$10,662,000	\$17,915,000
Instrumentation	\$1,934,000	\$155,000	\$147,000	\$2,235,000	\$1,009,000	\$3,244,000
Infrastructure & Buildings	\$2,954,000	\$205,000	\$194,000	\$3,353,000	\$1,671,000	\$5,024,000
Supplier Engineering					\$1,722,000	\$1,722,000
Commissioning & Supervision					\$127,000	\$127,000
Spare Parts				\$9,998,000		\$9,998,000
Contingency				\$45,172,000		\$45,172,000
Total Direct Costs	\$110,798,000	\$4,875,000	\$4,678,000	\$179,431,000	\$56,452,000	\$235,883,000

**Table 21-7
Summary of Mill Capital Costs by Discipline**

Discipline Totals	Cost @ Source	Freight	Nevada Sales Taxes	Total Supply Cost	Install	Grand Total
	US\$	US\$	US\$	US\$	US\$	US\$
Major Earthworks				\$5,282,000	\$9,414,000	\$14,696,000
Civils (Supply & Install)	\$0			\$5,740,000	\$0	\$5,740,000
Structural Steelwork (Supply & Install)	\$0			\$7,283,000	\$0	\$7,283,000
Platework (Supply & Install)	\$0			\$0	\$0	\$0
Mechanical Equipment	\$92,374,000	\$7,390,000	\$7,020,000	\$106,784,000	\$31,114,000	\$137,898,000
Piping	\$4,907,000	\$0	\$0	\$4,907,000	\$1,555,000	\$6,462,000
Electrical	\$6,628,000	\$5,000	\$4,000	\$6,637,000	\$10,457,000	\$17,094,000
Instrumentation	\$4,619,000	\$369,000	\$351,000	\$5,339,000	\$1,670,000	\$7,009,000
Infrastructure & Buildings	\$3,972,000	\$318,000	\$302,000	\$4,592,000	\$1,176,000	\$5,768,000
Supplier Engineering					\$0	\$0
Commissioning & Supervision					\$0	\$0
Spare Parts				\$6,407,000		\$6,407,000
Contingency				\$38,237,000		\$52,082,000
Total Direct Costs	\$112,499,000	\$8,082,000	\$7,678,000	\$191,209,000	\$69,230,000	\$260,439,000

Freight, Nevada sales taxes and installation costs are also considered for each discipline. Freight costs are based on loads as bulk freight and have been estimated at 8% of the equipment cost.

Installation costs are based on the contractor quotes from recent projects, equipment costs or included in comparable turn-key supplier packages. Contractor costs include all labour, tools and support equipment required for proper placement and installation of equipment. Where not directly quoted, installation is based on an hourly installation rate of US\$128.07.

Engineering, procurement, and construction management (EPCM), indirect costs, and initial fills inventory are also considered as part of the capital cost estimate.

21.1.2.2 Major Earthworks and Liner

Earthworks and liner quantities for the Project have been estimated by KCA for all Project areas. Earthworks and liner supply and installation will be performed by contractors with imported fill being supplied by the mining contractor. Unit rates for site earthworks and liner supply and installation are based on recent KCA projects. The earthworks and liner discipline also includes cost for materials to construct the crushing retaining wall.

21.1.2.3 Civils

Concrete quantities have been estimated by KCA based on layouts, similar equipment installations, vibrating equipment, major equipment weights and on slab areas. Unit costs for concrete supply, which include production (supply of aggregates, water and cement, batching and mixing), delivery and installation of concrete which include all excavations, formwork, rebar, placement and curing are based on recent KCA projects.

21.1.2.4 Structural Steel

Costs for structural steel, including steel grating, structural steel, and handrails were based on data from similar projects.

21.1.2.5 Platework

The platework discipline includes costs for the supply and installation of steel tanks, bins, and chutes. Platework costs are included in the mechanical equipment supply costs and under Platework.

21.1.2.6 Mechanical Equipment

Costs for mechanical equipment are based on an equipment list of all major equipment for the process. Costs for all major equipment items are based on budgetary quotes from suppliers for recent KCA projects. Where similar project equipment quotes were not available, reasonable allowances were made based on recent quotes from KCA's files. All costs assume equipment purchased new from the manufacturer or to be fabricated new.

The mechanical equipment costs consider a complete turn-key Adsorption Circuit, SART, Refinery and Cyanide Dissolution System, complete engineering design and supply package for the crushing and reclaim systems and various equipment supply packages by several different suppliers. Installation costs for mechanical equipment are based on contractor quotes or are included as part of turn-key vendor packages.

21.1.2.7 Piping

Major piping, including heap irrigation, the solution collection pipes and water distribution pipes (raw water and fire water) are based on a material take-off and supplier quotes. Major piping for the mill is based on factors of the major mill equipment cost. Piping for the ADR and cyanide dissolution systems are included in the turn-key vendor supply package. Additional ancillary piping, fittings, and valve costs have been estimated on a percentage basis of the mechanical equipment supply costs by area ranging from 0 to 5%.

Installation costs for major piping is based on recent KCA project quotes or factored based on data in KCA's files. Installation of ancillary piping has been estimated based on unit installation rates from the installation contractor and estimated installation hours based on the material supply costs.

21.1.2.8 Electrical

Miscellaneous electrical costs have been estimated as percentages of the mechanical equipment supply cost for each process area and range between 0 and 25%.

Installation of electrical equipment and ancillary electrical items not included in turn-key vendor packages have been estimated based on unit installation rates from the installation contractor quote and estimated installation hours based on the material supply costs. Supply and installation of the distribution powerline is based on a similar KCA projects.

21.1.2.9 Instrumentation

Instrumentation costs have been estimated as percentages of the mechanical equipment supply cost for each process area and range between 0 and 3%.

21.1.2.10 Infrastructure & Buildings

Infrastructure and buildings for the Gabbs Project include the construction of an administration office building, process office building, change facilities, warehouse, guard house, on-site clinic, and light vehicle workshop. Process buildings including the laboratory, process workshop, reagents storage building, Adsorption Plant and Refinery are also included.

Water supply to the main water tank will be by production wells. Three production wells are to be developed.

21.1.2.11 Supplier Engineering and Installation Supervision / Commissioning

Supplier engineering costs have been quoted for the crushing system as well as the recovery plant and include the costs for detailed engineering for the complete or turn-key supply packages. Costs for installation and commissioning supervision has been estimated as a cost per time period and are considered for all major equipment items.

21.1.2.12 Process Mobile Equipment

Mobile equipment included in the capital cost estimate are detailed in Table 21-8.

**Table 21-8
Process Mobile Equipment**

Description	Quantity
Forklift	2
Boom Truck	1
Mechanics Service Truck	1
Backhoe/Loader	2
Pick Up Truck	6
Front End Loader (Process)	1
Dozer (Heap)	1
Rough Terrain Crane	1
Water Truck	1
Skid Steer	2
Light Plant	4
Light Vehicles	7
Ambulance	1

Costs for process mobile equipment are based on cost guides or other published data. Mobile equipment costs are considered in the mechanical equipment cost estimate.

21.1.2.13 Spare Parts

Spare parts costs are estimated at 6% of the mechanical equipment supply costs, with an additional estimate for spare HPGR rolls.

21.1.2.14 Process & Infrastructure Contingency

Contingency for the process and infrastructure has been applied to the total direct costs by discipline at rates ranging from 20 to 25%.

21.1.2.15 Process & Infrastructure Sustaining Capital

Sustaining capital for process and infrastructure includes the expansion of the heap leach pad and the construction of the mill starting in year four (4).

21.1.3 Construction Indirect Costs

Indirect field costs include temporary construction facilities, construction services, quality control, survey support, warehouse and fenced yards, support equipment, etc. These costs have been estimated based on 16 months of field construction and reasonable allowances based on KCA's recent experience.

21.1.4 Other Owner's Construction Costs

Other Owner's construction costs are intended to cover the following items:

- Owner's costs for labour, offices, home office support, vehicles, travel and consultants during construction;
- Subscriptions, licence fees, etc;
- Environmental and other auditing;
- Work place health and safety costs during construction.

Other Owner's construction costs are estimated based on 16 months of site construction.

21.1.5 Initial Fills Inventory

The initial fills consist of consumable items stored on site at the outset of operations, which includes sodium cyanide (NaCN), cement, caustic, hydrochloric acid (HCl), flocculant, sulphuric acid (H₂SO₄), sodium hydrosulphide (NaSH), carbon, grinding media, flotation reagents, metabisulphite and antiscalant.

21.1.6 Engineering, Procurement & Construction Management

The estimated costs for engineering, procurement and construction management (EPCM) for the development, construction, and commissioning are based on a percentage of the direct capital cost. The total EPCM cost is based on 10% of the heap leach process and infrastructure direct costs and 8% for the mill direct costs.

The EPCM costs cover services and expenses for the following areas:

- Project Management
- Detailed Engineering
- Engineering Support
- Procurement
- Construction Management
- Commissioning
- Vendors Reps

21.1.7 Working Capital

Working capital is money that is used to cover operating costs from start-up until a positive cash flow is achieved. Once a positive cash flow is attained, Project expenses will be paid from earnings. Working capital for the heap leach is based on 60 days of operation and includes all mine, process and G&A operating costs. A working capital allowance of two weeks of operation was also included for the mill.

21.1.8 Exclusions

The following capital cost considerations have been excluded from the scope of supply and estimate:

- Finance charges and interest during construction
- Escalation costs

21.2 Operating Costs

Process operating costs for the Gabbs Project have been estimated based on information presented in earlier sections of this Report. Mining costs were provided by P&E at US\$1.55 per tonne mined including stockpile rehandle (LOM US\$6.73 per tonne processed) and are based on first principal cost calculations.

Process operating costs have been estimated by KCA from first principles. Labour costs were estimated using project specific staffing, salary and wage and benefit requirements. Unit consumptions of materials, supplies, power, water and delivered supply costs were also estimated. LOM average processing costs are estimated at US\$11.78 per tonne processed.

General administrative costs (G&A) have been estimated by KCA with input from P2. G&A costs include project specific labour and salary requirements and operating expenses including social contributions and land and water rights. G&A costs are estimated at US\$0.73 per tonne processed.

Operating costs were estimated based on 1st/2nd Quarter 2024 US dollars and are presented with no added contingency based upon the design and operating criteria present in this report.

The operating costs presented are based upon the ownership of all process production equipment and site facilities, including the onsite laboratory. The owner will employ and direct all operating maintenance and support personnel for all site activities.

Operating costs estimates have been based upon information obtained from the following sources:

- Mining costs from P&E;
- G&A costs estimated by KCA with input from P2;
- Project metallurgical test work and process engineering;
- Supplier quotes for reagents and fuel;
- Recent KCA project file data; and

- Experience of KCA staff with other similar operations.

Where specific data do not exist, cost allowances have been based upon consumption and operating requirements from other similar properties for which reliable data exist.

21.2.1 Open Pit Mine Operating Costs

A breakdown of the open pit mining costs by activity is shown in Table 21 9. It is planned that Company personnel will operate, maintain and supervise all mining equipment. Total mining OPEX during the production period is estimated at US\$843.2 million or US\$1.55/t moved.

**Table 21-9
Open Pit Mining Operating Costs**

Area	Total Operating Cost (\$M)	LOM Cost per Tonne Moved (\$/t)
Drilling	65.7	0.12
Blasting	133.6	0.25
Loading	166.7	0.31
Hauling	351.0	0.64
Services, Roads, Dumps	87.8	0.16
Supervision and Technical	38.4	0.07
Total¹	843.2	1.55

Note: ¹. Totals may not sum due to rounding.

21.2.2 Process and G&A Operating Costs

Average annual process and G&A operating costs are presented in Table 21-10. These costs are for the entire life of the project.

Table 21-10
Average Process, Support & G&A Operating Cost

Area	US\$ per Tonne
Labor	\$1.52
Primary Crushing	\$0.20
Secondary Crushing	\$0.31
Tertiary Crushing (HPGR)	\$0.65
Agglomeration	\$0.73
Conveyor Stacking	\$0.10
Heap Leach Systems	\$0.23
SART	\$2.45
Recovery	\$0.07
Milling	\$1.25
Flotation	\$0.21
CIP	\$0.04
Mill CCD	\$0.40
Cyanide Destruction	\$0.56
Tailings Filtration	\$0.33
Refinery	\$0.03
Reagents	\$2.38
Water Supply & Distribution	\$0.09
Laboratory	\$0.11
Support Services / Facilities	\$0.13
TOTAL COST (excluding G&A)	\$11.78
G&A	\$0.73
TOTAL COST	\$12.51

*Note: Average G&A does not include the reclamation and closure period.

21.2.2.1 Personnel and Staffing

Staffing requirements for process and administration personnel have been estimated by KCA based on experience with similar sized operations with input from P2 on wages and salary information. Total process personnel are estimated at 98 persons including 13 laboratory workers. G&A labour is estimated at 20 additional personnel.

Personnel requirements and costs for Process and G&A are summarized in Table 21-11..

**Table 21-11
Heap Leach Process and G&A Personnel**

Description	Number of Workers	Cost US\$/yr
Process Supervision	7	\$ 1,312,776
Crushing	12	\$ 1,248,684
Heap Leach	18	\$ 1,873,025
SART & Recovery Plant	26	\$ 2,687,140
Mill	38	\$ 3,908,313
Maintenance	22	\$ 2,782,940
Subtotal Process	85	\$ 9,904,566
Laboratory	13	\$ 1,421,170
Subtotal Process	98	\$ 11,325,736
G&A	20	\$ 2,563,463
TOTAL	152	\$ 13,889,199

21.2.2.2 Power

Power usage for the process and process-related infrastructure was derived from estimated connected loads assigned to powered equipment from the mechanical equipment list. Equipment power demands under normal operation were assigned and coupled with estimated operating times to determine the average energy usage and cost. Power requirements for the Project are presented in Section 18 of this report excluding any pit dewatering power requirements.

Power will be supplied by improving an existing powerline that runs along the highway adjacent to the Project site. The power supply cost is estimated at US\$0.12/kWh.

21.2.2.3 Consumable Items

Operating supplies have been estimated based upon unit costs and consumption rates predicted by metallurgical tests and have been broken down by area. Freight costs are included in all operating supply and reagent estimates. Reagent consumptions have been derived from test work and from design criteria considerations. Other consumable items have been estimated by KCA based on KCA's experience with other similar operations.

Operating costs for consumable items have been distributed based on tonnage and gold/silver/copper production or smelting batches, as appropriate.

21.2.2.4 Heap Leach Consumables

Heap leach consumables for years one through five are summarized in Table 21-12 below.

**Table 21-12
Heap Leach Consumables**

	Unit Costs	Costs/Year	Cost per Tonne
Piping, Fittings and Emitters		\$169,965	\$0.030
Sodium Cyanide	\$2.471	\$13,996,735	\$2.471
Cement	\$0.174	\$5,914,630	\$1.044
Antiscalant	\$3.760	\$554,572	\$0.105

The heap pipe costs include expenses for broken pipe, fittings and valves, and abandoned tubing. The heap pipe costs are based on previous detailed studies conducted by KCA on similar projects. Other prices are based on quotes.

21.2.2.5 SART Consumables

Heap leach SART consumables through LOM are summarized in Table 21-13 below.

**Table 21-13
SART Consumables (Heap Leach)**

	Unit Costs	Costs/Year	Cost per Tonne
Sulphuric Acid	\$0.312	\$4,813,902	\$0.85
Sodium Hydrosulphide	\$1.600	\$5,583,914	\$0.986
Flocculant	\$4.300	\$5,846,794	\$1.032
Lime	\$0.256	\$2,469,983	\$0.436
Caustic	\$0.614	\$90,396	\$0.016

Mill SART consumables for years LOM are summarized in Table 21-13 below.

Table 21-14
SART Consumables (Mill)

	Unit Costs	Costs/Year	Cost per Tonne
Sulphuric Acid	\$0.312	\$778,064	\$0.169
Sodium Hydrosulphide	\$1.600	\$902,519	\$0.196
Flocculant	\$4.300	\$945,008	\$0.205
Lime	\$0.256	\$399,220	\$0.087
Caustic	\$0.614	\$14,611	\$0.003

Sulphuric acid, sodium hydrosulphide, flocculant, lime and caustic prices have been estimated based on quotes for other projects.

21.2.2.6 Recovery Plant Consumables

Heap leach Recovery Plant consumables through LOM are summarized in Table 21-13 below.

Table 21-15
Recovery Plant Consumables (Heap Leach)

	Unit Costs	Costs/Year	Cost per Tonne
Carbon	\$2.20	\$45,932	\$0.008
Hydrochloric Acid	\$4.24	\$707,209	\$0.118
Smelting Fluxes	\$1.73	\$3,460	\$0.001

Mill Recovery Plant consumables for LOM are summarized in Table 21-13 below.

Table 21-16
Recovery Plant Consumables (Mill)

	Unit Costs	Costs/Year	Cost per Tonne
Carbon	\$2.20	\$37,316	\$0.008
Hydrochloric Acid	\$4.24	\$517,776	\$0.091
Smelting Fluxes	\$1.73	\$2,811	\$0.001

Carbon, Hydrochloric Acid and smelting flux prices have been estimated based on quotes for other projects.

21.2.2.7 Laboratory

Fire assaying and solution assaying of samples will be conducted in the on-site laboratory. It is estimated that approximately 150 solids assays and 150 solutions assays at US\$7 and US\$3 per assay, respectively, will need to be performed each day.

21.2.2.8 Fuel

Diesel fuel will be required for heavy equipment operation, personnel vehicles and in the recovery plant. Diesel is estimated at US\$0.86/L.

21.2.2.9 Miscellaneous Operating & Maintenance Supplies

Overhaul and maintenance of equipment along with miscellaneous operating supplies for each area have been estimated as allowances based on tonne processed. The allowances for each area were developed based on published data as well as KCA's experience with similar operations.

21.2.2.10 Mobile / Support Equipment

Mobile and support equipment are required for the process. The costs to operate and maintain each piece of equipment have been estimated primarily using published information and project specific fuel costs. Where published information was not available, allowances were made based on KCA's experience from similar operations.

21.2.2.11 G&A Expenses

General and administrative expenses are expected to average US\$3.5 million per year and include costs for offices, insurance, office supplies, communications, environmental and social management, health and safety supplies, security, travel and other miscellaneous operations. For the cost estimate G&A expenses are represented primarily as fixed costs or have been structured based on P2 input. G&A expenses are presented in Table 21-17.

**Table 21-17
Fixed G&A Expenses**

Description	Basis	Total Annual Cost, US\$
Maintenance Supplies	2.5% of G&A Staff / Labor	\$ 64,087
Office Supplies/Software	5% of G&A Staff / Labor	\$ 128,173
Transportation (Sr Management)	Allowance	\$ 200,000
Light Vehicle Operating Costs	Replace 1 Truck/Year	\$ 64,800
Local Office Rental	Allowance	\$ 24,000
Communications & Public Relations	5% of G&A Staff / Labor	\$ 128,173
Insurance (COC, Liability, Shipping, Ops)	Allowance	\$ 900,000
BLM Fees and County property taxes	Allowance	\$ 200,000
Licenses and permit fees	Allowance	\$ 100,000
Safety Supplies	Allowance	\$ 60,000
Environmental (Testing, etc)	Allowance	\$ 400,000
Training Supplies	Allowance	\$ 75,000
Outside Audit (Accounting, Metallurgy, etc)	Allowance	\$ 300,000
Travel (Operating team)	Allowance	\$ 100,000
Legal	Allowance	\$ 200,000
Data Processing / Payroll	Allowance	\$ 50,000
Access Road Maintenance	Allowance	\$ 75,000
Cleaning	Allowance	\$ 20,000
Miscellaneous	15% of G&A	\$ 463,385
TOTAL		\$3,553,000

21.3 Reclamation & Closure Costs

A cost estimate for reclamation and closure was made by KCA. Costs for reclamation and closure are based on a 3-year closure period (plus on-going monitoring) and are estimated at US\$56.4 million (US\$0.45 per processed tonne).

The main objectives of the reclamation and closure plan include:

- Progressive rehabilitation to allow rapid recovery of the vegetation cover and early recovery of the ecosystem;
- Sustainability of rehabilitation work including water and wind erosion;
- Recovery of land uses; and
- Implementation of a post-closure monitoring program.

22.0 ECONOMIC ANALYSIS

22.1 Summary

Based on the estimated production schedule, capital costs, operating costs, royalties and taxes, a cash flow model was prepared by KCA for the economic analysis of the Project. All of the information used in this economic evaluation has been taken from work completed by KCA and other consultants working on this Project as described in previous sections of this Report.

The Project economics were evaluated using a discounted cash flow (DCF) method, which estimates the Net Present Value (NPV) of future cash flow streams. The results of the economic analyses represent forward-looking information as defined under Canadian securities law. The results depend on inputs that are subject to a number of known and unknown risks, uncertainties and other factors that may cause actual results to differ materially from those presented here.

The final economic model was developed by KCA based on the following assumptions:

- The cash flow model is based on the mine production schedule from P&E.
- Period of analysis of 17 years including 2 years of investment and pre-production, 13.4 years of production and 1.6 years for reclamation and closure.
- Gold price of US\$1,950/oz, at P2's request.
- Copper price of US\$4.50/lb, at P2's request.
- Processing rate of 24,658 tpd.
- Heap Oxide recoveries of 78.3% for gold, 45.0% for silver and 54.0% for copper.
- Mill Sulphide recoveries of 94.5% for gold, 50.0% for silver and 79.9% for copper.
- Capital and operating costs as developed in Section 21.0 of this Report.

The key economic parameters are presented in Table 22-1 and the economic summary is presented in Table 22-2.

**Table 22-1
Key Economic Parameters**

Item	Value	Unit
Au Price	1950	US\$/oz
Cu Price	4.50	US\$/lb
Ag Price	25	US\$/oz
Au Avg. Recovery	84	%
Cu Avg. Recovery	64	%
Ag Avg. Recovery	47	%
Treatment Rate	24,658	t/d
Refining & Transportation Cost, Au	1.40	US\$/oz
Refining & Transportation Cost, Ag - Concentrate	1.00	US\$/oz
Refining & Transportation Cost, Cu - Concentrate	170.00	US\$/t
Concentrate Treatment Cost	213.85	US\$/wet t
Payable Factor, Au	99.9	%
Payable Factor, Cu - Concentrate	96.5	%
Payable Factor, Ag - Concentrate	90	%
Total Produced Au	1,472	koz
Income & Corporate Tax Rate	21	%
Nevada Au & Ag Mine Royalty (Excise Tax)	1.10	%
Net Proceeds of Mineral Tax	3.66	%

**Table 22-2
Economic Analysis Summary**

Production Data		
Life of Mine	14.1	Years
Mine Throughput per year	9,000,000	Tonnes/year
Operating Days per year	365	Days/Year
Mine Throughput per day (After First Year)	24,658	Tonnes/day
Grade Au (Avg.)	0.43	g/t
Grade Ag (Avg.)	1.09	g/t
Grade Cu (Avg.)	0.24	%
Contained Au, oz	1,749,000	Ounces
Contained Ag, oz	4,398,000	Ounces
Contained Cu, tonnes	295,200	Tonnes
Average Annual Gold Production	104,000	Ounces
Average Annual Silver Production	146,000	Ounces
Average Annual Copper Production	13,000	Tonnes
Total Gold Produced	1,472,000	Ounces
Total Silver Produced	2,058,000	Ounces
Total Copper Produced	146,000	Tonnes
LOM Strip Ratio (W:O)	3.19	
Operating Costs (Average LOM)		
Mining (moved)	\$1.55	/Tonne mined
Mining (processed)	\$6.73	/Tonne processed
Processing & Support	\$11.78	/Tonne processed
G&A	\$0.73	/Tonne processed
Total Operating Cost	\$19.24	/Tonne processed
Total By-Product Cash Cost	\$493	/Ounce Au
All-in Sustaining Cost	\$1,234	/Ounce Au
Capital Costs		
Initial Capital	\$365.5	Million
LOM Sustaining Capital	\$484.9	Million
Total LOM Capital	\$850.5	Million
Working Capital & Initial Fills	\$14.2	Million
Closure Costs	\$56.4	Million
Financial Analysis		
Average Annual Cashflow (Pre-Tax)	\$326.9	Million
Average Annual Cashflow (After-Tax)	\$262.6	Million
Internal Rate of Return (IRR), Pre-Tax	23.1%	
Internal Rate of Return (IRR), After-Tax	21.0%	
NPV @ 5% (Pre-Tax)	\$653.2	Million
NPV @ 5% (After-Tax)	\$550.0	Million
Pay-Back Period (Heap Leach, Years based on After-Tax)	3.0	Years

22.2 Methodology

The Gabbs Project economics are evaluated using a discounted cash flow (DCF) method. The DCF method requires that annual cash inflows and outflows are projected, from which the resulting net annual cash flows are discounted back to the Project evaluation date. Considerations for this analysis include the following:

- The cash flow model has been developed by KCA with input from P2.
- The cash flow model is based on the mine production schedule from P&E.
- Gold production and revenue in the model are delayed from the time heap material is stacked based on the mine production schedule and leach curves to account for time required for metal values to be recovered from the heap. No recovery delay is considered for milled material.
- Period of analysis of 17 years including 2 years of investment and pre-production, 14.1 years of production and 1.6 years for reclamation and closure.
- All cash flow amounts are in US dollars (US\$). All costs are based on 2nd Quarter 2024 prices.
- The Internal Rate of Return (IRR) is calculated as the discount rate that yields a zero Net Present Value (NPV).
- The NPV is calculated by discounting the annual cash back to Year -2 at different discount rates. All annual cash flows are assumed to occur at the end of each respective year.
- The payback period is the amount of time, in years, required to recover the initial construction capital cost for the initial heap leach project.
- Working capital and initial fills are considered in this model and includes mining, processing and general administrative operating costs. The model assumes working capital and initial fills for the initial heap leach project are recovered during the final year of heap operation and milling initial fills and working capital are recovered during the final year of milling.
- Government royalties and government taxes are included in the model.
- The model is built on an unlevered basis.
- Salvage value for process equipment is considered and is applied at the end of the Project.
- Reclamation and closure costs are included.

The economic analysis is performed on a before and after-tax basis in constant dollar terms, with the cash flows estimated on a project basis.

22.2.1 General Assumptions

General assumptions for the model, including cost inputs, parameters, government royalties and taxes are as follows:

- Gold price of US\$1,950/oz is used as the base case commodity price, as requested by P2.
- Silver price of US\$25/oz is used as the base case commodity price, as requested by P2.
- Copper price of US\$4.50/lb as the base commodity price, as requested by P2.
- LOM average operating costs of US\$19.24/t including a mining cost of US\$6.73/t (US\$1.62/tonne mined), processing cost of US\$11.78/t and G&A cost of US\$0.73/t processed.
- Pre-production capital costs for the Project are spent entirely in Years -2 and -1. Sustaining capital for the mill project is spent during Years 4 and 5. Sustaining capital for mining is spent during Years 1 through 10.
- Working capital equal to 60 days of operating costs during the pre-production and ramp up period for the heap leach and 14 days for the mill is considered in the model for mining, process and G&A costs as well as initial fills for process reagents and consumables. The assumption is made that all working capital and initial fills can be recovered in the final years of the heap leach and milling operations, respectively, and the effective sum of working capital and initial fills over the life of mine is zero.
- Depreciation allowances for eligible items are included in the model.
- Depletion allowances are included in the model.
- A corporate federal income tax of 21% is considered.
- A 1.10% Nevada mining excise royalty is included.
- A 3.66% net proceeds of mineral tax is included.
- A refinery and transportation cost of US\$1.40/oz for gold, US\$1.00/oz for silver and US\$170/t for copper plus a concentrate treatment charge of US\$213.85 is used in the model, including insurance. Gold, silver and copper are assumed to be 99.9%, 96.5% and 96.5% payable, respectively.
- By-product cash operating costs per payable ounce represent the mine site operating costs including mining, processing, metal transport, refining, administration costs and royalties with a credit for silver and copper produced. Operating costs are presented in greater detail in Section 21 of this report.
- All in sustaining costs per payable ounce represent the mine site operating costs including mining, processing, metal transport, refining, administration costs and royalties with a credit for silver and copper produced as well as the LOM sustaining capital and reclamation and closure costs.

- The cash flow analysis evaluates the Project on a stand-alone basis. No withholding taxes or dividends are included. No head office or overheads for the parent company are included.

22.3 Capital Expenditures

Capital expenditures include initial capital (pre-production or construction costs), sustaining capital (mining sustaining capital and mill expansion) and working capital. The capital expenditures are presented in detail in Section 21 of this Report.

The economic model assumes working capital and initial fills will be recovered at the end of each operating phase and are applied as credits against the capital cost. Working capital and initial fills are assumed to be recovered during Year 5 for the heap and Year 14 for the mill. Salvage value for the mining fleet, process equipment and electrical equipment is included and is applied during Years 14 and 15 after equipment items are no longer in service.

22.4 Metal Production

Total metal production for the Gabbs oxide and sulphide deposits are estimated at 1,472,600 ounces of recovered gold, 2,058,100 ounces of recovered silver and 190,000 tonnes of recovered copper. Annual production profiles for gold, silver and copper are presented in Figure 22-1 through Figure 22-3 with 104,000 ounces of gold, 146,000 ounces of silver and 13,000 tonnes of copper being recovered annually on average.

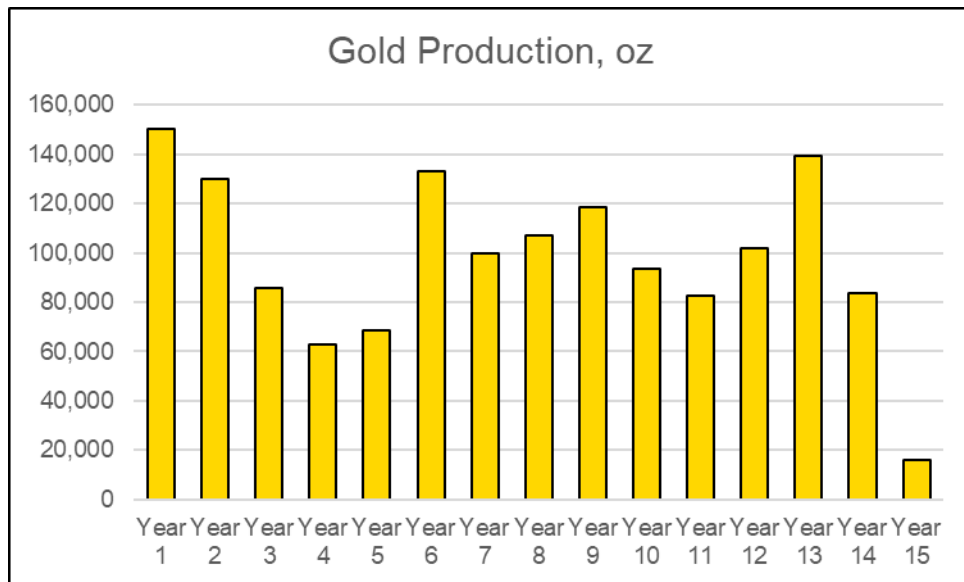

Figure 22-1 Annual Gold Production

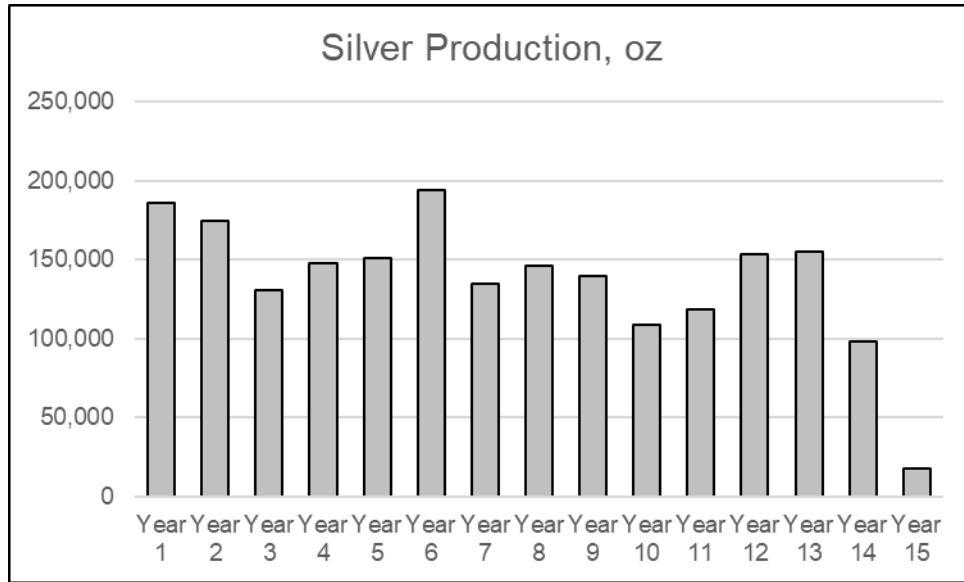

Figure 22-2 Annual Silver Production

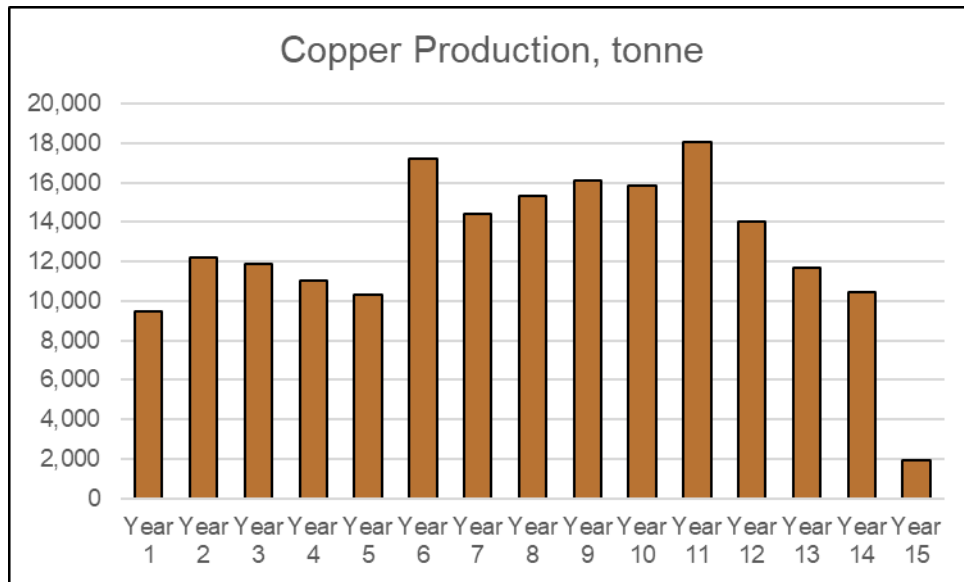

Figure 22-3 Annual Copper Production

22.5 Royalties

The Gabbs Project does not include any royalties other than the 1.1% Nevada Mining Excise Tax.

22.6 Operating Costs

Operating costs were estimated by KCA for all process and support services. G&A operating costs were estimated by KCA with input from P2. Mining costs were estimated by P&E. LOM operating costs for the Gabbs Project are summarized in Table 22-3. A detailed description of the operating cost build-up is included in Section 21.0 of this report.

**Table 22-3
LOM Operating Costs**

Description	LOM Cost (US\$/t)
Mine	\$6.73
Process & Support Services	\$11.78
Site G & A	\$0.73
Total	\$19.24

22.7 Closure Costs

Reclamation and closure include costs for works to be conducted for the closure of the mine at the end of operations and have been estimated primarily by KCA with input from P&E for encapsulation of transition and sulphide material in the waste rock dump. The estimated LOM reclamation and closure costs is US\$56.4 million, not including G&A, or US\$0.45 per tonne processed based on a closure period of 1.6 years after the completion of operations (concurrent reclamation of the heap leach will occur during Year 14 while the mill is in operation). Reclamation and closure activities are summarized in Section 20.0 of this report and costs are summarized in Section 21.0.

22.8 Taxation

22.8.1 Federal Income Tax

Federal income tax is applied at 21% of the Project income after deductions of eligible expenses including depreciation of assets, earthworks and indirect construction costs, exploration costs, special mining tax, extraordinary mining duty and any losses carried forward.

22.8.1 Nevada Mining Excise Tax

The Nevada excise tax is applied at 1.1% of the Project revenue.

22.8.1 Net Proceeds of Mineral Tax

The Net Proceeds of Mineral Tax is applied at 3.66% of the Project income after deduction of eligible exploration, earthworks and indirect costs expenses. Income subject to the special mining tax does not allow deductions for depreciation or allow losses carried forward.

22.8.2 Depreciation

Depreciation is considered for the Nevada Net Proceeds of Mineral Tax and Federal Income Tax calculations and is based on the 7-year modified accelerated recovery system (MACRS) method for mining and process equipment, 39-year MACRS for buildings and structures and units of production for mining and processing pre-production costs. Salvage value is considered in the depreciation calculations.

22.8.3 Depletion

Depletion is considered for the calculation of the Nevada Net Proceeds of Mineral Tax and Federal Income Tax and is calculated as 15% of the annual gross income or 50% of the taxable income, whichever is less.

22.9 Economic Model & Cash Flow

The discounted cash flow model for the Gabbs Project is presented in Table 22-4 and is based on the inputs and assumptions detailed in this Section.

The Project cash flows are net of royalties and taxes. The Project yields an after-tax IRR of 21.0%.

Table 22-4 Cashflow Model Summary

Item	TOTAL	Heap Leach Production										Heap and Mill Production						
		Year -2	Year -1	Year 1	Year 2	Year 3	Year 4	Year 5	Year 6	Year 7	Year 8	Year 9	Year 10	Year 11	Year 12	Year 13	Year 14	Year 15
Total Mined																		
Processed Tonnes	125,345,274			8,999,988	9,000,038	8,999,842	8,999,997	8,999,997	8,999,965	8,999,741	8,999,592	9,000,520	9,000,297	8,999,891	8,999,996	9,000,245	7,317,001	1,028,163
Au, g/t	0.43			0.78	0.54	0.35	0.26	0.31	0.52	0.38	0.43	0.47	0.36	0.31	0.43	0.57	0.35	0.45
Ag, g/t	1.09			1.68	1.28	0.96	1.17	1.16	1.33	0.93	1.06	0.99	0.77	0.84	1.15	1.15	0.78	0.88
Cu, %	0.24			0.23	0.26	0.24	0.22	0.21	0.26	0.23	0.25	0.26	0.26	0.28	0.21	0.19	0.19	0.20
Waste Mined	399,384,168		14,592,548	34,685,749	36,996,471	47,240,220	48,371,693	48,857,852	43,310,977	16,994,132	13,446,430	11,144,097	18,125,556	29,105,202	30,467,250	5,955,946	45,022	45,022
Total mined	534,045,108		14,592,548	46,264,910	47,049,769	57,646,778	58,733,783	58,850,962	52,310,942	26,319,966	22,833,871	20,403,690	27,157,198	38,213,729	40,273,547	14,958,193	7,362,024	1,073,199
Contained Au, oz	1,119,955			225,872	155,519	101,391	76,353	89,504	66,639	44,466	55,661	60,193	46,460	31,592	65,543	85,736	15,025	0
Contained Ag, oz	2,819,334			486,748	370,070	277,557	337,624	335,748	180,565	92,829	114,219	93,021	77,663	70,488	156,173	178,974	47,655	0
Contained Au, kg	34,834			7,025	4,837	3,154	2,375	2,784	2,073	1,383	1,731	1,872	1,445	983	2,039	2,667	467	0
Contained Ag, kg	87,890			15,139	11,510	8,633	10,501	10,443	5,616	2,887	3,553	2,893	2,416	2,192	4,857	5,567	1,482	0
Contained Cu, tonnes	177,508			20,619	23,014	21,774	20,184	18,991	8,908	7,532	9,083	10,252	10,110	9,218	6,292	8,271	3,261	0
Total Gold Produced, oz	1,471,603			150,330	130,034	85,746	62,725	68,537	133,120	99,602	106,979	118,307	93,382	82,580	101,721	139,140	83,580	15,819
Total Silver Produced, oz	2,058,092			186,181	174,407	131,145	147,876	151,213	194,017	135,175	146,058	139,677	108,659	118,620	153,449	155,316	98,571	17,727
Total Copper Produced, t	189,959			9,464	12,233	11,858	11,028	10,352	17,195	14,437	15,314	16,081	15,832	18,055	14,047	11,698	10,446	1,917
Realized Recovery, Au				67%	74%	76%	77%	77%	79%	80%	81%	82%	82%	83%	83%	83%	84%	84%
Realized Recovery, Ag				38%	42%	43%	43%	44%	45%	46%	46%	46%	46%	46%	46%	46%	47%	47%
Realized Recovery, Cu				46%	50%	51%	52%	53%	56%	58%	60%	61%	62%	63%	63%	64%	64%	64%
Gold Payable, oz	1,470,499			150,217	129,936	85,682	62,678	68,486	133,020	99,527	106,899	118,218	93,312	82,518	101,645	139,036	83,517	15,807
Silver Payable, oz	1,986,059			179,665	168,303	126,555	142,701	145,921	187,226	130,443	140,946	134,788	104,856	114,468	148,078	149,880	95,121	17,107
Copper Payable, t	183,310			9,133	11,805	11,443	10,642	9,990	16,593	13,932	14,778	15,519	15,278	17,423	13,556	11,289	10,080	1,850
Refining & Transportation Charge Au	\$2,060,244			\$210,461	\$182,048	\$120,045	\$87,815	\$95,952	\$186,368	\$139,443	\$149,771	\$165,629	\$130,735	\$115,612	\$142,409	\$194,796	\$117,012	\$22,147
Refining & Transportation Charge Ag	\$2,058,092			\$186,181	\$174,407	\$131,145	\$147,876	\$151,213	\$194,017	\$135,175	\$146,058	\$139,677	\$108,659	\$118,620	\$153,449	\$155,316	\$98,571	\$17,727
Refining & Transportation Charge Cu	\$32,292,946			\$1,608,928	\$2,079,694	\$2,015,902	\$1,874,796	\$1,759,825	\$2,923,160	\$2,454,261	\$2,603,370	\$2,733,838	\$2,691,452	\$3,069,279	\$2,388,040	\$1,988,705	\$1,775,809	\$325,888
Treatment Charge - SART/Flotation	\$95,396,733			\$3,679,858	\$4,756,570	\$4,610,668	\$4,287,939	\$4,024,982	\$9,428,556	\$7,916,135	\$8,397,082	\$8,817,904	\$8,681,187	\$9,899,856	\$7,702,544	\$6,414,501	\$5,727,812	\$1,051,139
NET REVENUE	\$4,603,899,253	\$0	\$0	\$382,336,056	\$367,509,166	\$276,892,052	\$224,970,834	\$230,267,948	\$415,965,791	\$324,906,643	\$347,290,016	\$375,994,372	\$324,538,091	\$321,415,358	\$326,006,441	\$378,107,612	\$257,522,548	\$48,187,336
OPERATING COSTS	Total	Year -2	Year -1	Year 1	Year 2	Year 3	Year 4	Year 5	Year 6	Year 7	Year 8	Year 9	Year 10	Year 11	Year 12	Year 13	Year 14	Year 15
Operating Costs																		
Mining Costs	\$843,152,827			\$70,355,552	\$74,714,317	\$89,181,382	\$87,606,424	\$88,137,929	\$88,619,149	\$44,240,889	\$47,720,045	\$48,251,694	\$42,775,140	\$57,775,768	\$57,719,904	\$38,388,318	\$7,154,548	\$511,767
Processing Cost	\$1,476,487,686			\$96,072,510	\$95,471,245	\$94,985,843	\$94,763,578	\$94,881,072	\$111,583,011	\$111,199,614	\$111,326,661	\$111,417,948	\$111,145,207	\$110,789,938	\$111,074,759	\$111,485,650	\$94,725,827	\$15,564,822
G&A Cost	\$91,509,164			\$6,116,463	\$6,116,463	\$6,116,463	\$6,116,463	\$6,116,463	\$6,586,686	\$6,586,686	\$6,586,686	\$6,586,686	\$6,586,686	\$6,586,686	\$6,586,686	\$6,586,686	\$6,586,686	\$6,586,686
TOTAL OPERATING COSTS	\$2,411,149,676	\$0	\$0	\$172,544,526	\$176,302,026	\$190,283,688	\$188,486,465	\$189,135,464	\$206,788,846	\$162,027,189	\$165,633,392	\$166,266,328	\$160,507,033	\$175,152,393	\$175,281,340	\$165,460,655	\$108,467,061	\$17,723,261
CAPITAL COSTS	Total	Year -2	Year -1	Year 1	Year 2	Year 3	Year 4	Year 5	Year 6	Year 7	Year 8	Year 9	Year 10	Year 11	Year 12	Year 13	Year 14	Year 15
Capital Costs																		
Mining Direct Costs	\$159,550,189	\$23,203,272	\$12,180,187	\$18,417,529	\$21,047,334	\$26,785,998	\$22,785,998	\$17,033,087	\$8,425,645	\$3,479,163	\$815,500	\$340,500	\$1,201,790	\$650,733	\$650,733	\$1,231,252	\$650,733	\$650,733
Mining Indirect Costs	\$5,813,408	\$655,731	\$487,207	\$723,081	\$828,273	\$897,820	\$897,820	\$667,703	\$323,406	\$125,547	\$19,000	\$0	\$34,452	\$26,029	\$26,029	\$49,250	\$26,029	\$26,029
EPCM	\$0	\$0	\$0	\$0	\$0	\$0	\$0	\$0	\$0	\$0	\$0	\$0	\$0	\$0	\$0	\$0	\$0	\$0
Owner's Costs	\$0	\$0	\$0	\$0	\$0	\$0	\$0	\$0	\$0	\$0	\$0	\$0	\$0	\$0	\$0	\$0	\$0	\$0
Pre-stripping	\$25,743,252	\$0	\$25,743,252	\$0	\$0	\$0	\$0	\$0	\$0	\$0	\$0	\$0	\$0	\$0	\$0	\$0	\$0	\$0
Contingency	\$19,110,685	\$2,385,900	\$3,841,065	\$1,914,061	\$2,187,561	\$2,768,382	\$2,368,382	\$1,770,079	\$874,905	\$360,471	\$83,450	\$34,050	\$123,624	\$67,676	\$67,676	\$128,050	\$67,676	\$67,676
Mine Subtotal	\$210,217,533	\$26,244,904	\$42,251,711	\$21,054,671	\$24,063,168	\$30,452,199	\$26,052,199	\$19,470,869	\$9,623,956	\$3,965,181	\$917,950	\$374,550	\$1,359,865	\$744,439	\$744,439	\$1,408,553	\$744,439	\$744,439
Major Earthworks	\$50,149,433	\$15,469,929	\$10,313,286			\$6,812,316	\$5,050,727	\$2,525,363	\$5,218,854				\$4,758,959					
Liner / Materials	\$36,065,007	\$5,909,485	\$3,939,657			\$8,027,329	\$4,746,465	\$2,373,233	\$5,841,002				\$5,227,837					
Civils (Supply & Install)	\$21,847,473		\$16,107,257					\$5,740,216										
Structural Steel (Supply & Install)	\$11,777,151		\$4,494,278					\$7,282,873										
Platwork (Supply)	\$4,484,024		\$4,484,024															
Platwork (Install)	\$1,353,383		\$1,353,383															
Mechanical Equipment (Supply)	\$184,107,365	\$7,732,306	\$69,590,754				\$71,189,537	\$35,594,768										
Mechanical Equipment (Install)	\$53,302,834		\$22,189,165				\$20,742,446	\$10,371,223										
Piping (Supply & Install)	\$13,537,044		\$7,074,578				\$2,154,155	\$4,308,310										
Electrical (Supply)	\$13,889,704		\$7,253,022				\$6,636,682											
Electrical (Install)	\$21,118,856		\$10,661,704					\$10,457,151										
Instrumentation (Supply & Install)	\$10,253,159		\$3,244,211				\$2,336,316	\$4,672,632										
Infrastructure (Supply & Install)	\$10,791,533		\$5,023,949					\$5,767,584										
Spare Parts	\$16,405,114		\$9,998,056				\$4,271,372	\$2,135,686										
Process Contingency	\$106,224,011		\$45,171,854			\$3,709,												

PRE-TAX NET CASH FLOW	Total	Year -2	Year -1	Year 1	Year 2	Year 3	Year 4	Year 5	Year 6	Year 7	Year 8	Year 9	Year 10	Year 11	Year 12	Year 13	Year 14	Year 15
Pre-Tax Net Cash Flow																		
Pre-tax net cash flow	\$1,285,890,506	-\$63,412,806	-\$314,311,806	\$188,736,859	\$167,143,962	\$36,123,167	-\$147,410,907	-\$110,342,159	\$184,612,573	\$158,914,273	\$180,738,673	\$209,363,494	\$149,189,370	\$147,518,526	\$149,879,652	\$220,238,405	\$130,464,730	-\$1,556,502
Royalty Payable	\$0	\$0	\$0	\$0	\$0	\$0	\$0	\$0	\$0	\$0	\$0	\$0	\$0	\$0	\$0	\$0	\$0	\$0
Extraordinary Mining Duty	\$50,642,892	\$0	\$0	\$4,205,697	\$4,042,601	\$3,045,813	\$2,474,679	\$2,532,947	\$4,575,514	\$3,573,973	\$3,820,190	\$4,136,938	\$3,569,919	\$3,557,569	\$3,586,060	\$4,159,184	\$2,832,748	\$530,061
Salvage Value	\$62,142,972																\$31,071,486	\$31,071,486
Pre-tax net Cash Flow	\$1,297,390,586	-\$63,412,806	-\$314,311,806	\$184,531,163	\$163,101,361	\$33,077,354	-\$149,885,586	-\$112,875,106	\$180,037,060	\$155,340,300	\$176,918,483	\$205,227,556	\$145,619,451	\$143,960,957	\$146,293,592	\$216,079,221	\$158,703,468	\$28,985,923
Cumulative		-\$63,412,806	-\$377,724,612	-\$193,193,449	-\$30,092,088	\$2,985,266	-\$146,900,320	-\$259,775,426	-\$79,738,366	\$75,601,934	\$252,520,417	\$457,747,973	\$603,367,424	\$747,328,382	\$893,621,974	\$1,109,701,195	\$1,268,404,663	\$1,297,390,586
After-TAX NET CASH FLOW																		
After-Tax Net Cash Flow																		
Income & Other Taxes	\$182,084,424	\$0	\$0	\$4,484,234	\$16,539,966	\$3,483,162	\$0	\$0	\$0	\$0	\$16,644,180	\$26,959,496	\$18,264,164	\$16,266,249	\$20,287,573	\$37,975,439	\$21,179,961	\$0
After-Tax net annual Cash Flow, \$	\$1,115,306,162	-\$63,412,806	-\$314,311,806	\$180,046,929	\$146,561,395	\$29,594,192	-\$149,885,586	-\$112,875,106	\$180,037,060	\$155,340,300	\$160,274,303	\$178,268,059	\$127,355,287	\$127,694,709	\$126,006,020	\$178,103,782	\$137,523,507	\$28,985,923
Cumulative		-\$63,412,806	-\$377,724,612	-\$197,677,683	-\$51,116,288	-\$21,522,096	-\$171,407,682	-\$284,282,788	-\$104,245,728	\$51,094,572	\$211,368,875	\$389,636,935	\$516,992,222	\$644,686,930	\$770,692,950	\$948,796,732	\$1,086,320,239	\$1,115,306,162

22.10 Sensitivity

To estimate the relative economic strength of the Project, base case sensitivity analyses have been completed analyzing the economic sensitivity to several parameters including changes in gold price, capital costs and average operating cash cost per tonne processed. The sensitivities are based on +/- 25% of the base case values. The after-tax analysis is presented in Table 22-5. Figure 22-4 and Figure 22-5 present graphical representations of the after-tax sensitivities.

The economic indicators chosen for sensitivity evaluation are the internal rate of return (IRR) and NPV at 5% discount rate.

**Table 22-5
After-Tax Sensitivity Analysis Results**

	Variation	IRR	NPV (\$,000)		
			0%	5%	10%
Gold Price					
75%	\$1,463	9.7%	\$530,242	\$167,345	(\$8,068)
90%	\$1,755	16.4%	\$883,693	\$399,226	\$153,036
100%	\$1,950	21.0%	\$1,115,306	\$549,957	\$257,004
110%	\$2,145	25.6%	\$1,344,535	\$698,376	\$358,878
125%	\$2,438	32.7%	\$1,684,515	\$917,999	\$509,377
Capital Costs					
75%	\$637,840	33.0%	\$1,327,920	\$722,623	\$400,604
90%	\$765,408	24.9%	\$1,200,352	\$619,023	\$314,444
100%	\$850,454	21.0%	\$1,115,306	\$549,957	\$257,004
110%	\$935,499	17.8%	\$1,030,261	\$480,890	\$199,564
125%	\$1,063,067	13.9%	\$902,693	\$377,290	\$113,405
Operating Costs					
75%	\$1,808,362	30.5%	\$1,583,508	\$856,150	\$468,114
90%	\$2,170,035	24.8%	\$1,304,293	\$673,850	\$342,589
100%	\$2,411,150	21.0%	\$1,115,306	\$549,957	\$257,004
110%	\$2,652,265	17.1%	\$924,023	\$423,810	\$169,382
125%	\$3,013,937	11.3%	\$627,530	\$226,698	\$31,550

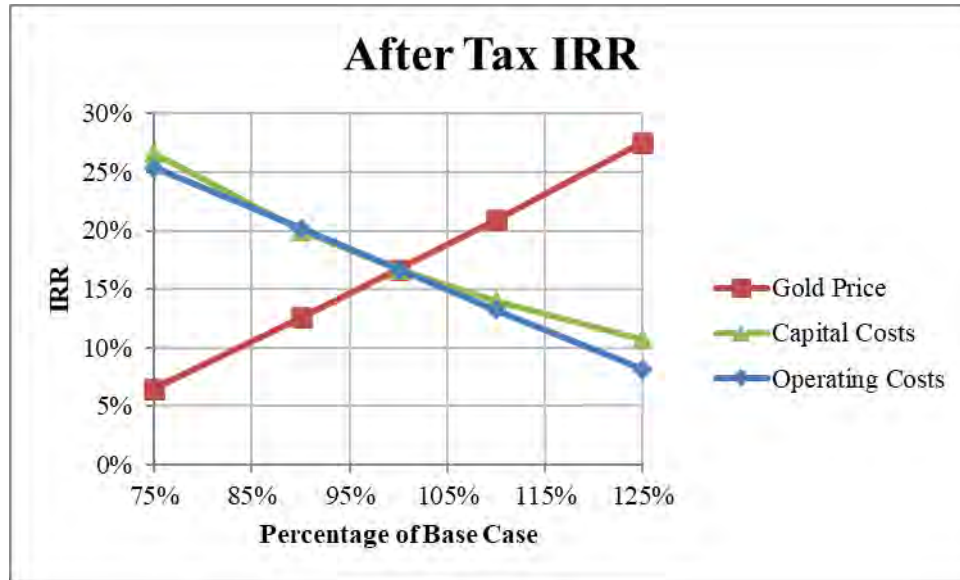

Figure 22-4 After Tax Sensitivity – IRR

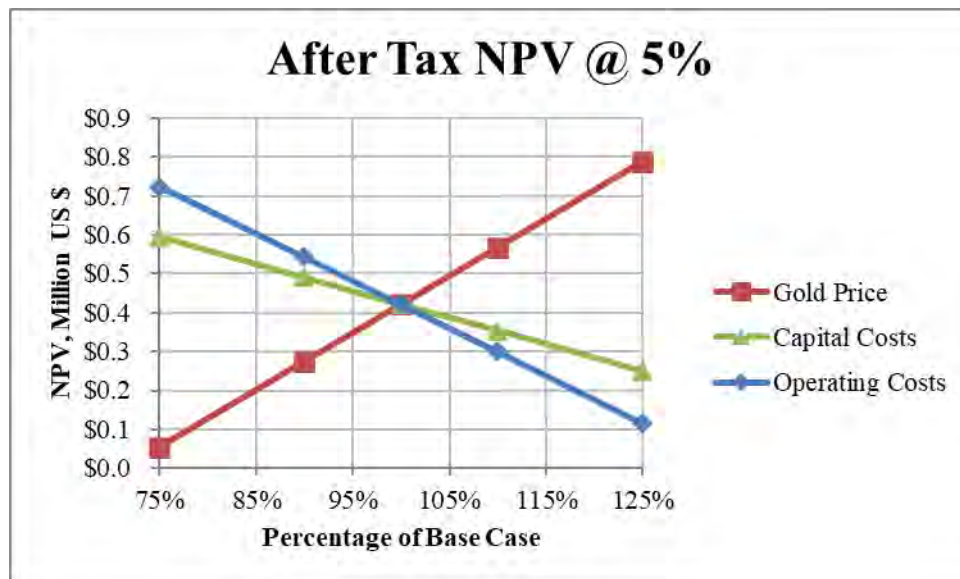
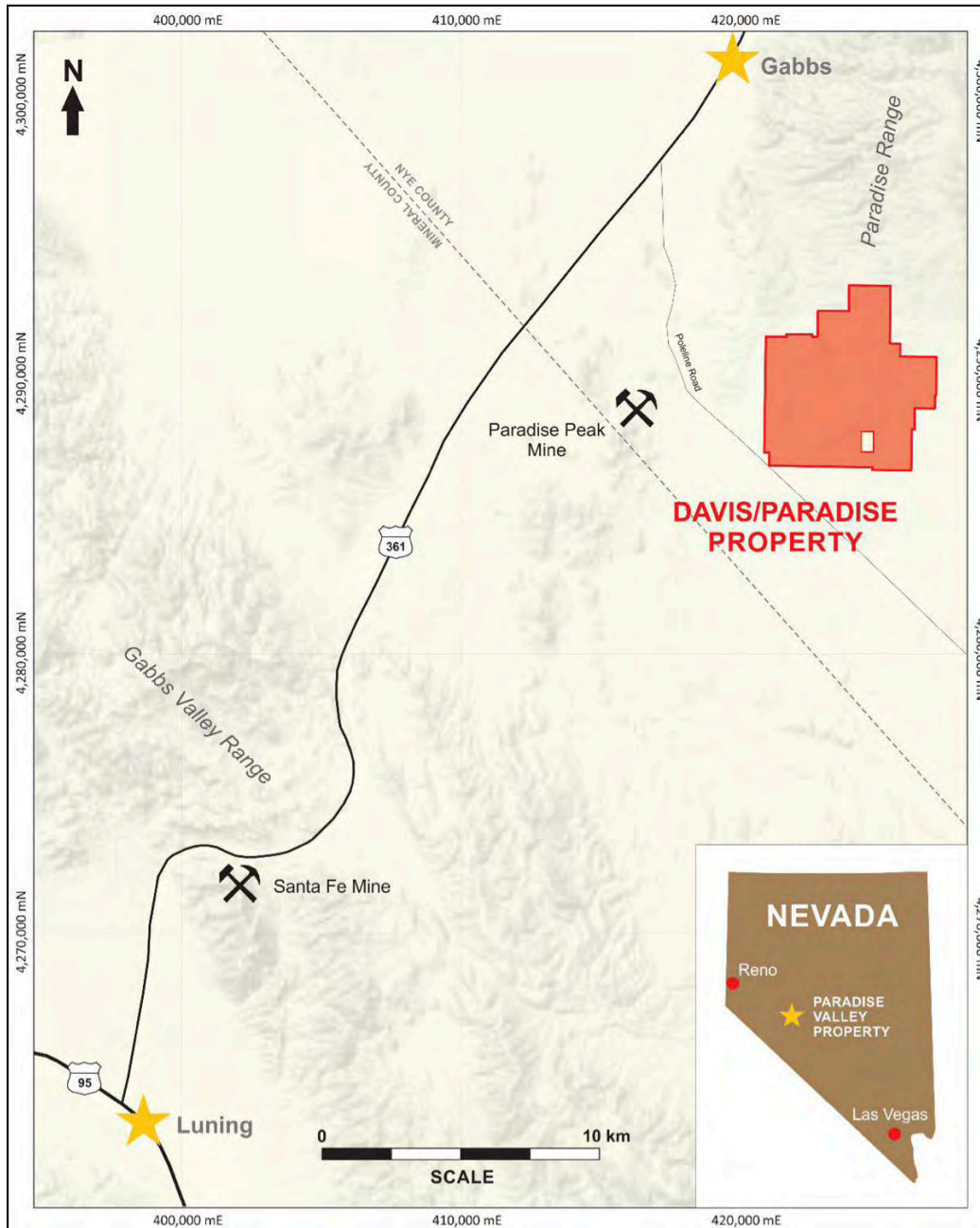

Figure 22-5 After Tax Sensitivity – NPV @ 5%

Based on the spot metal prices on the Report Effective Date of 17 May 2024 (US\$2,414/oz gold, US\$31.48/oz silver, and US\$4.71/lb copper), the after-tax NPV at 5% discount rate of the Project is US\$949.2 million and the after-tax IRR is 33.5%.

23.0 ADJACENT PROPERTIES

Two other significant properties are located in the Gabbs Property area: 1) the Paradise Peak Mine Property; and 2) the Paradise/Davis Property (Figure 23-1). Each of these two properties are described below.



Source: Almadex Minerals (press release dated September 22, 2022)

Figure 23-1
Location of the Davis/Paradise Valley Property

23.1 Paradise Peak Gold Mine

The information below is summarized from an Economic Geology paper on the Paradise Peak Property prepared by Sillitoe and Larson (1994).

The Paradise Peak Mine, located south-adjacent to the Gabbs Property (Figure 23-1) and discovered in 1983, was mined by FMC Corporation from 1985 to 1993. Total production was 1.46 million ounces gold, 38.9 million ounces silver, and 457 tonnes of mercury.

At the Paradise Peak Mine, high sulphidation epithermal gold-silver-mercury mineralization is hosted by stratabound bodies of pervasively silicified, welded ash-flow tuff. The highest precious metal values were found in hydrothermal breccias that cut silicified tuff and, at the Paradise Peak Deposit, also overlying andesite flows and felsic tuffs altered to a quartz-alunite assemblage.

A lower andesite sequence is the host for a large zone of low-grade porphyry style gold mineralization. This andesite sequence is located beneath the mineralized tuff horizons. Gold is present in a quartz veinlet stockwork cutting sericitized andesite flows, which is inferred to be intruded at depth by a porphyry stock.

Three of the high sulphidation deposits were considered to have been a single deposit prior to an episode of detachment faulting that postdates steep, normal faulting and precious metal mineralization.

High sulphidation mineralization in the east lobe of the Paradise Peak Deposit lies beneath the base of oxidation and consists of refractory sulphidic material. Sulphides compose 10 to 90% of the unoxidized material and, after oxidation, produced the friable, powdery material common in the deposits. Weathering resulted in very localized redistribution of silver and gold. Hypogene oxidation was not recognized.

23.2 Davis/Paradise Property

Almadex Minerals consolidated the Davis/Paradise Valley area during 2019 by optioning, from the underlying owners, the Davis Property. The Davis Property adjoins the pre-existing Paradise Valley Property, which had been staked by Almadex's predecessor company. The combined Davis/Paradise Property now consists of 358 claims totalling approximately 2,800 ha and is located approximately eight miles southeast of Gabbs, Nevada and five miles northeast of the Paradise Peak Gold Mine (Figure 23-1).

According to the Almadex Minerals website, the Davis/Paradise Property is fully permitted for drilling, which is planned to test several targets in 2023, including the Davis vein, Turquoise

Ridge copper porphyry target, and the broad Paradise high sulphidation alteration target areas. The drilling planned at the Davis Vein is designed to test the continuation of the vein at depth, where drilling completed earlier in 2022 returned intervals including 13.70m (core length) of 2.3 g/t gold and 24.1 g/t silver.

The reader is cautioned that the Author has been unable to verify the information in this section and such information is not necessarily indicative of the mineralization on the Gabbs Property, which is the subject of this Technical Report.

24.0 OTHER RELEVANT DATA AND INFORMATION

The authors are not aware of any relevant data or information available for the Gabbs Project that have been excluded from this report.

25.0 INTERPRETATIONS AND CONCLUSIONS

25.1 Conclusions

25.1.1 Mineral Resource Estimate

The Gabbs Property is well situated in an established Nevada mineralization trend. The Property contains at least three separate Au-Cu porphyry deposits (the Sullivan, Lucky Strike and Gold Ledge Zones) and one epithermal gold deposit (the Car Body Zone). Their close proximity to each other suggests that they may either share a common source, or that multiple intrusive centres exist. Significant potential exists for additional drilling to extend the current mineralization and expand the Mineral Resources.

The current pit-constrained Mineral Resource Estimate for the Gabbs Property is reported using a cut-off of 0.27 g/t gold equivalent (“AuEq”) for oxide material and 0.36 g/t AuEq for sulphide material. Gold equivalent pit constrained Mineral Resources at Gabbs consist of: Indicated Mineral Resources of 1.16 million ounces of gold equivalent (“AuEq”) or 0.72 million ounces of gold, 2.2 million ounces of silver and 297.0 million pounds of copper (49.8 million tonnes grading 0.45 g/t Au, 1.36 g/t Ag and 0.27% Cu); and Inferred Mineral Resources of 2.29 million ounces of AuEq or 1.28 million ounces of gold, 3.0 million ounces of silver and 567.1 million pounds of copper (112.2 million tonnes grading 0.35 g/t Au, 0.84 g/t Ag and 0.23% Cu).

25.1.2 Mining

The mineralized material will be mined by standard open-pit mining methods using an owner mining fleet of 136 tonne haul trucks and 15 m³ hydraulic excavators with a LOM production of 125.3 million tonnes with an average grade of 0.43 g/t Au, 1.09 g/t Ag and 0.24% Cu.

25.1.3 Metallurgy and Process

The work that has been completed to date has demonstrated that the Gabbs open pit mine, heap leach and milling facilities are a technically feasible and economically viable project. The property is conveniently located with access via Highway 361.

The Project has been designed as an open-pit mine with heap leach for recovery of gold, silver and copper from oxide material and recovery of those metals from sulphide material by milling. Overall average grades are estimated to be 0.43 g/t Au, 1.09 g/t Ag and 0.24% Cu. Metallurgical test work on the material to date shows acceptable recoveries for gold, silver and copper with moderate reagent consumptions.

Mineralized heap leach material will be crushed to P₈₀ 6.3 mm, stockpiled, reclaimed and conveyor stacked onto the heap leach pad at 9million tonnes per year. Stacked material will be leached using low grade sodium cyanide solution and the resulting pregnant leach solution will be processed in a SART plant for the recovery of copper and silver and cyanide. The resulting copper and silver precipitate will be sold, bringing additional revenue to the project while the cyanide will be recycled back to the plant.

Starting in year six, mineralized sulfide material will be treated in a flotation/cyanidation mill at a rate of approximately 5,000,000 tonnes per year. The ROM material will be fine crushed in the same crushing circuit used in the operation of the heap leach facility. The crushed product will then be conveyed to a ball mill grinding circuit. The heap leach will continue to operate at a reduced rate of 4,000,000 tonnes per year.

The milled sulfide product will be treated in a flotation plant to produce a copper concentrate suitable for sale. The flotation tailings will be thickened, then direct cyanide leached in a cyanidation circuit to dissolve gold, silver and any remaining cyanide soluble copper. The leached solids will be washed in a countercurrent decantation (CCD) circuit to remove dissolved gold, silver and copper. The dissolved copper and silver will be recovered from the CCD overflow solution in a SART plant as a copper/silver sulphide precipitate. Regenerated sodium cyanide from the SART plant will be recycled to the leach circuit.

CCD tails will be treated in a cyanide destruction circuit, filtered, and conveyed to a “dry stack” storage facility.

The barren solution from the SART plant will be processed in a carbon adsorption-desorption-recovery (ADR) plant to recover gold. The gold will be periodically stripped from the carbon using a desorption process. The gold will be plated on stainless steel cathodes, removed by washing, filtered, dried and then smelted to produce a doré bar.

The Project has an estimated mine life of 14.1 years.

25.1.4 Environmental Studies, Permits, And Social Or Community Impacts

To develop, operate, and close a mining operation, P2 Gold will be required to obtain a number of environmental and other permits from the BLM, the State of Nevada, and Nye County. Environmental baseline studies will need to be conducted at the Project area to meet federal and state requirements.

The permitting process will require the preparation of an Environmental Assessment (EA) or Environmental Impact Statement (EIS) under the National Environmental Policy Act (NEPA),

Council of Environmental Quality (CEQ) regulations, and BLM guidelines and procedures. Nevada state permits that will be required prior to authorization for a mine project include a Water Pollution Control Permit, Reclamation Permit, Air Quality Operating Permit, and several other minor permits.

A query of the Nevada Division of Natural Heritage database conducted by Western Biological revealed no records of endangered, threatened, or at-risk animal taxa within the Project area. Historic records of Eastwood milkweed and Tonopah milkvetch exist one and five miles outside of the Project Area, respectively. Historic records of the pale kangaroo mouse exist greater than 8 km (5 miles) outside of the Project area. None of these species were observed during the baseline biological surveys.

At this early stage of environmental studies at the Project site, the QP is not aware of any environmental issues that would preclude development on a potential mine operation. Currently, P2 Gold holds two Notices of Intent with the BLM for exploration drilling and bulk sampling on approximately up to a combined 8 acres of disturbance on unpatented mining claims.

Residents of the nearby town of Gabbs, the larger town of Hawthorne, somewhat more distal, and the general regional area, have historically been supportive of mineral exploration and mine development projects. A labor workforce of experienced miners and exploration support staff is available regionally.

25.2 Opportunities

25.2.1 Mining

- Considering contract mining to decrease capital costs required in Year 0;
- Evaluate equipment alternatives to reduce capital costs;
- Optimize mine plan sequencing to increase return on capital.

25.2.2 Mineral Resource

- Expand oxide gold, and gold, silver and copper mineralization in the Mineral Resource;

25.2.3 Metallurgy and Process

- Additional test work to increase recoveries for oxide and sulphide mineralization and evaluate the use of HPGR for potential heap leaching of sulphide mineralization to increase recovery of free gold;
- Evaluate equipment alternatives to reduce capital costs;

- Optimize mine plan sequencing to increase return on capital.

25.3 Risks

25.3.1 Mining

Geotechnical studies of the open pit wall slopes and hydrogeological studies on the potential water inflow into the open pits have not been conducted. Pit slope geotechnical studies could impact favorably or negatively on the pit designs. Flattening of slopes could have a significant impact on the open pit waste rock quantity to be mined.

The Mineral Resource Estimate is comprised of 37% Indicated Mineral Resources and 63% Inferred Mineral Resources. The Inferred Mineral Resources require in-fill drilling to be potentially converted to Indicated Mineral Resources for greater confidence and eligibility to become Mineral Reserves.

25.3.2 Metallurgy and Process

There is a risk that CIC and/or SART efficiencies may be poor, particularly during initial operations due to low pregnant solution concentrations of gold and copper. This may result in increased reagent consumptions and delayed or even reduced metal recoveries. The highest grade material is also expected to be processed during the initial years of the Project, further increasing the risks due to startup inefficiencies.

25.3.3 Other Risks

Future changes to the project flowsheet or layout could delay permitting.

26.0 RECOMMENDATIONS

26.1 KCA Recommendations

- Comminution testing is recommended to establish power consumption and wear rates for conventional crushing, HPGR crushing and milling for sulphide investigations;
- Additional compacted permeability testing is recommended to define the cement addition required to stack different oxide materials to 70 m;
- Additional flotation testing with additional cleaning and locked-cycle testing should provide enough concentrate to determine concentrate penalty elements, and concentrate treatment (i.e., leaching of gold from final cleaner concentrate);
- SART concentrate should be evaluated for penalty elements, and flotation-SART concentrate blends evaluated to minimize penalty elements;
- Additional, HPGR crushed, column leach testing is recommended to determine if the leach cycle can be reduced by adjusting the initial solution application rate and initial sodium cyanide concentration;
- Additional drilling should be completed as required to supply samples for metallurgical development programs.

The estimated cost for the metallurgical work is US\$300,000, not including costs for drilling or shipping of samples.

26.2 P&E Recommendations

It is recommended that the Company continue with the current sample preparation, security and analytical protocol at the Project, with the exception of modifying to a more suitable laboratory protocol for the Car Body Deposit samples. Recommendation is made to analyse all likely mineralized samples at the Car Body Deposit by metallic screening procedure.

It is recommended that the Company complete an additional 12,500 m (41,000 ft) of reverse circulation drilling to further delineate and expand the oxide Mineral Resources. This exploration program is estimated to cost US\$2.0 million.

26.3 Welsh Hagen Recommendations

26.3.1 Environmental Studies, Permitting, And Social Or Community Impacts

Initialization of baseline environmental studies is recommended to establish potential environmental permitting constraints associated with a potential future mine development

project. Baseline studies that should be started include a Class III cultural resource inventory, and static and kinetic rock characterization of mineralized and waste rock materials.

The preparation of a BLM Exploration Plan of Operations (EPO) and Reclamation Plan will be needed to conduct exploration, geotechnical investigations or other surface disturbance programs that would exceed the maximum 5-acre surface disturbance limit allowed under a BLM Notice of Intent. An environmental assessment will be required before the EPO is approved by the BLM.

The estimated cost for the environmental and permitting work is US\$200,000.

27.0 REFERENCES

- Chamberlain, C. 2008. Gabbs Mapping. Memorandum to Newcrest Resources Inc. July 25, 2008.
- Clark, G.J. 2010. Draft version of “Technical Report on the Gabbs Project, Fairplay Mining District, Nye County, Nevada”, prepared by Clark Exploration Consulting and dated November 2010.
- Corbett, G. 2009. Anatomy of Porphyry-related Au-Cu-Ag-Mo Mineralised Systems: Some Exploration Implications: Australian Institute of Geoscientists North Queensland Exploration Conference, dated June 2009.
- Craig, S.D., Oldow, J.S., dePolo, C.M., Hardyman, R.A. and John, D.A. 1992. Road Log from Luning to Westgate via Mina and Gabbs, in Craig, S.D., ed., Walker Lane Symposium, Hawthorne Area – Northern Walker Lane Structure and Tectonics, 1992 Spring Field Trip No. 1 Guidebook, Geological Society of Nevada, Special Publication No. 14, p. 54.
- Davis, D.A. 2008. Industrial Minerals, in The Nevada Mineral Industry 2007: Nevada Bureau of Mines and Geology Special Publication MI-2007, 117-147.
- Ellis, R. 2011. Recommendations for Geophysics on the Gabbs Project, Nye County, Nevada. Memorandum to St. Vincent Minerals Inc. dated April 29, 2011. Ellis Geophysical Consulting Inc.
- Fierst, John. 2009. Summary Report of Activities through 2008. The Gabbs Project, Nye County, Nevada, dated April 2009. Newcrest Resources Inc. 58 p.
- Jemielita, R. 2011. A Review of the Gabbs Gold-Copper Property Nye County Nevada USA. Report prepared for St. Vincent Minerals Inc., 31 p.
- Job, M. and Singh, V. 2010. Gabbs Gold-Copper Project Resource Estimation. Report Revision 1. 28/01/2010. Newcrest Mining Limited. 59 p.
- John, D.A., Nash, T., Clarke, C.W. and Wulfetange, W.H. 1990. Geology, Hydrothermal Alteration and Mineralization at the Paradise Peak Gold-Silver-Mercury Deposit, Nye County, Nevada. In Raines, G.L., Lisle, R.E., Schafer, R.W., and Wilkinson, W.H.,

- editors. Geology and Ore Deposits of the Great Basin. April 1-5, 1990. Symposium Proceedings. Geological Society of Nevada, Reno, Nevada, 1991. 1020-1050.
- John, D.A., Thomason, R.E. and McKee, E.H. 1989. Geology and K-Ar Geochronology of the Paradise Peak Mine and the Relationship of Pre-Basin and Range Extension to Early Miocene Precious Metal Mineralization in West-central Nevada. *Economic Geology* 84, 631-649.
- Jones, R. 2009. Gabbs Project QA/QC. Internal Report for Minerals Division, Newcrest Mining Ltd.
- Hedenquist, J.W., Arribas, A., Jr. and Gonzales-Urien, E. 2000. Exploration for Epithermal Gold Deposits. *Reviews in Economic Geology* 13, 245–277.
- Henley, R.W. and Ellis, A.J. 1983. Geothermal Systems, Ancient and Modern: *Earth Science Reviews* 19, 1–50.
- Kappes, Cassiday & Associates, 2022 (July), Gabbs Project Report of Metallurgical Test Work. Report I.D. KCA0220059_GAB01_01.
- Kappes, Cassiday & Associates, 2022 (June), Gabbs Project, Coarse Bottle Roll Leach Test Work. Report I.D. KCA0210121_GAB01_03.
- Kappes, Cassiday & Associates, 2023 (June), NI 43-101 Technical Report, Preliminary Economic Assessment, Gabbs Project, Nye County, Nevada, USA, Dan Whiteley, P.E. of Kappes, Cassiday & Associates of Reno Nevada , Eugene Puritch , P.Eng., FEC, CET, Andrew Bradfield , P.Eng., William Stone , Ph.D., P.Geo., Jarita Barry , P.Geo., David Burga , P.Geo. and Kirk Rodgers , P.Eng. of P&E Mining Consultants Inc. of Brampton, Ontario and Douglas Willis , CPG of Welsh Hagen Associates of Reno Nevada,.29 June 2023
- Kleinhampl, F.J. and Ziony, J.I. 1984. Mineral Resources of Northern Nye County, Nevada: Nevada Bureau of Mines and Geology Bulletin 99B, 241 p.
- Lowell, J.D. and Guilbert, J.M. 1970. Lateral and Vertical Alteration-Mineralization Zoning in Porphyry Ore Deposits. *Economic Geology* 65, 373-408.
- Ludington, S., John, D., Muntean, J., Hansen, A., Castor, S., Henry, C., Cline, J., and Simon, A. 2009. Mineral-Resource Assessment of Northern Nye County, Nevada-A Progress Report, United States Geological Survey (USGS) Open File Report (OFR) 2029-1271.

- Mason, D.R. 2008. Petrographic Descriptions for Thirty-Two Drill Core Rock Samples, Sullivan Porphyry Au-Cu Project, Nevada, USA. Mason Geoscience Pty Ltd. Unpublished report for Newcrest Resources Inc. May 7, 2008.
- Maxlow, J. 2009. Gabbs Gold-Copper Project, Resource Estimation, prepared for Newcrest Mining Limited.
- P&E, 2011. Technical Report and Resource Estimate on the Gabbs Gold-Copper Property, Fairplay Mining District, Nye County, Nevada, USA. Prepared for St. Vincent Minerals Inc., by Ewert, W., Brown, F., Armstrong, T. and Burga, D. of P&E Mining Consultants Inc., dated December 21, 2011 and available at www.SEDAR.com.
- P&E, 2021. Amended and Restated Mineral Resource Estimate of the Gabbs Gold-Copper Property, Fairplay Mining District, Nye Country, Nevada USA. Prepared for P2 Gold Inc., by Eugene Puritch, Richard H. Sutcliffe, Fred Brown and Jarita Barry of P&E Mining Consultants Inc., dated December 10, 2021 (with effective date January 13, 2021) and available at www.SEDAR.com.
- P&E, 2022. Technical Report and Updated Mineral Resource Estimate of The Gabbs Gold-Copper Property, Fairplay Mining District, Nye County, Nevada, USA, dated March 25, 2022 (with effective date February 10, 2022) and available at www.SEDAR.com.
- Pratt, W. and Ponce, M. 2011. Structural Controls on Mineralization at the Gabbs Project, Nye County, Nevada. Prepared for St. Vincent Minerals Inc. 48 p. plus Appendices.
- Proffett, J.M. 2007. Report on the Geology and Genesis of the Yerington Porphyry Copper District, Nevada, a Four-Dimensional Study. Final Report for USGS Mineral Resource External Research Program Grant 06HQGR0171, September 2007.
- Schilling, J.H. 1968. The Gabbs Magnesite-Brucite Deposit, Nye County, Nevada: in Ridge, J.D., ed., Ore Deposits of the United States, 1933-1967: Graton-Sales, vol. 2, American Institute of Mining, Metallurgical and Petroleum Engineers, New York, 1608-1621.
- Seedorff, E. 1991. Royston District, Western Nevada—a Mesozoic Porphyry Copper System that was Tilted and Dismembered by Tertiary Normal Faults, in Raines, G.L., Lisle, R.E., Schafer, R.W., and Wilkinson, W.H., eds., Geology and Ore Deposits of the Great Basin—Symposium Proceedings. Geological Society of Nevada, Reno, 359–391.

- Shaver, S.A. 1984. The Hall (Nevada moly) Molybdenum Deposit, Nye County, Nevada—Geology, Alteration, Mineralization and Geochemical Dispersion. Unpublished Ph.D. Dissertation, Stanford University.
- Sillitoe, R.H. 2010. Porphyry Copper Systems. *Economic Geology* 105, 3-41.
- Sillitoe, R.H. and Hedenquist, J.W. 2003. Linkages Between Volcanotectonic Settings, Ore Fluid Compositions, and Epithermal Precious Metal Deposits. *Society of Economic Geologists Special Publication* 10, 315–343.
- Sillitoe, R.H. and Lorson, R.C. 1994. Epithermal Gold-Silver-Mercury Deposits at Paradise Peak, Nevada: Ore Controls, Porphyry Gold Association, Detachment Faulting and Supergene Oxidation. *Economic Geology* 89, 1228-1248.
- Simmons, S.F., White, N.C., and John, D.A. 2005. Geological Characteristics of Epithermal Precious and Base Metal Deposits: *Economic Geology 100th Anniversary Volume*, 485-522.
- Smith, S.C. 2011. QA/QC Review, St. Vincent RC Drilling 2011.
- Snyder, J. 2008. Fall 2008 Gabbs Mapping. Memorandum to Newcrest Resources Inc. October 31, 2008.
- Thompson, T.B. 2006. Petrography of RC Chip Specimens from Drill Holes G-13 and G-28. Prepared for Newcrest Resources Inc. by Economic Geology Consulting, 20 September 2006.
- Tribe, Norm. 2007. Mineral Resource Evaluation Report on the B & C Springs Molycopper Property, Nye County, Nevada, USA: Private Report for Adanac Moly Corp., 48 p.
- Vila, T. and Sillitoe, R. 1991. Gold Rich Porphyry Systems in the Maracunga Belt, Northern Chile. *Economic Geology* 86, 1238-1260.
- Vitaliano, C.J. and Callaghan, E. 1956. Geologic Map of the Gabbs Magnesite and Brucite Deposits, Nye County, Nevada: U.S. Geological Survey Mineral Investigations Field Studies Map, MF-35.
- Walch, M., 2022. P2 Gabbs Raptor Survey Report 2022, Internal Report for P2 Gold Inc., dated September 2022. Western Biological.

Walch, M., 2022. P2 Gabbs Project Biological Baseline Survey Report, Internal Report for P2 Gold Inc., dated November 2022. Western Biological.

Walch, M., 2023. P2 Gabbs Project Passive Acoustic Bat Survey Report, Internal Report for P2 Gold Inc., dated January 2023. Western Biological.

Wood, John D. 2003. Summary Report of the Geology and History of the Gabbs Property and Adjacent Areas. The Gabbs Project, Nye County, Nevada. Newcrest Resources Inc. 16 p. dated March 2003.

Wood, John, D. 2005 The Gabbs Project, Lander County, Nevada, Summary Report of Activities through 2006, Newcrest Resource, dated March 2005.

28.0 DATE AND SIGNATURE PAGE

This report, entitled “Preliminary Economic Assessment NI 43-101 Technical Report on the Gabbs Gold Project, Nye County, Nevada, USA” has the following report dates:

Report Effective Date is: 17 May 2024

Report Signed Date is: 03 July 2024

Mineral Resource Effective Date is: 29 April 2024

The report was prepared as per the following signed Qualified Persons’ Certificates.

CERTIFICATE OF QUALIFIED PERSON

CARL E. DEFILIPPI, RM SME

I, Carl E. Defilippi, RM SME, of Reno, Nevada, USA, Project Manager at Kappes, Cassiday & Associates, as an author of this report entitled ““NI 43-101 Technical Report Preliminary Economic Assessment Gabbs Heap Leach and Mill Project Nye County, Nevada, USA”, (The “Technical Report”) with an effective date of May 17, 2024, prepared for P2 Gold Inc. (the “Issuer”) do hereby certify that:

1. I am employed as a Project Manager at Kappes, Cassiday & Associates, an independent metallurgical consulting firm, whose address is 7950 Security Circle, Reno, Nevada 89506.
2. This certificate applies to the Technical Report titled “NI 43-101 Technical Report Preliminary Economic Assessment Gabbs Heap Leach and Mill Project Nye County, Nevada, USA”, (The “Technical Report”) with an effective date of May 17, 2024.
3. I am a Registered Member with the Society of Mining, Metallurgy and Exploration (SME) since 2011 and my qualifications include experience applicable to the subject matter of the Technical Report. In particular, I am a graduate of the University of Nevada with a B.S. in Chemical Engineering (1978) and a M.S. in Metallurgical Engineering (1981). I have practiced my profession continuously since 1982. Most of my professional practice has focused on the development of gold-silver leaching projects. I have successfully managed numerous studies at all levels on various cyanidation projects.
4. I am familiar with National Instrument 43-101 – Standards of Disclosure for Mineral Projects (“**NI 43-101**”) and by reason of education, experience, and professional registration I fulfill the requirements of a “qualified person” as defined in NI 43-101.
5. I visited the Gabbs Project property for a total of one day on 30 September 2023 to inspect the Project site, proposed locations for process facilities and site infrastructure.
6. I am responsible for Sections 1.1, 1.2, 1.6, 1.9, 1.10, 1.12, 1.13, 1.14.1, 1.14.2, 1.14.3.2, 1.15.1, 2, 3, 4, 5, 6, 12.4, 13, 17, 18, 19, 21.1.2 through 21.1.8, 21.2.2, 21.3, 22, 24, 25.1.3, 25.2.3, 25.3.2, 25.3.3, 26.1, 27, 28 and 29 of the Technical Report.
7. I am independent of the Issuer as described in Section 1.5 of NI 43-101.
8. I have had prior involvement with this project. I was a Qualified Person for a Technical Report titled “NI 43-101 Technical Report Preliminary Economic Assessment Gabbs Project Nye County, Nevada, USA” with an effective date of September 7, 2023.
8. I have read NI 43-101 and the Technical Report has been prepared in compliance with NI 43-101.
9. As of the effective date of the Technical Report, to the best of my knowledge, information and belief, the Technical Report contains all scientific and technical information that is required to be disclosed to make the Technical Report not misleading.

Effective Date: May 17, 2024

Signed Date: July 3, 2024

{SIGNED AND SEALED}

[Carl E. Defilippi]

Carl E. Defilippi, RM SME

CERTIFICATE OF QUALIFIED PERSON

EUGENE PURITCH, P. ENG., FEC, CET

I, Eugene J. Puritch, P. Eng., FEC, CET, residing at 44 Turtlecreek Blvd., Brampton, Ontario, Canada, L6W 3X7, do hereby certify that:

1. I am an independent mining consultant and President of P&E Mining Consultants Inc.
2. This certificate applies to the Technical Report titled “NI 43-101 Technical Report Preliminary Economic Assessment Gabbs Heap Leach and Mill Project Nye County, Nevada, USA”, (The “Technical Report”) with an effective date of May 17, 2024.
3. I am a graduate of The Haileybury School of Mines, with a Technologist Diploma in Mining, as well as obtaining an additional year of undergraduate education in Mine Engineering at Queen’s University. In addition, I have also met the Professional Engineers of Ontario Academic Requirement Committee’s Examination requirement for a Bachelor’s degree in Engineering Equivalency. I am a mining consultant currently licensed by the: Professional Engineers and Geoscientists New Brunswick (License No. 4778); Professional Engineers, Geoscientists Newfoundland and Labrador (License No. 5998); Association of Professional Engineers and Geoscientists Saskatchewan (License No. 16216); Ontario Association of Certified Engineering Technicians and Technologists (License No. 45252); Professional Engineers of Ontario (License No. 100014010); Association of Professional Engineers and Geoscientists of British Columbia (License No. 42912); and Northwest Territories and Nunavut Association of Professional Engineers and Geoscientists (No. L3877). I am also a member of the National Canadian Institute of Mining and Metallurgy.

I have read the definition of “Qualified Person” set out in National Instrument 43-101 (“NI 43-101”) and certify that, by reason of my education, affiliation with a professional association (as defined in NI 43-101) and past relevant work experience, I fulfill the requirements to be a “Qualified Person” for the purposes of NI 43-101.

I have practiced my profession continuously since 1978. My summarized career experience is as follows:

- Mining Technologist - H.B.M.& S. and Inco Ltd., 1978-1980
- Open Pit Mine Engineer – Cassiar Asbestos/Brinco Ltd., 1981-1983
- Pit Engineer/Drill & Blast Supervisor – Detour Lake Mine, 1984-1986
- Self-Employed Mining Consultant – Timmins Area, 1987-1988
- Mine Designer/Resource Estimator – Dynatec/CMD/Bharti, 1989-1995
- Self-Employed Mining Consultant/Resource-Reserve Estimator, 1995-2004
- President – P&E Mining Consultants Inc, 2004-Present

4. I have not visited the Property that is the subject of this Technical Report.
5. I am responsible for authoring Sections 1.7, 1.15.2, 14, 25.1.1, 25.2.2 and 26.2 of this Technical Report.
6. I am independent of the Issuer applying the test in Section 1.5 of NI 43-101.
7. I have had prior involvement with the Project that is the subject of this Technical Report. I was a Qualified Person for a Technical Report titled “Technical Report and Updated Mineral Resource Estimate of the Gabbs Gold-Copper Property, Fairplay Mining District, Nye County, Nevada, USA”, with an effective date of February 10, 2022, and for a Technical Report titled “NI 43-101 Technical Report Preliminary Economic Assessment Gabbs Project Nye County, Nevada, USA” with an effective date of June 29, 2023.
8. I have read NI 43-101 and Form 43-101F1. This Technical Report has been prepared in compliance therewith.
9. As of the effective date of this Technical Report, to the best of my knowledge, information and belief, the Technical Report contains all scientific and technical information that is required to be disclosed to make the Technical Report not misleading.

Effective Date: May 17, 2024

Signed Date: July 3, 2024

{SIGNED AND SEALED}

[Eugene Puritch]

Eugene Puritch, P.Eng., FEC, CET

CERTIFICATE OF QUALIFIED PERSON

ANDREW BRADFIELD, P. ENG.

I, Andrew Bradfield, P. Eng., residing at 5 Patrick Drive, Erin, Ontario, Canada, N0B 1T0, do hereby certify that:

1. I am an independent mining engineer contracted by P&E Mining Consultants.
2. This certificate applies to the Technical Report titled “NI 43-101 Technical Report Preliminary Economic Assessment Gabbs Heap Leach and Mill Project Nye County, Nevada, USA”, (The “Technical Report”) with an effective date of May 17, 2024.
3. I am a graduate of Queen’s University, with an honours B.Sc. degree in Mining Engineering in 1982. I have practiced my profession continuously since 1982. I am a Professional Engineer of Ontario (License No.4894507). I am also a member of the National CIM.

I have read the definition of “Qualified Person” set out in National Instrument 43-101 (“NI 43-101”) and certify that, by reason of my education, affiliation with a professional association (as defined in NI 43-101) and past relevant work experience, I fulfill the requirements to be a “Qualified Person” for the purposes of NI 43-101.

I have practiced my profession continuously since 1982. My summarized career experience is as follows:

- Various Engineering Positions – Palabora Mining Company, 1982-1986
- Mines Project Engineer – Falconbridge Limited, 1986-1987
- Senior Mining Engineer – William Hill Mining Consultants Limited, 1987-1990
- Independent Mining Engineer, 1990-1991
- GM Toronto – Bharti Engineering Associates Inc, 1991-1996
- VP Technical Services, GM of Australian Operations – William Resources Inc, 1996-1999
- Independent Mining Engineer, 1999-2001
- Principal Mining Engineer – SRK Consulting, 2001-2003
- COO – China Diamond Corp, 2003-2006
- VP Operations – TVI Pacific Inc, 2006-2008
- COO – Avion Gold Corporation, 2008-2012
- Independent Mining Engineer, 2012-Present

4. I have not visited the Property that is the subject of this Technical Report.
5. I am responsible for authoring sections 1.8, 1.14.3.1, 15, 16, 21.1.1, 21.2.1, 25.1.2, 25.2.1 and 25.3.1 of this Technical Report.
6. I am independent of the Issuer applying the test in Section 1.5 of NI 43-101. I am independent of the Vendor and the Property.
7. I have had prior involvement with the Property that is the subject of this Technical Report. I was a Qualified Person for a Technical Report titled “NI 43-101 Technical Report Preliminary Economic Assessment Gabbs Project Nye County, Nevada, USA” with an effective date of June 29, 2023.
8. I have read NI 43-101 and Form 43-101F1. This Technical Report has been prepared in compliance therewith.
9. As of the effective date of this Technical Report, to the best of my knowledge, information and belief, the Technical Report contains all scientific and technical information that is required to be disclosed to make the Technical Report not misleading.

Effective Date: May 17, 2024

Signing Date: July 3, 2024

{SIGNED AND SEALED}

[Andrew Bradfield]

Andrew Bradfield, P.Eng.

CERTIFICATE OF QUALIFIED PERSON

JARITA BARRY, P.GEO.

I, Jarita Barry, P.Geo., residing at 9052 Mortlake-Ararat Road, Victoria, Australia, 3377, do hereby certify that:

1. I am an independent geological consultant contracted by P&E Mining Consultants Inc.
2. This certificate applies to the Technical Report titled “NI 43-101 Technical Report Preliminary Economic Assessment Gabbs Heap Leach and Mill Project Nye County, Nevada, USA”, (The “Technical Report”) with an effective date of May 17, 2024.
3. I am a graduate of RMIT University of Melbourne, Victoria, Australia, with a B.Sc. in Applied Geology. I have worked as a geologist for over 18 years since obtaining my B.Sc. degree. I am a geological consultant currently licensed by Engineers and Geoscientists British Columbia (License No. 40875) and Professional Engineers and Geoscientists Newfoundland & Labrador (License No. 08399), and I am registered as a Temporary Registrant with Professional Geoscientists Ontario (Registration No. 3888). I am also a member of the Australasian Institute of Mining and Metallurgy of Australia (Member No. 305397);

I have read the definition of “Qualified Person” set out in National Instrument 43-101 (“NI 43-101”) and certify that by reason of my education, affiliation with a professional association (as defined in NI 43-101) and past relevant work experience, I fulfill the requirements to be a “Qualified Person” for the purposes of NI 43-101.

My relevant experience for the purpose of the Technical Report is:

- Geologist, Foran Mining Corp. 2004
- Geologist, Aurelian Resources Inc. 2004
- Geologist, Linear Gold Corp. 2005-2006
- Geologist, Búscore Consulting 2006-2007
- Consulting Geologist (AusIMM) 2008-2014
- Consulting Geologist, P.Geo. (APEGBC/AusIMM) 2014-Present

4. I have not visited the Property that is the subject of this Technical Report.
5. I am responsible for authoring Sections 1.5, 11, 12.1, 12.2.2 and 12.3 of this Technical Report.
6. I am independent of the Issuer applying the test in Section 1.5 of NI 43-101. I am independent of the Vendor and the Property.
7. I have had prior involvement with the Project that is the subject of this Technical Report. I was a Qualified Person for a Technical Report titled “Technical Report and Updated Mineral Resource Estimate of the Gabbs Gold-Copper Property, Fairplay Mining District, Nye County, Nevada, USA”, with an effective date of February 10, 2022, and for a Technical Report titled “NI 43-101 Technical Report Preliminary Economic Assessment Gabbs Project Nye County, Nevada, USA” with an effective date of June 29, 2023.
8. I have read NI 43-101 and Form 43-101F1 and the Technical Report has been prepared in compliance therewith.
9. As of the effective date of this Technical Report, to the best of my knowledge, information and belief, the Technical Report contains all scientific and technical information that is required to be disclosed to make the Technical Report not misleading.

Effective Date: May 17, 2024

Signed Date: July 3, 2024

{SIGNED AND SEALED}

[Jarita Barry]

Jarita Barry, P.Geo.

CERTIFICATE OF QUALIFIED PERSON

DAVID BURGA, P.GEO.

I, David Burga, P. Geo., residing at 3884 Freeman Terrace, Mississauga, Ontario, Canada, do hereby certify that:

1. I am an independent geological consultant contracted by P&E Mining Consultants Inc.
2. This certificate applies to the Technical Report titled “NI 43-101 Technical Report Preliminary Economic Assessment Gabbs Heap Leach and Mill Project Nye County, Nevada, USA”, (The “Technical Report”) with an effective date of May 17, 2024.
3. I am a graduate of the University of Toronto with a Bachelor of Science degree in Geological Sciences (1997). I have worked as a geologist for over 20 years since obtaining my B.Sc. degree. I am a geological consultant currently licensed by the Association of Professional Geoscientists of Ontario (License No 1836).

I have read the definition of “Qualified Person” set out in National Instrument 43-101 (“NI 43-101”) and certify that, by reason of my education, affiliation with a professional association (as defined in NI 43-101) and past relevant work experience, I fulfill the requirements to be a “Qualified Person” for the purposes of NI 43-101.

My relevant experience for the purpose of the Technical Report is:

- | | |
|--|--------------|
| • Exploration Geologist, Cameco Gold | 1997-1998 |
| • Field Geophysicist, Quantec Geoscience | 1998-1999 |
| • Geological Consultant, Andeburg Consulting Ltd. | 1999-2003 |
| • Geologist, Aeon Egmond Ltd. | 2003-2005 |
| • Project Manager, Jacques Whitford | 2005-2008 |
| • Exploration Manager – Chile, Red Metal Resources | 2008-2009 |
| • Consulting Geologist | 2009-Present |

4. I have visited the Property that is the subject of this Technical Report on October 5 and 6, 2021.
5. I am responsible for authoring Sections 1.4, 9, 10 and 12.2.1 of this Technical Report.
6. I am independent of the Issuer applying the test in Section 1.5 of NI 43-101.
7. I have had prior involvement with the Project that is the subject of this Technical Report. I was a Qualified Person for a Technical Report titled “Technical Report and Updated Mineral Resource Estimate of the Gabbs Gold-Copper Property, Fairplay Mining District, Nye County, Nevada, USA”, with an effective date of February 10, 2022, and for a Technical Report titled “NI 43-101 Technical Report Preliminary Economic Assessment Gabbs Project Nye County, Nevada, USA” with an effective date of June 29, 2023.
8. I have read NI 43-101 and Form 43-101F1 and this Technical Report has been prepared in compliance therewith.
9. As of the effective date of this Technical Report, to the best of my knowledge, information and belief, the Technical Report contains all scientific and technical information that is required to be disclosed to make the Technical Report not misleading.

Effective Date: May 17, 2024

Signing Date: July 3, 2024

{SIGNED AND SEALED}

[David Burga]

David Burga, P.Geo.

CERTIFICATE OF QUALIFIED PERSON

WILLIAM STONE, PH.D., P.GEO.

I, William Stone, Ph.D., P.Geo., residing at 4361 Latimer Crescent, Burlington, Ontario, Canada do hereby certify that:

1. I am an independent geological consultant.
2. This certificate applies to the Technical Report titled “NI 43-101 Technical Report Preliminary Economic Assessment Gabbs Heap Leach and Mill Project Nye County, Nevada, USA”, (The “Technical Report”) with an effective date of May 17, 2024.
3. I am a graduate of Dalhousie University with a Bachelor of Science (Honours) degree in Geology (1983). In addition, I have a Master of Science in Geology (1985) and a Ph.D. in Geology (1988) from the University of Western Ontario. I have worked as a geologist for a total of 35 years since obtaining my M.Sc. degree. I am a geological consultant currently licensed by the Professional Geoscientists of Ontario (License No 1569).

I have read the definition of “qualified person” set out in National Instrument 43-101 (“NI 43-101”) and certify that, by reason of my education, affiliation with a professional association (as defined in NI 43-101) and past relevant work experience, I fulfill the requirements to be a “qualified person” for the purposes of NI 43-101.

My relevant experience for the purpose of the Technical Report is:

- Contract Senior Geologist, LAC Minerals Exploration Ltd. 1985-1988
- Post-Doctoral Fellow, McMaster University 1988-1992
- Contract Senior Geologist, Outokumpu Mines and Metals Ltd. 1993-1996
- Senior Research Geologist, WMC Resources Ltd. 1996-2001
- Senior Lecturer, University of Western Australia 2001-2003
- Principal Geologist, Geoinformatics Exploration Ltd. 2003-2004
- Vice President Exploration, Nevada Star Resources Inc. 2005-2006
- Vice President Exploration, Goldbrook Ventures Inc. 2006-2008
- Vice President Exploration, North American Palladium Ltd. 2008-2009
- Vice President Exploration, Magma Metals Ltd. 2010-2011
- President & COO, Pacific North West Capital Corp. 2011-2014
- Consulting Geologist 2013-2017
- Senior Project Geologist, Anglo American 2017-2019
- Consulting Geoscientist 2020-Present

4. I have not visited the Property that is the subject of this Technical Report.
5. I am responsible for authoring Sections 1.3, 7, 8 and 23 of this Technical Report.
6. I am independent of the Issuer applying the test in Section 1.5 of NI 43-101.
7. I have had prior involvement with the Project that is the subject of this Technical Report. I was a Qualified Person for a Technical Report titled “Technical Report and Updated Mineral Resource Estimate of the Gabbs Gold-Copper Property, Fairplay Mining District, Nye County, Nevada, USA”, with an effective date of February 10, 2022, and for a Technical Report titled “NI 43-101 Technical Report Preliminary Economic Assessment Gabbs Project Nye County, Nevada, USA” with an effective date of June 29, 2023.
8. I have read NI 43-101 and Form 43-101F1 and this Technical Report has been prepared in compliance therewith.
9. As of the effective date of this Technical Report, to the best of my knowledge, information and belief, the Technical Report contains all scientific and technical information that is required to be disclosed to make the Technical Report not misleading.

Effective Date: May 17, 2024

Signing Date: July 3, 2024

{SIGNED AND SEALED}

[William Stone]

Dr. William E. Stone, P.Geo.

CERTIFICATE OF QUALIFIED PERSON

DOUGLAS W. WILLIS, C.P.G.

I, Douglas W. Willis, C.P.G., residing at 6306 Chesterfield Ln., Reno, Nevada, USA, as an author of this report do hereby certify that:

1. I am employed as senior geologist at Welsh Hagen Associates, an engineering and mine permitting firm whose address is 250 S. Rock Blvd., Suite 118, Reno, Nevada, USA, 89502.
2. This certificate applies to the Technical Report titled “NI 43-101 Technical Report Preliminary Economic Assessment Gabbs Heap Leach and Mill Project Nye County, Nevada, USA”, (The “Technical Report”) with an effective date of May 17, 2024.
3. I am a graduate of California State University, Chico with a Bachelor of Science degree in Geology (1987). I have practiced my profession as a geologist for 23 years primarily focusing on gold exploration, mine planning, mine permitting, and mine development in Nevada, USA. I have successfully managed environmental studies and prepared exploration and mine permit applications for federal and state agencies for numerous precious metals and industrial minerals projects in the state of Nevada, USA for the past 16 years. I am a Certified Professional Geologist (#11371) in good standing with the American Institute of Professional Geologists (AIPG). I have read the definition of “Qualified Person” set out in National Instrument 43-101 (“NI 43-101”) and certify that by reason of education, certification as a professional geologist and past relevant work experience, I fulfill the requirements to be a “Qualified Person” for the purposes of NI 43-101.
4. I have not visited the Property that is the subject of this Technical Report.
5. I am responsible for authoring Sections 1.11, 1.16, 20, 25.1.4 and 26.3 of this Technical Report.
6. I am independent of the issuer, applying all of the tests in section 1.5 of NI 43-101.
7. I have had prior involvement with the Property that is the subject of this Technical Report. I was involved with the independent contractor selection process for a biological baseline survey at the Property in 2022. I was a Qualified Person for the Technical Reports titled “NI 43-101 Technical Report Preliminary Economic Assessment Gabbs Project Nye County, Nevada, USA” with an effective date of June 29, 2023, and “NI 43-101 Technical Report Preliminary Economic Assessment Gabbs Heap Leach and Mill Project Nye County, Nevada, USA” with an effective date of September 7, 2023.
8. I have read NI 43-101 and Form 43-101F1 and this Technical Report has been prepared in compliance herewith.
9. As of the effective date of this Technical Report, to the best of my knowledge, information and belief, the Technical Report contains all scientific and technical information that is required to be disclosed to make the Technical Report not misleading.

Effective Date: May 17, 2024

Signed Date: July 3, 2024

{SIGNED AND SEALED}
[Douglas W. Willis]

Douglas W. Willis, C.P.G.

29.0 APPENDICES

29.1 Appendix A - Surface Drill Hole Plans

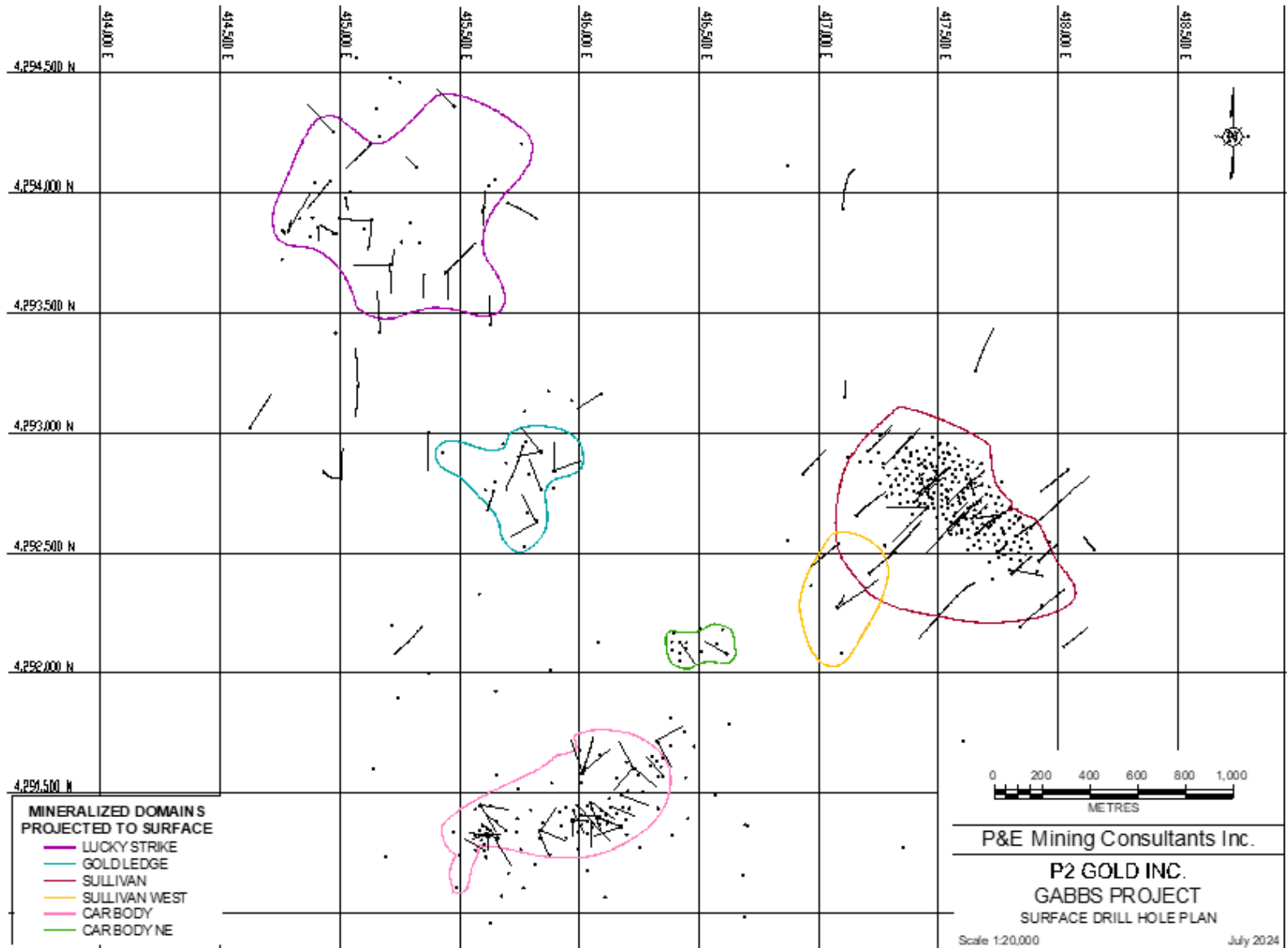

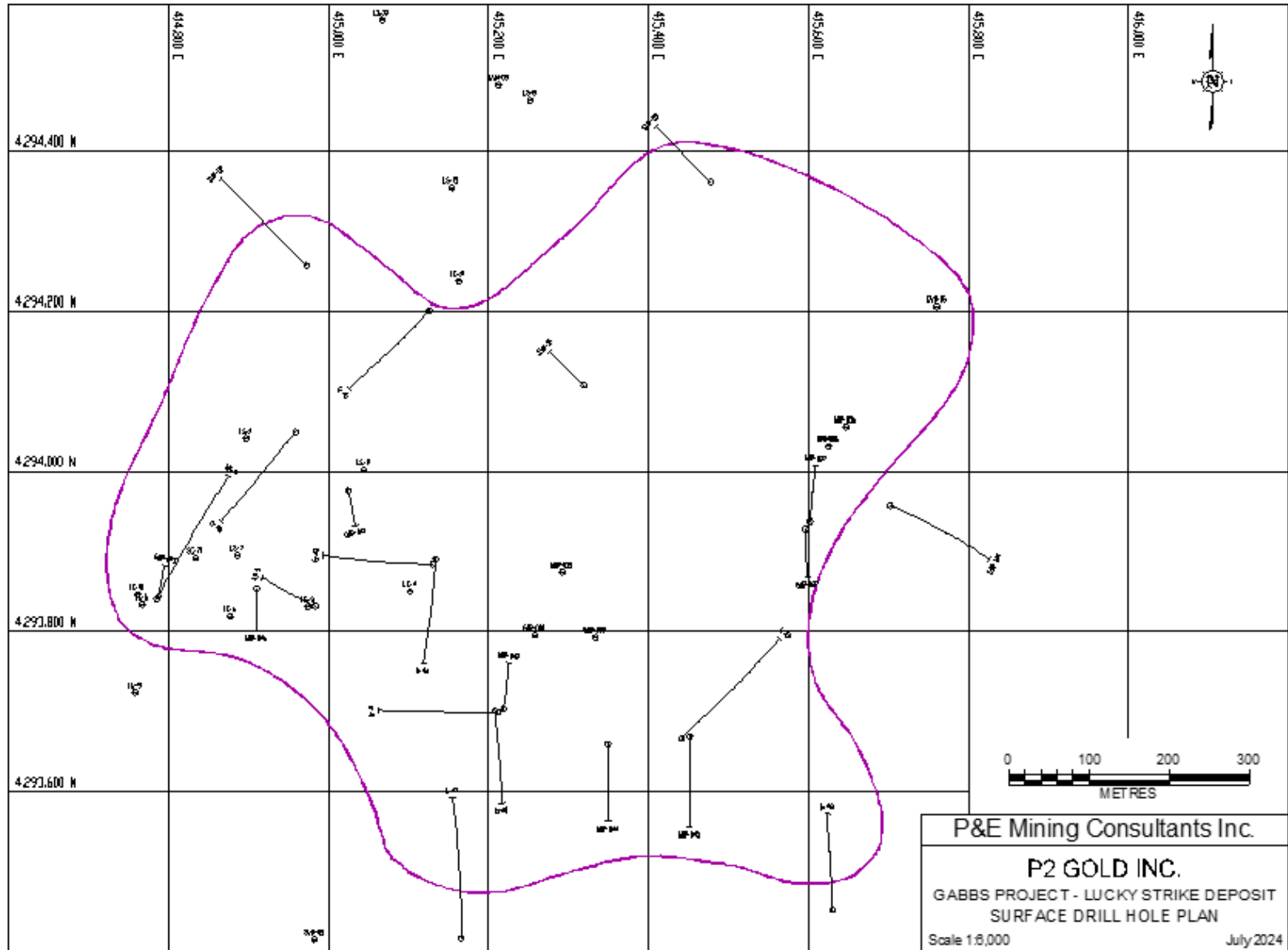

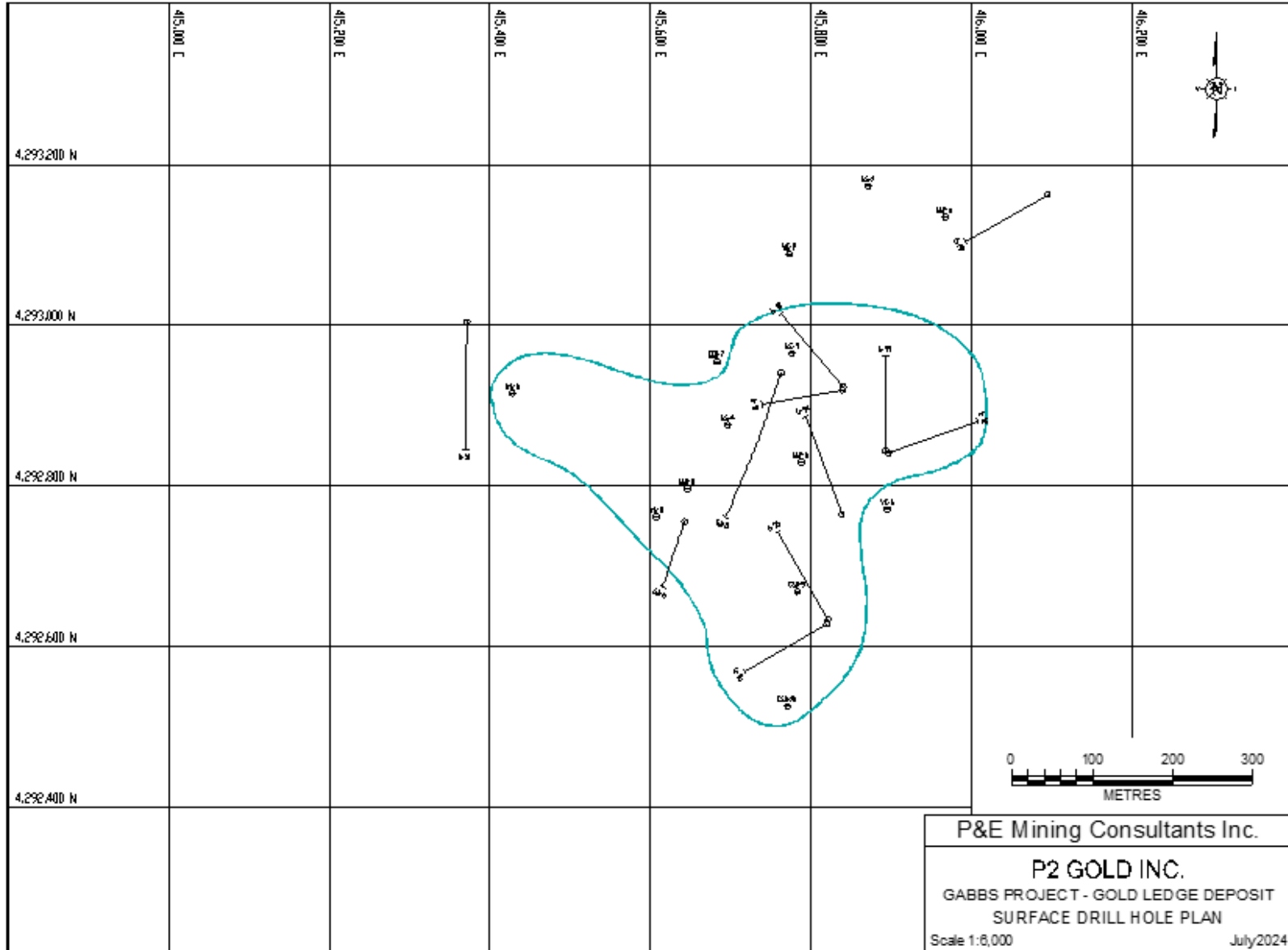

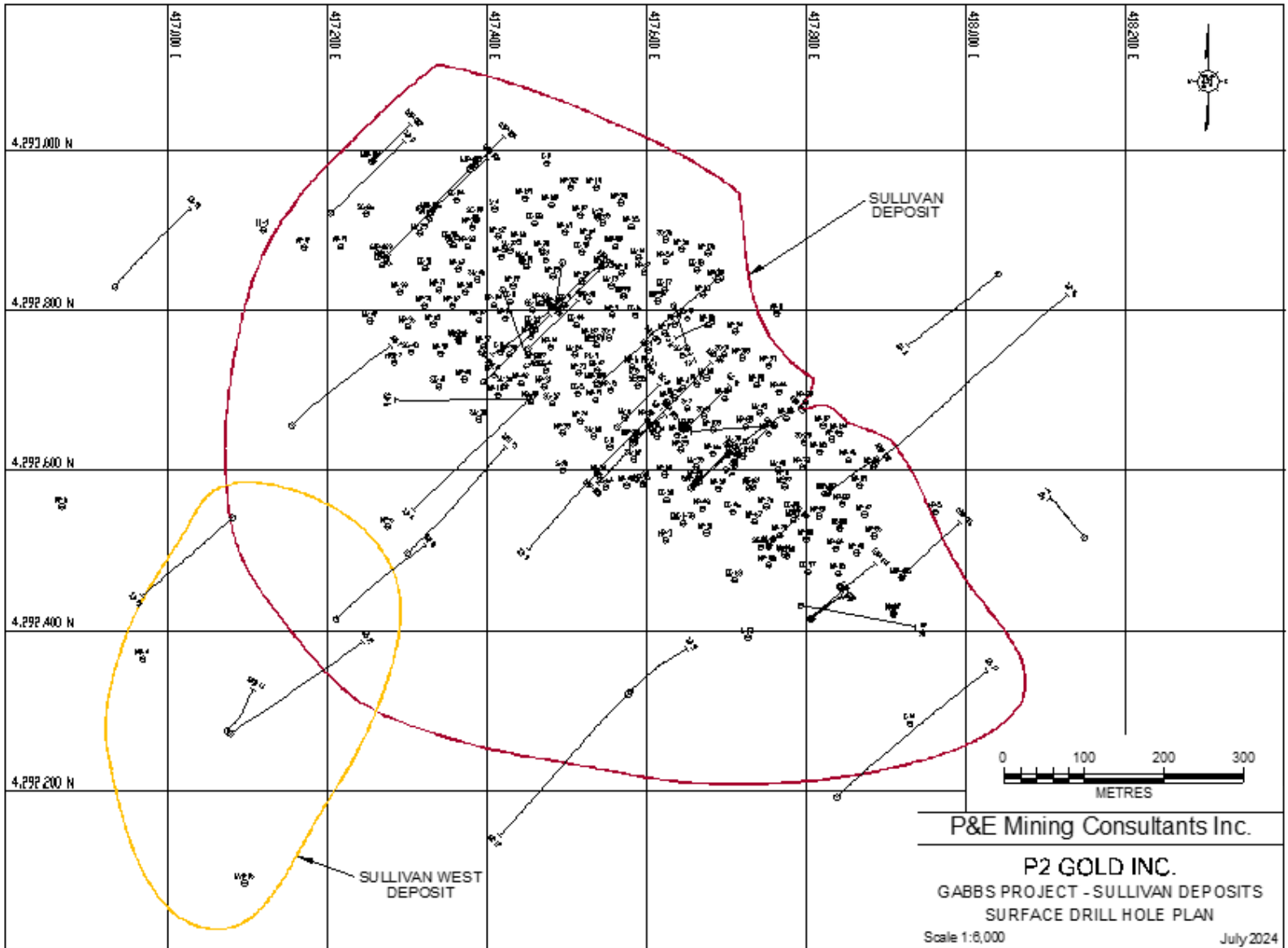

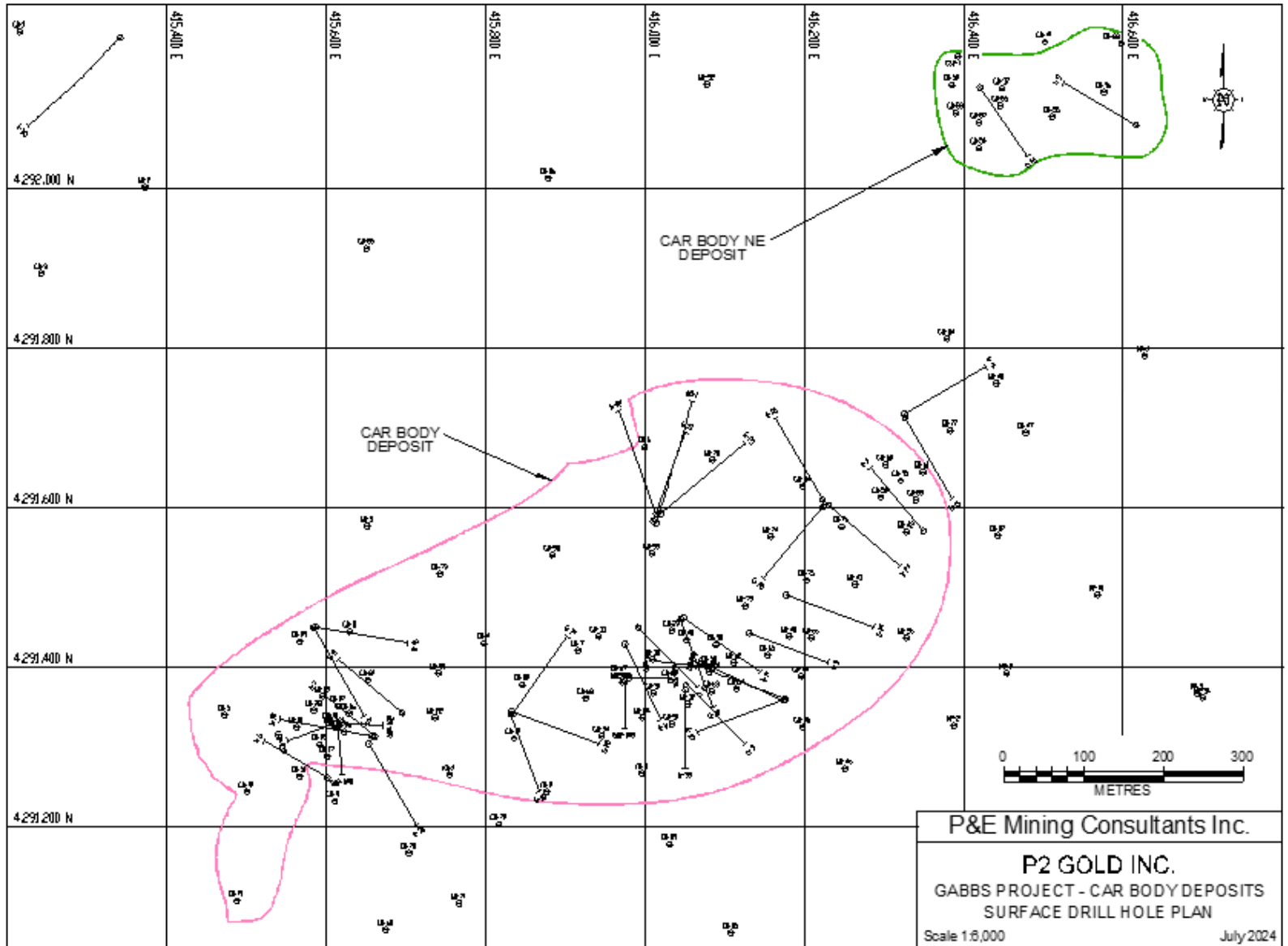

29.2 Appendix B - 3-D Domains

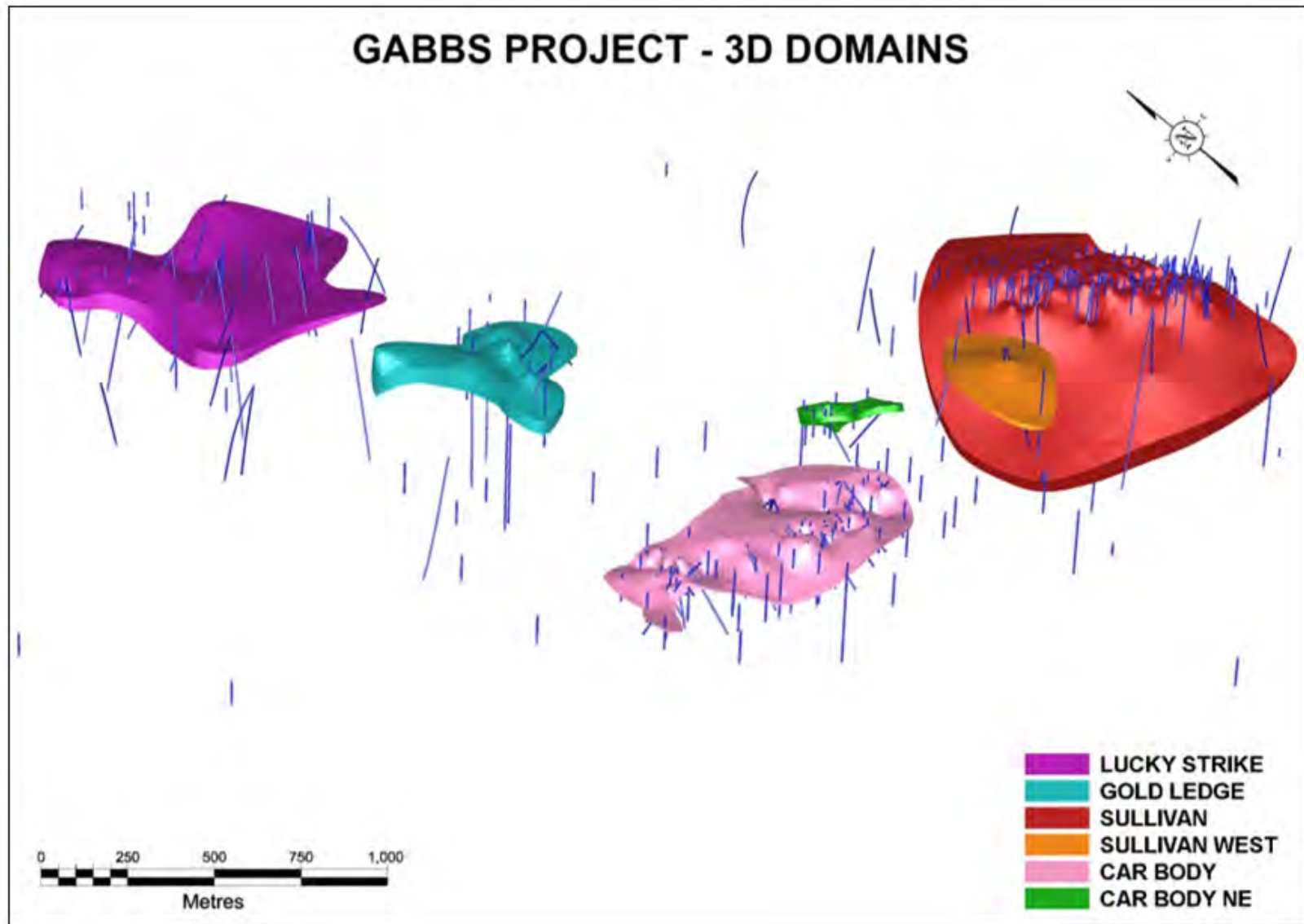

29.3 Appendix C - Block Model Plans

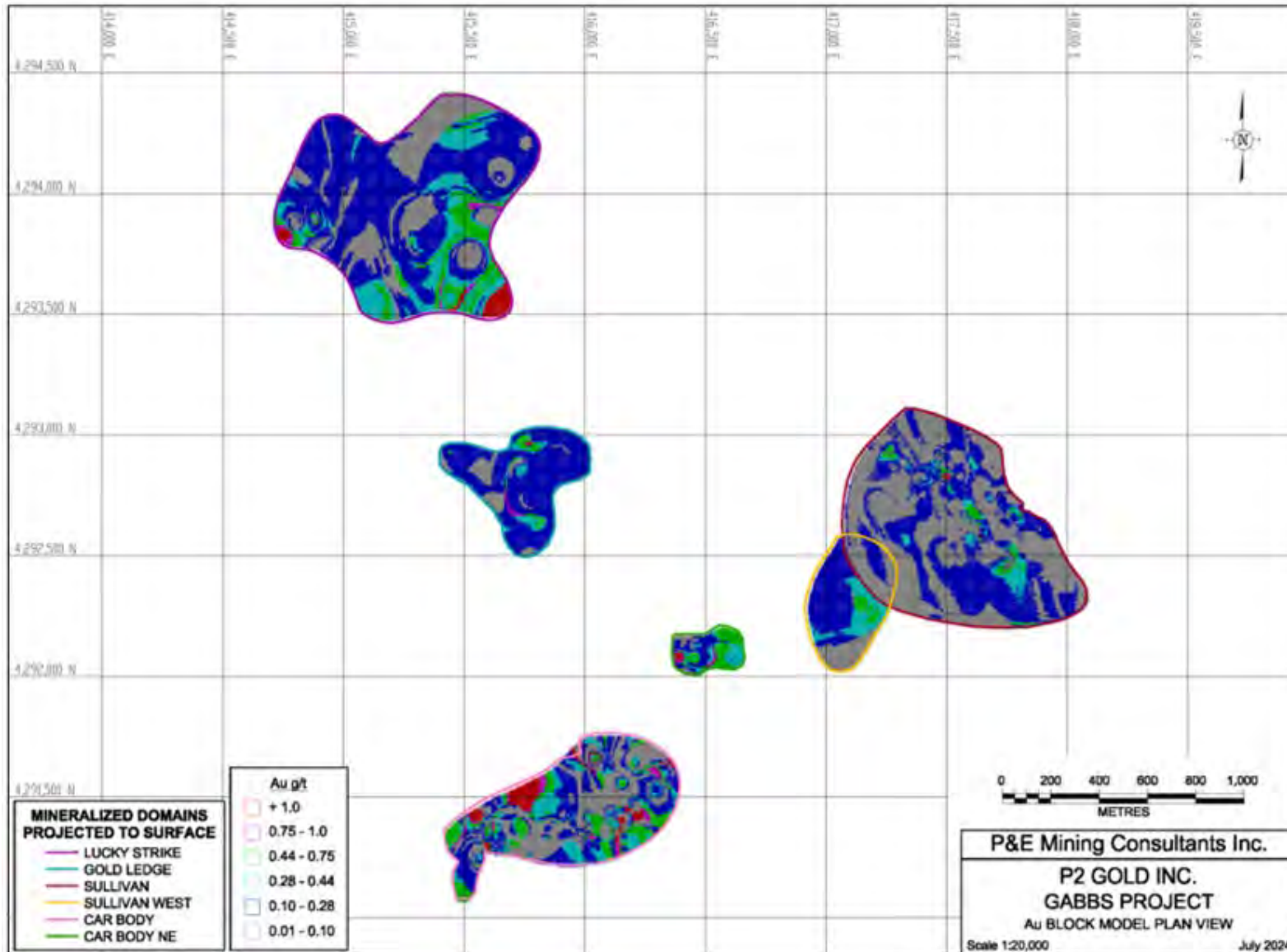

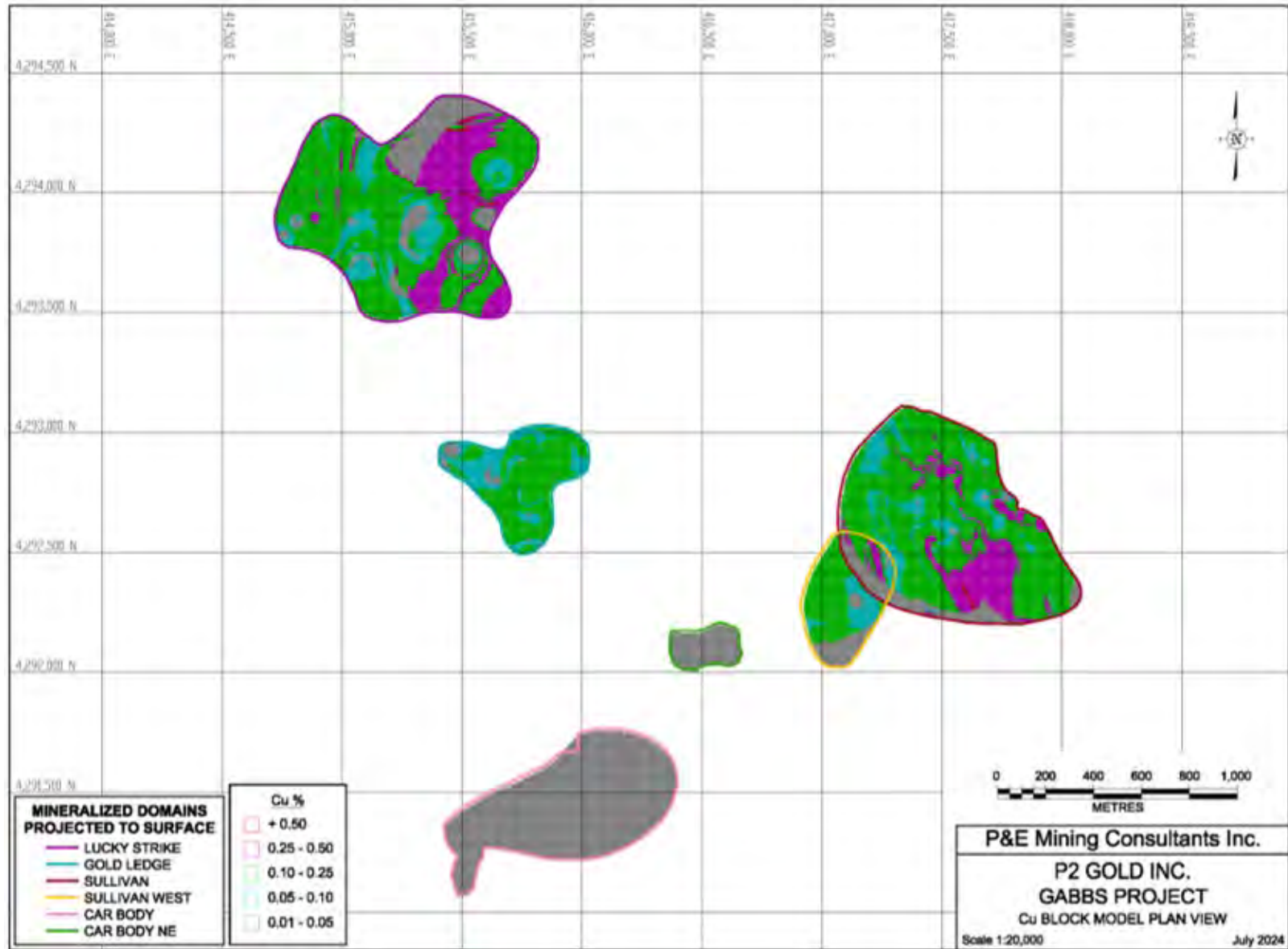

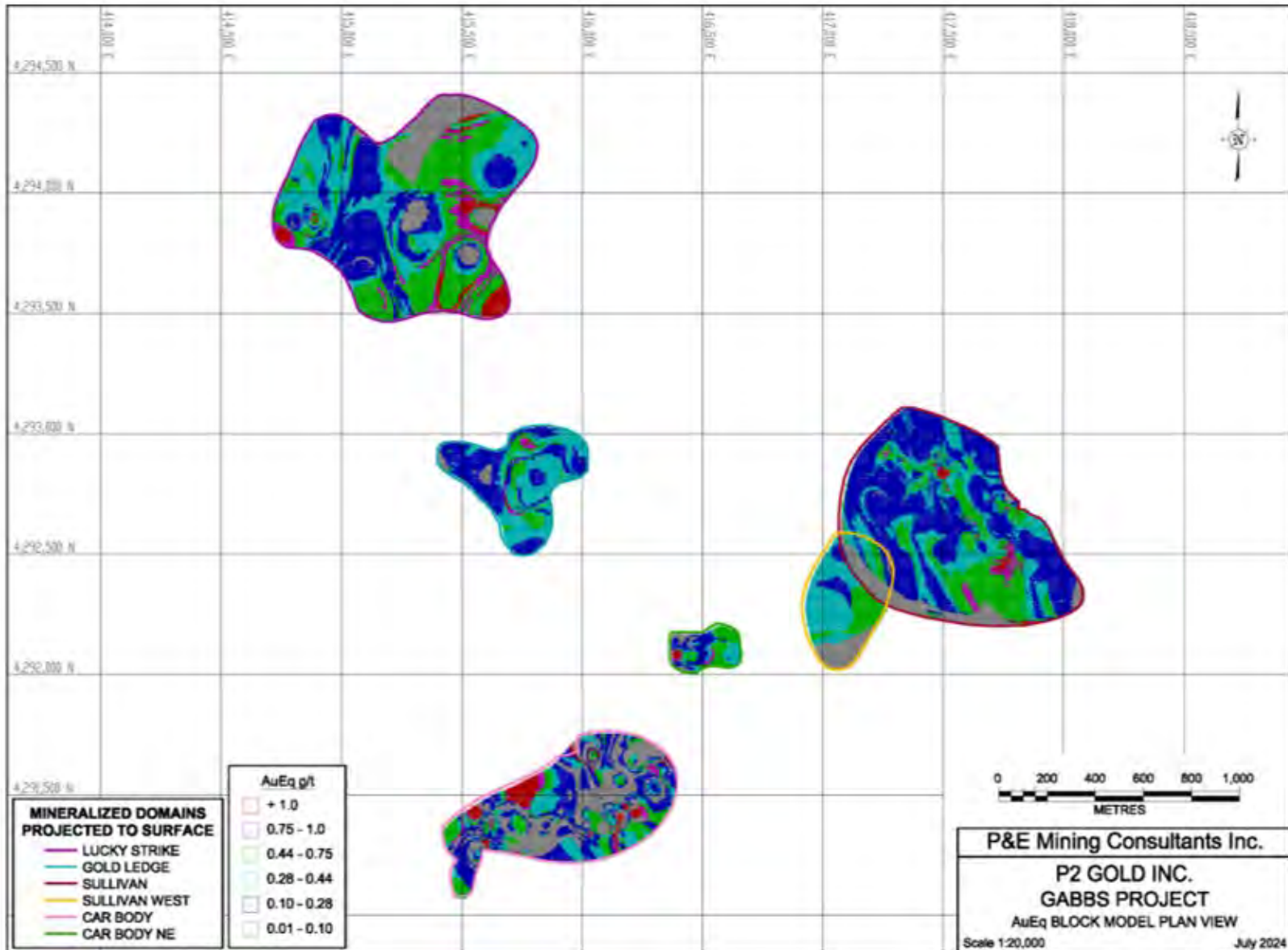

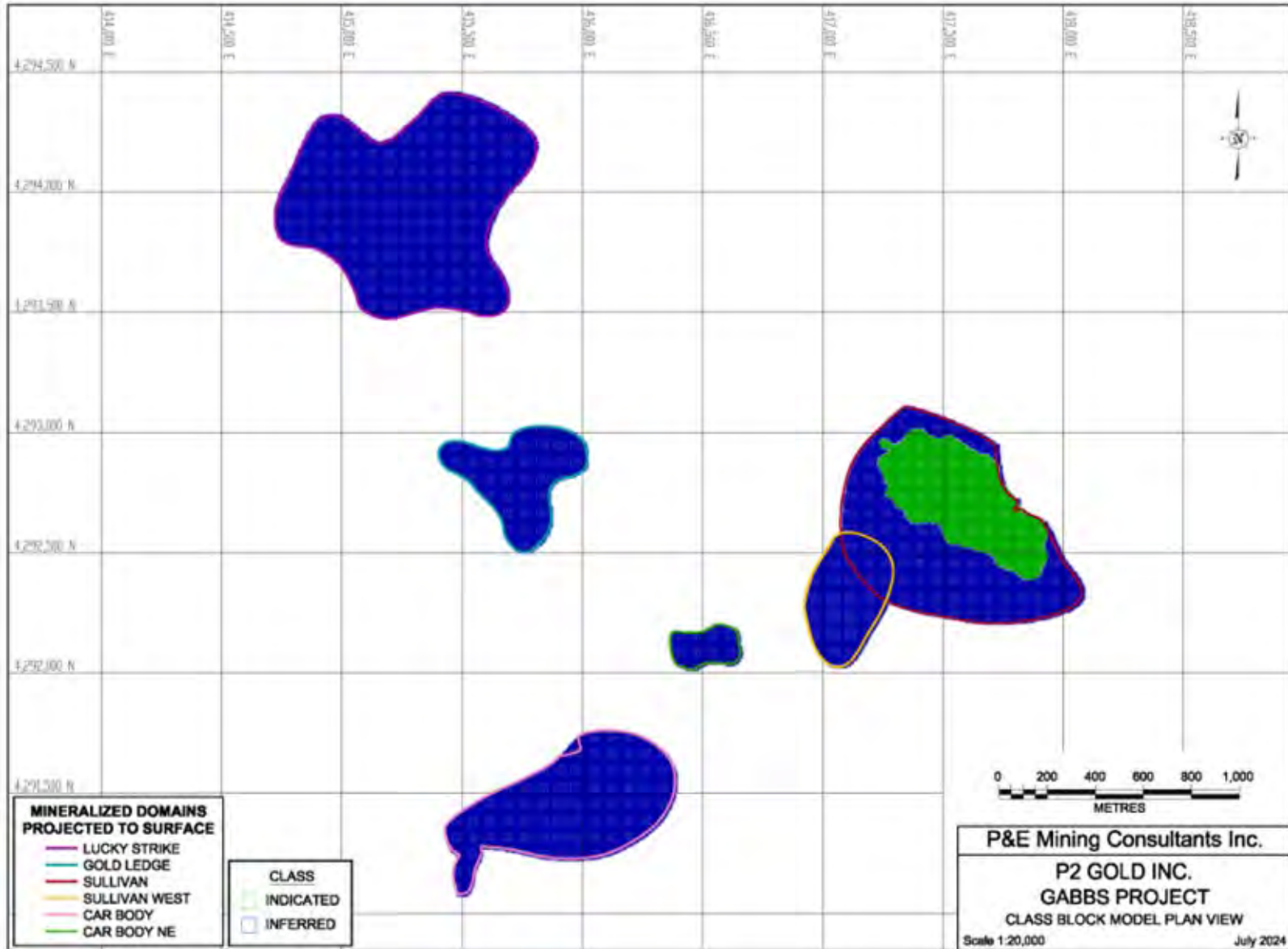

29.4 Appendix D - Optimized Pit Shells

GABBS PROJECT - OPTIMIZED PIT SHELLS

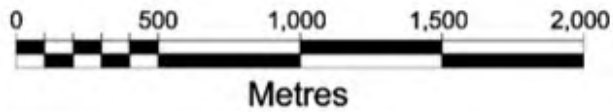
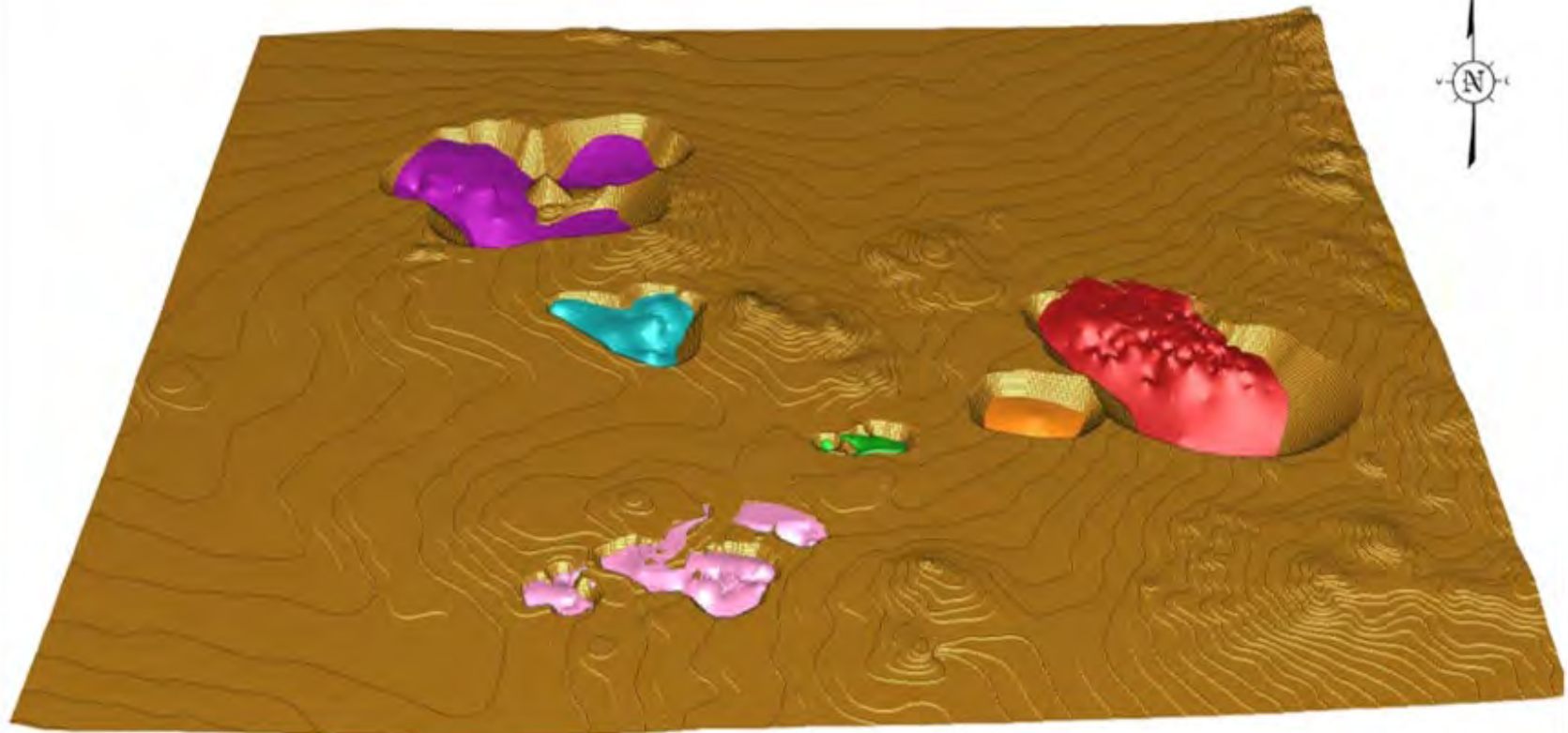

- LUCKY STRIKE
- GOLD LEDGE
- SULLIVAN
- SULLIVAN WEST
- CAR BODY
- CAR BODY NE

29.5 Appendix E – Gabbs Property Claims

The patented Sullivan lode mining claim, Patent No. 42614, Mineral Survey No. 2156, Assessor’s Parcel No. 000-013-91, containing 20.66 acres, more or less, located in Sections 28 and 29, T11N, R36E, MDM, Nye County, Nevada.

The following 543 unpatented lode mining claims located within Sections 2, 3, 4, 5 and 6 of partially surveyed T10N, R36E, Sections 13, 24, 25, 26, 35 and 36 of T11N, R35E, and Sections 7, 8, 9, 16, 17, 18, 19, 20, 21, 27, 28, 29, 30, 31, 32, 33 and 34 of T11N, R36E, MDM, Nye County, Nevada:

Claim Name	Serial Number	Legacy Serial Number	Date of Location	County Document Number	Amended Document Number
SUL # 1	NV101494402	NMC100233	8-18-1969	15013	16616
SUL # 2	NV101302519	NMC100234	8-18-1969	15014	16617
SUL # 3	NV101610256	NMC100235	8-18-1969	15015	16618
SUL # 4	NV101304562	NMC100236	8-18-1969	15016	16619
SUL # 5	NV101606484	NMC100237	8-18-1969	15017	16620
SUL # 6	NV101497344	NMC100238	8-18-1969	15018	16621
SUL # 7	NV101494602	NMC100239	8-18-1969	15019	
SUL # 8	NV101407093	NMC100240	8-18-1969	15020	
SUL # 9	NV101340710	NMC100241	8-18-1969	15021	
SUL # 10	NV101401379	NMC100242	8-18-1969	15022	
SUL # 11	NV101507049	NMC100243	8-18-1969	15023	
SUL # 12	NV101402561	NMC100244	8-18-1969	15024	
SUL # 13	NV101490623	NMC100245	8-18-1969	15025	
SUL # 14	NV101403980	NMC100246	8-18-1969	15026	
SUL # 15	NV101495731	NMC100247	8-18-1969	15027	
SUL # 16	NV101479676	NMC100248	8-18-1969	15028	
SUL # 17	NV101506823	NMC100249	8-18-1969	15029	
SUL # 18	NV101349647	NMC100250	8-18-1969	15030	
SUL # 19	NV101452653	NMC100251	8-18-1969	15031	
SUL # 20	NV101347351	NMC100252	8-18-1969	15032	
SUL # 21	NV101457602	NMC100253	8-18-1969	15033	
SUL # 22	NV101498338	NMC100254	8-18-1969	15034	
SUL # 23	NV101603156	NMC100255	8-18-1969	15035	
SUL # 24	NV101521077	NMC100256	8-18-1969	15036	
SUL # 25	NV101603398	NMC100257	8-18-1969	15037	
SUL # 26	NV101609461	NMC100258	8-18-1969	15038	
SUL # 27	NV101491533	NMC100259	8-18-1969	15039	

Claim Name	Serial Number	Legacy Serial Number	Date of Location	County Document Number	Amended Document Number
SUL # 28	NV101610159	NMC100260	8-18-1969	15040	
SUL # 29	NV101496500	NMC100261	8-18-1969	15041	
SUL # 30	NV101602977	NMC100262	8-18-1969	15042	
SUL # 31	NV101495448	NMC100263	8-18-1969	15043	
SUL # 32	NV101300081	NMC100264	8-18-1969	15044	
SUL # 33	NV101602858	NMC100265	8-18-1969	15045	
SUL # 34	NV101302543	NMC100266	8-18-1969	15046	
SUL # 35	NV101607828	NMC100267	8-18-1969	15047	
SUL # 36	NV101492219	NMC100268	8-18-1969	15048	
SUL # 37	NV101504634	NMC100269	8-18-1969	15049	
SUL # 38	NV101403303	NMC100270	8-18-1969	15050	
SUL # 39	NV101340719	NMC100271	8-18-1969	15051	
BAGGS NO 1	NV101367019	NMC842251	11-21-2002	548390	
BAGGS NO 2	NV101367020	NMC842252	11-21-2002	548391	
BAGGS NO 3	NV101367021	NMC842253	11-21-2002	548392	
BAGGS NO 4	NV101367022	NMC842254	11-21-2002	548393	
BAGGS NO 5	NV101367023	NMC842255	11-21-2002	548394	
BAGGS NO 6	NV101367024	NMC842256	11-21-2002	548395	
BAGGS NO 7	NV101367025	NMC842257	11-21-2002	548396	
BAGGS NO 8	NV101367026	NMC842258	11-21-2002	548397	
BAGGS NO 9	NV101367027	NMC842259	11-20-2002	548398	
BAGGS NO 10	NV101367028	NMC842260	11-20-2002	548399	
BAGGS NO 11	NV101367029	NMC842261	11-20-2002	548400	
BAGGS NO 12	NV101367030	NMC842262	11-20-2002	548401	
BAGGS NO 13	NV101367031	NMC842263	11-20-2002	548402	
BAGGS NO 14	NV101367876	NMC842264	11-20-2002	548403	
BAGGS NO 15	NV101367877	NMC842265	11-20-2002	548404	
BAGGS NO 16	NV101367878	NMC842266	11-20-2002	548405	
BAGGS NO 17	NV101367879	NMC842267	11-20-2002	548406	
BAGGS NO 18	NV101367880	NMC842268	11-20-2002	548407	
BAGGS NO 19	NV101367881	NMC842269	11-20-2002	548408	
BAGGS NO 20	NV101367882	NMC842270	11-20-2002	548409	
BAGGS NO 21	NV101367883	NMC842271	11-20-2002	548410	
BAGGS NO 22	NV101367884	NMC842272	11-20-2002	548411	
BAGGS NO 23	NV101367885	NMC842273	11-20-2002	548412	
BAGGS NO 24	NV101367886	NMC842274	11-20-2002	548413	
BAGGS NO 25	NV101367887	NMC842275	11-20-2002	548414	
BAGGS NO 26	NV101367888	NMC842276	11-20-2002	548415	

Claim Name	Serial Number	Legacy Serial Number	Date of Location	County Document Number	Amended Document Number
BAGGS NO 27	NV101367889	NMC842277	11-20-2002	548416	
BAGGS NO 28	NV101367890	NMC842278	11-21-2002	548417	
BAGGS NO 29	NV101367891	NMC842279	11-21-2002	548418	
BAGGS NO 30	NV101367892	NMC842280	11-21-2002	548419	
BAGGS NO 31	NV101367893	NMC842281	11-21-2002	548420	
BAGGS NO 32	NV101367894	NMC842282	11-21-2002	548421	
BAGGS NO 33	NV101367895	NMC842283	11-21-2002	548422	
BAGGS NO 34	NV101367896	NMC842284	11-21-2002	548423	
BAGGS NO 35	NV101368739	NMC842285	11-21-2002	548424	
BAGGS NO 36	NV101368740	NMC842286	11-21-2002	548425	
BAGGS NO 37	NV101368741	NMC842287	11-21-2002	548426	
BAGGS NO 38	NV101368742	NMC842288	11-21-2002	548427	
BAGGS NO 39	NV101368743	NMC842289	11-21-2002	548428	
BAGGS NO 40	NV101368744	NMC842290	11-21-2002	548429	
BAGGS NO 41	NV101368745	NMC842291	11-21-2002	548430	
BAGGS NO 42	NV101368746	NMC842292	11-21-2002	548431	
BAGGS NO 43	NV101368747	NMC842293	11-21-2002	548432	
BAGGS NO 44	NV101368748	NMC842294	11-21-2002	548433	
BAGGS NO 45	NV101368749	NMC842295	11-21-2002	548434	
BAGGS NO 46	NV101368750	NMC842296	11-21-2002	548435	
BAGGS NO 47	NV101368751	NMC842297	11-21-2002	548436	
BAGGS NO 48	NV101368752	NMC842298	11-21-2002	548437	
BAGGS NO 49	NV101368753	NMC842299	11-21-2002	548438	
BAGGS NO 50	NV101368754	NMC842300	11-21-2002	548439	
BAGGS NO 51	NV101368755	NMC842301	11-21-2002	548440	
BAGGS NO 52	NV101368756	NMC842302	11-21-2002	548441	
BAGGS NO 53	NV101368757	NMC842303	11-21-2002	548442	
BAGGS NO 54	NV101368758	NMC842304	11-21-2002	548443	
BAGGS NO 55	NV101368759	NMC842305	11-21-2002	548444	
BAGGS NO 56	NV101369574	NMC842306	11-21-2002	548445	
BAGGS NO 57	NV101369575	NMC842307	11-21-2002	548446	
BAGGS NO 58	NV101369576	NMC842308	11-21-2002	548447	
BAGGS NO 59	NV101369577	NMC842309	11-21-2002	548448	
BAGGS NO 60	NV101369578	NMC842310	11-21-2002	548449	
BAGGS NO 61	NV101369579	NMC842311	11-21-2002	548450	
BAGGS NO 62	NV101369580	NMC842312	11-21-2002	548451	
BAGGS NO 63	NV101369581	NMC842313	11-21-2002	548452	
BAGGS NO 64	NV101369582	NMC842314	11-21-2002	548453	

Claim Name	Serial Number	Legacy Serial Number	Date of Location	County Document Number	Amended Document Number
BAGGS NO 65	NV101369583	NMC842315	11-21-2002	548454	
BAGGS NO 66	NV101369601	NMC842316	11-21-2002	548455	
BAGGS NO 67	NV101369602	NMC842317	11-21-2002	548456	
BAGGS NO 68	NV101369603	NMC842318	11-21-2002	548457	
BAGGS NO 69	NV101369604	NMC842319	11-21-2002	548458	
BAGGS NO 70	NV101369605	NMC842320	11-21-2002	548459	
BAGGS NO 71	NV101369606	NMC842321	11-21-2002	548460	
BAGGS NO 72	NV101369607	NMC842322	11-21-2002	548461	
BAGGS NO 73	NV101369608	NMC842323	11-21-2002	548462	
BAGGS NO 74	NV101369609	NMC842324	11-21-2002	548463	
BAGGS NO 75	NV101369610	NMC842325	11-21-2002	548464	
BAGGS NO 76	NV101369611	NMC842326	11-21-2002	548465	
BAGGS NO 77	NV101517167	NMC842327	11-21-2002	548466	
BAGGS NO 78	NV101517168	NMC842328	11-21-2002	548467	
BAGGS NO 79	NV101517169	NMC842329	11-21-2002	548468	
BAGGS NO 80	NV101517170	NMC842330	11-21-2002	548469	
BAGGS NO 81	NV101517171	NMC842331	11-21-2002	548470	
BAGGS NO 82	NV101517172	NMC842332	11-21-2002	548471	
BAGGS NO 83	NV101517173	NMC842333	11-21-2002	548472	
BAGGS NO 84	NV101517174	NMC842334	11-21-2002	548473	
BAGGS NO 85	NV101517175	NMC842335	11-21-2002	548474	
BAGGS NO 86	NV101517176	NMC842336	11-21-2002	548475	
BAGGS NO 87	NV101517177	NMC842337	11-21-2002	548476	
BAGGS NO 88	NV101517178	NMC842338	11-21-2002	548477	
BAGGS NO 89	NV101517179	NMC842339	11-21-2002	548478	
BAGGS NO 90	NV101517180	NMC842340	11-21-2002	548479	
BAGGS NO 91	NV101517181	NMC842341	11-21-2002	548480	
BAGGS NO 92	NV101517201	NMC842342	11-21-2002	548481	
BAGGS NO 93	NV101517202	NMC842343	11-21-2002	548482	
BAGGS NO 94	NV101517203	NMC842344	11-21-2002	548483	
BAGGS NO 95	NV101517204	NMC842345	11-21-2002	548484	
BAGGS NO 96	NV101517205	NMC842346	11-21-2002	548485	
BAGGS NO 97	NV101517206	NMC842347	11-21-2002	548486	
BAGGS NO 98	NV101518044	NMC842348	11-21-2002	548487	
BAGGS NO 99	NV101518045	NMC842349	11-21-2002	548488	
BAGGS NO 100	NV101518046	NMC842350	11-21-2002	548489	
BAGGS NO 101	NV101518047	NMC842351	11-21-2002	548490	
BAGGS NO 102	NV101518048	NMC842352	11-21-2002	548491	

Claim Name	Serial Number	Legacy Serial Number	Date of Location	County Document Number	Amended Document Number
BAGGS NO 103	NV101518049	NMC842353	11-21-2002	548492	
BAGGS NO 104	NV101518050	NMC842354	11-22-2002	548493	
BAGGS NO 105	NV101518051	NMC842355	11-22-2002	548494	
BAGGS NO 106	NV101518052	NMC842356	11-22-2002	548495	
BAGGS NO 107	NV101518053	NMC842357	11-22-2002	548496	
BAGGS NO 108	NV101518054	NMC842358	11-22-2002	548497	
BAGGS NO 109	NV101518055	NMC842359	11-22-2002	548498	
BAGGS NO 110	NV101518056	NMC842360	11-22-2002	548499	
BAGGS NO 111	NV101518057	NMC842361	11-22-2002	548500	
BAGGS NO 112	NV101518058	NMC842362	11-22-2002	548501	
BAGGS NO 113	NV101518059	NMC842363	11-22-2002	548502	
BAGGS NO 114	NV101518060	NMC842364	11-22-2002	548503	
BAGGS NO 115	NV101518061	NMC842365	11-21-2002	548504	
BAGGS NO 116	NV101518062	NMC842366	11-21-2002	548505	
BAGGS NO 117	NV101518063	NMC842367	11-21-2002	548506	
BAGGS NO 118	NV101518064	NMC842368	11-21-2002	548507	
BAGGS NO 119	NV101518844	NMC842369	11-21-2002	548508	
BAGGS NO 120	NV101518845	NMC842370	11-21-2002	548509	
BAGGS NO 121	NV101518846	NMC842371	11-21-2002	548510	
BAGGS NO 122	NV101518847	NMC842372	11-21-2002	548511	
BAGGS NO 123	NV101518848	NMC842373	11-21-2002	548512	
BAGGS NO 124	NV101518849	NMC842374	11-21-2002	548513	
BAGGS NO 125	NV101518850	NMC842375	11-21-2002	548514	
BAGGS NO 126	NV101518851	NMC842376	11-21-2002	548515	
BAGGS NO 127	NV101518852	NMC842377	11-21-2002	548516	
BAGGS NO 128	NV101518853	NMC842378	11-21-2002	548517	
BAGGS NO 129	NV101518854	NMC842379	11-21-2002	548518	
BAGGS NO 130	NV101518855	NMC842380	11-21-2002	548519	
BAGGS NO 131	NV101518856	NMC842381	11-21-2002	548520	
BAGGS NO 132	NV101518857	NMC842382	11-21-2002	548521	
BAGGS NO 133	NV101518858	NMC842383	11-21-2002	548522	
BAGGS NO 134	NV101518859	NMC842384	11-20-2002	548523	
BAGGS NO 135	NV101518860	NMC842385	11-20-2002	548524	
BAGGS NO 136	NV101518861	NMC842386	11-20-2002	548525	
BAGGS NO 137	NV101518862	NMC842387	11-20-2002	548526	
BAGGS NO 138	NV101518863	NMC842388	11-20-2002	548527	
BAGGS NO 139	NV101518864	NMC842389	11-20-2002	548528	
BAGGS NO 140	NV101519673	NMC842390	11-20-2002	548529	

Claim Name	Serial Number	Legacy Serial Number	Date of Location	County Document Number	Amended Document Number
BAGGS NO 141	NV101519674	NMC842391	11-20-2002	548530	
BAGGS NO 142	NV101519675	NMC842392	11-20-2002	548531	
BAGGS NO 143	NV101519676	NMC842393	11-20-2002	548532	
BAGGS NO 144	NV101519677	NMC842394	11-20-2002	548533	
BAGGS NO 145	NV101519678	NMC842395	11-20-2002	548534	
BAGGS NO 146	NV101519679	NMC842396	11-20-2002	548535	
BAGGS NO 147	NV101519680	NMC842397	11-20-2002	548536	
BAGGS NO 148	NV101519681	NMC842398	11-21-2002	548537	
BAGGS NO 149	NV101519682	NMC842399	11-21-2002	548538	
BAGGS NO 150	NV101519683	NMC842400	11-21-2002	548539	
BAGGS NO 151	NV101519684	NMC842401	11-21-2002	548540	
BAGGS NO 152	NV101519685	NMC842402	11-21-2002	548541	
BAGGS NO 153	NV101519686	NMC842403	11-21-2002	548542	
BAGGS NO 154	NV101519687	NMC842404	11-21-2002	548543	
BAGGS NO 155	NV101519688	NMC842405	11-22-2002	548544	
BAGGS NO 156	NV101519689	NMC842406	11-22-2002	548545	
BAGGS NO 157	NV101519690	NMC842407	11-22-2002	548546	
BAGGS NO 158	NV101519691	NMC842408	11-22-2002	548547	
BAGGS NO 159	NV101519692	NMC842409	11-22-2002	548548	
BAGGS NO 160	NV101519693	NMC842410	11-22-2002	548549	
BAGGS NO 161	NV101360475	NMC842411	11-21-2002	548550	
BAGGS NO 162	NV101360476	NMC842412	11-21-2002	548551	
BAGGS NO 163	NV101627934	NMC865476	2-29-2004	586392	610588
BAGGS 164	NV101311148	NMC952623	3-27-2007	683624	
BAGGS 165	NV101373759	NMC952624	3-27-2007	683625	
BAGGS 166	NV101311147	NMC952625	3-27-2007	683626	
BAGGS 167	NV101373760	NMC952626	3-27-2007	683627	
BAGGS 168	NV101373761	NMC952627	3-27-2007	683628	
BAGGS 169	NV101373762	NMC952628	3-27-2007	683629	
BAGGS 170	NV101373763	NMC952629	3-27-2007	683630	
BAGGS 171	NV101373764	NMC952630	3-27-2007	683631	
BAGGS 172	NV101373765	NMC952631	3-27-2007	683632	
BAGGS 173	NV101373766	NMC952632	3-27-2007	683633	
BAGGS 174	NV101373767	NMC952633	3-27-2007	683634	
BAGGS 175	NV101373768	NMC952634	3-27-2007	683635	
BAGGS 176	NV101373769	NMC952635	3-27-2007	683636	
BAGGS 177	NV101373770	NMC952636	3-27-2007	683637	
BAGGS 178	NV101373771	NMC952637	3-27-2007	683638	

Claim Name	Serial Number	Legacy Serial Number	Date of Location	County Document Number	Amended Document Number
BAGGS 179	NV101373772	NMC952638	3-27-2007	683639	
BAGGS 180	NV101373773	NMC952639	3-27-2007	683640	
BAGGS 181	NV101373774	NMC952640	3-27-2007	683641	
BAGGS 182	NV101373775	NMC952641	3-27-2007	683642	
BAGGS 183	NV101373776	NMC952642	3-27-2007	683643	
BAGGS 184	NV101373777	NMC952643	3-27-2007	683644	
BAGGS 185	NV101373778	NMC952644	3-27-2007	683645	
BAGGS 186	NV101373779	NMC952645	3-27-2007	683646	
BAGGS 187	NV101374517	NMC952646	3-27-2007	683647	
BAGGS 188	NV101374518	NMC952647	3-27-2007	683648	
BAGGS 189	NV101374519	NMC952648	3-27-2007	683649	
BAGGS 190	NV101374520	NMC952649	3-27-2007	683650	
BAGGS 191	NV101374521	NMC952650	3-27-2007	683651	
BAGGS 192	NV101374522	NMC952651	3-28-2007	683652	
BAGGS 193	NV101374523	NMC952652	3-28-2007	683653	
BAGGS 194	NV101374524	NMC952653	3-28-2007	683654	
BAGGS 195	NV101374525	NMC952654	3-28-2007	683655	
BAGGS 196	NV101374526	NMC952655	3-28-2007	683656	
BAGGS 197	NV101374527	NMC952656	3-28-2007	683657	
BAGGS 198	NV101374528	NMC952657	3-28-2007	683658	
BAGGS 199	NV101374529	NMC952658	3-28-2007	683659	
BAGGS 200	NV101374530	NMC952659	3-28-2007	683660	
BAGGS 201	NV101374531	NMC952660	3-28-2007	683661	
BAGGS 202	NV101374532	NMC952661	3-28-2007	683662	
BAGGS 203	NV101374533	NMC952662	3-28-2007	683663	
BAGGS 204	NV101374534	NMC952663	3-28-2007	683664	
BAGGS 205	NV101374535	NMC952664	3-28-2007	683665	
BAGGS 206	NV101374536	NMC952665	3-28-2007	683666	
BAGGS 207	NV101374537	NMC952666	3-28-2007	683667	
BAGGS 208	NV101375105	NMC952667	3-29-2007	683668	
BAGGS 209	NV101375106	NMC952668	3-29-2007	683669	
BAGGS 210	NV101375107	NMC952669	3-29-2007	683670	
BAGGS 211	NV101375108	NMC952670	3-29-2007	683671	
BAGGS 212	NV101375109	NMC952671	3-29-2007	683672	
BAGGS 213	NV101375110	NMC952672	3-29-2007	683673	
BAGGS 214	NV101375111	NMC952673	3-29-2007	683674	
BAGGS 215	NV101375112	NMC952674	3-29-2007	683675	
BAGGS 216	NV101375113	NMC952675	3-27-2007	683676	

Claim Name	Serial Number	Legacy Serial Number	Date of Location	County Document Number	Amended Document Number
BAGGS 217	NV101375114	NMC952676	3-27-2007	683677	
BAGGS 218	NV101375115	NMC952677	3-27-2007	683678	
BAGGS 219	NV101375116	NMC952678	3-27-2007	683679	
BAGGS 220	NV101375117	NMC952679	3-28-2007	683680	
BAGGS 221	NV101375118	NMC952680	3-28-2007	683681	
BAGGS 222	NV101375119	NMC952681	3-28-2007	683682	
BAGGS 223	NV101375120	NMC952682	3-28-2007	683683	
BAGGS 224	NV101375121	NMC952683	3-28-2007	683684	
BAGGS 225	NV101375122	NMC952684	3-28-2007	683685	
BAGGS 226	NV101375123	NMC952685	3-27-2007	683686	
BAGGS 227	NV101375124	NMC952686	3-27-2007	683687	
BAGGS 228	NV101375125	NMC952687	3-28-2007	683688	
BAGGS 229	NV101375838	NMC952688	3-27-2007	683689	
BAGGS 234	NV101368175	NMC968779	9-6-2007	696813	
BAGGS 235	NV101368176	NMC968780	9-6-2007	696814	
BAGGS 236	NV101368177	NMC968781	9-6-2007	696815	
BAGGS 237	NV101368178	NMC968782	9-6-2007	696816	
BAGGS 238	NV101368179	NMC968783	9-6-2007	696817	
BAGGS 239	NV101368180	NMC968784	9-6-2007	696818	
BAGGS 240	NV101368181	NMC968785	9-6-2007	696819	
BAGGS 241	NV101368182	NMC968786	9-6-2007	696820	
BAGGS 242	NV101368183	NMC968787	9-5-2007	696821	
BAGGS 243	NV101369024	NMC968788	9-5-2007	696822	
BAGGS 244	NV101369025	NMC968789	9-5-2007	696823	
BAGGS 245	NV101369026	NMC968790	9-5-2007	696824	
BAGGS 246	NV101369027	NMC968791	9-5-2007	696825	
BAGGS 247	NV101369028	NMC968792	9-5-2007	696826	
BAGGS 248	NV101369029	NMC968793	9-5-2007	696827	
BAGGS 249	NV101369030	NMC968794	9-5-2007	696828	
BAGGS 250	NV101369031	NMC968795	9-5-2007	696829	
BAGGS 251	NV101369032	NMC968796	9-5-2007	696830	
BAGGS 252	NV101369033	NMC968797	9-5-2007	696831	
BAGGS 253	NV101369034	NMC968798	9-5-2007	696832	
BAGGS 254	NV101369035	NMC968799	9-5-2007	696833	
BAGGS 255	NV101369036	NMC968800	9-5-2007	696834	
BAGGS 256	NV101369037	NMC968801	9-5-2007	696835	
BAGGS 257	NV101369038	NMC968802	9-5-2007	696836	
BAGGS 258	NV101369039	NMC968803	9-6-2007	696837	

Claim Name	Serial Number	Legacy Serial Number	Date of Location	County Document Number	Amended Document Number
BAGGS 259	NV101369040	NMC968804	9-6-2007	696838	
BAGGS 260	NV101369041	NMC968805	9-6-2007	696839	
BAGGS 261	NV101369042	NMC968806	9-6-2007	696840	
BAGGS 262	NV101369043	NMC968807	9-6-2007	696841	
BAGGS 263	NV101369044	NMC968808	9-6-2007	696842	
BAGGS 268	NV101369880	NMC968812	9-5-2007	696846	
BAGGS 269	NV101369881	NMC968813	9-5-2007	696847	
BAGGS 270	NV101369882	NMC968814	9-5-2007	696848	
BAGGS 271	NV101369883	NMC968815	9-5-2007	696849	
BAGGS 272	NV101369884	NMC968816	9-5-2007	696850	
BAGGS 273	NV101369885	NMC968817	9-5-2007	696851	
BAGGS 274	NV101369886	NMC968818	9-5-2007	696852	
BAGGS 275	NV101369887	NMC968819	9-5-2007	696853	
BAGGS 276	NV101369888	NMC968820	9-5-2007	696854	
BAGGS 277	NV101369889	NMC968821	9-5-2007	696855	
BAGGS 278	NV101369890	NMC968822	9-5-2007	696856	
BAGGS 279	NV101369891	NMC968823	9-5-2007	696857	
BAGGS 280	NV101369892	NMC968824	9-5-2007	696858	
BAGGS 415	NV101512192	NMC989001	4-30-2008	710088	
BAGGS 416	NV101512193	NMC989002	4-30-2008	710089	
BAGGS 417	NV101512194	NMC989003	4-30-2008	710090	
BAGGS 418	NV101512195	NMC989004	4-30-2008	710091	
BAGGS 419	NV101512196	NMC989005	4-30-2008	710092	
BAGGS 420	NV101512317	NMC989006	4-30-2008	710093	
BAGGS 421	NV101512318	NMC989007	4-30-2008	710094	
BAGGS 422	NV101512319	NMC989008	4-30-2008	710095	
BAGGS 423	NV101512320	NMC989009	4-30-2008	710096	
BAGGS 424	NV101512321	NMC989010	4-30-2008	710097	
BAGGS 425	NV101512322	NMC989011	4-30-2008	710098	
BAGGS 426	NV101512323	NMC989012	4-30-2008	710099	
BAGGS 427	NV101512324	NMC989013	4-30-2008	710100	
BAGGS 428	NV101512325	NMC989014	4-30-2008	710101	
BAGGS 429	NV101512326	NMC989015	4-30-2008	710102	
BAGGS 430	NV101512327	NMC989016	4-30-2008	710103	
BAGGS 431	NV101512328	NMC989017	4-30-2008	710104	
BAGGS 432	NV101512329	NMC989018	4-30-2008	710105	
BAGGS 433	NV101512330	NMC989019	4-30-2008	710106	
BAGGS 434	NV101513478	NMC989020	4-30-2008	710107	

Claim Name	Serial Number	Legacy Serial Number	Date of Location	County Document Number	Amended Document Number
BAGGS 435	NV101513479	NMC989021	4-30-2008	710108	
BAGGS 436	NV101513480	NMC989022	4-30-2008	710109	
BAGGS 437	NV101513481	NMC989023	4-30-2008	710110	
BAGGS 438	NV101513482	NMC989024	4-30-2008	710111	
BAGGS 439	NV101513483	NMC989025	4-30-2008	710112	
BAGGS 440	NV101513484	NMC989026	5-1-2008	710113	
BAGGS 441	NV101513485	NMC989027	5-1-2008	710114	
BAGGS 442	NV101513486	NMC989028	5-1-2008	710115	
BAGGS 443	NV101513487	NMC989029	5-1-2008	710116	
BAGGS 444	NV101513488	NMC989030	5-1-2008	710117	
BAGGS 446	NV101513489	NMC989032	5-1-2008	710119	
BAGGS 447	NV101513490	NMC989033	5-2-2008	710120	
BAGGS 448	NV101513491	NMC989034	5-2-2008	710121	
BAGGS 449	NV101513492	NMC989035	5-2-2008	710122	
BAGGS 450	NV101513493	NMC989036	5-2-2008	710123	
BAGGS 451	NV101513494	NMC989037	5-29-2008	710124	
BAGGS 453	NV101513495	NMC989039	5-29-2008	710126	
BAGGS 454	NV101513496	NMC989040	5-29-2008	710127	
BAGGS 455	NV101513497	NMC989041	5-29-2008	710128	
BAGGS 456	NV101513498	NMC989042	5-29-2008	710129	
SVM # 1	NV101651520	NMC1040665	3-21-2011	762523	
SVM # 2	NV101651521	NMC1040666	3-21-2011	762524	
SVM # 3	NV101651522	NMC1040667	3-21-2011	762525	
SVM # 4	NV101651523	NMC1040668	3-21-2011	762526	
GBS 1	NV105254636	-	7-7-2021	961863	
GBS 2	NV105254637	-	7-7-2021	961864	
GBS 3	NV105254638	-	7-7-2021	961865	
GBS 4	NV105254639	-	7-7-2021	961866	
GBS 5	NV105254640	-	7-7-2021	961867	
GBS 6	NV105254641	-	7-7-2021	961868	
GBS 7	NV105254642	-	7-7-2021	961869	
GBS 8	NV105254643	-	7-7-2021	961870	
GBS 9	NV105254644	-	7-7-2021	961871	
GBS 10	NV105254645	-	7-7-2021	961872	
GBS 11	NV105254646	-	7-7-2021	961873	
GBS 12	NV105254647	-	7-7-2021	961874	
GBS 13	NV105254648	-	7-7-2021	961875	
GBS 14	NV105254649	-	7-7-2021	961876	

Claim Name	Serial Number	Legacy Serial Number	Date of Location	County Document Number	Amended Document Number
GBS 15	NV105254650	-	7-7-2021	961877	
GBS 16	NV105254651	-	7-7-2021	961878	
GBS 17	NV105254652	-	7-7-2021	961879	
GBS 18	NV105254653	-	7-7-2021	961880	
GBS 19	NV105254654	-	7-7-2021	961881	
GBS 20	NV105254655	-	7-7-2021	961882	
GBS 21	NV105254656	-	7-7-2021	961883	
GBS 22	NV105254657	-	7-7-2021	961884	
GBS 23	NV105254658	-	7-7-2021	961885	
GBS 24	NV105254659	-	7-7-2021	961886	
GBS 25	NV105254660	-	7-7-2021	961887	
GBS 26	NV105254661	-	7-7-2021	961888	
GBS 27	NV105254662	-	7-7-2021	961889	
GBS 28	NV105254663	-	7-7-2021	961890	
GBS 29	NV105254664	-	7-7-2021	961891	
GBS 30	NV105254665	-	7-7-2021	961892	
GBS 31	NV105254666	-	7-7-2021	961893	
GBS 32	NV105254667	-	7-7-2021	961894	
GBS 33	NV105254668	-	7-7-2021	961895	
GBS 34	NV105254669	-	7-7-2021	961896	
GBS 35	NV105254670	-	7-7-2021	961897	
GBS 36	NV105254671	-	7-7-2021	961898	
GBS 37	NV105254672	-	7-7-2021	961899	
GBS 38	NV105254673	-	7-7-2021	961900	
GBS 39	NV105254674	-	7-7-2021	961901	
GBS 40	NV105254675	-	7-7-2021	961902	
GBS 41	NV105254676	-	7-6-2021	961903	
GBS 42	NV105254677	-	7-6-2021	961904	
GBS 43	NV105254678	-	7-6-2021	961905	
GBS 44	NV105254679	-	7-6-2021	961906	
GBS 45	NV105254680	-	7-6-2021	961907	
GBS 46	NV105254681	-	7-6-2021	961908	
GBS 47	NV105254682	-	7-6-2021	961909	
GBS 48	NV105254683	-	7-6-2021	961910	
GBS 49	NV105254684	-	7-6-2021	961911	
GBS 50	NV105254685	-	7-6-2021	961912	
GBS 51	NV105254686	-	7-6-2021	961913	
GBS 52	NV105254687	-	7-6-2021	961914	

Claim Name	Serial Number	Legacy Serial Number	Date of Location	County Document Number	Amended Document Number
GBS 53	NV105254688	-	7-6-2021	961915	
GBS 54	NV105254689	-	7-6-2021	961916	
GBS 55	NV105254690	-	7-6-2021	961917	
GBS 56	NV105254691	-	7-6-2021	961918	
GBS 57	NV105254692	-	7-6-2021	961919	
GBS 58	NV105254693	-	7-6-2021	961920	
GBS 59	NV105254694	-	7-6-2021	961921	
GBS 60	NV105254695	-	7-6-2021	961922	
GBS 61	NV105254696	-	7-6-2021	961923	
GBS 62	NV105254697	-	7-6-2021	961924	
GBS 63	NV105254698	-	7-6-2021	961925	
GBS 64	NV105254699	-	7-6-2021	961926	
GBS 65	NV105254700	-	7-6-2021	961927	
GBS 66	NV105254701	-	7-6-2021	961928	
GBS-67	NV105760795		2-4-2022	982809	
GBS-68	NV105760796		2-4-2022	982810	
GBS-69	NV105760797		2-4-2022	982811	
GBS-70	NV105760798		2-4-2022	982812	
GBS-71	NV105760799		2-4-2022	982813	
GBS-72	NV105760800		2-4-2022	982814	
GBS-73	NV105760801		2-4-2022	982815	
GBS-74	NV105760802		2-4-2022	982816	
GBS-75	NV105760803		2-4-2022	982817	
GBS-76	NV105760804		2-4-2022	982818	
GBS-77	NV105760805		2-4-2022	982819	
GBS-78	NV105760806		2-4-2022	982820	
GBS-79	NV105760807		2-4-2022	982821	
GBS-80	NV105760808		2-4-2022	982822	
GBS-81	NV105760809		2-4-2022	982823	
GBS-82	NV105760810		2-4-2022	982824	
GBS-83	NV105760811		2-4-2022	982825	
GBS-84	NV105760812		2-4-2022	982826	
GBS-85	NV105760813		2-4-2022	982827	
GBS-86	NV105760814		2-4-2022	982828	
GBS-87	NV105760815		2-4-2022	982829	
GBS-88	NV105760816		2-4-2022	982830	
GBS-89	NV105760817		2-4-2022	982831	
GBS-90	NV105760818		2-4-2022	982832	



Claim Name	Serial Number	Legacy Serial Number	Date of Location	County Document Number	Amended Document Number
GBS-91	NV105760819		2-4-2022	982833	
GBS-92	NV105760820		2-4-2022	982834	
GBS-93	NV105760821		2-4-2022	982835	
GBS-94	NV105760822		2-4-2022	982836	
GBS-95	NV105760823		2-4-2022	982837	
GBS-96	NV105760824		2-4-2022	982838	
GBS-97	NV105760825		2-4-2022	982839	
GBS-98	NV105760826		2-4-2022	982840	
GBS-99	NV105760827		2-4-2022	982841	
GBS-100	NV105760828		2-4-2022	982842	
GBS-101	NV105760829		2-4-2022	982843	
GBS-102	NV105760830		2-4-2022	982844	
GBS-103	NV105760831		2-4-2022	982845	
GBS-104	NV105760832		2-4-2022	982846	
GBS-105	NV105760833		2-4-2022	982847	
GBS-106	NV105760834		2-4-2022	982848	
GBS-107	NV105760835		2-4-2022	982849	
GBS-108	NV105760836		2-4-2022	982850	
GBS-109	NV105760837		2-4-2022	982851	
GBS-110	NV105760838		2-4-2022	982852	
GBS-111	NV105760839		2-4-2022	982853	
GBS-112	NV105760840		2-4-2022	982854	
GBS-113	NV105760841		2-4-2022	982855	
GBS-114	NV105760842		2-4-2022	982856	
GBS-115	NV105760843		2-4-2022	982857	
GBS-116	NV105760844		2-4-2022	982858	
GBS-117	NV105760845		2-4-2022	982859	
GBS-118	NV105760846		2-4-2022	982860	
GBS-119	NV105760847		2-4-2022	982861	
GBS-120	NV105760848		2-4-2022	982862	
GBS-121	NV105760849		2-4-2022	982863	
GBS-122	NV105760850		2-4-2022	982864	
GBS-123	NV105760851		2-4-2022	982865	
GBS-124	NV105760852		2-4-2022	982866	
GBS-125	NV105760853		2-4-2022	982867	
GBS-126	NV105760854		2-4-2022	982868	
GBS-127	NV105760855		2-4-2022	982869	
GBS-128	NV105760856		2-4-2022	982870	

Claim Name	Serial Number	Legacy Serial Number	Date of Location	County Document Number	Amended Document Number
GBS-129	NV105760857		2-4-2022	982871	
GBS-130	NV105760858		2-4-2022	982872	
GBS-131	NV105760859		2-4-2022	982873	
GBS-132	NV105760860		2-4-2022	982874	
GBS-133	NV105760861		2-4-2022	982875	
GBS-134	NV105760862		2-4-2022	982876	
GBS-135	NV105760863		2-4-2022	982877	
GBS-136	NV105760864		2-4-2022	982878	
GBS-137	NV105760865		2-4-2022	982879	
GBS-138	NV105760866		2-4-2022	982880	
GBS-139	NV105760867		2-4-2022	982881	
GBS-140	NV105760868		2-4-2022	982882	
GBS-141	NV105760869		2-3-2022	982883	
GBS-142	NV105760870		2-3-2022	982884	
GBS-143	NV105760871		2-3-2022	982885	
GBS-144	NV105760872		2-3-2022	982886	
GBS-145	NV105760873		2-3-2022	982887	
GBS-146	NV105760874		2-3-2022	982888	
GBS-147	NV105760875		2-3-2022	982889	
GBS-148	NV105760876		2-3-2022	982890	
GBS-149	NV105760877		2-3-2022	982891	
GBS-150	NV105760878		2-3-2022	982892	
GBS-151	NV105760879		2-3-2022	982893	
GBS-152	NV105760880		2-3-2022	982894	
GBS-153	NV105760881		2-3-2022	982895	
GBS-154	NV105760882		2-3-2022	982896	
GBS-155	NV105760883		2-3-2022	982897	
GBS-156	NV105760884		2-3-2022	982898	
GBS-157	NV105760885		2-3-2022	982899	
GBS-158	NV105760886		2-3-2022	982900	
GBS-159	NV105760887		2-3-2022	982901	
GBS-160	NV105760888		2-3-2022	982902	
GBS-161	NV105760889		2-3-2022	982903	
GBS-162	NV105760890		2-3-2022	982904	
GBS-163	NV105760891		2-3-2022	982905	
GBS-164	NV105760892		2-3-2022	982906	
GBS-165	NV105760893		2-3-2022	982907	
GBS-166	NV105760894		2-3-2022	982908	

Claim Name	Serial Number	Legacy Serial Number	Date of Location	County Document Number	Amended Document Number
GBS-167	NV105760895		2-3-2022	982909	
GBS-168	NV105760896		2-3-2022	982910	
GBS-169	NV105760897		2-3-2022	982911	
GBS-170	NV105760898		2-3-2022	982912	
GBS-171	NV105760899		2-3-2022	982913	
GBS-172	NV105760900		2-3-2022	982914	
GBS-173	NV105760901		2-3-2022	982915	
GBS-174	NV105760902		2-3-2022	982916	
GBS-175	NV105760903		2-3-2022	982917	
GBS-176	NV105760904		2-3-2022	982918	
GBS-177	NV105760905		2-3-2022	982919	
GBS-178	NV105760906		2-3-2022	982920	
GBS-179	NV105760907		2-3-2022	982921	
GBS-180	NV105760908		2-3-2022	982922	
GBS-181	NV105760909		2-3-2022	982923	
GBS-182	NV105760910		2-3-2022	982924	
GBS-183	NV105760911		2-3-2022	982925	
GBS-184	NV105760912		2-3-2022	982926	
GBS-185	NV105760913		2-3-2022	982927	
GBS-186	NV105760914		2-3-2022	982928	
GBS-187	NV105760915		2-3-2022	982929	
GBS-188	NV105760916		2-3-2022	982930	