



NI 43-101 Technical Report

San Andrés Mine, Department of Copán, Honduras

Aura Minerals Inc.

Prepared by:

SLR Consulting (Canada) Ltd.

SLR Project No.: 233.065242.00001

Effective Date:

December 31, 2024

Signature Date:

March 28, 2025

Revision: 1

Qualified Persons:

Benjamin Sanfurgo, ChMC (RM)

Eduardo Zamanillo, M.Sc., MBA, ChMC(RM)

Andrew P. Hampton, M.Sc., P.Eng.

Derek J. Riehm, M.A.Sc, P.Eng.

NI 43-101 Technical Report, San Andrés Mine, Department of Copán, Honduras

SLR Project No.: 233.065242.00001

Prepared by

SLR Consulting (Canada) Ltd.

55 University Ave., Suite 501

Toronto, ON M5J 2H7

for

Aura Minerals Inc.

Craigmuir Chambers, Road Town

Tortola VG1110

British Virgin Islands

Effective Date - December 31, 2024

Signature Date - March 28, 2025

Prepared by:

Benjamin Sanfurgo, ChMC (RM)

Eduardo Zamanillo, M.Sc., MBA, ChMC (RM)

Andrew P. Hampton, M.Sc., P.Eng.

Derek Riehm, M.A.Sc, P.Eng.

Peer Reviewed by:

Rosmery J. Cárdenas Barzola, P.Eng.

Antonio Hamilton Caires, FAusIMM CP (Min)

Deborah A. McCombe, P.Geo.

Approved by:

Project Manager

Antonio Hamilton Caires, FAusIMM CP (Min)

Project Director

David J.F. Smith, CEng



Table of Contents

1.0	Summary	1-1
1.1	Executive Summary	1-1
1.2	Economic Analysis	1-9
1.3	Technical Summary	1-9
2.0	Introduction	2-1
2.1	Sources of Information	2-1
2.2	List of Abbreviations	2-3
3.0	Reliance on Other Experts	3-1
4.0	Property Description and Location	4-1
4.1	Location	4-1
4.2	Land Tenure	4-4
4.3	Encumbrances	4-6
4.4	Royalties	4-6
4.5	Other Significant Factors and Risks	4-7
5.0	Accessibility, Climate, Local Resources, Infrastructure and Physiography	5-1
5.1	Accessibility	5-1
5.2	Climate	5-1
5.3	Local Resources	5-3
5.4	Infrastructure	5-4
5.5	Physiography	5-5
6.0	History	6-1
6.1	Prior Ownership, Exploration and Development History	6-1
6.2	Historical Resource Estimates	6-2
6.3	Past Production	6-2
7.0	Geological Setting and Mineralization	7-1
7.1	Regional Geology	7-1
7.2	Local Geology	7-2
7.3	Property Geology	7-5
7.4	Mineralization	7-13
8.0	Deposit Types	8-1
9.0	Exploration	9-1
10.0	Drilling	10-1
11.0	Sample Preparation, Analyses, and Security	11-1



11.1	Sampling Method and Approach	11-1
11.2	Sample Preparation and Analyses	11-5
11.3	Density Determinations	11-8
11.4	Sample Security	11-10
11.5	Quality Assurance and Quality Control	11-11
11.6	Conclusions and Recommendations	11-25
12.0	Data Verification	12-1
12.1	Previous Work	12-1
12.2	Current Work	12-2
13.0	Mineral Processing and Metallurgical Testing	13-1
13.1	Metallurgical Testing 2023	13-1
13.2	Metallurgical Testing 2024	13-8
14.0	Mineral Resource Estimates	14-1
14.1	Summary	14-1
14.2	Resource Database	14-3
14.3	Geological Interpretation	14-4
14.4	Grade Domaining	14-16
14.5	Treatment of High Grade Assays	14-18
14.6	Compositing	14-23
14.7	Trend Analysis	14-24
14.8	Block Models	14-32
14.9	Search Strategy and Grade Interpolation Parameters	14-32
14.10	Estimation Validation	14-37
14.11	Bulk Density	14-54
14.12	Cut-off Grade	14-54
14.13	Classification	14-55
14.14	Mineral Resource Reporting	14-57
15.0	Mineral Reserve Estimates	15-1
15.1	Summary	15-1
15.2	Dilution	15-5
15.3	Extraction	15-5
15.4	Cut-off Grade	15-5
15.5	Comparison with Previous Estimate	15-6
16.0	Mining Methods	16-1



16.1	Geotechnical Studies and Investigations	16-1
16.2	Hydrogeological Studies	16-9
16.3	Mining Method.....	16-12
16.4	Mine Optimization	16-19
16.5	Life of Mine Plan	16-22
17.0	Recovery Methods	17-1
17.1	Plant Throughput and Design	17-1
17.2	Summary Process Description.....	17-1
17.3	Process Description	17-2
17.4	Energy, Water, and Material Requirements.....	17-11
17.5	Process Flow Sheet	17-12
18.0	Project Infrastructure.....	18-1
18.1	Heap Leach Pad	18-1
18.2	Water Supply.....	18-4
18.3	Purchasing and Warehousing	18-4
18.4	Offices and Shops.....	18-4
18.5	Communications	18-4
18.6	Accommodations.....	18-4
18.7	Energy Supply.....	18-5
18.8	Transportation and Access	18-5
19.0	Market Studies and Contracts	19-1
19.1	Markets	19-1
19.2	Contracts.....	19-1
20.0	Environmental Studies, Permitting, and Social or Community Impact.....	20-1
20.1	Environmental Studies	20-1
20.2	Project Permitting.....	20-2
20.3	Social or Community Requirements.....	20-9
20.4	Waste Disposal, Site Monitoring and Water Management.....	20-11
20.5	Mine Closure Requirements.....	20-14
20.6	Qualified Person’s Opinion.....	20-15
21.0	Capital and Operating Costs	21-1
21.1	Capital Costs.....	21-1
21.2	Operating Costs	21-2
22.0	Economic Analysis	22-1



23.0	Adjacent Properties	23-1
24.0	Other Relevant Data and Information	24-1
25.0	Interpretation and Conclusions	25-1
25.1	Geology and Mineral Resources	25-1
25.2	Mining and Mineral Reserves	25-2
25.3	Mineral Processing.....	25-2
25.4	Infrastructure	25-4
25.5	Environment	25-5
25.6	Capital and Operating Costs	25-5
26.0	Recommendations	26-1
26.1	Geology and Mineral Resources	26-1
26.2	Mining and Mineral Reserves	26-1
26.3	Mineral Processing.....	26-2
26.4	Infrastructure	26-2
26.5	Environment	26-2
26.6	Capital and Operating Costs	26-3
27.0	References	27-1
28.0	Date and Signature Date	28-1
29.0	Certificate of Qualified Person	29-1
29.1	Benjamin Sanfurgo.....	29-1
29.2	Eduardo Zamanillo	29-3
29.3	Andrew Paul Hampton	29-4
29.4	Derek J. Riehm	29-5

Tables

Table 1-1:	Summary of Mineral Resource Estimate, Inclusive of Mineral Reserves – December 31, 2024	1-14
Table 1-2:	Summary of Mineral Resource Estimate, Exclusive of Mineral Resources – December 31, 2024	1-15
Table 1-3:	Summary of Mineral Reserve Estimate – December 31, 2024	1-16
Table 2-1:	Qualified Persons and Responsibilities	2-2
Table 6-1:	Production History – 1983 to 2024	6-3
Table 10-1:	Drill Programs Completed at San Andrés Mine.....	10-1
Table 11-1:	Density Measurements.....	11-8



Table 11-2:	San Andrés QC Submittals: 2010 to 2024.....	11-14
Table 11-3:	San Andrés Certified Reference Material Performances.....	11-16
Table 11-4:	Summary of Duplicate Data Performance	11-21
Table 13-1:	Column Leach Testing of Esperanza Alto in 2023	13-1
Table 13-2:	Column Leach Testing of Banana Ridge in 2023	13-3
Table 13-3:	Column Leach Testing of Esperanza Bajo in 2023	13-4
Table 13-4:	Column Leach Testing of Falla A in 2023	13-6
Table 13-5:	Column Leach Testing of Composite in 2023.....	13-7
Table 13-6:	Column Leach Test Results by Zone	13-10
Table 14-1:	Summary of Mineral Resource Estimate, Inclusive of Mineral Reserves – December 31, 2024	14-1
Table 14-2:	Summary of Mineral Resource Estimate, Exclusive of Mineral Resources – December 31, 2024.....	14-2
Table 14-3:	Lithological Domain Wireframes.....	14-5
Table 14-4:	Alteration Wireframes	14-7
Table 14-5:	Oxidation Wireframes	14-9
Table 14-6:	Grade Domain Wireframes (Au > 0.15 g/t).....	14-11
Table 14-7:	Geological Structural Sub-Zone Wireframes.....	14-13
Table 14-8:	Capping Statistics.....	14-21
Table 14-9:	Variogram Model Parameters.....	14-30
Table 14-10:	Block Model Definition.....	14-32
Table 14-11:	Sample Selection Strategy	14-33
Table 14-12:	Search Strategy and Grade Interpolation Parameters	14-34
Table 14-13:	Reserve Estimation (OK) versus NN Gold Grade Estimation.....	14-42
Table 14-14:	Mineral Resource Model Comparison with Production Data	14-45
Table 14-15:	Reconciliation of Grade Control, Process Plant and Gold Production.....	14-51
Table 14-16:	Comparison between the 2024 and 2023 Block Models (within Resource shell using original topography)	14-52
Table 14-17:	Grade and Tonnage Comparison for the 2024 vs 2023 Block Models (within Resource shell using December 2024 Topography)	14-53
Table 14-18:	Resources Cut-off Parameters	14-54
Table 14-19:	Summary of Mineral Resource Estimate, Inclusive of Mineral Reserves – December 31, 2024	14-57
Table 14-20:	Summary of Mineral Resource Estimate, Exclusive of Mineral Resources – December 31, 2024	14-58
Table 14-21:	2023 and 2024 Mineral Resource Comparison at Minosa	14-60



Table 15-1:	Open Pit Main Design Parameters	15-1
Table 15-2:	Cut-Off Grade Parameters	15-2
Table 15-3:	Summary of Mineral Reserve Estimate – December 31, 2024	15-2
Table 15-4:	Comparison of 2024 to 2023 Mineral Reserve Estimate	15-7
Table 16-1:	Summary of Geotechnical Units	16-1
Table 16-2:	Summary of Geotechnical Laboratory Testing and Strength Parameters	16-2
Table 16-3:	Description of Geotechnical Units	16-3
Table 16-4:	RMR and Q-Value Ranges by Geotechnical Unit.....	16-4
Table 16-5:	Maximum Overall Slope Angles by Lithology	16-8
Table 16-6:	Recent Hydrogeological Boreholes	16-9
Table 16-7:	Installation Depth of Piezometers.....	16-10
Table 16-8:	Summary of Recent Hydrogeological Data	16-10
Table 16-9:	Contractor Equipment Fleet	16-14
Table 16-10:	WRSF Design Parameters	16-18
Table 16-11:	Pit Optimization Results (RF = 1.0)	16-20
Table 16-13:	LOM Mining Schedule	16-23
Table 17-1:	Plant Throughput.....	17-1
Table 17-2:	Summary of Agglomerator Conveyors	17-5
Table 17-3:	Heap Leach Pond Capacities.....	17-7
Table 18-1:	Capacity of Diesel Powered Generators	18-5
Table 20-1:	Minosa - Environmental Permits.....	20-5
Table 21-1:	Capital Costs 2025 to 2029	21-1
Table 21-2:	Unit Operating Costs	21-3
Table 21-3:	Annual Operating Costs	21-3

Figures

Figure 4-1:	Location Map.....	4-2
Figure 4-2:	Site Location.....	4-3
Figure 4-3:	Mineral Concessions Map	4-5
Figure 5-1:	Seasonal Rainfall and Temperature Trends at San Andrés Mine	5-2
Figure 5-2:	Summary of Climatic Data for the San Andrés Mine (Monthly Averages).....	5-3
Figure 7-1:	Regional Structural Setting of the Caribbean Plate	7-1
Figure 7-2:	District Geology	7-3
Figure 7-3:	Stratigraphic Column	7-4



Figure 7-4:	Property Geology – Lithology (Topography December 2024)	7-7
Figure 7-5:	Property Geology – Lithology Section 290900 East	7-8
Figure 7-6:	Property Geology – Alteration (Topography December 2024)	7-11
Figure 7-7:	Property Geology – Alteration Section 290900 East	7-12
Figure 7-8:	Property Geology – Mineralization (topography December 2024)	7-14
Figure 7-9:	Property Geology – Mineralization Section 290900 East	7-15
Figure 9-1:	San Andrés Concessions	9-2
Figure 9-2:	Geochemical Sampling Locations for Gold on San Andrés Concessions I, II, III, IV, and V	9-3
Figure 9-3:	Geochemical Sampling Locations for Gold on San Andrés Concessions V, VII, and X	9-4
Figure 10-1:	Drill Hole Locations	10-2
Figure 10-2:	Core Recovery vs Gold Grade	10-5
Figure 11-1:	Schematic Flow Chart for Sample Collection and Surveying	11-4
Figure 11-2:	Density Sample Selection	11-9
Figure 11-3:	Sample Storage Facility	11-11
Figure 11-4:	San Andrés CRM Z-Score	11-17
Figure 11-5:	Control Chart of CRM G320-3 for Gold in LMI: 2023	11-18
Figure 11-6:	Control Chart of CRM G918-1 for Gold in LMI: 2023 - 2024	11-18
Figure 11-7:	Control Chart of CRM GG315-5 for Gold in LMI: 2021 - 2023	11-19
Figure 11-8:	Coarse Blank Samples in LMI	11-20
Figure 11-9:	Field Duplicate Data - RC	11-22
Figure 11-10:	Coarse Duplicate Data - RC	11-22
Figure 11-11:	Pulp Duplicate Data - DD	11-23
Figure 11-12:	Check Assay - Scatter Plot (2012 – 2013)	11-23
Figure 11-13:	Check Assay - Scatter Plot and QQ Plot (2024)	11-24
Figure 11-14:	Check Assay - Scatter Plot and QQ Plot (2024) – Au CN	11-24
Figure 12-1:	Drill Hole Comparison	12-3
Figure 12-2:	Drilling in Progress	12-4
Figure 13-1:	Esperanza Alto Gold Recovery versus Particle Size	13-3
Figure 13-2:	Banana Ridge Gold Recovery versus Particle Size	13-4
Figure 13-3:	Esperanza Bajo Gold Recovery versus Particle Size	13-5
Figure 13-4:	Falla A Gold Recovery versus Particle Size	13-7
Figure 13-5:	Composite Gold Recovery	13-8
Figure 13-6:	Gold Head Grade and Particle Size vs Recovery	13-11



Figure 13-7: Particle Size versus Gold Recovery	13-12
Figure 14-1: Depth Histogram	14-3
Figure 14-2: Sample Length Cumulative Distribution Plot by Drill Hole Type.....	14-4
Figure 14-3: Lithology, Level 1000	14-6
Figure 14-4: Alteration, Level 1000.....	14-8
Figure 14-5: Oxidation Domains, Level 1000.....	14-10
Figure 14-6: Grade Domains (Au > 0.15 g/t), Level 1000.....	14-12
Figure 14-7: Structural Sub-Zone Domains, Level 1000.....	14-14
Figure 14-8: Structural Map and Main Anisotropic Trends	14-15
Figure 14-9: Grade Domain (Au > 0.15 g/t)	14-17
Figure 14-10: Log Probability Plot Au g/t All Domains	14-18
Figure 14-11: Global TopCut Analysis. Esperanza Alto Oxide.	14-19
Figure 14-12: Box Plot Assays by Domain	14-20
Figure 14-13: Cumulative Distribution Comparison between Drill Holes Raw Data vs Composite	14-23
Figure 14-14: Grade x Thickness – Plan View.....	14-25
Figure 14-15: Grade x Thickness (GT) – East-West Section.....	14-26
Figure 14-16: Grade x Thickness – North-South Section	14-27
Figure 14-17: Esperanza Alto Oxide Variogram	14-28
Figure 14-18: Esperanza Bajo Oxide Variogram	14-29
Figure 14-19: Variable Orientation. Dynamic Anisotropy (DA)	14-36
Figure 14-20: Section North 1632550 Block Model and Drill holes	14-38
Figure 14-21: Section North 1632550 Production Data and Drill holes	14-39
Figure 14-22: Section East 291000 Block Model and Drill Holes	14-40
Figure 14-23: Elevation Plan 1000 Block Model and Drill Holes.....	14-41
Figure 14-24: Swath Plot Elevation: Drill Hole Grades, OK and NN Grade Estimation	14-43
Figure 14-25: Swath Plot Easting: Drill Hole Grades, OK and NN Grade Estimation.....	14-44
Figure 14-26: Swath Plot Northing: Drill Hole Grades, OK and NN Grade Estimation	14-44
Figure 14-27: Grade and Tonnes Comparison between 2024 Resource Model vs. Blast Hole Block Model.....	14-45
Figure 14-28: Contained Metal Comparison between 2024 Resource Model vs. Blast Hole Block Model.....	14-46
Figure 14-29: Tonnes, Grade, and Contained Metal Comparison between 2024 Resource Model vs. Blast Hole Block Model	14-46
Figure 14-30: Production BH vs. RC Hole Comparison - Histogram at 5 m Distances and Mean Comparison at Various Sample Separation Distances.....	14-47



Figure 14-31: Production BH vs. RC Hole Comparison - QQ Plot and Cumulative Probability Plot	14-47
Figure 14-32: Production BH vs. DD Hole Comparison - Histogram at 5 m Distances and Mean Comparison at Various Sample Separation Distances.....	14-48
Figure 14-33: Production BH vs. DD Hole Comparison - QQ Plot and Cumulative Probability Plot	14-48
Figure 14-34: RC vs. DD Hole Comparison - Histogram at 5 m Distances and Mean Comparison at Various Sample Separation Distances.....	14-49
Figure 14-35: RC vs. DD Hole Comparison - QQ Plot and Cumulative Probability Plot.....	14-49
Figure 14-36: Estimated Recovered Gold Ounces vs Production Ounces 2010 to 2024	14-50
Figure 14-37: Reconciliation Trend from 2010 to 2024 of Process Plant vs. Ore Mined (Tonnes, Gold Grade, and Ounces)	14-50
Figure 14-38: Grade and Tonnage Comparison of the 2024 vs 2023 Block models (within Resource shell using the Original Topography)	14-52
Figure 14-39: Grade and Tonnage Comparison for the 2024 vs 2023 Block model (within Resource shell using YE 2014 topography)	14-53
Figure 14-40: Mineral Resources Classification. Section 1632500 North.....	14-56
Figure 14-41: Percentage of Contained Gold vs Drill Hole Spacing by Classification	14-57
Figure 14-42: Mineral Resources with the Resource Pit.....	14-59
Figure 15-1: Final Pit Design	15-4
Figure 16-1: Pit Shell Optimization at Different Revenue Factors	16-21
Figure 16-2: Annual Production	16-24
Figure 16-3: Mining Phases and LOM Pit Configuration	16-25
Figure 16-4: Pit Configuration EOY 2025	16-26
Figure 16-5: Pit Configuration EOY 2026	16-27
Figure 16-6: Pit Configuration EOY 2027	16-28
Figure 16-7: Pit Configuration EOY 2028	16-29
Figure 16-8: Pit Configuration EOY 2029	16-30
Figure 17-1: Leach Solution Flow System	17-6
Figure 17-2: Simplified Flow Diagram of ADR Plant.....	17-9
Figure 17-3: Process Flowsheet	17-13
Figure 18-1: Heap Leach Pad Remaining Capacity and Potential Expansion Areas	18-3
Figure 18-2: Infrastructure Layout	18-6
Figure 20-1: Minosa Lifetime Environmental Permit, Secondary Environmental Licenses and la Buffa Area.....	20-8
Figure 20-2: Waste Rock Storage Facilities.....	20-12
Figure 23-1: Adjacent Properties	23-2



1.0 Summary

1.1 Executive Summary

SLR Consulting (Canada) Ltd. (SLR) was retained by Aura Minerals Inc. (Aura) to prepare an independent Technical Report (the Technical Report) on the San Andrés Mine (San Andrés or the Mine), located in the Department of Copán, Honduras. The purpose of this Technical Report is to disclose the Mineral Resource and Mineral Reserve estimates on the San Andrés Mine as of December 31, 2024, by Aura. This Technical Report has been prepared in accordance with Canadian National Instrument 43-101 (NI 43-101) Standards of Disclosure for Mineral Projects. SLR qualified persons (QPs) visited the property from October 21 to 24, 2024.

Aura is a mid-tier gold and copper producer listed on the Toronto Stock Exchange (TSX) under the symbol ORA, the Brazilian Stock Exchange (B3) as AURA33, and the OTC Markets (OTCQX) under ORAAF. Aura operates in Honduras, Brazil, and Mexico. Its exploration projects are located in Brazil, Guatemala, and Colombia.

The San Andrés Mine, located approximately 210 km southwest of San Pedro Sula, Honduras, is an open-pit, heap leach operation that has been in production since 1983. The Mine is wholly owned by Aura's subsidiary, Minerales de Occidente, S.A. de C.V. (Minosa). The Mine has all the required infrastructure to support current operations and has actively managed its community engagements efforts.

This Technical Report documents the current Mineral Resource and Mineral Reserve estimates, life of mine (LOM) plan, economic analysis, and technical details. This Technical Report updates the NI 43-101 Technical Report prepared by Aura filed on SEDAR, which had an effective date of December 31, 2013, referred to as the 2014 Technical Report (Aura 2014). In 2024, the Mine produced 78,372 ounces of gold and 9,644 ounces of silver.

1.1.1 Conclusions

1.1.1.1 Geology and Mineral Resources

- The SLR QP has reviewed data collection, sampling, sampling preparation, quality assurance/quality control (QA/QC), data verification, modeling, grade estimation methods, and classification definitions for the San Andrés Mine and has found no material issues.
- During the 2024 site visit, the SLR QP inspected the core storage facilities and confirmed they were well-maintained, appropriately managed, and in good condition.
- The geological models and gold resource estimations were completed using Leapfrog Edge.
- The Minosa Geological team updated the Mineral Resource estimate following standard industry practices. The updated estimate includes new 2023 and 2024 drilling with assays (309 drill holes with 23,721 m). The drill hole database contains 2,494 drill holes totalling 245,035 m.
- The Mineral Resource estimation was developed in seven areas, or domains, using ordinary kriging (OK). The SLR QP validated the block grade estimates with visual inspection of cross sections and plan views, general statistics, swath plots, and



reconciliation with production data to verify that the estimation results are unbiased and found no material issues.

- Mineral Resources have been classified in accordance with Canadian Institute of Mining, Metallurgy and Petroleum (CIM) Definition Standards for Mineral Resources and Mineral Reserves (CIM (2014) definitions).
- Resource classification of San Andrés was defined based on drill hole spacing (DHS) criteria and proximity to recent production areas. Classification criteria are supported by variography. The SLR QP considers the classification criteria appropriate.
- Inclusive of Mineral Reserves, the San Andrés Mineral Resources are estimated to be 11.5 million tonnes (Mt) of Measured Mineral Resources at 0.38 g/t Au containing 140 thousand ounces (koz), 47.5 Mt of Indicated Mineral Resources at 0.45 g/t Au containing 681 koz, and 8.55 Mt of Inferred Mineral Resources at 0.45 g/t Au containing 123 koz, using a long term US\$2,200 gold price reported at a cut-off grade of 0.187 g/t Au for oxide material and 0.291 g/t Au for mixed material. The effective date of the Mineral Resource estimate is December 31, 2024.
- Exclusive of Mineral Reserves, the San Andrés Mineral Resources are estimated to be 1.46 million tonnes (Mt) of Measured Mineral Resources at 0.34 g/t Au containing 16 koz, 24.22 Mt of Indicated Mineral Resources at 0.40 g/t Au containing 310 koz, and 8.55 Mt of Inferred Mineral Resources at 0.45 g/t Au containing 123 koz.
- The Mineral Resource estimate does not include any sulphide material.
- A comparison of production blast hole (BH) data and reverse circulation (RC) data suggests a potential 15% positive bias in gold grades. However, the review confirms the reliability of blast hole samples.

1.1.1.2 Mining and Mineral Reserves

- The San Andrés Mine employs conventional open-pit mining methods with a focus on selective ore extraction and waste management.
- The remaining mine life is approximately four years, reflecting constraints due to deposit geometry and the transition to low-grade sulphides at depth.
- As of December 31, 2024, the estimated Proven and Probable Mineral Reserves total 30.66 Mt at an average grade of 0.44 g/t Au, containing 429,187 ounces (oz) of gold.
- Mineral Reserves were estimated using the Pseudoflow optimization methodology, incorporating detailed block models.
- The definitions for Mineral Reserves in CIM (2014) were followed for Mineral Reserves.
- A gold price of US\$2,000/oz was used in estimating Mineral Reserves. The calculated cut-off grades were 0.214 g/t Au for oxide material and 0.334 g/t Au for mixed material. Appropriate modifying factors were applied, including 5% dilution based on historical reconciliation data and 95% mining recovery based on operational efficiency and geotechnical considerations.
- Historical data shows consistent performance in grade control and recovery, supported by reconciliation practices.
- The Mineral Reserves are constrained by pit geometry, taking into account geotechnical parameters, property boundaries, and the proximity of the river. At depth, Mineral



Reserves are limited by the transition to sulphide mineralization, which is uneconomic under current processing methods due to 0% recovery.

- The SLR QP is of the opinion that the Mineral Reserves have been estimated in accordance with CIM (2014) definitions, as incorporated by reference in NI 43-101, and adhere to industry standards.

1.1.1.3 Mineral Processing

- The mined material in the ore deposit is subjected to metallurgical testing to determine what material is suitable for heap leach gold extraction, including ore characterization tests, mineralogy, fire and chemical assaying, bottle roll leach testing and column leach testing. The leach tests determine the optimum operating parameters to be used for metal extraction and recovery.
- Column leach testing was performed on samples taken from the pit during operation. Dispatch software was used to track the location from which the sample was taken during mining. The data could then be used to build a geometallurgical model.
- Two tests were performed for each sample, one at 80% passing (P_{80} 2" and the other at the specified P_{80} to determine the effect of particle size on extraction. The results indicate that gold extraction is affected by degree of oxidation, degree of silicification and particle size. The material requires crushing. Heap leaching is applicable for the oxide and some of the mixed oxide/sulphide material. The silicified and unoxidized sulphide materials will require alternate extraction methods including fine grinding and sulphide oxidation.
- The tested samples represent various levels of oxidation and silicification. The samples with high recoveries are oxidized, and the samples with low recoveries are unoxidized, (fresh), silicified, or both. Examples include:
 - Sample MT-24-0010 is a sample of Esperanza Bajo described as a quartz matrix with sulphide minerals. The material was crushed to P_{80} 1.67 in., and the resulting heap leach gold recovery was 14.6%.
 - Sample MT-24-0011 is a sample of Esperanza Bajo described as mixed ore with oxidation in the veins and containing both oxidized and unoxidized sulphide minerals, primarily pyrite. The material was crushed to P_{80} 1.67 in., and the resulting heap leach gold recovery was 86.9%.
 - Sample MT-24-0012 is a sample of Esperanza Bajo described as silicified material with sulphides. The material is crushed to P_{80} 1.76 in., and the resulting heap leach gold recovery is 49.6%.
 - Sample MT-24-0013 is a sample of Esperanza Bajo described as fragmented quartz with strong silicification plus sulphide minerals. The material was crushed to P_{80} 1.8 in., and the resulting heap leach gold recovery was 24.1%.
- The San Andrés Mine employs heap leaching for the recovery of gold from mined material. The processing facilities include two stages of crushing and screening, drum agglomeration, heap leach pads (HLPs), an adsorption, desorption, and refining (ADR) plant for recovering the gold from solution, and gold-silver doré casting.
- The Mine produces approximately seven million tonnes per annum (Mtpa) of run-of-mine (ROM) material using conventional drilling, blasting, loading and haul truck transportation. The material is mined and transported by haul truck to either the waste



rock storage facilities (WRSFs) or to the primary crushers for processing. The LOM production plan includes 7.7 Mt of material placed during 2025, 7.3 Mt in each of 2026, 2027 and 2028, and 1.8 Mt in 2029, for a total of 31.5 Mt.

- The mineralized material is directly dumped into the feed hoppers of two primary crushers operating in parallel. The primary crushed ore is conveyed to an intermediate stockpile. The ore is drawn from the stockpile with feeders and conveyed to secondary crushing. Lime and cement are added to the secondary crusher product on the conveyor feeding two drum agglomerators operating in parallel.
- Sodium cyanide solution is added to the agglomerated material on conveyor 8 following agglomeration. The agglomerated material is conveyed to the HLP where it is placed using conveyor stackers. The placed material is leached with cyanide solution for a period of 60 days. The cyanide leach solution is maintained at 400 ppm sodium cyanide (NaCN). Leach solution flows by gravity through the heaps and discharges into the Pregnant Leaching Solution (PLS) pond. PLS solution is pumped from the PLS pond to the ADR plant for gold and silver recovery.
- PLS flows through the Carbon-in-Column (CIC) adsorption system, which comprises activated carbon columns operating in series, organized in trains, and designed for the selective adsorption of gold and silver from the gold-bearing leach solution.
- The carbon columns are designed to process 10,000 m³/day in each train and the plant has a capacity to work with up to 6 trains, which can be exchanged between PLS and intermediate leach solution (ILS) trains, depending on the need of the operation.
- The loaded carbon is eluted with a solution of caustic soda and ethanol under controlled temperature and pressure. Gold is recovered from the rich gold eluate by electrowinning resulting in the deposition of metals, including gold, in stainless steel cathodes. The resulting gold mud is dried in a mercury retort and then melted into gold-silver doré for sale.
- Eluted carbon is reactivated by an acid wash with hydrochloric acid and then taken to a high temperature rotary kiln prior to recycling the carbon to the carbon columns for continued adsorption of gold.

1.1.1.4 Infrastructure

- The San Andrés Mine has been in operation since 1983 and has developed the necessary infrastructure to support current and planned mining activities. Key components include power supply, water management systems, waste handling facilities, operational support buildings, and access roads.
- The Mine is connected to the Honduran national power grid, which supplies most of the site's energy needs. A diesel-powered backup generator system is maintained to ensure operational continuity during grid outages. The Platanares Geothermal Power Plant, located in La Unión, Copán, presents potential opportunities for future renewable energy integration.
- Process water is sourced from rainwater runoff collected in a surge pond and direct pumping from the Río Lara, which provides a reliable flow even during the driest months.
- Potable water is available at the site via a 72,000-gallon storage tank that is fed by a 17 km pipeline from the Río Lara. Additional purified water is sourced locally.



- WRSFs are designed with runoff control and erosion prevention measures.
- The HLP system has been expanded over time to accommodate increased processing demands. The most recent stability assessment by an independent third party was conducted in 2021. Additionally, an ongoing geotechnical study is being carried out by SRK Consulting (U.S.), Inc. (SRK) to evaluate long-term stability and potential future expansion.
- Monthly monitoring of parameters related to HLP is being done, and data reported in the September 2024 report indicate that the HLP structure is performing within design parameters (Minosa 2024a).
- Minosa has updated the HLP capacity estimate and determined that the currently available storage is lower than the total required for the Life of Mine (LOM). To address this, Minosa is advancing multiple expansion projects in collaboration with Kappes, Cassidy & Associates (KCA) for design and SRK for geotechnical evaluation. While the ongoing expansions are expected to provide sufficient capacity for the LOM plan, SLR has not reviewed the details of these projects and therefore does not provide an opinion on the final HLP capacity.
- Support facilities include warehouses, maintenance workshops, an assay laboratory, and administrative offices.
- On-site housing for essential personnel and contractors is available.
- The site is accessible via a combination of paved highways and gravel roads, ensuring year-round access for materials, equipment, and personnel.
- The Mine includes a helipad, primarily used for gold doré transport and available for personnel transfers or emergency medical evacuations when required.
- The Mine maintains radio, telephone, internet, and satellite television services, ensuring effective coordination across operational areas.
- The Mine's infrastructure has been progressively maintained and adapted to meet operational requirements while ensuring compliance with environmental and regulatory standards.

1.1.1.5 Environment

- Minosa has signed collaboration agreements with the communities within the direct area of interest (AOI). These collaboration agreements seek to provide financial support to direct AOI communities through social investments in areas related to education, health, housing, and employment.
- Minosa has started completing social transitioning/economic diversification, including the implementation of the Seeds of Hope Project and the partnership approach used by the San Andrés Foundation to fund initiatives as a mechanism to ensure the sustainability of these initiatives beyond the Mine's life.
- The Mine obtained the San Andres I mining concession, covering 355 hectares, in 1983 issued by *Instituto Hondureño de Geología y Minas* (INHGEOMIN). Minosa understands that a lifetime environmental permit has been granted for the site covering the same area as the mining concession (355 ha), and that the permit can be used to develop the Buffa Zone. SLR understands that Minosa requested that the environmental authority confirm this approach. The outcome/response from the environmental authority is



unknown. In the meantime, in January 2025, Aura obtained authorization to cut the trees in the Buffa Zone through Resolution DE-PS-002-2025 issued by *Instituto Nacional de Conservación Forestal* (ICF), which supports Aura's understanding related to the area covered by the initial environmental permit.

- Minosa submits periodic Environmental Control Measures Compliance Reports (*Informe de Cumplimiento de Medidas Ambientales*, or ICMA) to the environmental authority. The environmental authority rarely provides any comments/questions to Aura.
- Aura completed a Mine Closure Plan (MCP) and submitted it to the regulator for review and approval. The MCP has not yet been approved.

1.1.1.6 Capital and Operating Costs

- Capital Costs:
 - Capital expenditure for the San Andrés Mine primarily focuses on sustaining capital investments, including HLP expansions, equipment maintenance, and tailings management.
 - Planned expenditures for 2025 through 2028 include upgrades to processing facilities and ongoing infrastructure improvements to support operational efficiency.
 - No major greenfield or expansionary capital expenditures are expected, aligning with the remaining LOM.
- Operating Costs:
 - The Mine operates at an average total operating cost US\$11.82/t processed.
 - Key components of operating costs include:
 - Mining: Diesel fuel, haulage, and explosives costs dominate mining expenses, with optimized fleet operations to reduce unit costs. The average LOM mining cost is US\$2.44/t moved.
 - Processing: Costs related to heap leach operations include reagents (e.g., cyanide, lime), power consumption, and water management. The average LOM processing costs is US\$6.27/t processed.
 - General and Administrative (G&A): Expenses include labor, security, and community engagement programs. The average LOM G&A cost is US\$1.88/t processed.
- Cost Control Initiatives:
 - The transition to national grid power in year 2015 has reduced energy costs by approximately 31%, providing significant savings in operational expenses.
 - Optimization of consumables (e.g., explosives and reagents) through long-term supplier contracts ensures cost stability.
 - Continuous monitoring of mine-to-mill performance helps identify inefficiencies and implement corrective measures.
- Total site costs average US\$1,360 per ounce gold produced, covering mining, processing, general and administrative (G&A) expenses, and sales costs.



- Sustaining capital expenditures add US\$134 per ounce, which is consistent with industry benchmarks for mature operations.
- The All-In Sustaining Cost (AISC) is estimated at US\$1,493 per ounce payable.

1.1.2 Recommendations

The SLR QPs offer the following recommendations by area:

1.1.2.1 Geology and Mineral Resources

- 1 Complete further exploration testing of oxide and mixed (i.e., mixed oxide/sulphide material) mineralization to further optimize the boundary with the sulphides and test the extension of mineralization at depth.
- 2 Continue the geological characterization for the different material types (i.e., oxide, mixed, and sulphide) and incorporate those characterizations in the geological interpretation.
- 3 Maintain cyanide-soluble gold assays for blast hole sampling and plant metallurgical control, incorporating results into the resource model.
- 4 Investigate process options for sulphide material to assess its potential inclusion in Mineral Resources.
- 5 Advance drilling in the Buffa Zone to delimit the lateral and vertical extension.
- 6 Continue the RC infill drilling to better evaluate gold grade representativity.
- 7 Conduct detailed sampling and reconciliation studies to assess the potential 15% positive bias in BH data relative to RC data.
- 8 Prioritize exploration in the San Andrés III and IV concessions, leveraging newly granted exploration rights to identify economically viable material.

1.1.2.2 Mining and Mineral Reserves

- 1 Conduct periodic updates to the Pseudoflow optimization models to account for changing economic parameters, including gold price fluctuations and operating costs.
- 2 Refine cut-off grade calculations to ensure Mineral Reserve estimates remain aligned with the most current cost and recovery data.
- 3 Implement advanced grade control measures, such as additional real-time sampling or enhanced ore-waste boundary delineation, to minimize dilution beyond the current 5%.
- 4 Maintain or improve mining recovery rates by continuing to focus on operational efficiencies, such as precise excavation techniques and equipment optimization.
- 5 Conduct ongoing geotechnical monitoring to evaluate pit wall stability, particularly as mining progresses into deeper areas with steeper slopes.
- 6 Conduct additional geotechnical studies to evaluate opportunities to steepen pit slope angles to potentially include additional Mineral Reserves.
- 7 Evaluate the potential for near-pit exploration drilling to convert Resources into Reserves and extend the mine life.
- 8 Continue enhancing reconciliation processes to validate Mineral Reserve and Mineral Resource estimates against actual production data.



- 9 Develop predictive models to identify deviations between planned and actual performance, ensuring future Mineral Reserve estimates are accurate and reliable.
- 10 Integrate environmental and community considerations into Mineral Reserve planning to align with Aura's broader sustainability goals.

1.1.2.3 Mineral Processing

- 1 Continue column leach testing of ore samples during mining to build the geometallurgy database. The samples should be selected to represent the various zones and lithologies, degrees of oxidation, and degrees of silicification within the zones, as gold recovery is highly dependent on material characteristics.

1.1.2.4 Infrastructure

The infrastructure at the Mine is adequate for current and planned mining activities, however, the following recommendations are made regarding the HLP:

- 1 Review and validate the expansion of the HLP capacity in comparison to the options considered in the SRK 2021 analyses. A third-party validation of the remaining HLP capacity is recommended, considering the ongoing technical review by Kappes, Cassidy & Associates (KCA) and geotechnical assessment by SRK. Depending on the outcomes of these studies, assess whether additional permitting requirements may be necessary for further expansion. Based on Aura's internal review, no permitting constraints are anticipated at this time.
- 2 Update the 2021 HLP stability analysis to correspond to current and planned configurations, incorporating calibration based on monitoring data. The ongoing geotechnical assessment by SRK should be integrated into this update to ensure alignment with current operational and design parameters.

1.1.2.5 Environment

- 1 Review and update Minosa's existing environmental operational procedures.
- 2 Continue engaging with the environmental authority in regard to the discharge authorization for effluent discharge identified as Tuberia Descarga Poza 6 (TDP6). In addition, it is recommended that Minosa confirm the need for other discharge authorizations (to initiate the permitting process as required).
- 3 Continue engaging with Secretariat of Energy, Natural Resources, Environment and Mines (MIAmbiente) and other environmental agencies to obtain clarification related to the Buffa Zone, to renew the applicable permits/licences, and to obtain approval of the Closure Plan.
- 4 Review and standardize the ICMA's, highlighting the activities completed during the reported period. This will allow consistency for both Aura and the regulators and will prevent unnecessary risks to the operation.
- 5 Tabulate and process water quality information to understand water quality trends and compliance with applicable regulations. The analysis will allow Minosa to use the existing water quality database and identify and manage any issues as they arise.
- 6 As the Mine approaches its mine closure stage, continue developing and implementing the closure social transitioning activities, including communication and economic diversification. Communities in the AOI are currently highly dependent on the Mine's



social investment, employment, and local contracting opportunities. The social transitioning activities require several years to plan, implement, and materialize.

- 7 Consider expanding Minosa's engagement activities to include communities directly and through the Patronatos, Minosa's elected representatives. More frequent exposure to communities could help avoid miscommunication and understand first-hand community issues and concerns.
- 8 Review the Mine Closure Plan to ensure that a comprehensive review and supporting information (i.e. geochemistry and hydrogeology) are carried out by a third party with relevant experience in mine closure. This will allow Aura to determine the best cost-effective alternatives for closure.

1.1.2.6 Capital and Operating Costs

1. Align sustaining capital investments with operational priorities, focusing on HLP expansion, equipment replacements, and essential infrastructure maintenance to support efficient mine closure and maximize remaining asset value.
2. Optimize operating costs through efficiency improvements in energy consumption, procurement, and contractor services, leveraging reduced power costs from the national grid and renegotiating key supply contracts.
3. Enhance cost tracking and financial planning by implementing real-time expenditure monitoring, conducting periodic cost benchmarking against peer operations, and updating sensitivity analyses for gold price scenarios to ensure economic resilience.
4. Ensure capital and operating expenditures remain proportional to the mine's remaining life, avoiding overcapitalization while maintaining operational reliability and long-term value.

1.2 Economic Analysis

This section is not required as Aura is a producing issuer, the property is currently in production, and there is no material expansion of current production.

1.3 Technical Summary

1.3.1 Property Description and Location

The San Andrés Mine is located in the Department of Copán, within the Municipality of La Unión, Honduras. It is situated approximately 210 km southwest of San Pedro Sula, the second-largest city in Honduras, and 340 km west of Tegucigalpa, the capital city. The geographic coordinates of the property are 14.76° North latitude and 88.94° West longitude, based on the WGS84 datum.

The Mine is part of the western Interior Highlands topographical province, characterized by moderate relief and steep slopes. The elevation ranges from 750 metres above sea level (masl) to 1,300 masl, with the mine area predominantly covered by short grasses and open pine and oak forests.

Average annual precipitation ranges between 1,300 and 1,500 mm (Aguagea 2020). Rainfall occurs during winter from May to November. The highest monthly rainfall recorded was 551 mm in August 1995. The 2-year, 10-year, and 100-year precipitation events were calculated to be 81 mm, 121 mm, and 216 mm respectively. April and May are typically the warmest months.



Monthly temperatures range from 15°C in January to 25°C in May. Mean annual relative humidity is 82%. The San Andrés Mine can operate year-round. While occasional delays may occur during the wettest months, particularly due to heavy rainfall, these typically result in no more than a 6% reduction in productivity and do not materially impact overall operations.

The property is located within the Río Lara catchment basin, with key watercourses including Quebrada de San Miguel, Quebrada del Agua Caliente, and the Río Lara itself. These streams flow year-round and contribute to the hydrology of the region.

Access to the site is reliable year-round via paved highways and secondary gravel roads. The primary routes connect the Mine to nearby towns such as Santa Rosa de Copán, a regional hub, and San Pedro Sula, providing logistical support for supplies and personnel.

The Mine's infrastructure includes power, water, communication systems, and processing facilities, supporting continuous operation. Community engagement programs and environmental management plans are integral to its operations, ensuring sustainable coexistence with the surrounding region.

1.3.2 Land Tenure

Minosa holds three mineral concessions officially granted by INHGEOMIN (*Instituto Hondureño de Geología y Minas*): San Andrés I, San Andrés III, and San Andrés IV.

- San Andrés I is a mining concession originally granted for 30 years and renewed in 2021 through the administrative legal mechanism of *Afirmativa Ficta*, extending its validity until 2051. This Concession covers an area of 355 hectares.

San Andrés III (864 hectares) and San Andrés IV (994 hectares) are exploration concessions valid for 10 years, granted in 2020 and expiring in 2030, expanding the Property's exploration potential by a total of 1,858 hectares. Upon Minosa's notification to INHGEOMIN, exploitation activities can be initiated in these areas under applicable procedures.

- Minosa has submitted applications for new exploration concessions, totaling 2,900 additional hectares: San Andrés II (900 hectares), San Andrés V (1,000 hectares), and San Andrés X (1,000 hectares), which are currently under review by INHGEOMIN.

Surface rights over the concessions are secured through various mechanisms:

- Minosa holds 343 land parcels, grouped in six areas (Territories 1 to 6), acquired through public deeds, some registered in the Honduran Property Institute and others pending registration. Some lots are held under informal or community agreements, such as T6-MI-30, obtained via land swap with local residents. Others, like T5-MI-77, are located within the concession area and used for mining activities under applicable rights, despite not being formally titled.
- Minosa holds approximately 40% of the surface rights within the concession area.
- Agreements with local landowners and communities ensure access to land for mining and related activities.
- Strategic surface rights acquisitions have facilitated the construction of key infrastructure, including access roads, and processing facilities.

Minosa's legal rights include access, surface use, water use, and rights of way, as established in Article 53 of the Honduran Mining Law. These include:



- Use of state lands not under productive use.
- Establishment of easements on third-party lands or within other concession areas.
- Use of water resources (with municipal/state permissions).
- Recovery of minerals in water and processing byproducts.
- Conduct of operations directly or via third parties, with prior notification to authorities.
- Request for administrative inspections related to encroachment or safety risks.
- Confidentiality rights over technical and financial information submitted to authorities.

Minosa confirms that there are no legal disputes, judicial claims, or third-party agreements currently in place that could materially affect its land tenure or the operation of the San Andrés Mine. The project area is not inhabited by Indigenous or Afro-descendant peoples protected by international treaties, and no claims have been filed against the concession or related land parcels.

In areas overlapping with the community of Azacualpa, including parts of the urban center, Minosa must acquire land rights via negotiation or lease with private landowners. For forested areas, timber cutting permits must be obtained from the relevant environmental authority (Instituto Nacional de Conservación Forestal – ICF) in addition to the environmental license.

1.3.3 History

The San Andrés Mine has a long history of gold production, transitioning from small-scale artisanal mining to a modern, mechanized operation over several decades.

- Early Artisanal Mining (1930s-1980s): Gold mining in the San Andrés area began in the 1930s through small-scale artisanal miners targeting oxide-rich mineralization using rudimentary methods.
- Modern Mining Commencement (1983): Formalized industrial mining began in 1983 with the granting of the original San Andrés I mining concession by INHGEOMIN. This initial 355 ha concession marked the start of modern, mechanized heap leach operations.
- Ownership and Development Milestones:
 - 1995: The Mine was acquired by Minosa (Minerales de Occidente S.A.), which implemented significant infrastructure and operational improvements.
 - 2009: Aura Minerals Inc. acquired the San Andrés Mine, integrating it into its portfolio of gold-producing assets. Aura has since invested in further modernization, resource exploration, and community engagement.
- Regulatory and Concession Developments:
 - 2002: Applications for four additional exploration concessions (San Andrés II, III, IV, and V) were submitted to expand the resource base.
 - 2020: INHGEOMIN granted San Andrés III and IV as exploration concessions, each valid for 10 years and expiring in 2030.
 - 2021: The San Andrés I mining concession was officially renewed for 30 years, extending its validity to 2051, under the administrative mechanism of *Afirmativa Ficta*, in accordance with Honduran administrative law.



- 2025: Minosa has submitted further concession applications for San Andrés II, V, and X, which are currently under review

The historical evolution of the San Andrés Mine highlights its strategic importance as a gold producing asset in Honduras and a cornerstone in Aura Minerals' operational portfolio. Ongoing exploration, concession management, and stakeholder engagement ensure the continued sustainability and legacy of the operation.

1.3.4 Geology and Mineralization

The gold deposits at the Mine are hosted within Tertiary-aged felsic volcanic flows, tuffs and agglomerates, thick inter-bedded silica breccias, primarily containing volcanic fragments and tuffaceous sandstones. These volcanic units occur on the south (hanging wall side) of the San Andrés Fault. The fault strikes west-east and dips at 60° to 70° south and it marks the northern boundary of the Water Tank Hill and East Ledge pits. The fault forms the contact between the Permian phyllites (metasediments) to the north and the volcanic units on the south. Mineralisation within the phyllites is limited to the Buffa Zone where quartz carbonate veining is proximal to the San Andrés Fault. South of the Mine area, where there is no alteration, the volcanic and sedimentary rocks have a distinctive hematite brick red color; in the Mine area, they have been bleached to light buff yellow and grey colors due to alteration. The younger volcanic and sedimentary units typically have a shallow to moderate southerly dip and thicken to the south of the Mine area.

Structurally, the Mine area is transected by a series of sub-parallel, west to northeast-striking faults that are typically steeply dipping to the south and by numerous north and northwest-striking normal faults and extension fractures. The most prominent fault of the first set is the San Andrés Fault. The San Andrés Fault is parallel to, and coeval with, a major set of west to north-northeast trending strike-slip faults that form the Motagua Suture Zone, which is continuous with the Cayman Trough. The Motagua Suture Zone and the Cayman Trough result from the movement between the North American plate and the Caribbean plate. The direction of movement along these strike-slip faults, including the San Andrés Fault, is left lateral.

The normal faults and extension fractures occur within the volcanic and sedimentary units on the south side of the San Andrés Fault. Average strike of these structures is N25°W; dip is 50° to 80° to the southwest and northeast, forming grabens where the strata are locally offset. These faults and fractures are generally filled with banded quartz and blade calcite and have formed focal points the alteration and mineralisation fluids within the Mine area. These extensional structures are distributed over a wide area, from the East Ledge open pit to Quebrada Del Agua Caliente, approximately 1,500 m to the east, and from the San Andrés Fault, for at least 1,200 m south and are coeval with the strike-slip faults.

There are abundant occurrences of hot springs throughout Honduras and hot springs occur within the immediate vicinity of the Mine. These geothermal systems are most likely caused by thin crust and high regional heat flow resulting from the rifting associated with the Suture Zone. The hot springs are neutral to alkaline in pH and range in temperature from 120°C to 225°C. The high-temperature springs are currently depositing silica sinter with cooling. Structurally, the hot springs are associated with the northwest-trending extensional faults and fractures. The San Andrés deposit is classified as an epithermal gold deposit associated with extension structures within tectonic rift settings. These deposits commonly contain gold and silver mineralization, which is associated with banded quartz veins. At the Mine, however, silver does not occur in significant economic quantities. Gold occurs in quartz veins predominantly comprised of colloform banded quartz (generally chalcedony with lesser amounts of fine comb quartz, adularia, dark carbonate, and sulphide material). The gold mineralization is deposited as a



result of the cooling and interaction of hydrothermal fluids with groundwater and the host rocks. The hydrothermal fluids may have migrated some distance from the source; however, there is no clear evidence at the Mine that the fluids or portions of the fluids have been derived from magmatic intrusions.

The rocks hosting the San Andrés deposit have been oxidized near surface as a result of weathering. The zone of oxidation varies in depth from 10 m to more than 200 m, and in the main area is approximately 100 m. The zone of oxidation is generally thicker in the East Ledge deposit compared to the Twin Hills deposit. In the oxide zone, the pyrite has been altered to an iron oxide such as hematite, goethite, or jarosite. The oxide zone generally overlies a zone of partial oxidation, called the mixed zone, which consists of both oxidized and sulphide material. The mixed zone may not occur continuously, but where it is present, it reaches thicknesses that vary in depth from 0 m to over 100 m, averaging 50 m, below the zone of oxidation. The gold is commonly associated with sulphide minerals such as pyrite. The sulphide, or “fresh”, zone lies below the mixed zone. The gold contained in the oxide zone is amenable to extraction by heap leaching using a weak cyanide solution. The gold recovery is reduced in the mixed zone as a result of the presence of sulphide minerals, and the gold cannot currently be recovered economically from the sulphide zone by heap leaching.

1.3.5 Exploration Status

Since Aura’s acquisition of Minosa on August 25, 2009, exploration activities at the San Andrés Mine have included property-scale geological mapping, road cut channel sampling, geochemical characterization, and geophysical surveys, all conducted by Minosa personnel. In 2010 and 2011, geological mapping and channel sampling were completed in adjacent areas, accompanied by a reverse circulation (RC) drilling program.

District-scale prospecting efforts focused on the San Andrés III and IV concessions, where detailed mapping, systematic sampling, and geochemical characterization were conducted. Initial results from this phase indicated strong potential for deeper mineralization. Exploration efforts in 2022 concentrated on reevaluating regional targets to refine the 2023 program. Geochemical sampling, including soil and rock analyses, was conducted in San Andrés IV during the first half of 2022. Additionally, an aeromagnetic survey covering approximately 4,435 hectares was carried out using drones. The survey identified key structural features interpreted as primary controls on mineralization, aiding in the definition of future exploration targets. No exploration activities outside the San Andrés property have been completed. Key findings are listed:

- San Andrés Concession II, no anomalies were detected due to a tuff cover.
- San Andrés Concession III, a geochemical anomaly was identified and is currently under further analysis.
- San Andrés V: Several anomalies were detected, necessitating additional sampling,
- San Andrés X: Poor results led to the cessation of further exploration.

Since 2022, exploration activities have been focused on the San Andrés Mine. In 2022, RC drilling totaled 3,459 m in 34 holes and diamond drilling 2,507 m in 19 drill holes, aimed at increasing confidence and infilling structural gaps in the alteration models. In 2023, exploration efforts targeted the continuity of historical high-grade sulphide mineralization. A total of 1,988 m was drilled in seven diamond drill holes at Esperanza Alto and Esperanza Bajo, while 10,842 m were drilled across 163 RC drill holes in the main corridor. In 2024, exploration was focused on infill drilling in the main high-grade corridor of Esperanza Alto and Esperanza Bajo, as well as



refining the oxide-mixed-sulphide boundary. In 2024, a total of 3,143 m in 19 diamond drill holes and 12,224 m in 158 RC drill holes were drilled.

1.3.6 Mineral Resources

The Mineral Resource estimate was prepared by the Minosa team and supervised and accepted by the SLR QP. Mineral Resources have been classified in accordance with CIM (2014) definitions.

The Mineral Resources are based on all available drill hole data as at September 18, 2024, and are reported below the estimated topography for EOY2024.

The Mineral Resources Sulphide material was excluded, and an Agua Caliente River exclusion zone (50 m) was applied.

The database and block models were supplied to SLR and included geological and block models as a Leapfrog Edge project that contains the main parameters and assumptions used to estimate Mineral Resources. SLR used Leapfrog Edge, Supervisor, and Vulcan software for statistical review, geostatistical analysis, block model visualisation, validation, and reporting.

The Minosa team supplied to SLR the previous resource block model, production block model, and reconciliation report, which SLR used in the validation process. Also, SLR generated an internal production block model for validation propose.

Table 1-1 summarizes the San Andrés Mine Mineral Resource estimate, inclusive of Mineral Reserves, as of December 31, 2024.

Table 1-1: Summary of Mineral Resource Estimate, Inclusive of Mineral Reserves – December 31, 2024

Category	Oxide			Mixed			Total		
	Tonnage (000 t)	Au (g/t)	Contained Gold (000 oz)	Tonnage (000 t)	Au (g/t)	Contained Gold (000 oz)	Tonnage (000 t)	Au (g/t)	Contained Gold (000 oz)
Measured	10,402	0.36	119	1,115	0.60	22	11,516	0.38	140
Indicated	42,459	0.43	580	5,074	0.62	100	47,533	0.45	681
Measured + Indicated	52,861	0.41	699	6,189	0.61	122	59,049	0.43	821
Inferred	6,921	0.42	94	1,629	0.56	29	8,550	0.45	123

Notes:

1. Mineral Resources are reported inclusive of Mineral Reserves.
2. CIM (2014) definitions were followed for Mineral Resources.
3. The Mineral Resource estimate is reported on a 100% ownership basis.
4. Mineral Resources are contained within a pit shell and are estimated in situ.
5. Mining dilution, mining losses, or process losses were not applied in estimating Mineral Resources.
6. Mineral Resources are estimated at a cut-off grade of 0.187 g/t Au Oxide and 0.291 g/t Au Mixed.
7. Metallurgical recovery is 70% for oxide material and 45% for mixed material.
8. Mineral Resources are estimated using a long-term gold price of US\$2,200 per ounce.
9. A minimum mining width of 6 m was used.
10. Bulk density is estimated by lithology and averages 2.38 g/cm³.
11. Mineral Resources that are not Mineral Reserves do not have demonstrated economic viability.
12. Numbers may not add due to rounding.



Table 1-2 summarizes the San Andrés Mine Mineral Resource estimate, exclusive of Mineral Reserves, as of December 31, 2024.

Table 1-2: Summary of Mineral Resource Estimate, Exclusive of Mineral Resources – December 31, 2024

Category	Oxide			Mixed			Total		
	Tonnage (000 t)	Au (g/t)	Contained Gold (000 oz)	Tonnage (000 t)	Au (g/t)	Contained Gold (000 oz)	Tonnage (000 t)	Au (g/t)	Contained Gold (000 oz)
Measured	1,070	0.27	9	387	0.54	7	1,457	0.34	16
Indicated	21,136	0.38	256	3,082	0.55	54	24,218	0.40	310
Measured + indicated	22,206	0.37	265	3,469	0.54	61	25,675	0.40	326
Inferred	6,921	0.42	94	1,629	0.56	29	8,550	0.45	123
Notes:									
1. Mineral Resources are reported exclusive of Mineral Reserves.									
2. See Notes 2 through 12 of Table 1-1.									

The QP is not aware of any environmental, permitting, legal, title, taxation, socio-economic, marketing, political, or other relevant factors that could materially affect the Mineral Resource estimate.

1.3.7 Mineral Reserves

The Mineral Reserve estimates for the San Andrés Mine, as of December 31, 2024, were prepared using the Pseudoflow optimization methodology. CIM (2014) definitions were used in classifying Mineral Reserves.

The estimated Proven and Probable Reserves total 30.66 Mt at an average grade of 0.44 g/t Au, containing 429,187 ounces of gold, comprising:

- Proven Reserves of 8.7 Mt grading 0.36 g/t Au, containing 101,495 ounces of gold.
- Probable Reserves of 22.0 Mt grading 0.44 g/t Au, containing 327,692 ounces of gold.

Mineral Reserves are estimated using cut-off grades that are differentiated by material type. The cut-off grade for oxide material is 0.215 g/t Au and for mixed material is 0.334 g/t Au.

Modifying factors, including geotechnical, environmental, and economic considerations, were applied to support reserve classification.

The key parameters used in estimating Mineral Reserves are listed:

- Gold price: US\$2,000/oz reflecting short-term market conditions and the remaining mine life of approximately four years.
- Metallurgical recovery: 70% and 45% for Oxides and Mixed materials, respectively, based on historical reconciliation data for heap leach processing.
- Dilution and Recovery: A dilution factor of 5% and mining recovery rate of 95% were applied, consistent with historical operational data and industry standards.



The Pseudoflow methodology integrates a detailed block model with operational and economic constraints to generate practical pit designs and production schedules. This approach ensures that reserve estimates are optimized for both economic viability and operational feasibility.

The Mineral Reserve estimate, effective as at December 31, 2024, is summarized in Table 1-3.

Table 1-3: Summary of Mineral Reserve Estimate – December 31, 2024

Category	Tonnage (000 t)	Tonnage (000 t)	Grade (g/t Au)	Contained Metal (oz Au)
Proven	Oxide	8,206	0.36	93,977
	Mixed	468	0.50	7,519
Total Proven	-	8,674	0.36	101,495
Probable	Oxide	20,696	0.46	305,410
	Mixed	1,286	0.54	22,282
Total Probable	-	21,981	0.46	327,692
Total Proven + Probable	-	30,655	0.44	429,187

Notes:

1. CIM (2014) definitions were followed for Mineral Reserves.
2. The effective date of the estimate is December 31, 2024.
3. The Mineral Reserve estimate is reported on a 100% ownership basis.
4. Mineral Reserves are estimated using an average long-term gold price of US\$2,000 per ounce
5. Mineral Reserves are reported as Run-of-Mine (ROM) material, after applying dilution (5%), mining recovery (95%), and operational adjustments incorporated into the final pit design. These adjustments include considerations for minimum mining widths, ramp placements, and geotechnical constraints to ensure practical mineability. The applied cut-off grades are 0.215 g/t Au for oxide material and 0.334 g/t Au for mixed material.
6. The bulk density of ore is variable and applied in the geological block model; it averages 2.7 t/m³.
7. The metallurgical recovery is 70% and 45% for Oxides and Mixed materials, respectively.
8. The Mineral Reserve did not consider any sulphide material
9. The average strip ratio is 0.45:1.
10. Numbers may not add due to rounding.

The QP is not aware of any mining, metallurgical, infrastructure, permitting, or other relevant factors that could materially affect the Mineral Reserve estimate.

1.3.8 Mining Method

The San Andrés Mine utilizes conventional open-pit mining methods, including drilling, blasting, loading, and hauling. Selective mining is applied where practical to improve ore recovery and reduce dilution. Grade control practices are consistent with good industry standards, ensuring effective ore classification and minimizing material misallocation. The key aspects of the mining methods and operation are outlined below:

- Pit Design and Layout:
 - The current pit design consists of seven phases, sequenced to balance stripping requirements, ore accessibility, and haulage efficiency over the mine life.
 - Mining benches are designed at 6-meter heights, aligning with the capabilities of the selected equipment fleet and operational safety considerations. Bench geometry is optimized for efficient loading, grade control, and geotechnical stability.



- **Equipment Fleet:**
 - The mining fleet includes a combination of hydraulic excavators, front-end loaders, and rigid-frame haul trucks. It is fully contractor-owned and operated.
 - Equipment selection is optimized for material handling efficiency, with periodic fleet assessments and replacements to maintain availability rates.
- **Material Handling:**
 - Ore is hauled to one of two primary crushers, where it is reduced to a suitable size for heap leach processing.
 - After crushing, the ore is transported to the HLP for gold extraction.
 - Waste material is hauled to designated storage areas, including external waste dumps and in-pit backfill locations, depending on operational requirements.
 - Waste rock storage facilities are designed with environmental considerations, including drainage control, slope stability measures, and erosion prevention supported by ongoing monitoring and management.
- **Dilution and Recovery Management:**
 - A dilution factor of 5% is applied, based on historical reconciliation data and operational performance. This accounts for unintentional waste inclusion during mining.
 - Mining recovery is estimated at 96%, considering ore losses due to operational constraints, geotechnical stability requirements, and selectivity limitation.
- **Operational Challenges and Mitigation:**
 - Steep pit slopes and geotechnical stability are managed through continuous monitoring, slope stability analysis, and targeted reinforcement measures such as bench scaling and drainage control.
 - Seasonal rainfall during the wet season (May to November) can impact mining operations; however, water management systems, including surface drainage channels, sumps, and pumping infrastructure, are in place minimize disruptions.
- **Production Rates:**
 - The operation targets an annual ore production rate of approximately 7.3 to 7.8 million tonnes of run-of-mine (ROM) ore from 2025 to 2028, with a decrease to 1.6 million tonnes in 2029, as the mine approaches closure.
 - Total material movement (ore + waste) ranges between 9.0 and 12.9 million tonnes per year, depending on stripping requirements and phase sequencing.
 - Gold grades vary between 0.37 and 0.50 g/t Au, with an expected in-situ gold content of 81 to 117 koz annually during the primary production years.
 - Estimated gold production, based on a 68% recovery rate (weighted average), is projected at approximately 55 koz to 79 koz per year from 2025 to 2028, declining to 12 koz in 2029.



1.3.9 Mineral Processing

The San Andrés Mine employs heap leaching for the recovery of gold from mined material. The processing facilities include two stages of crushing and screening, drum agglomeration, HLPs, an ADR plant for recovering the gold from solution, and gold-silver doré casting.

The Mine produces approximately 7 Mtpa of ROM material using conventional drilling, blasting, loading and haul truck transportation. The LOM production plan includes 7.6 Mt of material placed during 2025, 7.3 Mt in 2026, 2027 and 2028 and 1.6 Mt in 2029 for a total of 30.7 Mt. The material is mined and transported by haul truck to either the WRSFs or to the primary crushers for processing. The ore is direct dumped into the feed hoppers of two primary crushers operating in parallel. The primary crushed ore is conveyed to an intermediate stockpile. The ore is drawn from the stockpile from three draw points beneath the pile with feeders which discharge onto a conveyor that delivers the ore to secondary crushing. Lime and cement are added to the secondary crushed product on the conveyor and the material is conveyed to two drum agglomerators operating in parallel. Pre-cyanidation is practiced, dosing sodium cyanide on conveyor 8 after the agglomeration drums. The agglomerated material is conveyed to the HLP where it is placed using conveyor stackers. The placed material is leached with cyanide solution for a period of 60 days during which time, cyanide-soluble gold is dissolved into solution. After the first leach cycle the leached panel of material is allowed to rest and the entrained solution drains out of the material. After draining, a new lift of material will be stacked over the leached material and the process will be repeated.

The activated carbon in columns method (CIC) is used to recover the gold and silver from solution. Gold and silver are adsorbed onto the carbon until the carbon is loaded to capacity. The loaded carbon is transferred to the adsorption, desorption, regeneration (ADR) plant where the gold and silver are eluted from the carbon with a solution of caustic soda and alcohol under conditions of high temperature and pressure. The eluate is then passed through electrowinning circuits, and the gold and silver are recovered in the stainless steel mesh cathodes and precipitated sludge in the cells. The precious metal sludge is recovered from the cells, dried and retorted for mercury removal and recovery and smelted in a furnace to produce doré metal ingots for sale.

The eluted or stripped carbon is then regenerated in a high temperature kiln and returned to the carbon adsorption column circuit to adsorb more gold.

1.3.10 Project Infrastructure

The Mine currently has infrastructure to support its current operations and the LOM plan. Infrastructure includes water supply systems; energy supply via connection to the Honduran national power grid; on-site access roads; camp facility with capacity for 45 persons for contractors or visiting personnel; communications network including optical fiber, radio, and cellular services; and on-site warehousing, maintenance buildings and offices.

1.3.11 Market Studies

The primary commodity produced at the San Andrés Mine is gold, which is freely traded on global markets. The sale of gold from the mine does not rely on specific sales agreements or long-term contracts, allowing Aura Minerals to capitalize on prevailing market conditions.

- The reserve estimates for the San Andrés Mine are based on a long-term gold price of US\$2,000/oz, reflecting short-to-medium-term market trends.



- The price assumption aligns with consensus forecasts for gold in the medium term, justified by the Mine's remaining life of approximately four years.
- Industry comparisons indicate that US\$2,000/oz is at the higher end of pricing assumptions for reserve calculations, which is appropriate given the short mine life and the need to maximize recoverable value.
- The San Andrés Mine does not engage in hedging or forward sales contracts, ensuring exposure to spot market prices for gold.
- The Mine has established agreements with contractors and suppliers to support its operational needs. These include:
 - Mining Services: Provided by a Honduras-based contractor, awarded through a competitive tender process.
 - Explosives and Reagents: Long-term contracts ensure the reliable supply of key inputs such as cyanide, lime, and cement.
 - Energy: The connection to the national power grid has significantly reduced power costs, improving the mine's cost structure.

1.3.12 Environmental, Permitting and Social Considerations

SLR based its review on a desktop review and a site visit, including interviews with key environmental, social, and mining staff from Minosa.

Baseline Environmental Studies

The environmental impact assessment (EIA) (SRK, 1998) provides a detailed description of the baseline environment. It should however be noted that exploration and mining in the area and at site occurred from the 1930s through 1976, and the property was acquired by Minerales de Copán in 1983.

Acid base accounting (ABA) and metal leaching tests were conducted on ore, including spent ore, and waste rock samples. Results showed that there is limited potential for acid generation from ore samples, and that drainage from spent ore could contain low concentrations of aluminum, arsenic, and calcium.

There are no protected areas in the vicinity of the site. The closest protected areas are Protected Area Erapuca (wildlife refuge), located 8.5 km to the southwest of Minosa site, and National Park Montana de Celaque, located 27 km southeast of the Minosa Site.

Permitting

The Mine obtained the mining concession for San Andres I (355 ha) in 1983 issued by *Instituto Hondureño de Geología y Minas* (INHGEOMIN). The Mine's first environmental impact assessment (EIA) was completed in 1998. An initial environmental permit was issued in 2001 for the total project area (355 ha polygon). In addition, Aura has obtained secondary environmental licences (most of them, Operational Environmental Licences) for various/small polygons within the original permitted polygon.

Aura understands that this initial environmental permit (issued for the 355 ha polygon) is considered to be the overall lifetime environmental licence for the site (Aguilar Castillo Love 2024), and covers both the secondary environmental licences and the Buffa Zone. Aura submitted a request to the environmental authority to confirm if that is the case. SLR



understands that Aura is still waiting for the outcome of this administrative process. In the meantime, Aura obtained recently (January 2025) the permit to cut the trees in the Buffa Zone, supporting Aura's understanding related to the environmental lifetime licence. Furthermore, Aura's legal counsel indicates that in Honduras there is a positive administrative silence for environmental matters (as per the Administrative Procedure Law – Decree 152-87). This means that if the environmental authority does not approve/deny the request for the renewal of an environmental permit within the legal timeframe established as per the regulation, the principle of positive administrative silence applies, and the public administration is obliged to recognize the favourable legal effects of the submitted application.

For exploration, Aura has mining and environmental permits for the areas identified as San Andrés III and San Andrés IV. Furthermore, Aura understands that exploration for San Andrés I (covering the 355 ha polygon) is also allowed. Minosa has five wastewater discharges to the environment. The Mine has requested the wastewater discharge registration for one of them, identified as effluent discharge TDP6 (effluent from the HLP area) in March 2022. On September 15, 2022, Minosa and the National Environmental Impact Assessment Evaluation System (SINEIA, integrated by *Centro de Estudios y Control de Contaminantes*, CESSCO, INHGEOMIN and Minosa) signed the updated Provisional Protocol for Wastewater Discharge for this effluent discharge. Minosa understands based on the discussion with the regulators that this Protocol is the discharge authorization for this effluent discharge.

It appears that Minosa does not have enough capacity in the HLP area to manage the LOM projected material (Section 18.1). Therefore, additional permitting planning should be required.

Mitigation measures were specified by the Secretariat of Natural Resources and Environment (now MiAmbiente) to manage environmental impacts when approving the various secondary environmental licences. In addition, Aura has several environmental operating procedures in place.

Social Aspects

The area of influence (AOI) or surrounding communities that may interact with the Mine and its facilities include Azacualpa, San Andrés, San Miguel, Platanares, Ceibita, and El Equin located within or near the mining concession. Labour is sourced locally from the surrounding communities. Educational, medical, recreational, and shopping facilities are available in the Mine area. Management and specialized staff are sourced locally or internationally as required and available. Minosa engagement activities focus on providing these communities benefits through employment, local procurement, and social investment programs. These communities are mainly agricultural communities dedicated to coffee planting. Income is mainly from farming and mine-related activities (i.e., temporary and permanent employment and local procurement).

A municipal cemetery used by the communities was located adjacent to the existing pit. Due to geotechnical stability concerns and the strategic position of the cemetery for the Mine, an agreement with the communities in 2012 allowed for the relocation of this cemetery. Minosa signed agreements with communities to relocate the cemetery in 2015. A few families opposed the relocation of their ancestors' remains, which concluded with a Judicial Resolution ordering Minosa to complete the relocation. Minosa compensated all the affected families and fulfilled all the obligations per the agreements signed, and the relocation of the cemetery was completed in 2021. As part of the compensation process, Aura provided some houses/lots to these affected families in a new area called Nueva Azacualpa located around five kilometres to the southeast of the site.



Minosa has signed collaboration agreements with the direct AOI communities. It executed agreements with Azacualpa (2012), San Andrés (2012), and San Miguel (2021). These collaboration agreements seek to provide financial support to direct AOI communities through social investments in areas related to education, health, housing, and employment.

Managing high expectations from surrounding communities is one of the key social risks for Minosa. Communities have expressed concerns about pollution, noise, changes in land use, biodiversity loss and social conflicts, including blockades (Aura 2023a). SLR understands that to manage these risks, the Project has established dialogue tables with representatives from the central government, municipalities, local government, local companies, and Minosa to discuss topics related to the management of environmental impacts. Minosa also meets biweekly with the representatives of the AOI's communities to monitor Mine-related effects and commitment implementation (Aura 2022).

Aura achieved the Socially Responsible Company Seal from the Honduran Foundation for Corporate Social Responsibility, awarded to companies that achieve a minimum score of 80% in the analysis of seven environmental and social governance (ESG) topics (i.e., governance, human rights, labour practices, fair operational practices, environment, consumer-related issues, and active community participation).

SLR understands that no Indigenous Peoples are identified within the AOI of Minosa (Aura 2023).

Mine Waste, Water Management and Monitoring

Waste rock material is used for backfilling at Twin Hills pit or is deposited in the Twin Hills North Waste Rock Pile/Cerro Cortes Waste Rock Pile. The waste rock storage facilities (WRSF) do not show significant movements (TerrasarX radar), there are no relevant observations related to topographic monitoring (prisms), and the inclinometers were reported as damaged (Aura 2024a).

The Mine completes environmental site monitoring regularly. As part of the monitoring, water quality, air quality monitoring, noise monitoring, and terrestrial ecology monitoring are completed.

Minosa has undertaken a review of the water management system for the HLP, mostly focused on the capacity of the six ponds. The main findings of a draft report (SRK, 2024) indicated that i). operational practices should be amended to always maintain the design freeboard, ii). the current system has insufficient capacity to store the runoff resulting from the 1 in 100 years, 24-hour duration rainfall storm event, iii). the minimum pond volume recommended to replace Pond 5 is 400,000 m³, iv). approximately 20% to 30% of the HLP surface area cannot be expanded, and therefore, it is recommended that progressive closure of that area be initiated to reduce the volume of excess water to be treated and discharged, and v). installation of raincoats to reduced volume of water is recommended. SLR understands that this report is ongoing, and the final conclusions, and associated action plan are still to be determined.

A hydrologic assessment conducted by an external consultant in 2020 (Aquagea Consultores 2020) proposed the development and implementation of a water management plan for integrated management of surface runoff. Based on the review completed, Aura has established an ongoing action plan, and constructed to date 10,500 metres of channels, 30 culverts, and a lining of 3,300 m of channels.

Surface water quality and groundwater quality monitoring is undertaken. It appears there are 18 surface water quality monitoring locations at sedimentation ponds, natural watercourses and points established for monitoring of acid rock drainage. The procedure lists a total of 33



groundwater quality monitoring locations encompassing piezometers and French drain outlets from WRSFs. According to ICMA reports prepared by Aura, exceedances have been identified from time to time through the water quality monitoring program. SLR is not aware of any non-compliance expressed by the environmental authorities regarding water quality.

Closure

Aura has a 2024 Closure Plan compiled by *Consultoría e Ingeniería Félix* (CIFE) which was submitted to the regulator but has not yet been approved. Progressive closure is incorporated into the mine plan, with two years of active closure after mining and processing cessation and three years of post-closure monitoring planned. The Closure Plan states that it includes direct and indirect costs for physical closure and the treatment, monitoring and maintenance of water, as established by the regulatory authorities and in accordance with the Mine Closure Regulations. The amount was calculated to be \$31,371,695. The SLR QP makes no conclusions as to the adequacy of the closure cost estimate.

There are currently requirements under Honduras legislation for closure financial provisions (General Mining Law, Section 30, and Closure Planning Regulation, section 44-45). However, it is SLR's understanding that the closure financial provision has to be established once the closure plan is approved, which has not happened.

1.3.13 Capital and Operating Cost Estimates

All costs are expressed in Q3 2024 US dollars and are based on an exchange rate of HNL\$ 25.5 (Honduran Lempira) per US\$1.00.

The capital costs required to achieve the San Andrés Mineral Reserve LOM production were estimated by Aura and reviewed by the SLR QP to ensure alignment with the remaining life-of-mine (LOM) plan and operational strategy.

The capital cost estimate for the LOM period (2024-2029) includes sustaining capital required to maintain production and infrastructure (totalling approximately US\$7.3 million) and development capital associated with potential future expansion or future resource conversion (approximately US\$15.3 million), which is excluded from the financial analysis.

The Mine's all-in sustaining cost (AISC) is estimated at US\$1,493 per ounce of gold payable, with annual variations based on production levels and sustaining capital requirements.

- Capital Costs
 - Given the short remaining mine life of approximately four years, no significant development projects are planned.
 - All capital investments are focused on maximizing near-term operational efficiency and meeting regulatory requirements.
 - Primary investments focus on maintaining infrastructure, including HLP expansions, equipment maintenance, and tailings management improvements.
 - Planned sustaining capital expenditures for 2025 include upgrades to processing facilities and heap leach operations to ensure continuous ore processing.

Operating Costs were also estimated by Aura based on historical mine performance, current contractor agreements, and projected cost trends. The SLR QP reviewed the estimates for reasonableness and consistency with industry benchmarks.

- Operating Costs



- Cost Structure:
 - The total operating costs average \$11.82/tonne processed, with key components including:
 - Mining Costs: Fuel, haulage, drilling, and blasting represent the majority of mining expenses.
 - Processing Costs: Heap leach operations incur costs for reagents (e.g., cyanide, lime), water management, and power.
 - General and Administrative Costs (G&A): Labor, security, and site services.
 - Impact of Grid Power: The connection to the national power grid has reduced energy costs by approximately 31%, contributing significantly to operational cost savings.
 - The total operating costs average US\$1,247 per ounce of gold produced (include sales costs).
 - Sensitivity analyses demonstrate economic resilience even under lower gold price scenarios, supporting positive project economics.
 - Cost Control and Optimization
 - Long-term supply agreements for explosives, reagents, and other consumables ensure cost stability and reliable supply.
 - Continuous improvement initiatives include fleet optimization, energy efficiency programs, and enhanced grade control to reduce unit costs.



2.0 Introduction

SLR Consulting (Canada) Ltd. (SLR) was retained by Aura Minerals Inc. (Aura) to prepare an independent Technical Report (the Technical Report) on the San Andrés Mine (San Andrés or the Mine), located in the Department of Copán, Honduras. The purpose of this Technical Report is to disclose the Mineral Resource and Mineral Reserve estimates on the San Andrés Mine as of December 31, 2024. This Technical Report has been prepared in accordance with Canadian National Instrument 43-101 (NI 43-101) Standards of Disclosure for Mineral Projects. SLR qualified persons (QPs) visited the property from October 21 to 24, 2024.

Aura is a mid-tier gold and copper producer listed on the Toronto Stock Exchange (TSX) under the symbol ORA, the Brazilian Stock Exchange (B3) as AURA33, and the OTC Markets (OTCQX) under ORAAF. Aura operates in Honduras, Brazil, and Mexico. Its exploration projects are located in Brazil, Guatemala, and Colombia.

The San Andrés Mine, located approximately 210 km southwest of San Pedro Sula, Honduras, is an open-pit, heap leach operation that has been in production since 1983. The Mine is wholly owned by Aura's subsidiary, Minerales de Occidente, S.A. de C.V. (Minosa). The Mine has all the required infrastructure to support current operations and has actively managed its community engagements efforts.

This Technical Report documents the current Mineral Resource and Mineral Reserve estimates, life of mine (LOM) plan, economic analysis, and technical details. This Technical Report updates the NI 43-101 Technical Report prepared by Aura filed on SEDAR, which had an effective date of December 31, 2013, referred to as the 2014 Technical Report (Aura 2014). In 2024, the Mine produced 78,372 ounces of gold and 9,644 ounces of silver.

2.1 Sources of Information

This Technical Report was prepared by qualified persons (QPs) Benjamin Sanfurgo, Eduardo Zamanillo, Andrew P. Hampton, and Derek J. Riehm, as detailed in Table 2-1. The QPs Sanfurgo and Zamanillo visited the site from October 21 to 24, 2024. They were accompanied by SLR Senior Permitting and Environmental Specialist Liliana Escovar, who also visited the site under the direction of the QP Derek Riehm.

The purpose of the site visit was to validate the data, observe mining operations, and assess the current state of the Mine to ensure the accuracy of this Technical Report.

- Mr. Sanfurgo toured operational areas, project offices, process plant and mine laboratory; inspected various parts of the property geology and drilling sites to check coordinates; inspected the core handling facility; reviewed the sampling procedures; and interviewed key personnel involved in the collection, interpretation, and processing of geological data and preparation of the Mineral Resource estimates. Additionally, the QP checked the logs of seven drill holes and visually verified that assays from the database are consistent with the metal content in the same intervals.
- Mr. Zamanillo reviewed active mining operations, pit designs, equipment usage, and production sequencing. The QP also assessed drilling, blasting, and material handling practices along with the crushing, heap leaching circuits, and evaluated geotechnical stability measures and operational safety protocols. Additionally, the QP assessed key aspects of site environmental management, including the mine waste facilities, water management infrastructure, and implementation of community and environmental programs.



- Ms. Escovar supported the environmental review by inspecting water treatment facilities, waste management practices, mine waste facilities, and community engagement activities. Her findings were incorporated by Mr. Riehm into the environmental and permitting sections of this Technical Report.

The findings from this visit have been incorporated into the report to ensure that it reflects the current operational and environmental conditions of the San Andrés Mine.

Table 2-1: Qualified Persons and Responsibilities

QP, Designation, Title	Responsible for
Benjamin Sanfurgo, ChMC(RM), Managing Principal Geologist	1.1.1.1, 1.1.2.1, 1.3.1 to 1.3.6, 4 to 12, 14, 23, 25.1, 26.1.
Eduardo Zamanillo, M.Sc., MBA, ChMC(RM), Principal Mining Engineer	1.1, 1.1.1.2, 1.1.1.4, 1.1.1.6, 1.1.2.2, 1.1.2.4, 1.1.2.6, 1.2, 1.3.7, 1.3.8, 1.3.10, 1.3.11, 1.3.13, 2, 3, 15, 16, 18, 19, 21, 22, 24, 25.2, 25.4, 25.6, 26.2, 26.4, 26.6
Andrew P. Hampton, M.Sc., P.Eng., Senior Principal Metallurgist	1.1.1.3, 1.1.2.3, 1.3.9, 13, 17, 25.3, 26.3
Derek J. Riehm, M.A.Sc., P.Eng. Technical Director	1.1.1.5, 1.1.2.5, 1.3.12, 20, 25.5, 26.5
All	27

The documentation reviewed, and other sources of information, are listed at the end of this Technical Report in Section 27 References.



2.2 List of Abbreviations

Units of measurement used in this Technical Report conform to the metric system. All currency in this Technical Report is US dollars (US\$) unless otherwise noted.

μ	micron	kVA	kilovolt-amperes
μg	microgram	kW	kilowatt
a	annum	kWh	kilowatt-hour
A	ampere	L	litre
bbl	barrels	lb	pound
Btu	British thermal units	L/s	litres per second
°C	degree Celsius	m	metre
C\$	Canadian dollars	M	mega (million); molar
cal	calorie	m ²	square metre
cfm	cubic feet per minute	m ³	cubic metre
cm	centimetre	MASL	metres above sea level
cm ²	square centimetre	m ³ /h	cubic metres per hour
d	day	mi	mile
dia	diameter	min	minute
dmt	dry metric tonne	μm	micrometre
dwt	dead-weight ton	mm	millimetre
°F	degree Fahrenheit	mph	miles per hour
ft	foot	MVA	megavolt-amperes
ft ²	square foot	MW	megawatt
ft ³	cubic foot	MWh	megawatt-hour
ft/s	foot per second	oz	Troy ounce (31.1035g)
g	gram	oz/st, opt	ounce per short ton
G	giga (billion)	ppb	part per billion
Gal	Imperial gallon	ppm	part per million
g/L	gram per litre	psia	pound per square inch absolute
Gpm	Imperial gallons per minute	psig	pound per square inch gauge
g/t	gram per tonne	RL	relative elevation
gr/ft ³	grain per cubic foot	s	second
gr/m ³	grain per cubic metre	st	short ton
ha	hectare	stpa	short ton per year
hp	horsepower	stpd	short ton per day
hr	hour	t	metric tonne
Hz	hertz	tpa	metric tonne per year
in.	inch	tpd	metric tonne per day
in ²	square inch	US\$	United States dollar
J	joule	USg	United States gallon
k	kilo (thousand)	USgpm	US gallon per minute
kcal	kilocalorie	V	volt
kg	kilogram	W	watt
km	kilometre	wmt	wet metric tonne
km ²	square kilometre	wt%	weight percent
km/h	kilometre per hour	yd ³	cubic yard
kPa	kilopascal	yr	year



3.0 Reliance on Other Experts

This Technical Report has been prepared by SLR for Aura. The information, conclusions, opinions, and estimates contained herein are based on:

- Information available to SLR at the time of preparation of this Technical Report.
- Assumptions, conditions, and qualifications as set forth in this Technical Report.

For the purpose of this Technical Report, SLR has relied on ownership information provided by Aura in a legal opinion by Rodrigo Velazquez Rosales, Aura's Head of Legal (North America) and Head of Compliance, entitled Legal Opinion and dated February 24, 2025. SLR has not researched property title or mineral rights for the San Andrés Mine as we consider it reasonable to rely on Aura's legal counsel who is responsible for maintaining this information. This information has been used in Section 1.0 Summary and Section 4.0 Property Description and Location of this report.

SLR has relied on Aura for guidance on applicable taxes, royalties, and other government levies or interests, applicable to revenue or income from the San Andrés Mine in preparing the economic analysis to confirm the Mineral Reserves. As the San Andrés Mine has been in operation for over ten years, Aura has considerable experience in this area.

Except for the purposes legislated under provincial securities laws, any use of this Technical Report by any third party is at that party's sole risk.



4.0 Property Description and Location

The Mine is located in the Department of Copán in the interior highlands of western Honduras, approximately 210 km southwest of the city of San Pedro Sula within the Municipality of La Unión (Figure 4-1). The property is centered on latitude 14.76° North (UTM 1,632,640 m North) and longitude 88.94° West (UTM 291,085 m East).

4.1 Location

The San Andrés Mine is located in the interior highlands of western Honduras, within the Department of Copán and the Municipality of La Unión. The mine site is situated approximately 210 km southwest of San Pedro Sula and 340 km west of Tegucigalpa, the capital of Honduras. The geographic coordinates of the Project are approximately 14.76° North latitude and 88.94° West longitude, placing it in a region of moderate elevation and accessible terrain (WGS84 datum). Figure 4-1 shows the location of the Mine.

The Mine is located near several communities, which provide labor, services, and infrastructure support to the operation:

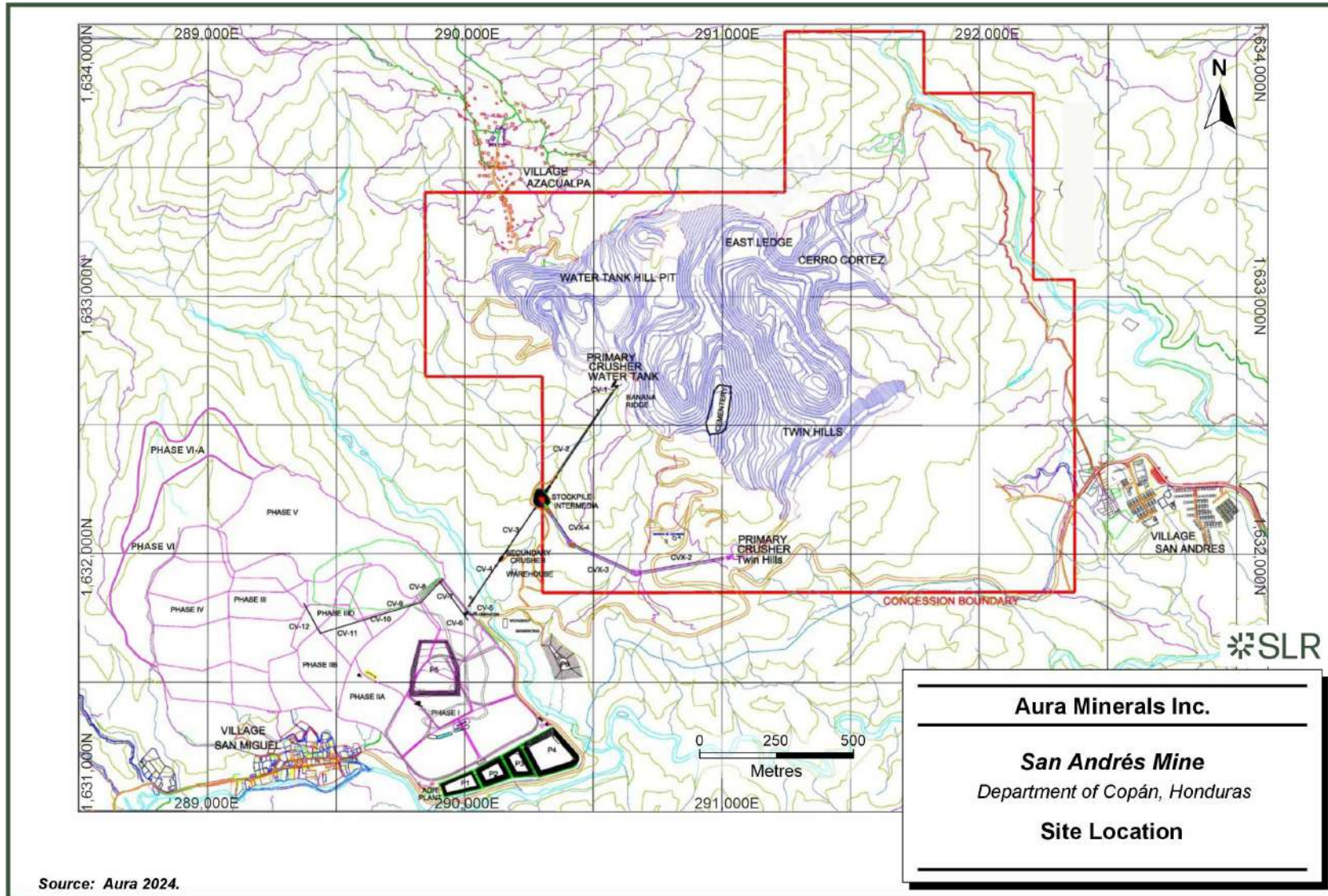
- Santa Rosa de Copán: With a population exceeding 40,000 people, Santa Rosa is the largest town in the region and the administrative and commercial center of the Department of Copán. The town offers healthcare, education, lodging, and logistics services, supporting the needs of both mine personnel and contractors.
- La Unión: The Municipality of La Unión is located closer to the mine and serves as the local administrative center, with smaller populations in villages such as San Andrés, San Miguel, Platanares, and Azacualpa. These communities are located within and proximal to the mining concession, as illustrated in the site layout map in Figure 4-2, and are part of ongoing social engagement programs.



Figure 4-1: Location Map



Figure 4-2: Site Location



4.2 Land Tenure

The San Andrés Mine property and associated mineral rights are held by Minosa, a wholly owned subsidiary of Aura. Minosa maintains the necessary mineral exploitation and exploration concessions, as well as surface rights, to support ongoing mining and processing activities.

4.2.1 Mining Concessions

The San Andrés I (SA I) mining concession covers an area of 355 hectares (3.55 km²) and was originally granted on January 27, 1983, to Compañía Minerales de Copán, S.A. de C.V (Minerales de Copán). The concession was later expanded and formalized in 1997, under the ownership of Greenstone Resources Ltd. (Greenstone), reaching its current area. The San Andrés I (SAI) is currently held by Minosa (Minerales de Occidente S.A. de C.V.) and was officially renewed in 2021 for a period of 30 years, extending its validity until 2051. This renewal was granted under the administrative mechanism of *Afirmativa Ficta*, as permitted by the Honduran *Ley de Procedimiento Administrativo*. The concession encompasses the area containing the current Mineral Resource and Mineral Reserve estimates.

To maintain the validity of the SAI concession, Minosa is required to pay an annual concession fee (canon territorial), in accordance with applicable Honduran mining regulations.

To support future exploration and potential expansion, Minosa submitted applications for five additional contiguous mining concessions in May 2002:

- San Andrés II (SAII) – 900 ha (application under review)
- San Andrés III (SAIII) – 864 ha (granted in 2020 for exploration, valid through 2030)
- San Andrés IV (SAIV) – 994 ha (granted in 2020 for exploration, valid through 2030)
- San Andrés V (SAV) – 1,000 ha (application under review)
- San Andrés X (SAX) – 1,000 ha (application under review)

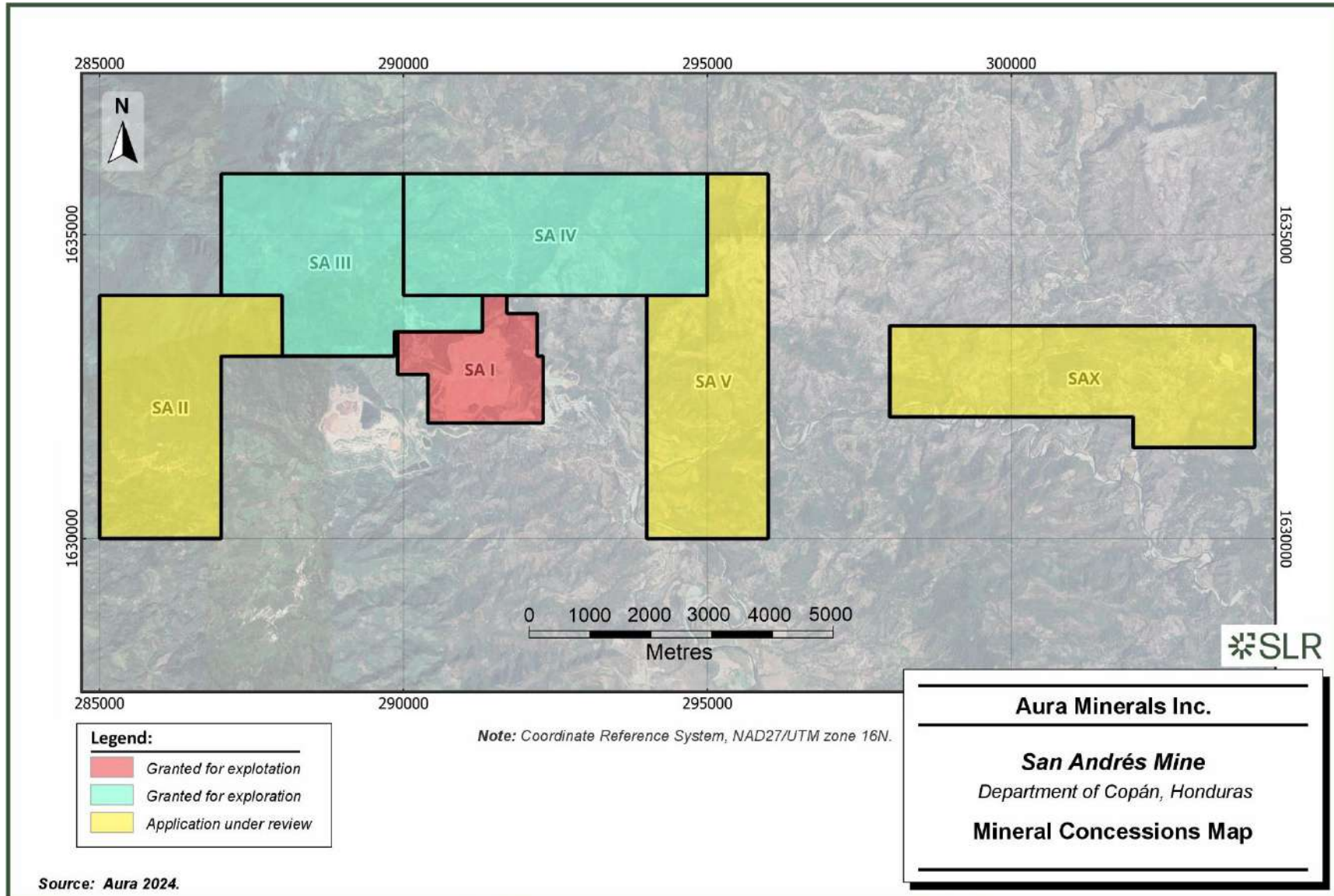
Minosa holds valid and active exploration rights for SAIII and SAIV, both authorized by INHGEOMIN for a 10-year period, with the ability to initiate exploitation activities upon formal notification to the authority. Applications for SAI, SAV, and SAX remain under review, with Minosa retaining preferential rights to these areas pending official resolution.

The combination of the SAI concession and the adjacent granted and requested areas creates a contiguous land package that secures long-term mineral tenure for current and future operations at the San Andrés Mine.

Minosa confirms that all mining concessions are held in accordance with Honduran law and are supported by appropriate environmental and operational permits, including a lifetime environmental license. The company has also confirmed, through legal counsel, that there are no outstanding legal disputes, encumbrances, or community access agreements that would materially affect the status or use of these concessions (Minosa 2025).



Figure 4-3: Mineral Concessions Map



4.2.2 Surface Rights

Minosa holds approximately 40% of the surface rights within the San Andrés I concession. The remaining land comprises government-owned property and community ejido lands, for which Minosa has secured access rights under the provisions of the Honduran Mining Law. Agreements with local communities, such as San Andrés, San Miguel, Platanares, and Azacualpa, ensure access to areas required for mining activities.

Minosa also privately owns surface rights for key infrastructure located outside the mining concession, including the secondary crusher, agglomerators, leach pad, and carbon-in-column (CIC) – adsorption, desorption and recovery (ADR) plant. Surface rights for the expansion of the leach pads and open-pit operations have been acquired, with additional negotiations in progress as part of the Mine’s long-term development plan.

4.2.3 Legal Framework

The granting of mining concessions, surface rights, and associated royalties is governed by the General Mining Law (Decree 238-2012) and its regulations, under the supervision of the INHGEOMIN. All mining activities also require compliance with the General Law of the Environment (*Ley General del Ambiente*, Decree 104-93) and municipal permitting processes.

4.3 Encumbrances

The San Andrés Mine operates in compliance with the Honduran General Mining Law (Decree 238-2012) and associated environmental regulations. The Mine holds all necessary permits for mining, processing, and associated activities, supported by approved Environmental Impact Assessments (EIAs) and Environmental Licenses. The current and future permitting requirements are summarized in Section 20.0.

4.4 Royalties

The San Andrés Mine operates under the Honduran General Mining Law (Decree 238-2012), which stipulates royalty payments and other taxes as follows:

- Special Mining Tax (IEM):
 - 5% of the FOB (Free on Board) value of the extracted metals, broken down as:
 - 2% for the Security Fee, paid to the national treasury.
 - 2% as a municipal tax, paid directly to the local municipal treasury where the mining operation is located.
 - 1% to the Honduran Mining Authority (*Instituto Hondureño de Geología y Minas*, or INHGEOMIN) to support mining regulation and research activities.
- Additional Fees: Mining operations are also subject to standard municipal operating permits and environmental compliance fees required for land use and resource extraction.

These royalty and tax obligations are integrated into the financial models of the Mine and ensure compliance with national legislation while contributing to regional and national development programs.



4.5 Other Significant Factors and Risks

Minosa holds all necessary permits and approvals required to conduct current operations and the proposed work program.

There are no known unmitigated environmental liabilities on the property. All historical disturbances have been addressed through previously approved Environmental Impact Assessments (EIAs) and associated mitigation measures. The Environmental Management Plan (EMP) remains in place and actively monitors compliance with reclamation and control programs.

Minosa has obtained the necessary mining and environmental permits for current operations, including active pits such as Falla A Phase 2, Banana Ridge, and other designated areas. Environmental licenses are up to date or in the process of renewal, where applicable, to ensure compliance with Honduran environmental regulations and the General Mining Law.

Minosa maintains clear and undisputed title to the San Andrés mining concession (San Andrés I, 355 ha) and additional exploration concessions granted in 2021 (San Andrés III and IV). The land tenure framework includes surface rights agreements and access permissions secured through negotiations with local communities and Honduran authorities. Pending applications for the San Andrés II and San Andrés V concessions remain under review, with Minosa retaining first rights to these areas.

The SLR QP is not aware of any significant legal, political, or technical risks that may adversely affect the:

- Access to the property.
- Title or tenure of the mineral rights and surface rights.
- The ability to conduct current operations or execute the proposed work program.

While there are localized risks related to seasonal rainfall and slope stability, these are actively managed through geotechnical monitoring, water diversion systems, and established Trigger Action Response Plans (TARPs).

The QP is not aware of any other significant factors and risks that may affect access, title, or the right or ability to perform the proposed work program on the property.



5.0 Accessibility, Climate, Local Resources, Infrastructure and Physiography

The San Andrés Mine, located in the western highlands of Honduras, has distinct geographical and environmental characteristics that influence its operations and accessibility.

5.1 Accessibility

The Mine can be accessed by well-maintained highways and secondary roads, ensuring reliable year-round access:

- The primary access route from San Pedro Sula, the country's second-largest city and a key economic hub, follows CA-4 Highway southwest towards the town of La Entrada. From La Entrada, the CA-4 highway continues towards Santa Rosa de Copán.
- Santa Rosa de Copán, located approximately 55 km east of the Mine by road, serves as a regional center with a significant population, providing essential services, accommodations, and infrastructure. From Santa Rosa, a combination of paved and well-maintained gravel roads leads directly to the mine site.
 - 28 km of paved highway from Santa Rosa de Copán to the town of Cucuyagua.
 - 22 km of gravel road from Cucuyagua to the Mine. While this gravel road is a public route, Minosa voluntarily maintains it to ensure safe and reliable access for vehicles, as well as for the benefit of the local community.
- Travelers departing from Tegucigalpa can take CA-5 Highway north to Comayagua and then connect to CA-7 Highway westbound towards Santa Rosa de Copán. This route, spanning approximately 340 km, takes about 6 to 7 hours by vehicle. The final approach to the Mine follows the same route described above, connecting through Santa Rosa de Copán.

The road network leading to the San Andrés Mine is fully accessible for passenger vehicles, heavy trucks, and mine-related equipment, which facilitates the transportation of materials, supplies, and personnel.

San Pedro Sula is served by Ramón Villeda Morales International Airport (SAP), providing daily flights to major destinations in the United States and Latin America. For Tegucigalpa, international flights are now routed through Palmerola International Airport (XPL) in Comayagua, approximately 80 km northwest of the city, while Toncontín Airport (TGU) primarily serves domestic flights. These airports ensure reliable access for personnel and supplies.

San Pedro Sula is also 40 km from Puerto Cortés, the main seaport in Honduras, located on the Caribbean Sea. Puerto Cortés facilitates the import and export of goods and materials required for the mine's operations.

This infrastructure supports the transport of equipment, supplies, and personnel to and from the mine. The connectivity to both major urban centers and regional hubs, combined with proximity to international transport routes, ensures smooth logistical operations for the San Andrés Mine.

5.2 Climate

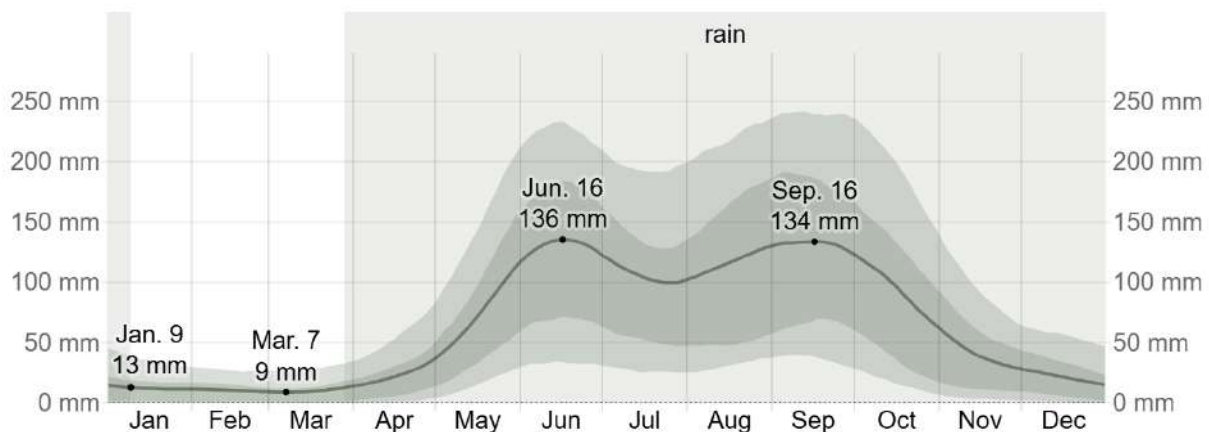
The Mine lies within the Interior Highlands of Honduras with a temperate climate. The nearest weather station is 18 km east of the Mine and data has been collected since 1953. The weather station has a similar elevation to the Mine.



Average annual precipitation ranges between 1,300 and 1,500 mm (Aquagea 2020), and there are distinct wet and dry seasons that influence mining operations and planning.

- **Rainy Season:** Locally referred to as "winter," the rainy season extends from May to November. During this period, the region experiences heavy rainfall, with the wettest months being June and September, recording average rainfall of 136 mm and 134 mm, respectively. The highest monthly rainfall recorded was 551 mm in August 1995. The 2-year, 10-year, and 100-year precipitation events were calculated to be 81 mm, 121 mm, and 216 mm respectively.
- **Dry Season:** The driest months are January and February, with minimal rainfall of 13 mm and 9 mm, respectively. These months allow for uninterrupted mining activities and logistical operations.
- Figure 4-1 presents the seasonal rainfall trends at San Andres Mine, The average rainfall (solid line) accumulated over the course of a sliding 31-day period centered on the day in question, with 25th to 75th and 10th to 90th percentile bands. The thin dotted line is the corresponding average snowfall.

Figure 5-1: Seasonal Rainfall and Temperature Trends at San Andrés Mine



Source: Weatherpark.com 2025

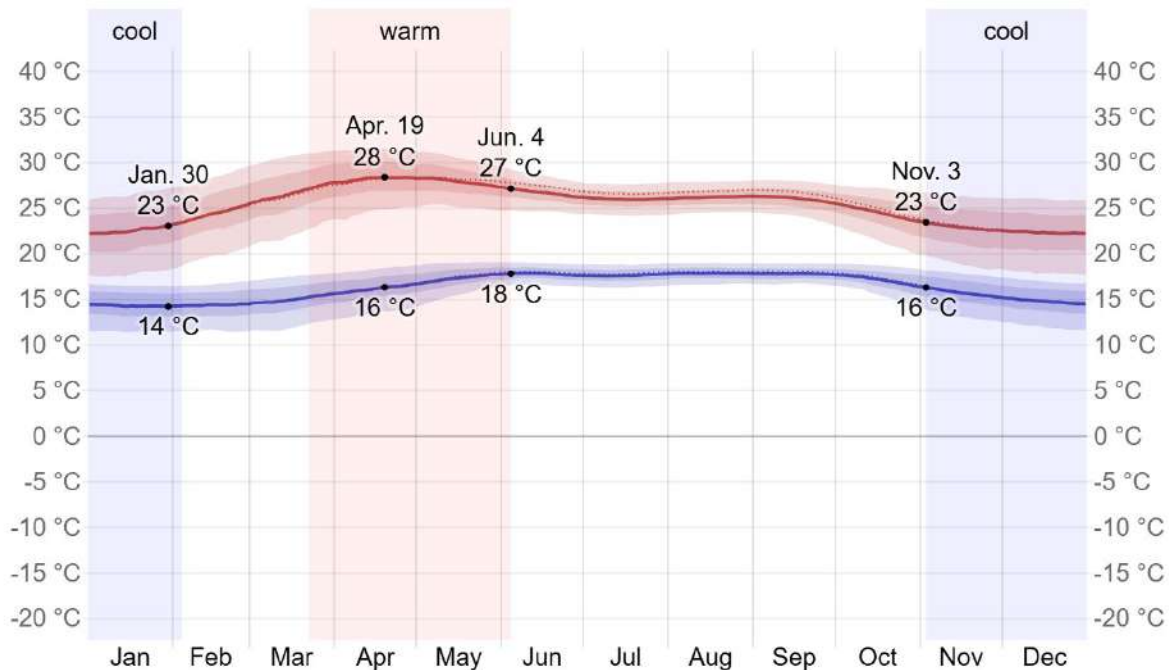
The Mine enjoys moderate temperatures throughout the year.

- The warm season lasts for approximately 2 and a half months, from mid-to-late March to early June, with an average daily high temperature above 27°C. The hottest month of the year in Santa Rosa de Copán is May, with an average high of 28°C and low of 17°C.
- The cool season lasts for approximately 3 months, from early November to early February, with an average daily high temperature below 23°C. The coldest month of the year in Santa Rosa de Copán is January, with an average low of 14°C and high of 23°C.

Figure 4-2 presents the daily average high (red line) and low (blue line) temperatures, with 25th to 75th and 10th to 90th percentile bands. The thin dotted lines are the corresponding average perceived temperatures.



Figure 5-2: Summary of Climatic Data for the San Andrés Mine (Monthly Averages)



Source: Weatherpark.com 2025

Annual evaporation varies between 825 mm and 1,296 mm, indicating a balance between rainfall and water loss through evaporation.

Wind blows predominantly from the north and is constant, with little variation. Average annual wind speed is 9.6 km/h. While not extreme, these conditions help mitigate heat buildup and ensure adequate ventilation around mining and processing areas. Honduras lies within a hurricane belt; however, the Mine location is generally unaffected (SRK 1998).

The heavy rainfall during the wet season occasionally limits accessibility and may delay certain mining activities. Historically, the Mine has observed a reduction of 6% in available production hours during the wettest months due to weather-related challenges.

The San Andrés Mine can operate year-round with minimal weather related disruptions.

5.3 Local Resources

The San Andrés Mine benefits from a network of local and regional resources that support its operations.

- Honduras and neighboring Central American countries host several mining operations, leading to the establishment of branch offices and facilities by international contractors and suppliers. Domestic contractors and suppliers also play a significant role in providing necessary services.
- Essential materials such as cement and fuel are sourced from Honduran companies.
- Components and supplies from major centers in North and South America can be delivered to the site within reasonable timeframes, facilitated by efficient logistics and transportation networks.
- Numerous communities in the immediate vicinity provide a local workforce.



- Management and technical personnel are recruited both regionally within Central America and internationally from North and South America. Aura maintains a corporate office in Canada, staffed with experienced geologists and engineers who provide technical support and oversight for all its projects, including the San Andrés Mine.
- The surrounding communities are equipped with educational, medical, recreational, and shopping facilities, contributing to the well-being of the workforce and their families.

5.4 Infrastructure

The San Andrés Mine, operational since 1983, has the necessary infrastructure to support its mining activities. Key components include:

Power Supply:

- In year 2015, the Mine successfully connected to the national power grid managed by Empresa Nacional de Energía Eléctrica (ENEE). This transition significantly reduced power costs by approximately 31%, enhancing the Mine's operational efficiency. The current setup allows for power to be purchased from the grid, while maintaining on-site diesel generators as backup to ensure reliability during grid outages or maintenance periods.
- On-site diesel power generation remains in place to provide additional energy security. This dual power system ensures uninterrupted operations, even during peak demand or unexpected disruptions in grid power.
- The proximity of the Platanares Geothermal Power Plant, located in La Unión, Copán, presents potential opportunities for incorporating renewable energy into the Mine's power mix in the future. This geothermal facility, with a capacity of 35 MW, underscores the region's advancements in sustainable energy.

Water Supply:

- Process Water: Sourced from rainwater runoff collected in a surge pond and supplemented by direct pumping from a station on the perennial Río Lara, adjacent to the CIC-ADR plant. Flow measurements indicate that the Río Lara maintains a flow rate exceeding 100 m³/h even during the driest periods, ensuring a reliable water supply for processing needs.
- Potable Water: Chlorinated water for the town of San Andrés and on-site camp facilities is stored in a 72,000-gallon tank. This tank is fed via a 4-inch, 17-km metal pipeline originating upstream along the Río Lara near the village of La Arena. Additionally, purified water for drinking and cooking is procured from local suppliers.

Facilities:

- Operational Facilities: The site is equipped with warehouses, maintenance facilities, an assay laboratory, and on-site camp accommodations for management, staff, and contractors, ensuring efficient daily operations.
- Communication Systems: Comprehensive communication infrastructure includes radio, telephone, internet, and satellite television services, facilitating seamless coordination and connectivity.



5.5 Physiography

The San Andrés Mine is located within the western Interior Highlands topographical province of Honduras, a region characterized by its mountainous terrain, moderate relief, and relatively steep slopes. The area is predominantly covered with short grasses and open forests of pine and oak, providing a mix of natural habitats and rugged landscapes.

The elevation across the mine site ranges from approximately 750 masl to 1,300 masl, with steep slopes and moderate overall topographic relief. These conditions influence both the hydrology and accessibility of the area, requiring careful engineering and environmental planning for mining operations.

The Mine lies within the Río Lara catchment basin, a regional watershed system. The Mine's operational footprint represents only a small portion of this basin, and all streams and watercourses within the Mine's vicinity are perennial, flowing year-round. The principal drainages include:

- Quebrada de San Miguel: Located to the north of the Mine, this stream flows southeast and east, eventually joining the Quebrada del Agua Caliente.
- Quebrada del Agua Caliente: Situated along the eastern boundary of the San Andrés I concession area, it drains southeast into the Río Lara.
- Río Lara: Positioned immediately south of the processing facilities, it flows eastward into the Río Higuito, approximately four kilometers southeast of the mine site.
- Quebrada de Casas Viejas: Draining the southwestern portion of the mine site area, this creek also flows southeast to join the Río Lara.

These streams form an interconnected drainage network, ultimately discharging into the Río Higuito. This system emphasizes the importance of water management practices to ensure minimal environmental impact and compliance with regulatory standards.

The region's vegetation, dominated by grasses and open woodlands, supports diverse ecological functions while providing areas for grazing and forestry. The natural cover also helps stabilize slopes and mitigates soil erosion in steeply sloped regions.

This physiographic setting plays an important role in shaping the mine's environmental management strategies and operational designs. The integration of hydrological studies and topographical planning ensures that the mine operates sustainably within this unique and rugged landscape.



6.0 History

The San Andrés Mine has a rich history that reflects its role as a significant gold producer in Honduras. The mine has evolved from small-scale underground operations to a modern open-pit, heap leach operation.

6.1 Prior Ownership, Exploration and Development History

The following historical ownership summary is based on prior technical reports prepared for the San Andrés Mine (Aura 2014). While the core content remains unchanged, certain details have been updated to reflect newly available information and to ensure consistency with the current report.

The San Andrés area is reported to be the site of the first Spanish gold discovery in Honduras, with initial production commencing in the early 1500s. For centuries, efforts to exploit small gold deposits hosted in quartz veins were undertaken, resulting in the development of adits, drifts, shafts, declines, and prospect pits, many of which remain visible today. Local populations extensively mined the streams in the area for placer gold (Malouf 1985).

Exploration during the 1930s and 1940s was carried out in the property area by various companies, including Gold Mines of America and the New York and Honduras-based Rosario Mining Company (Rosario). These efforts included the development of over 3,140 m of underground drifts and cross-cuts within zones of epithermal quartz veins and quartz stockwork. During this time, Gold Mines of America operated a small amalgamation plant between 1936 and 1937.

In 1945, the property was acquired by the San Andrés Mining Company, which was subsequently purchased by the New Idria Company (Malouf 1985). New Idria installed a cyanide circuit with a capacity of 200 short tons per day in 1948, transporting all equipment by air to an airstrip located at Platanares. Over the years, approximately 300,000 short tons of surface ore and 100,000 short tons of underground ore, averaging 5.8 g/t gold, were mined and milled by New Idria. In 1949, the San Andrés operation pioneered the use of carbon-in-pulp (CIP) technology to recover gold and silver using granular carbon. However, logistical challenges, high underground mining costs, and insufficient air travel support caused the operation to cease by 1954.

In 1969, exploration in western Honduras, including the San Andrés property, was restricted by the Honduran Government and the United Nations for study purposes, effectively halting activities in the area. This restriction covered 10,800 km² and was lifted in 1974, reopening the region to exploration (Malouf 1985).

An exploration permit was granted in 1974 to Minerale, SA de CV (MINSA), a subsidiary of Noranda. MINSA entered a joint venture with Rosario to conduct soil sampling, mapping, and trenching to identify a large, disseminated, open-pit gold deposit. These activities indicated a resource potential of approximately 20 million short tons grading 2.83 g/t gold (Malouf 1985). However, changes in Honduran tax laws in 1976 forced MINSA to abandon the concession. In 1983, Compañía Minerale de Copán, SA de CV (Minerale de Copán) acquired the property following a tax law revision. Minerale de Copán installed a small-scale heap leach operation with a capacity of 60 short tons per day, employing 170 local residents in a rudimentary operation involving shovels and wheelbarrows.

In 1993, Fischer-Watt Gold Company Inc. (Fischer-Watt) took an interest in the property as part of a Honduran grassroots exploration program, acquiring an option from Minerale de Copán.



After conducting additional mapping and sampling programs with promising results, Fischer-Watt transferred the option to Greenstone in 1994. Greenstone exercised the option in 1996, acquiring over 99% ownership of Minerales de Copán. Feasibility studies initiated in 1996 culminated in a 1997 plan to mine the Water Tank Hill deposit, expand the existing open-pit mine, and construct new heap leach facilities. Additional infrastructure included a conveyor system, waste rock disposal areas, spoils piles, haul roads, and a landfill. This project required relocating the village of San Andrés. Proposed production was set at 2.1 million tonnes per annum (Mtpa) of ore, with a mine life of seven years. Infrastructure was designed to process more than 3.5 Mtpa of ore and waste.

Mining operations were suspended in May 1997 to focus on construction. Key developments included improvements to access roads, the construction of leach pads and spoils piles, and the relocation of the village. The Secretary of State in the department of the Environment (*Secretaría de Estado en el Despacho del Ambiente*, SEDA) approved these activities. Mining resumed in early 1999, with the first gold shipment on March 30, 1999. At its peak, the mine employed 344 individuals, including 10 expatriates, with the majority of the workforce sourced from nearby communities.

Greenstone ceased mining and crushing operations in December 1999 due to cash flow issues. By March 2000, management had largely departed, leaving a skeleton crew to maintain site permits and leaching operations. The project's rights and obligations were transferred to Banco Atlántida, a Honduran bank, which facilitated a bridge loan in June 2000, enabling the formation of Minosa to assume operations.

Minosa resumed mining in August 2000, with management services provided by RNC Gold Inc. (RNC). At the time, San Andres (Belize) Limited owned 75% of Minosa, with the remaining 25% held by Banco Atlantida. On September 7, 2005, RNC purchased 100% of the San Andrés Mine by acquiring all remaining shares of Minosa. The transaction valued the Mine at US\$22.5 million, with San Andrés (Belize) Limited selling its 75% stake for US\$ 12.0 million plus a net smelter royalty (NSR). The NSR terms were 1% on the first US\$20.0 million of annual revenue, reducing to 0.5% thereafter, with a cumulative cap of US\$1.5 million, which has since been fulfilled.

On February 28, 2006, Yamana Gold Inc. (Yamana) acquired RNC, obtaining a 100% beneficial interest in Minosa. The transaction was funded through an \$18.9 million senior secured loan to RNC, but Yamana's acquisition of RNC was completed via a share transaction. Finally, Aura acquired 100% of Minosa on August 25, 2009, consolidating its ownership of the San Andrés Mine.

6.2 Historical Resource Estimates

Any historical resource estimates have been superseded by the current Mineral Resource estimates in 14.0 Mineral Resources Estimates in this Technical Report.

6.3 Past Production

Gold production at the San Andrés Mine began in 1983 as a small-scale heap leach operation. Early years saw low processing volumes, with annual ore leaching rates below 150,000 tonnes and gold recoveries averaging between 1,000 and 5,000 ounces per year.

A significant increase in production occurred in 1999, when large-scale mining operations were introduced. Annual ore processing exceeded 1.3 million tonnes, and gold recoveries reached



approximately 42,455 ounces. This expansion marked a transition from small-scale to commercial mining.

From 2000 to 2009, production continued to scale up, with annual ore processing volumes fluctuating between 2.3 million and 4.5 million tonnes, depending on mining conditions and operational constraints. Gold recoveries during this period ranged from 50,000 to over 100,000 ounces per year.

Following Aura Minerals' acquisition in 2009, further investments were made in processing facilities, heap leach pad expansions, and mining fleet capacity, resulting in increased ore tonnage and operational efficiency. Between 2010 and 2024, the mine consistently processed between 4.0 and 8.5 million tonnes of ore annually, with gold recoveries varying based on grade fluctuations and heap leach performance.

In recent years (2020–2024), total ore tonnage reached its highest levels, exceeding 7 million tonnes annually in 2023 and 2024. However, gold grades have gradually declined from an average of 0.538 g/t Au in 2020 to 0.435 g/t Au in 2024, reflecting the natural depletion of higher-grade zones. Despite this, improved operational efficiencies and heap leach performance have maintained annual gold recoveries between 60,000 and 88,000 ounces per year.

The historical production trends in Table 6-1 illustrate the Mine's evolution from a small-scale operation to a well-established open-pit mine, with steady production levels maintained through ongoing operational improvements and strategic mine planning in the last years.

Table 6-1: Production History – 1983 to 2024

Year	Ore Leached (Tonnes)	Grade (g/t Au)	Gold Recovered (oz)	Silver Recovered (oz)
1983	21,480	-	-	-
1984	22,459	2.12	1,388	575
1985	22,332	2.46	1,433	636
1986	29,120	3.08	2,510	750
1987	40,178	2.46	2,710	806
1988	56,154	2.21	2,957	803
1989	76,209	1.87	3,406	1,247
1990	105,598	1.37	3,495	1,120
1991	133,084	1.93	4,813	1,385
1992	129,647	1.09	3,737	944
1993	138,766	1.15	4,607	1,100
1994	138,083	1.06	4,291	739
1995	130,956	0.93	3,482	708
1996	127,801	1.21	4,504	1,242
1997	42,885	0.87	1,048	262
1998	-	-	-	-
1999	1,357,544	2.04	42,455	44,392



Year	Ore Leached (Tonnes)	Grade (g/t Au)	Gold Recovered (oz)	Silver Recovered (oz)
2000	-	-	6,006	7,477
2000	719,631	1.85	17,508	22,841
2001	2,289,276	1.75	105,775	131,201
2002	3,378,116	1.09	99,064	108,694
2003	2,891,890	0.63	50,795	35,421
2004	3,793,870	0.69	65,032	18,502
2005	3,392,092	0.72	61,236	16,488
2006	3,732,049	0.70	70,779	-
2007	2,910,904	0.52	51,240	34,992
2008	3,567,279	0.58	47,761	17,636
2009	4,530,009	0.68	68,372	34,406
2010	4,913,900	0.70	70,641	52,394
2011	4,312,947	0.68	60,871	38,208
2012	4,263,953	0.64	59,751	41,487
2013	5,370,142	0.58	63,811	34,765
2014	6,167,074	0.476	88,813	61,917
2015	6,149,421	0.494	83,521	67,609
2016	6,459,139	0.474	78,327	45,325
2017	6,699,350	0.453	82,270	58,995
2018	6,065,192	0.467	63,603	48,346
2019	5,172,717	0.515	58,374	25,193
2020	4,005,298	0.538	60,769	26,036
2021	5,611,373	0.557	88,410	20,158
2022	5,485,383	0.488	61,439	21,230
2023	7,095,956	0.445	65,928	17,390
2024	8,544,997	0.435	78,372	9,644

Silver has historically been recovered as a byproduct of gold production at San Andrés, with reported recoveries included in operational records through 2024, as shown in Table 5-1. However, due to its low economic contribution relative to gold, silver is not a primary focus of the operation and is not modeled in the geological block model. Consequently, silver grades and recoveries are not considered in the Mineral Resource or Mineral Reserve estimates presented in this report. While silver continues to be recovered in trace amounts during gold processing, it is not included in pit optimization or Mineral Reserve estimate disclosures, as its contribution to overall project economics is not considered material.

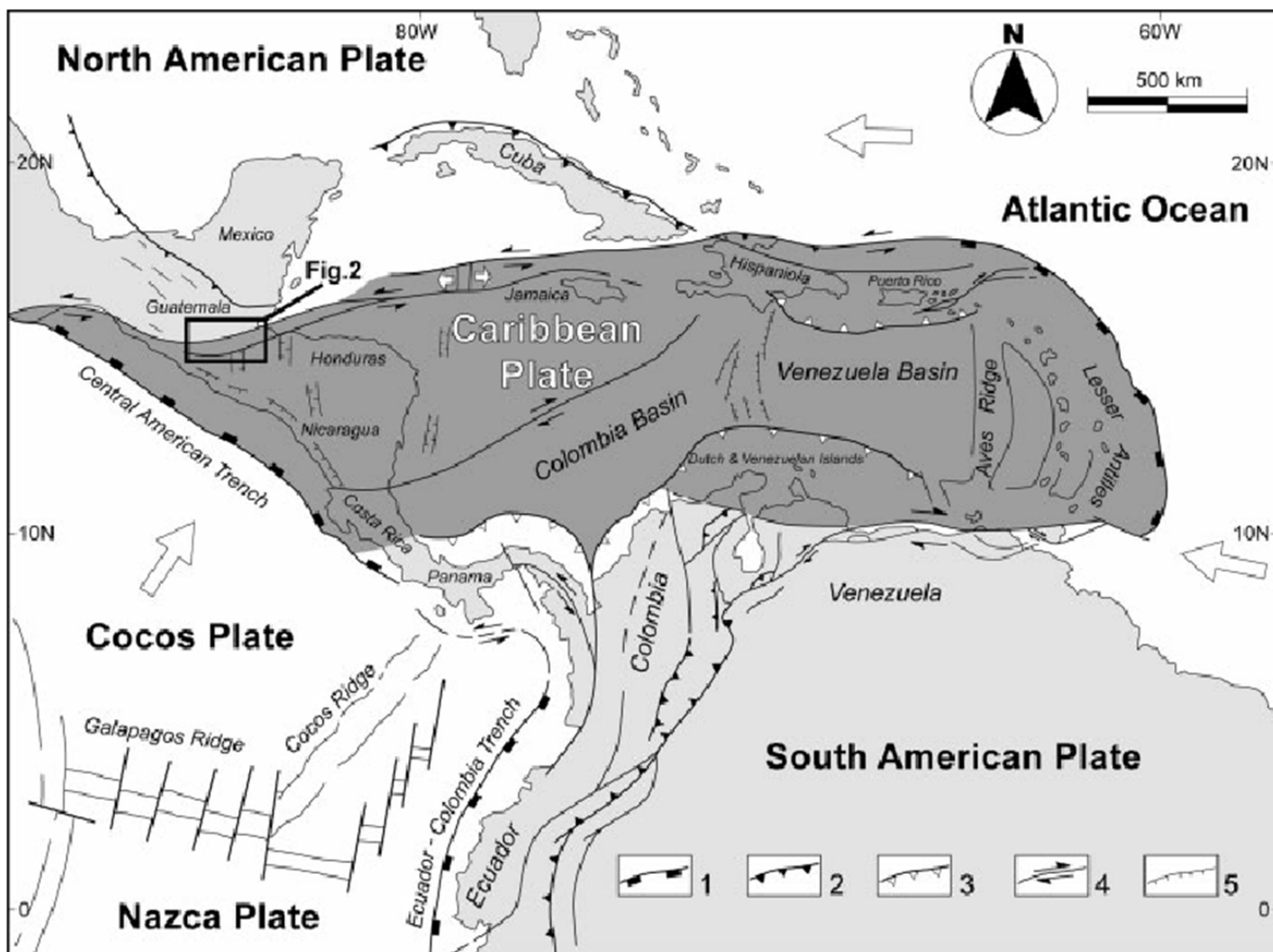


7.0 Geological Setting and Mineralization

7.1 Regional Geology

Five lithospheric plates form boundaries in the region. Most of Central America between Guatemala and Costa Rica lies on the Caribbean Plate. The San Andrés Mine is located on the northern edge of the Caribbean Plate at the boundary with the North American Plate. A chain of active volcanoes situated along the Pacific coast from Guatemala to Costa Rica marks the subduction zone which lies between the Cocos and Caribbean plates along the Middle American Trench. Figure 7-1 shows the regional structural setting of the Caribbean plate.

Figure 7-1: Regional Structural Setting of the Caribbean Plate



Source: from Giunta et al. 2003:

The boundary between the Caribbean and North American plates in Central America is marked by the Motagua Suture Zone. The suture zone is approximately 80 km wide and extends through Honduras and Guatemala. Three major faults are recognized within the zone: the Polochic Fault, the Motagua Fault, and the Jocotan Fault. These faults are predominantly strike-



slip with left-lateral movement and are seismically active. The Motagua Suture Zone is terminated to the west by the Middle America Trench, marking the boundary with the Pacific plate.

The strike-slip faults forming the Motagua Suture Zone extend offshore to the east and form the Cayman Trough. The Cayman Trough formed as a result of strike-slip faulting on the Swan Islands Fault and the Oriente Fault. The Swan Islands Fault and the Oriente Fault are transform faults that form respectively, the southern boundary and the northern boundary of the Cayman Trough. The Cayman Trough is approximately 100 km wide and extends from the coast of Honduras to Hispaniola on the east, cutting through the Oriente Province in southeast Cuba (Gordon 1997). The trough terminates at the Puerto Rico Trench. The Cayman Trough and the Motagua Suture Zone extend over a distance of about 2,500 km from the Puerto Rico Trench to the Middle America Trench on the west. The Cayman Trough contains a slow-spreading center, referred to as the Mid Cayman Rise (Ten Brink et al. 2002). This feature is oriented north-south and connects the transform faults forming the boundaries of the Cayman Trough. It is a major extensional fracture formed at the same time as the strike-slip faults. Both of these structural elements result from the relative movements of the North American and Caribbean plates. Rock samples collected from the rise are largely basaltic in composition. The Mid Cayman Rise is a zone of high heat flow, which is typical of spreading centers. Further evidence of the formation of north-south extensional fractures is also demonstrated from mapping in the vicinity of the Oriente Fault in Southeast Cuba (Rojas-Agramonte et al. 2003) and is exemplified by karst-filled extensional veins and normal faults.

7.2 Local Geology

Honduras can be divided geologically into three zones. The northern third of the country, the Cordillera Del Norte, generally consists of Permian metamorphic rocks ranging in age from 280 to 225 Ma. The central third of the country, the Cordillera Central, consists primarily of Cretaceous sedimentary rocks ranging in age from 136 to 65 Ma. The southern third of the country, the Cordillera del Sur, is dominated by Tertiary volcanic rocks that range in age from 65 to 2 Ma. A generalized geological map is shown in Figure 7-2 and a stratigraphic section is shown in Figure 7-3.



Figure 7-2: District Geology

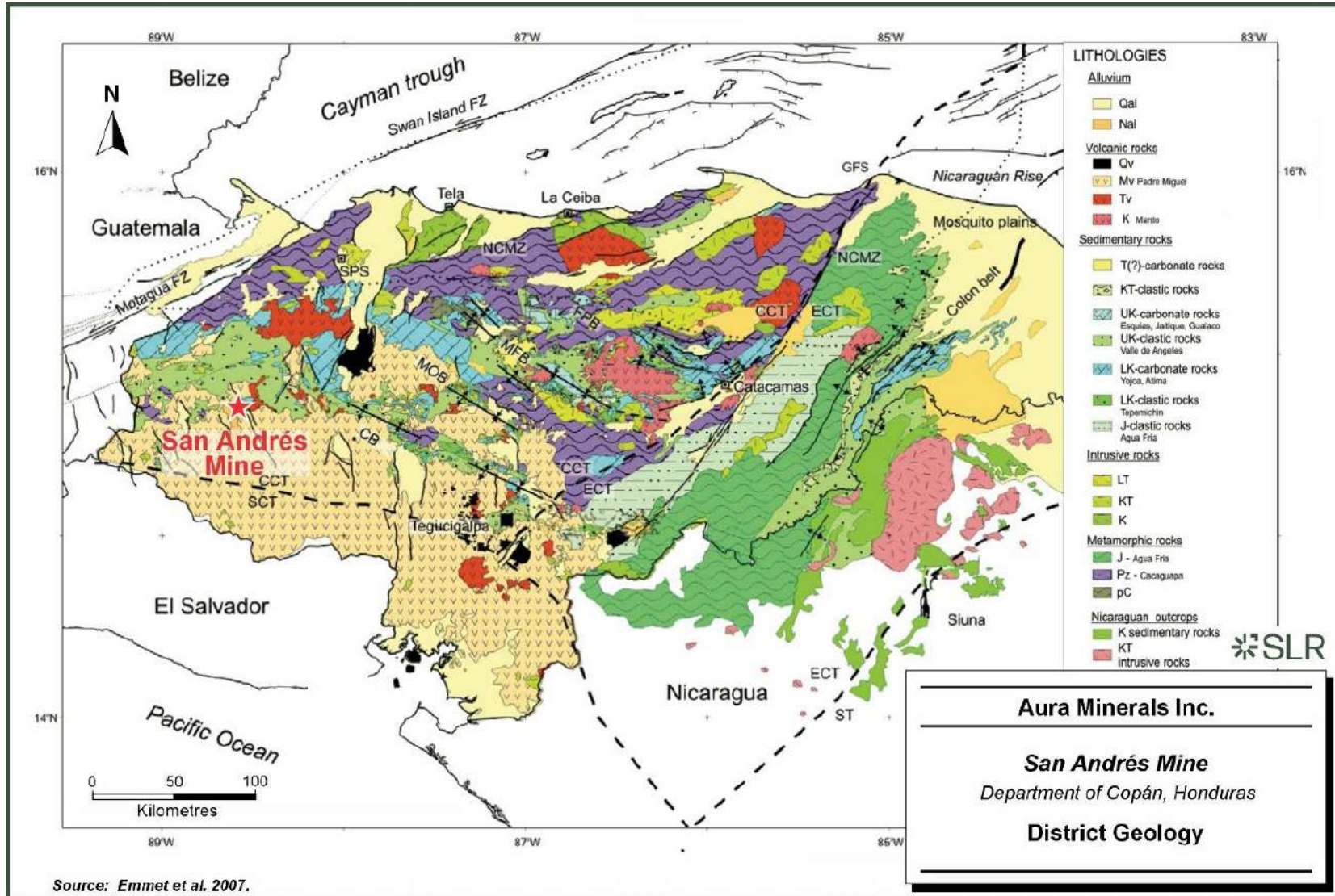
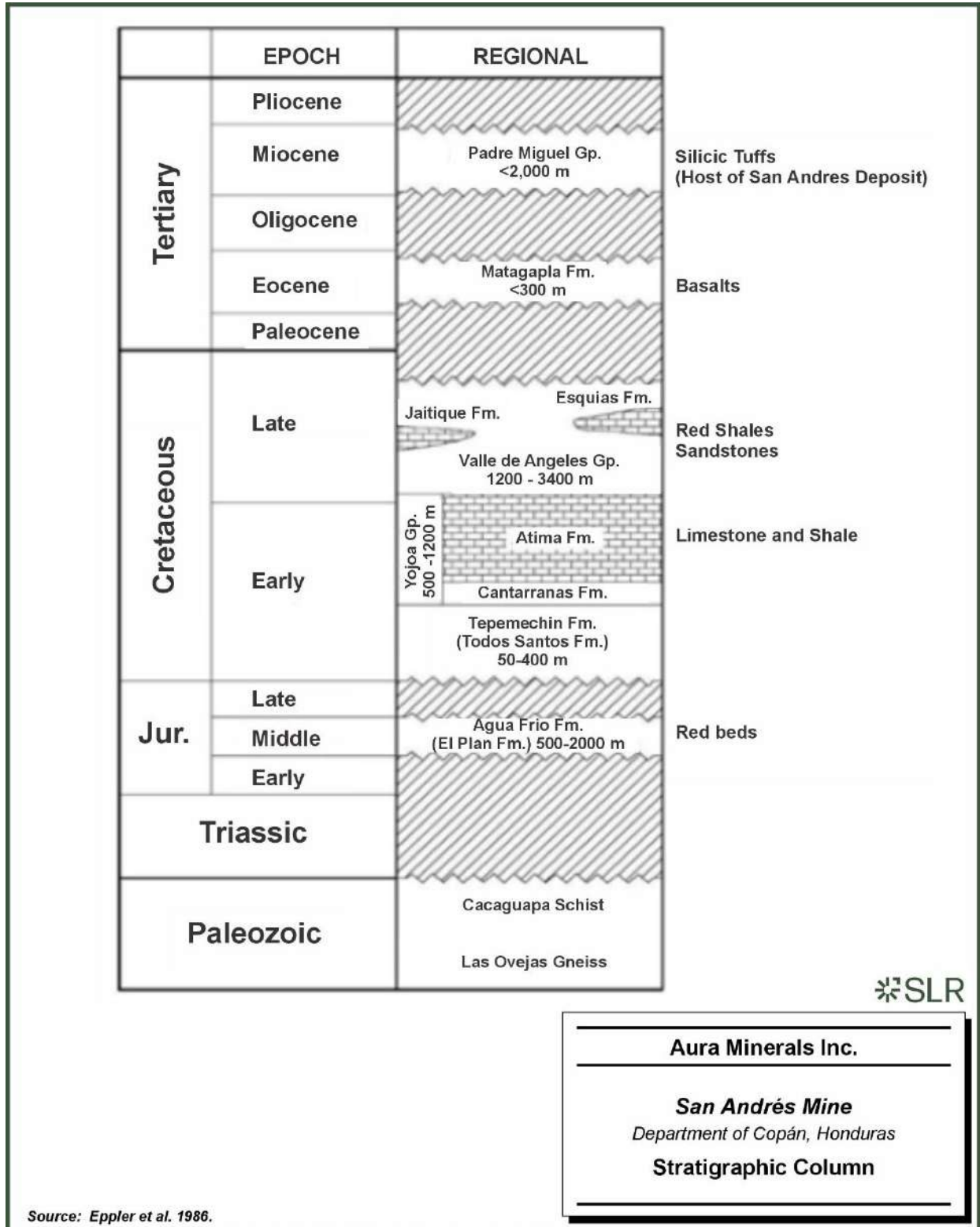


Figure 7-3: Stratigraphic Column



North-trending grabens associated with the “Honduras Depression” cut across Honduras from San Pedro Sula to the Golfo de Fonseca. The faults bounding these grabens, as well as a host of other faults throughout Honduras, average a northerly strike. However, they are stepped along northeast and northwest-trending faults that are dominantly normal-slip, but also have strike-slip components (Eppler et al. 1986). Eppler et al. (1986) also suggested that this extension was causing crustal thinning in the region. Pflaker (1976) suggested that the northwest portion of the Caribbean Plate was fragmenting along these north-trending grabens as a result of the eastward movement of the Caribbean Plate. He suggested that the greatest movement on the graben faults was associated with the eruption of the Padre Miguel tuffs in the Miocene and Pliocene and that minor adjustments along these faults may be occurring today. He suggested that the east-west extension implied a north-trending horizontal principal stress. There are abundant occurrences of hot springs throughout Honduras and hot springs occur within the immediate vicinity of the San Andrés Mine. A hot spring was encountered during mining of the Water Tank Hill pit. Eppler et al. (1986) carried out an extensive study of these hot springs to assess the potential for geothermal resource sites. In their opinion, the absence of young silicic volcanism suggests that cooling plutons are not the heat source for the hot spring activity. Rather, the geothermal systems are caused by thin crust and high regional heat flow. In their inspection of several sites, Eppler et al. noted the association of the springs with the north-trending extensional faults and fractures. Eppler et al. indicated that the geothermal fluids were neutral to alkaline in pH and were best classified as Na-HCO₃-SO₄-Cl waters. They also observed that the systems with the highest temperature generally deposited silica sinter. Temperatures of the fluids varied from 120°C to 225°C.

7.3 Property Geology

The San Andrés Mine is situated along the southern margin of the Motagua Suture Zone. The deposits occur on the south, or hanging wall side, of the San Andrés Fault. The oldest rocks recognized at San Andrés are Permian metasediments which are grey green to locally black in colour and appear to be a thick sequence of metamorphosed shales, sandstones, and arkosic sands (red bed). The metasediments (phyllites) are exposed on the north, or footwall side of the San Andrés Fault, located immediately to the north and northwest of the Water Tank Hill pit and mine area. Drilling in the Buffa Zone in the phyllites demonstrate that they are carbonaceous, with 1% to 2% sulphide in the form of pyrite, and contain narrow veins of massive white (milky) quartz. High gold grades have been intercepted in holes MO-15-47, MO-20-29 and MO-20-28 located in Buffa.

The phyllites are overlain by porphyritic andesites of the Tertiary Matagalpa Formation. This unit underlies much of the San Andrés Mine, the Cerro Cortez Hill area, and extends eastward to the Quebrada del Agua Caliente. The explosive phase of the andesites consists of agglomerates, flows, and tuff breccias. Locally, the andesite appears to have intruded into the overlying sandstone and conglomerate rock units. The andesite-conglomerate contact is often very irregular in form and typically exhibits shearing. There are zones of mixed rock along the contact where angular fragments of andesite porphyry are found in a matrix of conglomerates and sandstones. In places, the andesite is grayish green in colour and consists of moderately abundant plagioclase and hornblende phenocrysts in a felsic to glassy matrix. Overlying the andesites is a thick red bed sequence of quartz conglomerates, medium to fine sands and silts. These rocks are believed to be the Tertiary Subinal Formation. South of the mine area, where unaltered, these rocks have the distinctive hematite brick red colour, but in the mine area they have been bleached to light buff yellow and grey colours. These units typically have a shallow to moderate southerly dip and they



thicken to the south of the mine area. The principal mineralized lithology is the Brecha/ Conglomerate and secondary the Andesite.

The Subinal Formation sediments are overlain by poorly to moderately welded rhyodacite and rhyolite tuffs. Fine sands and silts with a tuffaceous matrix and quartz fragments of volcanic origin are also part of these tuff units and appear to be the basal portion in contact with the conglomerates and sands of the Subinal Formation which represents a change in the geologic environment. These units occur as intercalated, thin, discontinuous beds. The rhyodacite and rhyolite tuffs consist of crystal-rich, poorly to locally moderately welded tuffs with abundant biotite in a felsic groundmass. Quartz pyroclasts are not always present, but may be locally abundant. This unit is considered to be the Tertiary-aged Padre Miguel Group. The rhyolite tuffs crop out on the hill immediately to the east of the past-producing Water Tank Hill pit and form thick ridge cappings in the southern and eastern portion of the district. A thin remnant of biotite crystal-rich rhyolite tuff was mapped on Water Tank Hill before it was mined. The youngest sequences present in the area are Quaternary and recent alluvial deposits which fill canyon bottoms and stream valleys and occur locally as slope cover.

Figure 7-4 illustrates the property lithology.



Figure 7-4: Property Geology – Lithology (Topography December 2024)

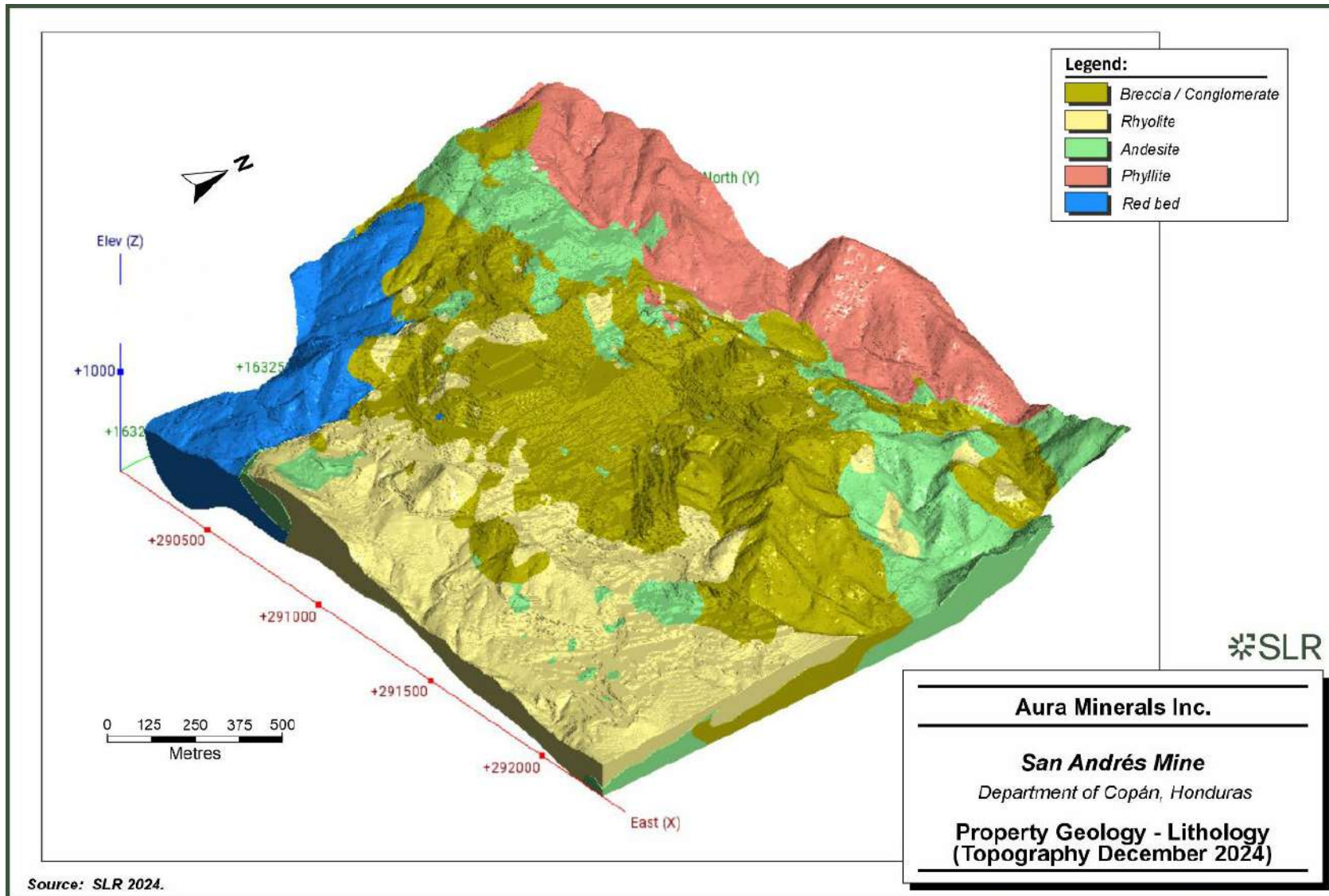
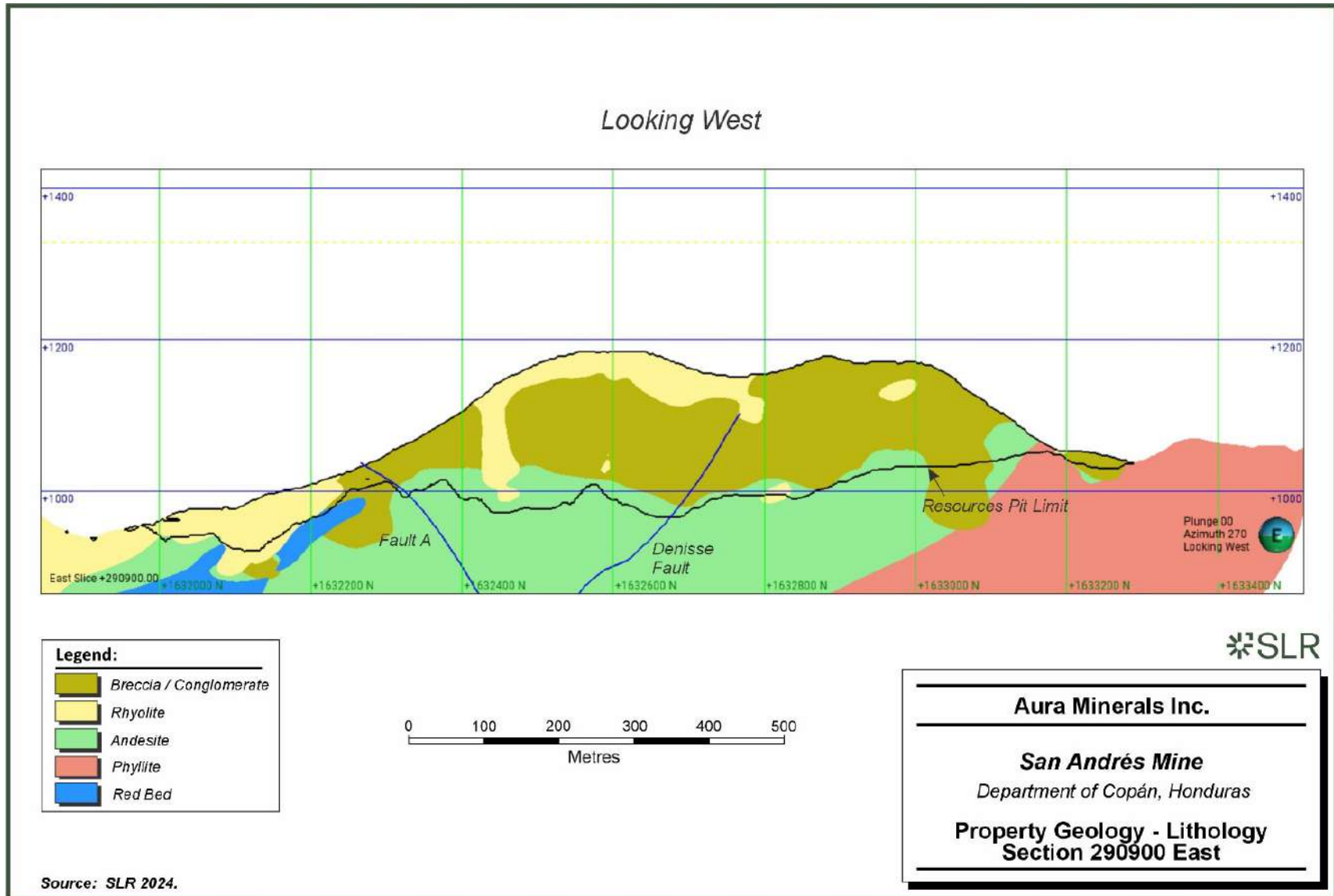


Figure 7-5: Property Geology – Lithology Section 290900 East



7.3.1.1 Structure

The San Andrés Mine area is dominated by a series of sub parallel and widely spaced east to northeast-striking faults that are typically steeply dipping to the south and by numerous north to northwest-striking faults that also dip moderately to steeply to the east and to the west. The most prominent fault on the property is the San Andrés Fault which strikes east to east-northeast and dips steeply south. The San Andrés Fault forms a distinct boundary between the phyllites to the north (footwall side of the fault) and the host rocks for the San Andrés Mine to the south (hanging wall side), which include the andesite, conglomerates, and rhyolite tuff units. The San Andrés Fault is parallel to, and coeval with, the major set of east to north-northeast trending strike-slip faults that form the Motagua Suture Zone and the direction of movement along the San Andrés Fault is also left lateral. Drilling has shown that the fault strikes east-northeast and dips at 60° to 70° south at the mine. Within the volcanic and sedimentary units on the south side of the San Andrés Fault, numerous and more closely spaced extensional faults and fractures have been mapped. The average strike of these faults is N25°W and the dip is 50° to 80° to the southwest and northeast, forming graben-like blocks where the strata are locally offset. These faults and fractures are generally filled with banded quartz and blade calcite. These extensional structures are distributed over a wide area, from the East Ledge open pit to Quebrada del Agua Caliente, approximately 1,500 m to the east, and from the San Andrés Fault, for at least 1,200 m south. At Platanares, the active geothermal springs and seeps are also associated with a northwest trending fault and fracture system. These extensional faults and fractures are interpreted as being coeval with the regional extensional structures resulting from the current rifting process. These extensional structures most likely exhibit low levels of seismicity. Micro-seismic monitoring systems could be used to identify zones containing major extension fracture systems for exploration purposes. Carvalho (2006) completed a structural analysis of the San Andrés Mine area, focusing particularly on the East Ledge pit area. He divided the East Ledge pit into three main domains: North, East, and Central West based on similar structural features. The northern portion of the East Ledge pit is dominated by two main sets of structures: east-west strike-slip faults, probably related to the San Andrés Fault, and north-striking faults and extensional structures. He noted that strong hydrothermal alteration and mineralization are always associated with the extensional faults. De Carvalho considered the Central West Domain to be the central part of a graben-like structure. This type of structure is considered to be the principal control on the mineralization in the mined-out Water Tank Hill pit. These graben-type structures are thought to have formed in conjunction with the displacement on the San Andrés Fault. The East Domain is in the east-southeast portion of the pit and is different from the other domains being characterized by a major concentration of northwest striking fractures. Alteration is dominated by strong silicification and quartz veining. This area is considered by de Carvalho to be a potential main pathway for the mineralizing fluids. A prominent north-striking structure in the southwest wall of the East Ledge pit is reported to display a steep lineation of the slickenside on the footwall of one of the faults, indicating vertical movement. The fault was filled with banded chalcedony and bladed calcite and varied in width from one metre to 0.2 m. The strike of the fault was north-northeast and it dipped at 55° east.

7.3.1.2 Alteration

Rock alteration associated with the deposit includes an outer halo of bleaching and propylitization with mixed argillization and silicification central to the gold mineralization. The 2024 geological model focused on the alteration of mineralization control: silicification to silicification + argillic to argillic + silicification to argillic, as illustrated in Figure 7-6.



Minor to locally moderate amounts of sulphides, such as pyrite and possibly marcasite, were also introduced into the host rocks, but are now nearly all oxidized and occur as hematite, goethite, and jarosite. Oxidation in the mineralized zones extends to at least 100 m vertically in the East Ledge pit. Propylitization is seen in the andesite flows and intrusive as a grayish green colouration with various amounts of very fine disseminated pyrite, chlorite, and calcite. The andesite shows weak to moderate argillic alteration throughout, with the plagioclase and groundmass altered to soft light-coloured clays, but with phenocrysts still visible. Within the sediments, the silty and fine-grained matrix has been strongly clay altered near the underlying andesite intrusive contact and along faults and vein structures. Weak to moderate argillic alteration is present over broad areas within the sedimentary rocks and is associated with hematite, goethite, and jarosite development. Silicification varies from weak through intense to total replacement in both sediments and andesite. Although silicification is generally associated with veins and faults, local areas of flooding are noted. The silica flooded areas are locally blanket-like zones associated with controlling feeder structures. The silicic alteration is strongest in the tuffs.



Figure 7-6: Property Geology – Alteration (Topography December 2024)

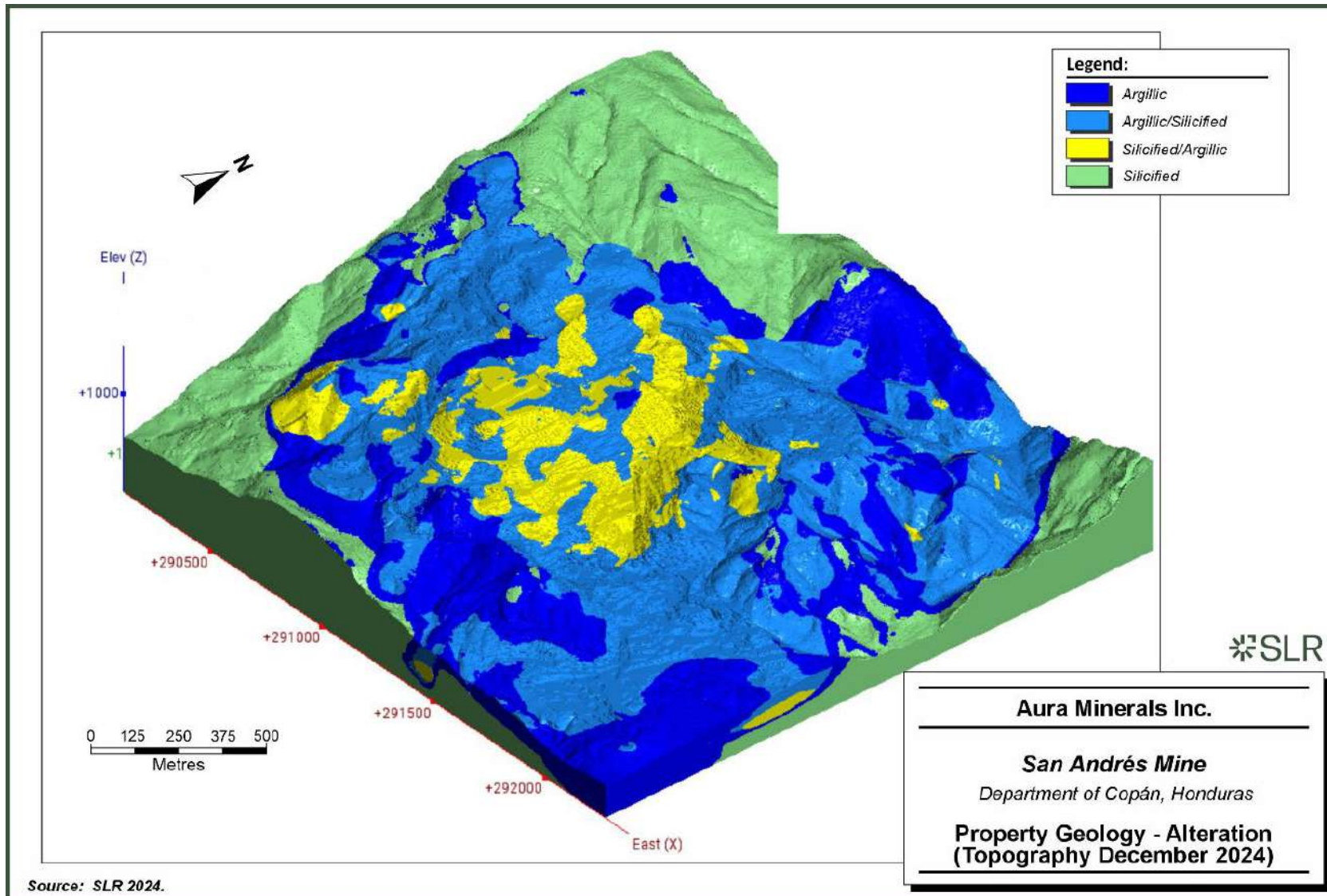
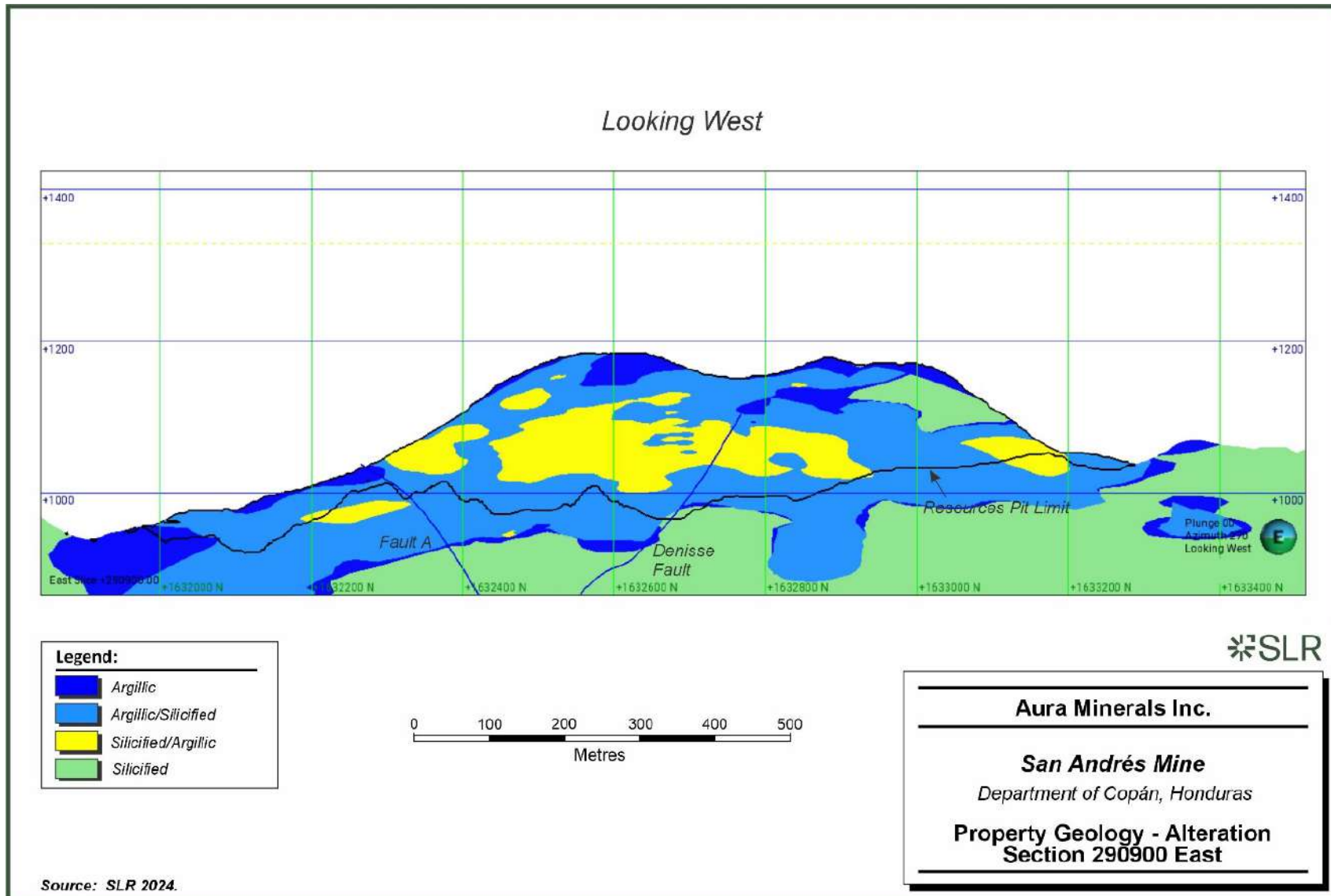


Figure 7-7: Property Geology – Alteration Section 290900 East



7.4 Mineralization

At the Mine, gold and silver mineralization is associated with a high level epithermal, quartz-carbonate-adularia system consisting of veins, stockworks, and disseminations. In the andesite, overlying conglomerate and rhyodacite, the quartz veins are typically composed of banded chalcedony and fine-grained white quartz, which has replaced calcite. The bladed calcite texture seen in veining is ubiquitous and the quartz replacement is almost always complete. Metallurgical studies show that the gold is primarily contained in electrum as fine-grained particles. The particle size of the electrum grains varied from 1 µm x 1 µm up to 10 µm x 133 µm. One native gold grain was noted.

Sulphur mineralization in the Mine is not considered as Mineral Resources or Mineral Reserves as there are no current or planned recovery methods for sulphur mineralization.

SLR assessed the ratio between the silver assays that were available with the gold assays in the 2024 Reserve and Resource pit at a 0.187 g/t Au cut-off. The ratio was 4 to 1, However, because of the much lower price for silver and the lower metal recoveries, the value of the silver recovered is less than 1 to 2% of the value of the gold produced. Therefore, samples are not generally analyzed for silver and silver grades are not included in the block model.

The property mineralization is shown in Figure 7-8.



Figure 7-8: Property Geology – Mineralization (topography December 2024)

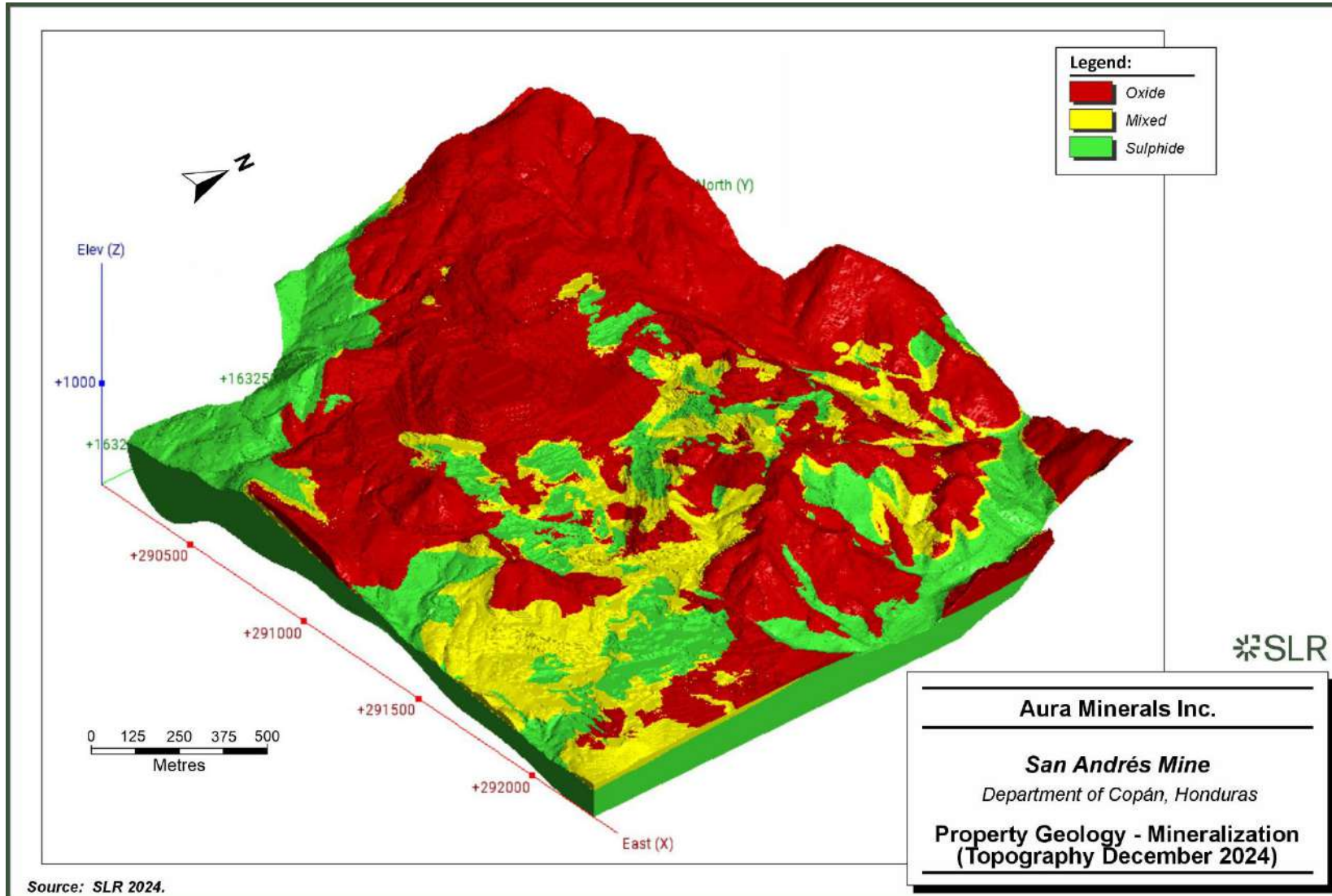
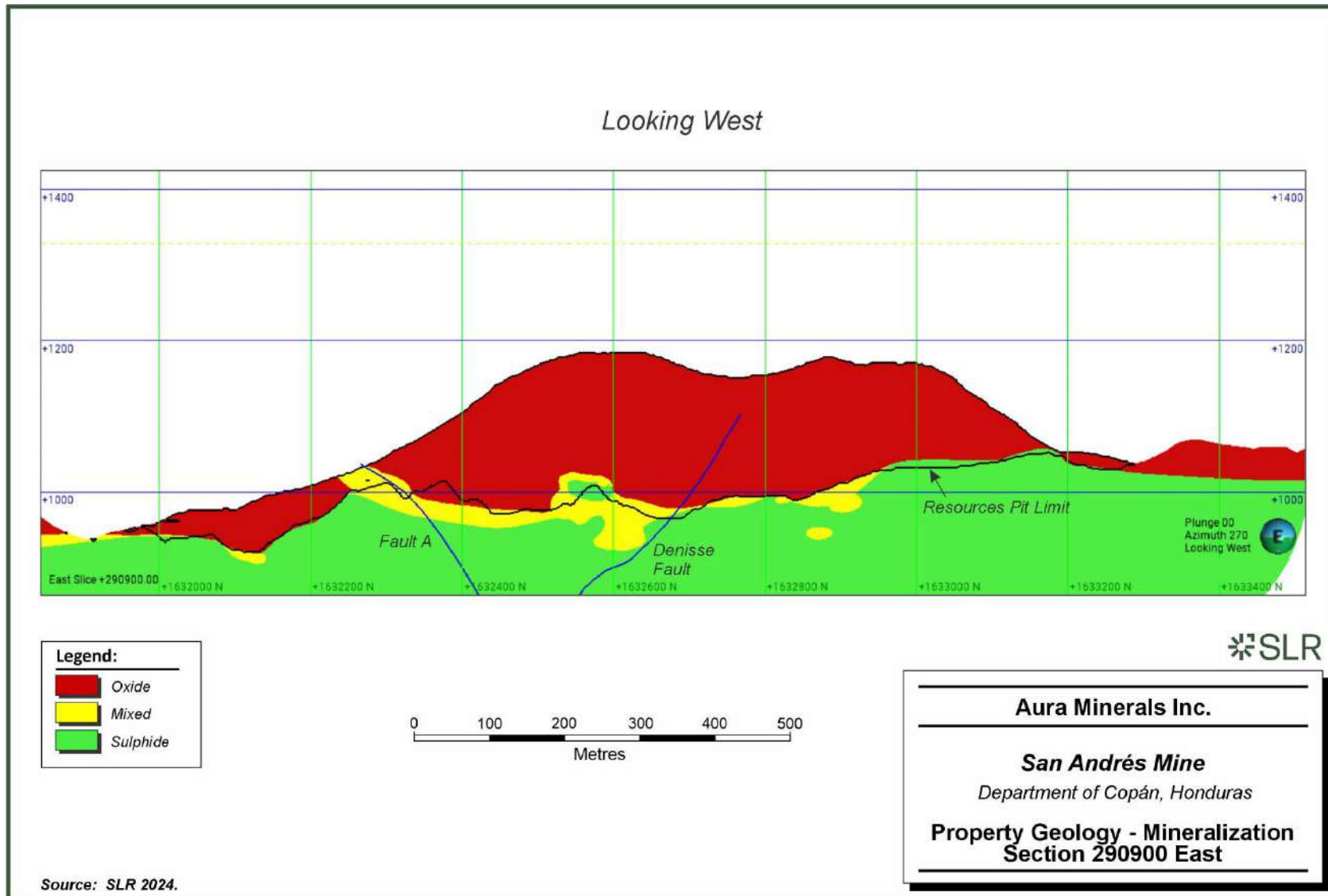


Figure 7-9: Property Geology – Mineralization Section 290900 East



8.0 Deposit Types

The San Andrés deposit is an epithermal gold deposit associated with extensional structures within tectonic rift settings. These deposits commonly contain gold and silver mineralization, which is associated with banded quartz veins. At San Andrés, silver is not economically important. Gold occurs in quartz veins that are predominantly comprised of colloform banded quartz, generally chalcedony, with lesser amounts of fine comb quartz, adularia, dark carbonate, and sulphide material. The gold mineralization is deposited as a result of cooling and the interaction of hydrothermal fluids with groundwater and the host rocks. The hydrothermal fluids may have migrated some distance from the source; however, there is no clear evidence at San Andrés that the fluids, or portions of the fluids, have been derived from magmatic intrusions. Many of these low sulphidation epithermal deposits occur in felsic volcanic sequences where geothermal fluids are circulating. Near surface, many deposits are capped by eruption breccias which are formed by the rapid expansion of depressurized geothermal fluids. These breccias are characterized by intensely silicified matrix and angular fragments of the host rock. Wall rock alteration forms as halos to veins and includes sericite grading to peripheral smectite and marginal chlorite alteration.

Corbett (2002) suggests that structure and the competency of the host rocks may be important ore controls for the vein systems. The extension fractures form in the stronger, more competent rocks. Higher grade ore shoots generally develop in areas with a greater frequency of extensional structures, or at dilational jogs or flexures in the veins. The mineralization at San Andrés appears to be in an upper level epithermal system as indicated by the hydrothermal alteration patterns, the disseminated style of mineralization, the presence of both gold and silver associated with quartz veining, the presence of active hydrothermal fluid flow at the property, and the actively forming extensional fracture system, which creates the permeability.



9.0 Exploration

Since Aura's acquisition of Minosa on August 25, 2009, exploration activities at the San Andrés Mine have included property-scale geological mapping, road cut channel sampling, geochemical characterization, and geophysical surveys, all conducted by Minosa personnel.

In 2010 and 2011, geological mapping and channel sampling were completed in adjacent areas, accompanied by a reverse circulation (RC) drilling program. District-scale prospecting efforts focused on the San Andrés III and IV concessions, where detailed mapping, systematic sampling, and geochemical characterization were conducted. Initial results from this phase indicated strong potential for deeper mineralization.

From 2013 to 2020, the exploration programs predominantly consisted of diamond and reverse circulation (RC) drilling. The results of the drilling are described in Section 10 Drilling.

In 2021, district prospecting focused on San Andrés III and IV concessions. Social, legal, and environmental permits were obtained for these concessions. Detailed mapping, systematic sampling and geochemical characterization were completed. The results obtained in this first phase show a high possibility of deep mineralization. In a second phase scheduled for 2022, the anomalies will be tested by drilling.

Exploration efforts in 2022 concentrated on reevaluating regional targets to refine the 2023 program. Geochemical sampling, including soil and rock analyses, was conducted in San Andrés IV during the first half of 2022. Additionally, an aeromagnetic survey covering approximately 4,435 hectares was carried out using drones. The survey identified key structural features interpreted as primary controls on mineralization, aiding in the definition of future exploration targets.

No exploration activities outside the San Andrés property have been identified.

Figure 9-1 illustrates the district-wide San Andrés concessions. Figure 9-2 and Figure 9-3 show the geochemical sampling locations.

Brief summaries of the results are as follows:

- San Andrés II: No geochemical anomalies were identified due to the area being covered by a tuff layer.
- San Andrés III: A new geochemical anomaly was interpreted based on historical soil and rock sampling data. Selected samples were resampled and sent to an external laboratory for further analysis. This anomaly appears to extend from San Andrés IV.
- San Andrés V: A few samples exhibited anomalous values, warranting further investigation, including detailed mapping and additional sampling in the vicinity of these anomalies.
- San Andrés X: Exploration results were discouraging, and after re-evaluation with updated mapping and sampling, further exploration activities were halted.



Figure 9-1: San Andrés Concessions

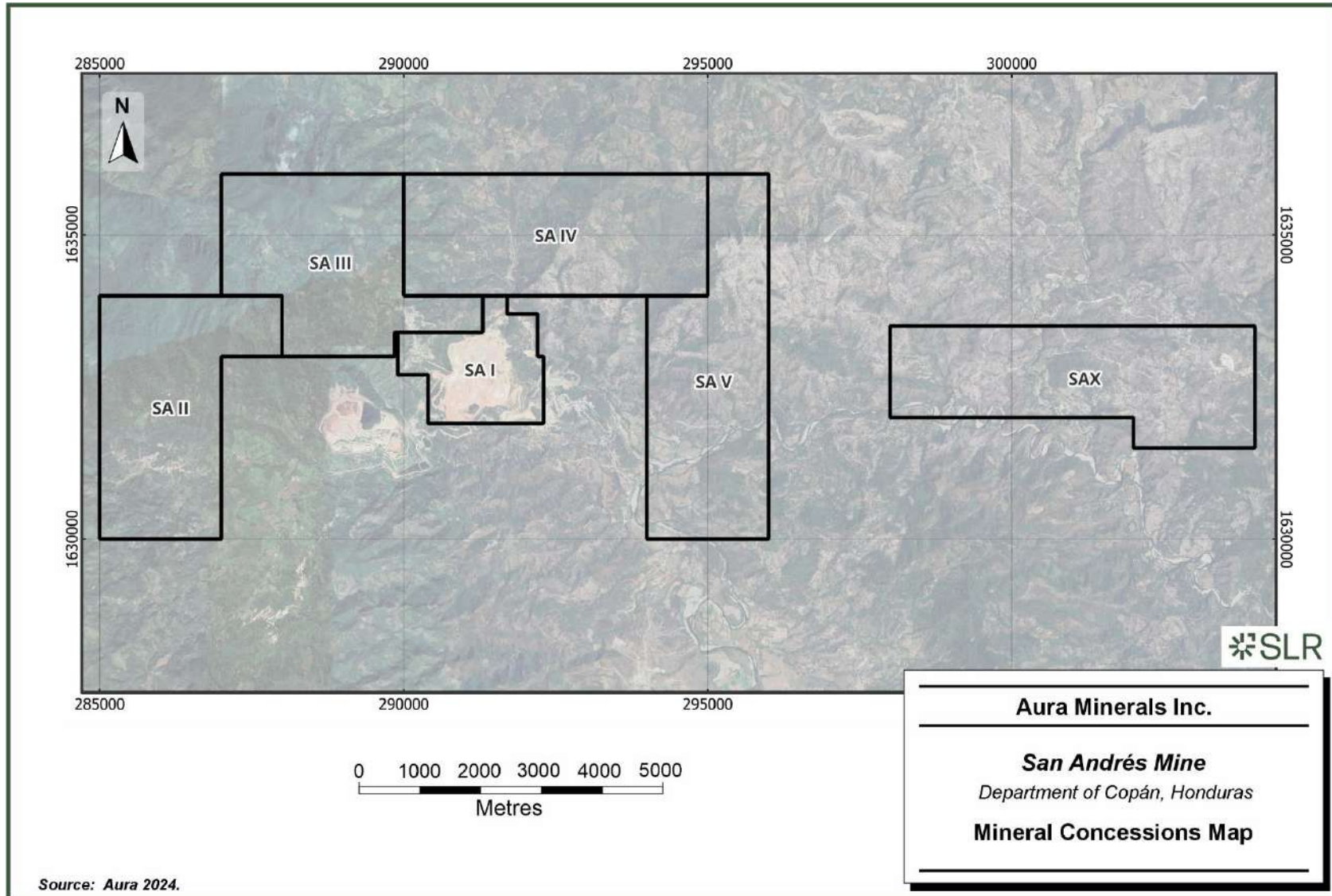


Figure 9-2: Geochemical Sampling Locations for Gold on San Andrés Concessions I, II, III, IV, and V

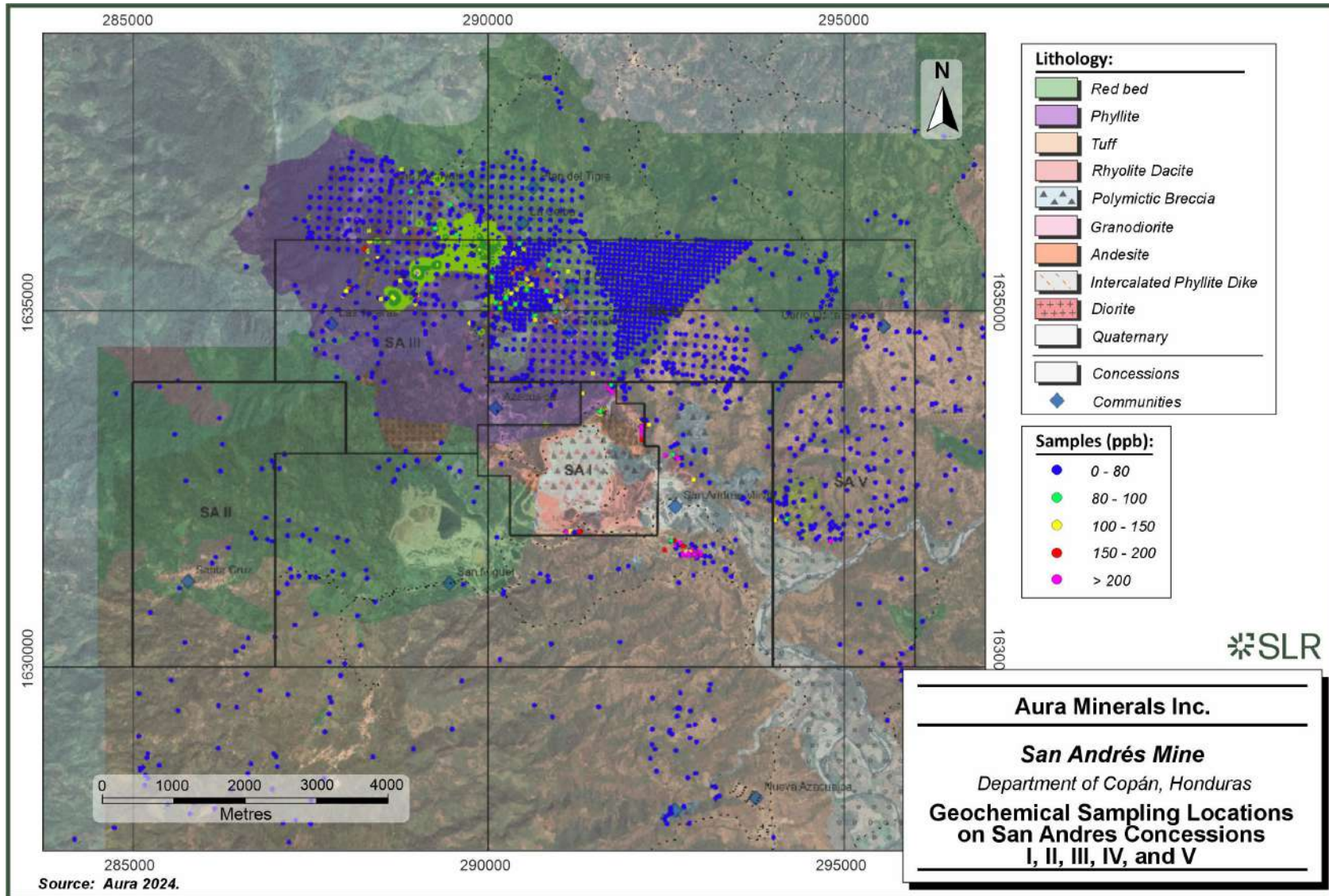
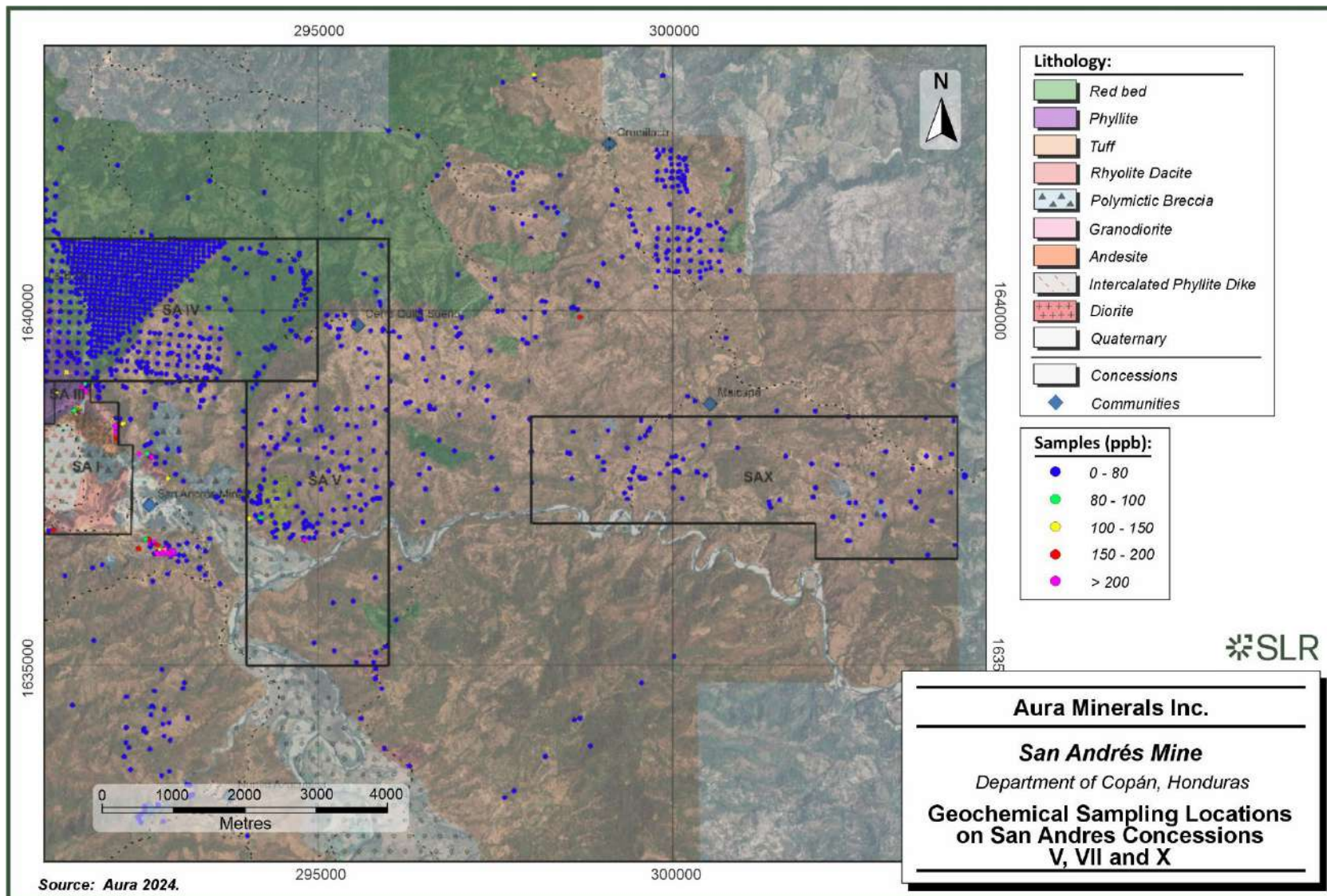


Figure 9-3: Geochemical Sampling Locations for Gold on San Andrés Concessions V, VII, and X



10.0 Drilling

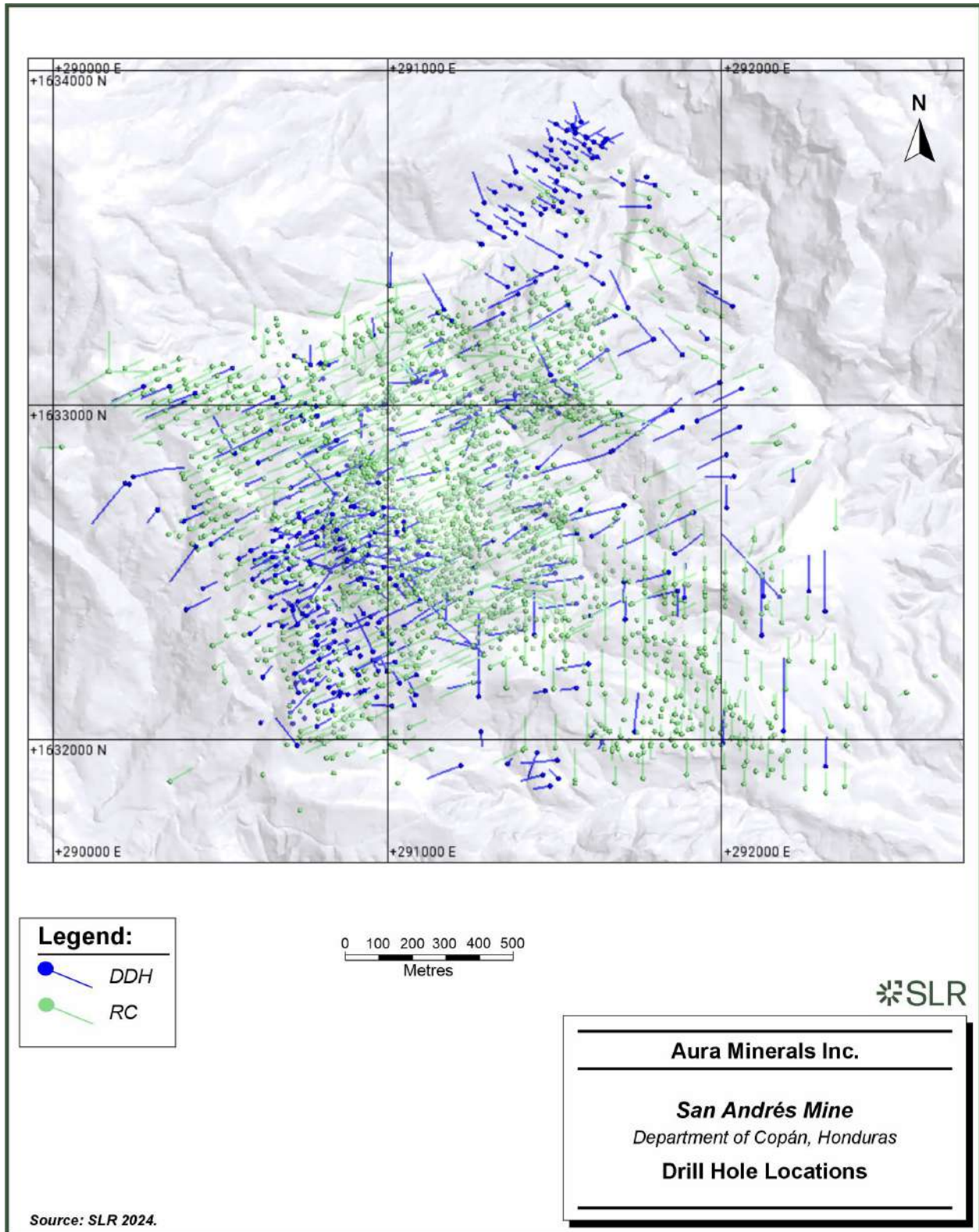
Since 1992, Minosa and its predecessors have drilled a total of 2,494 holes, comprising 464 diamond (DDH) with 60,884 m and 2,030 reverse circulation (RC) with 184,151 m, totalling 244,223 m as summarized in Table 10-1 and illustrated in Figure 10-1. The coordinate system is NAD27 / UTM zone 16N.

Table 10-1: Drill Programs Completed at San Andrés Mine

Company	Year	RC Holes		DD Core Holes		Total	
		No. of Holes	Metres	No. of Holes	Metres	No. of Holes	Metres
Fischer-Watt	1992	22	2,717			22	2,717
Greenstone	1994	63	5,008			63	5,008
Greenstone	1996	41	5,921			41	5,921
Greenstone	1997	101	11,601	9	1,324	110	12,925
Greenstone	1998	150	18,438	37	4,536	187	22,974
Minosa	2001	15	1,674			15	1,674
Minosa	2002	49	6,307			49	6,307
Minosa	2005	25	2,280			25	2,280
Yamana	2006	113	17,639	12	2,566	125	20,205
Yamana	2007	59	8,316	28	6,253	87	14,569
Yamana	2008	12	1,900	22	4,839	34	6,739
Minosa-Aura	2010	59	3,304			59	3,304
Minosa-Aura	2011	14	631			14	631
Minosa-Aura	2012	85	8,868			85	8,868
Minosa-Aura	2013	104	11,078			104	11,078
Minosa-Aura	2014	35	3,665			35	3,665
Minosa-Aura	2015	48	4,597			48	4,597
Minosa-Aura	2016	97	10,143			97	10,143
Minosa-Aura	2017	154	9,936	35	3,584	189	13,520
Minosa-Aura	2018	211	9,907	39	3,159	250	12,256
Minosa-Aura	2019	26	1,495	72	5,676	98	7,171
Minosa-Aura	2020	68	4,952	101	9,144	169	14,095
Minosa-Aura	2021	124	7,609	64	12,166	188	19,775
Minosa-Aura	2022	34	3,459	19	2,507	53	5,966
Minosa-Aura	2023	163	10,482	7	1,988	170	12,469
Minosa-Aura	2024	158	12,224	19	3,143	177	15,367
	Total	2,030	184,151	464	60,884	2,494	244,223



Figure 10-1: Drill Hole Locations



Over 80% of the drilling was by RC and the balance was diamond drill holes. Most of the diamond drill holes and RC holes were drilled at steeply inclined 60° to 70° orientations toward the southwest or northeast.

RC holes were drilled using 4 3/4 in. tricone bits, and all diamond drill holes were collared using HQ ad deep reduce to NQ size tools. The common drill holes lengths varia from 100 m to 200 m. Some deeper core holes go to 200 m to 520 m.

Aura's drilling campaigns are briefly summarized in the following:

- An RC drilling program was completed in 2010/2011. Drilling targeted the Twin Hill South, Banana Ridge, Fault A, Cerro Cortez, Buffa Zone, and Agua Caliente areas, totalling 3,935 m. The exploration program helped to develop the geological model and define future targets for infill drilling.
- During 2012, a new RC drilling program was commenced in the Cerro Cortez and Esperanza areas for improving Mineral Resource and Mineral Reserve definition; this program continued throughout 2013.
- During the period of 2014 to 2017, the RC infill drilling campaign conducted by Minosa was aimed to fill the gaps in active mining areas including Cerro Cortez, East Ledge zones.
- In 2017 and 2018 diamond drilling also added to the drilling campaign in Minosa in active mining areas such as Cerro Cortez and East Ledge zone and also in some other areas such as Falla A, Banana Ridge, Agua Caliente, Buffa zone, and Esperanza to further delineate these areas within design pits.
- During 2019, a total of 7,171 m of drilling, comprising 5,676 m DD and 1,495 RC drilling, were carried out in Cerro Cortez, East Ledge North, Esperanza and Falla A areas.
- By the end of 2020, a total of 14,095 m had been drilled in 169 drill holes including 101 diamond drill (9,144 m) and 68 RC (4,952 m) holes. Part of the program was focused on infill drilling with the aim of replacing depletion and to confirm tonnes and grade in the mine plan. In the East Ledge, Banana Ridge and Esperanza zones, the results confirmed the Resource Model grades, which vary between 0.40 g/t Au to 0.87 g/t Au for East Ledge, and values between 0.36 g/t Au to 1.50 g/t Au for Banana Ridge and Esperanza.
 - In Esperanza three holes was drilled, which intercepted values between 0.30 g/t Au to 1.00 g/t Au over more than 50 m.
 - In East Ledge, Banana Ridge and Falla A, the holes have an average direction of 65/245, dip between -90 to -40 and depth up to 240 m; in Buffa, the holes had an average direction of 60/300, dip between -50° to -75° and depth up to 130 m; and in Esperanza, the holes had an average direction of 95, dip between -50 to 90 and depth up to 235 m.
- In 2021, a total of 19,775 m was drilled in 188 drill holes including 64 diamond drill holes (12,166 m) and 124 RC (7,609 m) holes, distributed in four projects: Esperanza – Infill, Sulphide - High grade veins, Extension of ELN, and the condemnation project.
 - In Esperanza fourteen holes were drilled (2,785 m) with the objective was replacement and increase of resources. The holes had a dip between -90 to -50 and depth up to 240 m; the oxide zone extended up to 150 m deep and the average grade was between 0.30 g/t Au to 0.50 g/t Au with pockets of up to 3 g/t Au.



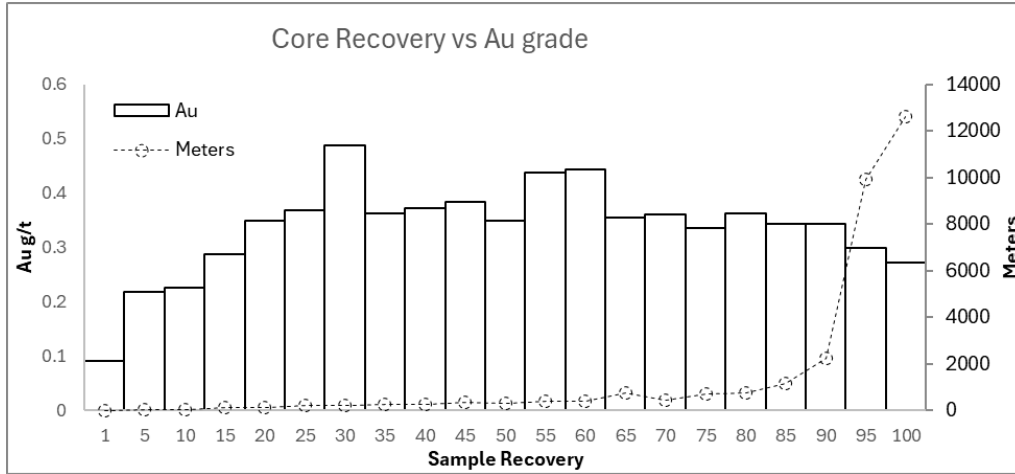
- Esperanza - Infill was developed with the objectives of increasing the confidence of the resources in the production zone and defining the oxide and sulphide limit; there are 79 drillings through reverse air that total 4,104 m. It was divided into two stages.
- Exploration drilling continued in Minosa concession area, with the objectives of extending of the current resource pit in Banana Ridge and Falla A zones, to investigate sulphide - high grade veins project, and certify the absence of mineralization in areas outside the pit.
- In Banana Ridge and Falla A, drilling results showed continuity of mineralization and its extension with average grades of 0.20 g/t Au to 0.50 g/t Au with widths between 20 m to 60 m.
- Sulphide – High grade veins project – 5,364 m were drilled in 24 holes with depths up to 350 m. The results show intercepts of high-grade sulphides with intervals between 0.35 m to 4.50 m and grades between 2.80 g/t Au to 56.10 g/t Au, identifying two structures with high potential.
- The condemnation project checked and certified the absence of mineralization north and south of Banana Ridge and Pan de Azucar backfill. A total of 3,331 m was drilled in 36 holes.
- During 2022, RC drilling totaled 3,459 m in 34 holes and diamond drilling totalled 2,507 m in 19 drill holes to increase confidence and fill the structural gaps in the alteration models.
- Exploration activities during 2023 focused on exploration drilling to test continuity of historical sulphide high grade area zone in the San Andrés Mine and the sulphide mineralization. A total of 1,988 m was drilled in seven diamond drill holes in Esperanza Alto and Esperanza Bajo, and 10,842 m drilled in 163 RC drill holes in the main corridor.
- During 2024 exploration focus on the infill the Esperanza Alto and Esperanza Bajo main high-grade corridor and the oxide-mixed-sulphur delimitation, A total of 3,143 m drilled in nineteen diamond drill holes and 12,224 m in 158 RC drill holes

The average core recovery was 89%, as the rock is highly fractured as a result of regional tectonic setting. Sample recovery varies according to the level of oxidation level from 86% in oxide, 90% transitional, and 94% in sulphur. The gold content is not related to the core recovery, as illustrated in Figure 10-2.

In the SLR QP's opinion the core sample recovery is acceptable for the purposes of Mineral Resource estimation. Based on the reconciliation results discussed in Section 14 Mineral Resources, the diamond drill hole sampling results may understate the grade compared to the RC and blast hole sampling results. Further study is needed to investigate the sampling bias among hole types used in the resource model.



Figure 10-2: Core Recovery vs Gold Grade



11.0 Sample Preparation, Analyses, and Security

11.1 Sampling Method and Approach

11.1.1 Previous Work (2005 – 2008)

Chlumsky, Armbrust and Meyer, LLC (CAM) documented the RC drilling procedures in a technical report prepared for RNC, covering drilling programs conducted before October 2005 (CAM 2005). The sampling method protocols for 2005 through 2008 that are described below have been compiled from information provided in Aura (2012). The QP is unaware of specific details regarding sampling methods and protocols used prior to 2005.

11.1.1.1 Sampling Method and Approach

The Mineral Resource estimation relied primarily on data from RC drilling, with a smaller contribution from core drilling. Sampling and logging were conducted along the entire length of each drill hole. Although surface channel sampling was extensively carried out at the Twin Hills deposit, these data were not considered in the Mineral Resource model. Similarly, blast hole assay data from production drilling and geological mapping of the East Ledge pit were excluded from the estimation process.

The drill hole database used in the estimation included 740 holes, with a total of 66,195 samples. To maintain consistency in the resource estimation, samples collected from surface exposures for mapping purposes, as well as data from holes drilled during pit excavation, were omitted.

11.1.1.2 Sampling Method for RC Drilling

Sampling methods for RC drilling were previously reported by CAM (2005) and reviewed in subsequent reports by Scott Wilson RPA (2007). Drilling campaigns were designed to sample the oxide and mixed zones extensively, with holes typically ranging from 150 m to 200 m in depth, often terminating within the sulphide zone. Samples were collected continuously along the entire length of each drill hole, from the collar to the end, at consistent intervals of 1.5 m (5 ft). The sampling protocols employed by Yamana for both RC and core drilling closely followed the procedures previously established by CAM. These procedures are outlined below:

- RC drill cuttings are collected from the cyclone discharge into 5-gal plastic buckets. Each sample represents 5 ft, or 1.5 m, of drilling. The drill rods are in 10 ft (3 m) lengths and the rod holder is marked at the point when the rod is halfway through the run. At that point, a new sample is collected.
- The weight of the chips collected in the buckets is measured and recorded in the drill log. Sample recoveries are estimated from weight of the sample compared to the calculated weight from the volume of a 1.5 m, or 5 ft, sample interval.
- When drilling dry, the recovered sample is passed from the bucket through a Gilson splitter and reduced to two samples of about five kilograms each. Splits are retained in poly bags with a sequence number, hole number, and depth.
- When drilling wet, a rotary wet splitter was used to produce the two samples. The wet samples are passed through the Gilson splitter if further size reduction is necessary.



- One sample (“A”) was transported to the assay laboratory at the mine site for sample preparation. The other sample (“B”) remains on site in a storage facility for future reference. Every 20th sample is split for a duplicate assay check.
- In addition to the duplicate samples, standards and blanks are inserted to assess for sample accuracy, contamination, and assay accuracy.

Sample recovery was estimated to range between 80% and 85% based on the ratio of the measured sample weight to the calculated theoretical weight. A review conducted by Scott Wilson RPA of 20 RC drill holes identified eight instances where no sample cuttings were recovered. Despite this, recovery across the drilled intervals, including approximately 3,000 m with no sample collection, was estimated to exceed 99%.

11.1.1.3 Sampling Method for Core Drilling

The drill core was extracted directly into the core box by the driller. The core barrel length was 10 ft (3.1 m); however, incomplete recovery often occurred due to blockages or other operational limitations. The end of each core run was identified using wooden blocks, with the depth (metreage) clearly marked on each block to ensure precise documentation. The core was not oriented during the drilling process.

Core boxes were covered immediately upon filling, and each box was labeled with the drill hole number and the corresponding depth intervals to ensure traceability. Sample intervals were defined by a geologist based on observable changes in lithology or structural features. These intervals ranged from 0.5 m to 3.0 m in length, depending on geological variability. Sample intervals were clearly marked on the core before splitting to maintain consistency and minimize errors.

The core was split lengthwise using a diamond saw. One half of the split core was placed in a plastic sample bag, and each bag was labeled with the drill hole number, sample number, and depth interval. The remaining half of the core was stored in the core box and retained on site in a secure, covered facility for future reference and verification purposes.

Quality assurance and quality control measures included the systematic insertion of duplicate samples, blanks, and certified reference materials at regular intervals to monitor analytical accuracy and precision.

11.1.2 Current Work (2010 - 2024)

11.1.2.1 Sampling Method for Blast Holes

During double-shift operations, sampling is carried out with the driller and two assistants to enhance productivity and maintain sample integrity. Drilling should penetrate approximately one foot (0.3 m) into firm ground before sample trays are set to avoid soil contamination. After drilling six metres, the team removes the sample trays and buckets from the fines collector, ensuring no sub-drilling material is included, and prepares the detritus and fines for sampling and quartering.

For single shifts or if samples are wet due to rain, trays are not used; instead, samples are collected directly using a shovel and without a Jones splitter. Approximately 6 kg to 9 kg of material is bagged, and equipment is cleaned between samples to avoid contamination. Once bagged, samples are sealed and labeled near the corresponding drill hole.

When transferring equipment between sites, each sampling site resets its numbering (e.g., BR04701-001, SC03734-001), and geological staff label samples with a unique identifier



including area, level, and sequence number (e.g., SC03825-001, where SC is the area, 038 the level number, 25 yard number at that level, and 001 is the sample number in sequential order, independent for each blast).

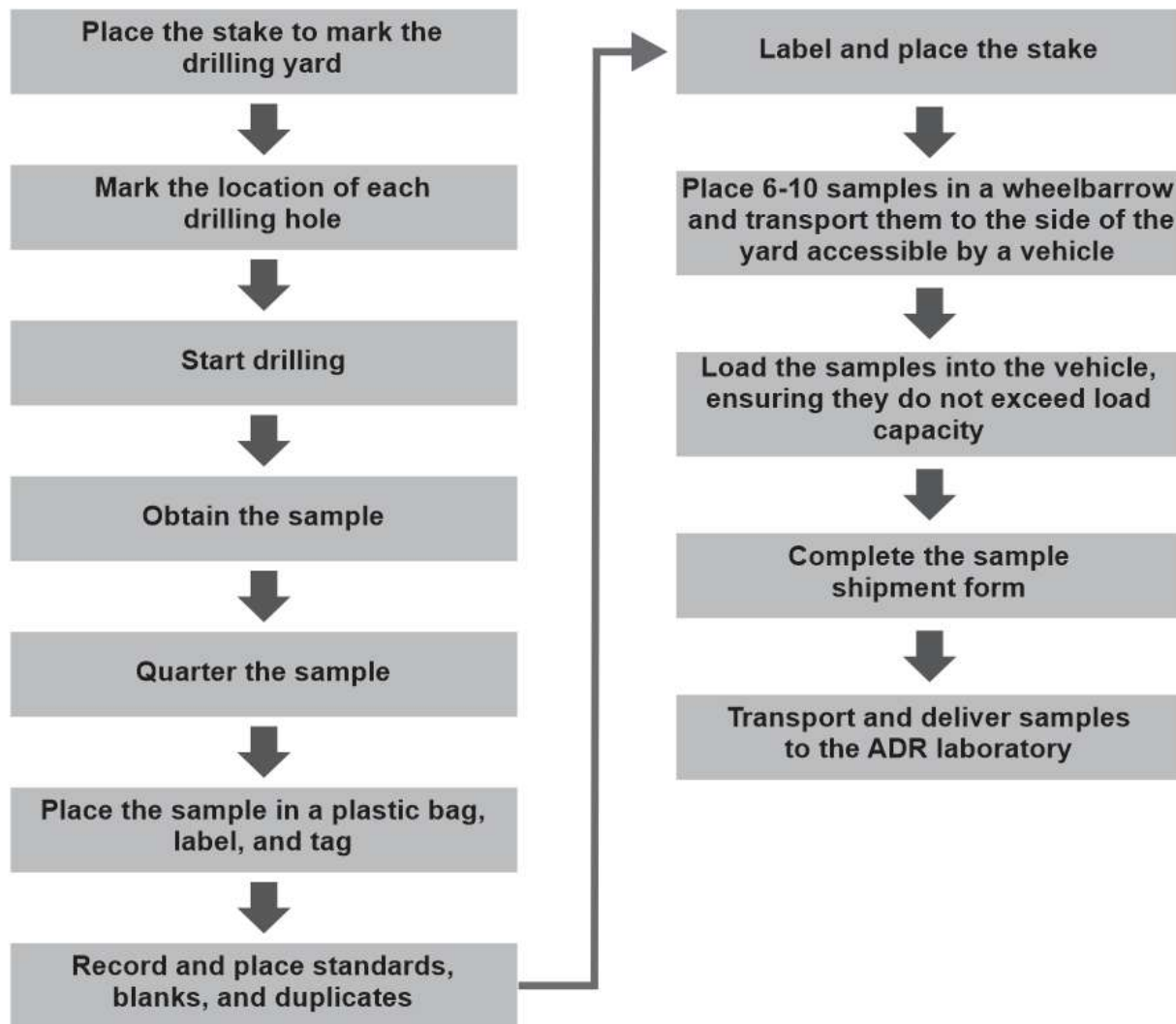
The geology personnel document each hole's rock type and alteration, placing standards, blanks, and duplicates for quality assurance (QA) and quality control (QC). Standards are inserted every 100 samples, blanks every 50, and duplicates every 25. After tagging and identifying standards and blanks, samples are placed in wheelbarrows (6-10 samples at a time) and moved to a loading area for vehicle transport.

Samples are organized in the vehicle by number (up to 100 per load) and the sampling list (shipment form) is completed on site. The list includes collection date, bank source, consecutive ID, analysis type, total samples, and delivery/receipt details. Samples are delivered to the mine laboratory, unloaded in sequential order, and verified by laboratory staff against the shipment form. Survey coordinates are recorded for each sample and shared with the Technical Services department for database entry.

Figure 11-1 shows a schematic flow chart of sample collection and surveying protocol.



Figure 11-1: Schematic Flow Chart for Sample Collection and Surveying



Source: Aura 2023.

11.1.2.2 Sampling Method for Core Drilling

The core tube was emptied directly into the core box by the driller. Although the core tube had a length of 10 ft (3.1 m), it was frequently not completely filled due to obstructions. The end of each core run was identified using wooden markers labeled with the corresponding meterage. Core orientation was not conducted. Once a core box was filled, it was promptly covered and marked with the hole number and depth information. Minosa personnel then transported the core boxes to the logging facility at the sample storage site, where core logging was performed under proper lighting conditions.

Sample intervals were defined by a geologist based on lithological or structural variations, ranging from 0.5 m to 3.0 m in length. These intervals were distinctly marked on the core before splitting. The core was subsequently cut in half using a diamond saw, with one half placed in a labeled plastic bag containing the hole number, sample number, and depth details. The



remaining half was retained in the core box and stored on-site in a covered facility for future reference.

All sampling activities were carried out by company personnel. To ensure quality control, duplicate samples, blanks, and certified reference materials were systematically inserted at predefined intervals as part of the QA/QC program. The collected core samples were initially transported by Minosa employees to the company's offices in Santa Rosa de Copán before being dispatched via an independent courier service to CAS for sample preparation and assay.

11.2 Sample Preparation and Analyses

11.2.1 Previous Work (1992 – 2008)

Details of the analytical methods conducted prior to the 2010 drilling season are summarized here, with full information available in the Aura (2012).

11.2.1.1 1992 – 2005

During Fischer-Watt's 1992 drilling program, American Assay Laboratories (AAL) in Sparks, Nevada, USA, was used for sample analysis. Greenstone initially used Chemex Labs in Mississauga, Ontario, Canada, but switched to Barringer Assay Lab in Reno, Nevada, USA, in January 1998, starting with RC hole SA-232 and core hole SC-5. All three are independent laboratories. AAL is ISO-17025 accredited. The SLR QP has no information available regarding the accreditation status of Chemex Labs and Barringer Assay during this time period.

In April 1997, a new protocol was implemented to reduce air freight costs. Samples were first sent to independent McClelland Labs in Tegucigalpa, Honduras, for partial preparation. At McClelland, 5 kg samples were dried, crushed to -10 mesh, and subsampled to 800 g to 1,000 g. The subsample was forwarded to AAL for final preparation and analysis.

All samples were analyzed for gold, with most also analyzed for silver, using fire assay (FA) methods with atomic absorption spectroscopy (AAS) for gold determination. Analyses employed a 29.162 g (1 assay-ton) sample. For most programs (excluding Fischer-Watt), results were reported in g/t Au. Original assay certificates were archived on site. Sample preparation and analysis procedures adhered to industry standards and were summarized by CAM (2005) as follows:

- Samples were dried in an oven at 140°F.
- Samples were crushed to minus 10-mesh, ensuring >80% passed through a 10-mesh screen.
- A 200 g to 400 g subsample was split using a Jones Riffle Splitter, with remaining reject material bagged and saved.
- Subsamples were pulverized in a ring-mill pulverizer, achieving at least 90% passing a 150-mesh screen.
- Pulverized samples were homogenized on a rolling cloth, and a 29.162 g (1 assay-ton) sample was taken for FA.

Gold analysis followed standard FA techniques. Samples were fused with a natural flux, inquarted with 4 mg of gold-free silver, and cupelled. Silver beads were digested in nitric acid for 1.5 hours, followed by hydrochloric acid to dissolve gold into solution. Samples were diluted to 10 mL, homogenized, and analyzed by AAS.



Silver analysis involved digesting prepared samples in a hot nitric-hydrochloric acid mixture, reducing to dryness, and transferring to a volumetric flask with a 25% hydrochloric acid matrix. Solutions were analyzed by AAS.

For the East Ledge drilling programs (2001–2002), Minosa analyzed samples at the San Andrés mine laboratory using procedures consistent with blast hole drill samples. These adhered to industry standards and included:

- Drying samples in an oven at 140°C.
- Crushing samples to minus ¼-inch using a jaw crusher.
- Splitting a 50 g to 60 g subsample, with remaining rejects bagged and saved.
- Subsamples were pulverized in a ring-mill pulveriser, achieving at least 90% passing a 150-mesh screen.
- Homogenizing pulverized samples and taking a subsample for FA.

The mine laboratory followed the same FA and AAS methods for gold and silver analysis as the North American labs. Sample security and preparation met industry standards, as confirmed by CAM (2005).

11.2.1.2 2006 – 2008

Starting in February 2006, all exploration samples were submitted for gold analysis to the CAS laboratory in Tegucigalpa, operated by Custom Analytical Services, Inc., based in Washington State. RC samples continued to be prepared at the mine laboratory, while core samples were sent to CAS for preparation and analysis. CAS was not an accredited laboratory.

Sample preparation and analysis at CAS consisted of:

- Samples were dried at a temperature of 60°C.
- Crushed to -10 mesh and split in a Jones Riffle Splitter until 250 g to 300 g.
- Subsamples were pulverized with a ring and puck mill to 90% passing -150 mesh.
- Manual screen analysis tests were performed on sample pulps, one in every 15 samples, to ensure that proper grinding was maintained.
- Pressurized air and a silica (glass) rinse were used between each sample to clean the milling rings and bowls to ensure no cross-contamination occurred.
- Coarse rejects were stored indoors for a period of 30 days free of charge. All sample pulps were stored for up to sixty days at no charge.

The analytical procedures at CAS were as follows:

- A 30-g pulp was analyzed by FA with AA.
- If the gold assay result was greater than 1,000 ppb Au, the sample was re-assayed by FA with gravimetric finish.
- Each set of samples assayed (usually 28 in a set) included a blank, a standard, and two random repeats. The controls were used for internal purposes. All QA/QC controls were reported.

In March 2006, prior to restarting the exploration drilling program after the Mine was acquired by Minosa, procedural reviews were conducted at the San Andrés mine laboratory and the CAS



laboratory in Tegucigalpa. On March 30, 2006, Rod Hanson, a sampling consultant, along with David Turner and Sergio Brandão Silva, Senior Geologists for Minosa, conducted a due diligence visit to the CAS laboratory. Minosa and its consultant deemed the equipment and procedures at CAS satisfactory.

11.2.2 Current Work (2010 – 2024)

The San Andrés Mine utilizes the in-house Minosa Laboratory (LMI) as its primary assay laboratory. While LMI is not certified, it routinely incorporates quality assurance and quality control (QA/QC) protocols, including the insertion of blanks, standards, and duplicates into each batch of samples analyzed. Results from internal QA/QC checks are included in the laboratory's analytical reports.

Control sample analysis data are stored both in the laboratory's records and the San Andrés Digital Database. All assay results and Certificates of Analysis from the laboratory are delivered in digital format to the San Andrés database manager for integration.

The 2014 NI 43-101 Technical Report (Aura 2014) describes the sample handling and analytical procedures implemented during the 2012–2013 period. Aura (2014) reports that most samples from the 2012–2013 drilling campaign were processed at the mine laboratory, except for 15 drill holes (MO-12-41 to MO-12-55), which were sent to Inspectorate America Corporate (INS). Samples were transported to the INS preparation laboratory in Guatemala for processing before being sent to Reno, USA, for analysis.

The INS Laboratory operates as part of the Bureau Veritas Group, which holds ISO 9001 and ISO 14001 certifications and is independent of Aura.

The INS laboratory followed procedures comparable to those used at LMI and served as Minosa's QA/QC check assay facility. LMI applied identical sample preparation and analytical methods for both blasthole and exploration samples, with all analyses conducted exclusively for gold. Since late 2012, both production and exploration samples have been analyzed using fire assay and hot cyanide leach methods with atomic absorption (AA) finish. Prior to late 2012, exploration samples were analyzed solely by fire assay. To mitigate cross-contamination risks, exploration samples were processed and analyzed in separate batches from production samples.

The sample preparation and analytical procedures are listed:

- Samples were initially dried at 140°F, then crushed to approximately $\frac{1}{4}$ inch using a small jaw crusher.
- A 300 g sub-sample was separated using a riffle splitter, while the remaining -10 mesh fraction was bagged and retained by the exploration team for QA/QC verification and external checks.
- The 300 g split was pulverized using a ring-mill pulverizer, with a target specification of at least 90% passing a 150-mesh screen.
- The pulverized material was homogenized using a rolling cloth, and a split was collected for fire assay.
- Gold analysis was performed using standard fire assay techniques. Samples were fused with a flux containing inquarted gold-free silver, followed by cupellation. The resulting silver beads were digested in nitric acid for 1.5 hours to remove silver, followed by



hydrochloric acid digestion to bring gold into solution. The final solution was cooled, diluted to a 10 ml volume, homogenized, and analyzed for gold by AA.

- For hot cyanide leach analysis, a 10 g aliquot was placed in a vial, and 20 g of cyanide solution (10,000 ppm) was added. The sample was agitated using a Thermo Scientific Precision agitator for approximately one hour, followed by centrifugation in a Thermo Scientific Heraeus Megafuge 16 for three minutes. The resulting solution was then analyzed by AA.

The actual sample preparation and analytical processes at LMI include:

- Samples were dried at 175°C and coarsely crushed to 75% passing through a 10 ASTM # and 250 g split was pulverization to 95% passing 140 ASTM# mesh using a Jones splitter.
- Gold was assayed in the laboratory using two different methods, as follows:
 - Method Au-FA30: Gold was assayed using Fire Assay (FA) digestion with an Atomic Absorption Spectroscopy (AAS) finish. A 30-gram sub-sample was used for the assay. The lower detection limits for gold are 0.01 ppm and the over limit is 10 ppm.
 - Method Au-CN10: Gold was also assayed using Cyanidation (CN) digestion with an AAS finish. A 10-gram sub-sample was used for this assay. This method also provides detection limits for gold ranging from less than 0.01 ppm to greater than 10 ppm.

During the 2024 site visit, the SLR QP visited the Minosa Laboratory (LMI), observing that the equipment, sample management, and laboratory protocols are appropriate. The Minosa geological team checks the laboratory precision with SGS laboratory in Peru. The validation methodology is appropriate, as further discussed in Section 11.5.

The SLR QP recommends reducing the dried temperature to 105°C and continue the soluble cyanide gold assay for production blast hole assays and plant metallurgical control.

The SLR QP recommends determining the sample granulometry of the 10# sample before the first split and incorporating this in the sampling protocol.

11.3 Density Determinations

A total of 15,265 density samples were collected from 1997 to 2023 for San Andrés, as summarized in Table 11-1, which presents the density sample selection by year, oxidation and measured.

Figure 11-2 show the 2024 density sample selection.

Table 11-1: Density Measurements

Year	Total		Oxide		Transitional / Mixed		Sulphide		Other	
	# Samples	Density (g/cm ³)	# Samples	Density (g/cm ³)	# Samples	Density (g/cm ³)	# Samples	Density (g/cm ³)	# Samples	Density (g/cm ³)
1997	163	2.29	91	2.18	5	2.57	67	2.43		
1998	974	2.31	525	2.27	115	2.34	333	2.35	1	2.02
2006	32	2.52	14	2.51	5	2.53	13	2.54		
2007	44	2.51	13	2.47	2	2.54	29	2.53		



Year	Total		Oxide		Transitional / Mixed		Sulphide		Other	
	# Samples	Density (g/cm ³)	# Samples	Density (g/cm ³)	# Samples	Density (g/cm ³)	# Samples	Density (g/cm ³)	# Samples	Density (g/cm ³)
2008	26	2.52	5	2.49	2	2.54	19	2.52		
2020	5,315	2.35	3,144	2.27	403	2.32	1,739	2.50	29	2.30
2021	6,729	2.42	1,798	2.29	371	2.34	4,529	2.48	31	2.28
2022	929	2.31	769	2.30	91	2.33	69	2.29		
2023	1,053	2.47	242	2.30	16	2.25	795	2.53		
Total	15,265	2.38	6,601	2.28	1,010	2.33	7,593	2.48	61	2.28

Figure 11-2: Density Sample Selection



11.3.1 Previous Work

The historical density procedures are described in detail in Aura (2011) and are briefly outlined here.

Specific gravity determinations for the East Ledge and Twin Hills deposit areas, as reported by CAM (2005), were performed using the “weight in air – weight in water” method. Samples were air-dried for two to four weeks before measurements. Using a balance, the weight of the sample was recorded in air, followed by weighing the sample in water. For the latter, a cradle suspended from the balance base was submerged in a barrel of water, and the sample's weight in water was calculated as the difference between the cradle/sample weight in water and the weight of the empty cradle in water.



Moderately to strongly argillaceous samples were wrapped in plastic to prevent water absorption in pore spaces, fractures, or argillic alteration minerals. Tests were performed on whole core pieces.

11.3.1.1 East Ledge Specific Gravity Determinations

In 1998, Greenstone measured specific gravity on 460 core samples from eight PQ-diameter metallurgical holes and twelve HQ-diameter exploration holes in the Water Tank Hill area. Samples were categorized by principal mineralized and barren rock types, with an overall average specific gravity calculated for each.

The data were further refined to evaluate the impact of mineralization on specific gravity. Mineralized samples (>0.50 g/t Au), typically strongly silicified or quartz-veined, were segregated from the general dataset, and a separate average specific gravity was calculated for these samples.

Since the geology of the Water Tank Hill and East Ledge pits was very similar, additional specific gravity tests were not performed at East Ledge, and the values obtained from Water Tank Hill were applied to East Ledge.

11.3.1.2 Twin Hills Specific Gravity Determinations

In 1998, Greenstone conducted specific gravity measurements on 191 core samples from ten HQ-diameter exploration holes in the Twin Hills area. Results were calculated separately for oxide and mixed zones.

- In the **oxide zone**, 151 samples were tested, 140 of which had rock types coded. The average density was 2.25 g/cm³, with a standard deviation of 0.15.
- In the **mixed zone**, 40 samples were tested, all of which had rock types coded. The average density was 2.37 g/cm³, with a standard deviation of 0.29.

Although the mixed zone showed a higher specific gravity of 2.37, a limited number of samples were tested from this zone, and there is a lack of production data for this material. As a result, a uniform specific gravity of 2.25 g/cm³ was applied across all rock and ore types in the model.

11.3.1.3 Gravity Determinations 2020,2021,2022,2023

From 2020 to 2023, Minosa took a total of 14,056 samples for in-house density sampling, with samples taken for each core hole every 1.5 m.

The 2024 density sampling program is in progress and was not incorporated in the 2024 Mineral Resource estimation.

11.4 Sample Security

11.4.1 Previous Work

RC drill samples were transported from the San Andrés Mine to Minosa's Santa Rosa de Copán office by company vehicle and subsequently shipped to CAS de Honduras (CAS) in Tegucigalpa via courier. A work request form accompanied each shipment, and CAS verified sample numbers upon receipt, notifying Minosa of any discrepancies. Assay results were transmitted electronically, with signed certificates delivered by courier to Santa Rosa de Copán for archiving in the mine's exploration records. Bulk rejects were returned to Santa Rosa de Copán by courier and subsequently transferred to the mine's storage facility.



Split core samples were transported by Minosa employees to the company's offices in Santa Rosa de Copán and then sent to CAS via an independent courier for preparation and assay. The core boxes were transferred by company employees to a core logging facility at the sample storage site.

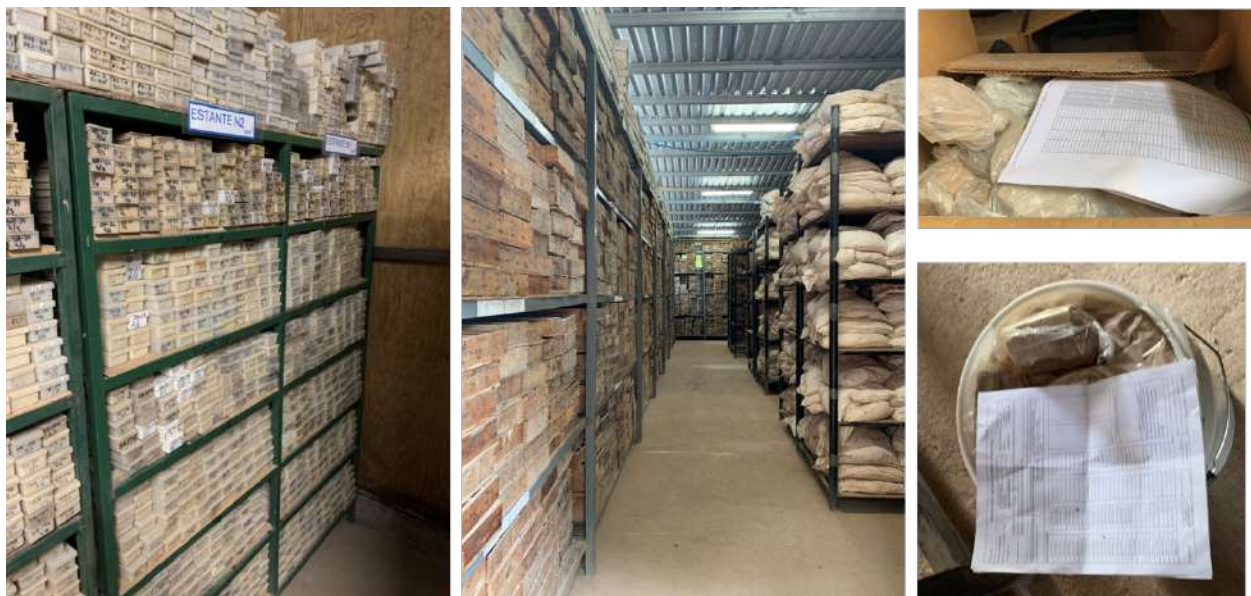
All sampling, including RC and core samples, was conducted by company personnel. A secure chain of custody was maintained from the drill site to the CAS assay laboratory. Drill core and RC samples were stored in a secure facility at the mine site.

11.4.2 Current Work

Check samples requiring preparation were transported by ADL, a logistics company, from the site to INS's sample preparation laboratory in Guatemala City. Once prepared, the pulp samples were shipped to INS's analytical laboratory in Reno. Pulverized check samples were sent directly to the Reno facility without additional preparation.

Each shipment was accompanied by a work request form, and upon receipt, INS verified the sample numbers against the documentation. Any discrepancies were reported to Minosa via email. Once analyses were completed, assay results were transmitted electronically, and original signed assay certificates were sent to the site via courier. Samples, including RC, split core, and pulp samples, are stored in a secure facility at the mine site (Figure 11-3).

Figure 11-3: Sample Storage Facility



The SLR QP is of the opinion that the sample security procedures at the Mine comply with industry standards.

11.5 Quality Assurance and Quality Control

Quality assurance consists of evidence that the assay data has been prepared to a degree of precision and accuracy within generally accepted limits for the sampling and analytical method(s) to support its use in a mineral resource estimate. Quality control consists of procedures used to ensure that an adequate level of quality is maintained in the process of collecting, preparing, and assaying the exploration drilling samples. In general, QA/QC programs are designed to prevent or detect contamination and allow assaying (analytical),



precision (repeatability), and accuracy to be quantified. In addition, a QA/QC program can disclose the overall sampling-assaying variability of the sampling method itself.

11.5.1 Previous Work

This section synthesizes the QA/QC protocols followed up to 2010, as detailed in Aura (2011).

11.5.1.1 Pre-2006 Drilling

Fisher-Watt submitted samples for assay to the AAL in Sparks, Nevada. Details of any QA/QC programs for this work remain unknown. Greenstone submitted samples to Chemex in Mississauga, Ontario, from 1994 to 1997, but subsequently used Barringer Assay Laboratory in Reno, Nevada, for samples collected in 1998. From 2001 to 2005, Minosa primarily used the San Andrés mine assay laboratory, with some check samples sent to CAS in Tegucigalpa, Honduras.

East Ledge

Two separate check assay programs were conducted on RC drill samples in 2002.

The first program involved submitting a sample split to the laboratory concurrently with the primary sample. This procedure was implemented for all 47 drill holes from the 2002 drilling campaign.

The second program commenced after the first 14 holes were drilled, and their assay results were reviewed. It was observed that check samples submitted at the same time as primary samples showed good correlation, whereas check samples submitted later had poorer correlation. Starting from the 15th hole of the campaign, a second duplicate sample was submitted at least two days after the primary sample and the first duplicate.

CAM (2005) reviewed the QA/QC data for drilling at East Ledge. After conducting statistical analyses and verifying data entry, CAM concluded that the exploration database was prepared to industry standards and was suitable for developing geological and grade models.

Twin Hills

Check assay programs for the Twin Hills drill data were reported by CAM (Armbrust et al. 2005) to have been conducted in four phases:

- In 1995, a check-assay program on RC drill samples involved taking one random 1.5 m duplicate sample approximately every 100 m and submitting it to either AAL or Chemex Labs for assay. Duplicate assays showed strong correlation with the original assays.
- In early 1998, Greenstone initiated a second check assay program on 1,544 duplicate samples from 136 drill holes (SA-149 through SA-285) from the 1997–1998 RC drilling programs. These samples, which included holes collared at Twin Hills and nearby prospects, consisted of one random duplicate taken every six to ten metres (15% of total samples). Statistical analysis performed by Mine Development Associates (MDA) demonstrated excellent correlation between original and duplicate assays, with a correlation coefficient of 0.96 for gold and 0.94 for silver.
- Eighty-six pulp samples from Chemex were sent to Barringer, and 92 pulps were sent from Barringer to Chemex to evaluate inter-laboratory variability. Additionally, 118 coarse rejects were sent from McClelland Labs in Tegucigalpa to CAS Labs in Tegucigalpa and analyzed by both Barringer and CAS to assess the sample preparation



procedures at McClelland. Results demonstrated a good correlation coefficient for gold ($r = 0.950\text{--}0.997$) between labs, confirming assay reproducibility within industry standards.

- Metallic screen assays were performed on 47 samples to check for coarse gold. Approximately 4% of the total gold was in the +150-mesh fraction. However, MDA concluded that this did not affect assay reproducibility.

11.5.1.2 2006 - 2008 Drilling

Standard Reference Material

During drilling conducted by Yamana from 2006 to 2008, six certified standard reference materials (SRMs) were inserted into the sample stream at a rate of 1 in 20 samples. These SRMs were procured from Geostats Pty of Australia and had gold grades ranging from 0.33 g/t Au to 6.83 g/t Au.

The CAS laboratory, in general, underestimated the expected values of the SRMs:

- Standards 1 and 2 were underestimated by approximately 10%.
- Standards 3, 4, and 5 were underestimated by approximately 3%.
- Standard 6 was underestimated by only 1%.

Despite these discrepancies, the check assay results between CAS and Minosa, as well as CAS and ACME, showed good correlation.

Blank Samples

Minosa inserted blank samples at regular intervals within the sample stream. Overall results confirmed acceptable performance, indicating minimal cross-contamination between samples during preparation or analysis.

Duplicate Samples

As per the RC drilling sample collection methodology, Minosa collected two samples from the RC cuttings: Sample “A” was sent for analysis, while Sample “B” was stored. A duplicate sample was collected from Sample “B” every 10th sample and submitted for assay. Results of duplicate sampling demonstrated a strong correlation ($r = 0.977$) and comparable mean grades between the original and duplicate samples.

Check Assay

Between 2006 and 2008, CAS split every 10th sample and submitted these to both Minosa (the mine laboratory) and the independent ACME Analytical Laboratories (Vancouver) Ltd. The comparison of assays between CAS and Minosa, and CAS and ACME, showed strong correlation, with coefficients better than 0.96. The mean grades of the check assays were similar, indicating consistent results among the laboratories.

These findings supported the conclusion by J. Britt Reid et al. (Aura 2012) that CAS assay results were sufficiently reliable for use in Mineral Resource and Mineral Reserve estimation.

11.5.2 Current Work (2010 - 2024)

The Minosa QA/QC program included submittal of both blind and non-blind control samples into the sample stream being analyzed by the laboratory.



The QA/QC program mandates the insertion of control samples within each batch submitted for analysis, as outlined below:

- Certified Reference Materials (CRMs): One high-grade and one low-grade or medium-grade CRM in every analytical batch of 40 samples (approximate insertion rate of 5%).
- Blank Samples are inserted at a rate of 1 in 20 (5% insertion), primarily after mineralized intervals, to detect contamination.
- Duplicate Samples are inserted at a rate of 1 in 20 (approximately 5%), including field duplicates (quarter-core), coarse, and pulp duplicates (splits of pulverized material).
- Check Assays: Check assays were performed between 2012 and 2013, and again in 2024, with a total of 1,958 samples analyzed.

The acceptance criteria and protocols for failures are presented as follows:

- CRMs: A batch fails automatically if any CRM assay result exceeds three standard deviations from the CRM’s certified mean. The entire batch must be re-assayed. CRM trend analysis is performed to monitor bias. If trends indicate possible bias, the laboratory is contacted to resolve the issue.
- Blanks: If blank assays exceed three times the detection limit, ten samples surrounding the blank are automatically re-assayed.
- Duplicates: Field duplicates are not used to determine failure of assay certificates but are reviewed to monitor precision and variability.

The control samples account for approximately 16% of the total samples. Table 11-2 presents a summary of the project’s QC submittals by year.

Table 11-2: San Andrés QC Submittals: 2010 to 2024

Phase/ Year	Primary Samples	Blanks		CRM		Field Duplicates		Coarse Duplicates		Pulp Duplicates		Check Assay		Overall Insertion Rate
		No.	%	No.	%	No.	%	No.	%	No.	%	No.	%	
Historical (1992 - 2008)	67,396	-		-		-		-		-		-		-
2010	2,168	57	2%	25	1%	43	2%	-		-		-		5%
2011	414	68	12%	34	6%	70	12%	-		-		-		29%
2012	5,674	92	1%	191	3%	132	2%	134	2%	-		159	2%	11%
2013	7,269	211	2%	580	6%	300	3%	54	1%	452	5%	442	5%	22%
2014	2,405	88	2%	255	6%	492	12%	436	11%	262	7%	-		39%
2015	3,009	121	2%	250	5%	558	12%	518	11%	386	8%	-		38%
2016	6,615	237	3%	525	7%	-		-		-		-		10%
2017	8,930	333	3%	618	6%	-		-		-		-		10%
2018	8,128	320	4%	510	6%	-		-		-		-		9%
2019	4,814	133	3%	201	4%	-		-		-		-		6%
2020	9,203	358	4%	640	6%	-		-		-		-		10%
2021	12,785	404	3%	882	6%	-		-		-		-		9%
2022	3,883	147	3%	324	6%	382	7%	252	5%	433	8%	-		28%
2023	8,198	255	3%	582	6%	416	4%	-		-		-		13%



Phase/ Year	Primary Samples	Blanks		CRM		Field Duplicates		Coarse Duplicates		Pulp Duplicates		Check Assay		Overall Insertion Rate
		No.	%	No.	%	No.	%	No.	%	No.	%	No.	%	
2024	7,393	232	3%	540	6%	426	5%	-	-	-	-	1,958	19%	30%
Grand Total (2010 - 2024)	90,888	3,056	3%	6,157	6%	2,819	3%	1,394	1%	1,533	1%	2,559	26%	16%

Observations from SLR’s review of the San Andrés QA/QC database, encompassing data from 2010 to the 2024 drilling campaign, are presented in the following discussion.

Certified Reference Material

Results of the regular submission of CRMs (standards) are used to identify potential issues with specific sample batches and long-term biases associated with the primary assay laboratory. Over the San Andrés Mine’s history, a total of 6,157 CRMs from Geostats Pty Ltd. were submitted to LMI Laboratory, comprising 31 different CRM types.

The performance of these CRMs, summarized in Table 11-3, was evaluated using control limits set at ± 3 standard deviations (SD) above or below the expected values.

All CRMs were initially reviewed for overall performance using z-score plots, which included all CRM series, as showed in Figure 11-4. Most of the data points fall within the ± 2 SD range, demonstrating consistent laboratory accuracy.

Overall, the LMI laboratory demonstrated reliable performance, despite sporadic deviations beyond ± 3 SD limits in some CRMs, which do not indicate systemic inaccuracies. The following specific observations were noted:

- CRM G917-6: A notable bias of -13.5%, possibly due to mislabeling.
- The CRM 999-2 indicates a high bias; however, this bias appears to be due to sample swaps, particularly during the 2011 period.
- SLR understands that the number of outliers observed in the CRMs G318-7 and G321-7 was due to sample swaps. The QP recommends to thoroughly investigate each of these samples and ensure strict adherence to sampling protocols to prevent mislabeling errors.
- CRM G315-5: Exhibited a bias of 7.56%, likely associated with its low-grade nature, with no outliers detected.
- CRM G306-1: High bias of -10.98%, though limited sample count reduces the representativeness of this result. The CRM was used only until 2012, limiting its relevance for ongoing performance monitoring.
- CRM 308-4: Showed a significant bias of -17.48%. The bias source is uncertain, potentially linked to storage, preparation, or assay reading errors. Given the limited samples and the discontinuation of its use in 2011, no further investigation was conducted.

The results indicate that recent analyses have shown better control, and the results have improved over time, despite the mislabeling issues found in some CRMs used in 2023/2024.

CRMs cover a good range of gold grades analyzed by the FA-AAS method. However, SLR noted that in 2023 and 2024, multiple CRMs with overlapping grade ranges were introduced. The SLR QP recommends consolidating the selection to three CRM types—high-grade,



medium-grade, and low-grade—to effectively monitor laboratory performance while simplifying the identification of emerging biases or systematic errors over time.

Table 11-3: San Andrés Certified Reference Material Performances

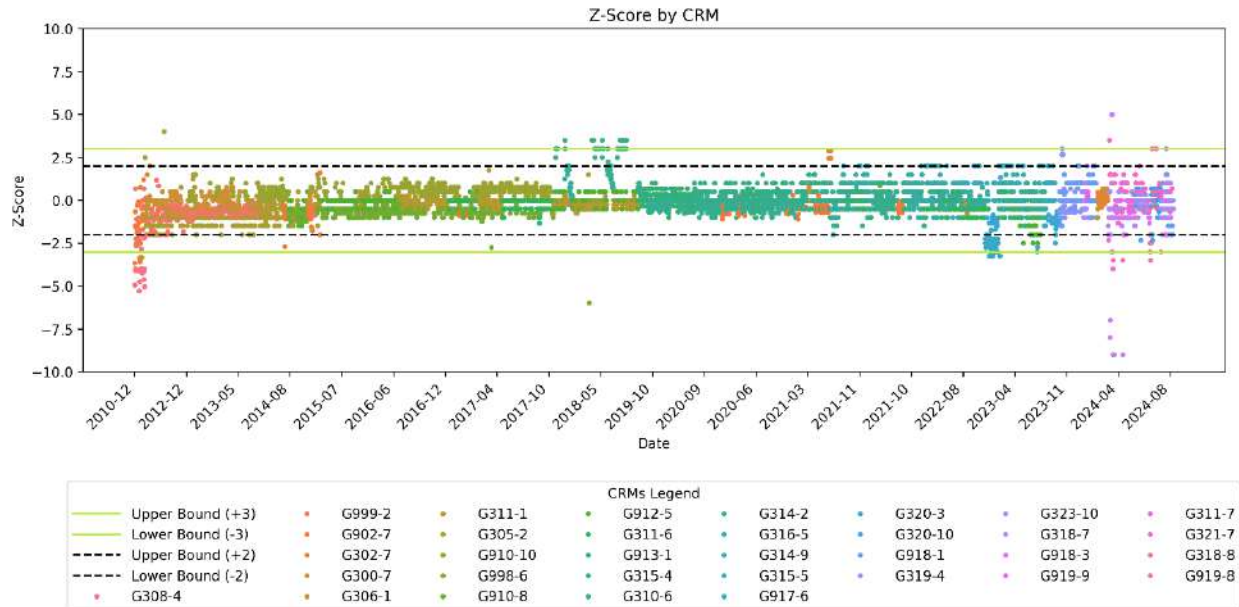
CRM	Year Range	No. Samples	Mean	EV	SD	No. Outliers	Bias (%)	Percentage Outliers (%)
G308-4	2010-2011	17	5.59	6.77	0.29	14	-17.48	82.35
G306-1	2010-2012	6	0.37	0.41	0.03	1	-10.98	16.67
G999-2	2010-2015	275	0.58	0.63	0.06	1	-7.20	0.36
G300-7	2010-2021	200	0.99	1	0.04	0	-1.09	0.00
G902-7	2010-2021	154	1.34	1.41	0.1	2	-4.93	1.30
G302-7	2010-2024	78	2.15	2.14	0.09	4	0.47	5.13
G305-2	2011-2015	258	0.30	0.32	0.02	1	-6.10	0.39
G311-1	2011-2024	474	0.51	0.52	0.04	0	-1.48	0.00
G910-10	2012-2017	471	0.99	0.97	0.04	0	2.40	0.00
G910-8	2014-2018	407	0.60	0.63	0.04	1	-4.63	0.25
G998-6	2014-2021	34	0.82	0.8	0.06	0	2.50	0.00
G912-5	2014-2023	523	0.38	0.38	0.02	1	-0.98	0.19
G913-1	2017-2020	222	0.82	0.82	0.03	0	0.37	0.00
G311-6	2017-2023	425	0.22	0.22	0.02	0	-1.76	0.00
G310-6	2018-2021	531	0.65	0.65	0.04	0	0.23	0.00
G315-4	2018-2023	826	0.32	0.32	0.02	33	1.41	4.00
G314-2	2021-2022	97	0.99	0.99	0.04	0	-0.22	0.00
G314-9	2021-2023	9	1.52	1.52	0.06	0	0.15	0.00
G315-5	2021-2023	141	0.11	0.1	0.01	0	13.19	0.00
G316-5	2021-2023	201	0.51	0.5	0.02	0	1.08	0.00
G320-3	2023-2023	48	0.99	1.03	0.06	0	-4.23	0.00
G917-6	2023-2023	50	0.66	0.76	0.04	4	-13.50	8.00
G319-4	2023-2024	90	0.50	0.5	0.03	0	-0.40	0.00
G320-10	2023-2024	30	0.65	0.65	0.03	0	-0.31	0.00
G918-1	2023-2024	154	0.37	0.36	0.02	0	1.64	0.00
G311-7	2024-2024	48	0.39	0.4	0.03	0	-2.29	0.00
G318-7	2024-2024	70	0.30	0.31	0.01	9	-3.55	12.86
G318-8	2024-2024	13	0.79	0.79	0.03	0	0.19	0.00
G321-7	2024-2024	38	0.48	0.47	0.02	4	2.07	10.53
G323-10	2024-2024	109	0.22	0.23	0.02	0	-2.91	0.00
G918-3	2024-2024	20	0.50	0.52	0.03	0	-3.46	0.00
G919-8	2024-2024	27	0.56	0.57	0.02	1	-2.21	3.70
G919-9	2024-2024	14	0.97	0.95	0.04	0	1.73	0.00

Notes:

1. Au in ppm, EV: Expected Value, SD: Standard Deviation



Figure 11-4: San Andrés CRM Z-Score



SLR selected three CRMs for an in-depth review, representing the low, average, and high gold grade ranges.

As illustrated in Figure 11-5, the CRM G320-3, represented by results from 48 high-grade samples, did not display any outliers. However, the analyses indicate a slight negative bias of 4%, with the mean reported by ALS laboratory being marginally lower than the expected value. Despite this bias, the results remain within acceptable limits.

The CRM G918-1 analysis comprises 154 samples at an average grade, demonstrating strong performance with a minimal bias of 1.64% and no outliers, presented in Figure 11-6. All results fall well within acceptable limits, confirming the reliability of the dataset.

Figure 11-7 presents the results for CRM G315-5, where a total of 238 samples were analyzed. A positive bias of 7.56% was observed, with the laboratory's mean slightly above the expected value. No outliers were identified in the dataset. Considering this is a low-grade CRM, the observed bias can still be considered within acceptable limits.



Figure 11-5: Control Chart of CRM G320-3 for Gold in LMI: 2023



Figure 11-6: Control Chart of CRM G918-1 for Gold in LMI: 2023 - 2024

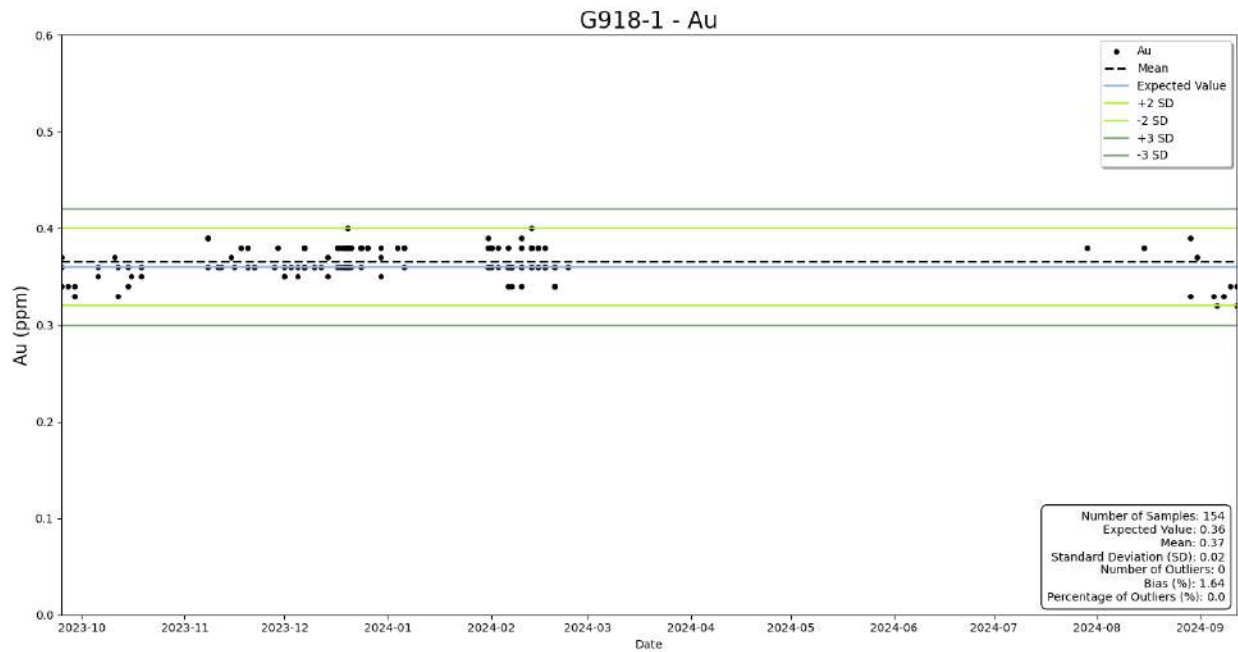
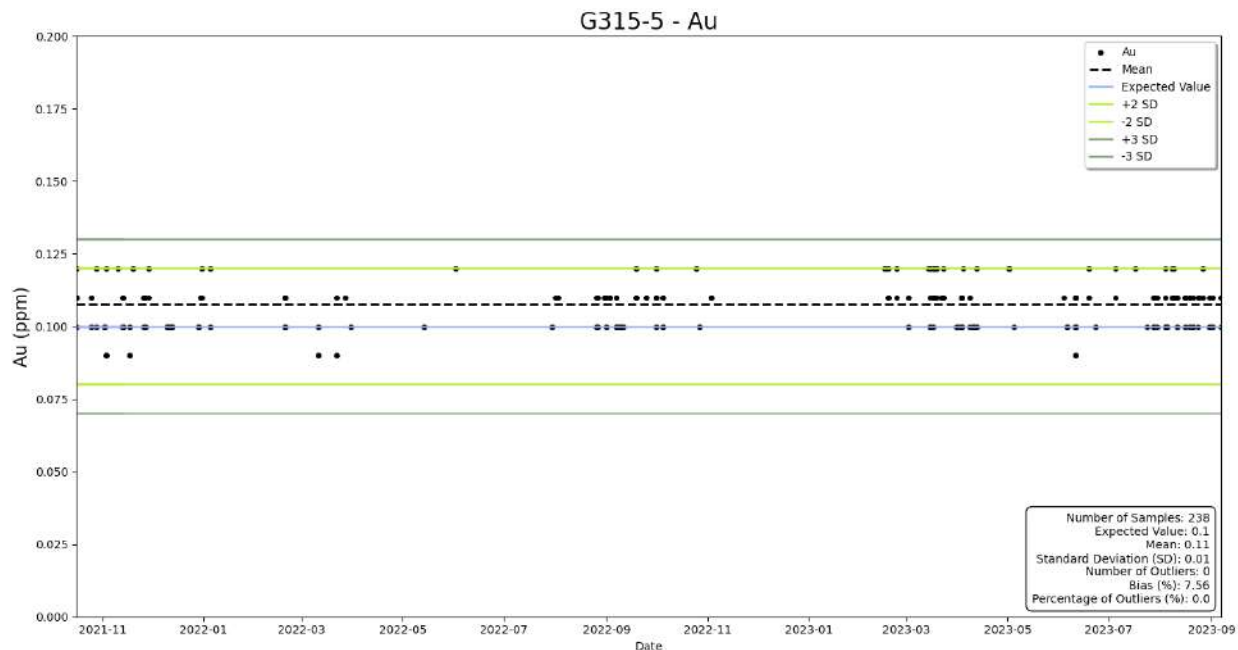


Figure 11-7: Control Chart of CRM GG315-5 for Gold in LMI: 2021 - 2023



The SLR QP recommends continuous monitoring of the CRM data to ensure early detection of potential emerging bias that may require re-analysis, and to promptly identify and rectify any biases that could affect the reliability of the results.

Blank Material

The regular submission of blank material is used to assess contamination during sample preparation and to identify sample numbering errors. Field blank samples are composed of barren material that have grades below the detection limit.

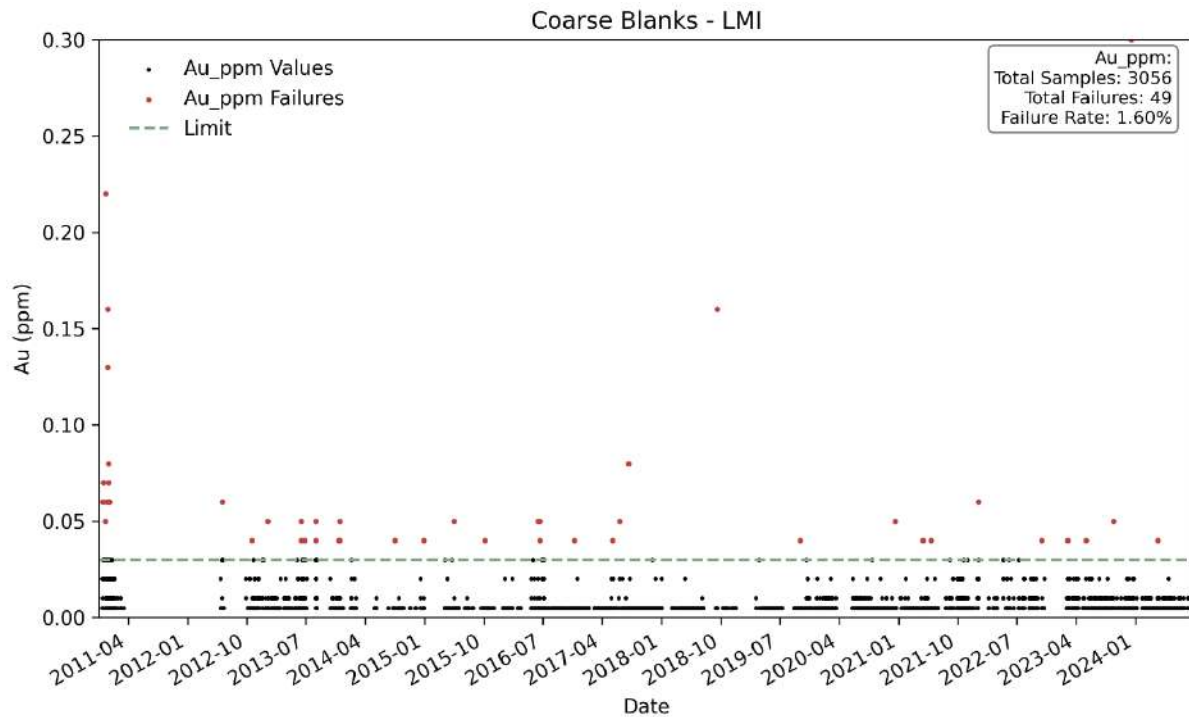
Between 2010 and 2024, a total of 3,056 coarse blanks were inserted into the sample stream, consisting of 3% of insertion rate.

The detection limit for gold (Au) using FA with an atomic absorption (AA) finish was established at 0.01 g/t Au. Control thresholds for blank samples were defined, with the warning limit set at two times the detection limit (0.02 g/t Au) and the failure limit at three times the detection limit (0.03 g/t Au). A review of the blanks indicates that no significant contamination was detected, as illustrated in Figure 11-8.

Of the 3,056 blank samples analyzed, 49 samples exceeded the threshold, representing a failure rate of less than 2%. Furthermore, most of these values were only slightly above the threshold or located within non-mineralized zones, negating the need for resampling around the failure blanks. Of the 49 failure samples, only 8 have values above 0.1 g/t Au, most of which were collected in 2010. SLR did not have access to the original certificates for these samples for comparison. The sample MO23-09534 (2023) is registered in the QA/QC database as blank; however, it is a mislabeled sample, as the original certificate lists it as a primary sample, and the blanks from the same batch have values below the detection limit.



Figure 11-8: Coarse Blank Samples in LMI



Duplicates

Duplicates help assess the natural local-scale grade variance or nugget effect and are also useful for detecting sample numbering mix-ups. The field (core) duplicates help monitor the grade variability as a function of both sample homogeneity and laboratory error.

The precision of sampling and analytical results can be quantified by re-analyzing the same sample using the same methodology. The variance between the measured results will indicate their precision. Precision is affected by mineralogical factors such as grain size, distribution, and inconsistencies in the sample preparation and analysis processes. There are different duplicate sample types, which can be used to determine the precision of the entire sampling, sample preparation, and analytical process.

As part of QA/QC procedures, SLR conducted a reassessment of the duplicate sample data using the Half Absolute Relative Difference (HARD) analysis and scatter plots to evaluate analytical precision.

A total of 5,746 sample pairs analyzed by LMI Laboratory were reviewed, including 2,819 field duplicate samples with a 3% insertion rate, and 1,394 coarse duplicates and 1,533 pulp duplicates, both with a 1% insertion rate.

Individual failure criteria were set for pulp, coarse, and field duplicates. Evaluation criteria require 90% of pulp duplicates to have a HARD value below 10%, 20% for coarse duplicates, and 30% for field duplicates. Thus, a 10% HARD failure rate threshold serves as the benchmark to trigger corrective actions for sample group surpassing this limit. Table 11-4 summarizes the performance of each duplicate type across different hole types.



Table 11-4: Summary of Duplicate Data Performance

Hole Type	Duplicate Type	Year Range	Correlation	Count	Failures (HARD)	HARD Failure Rate (%)	Max DP	Max OR	Mean DP	Mean OR	Min DP	Min OR
DD	FD	2022 - 2024	0.95	160	29	18.13	4.15	3.16	0.322	0.313	0.01	0.01
	CD	2022 - 2022	0.93	104	15	14.42	2.32	2.3	0.535	0.542	0.18	0.01
	PD	2022 - 2022	0.97	221	73	33.03	3.56	3.39	0.353	0.375	0.02	0.01
RC	FD	2010 - 2024	0.93	2,659	304	11.43	5.84	5.4	0.394	0.385	0.01	0.01
	CD	2012 - 2022	0.97	1,290	142	11.01	6.46	6.31	0.419	0.408	0.01	0.01
	PD	2012 - 2022	0.95	1,312	380	28.96	8.06	8.66	0.283	0.291	0.01	0.01
Notes: 1. DP: Duplicate 2. OR: Original 3. FD Field Duplicate, CD Coarse Duplicate, PD Pulp Duplicate												

For the RC datasets, both field and coarse duplicates displayed HARD failure rates near the 10% threshold for acceptable precision as shown in Figure 11-9 and Figure 11-10. Pulp duplicates, however, exhibited a higher HARD failure rate of 28%. The scatter plot analysis indicates that although data dispersion occurs across the full grade range, it is most pronounced at lower grades. Despite this variability, pulp duplicates show a strong correlation with original assays ($R = 0.95$).

For DD duplicates, HARD failure rates were somewhat higher than those of RC duplicates. Like RC data, pulp duplicates for DD samples showed elevated HARD rates yet maintained a strong correlation between duplicates and originals ($R = 0.97$), as illustrated in Figure 11-11.

These results suggest considerable assay variability across the dataset, which is likely influenced by the nugget effect, commonly seen in gold mineralization deposits.

The SLR QP recommends that the Mine continue submitting pulp and coarse duplicates on a regular basis, targeting an insertion rate of approximately 5% for each duplicate type. This approach, along with ongoing monitoring of assay results and laboratory protocols, is advised due to the elevated HARD failure rates observed in pulp duplicates compared to other duplicate types.



Figure 11-9: Field Duplicate Data - RC

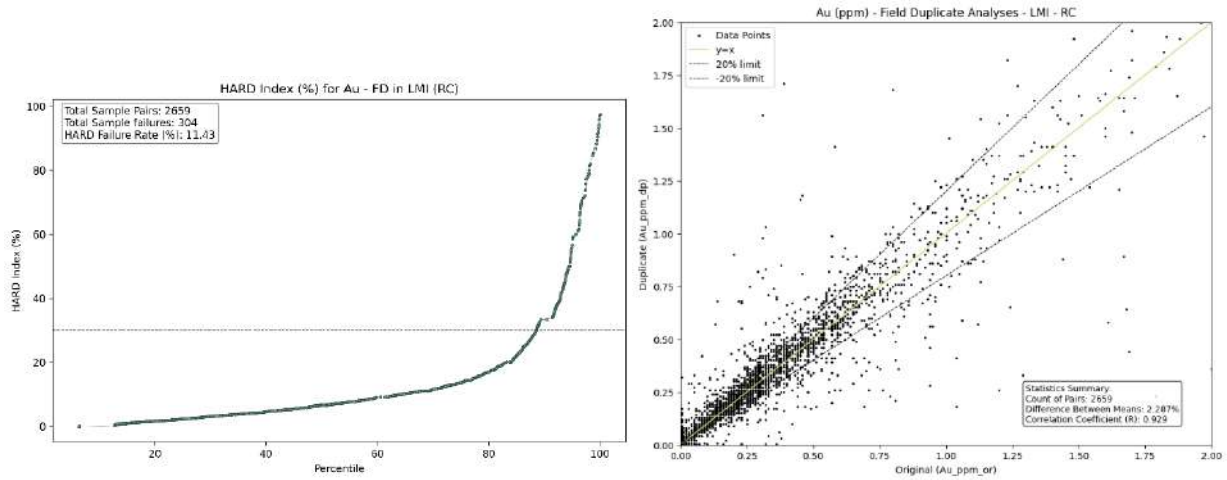


Figure 11-10: Coarse Duplicate Data - RC

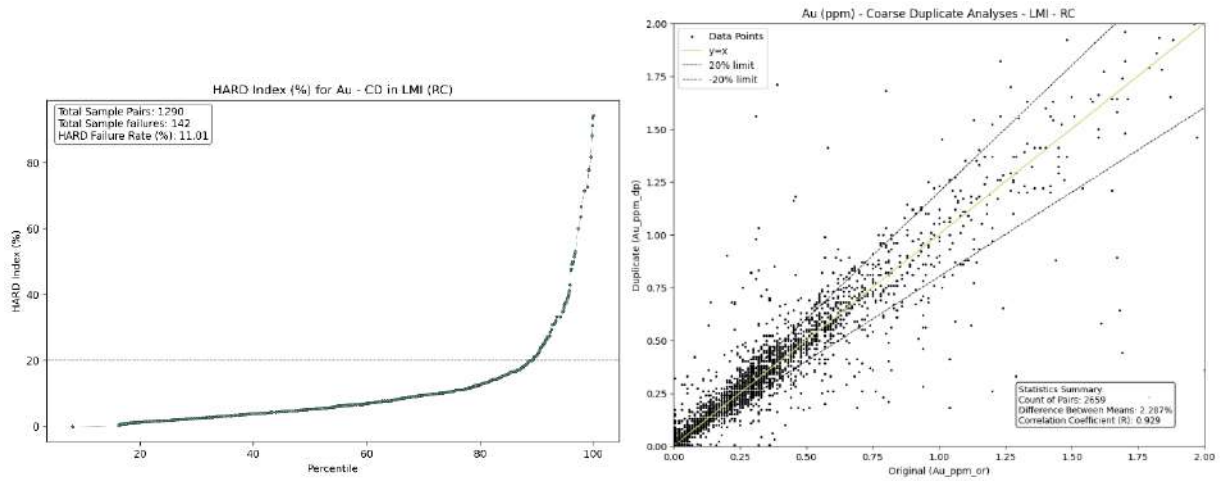
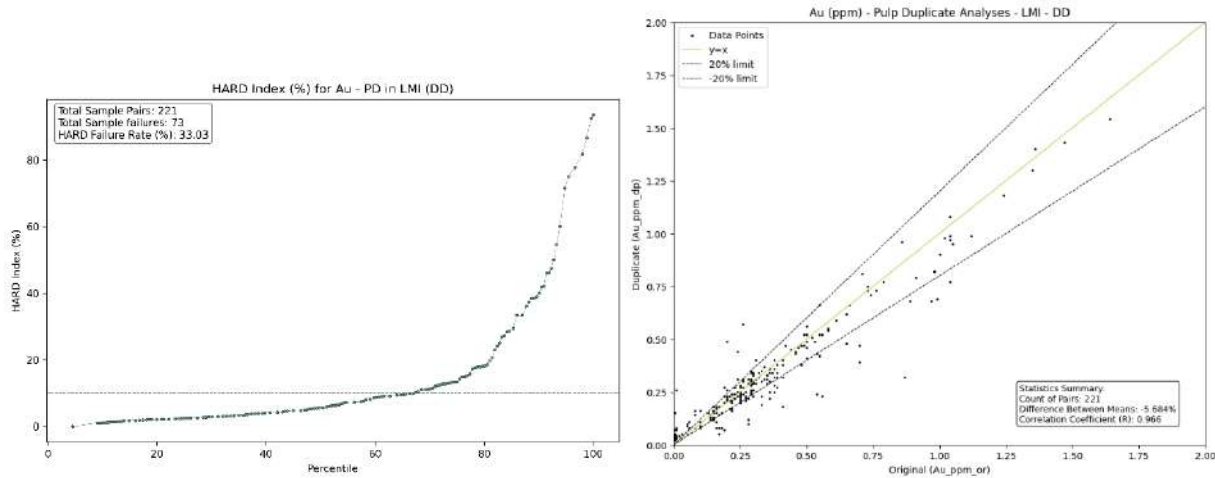


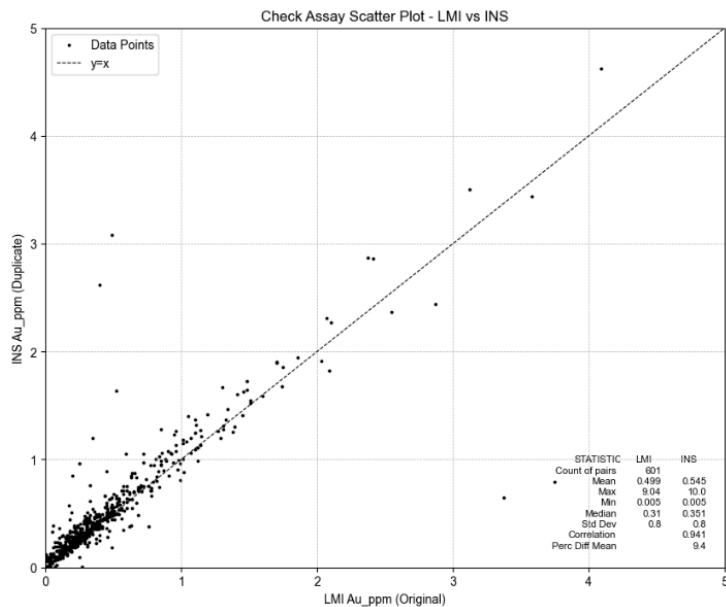
Figure 11-11: Pulp Duplicate Data - DD



Check Assay

Between 2012 and 2013, a total of 601 samples were collected from drill holes and submitted to the INS Laboratory, an independent third-party laboratory. The gold analyses, as presented in Figure 11-12, exhibited a strong correlation coefficient of 0.94 and a mean percentage difference of 9.4% between results reported by the LMI and INS laboratories, indicating a positive bias. Although a strong correlation is observed, some outliers were identified, which may be attributed to potential sample mix-ups. Despite these anomalies, the findings demonstrate that the datasets are statistically comparable, supporting the reliability and accuracy of the primary laboratory’s reported grades.

Figure 11-12: Check Assay - Scatter Plot (2012 – 2013)



In 2024, a total of 1,985 samples were submitted to the independent SGS laboratory in Peru for check analysis, as shown in Figure 11-12. The results indicate a difference between the means of -6.1%, highlighting a negative bias, which is evident in the QQ Plot (Figure 11-12). A strong correlation of 0.955 was observed, and despite the presence of some outliers, the overall results are considered robust and demonstrate good precision in the primary laboratory's assay performance. The samples were also analyzed using the Cyanide Leaching (CN) method, which exhibited greater data dispersion, as expected for this technique, and a high positive bias, as illustrated in Figure 11-14.

External check results demonstrated good data repeatability, indicating the reliability of the data reported by the primary laboratory. The SLR QP is of the opinion that the data is reliable and suitable for use in resource and reserve estimation, and recommends that Minosa continue to use a check assay program.

Figure 11-13: Check Assay - Scatter Plot and QQ Plot (2024)

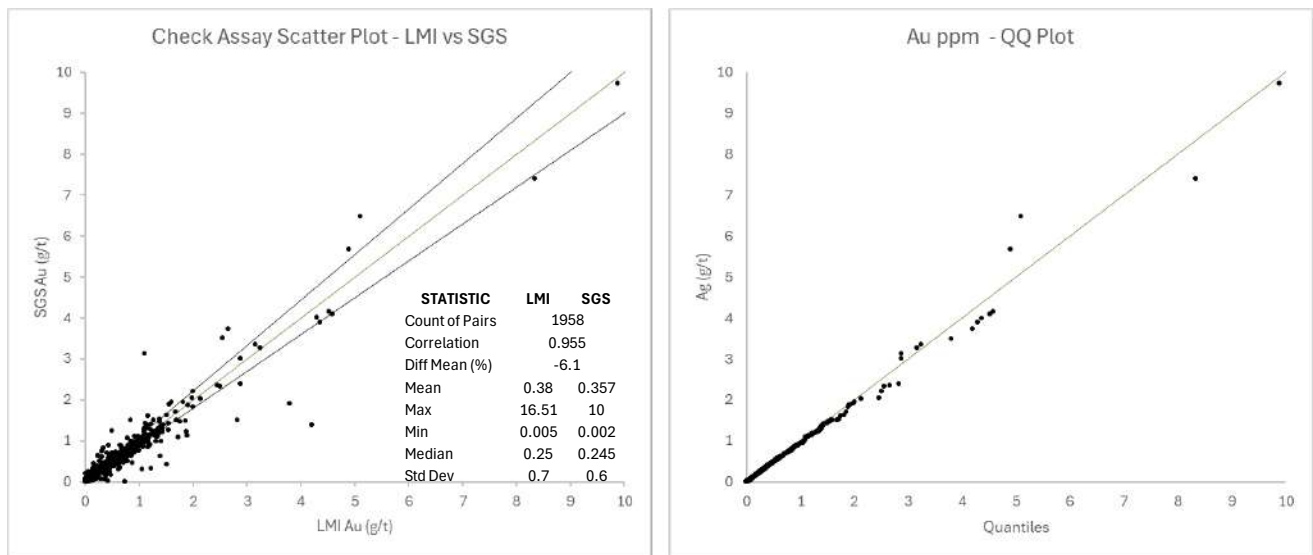
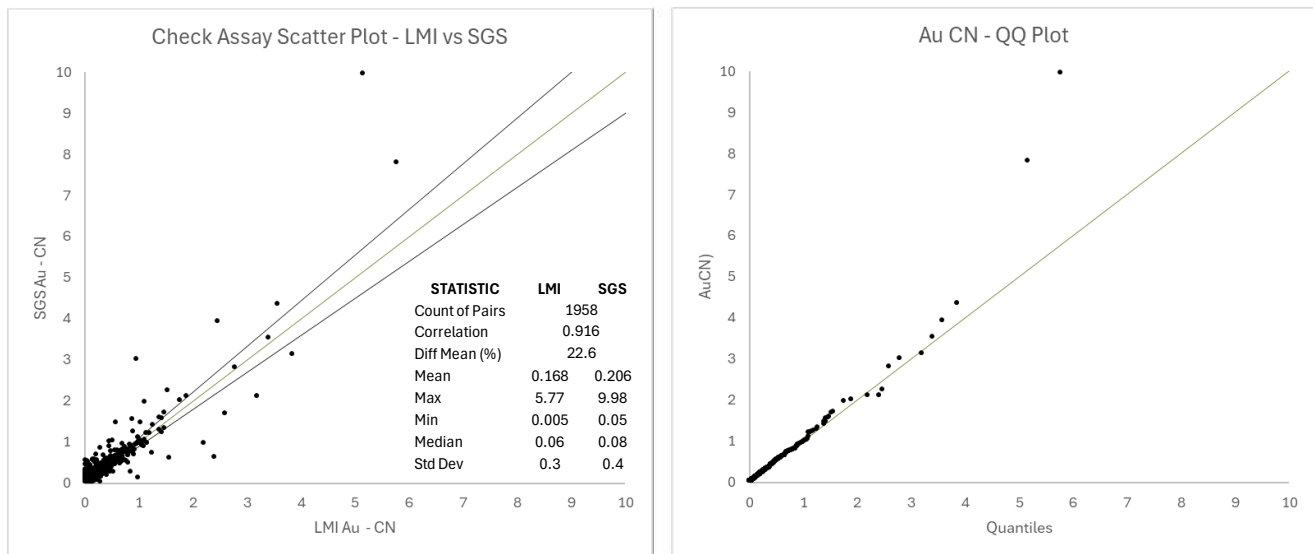


Figure 11-14: Check Assay - Scatter Plot and QQ Plot (2024) – Au CN



11.6 Conclusions and Recommendations

The SLR QP's QA/QC recommendations are as follows:

- Reduce the number of CRM types used. It is advisable to select a maximum of one CRM for each grade category (low, medium, medium-high, and high) aligned with the Mine's grade distribution.
- Continue the use of the three types of duplicates as routine practice: pulp duplicates, with a submission rate of 5% focused on economic grade, over the economical cut-off. These samples should be shipped along with blanks and standards to validate the secondary results.
- Maintain regular QC procedures and ensure consistent QC protocols to safeguard data integrity and reliability.

In the SLR QP's opinion, the sample preparation, analysis, and security procedures at San Andrés are appropriate for Mineral Resource estimation. Additionally, the QA/QC program designed and implemented by Minosa is adequate, and the assay results in the San Andrés databases are suitable for use in the Mineral Resource estimate.



12.0 Data Verification

12.1 Previous Work

The drill hole database used for Mineral Resource and Mineral Reserve estimation has undergone multiple verification efforts. In 2005, CAM independently verified the database. In 2006, Minosa reviewed 105 drill holes, focusing on survey, assay, and geological data. In 2007, Scott Wilson RPA verified data from 19 RC holes and one core hole from the 2005–2006 drilling programs. In 2011, MCB Serviços e Mineração Ltda. (MCB) did not conduct an independent verification but deemed the drill hole data reliable due to the strong correlation between drill hole grades and mined grades over more than 10 years of operation.

Details of the data verification programs for drilling campaigns conducted before 2010 drilling were detailed in the 2012 Technical Report (Aura 2012) and are summarized in the following subsections.

12.1.1 Survey and Topographic Data

From 1996 onward, drill hole collars were surveyed using modern electronic equipment, with the 1997–1998 programs employing a Topcon FC/48GX total station and resurveying about 1 in 15 holes for accuracy. Pre-1996 survey methods were undocumented but relied on reference points established during the 1992 Fischer-Watt program, with some collar coordinates estimated using compass and tape methods.

Survey data were later converted from a mine grid system to UTM coordinates by Minosa. Locatable pre-1996 holes were resurveyed, while others were mathematically converted using a grid-to-UTM factor. Downhole surveys were conducted on 14 core holes using a Sperry Sun single-shot instrument, with no corrections applied to holes lacking downhole surveys.

12.1.2 Pre-2005 Drill Programs

CAM (Armbrust et al. 2005) reported that assay results for the 1997–1998 Twin Hills and 2002 East Ledge drill programs were electronically transferred to the database, minimizing data entry errors. Earlier programs relied on manual data entry, which was later verified against original assay certificates before modeling.

About 80% of assay data were electronically transferred, while 20% (including eight of 86 East Ledge holes and 29 of 97 Twin Hills holes) were manually entered. Verification checks on seven manually entered holes found no discrepancies.

In 2005, CAM conducted thorough database checks, including assessments of duplicate collars, twin holes, anomalous surveys, assay statistics, assay spikes, contamination, and grade thickness. Minor anomalies were within industry norms and did not impact the resource estimate. CAM concluded the database met industry standards and was suitable for geological and grade modeling.

12.1.3 2005–2006 Drill Programs

12.1.3.1 Data Entry Procedures

For the 2005–2006 drill programs, Minosa employed the following database entry procedures:

- Geological Data Entry: Handwritten geological logs for each drill hole were manually entered into a master EXCEL database. This database was structured to be compatible



with MineSight software for modeling. It included data on collar location (northing, easting, elevation), survey details (bearing, dip), and hole depth, along with columns for drill hole ID, sample intervals (from/to), sample length, Au and Ag grades (when available), lithology, alteration, quartz vein percentage, oxide/sulphide, pyrite percentage, dry/wet condition, hematite, jarosite/goethite, structure, and sample ID numbers.

- Assay Data Entry: Assay results received electronically from the laboratory were cut and pasted directly into the master database. Assay data were also manually transcribed into individual paper drill logs to verify alignment with sample numbers and ensure drill log completeness.

Upon completion of data entry for each drill hole, a quick visual review of the EXCEL file was conducted to check for completeness and accuracy.

12.1.3.2 Data Verification

In April 2006, Minosa verified the database for 526 drill holes, up to MO-06-11. A total of 105 drill logs (20% of total) were randomly selected for review, comparing original paper logs and assay certificates against the electronic database for hole identification, total depth, collar coordinates, survey data, oxidation state, and assay information. No significant errors were detected.

Scott Wilson RPA conducted additional verification of the 2005–2006 drilling data, which were reported in Scott Wilson RPA (2007). Key findings included:

- Collar Surveys: No errors were found.
- Survey Information: Two discrepancies in dip angles (MO-06-46 and MO-06-48) were corrected (-45° in logs vs. -50° in the database).
- Oxidation State and Geological Data: No errors in oxidation state. Geological data were transcribed accurately, except for occasional omissions in structure-type entries.
- Assay Verification: A total of 1,990 samples from 19 RC holes and one core log were checked against handwritten logs, assay certificates, and the database. No errors were identified. For duplicate samples, assays from the "A" samples were consistently recorded in the database, and for duplicate pulps at the CAS lab, the first sample pulp assay was used consistently.

Scott Wilson RPA concluded that discrepancies were minor, and the database's geological and assay data were of high quality and suitable for Mineral Resource and Reserve estimation.

12.2 Current Work

12.2.1 SLR Site Verification Procedures

The SLR geology QP visited the site from October 21 to 24, 2024.

12.2.1.1 Confirmation of Mineralized Intercepts

During the site visit, the SLR QP visited the core storage facilities, and the geology, DDH log, and content of Au were visually compared for the drill holes MC-06-09, MC-21-32, MC-20-88, MC-21-17 and MC-20-63. In the SLR QP's opinion, there is a good correlation between



contained gold and the observed geology. The SLR QP recommends continuing with the oxide, mixed, and sulphide characterization.

During the site visit, the SLR QP observed good drill hole manipulation and data capture. Figure 12-1 shows samples of the DD core that was visually reviewed by the SLR QP.

Figure 12-1: Drill Hole Comparison



12.2.1.2 Confirmation of Drill Hole Location and Survey Information

At the time of the visit, the core drill hole MC-24-16 was in progress. SLR observed appropriate drilling technique and adequate drill core manipulation.



Figure 12-2: Drilling in Progress



12.2.2 SLR Audit of the Drill Hole Database

SLR performed cross-validation procedures between the Mine's assay database and the LMI assay certificates. A total of 841 certificates, dated from 2019 to 2024, were provided by the client and compiled and compared against gold values within the " SAEX-20240918_DB_assay.csv" assay database.

The database contains a total of 158,284 samples with recorded gold assays up to the cut-off date of September 2024. Of these, SLR cross checked 46,154 samples, representing 29% of the entire database. Data verification included 817 out of 2,456 drill holes.

There are reanalysis certificate results for 169 samples.

Three minor issues were likely related to decimal rounding within the database, with differences not exceeding 0.01 ppm Au, and are thus considered insignificant.

The SLR QP identified no discrepancies in gold values between the database and the assay certificates for the period from 2019 to 2024 and the database is considered consistent and robust, and it adheres to good practices in database management.

12.2.2.1 Conclusions and Recommendations

In the SLR QP's opinion, the data verification for the Mine identified no significant discrepancies. As a result, the assay and density data within the database are considered appropriate for use in a Mineral Resource estimate. The SLR QP recommends maintaining best industry practices to ensure consistency in the format and structure of the database.



13.0 Mineral Processing and Metallurgical Testing

Metallurgical testing for the San Andrés Mine has been conducted to characterize ore types and evaluate heap leach recovery potential. The testing program includes ore characterization, mineralogy, fire and chemical assaying, bottle roll leach testing, and column leach testing. These tests aim to determine the metallurgical variability of different ore zones and optimize heap leach operating parameters.

The samples tested are considered representative of the various styles of mineralization present at the deposit. Sampling has primarily focused on oxide and mixed oxide-sulphide material, which are amenable to heap leaching, as well as silicified and unoxidized sulphide material, which may require alternative processing methods. Test samples were collected from active mining areas across different pit zones, including Esperanza Alto, Esperanza Bajo, Banana Ridge, Buffa, and Falla A, and were selected to reflect variations in oxidation, silicification, and gold grade.

Metallurgical testing for the San Andrés Mine was conducted internally by Minosa at its on-site metallurgical laboratory located at the San Andrés Mine. The testwork was performed by Minosa personnel and included standard industry testing procedures. The laboratory follows internally established protocols that align with industry best practices; however, it is not an ISO-certified or third-party-accredited facility.

Testwork involved collecting and processing samples directly from selected pit locations, including blast holes and blasted material samples, as part of the mine's geometallurgical characterization efforts. The testing program assessed heap leach recovery performance under various conditions, with a particular focus on the impact of oxidation, silicification, and particle size distribution on gold recovery.

Results from the testwork are discussed in detail in Sections 10.1.1 and 10.2.1.

13.1 Metallurgical Testing 2023

13.1.1 Column Leach Testing of Materials by Zone

Column leach testing was performed on samples taken from the pit during operation. Dispatch software was used to track the location from which the sample was taken during mining. The data could then be used to build a geometallurgical model. Table 13-1 presents column leach test results for material mined from the Esperanza Alto zone. Bottle roll test recoveries are also included for comparison. Two tests were performed for each sample, one at P₈₀ 2" and the other at the specified P₈₀ to determine the effect of particle size on extraction. The results indicate that gold extraction is affected by degree of oxidation, degree of silicification, and particle size. The material requires crushing, and heap leaching is applicable for the oxide and mixed oxide/sulphide material. The silicified and sulphide materials will require alternate extraction methods including fine grinding and sulphide oxidation.

Table 13-1: Column Leach Testing of Esperanza Alto in 2023

Sample ID Code	SA-OC-23-1006	SA-OC-23-1007	SA-OC-23-1015	SA-OC-23-1017	SA-OC-23-1021	SA-OC-23-1025	SA-OC-23-1026	SA-OC-23-1029	SA-OC-23-1030
Test Number	MT-23-001	MT-23-002	MT-23-0003	MT-23-0007	MT-23-0009	MT-23-00011	MT-23-00012	MT-23-00014	MT-23-00015



Sample ID Code	SA-OC-23-1006	SA-OC-23-1007	SA-OC-23-1015	SA-OC-23-1017	SA-OC-23-1021	SA-OC-23-1025	SA-OC-23-1026	SA-OC-23-1029	SA-OC-23-1030
Zone	Esperanza Alto	Esperanza Alto	Esperanza Alto	Esperanza Alto	Esperanza Alto	Esperanza Alto	Esperanza Alto	Esperanza Alto	Esperanza Alto
Test Charge (kg)	196.03	200.99	222.47	221.02	242.22	234.42	227.29	233.43	238.62
P80 (in)	1.36	1.74	1.43	1.71	2.39	1.98	1.37	1.22	2.06
Head Au g/t (back calculated):	0.78	0.25	0.48	0.47	0.58	0.83	0.24	0.20	0.34
Tail Au g/t:	0.09	0.02	0.03	0.07	0.10	0.11	0.06	0.05	0.06
Gold Recovery % Column	88.56%	93.06%	93.69%	84.81%	82.64%	86.89%	76.77%	74.17%	82.55%
Gold Recovery % Column, P80 2 in.	81.25%	89.86%	86.77%	81.57%	86.09%	86.66%	70.53%	66.78%	82.55%
%Gold Recovery Bottle	80.46%	80.20%	85.95%	77.45%	82.14%	87.95%	81.90%	72.34%	84.46%
Cyanide Concentration (ppm)	400.00	400.00	400.00	400.00	400.00	400.00	400.00	400.00	400.00
Cyanide Consumption (g/t)	362.50	275.58	297.16	364.04	430.02	379.80	136.91	245.62	238.78
Cement (kg/t)	3.00	3.00	3.00	3.00	3.00	3.00	3.00	1.50	1.50
Lime (kg/t)	0.80	0.80	0.00	0.80	1.60	0.40	0.40	0.20	0.00
pH feed avg	10.64	10.64	10.84	10.83	11.05	10.96	11.12	10.86	10.96
pH PLS avg	11.87	11.92	11.79	11.07	11.65	11.57	11.72	11.70	11.86
Density, Real	1.87	1.97	2.31	1.97	2.02	2.17	2.09	2.17	2.26
Density, Apparent	1.19	1.30	1.37	1.19	1.27	1.47	1.44	1.43	1.25
Density, Solids	2.14	2.38	2.24	2.26	2.37	2.50	2.48	2.35	2.50
Notes: PLS Pregnant Leach Solution									



Figure 10-1 presents the column leach test results for the Esperanza Alto samples.

Figure 13-1: Esperanza Alto Gold Recovery versus Particle Size

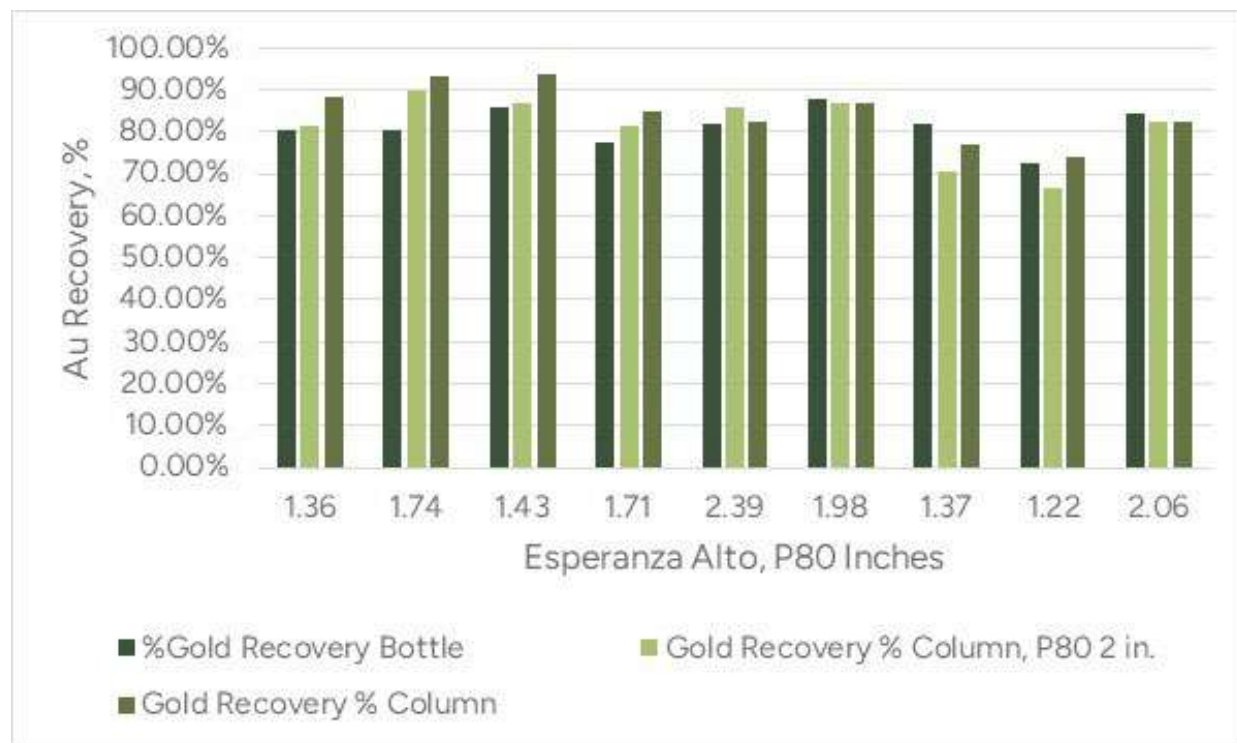


Table 13-2 and Figure 10-2 presents the relationship between particle size and gold recovery for Banana Ridge samples.

Figure 13-2 present the results of column leach tests of Banana Ridge samples.

Table 13-2: Column Leach Testing of Banana Ridge in 2023

Sample ID Code	SA-OC-23-1016	SA-OC-23-1016
Test Number	MT-23-0006	MT-23-0004
Zone	Banana Ridge	Banana Ridge
Test Charge (kg)	232.53	228.00
P80 (in)	1.17	2.13
Head Au (g/t) (back calculated):	0.16	0.56
Tail Au (g/t)	0.06	0.12
Gold Recovery % Column	60.07%	79.32%
Gold Recovery % Column, P80 2 in.	53.72%	80.72%
%Gold Recovery Bottle	51.29%	80.18%
Cyanide Concentration (ppm)	400.00	400.00
Cyanide Consumption (g/t)	526.64	490.94



Sample ID Code	SA-OC-23-1016	SA-OC-23-1016
Cement (kg/t)	3.00	3.00
Lime (kg/t)	3.00	2.00
pH feed avg	11.03	11.13
pH PLS avg	9.85	11.80
Density, Real	1.89	1.96
Density, Apparent	1.15	1.47
Density, Solids	2.09	2.42
Notes: PLS Pregnant Leach Solution		

Figure 10-2 presents the relationship between particle size and gold recovery for Banana Ridge samples.

Figure 13-2: Banana Ridge Gold Recovery versus Particle Size

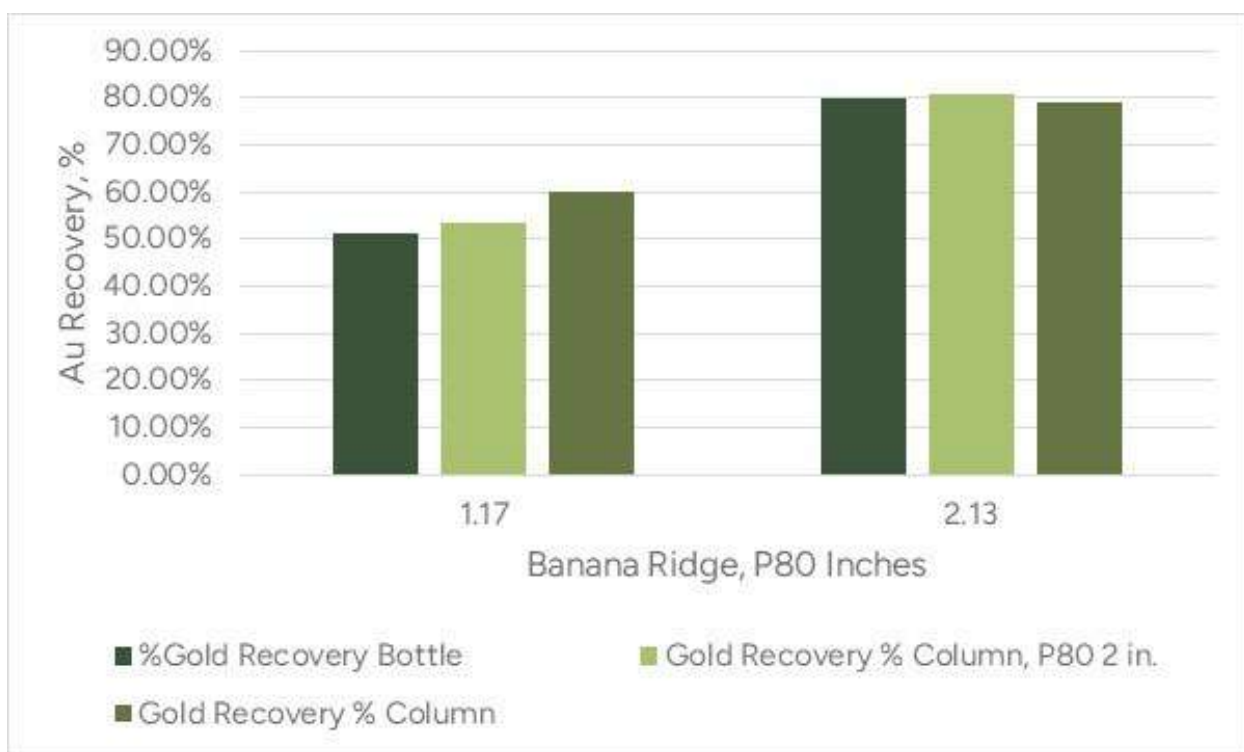


Table 13-3 and Figure 13-3 present the results of column leach tests of Esperanza Bajo samples.

Table 13-3: Column Leach Testing of Esperanza Bajo in 2023

Sample ID Code	SA-OC-23-1017	SA-OC-23-1024
Test Number	MT-23-0005	MT-23-00010
Zone	Esperanza Bajo	Esperanza Bajo



Sample ID Code	SA-OC-23-1017	SA-OC-23-1024
Test Charge (kg)	237.98	236.15
P80 (in)	1.96	1.99
Head Au (g/t) (back calculated):	0.83	0.97
Tail Au (g/t)	0.38	0.57
Gold Recovery % Column	53.68%	40.99%
Gold Recovery % Column, P80 2 in.	53.39%	40.99%
%Gold Recovery Bottle	66.84%	52.65%
Cyanide Concentration (ppm)	400.00	400.00
Cyanide Consumption (g/t)	413.11	364.56
Cement (kg/t)	3.00	3.00
Lime (kg/t)	0.00	0.80
pH feed avg	11.12	10.95
pH PLS avg	11.49	11.01
Density, Real	2.27	2.41
Density, Apparent	1.53	1.31
Density, Solids	2.55	2.53

Figure 13-3: Esperanza Bajo Gold Recovery versus Particle Size

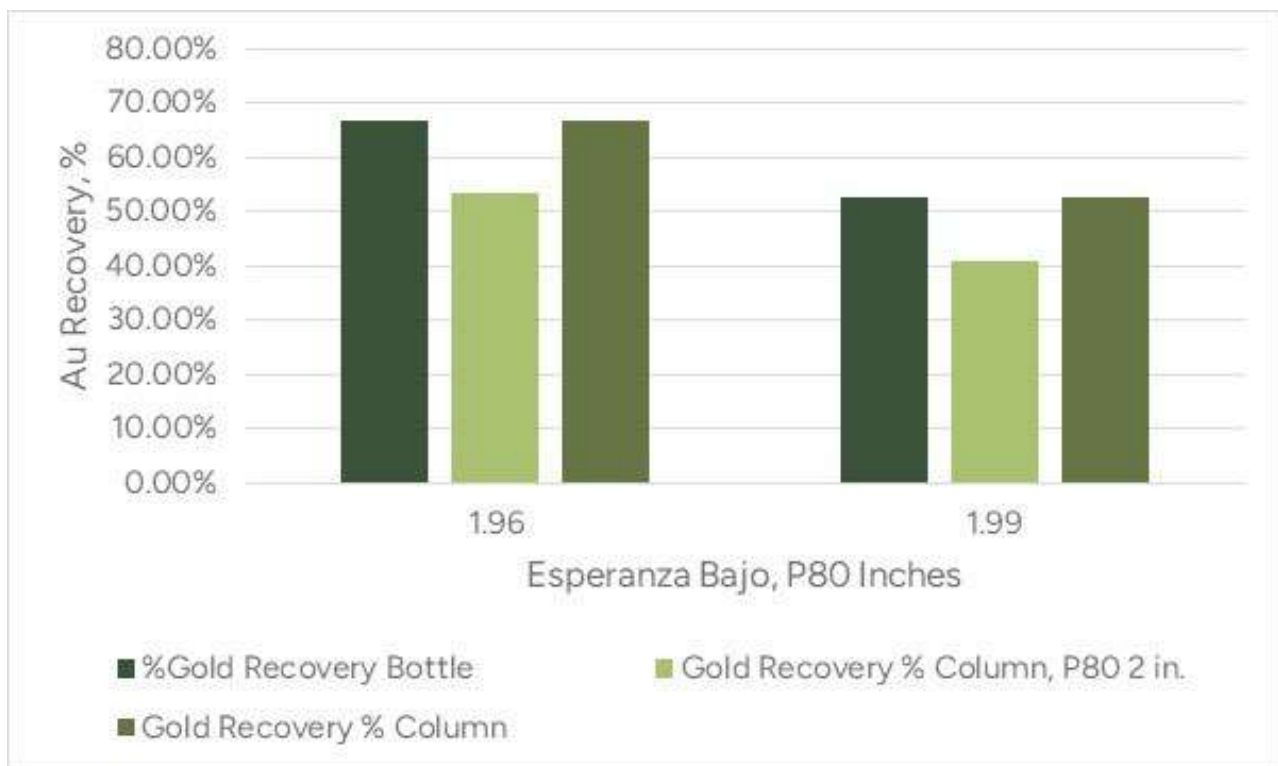


Table 13-4 and Figure 13-4 present the results of column leach tests of Falla A samples.

Table 13-4: Column Leach Testing of Falla A in 2023

Sample ID Code	SA-OC-23-1020
Test Number	MT-23-0008
Zone	Falla A
Test Charge (kg)	233.14
P80 (in)	2.36
Head Au (g/t) (back calculated):	0.77
Tail Au (g/t)	0.24
Gold Recovery % Column	68.56%
Gold Recovery % Column, P80 2 in.	71.96%
%Gold Recovery Bottle	71.80%
Cyanide Concentration (ppm)	400.00
Cyanide Consumption (g/t)	599.67
Cement (kg/t)	3.00
Lime (kg/t)	1.60
pH feed avg	11.04
pH PLS avg	10.63
Density, Real	2.03
Density, Apparent	1.12
Density, Solids	2.17



Figure 13-4: Falla A Gold Recovery versus Particle Size

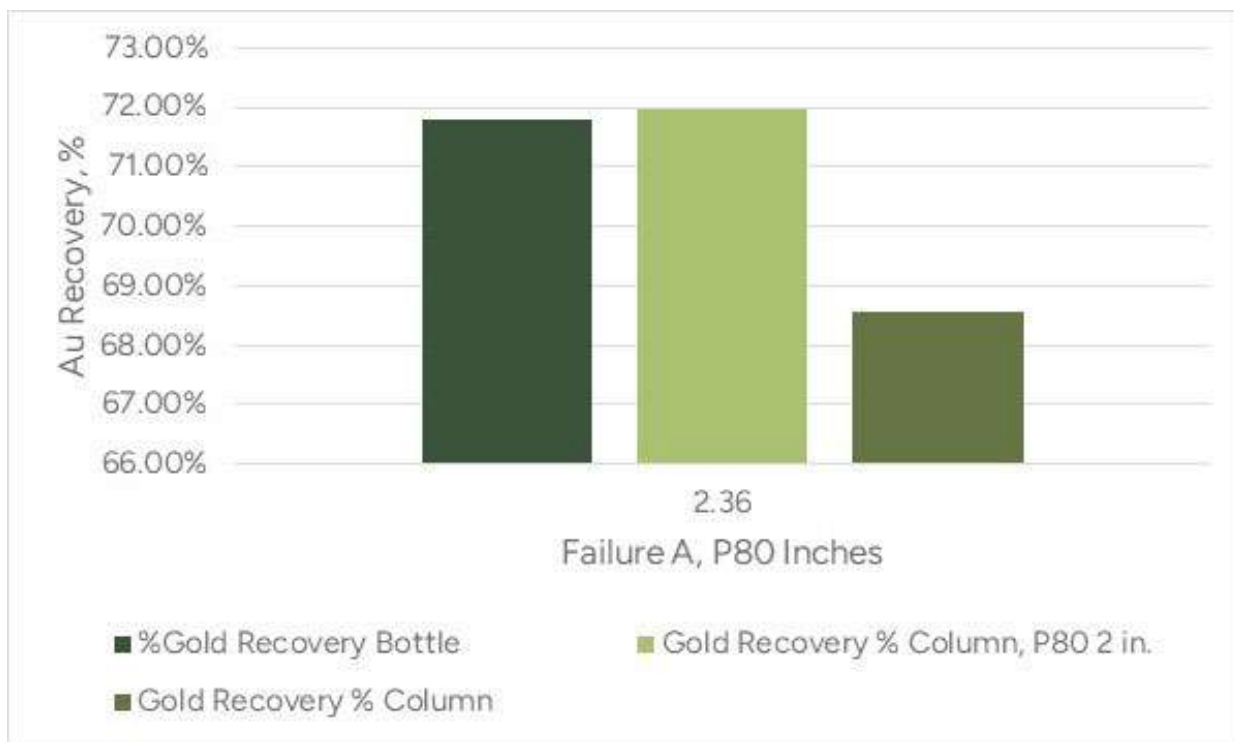


Table 13-5 and Figure 13-5 present the results of column leach tests of composite samples.

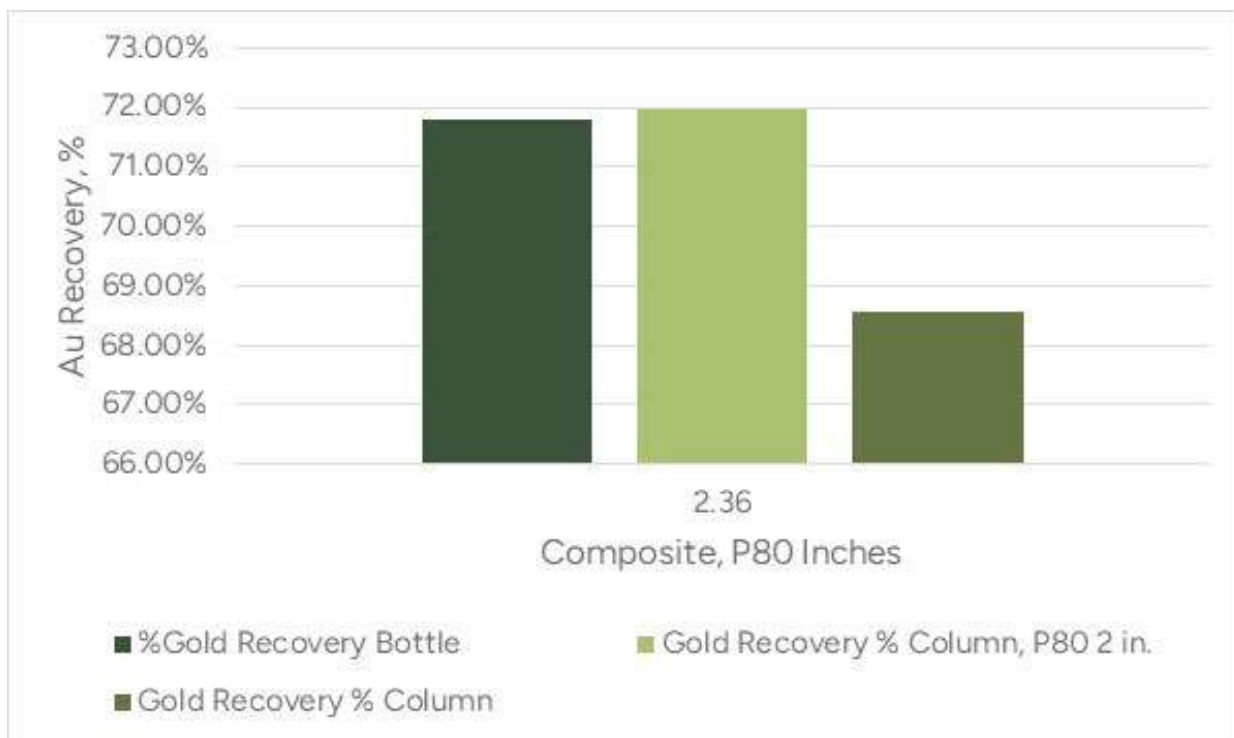
Table 13-5: Column Leach Testing of Composite in 2023

Sample ID Code	SA-OC-23-1028
Test Number	MT-23-00013
Zone	Composite
Test Charge (kg)	233.50
P80 (in)	1.72
Head Au (g/t) (back calculated):	0.58
Tail Au (g/t)	0.18
Gold Recovery % Column	69.55%
Gold Recovery % Column, P80 2 in.	65.18%
%Gold Recovery Bottle	
Cyanide Concentration (ppm)	400.00
Cyanide Consumption (g/t)	334.62
Cement (kg/t)	1.50
Lime (kg/t)	0.00
pH feed avg	10.98



Sample ID Code	SA-OC-23-1028
pH PLS avg	11.00
Density, Real	2.28
Density, Apparent	1.12
Density, Solids	2.53

Figure 13-5: Composite Gold Recovery



13.2 Metallurgical Testing 2024

The testing program performed in 2023 was continued in 2024 with an emphasis on sampling and column leach testing to support the development of a geometallurgical model. Column leach testing was performed on samples taken from the pit during operation. Dispatch software was used to track the truck load and location from which the sample was taken during mining.

13.2.1 Column Leach Testing of Materials by Zone

Table 13-6 presents column leach test results for material mined from the Esperanza Alto, Buffa, and Esperanza Bajo zones. Bottle roll test recoveries are also included for comparison. Two tests were performed for each sample, one at P₈₀ 2" and the other at the specified P₈₀ to determine the effect of particle size on extraction.

The results indicate that gold extraction is affected by degree of oxidation, degree of silicification and particle size. The material requires crushing, and heap leaching is applicable for the oxide and oxide/sulphide material. The silicified and unoxidized materials will require alternate extraction methods including fine grinding and sulphide oxidation.



The samples tested represent various levels of oxidation and silicification. The samples with high recoveries are oxidized, and the samples with low recoveries are unoxidized (fresh), silicified, or both. Notable examples of this are listed:

- Sample MT-24-0010 is a sample of Esperanza Bajo described as a quartz matrix with sulphide minerals. The material is crushed to P_{80} 1.67 in. and the resulting heap leach gold recovery is 14.6%.
- Sample MT-24-0011 is a sample of Esperanza Bajo described as mixed ore with oxidation in the veins and containing both oxidized and unoxidized sulphide minerals, primarily pyrite. The material is crushed to P_{80} 1.67 in. and the resulting heap leach gold recovery is 86.9%.
- Sample MT-24-0012 is a sample of Esperanza Bajo described as silicified material with sulphides. The material is crushed to P_{80} 1.76 in. and the resulting heap leach gold recovery is 49.6%.
- Sample MT-24-0013 is a sample of Esperanza Bajo described fragmented quartz with strong silicification plus sulphide minerals. The material is crushed to P_{80} 1.8 in. and the resulting heap leach gold recovery is 24.1%.



Table 13-6: Column Leach Test Results by Zone

Sample ID Code	SA-OC-24-1001	SA-OC-24-1002	SA-OC-24-1003	SA-OC-24-1004	SA-OC-24-1006	SA-OC-24-1007	SA-OC-24-1008	SA-OC-24-1009	SA-OC-24-1010	SA-OC-24-1011	SA-OC-24-1012	SA-OC-24-1013	SA-OC-24-1014
Test Number	MT-24-0001	MT-24-0002	MT-24-0003	MT-24-0004	MT-24-0006	MT-24-0007	MT-24-0008	MT-24-0009	MT-24-0010	MT-24-0011	MT-24-0012	MT-24-0013	MT-24-0014
Zone	Esperanza Alto	Buffa	Buffa	Buffa	Esperanza Bajo	Esperanza Alto	Esperanza Bajo	Esperanza Alto	Esperanza Bajo	Esperanza Bajo	Esperanza Bajo	Esperanza Bajo	Esperanza Bajo
Test Charge (kg)	190.37	196.02	194.56	195.62	198.33	176.33	173.47	192.49	145.54	176.70	214.42	180.33	194.81
P80 (in)	1.00	1.23	1.85	1.75	1.98	1.80	1.72	1.70	1.67	1.67	1.76	1.80	1.70
Head Au (g/t) (back calculated):	0.22	1.85	2.54	0.57	0.32	0.24	0.91	0.25	1.05	0.94	1.17	1.29	1.79
Tail Au (g/t)	0.04	0.45	0.49	0.44	0.18	0.04	0.37	0.04	0.89	0.12	0.57	0.99	0.37
Gold Recovery % Column	83.06%	75.64%	80.90%	22.75%	42.82%	84.25%	59.58%	84.55%	14.60%	86.90%	51.12%	24.14%	79.33%
Gold Recovery % Column, P80 2 in.	72.61%	68.20%	79.28%	22.00%	42.70%	82.01%	57.38%	81.20%	13.97%	83.13%	49.50%	23.50%	76.20%
%Gold Recovery Bottle	80.41%	87.25%	91.24%	44.50%	41.63%	85.45%	59.98%	86.72%	15.59%	87.62%	64.78%	31.21%	79.25%
Cyanide Concentration (ppm)	400.00	400.00	400.00	400.00	400.00	400.00	400.00	400.00	400.00	400.00	400.00	400.00	400.00
Cyanide Consumption (g/t)	291.91	1179.98	1019.49	391.42	264.99	264.65	480.48	193.53	407.59	372.78	630.55	476.31	598.55
Cement (kg/t)	3.00	3.00	3.00	3.00	3.00	3.00	3.00	3.00	3.00	3.00	3.00	3.00	2.00
Lime (kg/t)	19.00	0.80	3.20	2.60	1.40	0.40	0.00	0.40	3.80	0.40	2.40	12.00	1.25
pH feed avg	11.32	11.30	11.22	11.24	11.06	11.14	11.12	11.02	11.09	11.08	11.10	11.01	11.11
pH PLS avg	12.24	10.80	11.29	11.65	11.81	11.61	10.96	11.34	11.21	11.35	10.71	11.60	11.53
Density, Real	1.92	2.05	2.28	2.09	2.23	2.28	2.31	2.08	2.19	2.24	2.26	2.28	2.24
Density, Apparent	1.24	1.31	1.33	1.29	1.54	1.42	1.46	1.54	1.45	1.49	1.52	1.48	1.50
Density, Solids	2.22	2.39	2.31	2.33	2.40	2.49	2.48	2.47	2.51	2.42	2.48	2.37	2.50



Figure 13-6 illustrates the relationship between gold head grade, particle size distribution and gold recovery by zone. The samples within each zone vary in material type and degree of oxidation and silicification. Gold recovery is affected by particle size distribution as can be seen by the difference in recovery of the individual samples. When observing the complete set of samples, particle size is a factor though the main factors are degree of oxidation and silicification.

Figure 13-6: Gold Head Grade and Particle Size vs Recovery

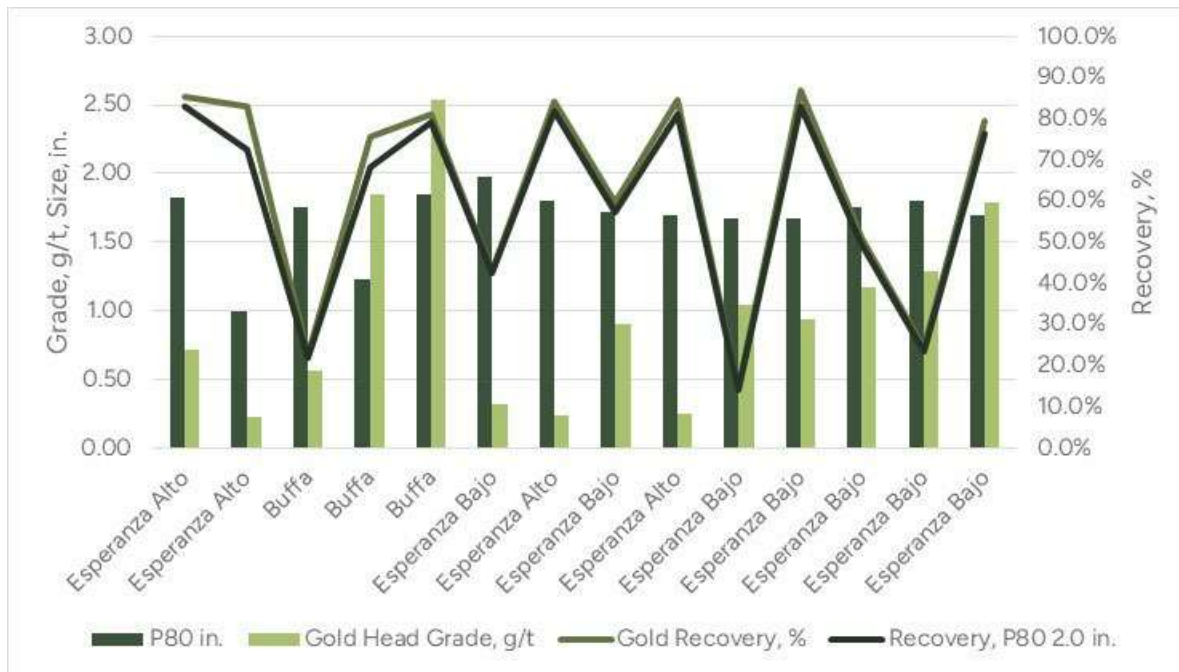
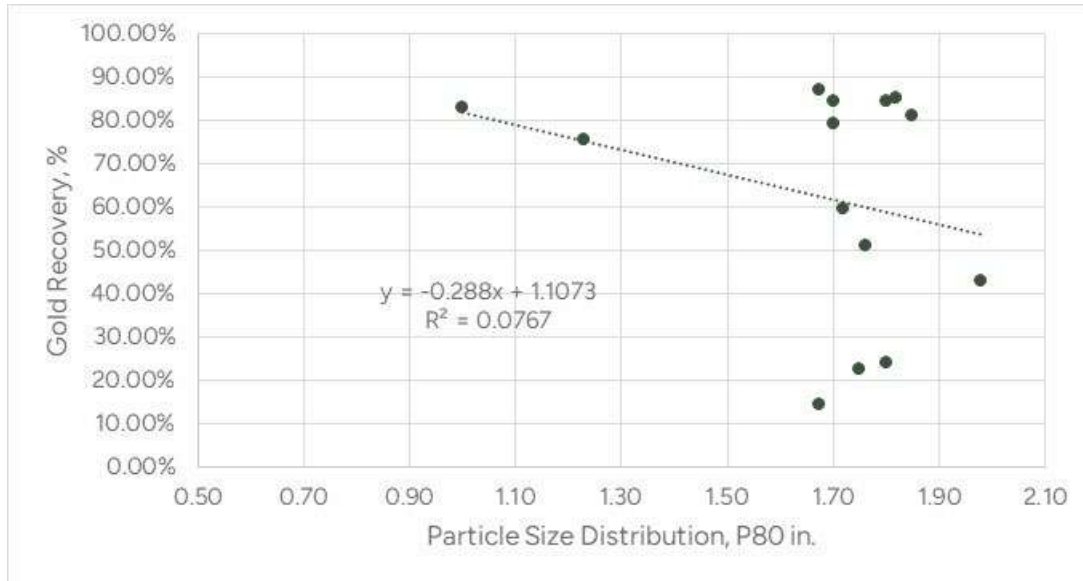


Figure 13-7 presents the relationship between particle size and gold recovery. Gold is affected by particle size distribution, however, the correlation in this data set is low, due to the variance in material types and degrees of oxidation and silicification.



Figure 13-7: Particle Size versus Gold Recovery



13.2.2 Deleterious Elements

The only deleterious element identified with respect to heap leaching is mercury. Mercury is extracted and collected as a liquid using retort distillation during the electrowinning sludge drying stage in the gold refinery.

13.2.3 SLR QP Opinion

It is the SLR QP’s opinion that the quantity and quality of the samples used for the metallurgical testing supporting the heap leach operation and defining the various ore types in the deposit is adequate for the purposes of this technical report. Aura is in the process of developing a geometallurgical model which requires selecting and characterizing, including bottle roll and column leach testing, representative samples of the each of the ore types to be mined along with their locations in the pit. This is being done during operations and will continue as benches are developed.



14.0 Mineral Resource Estimates

14.1 Summary

The Mineral Resource estimate for the San Andres deposit was prepared by the Minosa team and supervised and accepted by the SLR QP. The cut-off date of the Minosa drill hole database is September 18, 2024. The effective date of the Mineral Resources is December 31, 2024.

In the SLR QP’s opinion, Mineral Resource estimates have been prepared utilizing acceptable estimation methodologies. Ordinary kriging (OK) was used to estimate gold and density. The block model used blocks measuring 10 m x 10 m x 6 m. The updated estimate includes new 2023 and 2024 drilling (309 drill holes with 23,721 m). The drill hole database contains 2,494 drill holes consisting of 245,035 m. The drillhole data was composited to 1.5 m.

Minosa’s geological team updated the geological model, focusing on the oxide, mixed and sulphide mineralization. Sulphide mineralization is excluded from the Mineral Resources. The Mineral Resources are also constrained by a 50 m exclusion zone along the Agua Caliente River. Resource estimation used Leapfrog Geo and Leapfrog Edge software for interpretation, statistics, geostatistics and block model estimation. Leapfrog Edge, Vulcan, and Supervisor were used for validation.

Canadian Institute of Mining, Metallurgy and Petroleum (CIM) Definition Standards for Mineral Resources and Mineral Reserves (CIM (2014) definitions) were used for Mineral Resource classification. Mineral Resources have been classified in accordance with the CIM (2014) definitions using a combination of drill hole spacing and distance to recent mining areas for resource classification.

Inclusive of Mineral Reserves, the San Andrés Mineral Resources are estimated to be 11.5 million tonnes (Mt) of Measured Mineral Resources at 0.38 g/t Au containing 140 thousand ounces (koz), 47.5 Mt of Indicated Mineral Resources at 0.45 g/t Au containing 681 koz, and 8.55 Mt of Inferred Mineral Resources at 0.45 g/t Au containing 123 koz, using a long term US\$2,200 gold price reported at a cut-off grade of 0.187 g/t Au for oxide material and 0.291 g/t Au for mixed material. The effective date of the Mineral Resource estimate is December 31, 2024.

Exclusive of Mineral Reserves, the San Andrés Mineral Resources are estimated to be 1.46 million tonnes (Mt) of Measured Mineral Resources at 0.34 g/t Au containing 16 koz, 24.22 Mt of Indicated Mineral Resources at 0.40 g/t Au containing 310 koz, and 8.55 Mt of Inferred Mineral Resources at 0.45 g/t Au containing 123 koz.

Table 14-1 summarizes the San Andrés Mine Mineral Resource estimate, inclusive of Mineral Reserves, as of December 31, 2024.

Table 14-1: Summary of Mineral Resource Estimate, Inclusive of Mineral Reserves – December 31, 2024

Category	Oxide			Mixed			Total		
	Tonnage (000 t)	Au (g/t)	Contained Gold (000 oz)	Tonnage (000 t)	Au (g/t)	Contained Gold (000 oz)	Tonnage (000 t)	Au (g/t)	Contained Gold (000 oz)
Measured	10,402	0.36	119	1,115	0.60	22	11,516	0.38	140



Category	Oxide			Mixed			Total		
	Tonnage (000 t)	Au (g/t)	Contained Gold (000 oz)	Tonnage (000 t)	Au (g/t)	Contained Gold (000 oz)	Tonnage (000 t)	Au (g/t)	Contained Gold (000 oz)
Indicated	42,459	0.43	580	5,074	0.62	100	47,533	0.45	681
Measured + Indicated	52,861	0.41	699	6,189	0.61	122	59,049	0.43	821
Inferred	6,921	0.42	94	1,629	0.56	29	8,550	0.45	123

Notes:

1. Mineral Resources are reported inclusive of Mineral Reserves.
2. CIM (2014) definitions were followed for Mineral Resources.
3. The Mineral Resource estimate is reported on a 100% ownership basis.
4. Mineral Resources are contained within a pit shell and are estimated in situ.
5. Mining dilution, mining losses, or process losses were not applied in estimating Mineral Resources.
6. Mineral Resources are estimated at a cut-off grade of 0.187 g/t Au Oxide and 0.291 g/t Au Mixed.
7. Metallurgical recovery is 70% for oxide material and 45% for mixed material.
8. Mineral Resources are estimated using a long-term gold price of US\$2,200 per ounce.
9. A minimum mining width of 6 m was used.
10. Bulk density is estimated by lithology and averages 2.38 g/cm³.
11. Mineral Resources that are not Mineral Reserves do not have demonstrated economic viability.
12. Numbers may not add due to rounding.

Table 14-2 summarizes the San Andrés Mine Mineral Resource estimate, exclusive of Mineral Reserves, as of December 31, 2024.

Table 14-2: Summary of Mineral Resource Estimate, Exclusive of Mineral Resources – December 31, 2024

Category	Oxide			Mixed			Total		
	Tonnage (000 t)	Au (g/t)	Contained Gold (000 oz)	Tonnage (000 t)	Au (g/t)	Contained Gold (000 oz)	Tonnage (000 t)	Au (g/t)	Contained Gold (000 oz)
Measured	1,070	0.27	9	387	0.54	7	1,457	0.34	16
Indicated	21,136	0.38	256	3,082	0.55	54	24,218	0.40	310
Measured + indicated	22,206	0.37	265	3,469	0.54	61	25,675	0.40	326
Inferred	6,921	0.42	94	1,629	0.56	29	8,550	0.45	123

Notes:

1. Mineral Resources are reported exclusive of Mineral Reserves.
2. See Notes 2 through 12 of Table 1-1.

The QP is not aware of any environmental, permitting, legal, title, taxation, socio-economic, marketing, political, or other relevant factors that could materially affect the Mineral Resource estimate.



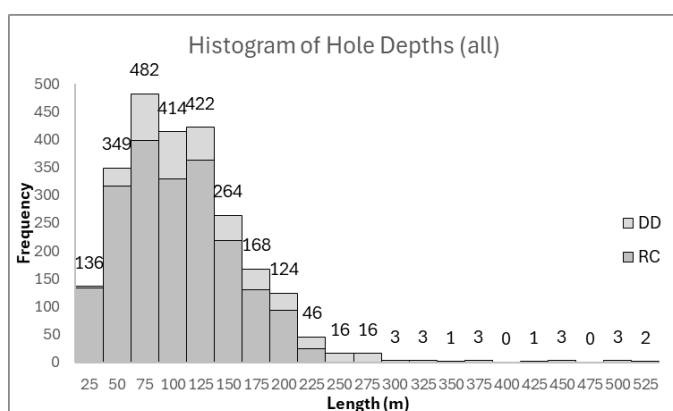
14.2 Resource Database

14.2.1 Collar Surveys

The resource model is based on data available up to September 18, 2024. This includes 2,456 drill holes totalling 240,109 m. Sixteen historical drill holes from 1996 to 1998, with no assays, and 22 RC holes (MC-24-04 to MC-24-19) totalling 1,564 m and 16 DD holes (MO-24-137 to MO-24-158) totalling 2,553 m, from 2024, with no assays, are excluded from the estimation.

Drill hole spacing varies across the deposit. In the oxide and mixed mineralization, the drill hole spacing is in the range of 25 m to 50 m, increasing in sulphide mineralization. A histogram of drill hole depth is presented in Figure 14-1.

Figure 14-1: Depth Histogram



Meters	DD		RC	
	#	Meters	#	Meters
[0-100]	203	13,851	1178	67,384
]100-150]	105	12,888	581	71,119
]150-200]	68	11,842	224	38,054
]200-300]	56	13,165	25	5,221
]300-400]	7	2,345		
]400-500]	7	3,204		
]500-550]	2	1,037		

14.2.2 Survey

Downhole surveys have only been conducted (largely by Minosa) for a small percentage of drill holes. Only 277 holes (approximately 10%) in the combined provided databases contain more than one downhole survey measurement per hole. The potential impacts of drill hole deviation are more significant as holes increase in depth over 150 m or 200 m. Uncertainty regarding sample locations is expected to increase downhole in the deeper drill holes. Approximately 15% of the drill holes are over 150 m length and for these holes only 103 drill holes have over one downhole survey measurement.

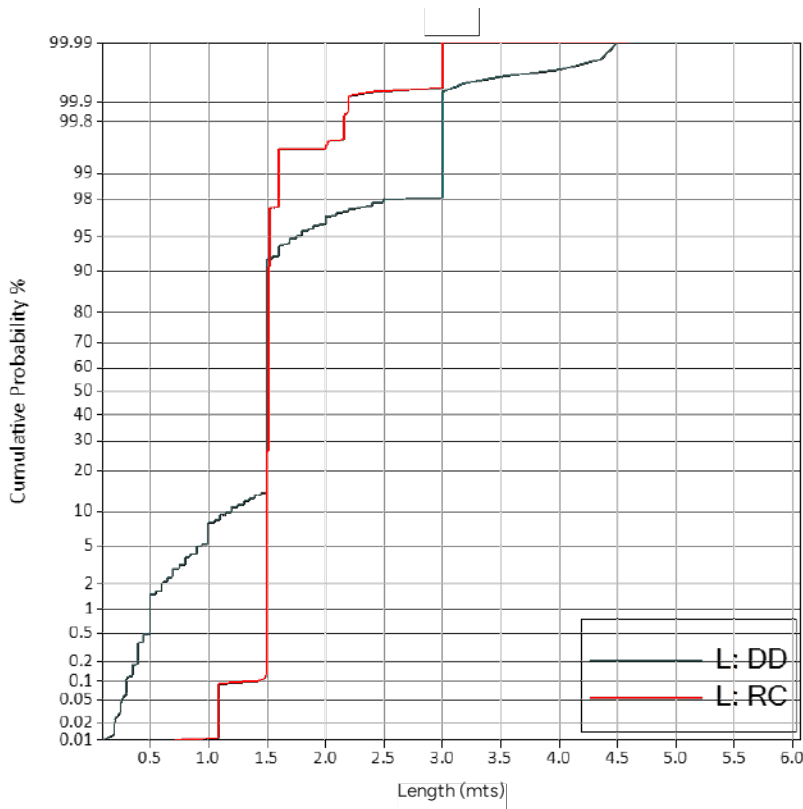
Based on the drill hole lengths, 85% of which are less than 150 m in depth, the SLR QP is of the opinion that the lack of downhole surveys will have no material impact globally on the geological model and Mineral Resource estimation.

14.2.3 Resources Assays

Assay sample intervals ranged from 0.1 m to 6 m. The normal sample length for RC drilling is in the range of 1.49 m to 1.53 m, accounting for 97% of the RC data, and 1.5 m in DD drilling, accounting for 79% of the DD data. For grade estimation, a small percentage (1.3%) of unsampled intervals from historical drill holes were ignored. After statistical and visual analysis, the SLR QP determined this to be a minor procedural issue with no significant impact on the global resource estimate, however, the SLR QP recommends that the explicit unsampled data should be treated as zero grades. The cumulative distribution plot shows sample length distribution (Figure 14-2).



Figure 14-2: Sample Length Cumulative Distribution Plot by Drill Hole Type



14.3 Geological Interpretation

The Minosa geology department has developed a very good understanding of the San Andrés geology. Geological models were constructed to provide geologic control for grade estimation and to provide parameters for mine planning. Geology models for lithology, alteration, oxidation domain, mineralization, and structural sub-zones were built using Leapfrog software. The wireframes built for the main geological, lithological, alteration, and grade domains are listed in Table 14-3 to Table 14-7, respectively. These wireframes were used in the estimation to assign codes to the block model. The wireframes are illustrated in Figure 14-3 through Figure 14-9.

Oxidation is a primary determinant of the mineralization at Minosa categorized into Oxide, Transitional (Mixed), and Sulphide material based on drill logging and spatial data. The cyanide-soluble gold (CNAu)/Fire Assay gold (Au) ratio was used for validation, with ratios of >0.5 for Oxide, >0.45 for Mixed, the 0.45-0.25 range, depending on logging, is classified as mixed, and <0.25 for Sulphide zones. The Mine uses a sulphide validation model based on a 0.25 ratio, which has performed relatively well.

Oxide zones are located in the upper mine and contain minerals such as hematite, goethite, limonite, and jarosite while deeper sulphide zones contain pyrite, sphalerite, stibine, etc. Mixed zones occur between these layers, with complex and variable boundaries.

The SLR QP reviewed the oxidation and mixed domains and overall found them acceptable with CNAu/Au ratios in most of the Resource and Reserve pits areas. The SLR QP recommends



continuing refining the oxide and mixed model and using the CNAu/Au ratio as the primary criterion for defining oxidation boundaries.

Table 14-3: Lithological Domain Wireframes

Code	Lithology	Triangulation
2	Brecha/ Conglomerate	OLD_GM_Litho_PCGL.dxf
3	Rhyolite	OLD_GM_Litho_RHYT.dxf
4	Andesite	OLD_GM_Litho_ANT.dxf
5	Red bed	OLD_GM_Litho_RBE.dxf
6	Phyllite	OLD_GM_Litho_PHL.dxf
99	Botadero	OLD_GM_Litho_99.Botadero.dxf



Figure 14-3: Lithology, Level 1000

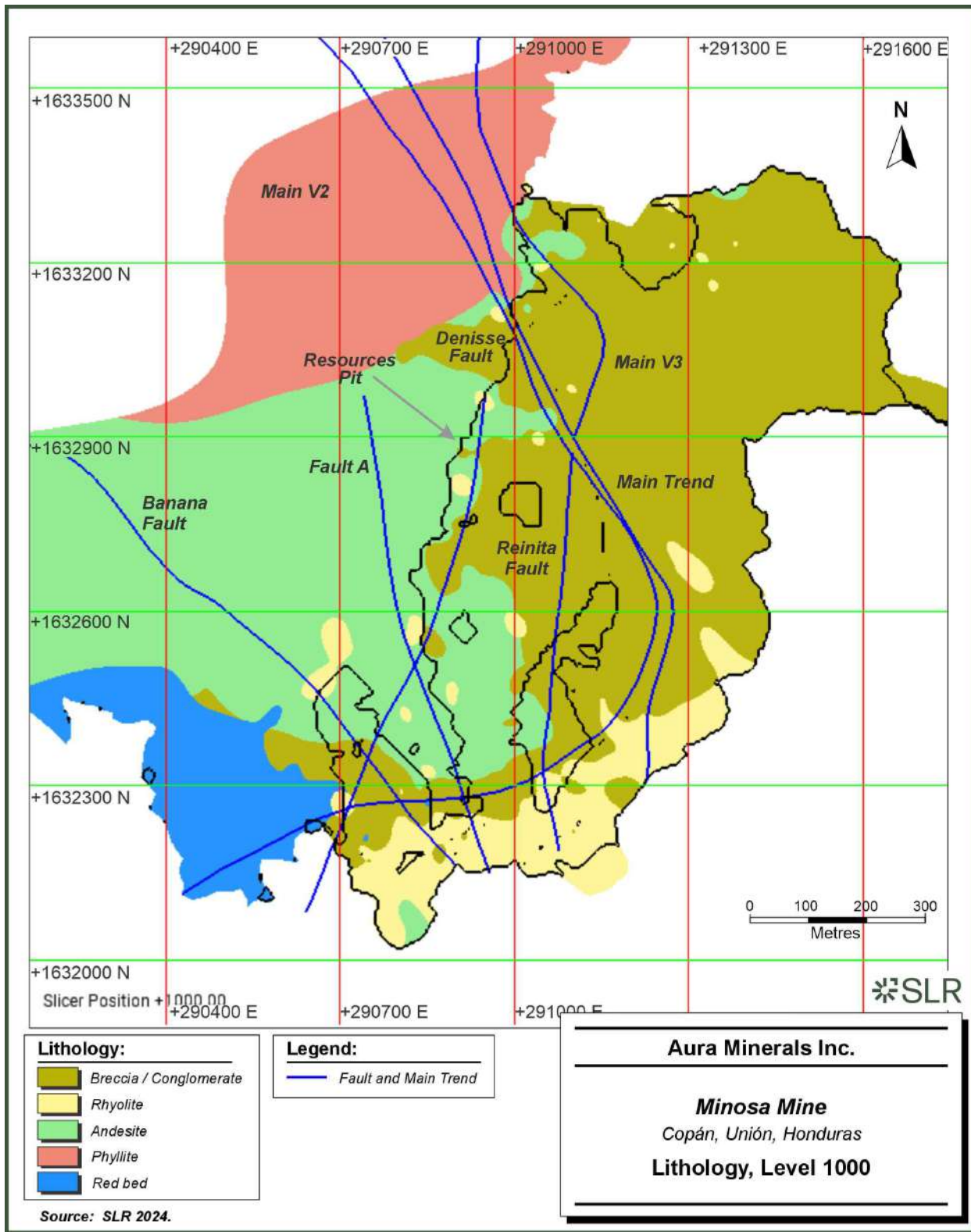


Table 14-4: Alteration Wireframes

Code	Alteration	Triangulation
1	Argillic	GM_Hydrothermal_Alteration_GM_Hydrothermal_Alteration_1.dxf
2	Argillic/Silicic	GM_Hydrothermal_Alteration_GM_Hydrothermal_Alteration_2.dxf
3	Silicic/Argillic	GM_Hydrothermal_Alteration_GM_Hydrothermal_Alteration_3.dxf
4	Silicic	GM_Hydrothermal_Alteration_GM_Hydrothermal_Alteration_4.dxf



Figure 14-4: Alteration, Level 1000

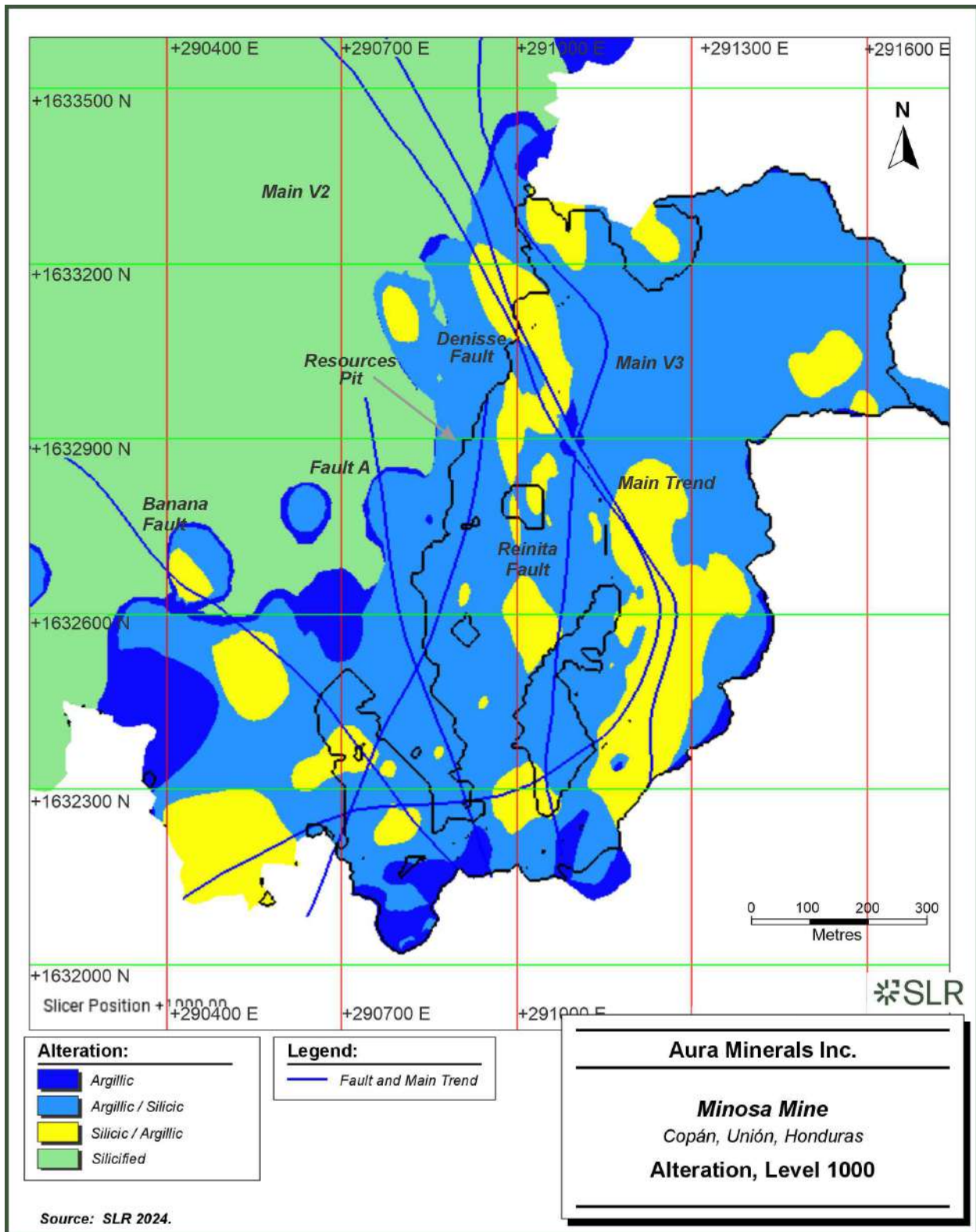


Table 14-5: Oxidation Wireframes

Code	Mineralization	Wireframe
1	Oxide	GM_Miner_Oxi.dxf
2	Mixed	GM_Miner_Mix.dxf
3	Sulphide	GM_Miner_Sulf.dxf



Figure 14-5: Oxidation Domains, Level 1000

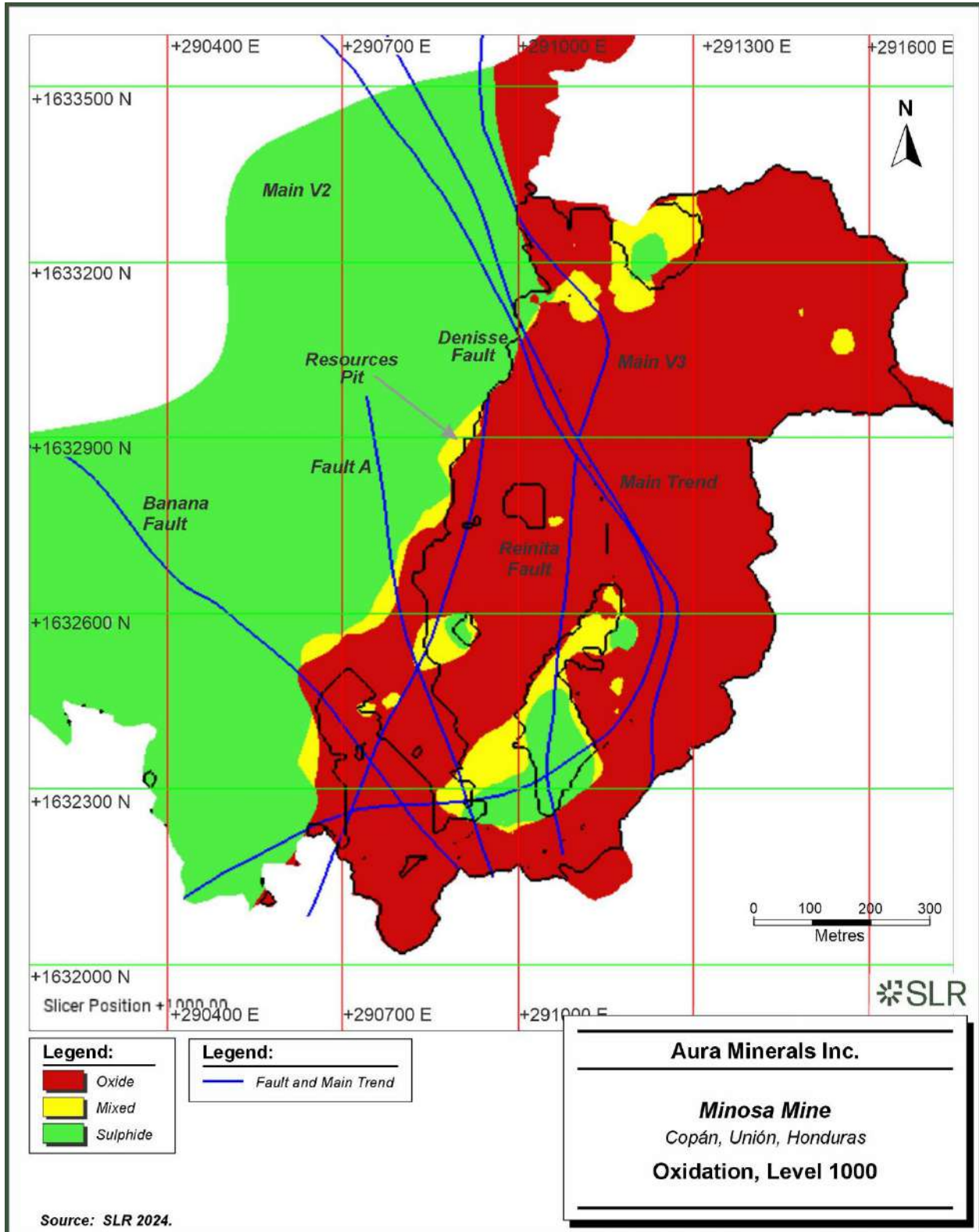


Table 14-6: Grade Domain Wireframes (Au > 0.15 g/t)

Code	Ore Au > 0.15 g/t	Triangulation
1	Ore	GM_Grade_Domains_0.15_AZACUALPA.00t
1	Ore	GM_Grade_Domains_0.15_BANANA_RIDGE.00t
1	Ore	GM_Grade_Domains_0.15_ESP_ALTO.00t
1	Ore	GM_Grade_Domains_0.15_ESP_BAJO.00t
1	Ore	GM_Grade_Domains_0.15_ESP_ELCC.00t
1	Ore	GM_Grade_Domains_0.15_ESP_WTH.00t
1	Ore	GM_Grade_Domains_0.15_ZONA_BUFFA.00t
0	WST (Waste)	



Figure 14-6: Grade Domains (Au > 0.15 g/t), Level 1000

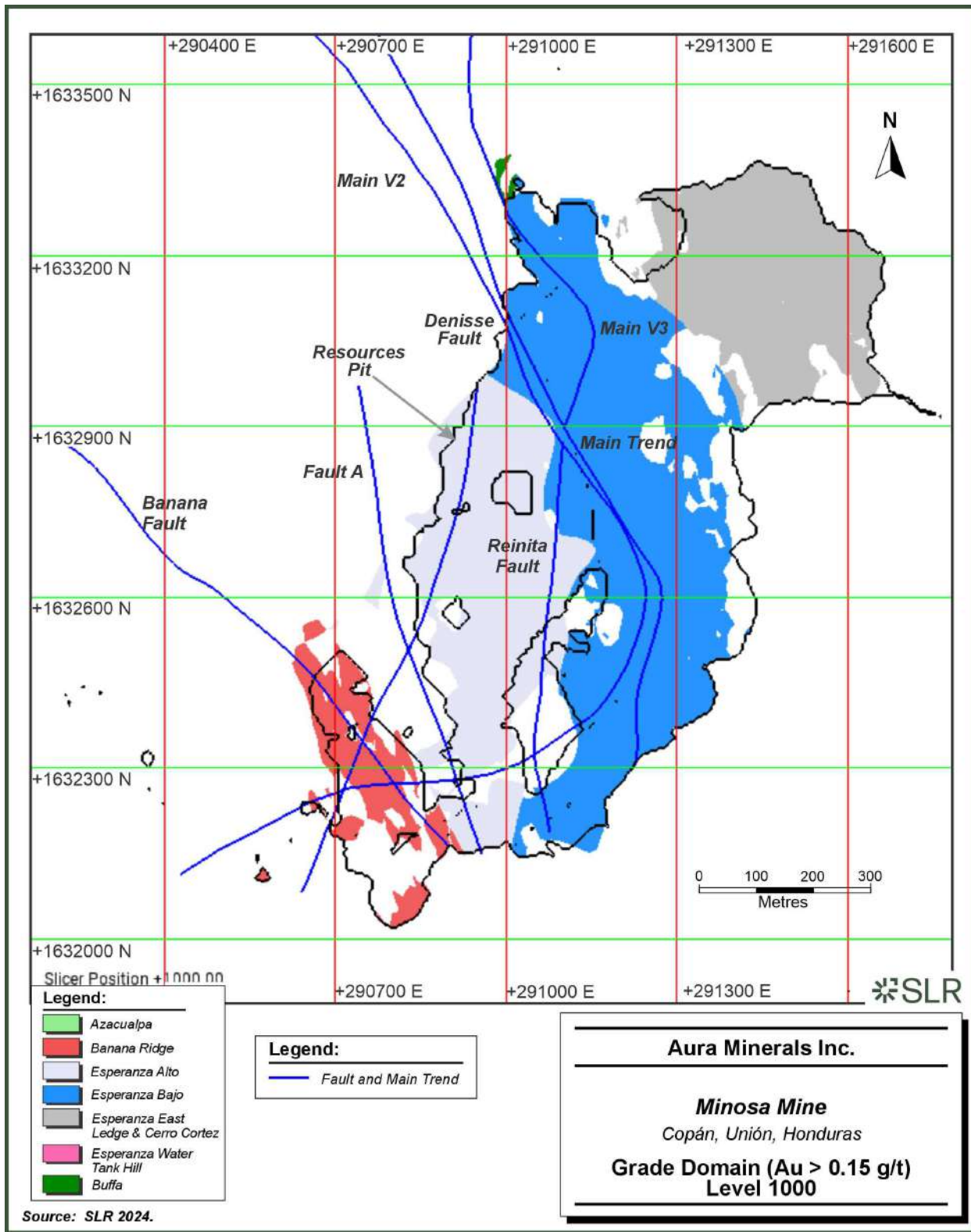


Table 14-7: Geological Structural Sub-Zone Wireframes

Code	Structural Sub-Zones	Triangulation
1	Esperanza Alto (ESP_ALTO)	GM_Great_Domains_ESP_ALTO.dxf
2	Esperanza Bajo (ESP_BAJO)	GM_Great_Domains_ESP_BAJO.dxf
3	Esperanza East Ledge & Cerro Cortez (ESP_ELCC)	GM_Great_Domains_ESP_ELCC.dxf
4	Esperanza Water Tank Hill (ESP_WTH)	GM_Great_Domains_ESP_WTH.dxf
5	Banana Ridge	GM_Great_Domains_BANANA_RIDGE.dxf
6	Azacualpa	GM_Great_Domains_AZACUALPA.dxf
7	Buffa	GM_Great_Domains_ZONA_BUFFA.dxf



Figure 14-7: Structural Sub-Zone Domains, Level 1000

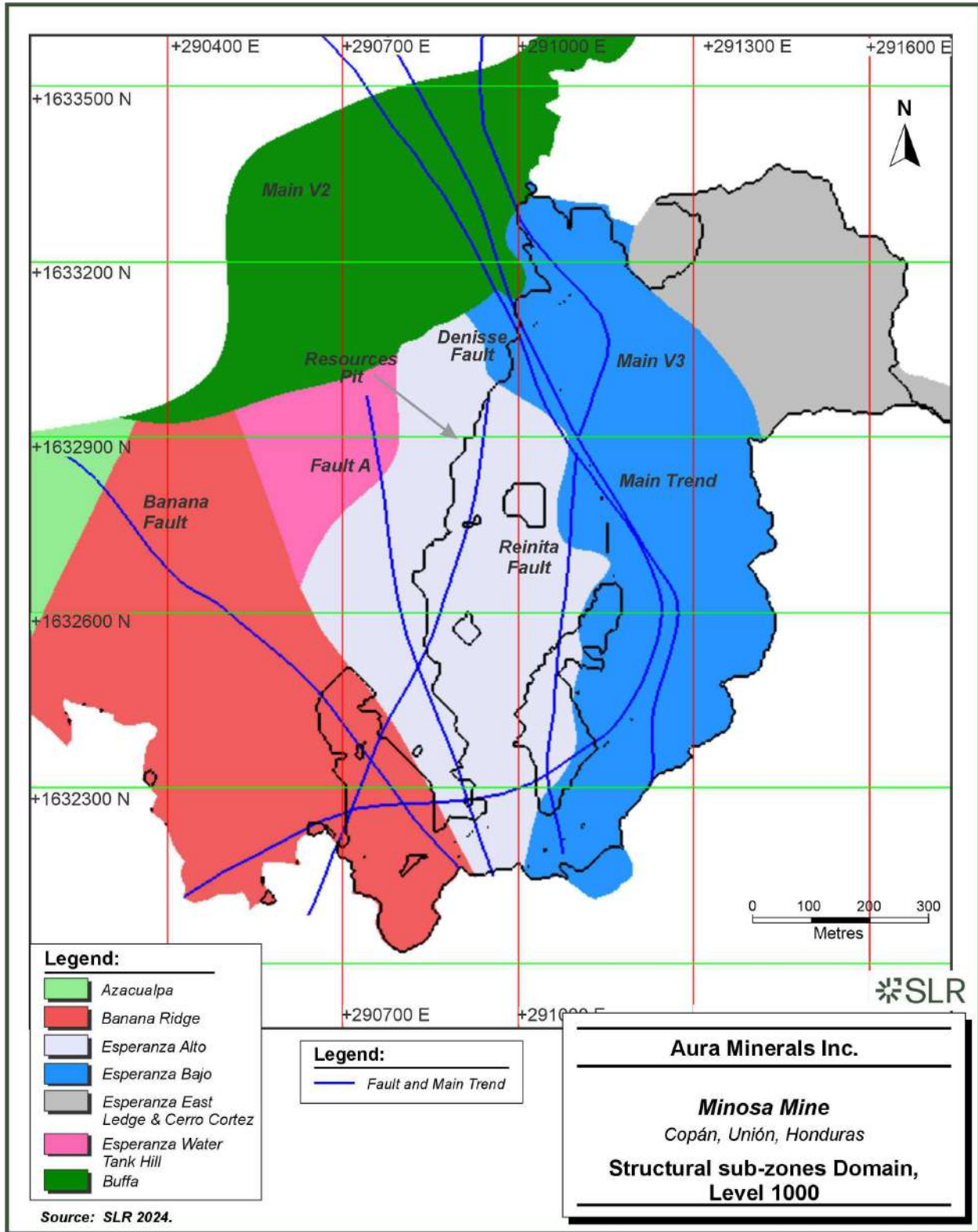
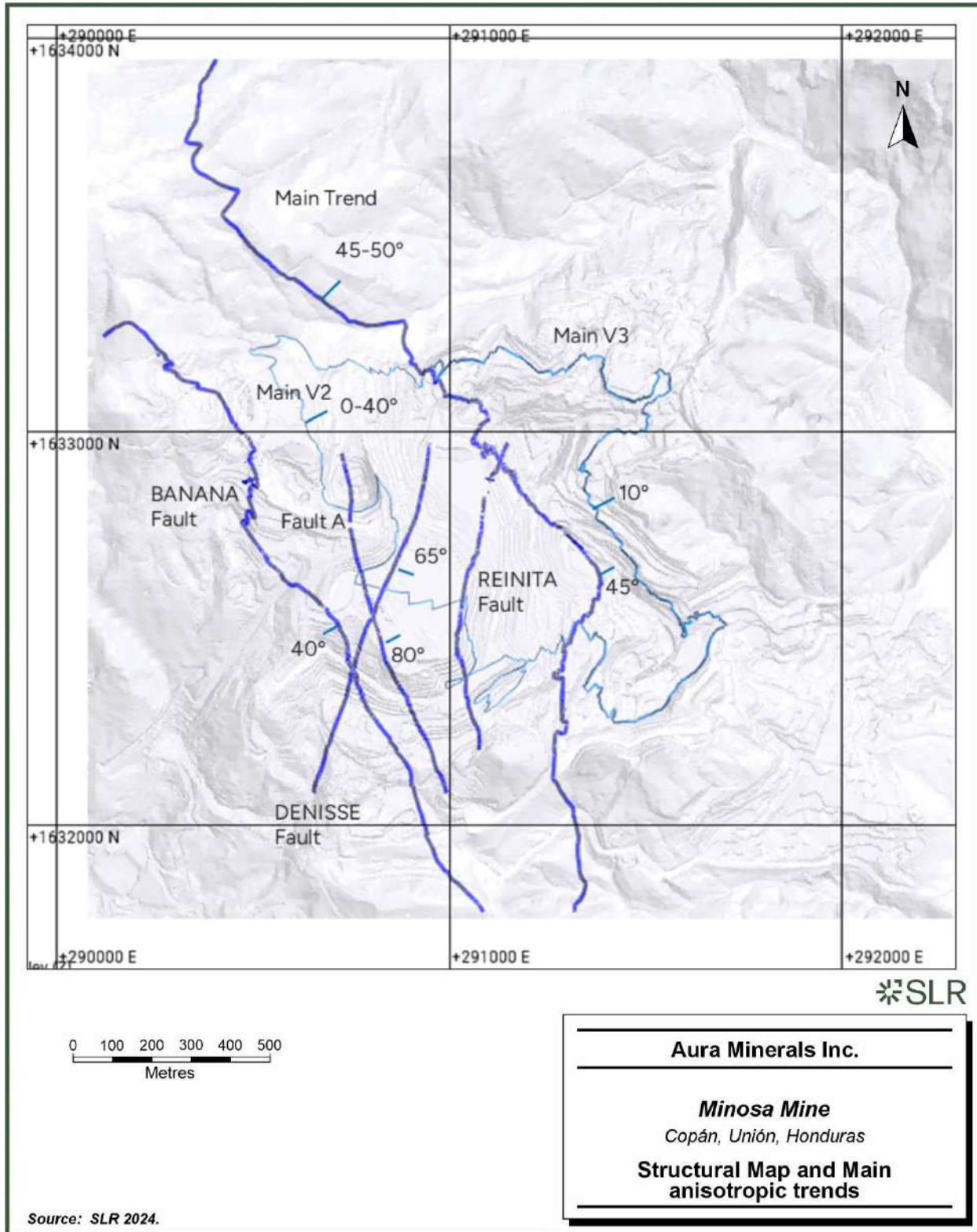


Figure 14-8: Structural Map and Main Anisotropic Trends



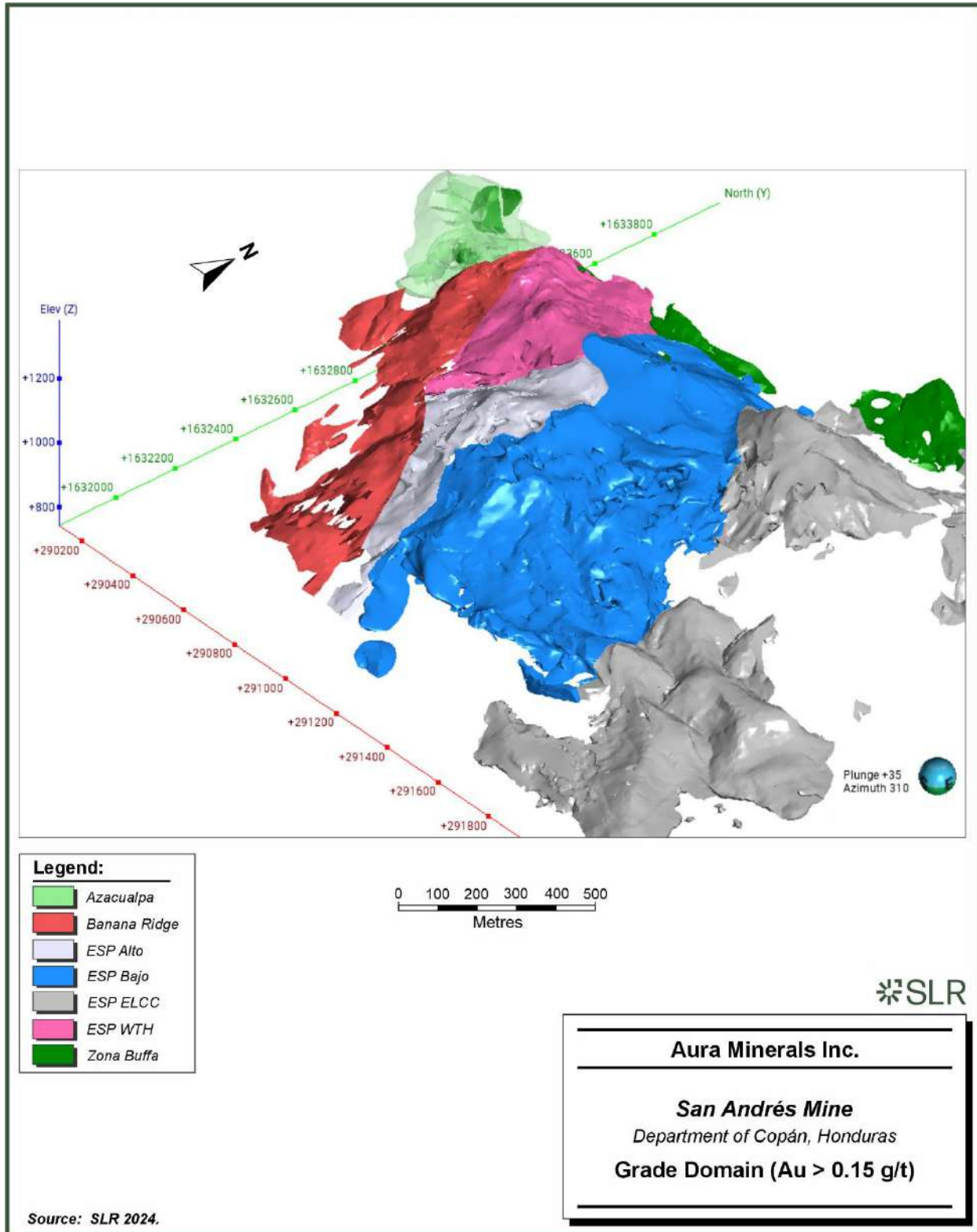
14.4 Grade Domaining

The drill hole data were used to build grade shells (by domain) above and below 0.15 g/t Au, low grade (WT) and high grade (ore), respectively. This resulted in two grade shells by structural sub-zone domains.

The Ore and WT grade shells were treated as hard boundaries whereby only composites located within a grade shell were used to interpolate blocks within that grade shell. Figure 14-9 presents the Au > 0.15 g/t grades shells by structural sub-zone domain.

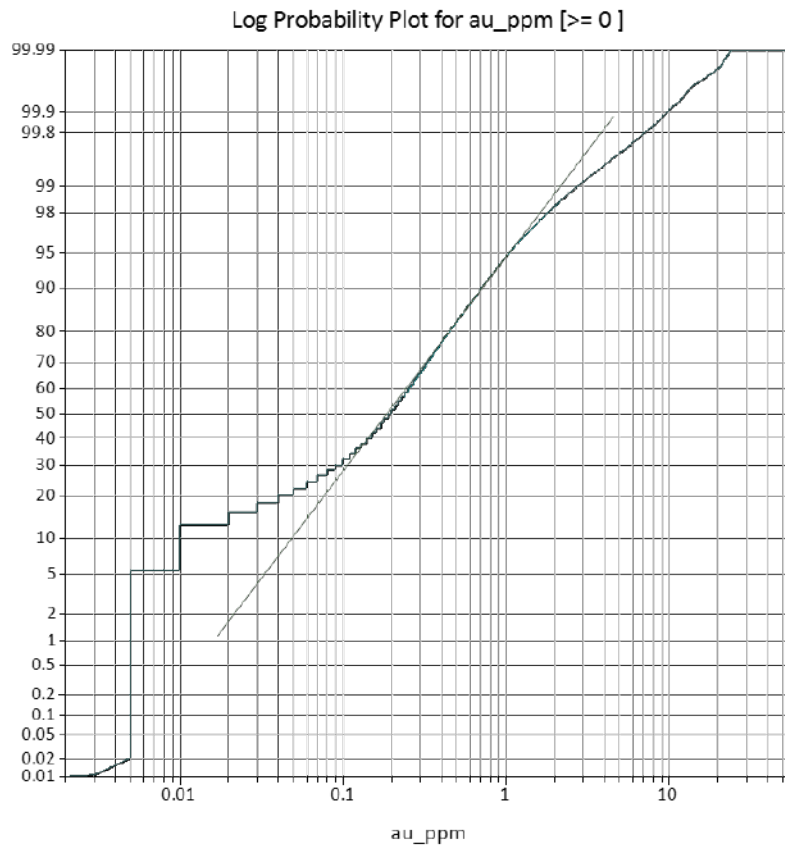


Figure 14-9: Grade Domain (Au > 0.15 g/t)



SLR prepared a log probability plot for gold distribution for all domains, as presented in Figure 14-10. SLR observed the gold distribution breaks at approximately 0.15 g/t Au, which may represent a different mineralization population. This break in the gold distribution is below the Mineral Resources cut-off grade. The SLR QP considers the grade domains as built to be appropriate for Mineral Resource estimation.

Figure 14-10: Log Probability Plot Au g/t All Domains



14.5 Treatment of High Grade Assays

14.5.1 Capping Levels

Minosa applied the capping for each estimation domain (Oxidation, Grade Domain, and Area) to reduce any undue influence of the extremely high-grade values. The capping was applied prior to compositing. The capping levels and associated impact are summarized in Table 14-8.

SLR examined the raw drill data for outliers using histogram, cumulative probability plots, mean and variance plots. Figure 14-11 presents an example of these plots for the Esperanza Alto Oxide. Figure 14-12 presents box plots by domain. Metal loss due to capping of higher grades was assessed for each estimation domain. Several scenarios were considered to understand the effect of capping, and the results were compared with the tonnes and grade within the mined-out areas.

SLR notes the low coefficient of variation (CV) for a gold deposit in Table 14-8. The statistics show a 2% potential metal cut, similar result show the uncapped estimation.



The SLR QP is of the opinion that the treatment of high-grade outliers applied by Minosa is reasonable, Also, the SLR QP considers capping before compositing, a good practice as it avoids smoothing any outliers with low grade values.

Figure 14-11: Global TopCut Analysis. Esperanza Alto Oxide.

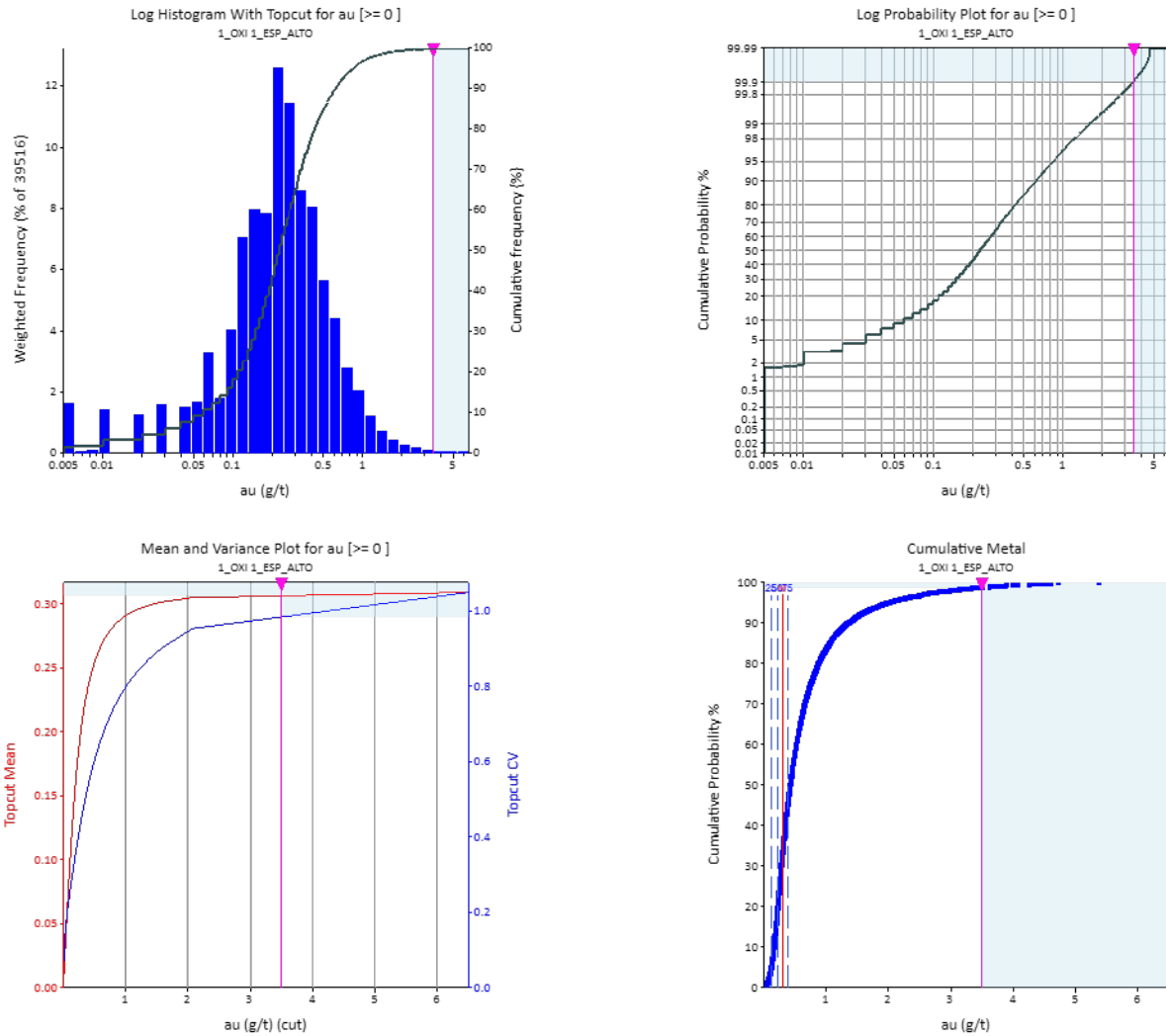


Figure 14-12: Box Plot Assays by Domain

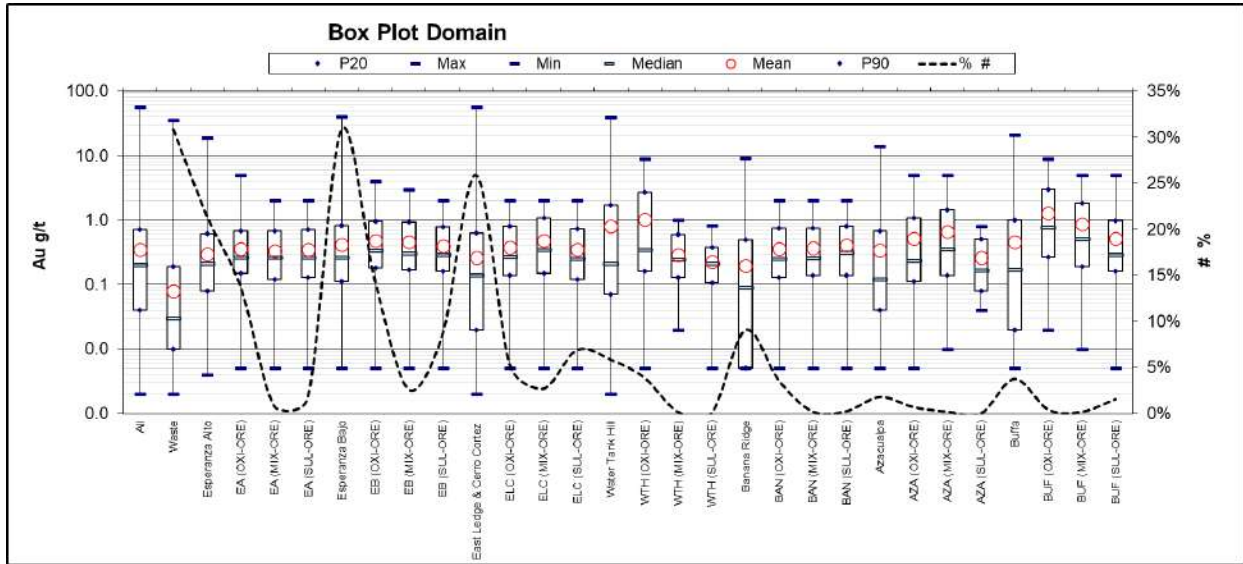


Table 14-8: Capping Statistics

Code	# Samples	%	Capped Values					Uncapped Values						
			Mean (Au g/t)	SD	Capped (Au g/t)	CV	% GT	Mean (Au g/t)	Max (Au g/t)	SD	CV	Percentile	No. Capped	Metal Loss
All	156,230	-						0.35	56	0.78	2.24			
Waste	48,237	31%	0.08	0.34	1.00	1.60	7%	0.08	36	0.18	2.26	99.6%	197	3%
Esperanza Alto	33,520	21%	0.29	0.35	3.50	1.16	18%	0.29	19	0.37	1.28	99.8%	62	1%
EA(OXI-ORE)	21,421	14%	0.35	0.29	3.50	1.00	14%	0.36	7	0.37	1.05	99.8%	44	1%
EA(MIX-ORE)	1,232	1%	0.34	0.32	2.00	0.86	1%	0.34	4	0.32	0.94	99.7%	4	1%
EA(SUL-ORE)	2,706	2%	0.35	0.50	2.00	0.91	2%	0.38	19	0.59	1.58	98.9%	31	7%
Esperanza Bajo	48,157	31%	0.40	0.53	4.00	1.25	36%	0.41	40	0.72	1.77	99.5%	248	4%
EB(OXI-ORE)	22,391	14%	0.48	0.50	4.00	1.10	20%	0.50	40	0.78	1.56	99.4%	133	4%
EB(MIX-ORE)	4,051	3%	0.46	0.37	3.00	1.09	3%	0.48	11	0.69	1.43	98.6%	57	5%
EB(SUL-ORE)	13,427	9%	0.40	0.33	2.00	0.93	10%	0.44	37	0.80	1.82	98.0%	264	10%
East Ledge & Cerro Cortez	40,459	26%	0.25	0.35	2.00	1.32	19%	0.26	56	0.48	1.81	99.2%	315	4%
ELC(OXI-ORE)	8,228	5%	0.38	0.44	2.00	0.93	6%	0.39	9	0.45	1.15	98.9%	88	3%
ELC(MIX-ORE)	4,211	3%	0.48	0.34	2.00	0.90	4%	0.50	8	0.53	1.05	98.2%	74	3%
ELC(SUL-ORE)	10,780	7%	0.35	1.51	2.00	0.98	7%	0.37	56	0.64	1.73	98.8%	133	5%
Water Tank Hill	9,123	6%	0.71	1.78	9.00	2.12	12%	0.79	39	2.14	2.70	98.6%	129	10%
WTH(OXI-ORE)	6,060	4%	1.02	0.21	9.00	1.75	12%	1.14	39	2.56	2.25	97.9%	128	11%
WTH(MIX-ORE)	254	0%	0.29	0.14	1.00	0.72	0%	0.34	13	0.83	2.45	98.4%	4	15%
WTH(SUL-ORE)	82	0%	0.23	0.29	0.82	0.63	0%	0.23	1	0.14	0.63	100.0%	-	0%
Banana Ridge	14,170	9%	0.19	0.35	2.00	1.50	5%	0.20	9	0.34	1.74	99.5%	71	3%
BAN(OXI-ORE)	5,534	4%	0.36	0.34	2.00	0.98	4%	0.37	9	0.45	1.22	98.8%	64	4%
BAN(MIX-ORE)	326	0%	0.37	0.35	2.00	0.93	0%	0.37	2	0.35	0.94	99.1%	3	1%
BAN(SUL-ORE)	383	0%	0.40	0.67	2.00	0.86	0%	0.41	3	0.36	0.89	99.2%	3	1%



Code	# Samples	%	Capped Values					Uncapped Values						
			Mean (Au g/t)	SD	Capped (Au g/t)	CV	% GT	Mean (Au g/t)	Max (Au g/t)	SD	CV	Percentile	No. Capped	Metal Loss
Azacualpa	2,793	2%	0.32	0.84	5.00	2.08	2%	0.34	14	0.88	2.57	99.2%	22	6%
AZA(OXI-ORE)	1,077	1%	0.51	0.93	5.00	1.64	1%	0.56	14	1.19	2.14	98.5%	16	9%
AZA(MIX-ORE)	304	0%	0.66	0.21	5.00	1.41	0%	0.68	8	1.04	1.53	98.4%	5	3%
AZA(SUL-ORE)	15	0%	0.26	0.96	0.79	0.81	0%	0.26	1	0.21	0.81	100.0%	-	0%
Bufa	5,860	4%	0.45	1.55	9.00	2.14	5%	0.45	21	1.05	2.32	99.7%	16	2%
BUF(OXI-ORE)	664	0%	1.27	1.13	9.00	1.22	2%	1.31	21	1.79	1.37	98.9%	7	3%
BUF(MIX-ORE)	282	0%	0.86	1.55	5.00	1.31	0%	0.95	12	1.55	1.63	95.7%	12	9%
BUF(SUL-ORE)	2,417	2%	0.51	0.75	5.00	1.46	2%	0.55	17	1.03	1.89	98.9%	27	7%
Notes: SD Standard Deviation CV Coefficient of Variation GT Grade-Thickness (Au g/t x Mts)														



14.5.2 High Grade Restriction

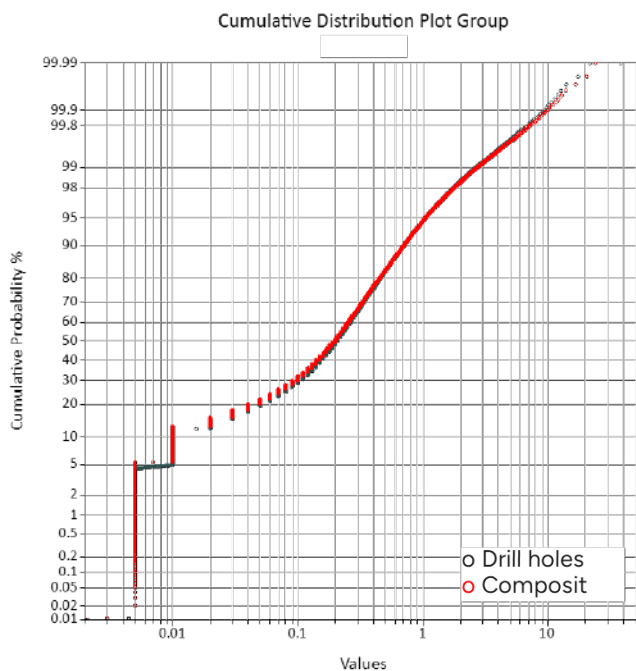
A high yield restriction (HYR) is applied in the estimation passes 2, 3, and 4 such that the composite is capped at 1 g/t Au at distances greater than 50% of the estimation range.

14.6 Compositing

The composite length within each estimation domain (oxidation, grade and area) was chosen to reflect the sample resolution expected in the grade control system for the Mine. In current operations, grade control is based on 6 m blast holes and 6 m bench heights, the resource block model is 10 m x 10 m x 6 m, and the normal sample length in RC is 1.52 m and in DD 1.5 m. A composite length of 1.5 m was selected. Using hard geological boundary (estimation domain, combination between mineralization, grade and area), if the residual sample is less than 0.75 m, it is added to the previous interval.

SLR reviewed composites with the raw data and observed no changes in the mean values, a small reduction in standard deviation (SD) from 0.776 to 0.717, and a small reduction in the maximum value from 56.90 g/t Au to 37.83 g/t Au (Figure 14-13). The SLR QP considers the selected length and the compositing strategy to be appropriate.

Figure 14-13: Cumulative Distribution Comparison between Drill Holes Raw Data vs Composite



	Drill holes	Composites
Samples	156,230	155,137
Minimum	0.002	0.002
Maximum	56.09	37.83
Mean	0.347	0.346
SD	0.776	0.717
CV	2.235	2.072
Variance	0.602	0.513
Skewness	16.566	14.501
Log mean	-1.946	-1.910
Log variance	2.254	2.180
Geometric mean	0.143	0.148



14.7 Trend Analysis

14.7.1 Grade x Thickness Distribution and Trend Analysis

SLR generated grade x thickness (GT) in plan and in north-south and east-west sections at a 0.05 g/t Au cut-off, identifying the main mineralization trends and the association with the Main Trend in the north and Banana Fault in the south. High grade intervals are observed in the area where two or more faults or trends are combined. Experimental variograms incorporate GT and the fault system in the analysis.

The general mineralized styles or trends are associated with Breccia/Conglomerate reflected in the Main Trend V2 and V1, enriched with the NNE/N fault Reinita, Denisse, and the NNE/S Banana Fault.



Figure 14-14: Grade x Thickness – Plan View

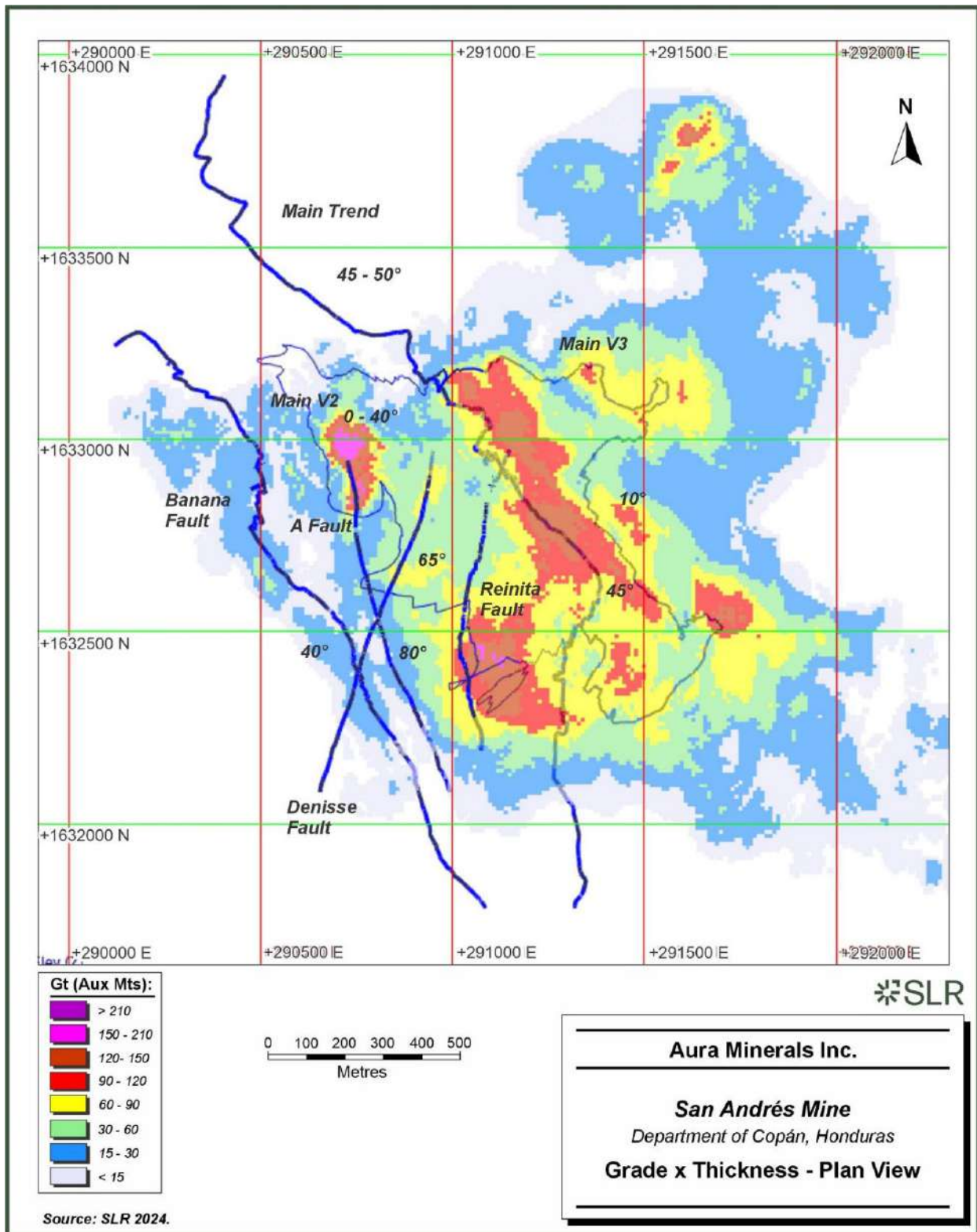


Figure 14-15: Grade x Thickness (GT) – East-West Section

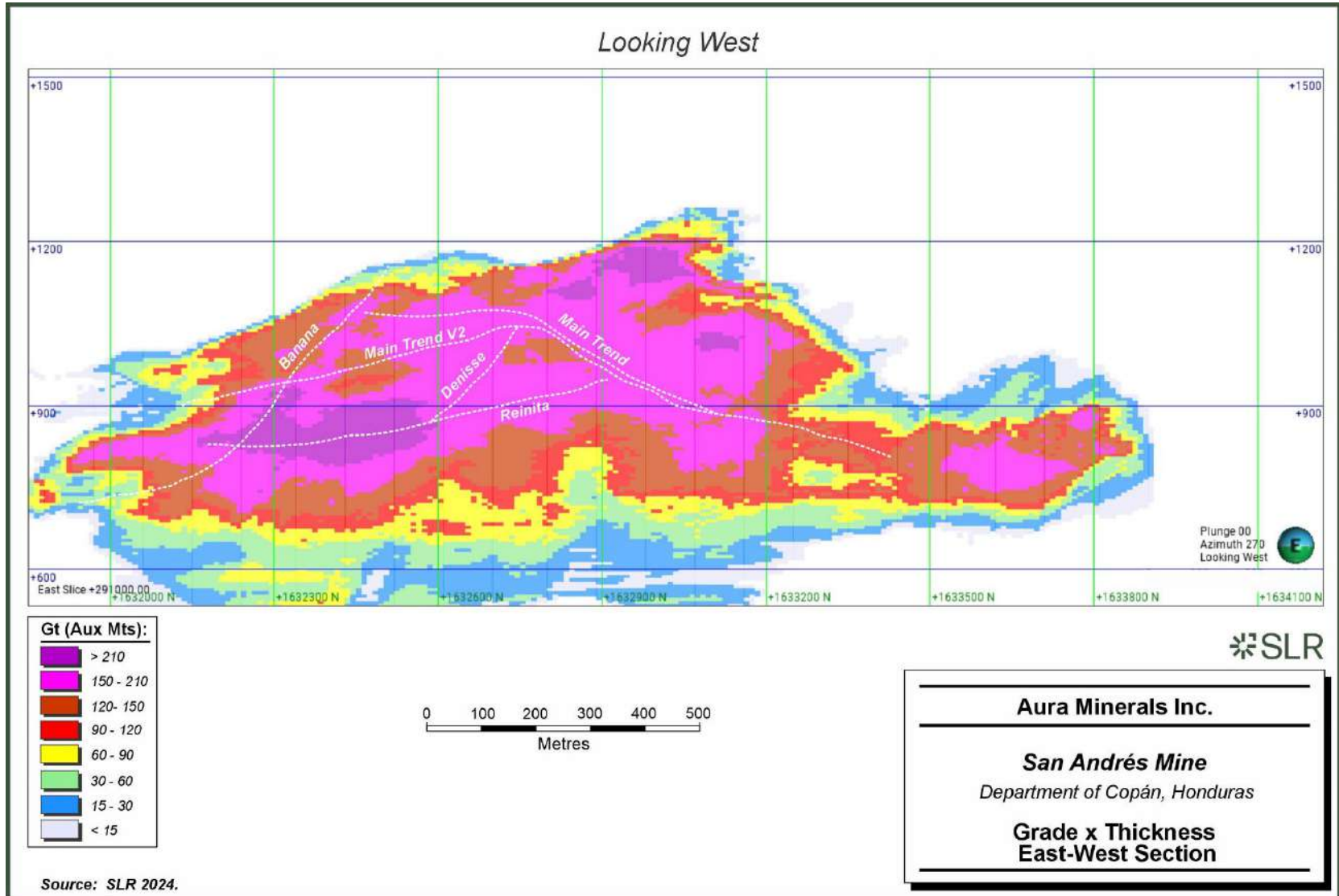
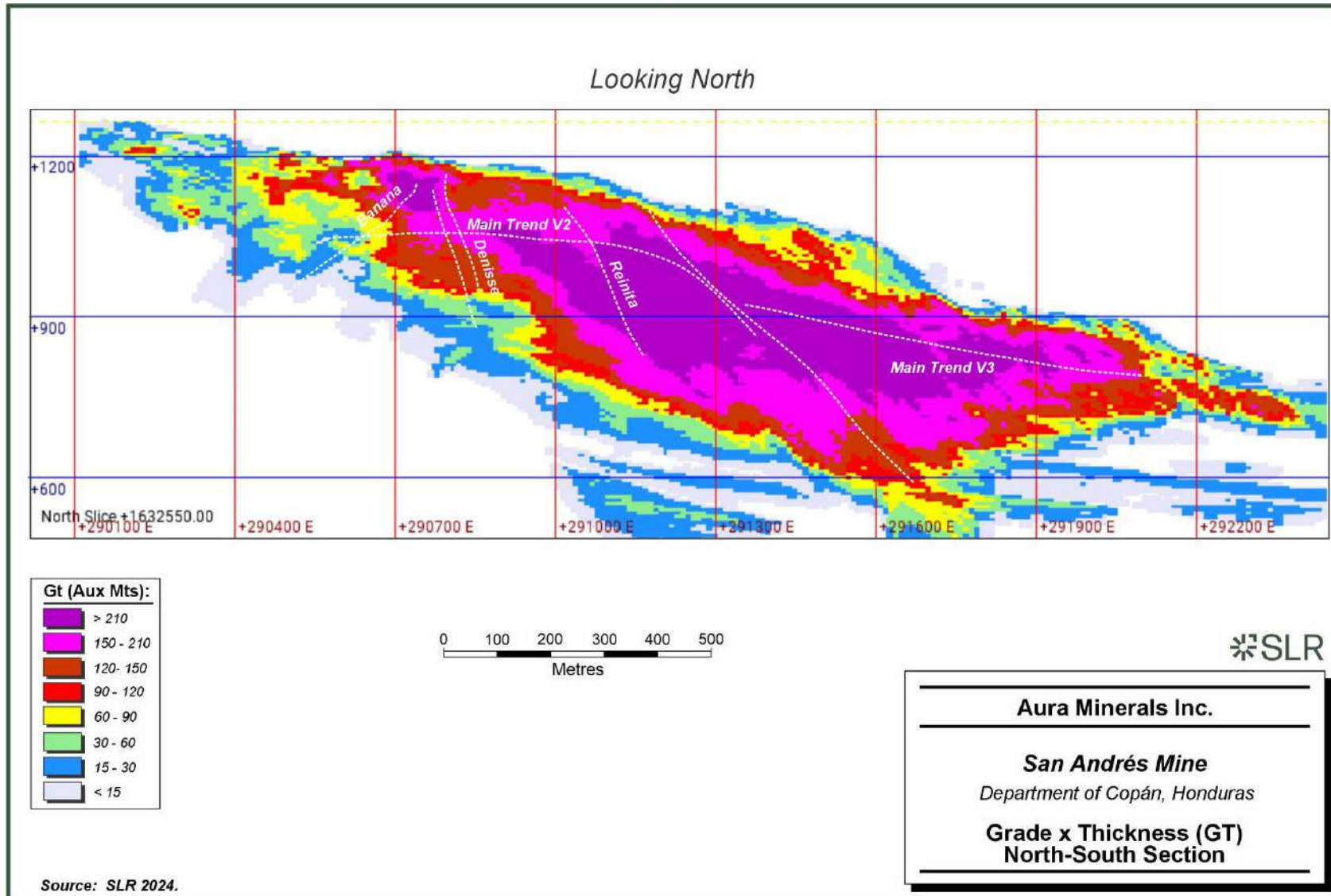


Figure 14-16: Grade x Thickness – North-South Section



14.7.2 Variography

Experimental variograms were calculated and modelled in Leapfrog for all the estimation domains were generated based on a number of geological parameters, which include oxidation type, gold grade wireframes and structural zone, and applied in the ordinary kriging (OK) estimation and in the classification. Key assumptions for the variogram analysis include:

- Variograms use 1.5 m composites, for each estimation domains.
- Variograms are oriented parallel to the main structural axes of the mineralized zones.

Figure 14-17 and Figure 14-18 present the variogram models for the Esperanza Alto and Esperanza Bajo domains, which contain over 70% of the estimated Mineral Resources. Table 14-9 summarizes all the gold variogram models use in the estimation. Based on the relevance of these domains, the variogram range for the Esperanza Alto and Esperanza Bajo domains were used as classification criteria.

In the estimation process, the SLR QP, in coordination with the Mine’s geology team, reviewed and re-ran all the variograms to confirm they were appropriate for use in the Mineral Resource estimation.

Figure 14-17: Esperanza Alto Oxide Variogram

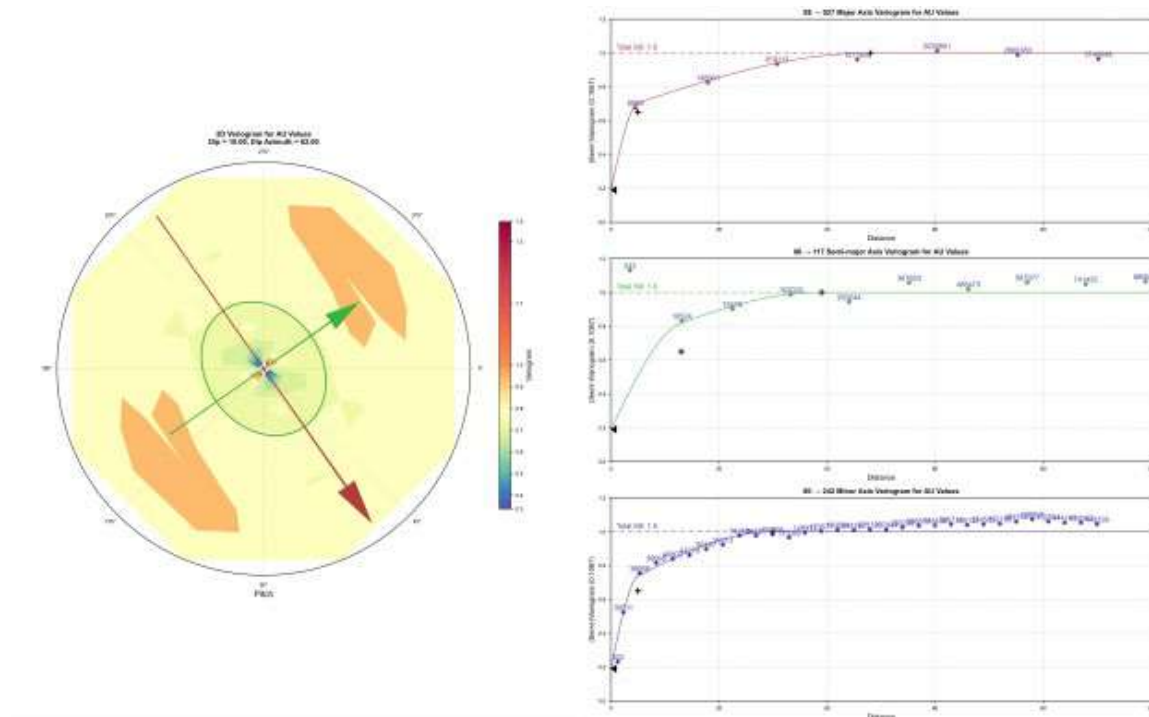


Figure 14-18: Esperanza Bajo Oxide Variogram

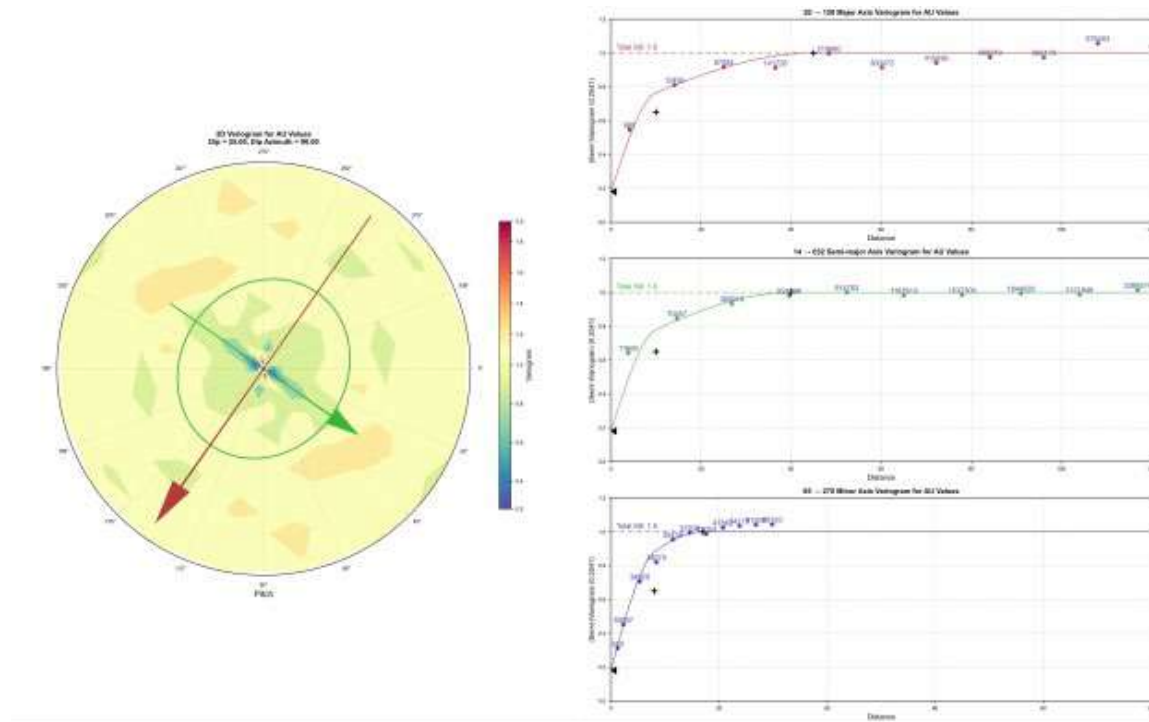


Table 14-9: Variogram Model Parameters

Area	Domain	Variance	Normalized Nugget	Dip	Dip Az.	Pitch	Normal sill	Major	Semi-major	Minor	Normal sill	Major	Semi-major	Minor
Azacualpa	ORE OXI	0.624	0.200	25	240	30	0.400	50	5	5	0.40	80	25	6
	ORE MIX	0.299	0.200	25	240	30	0.400	50	5	5	0.40	80	25	6
	ORE SULPH	0.030	0.250	25	240	30	0.430	40	15	2.5	0.32	80	30	5
Banana Ridge	ORE OXI	0.113	0.150	36	250	170	0.450	25	5	5	0.40	40	18	12
	ORE MIX	0.102	0.150	36	250	170	0.500	25	8	5	0.35	80	30	25
	ORE SULPH	0.108	0.150	36	250	170	0.500	40	20	6	0.35	80	30	25
ESP ALTO	ORE OXI	0.107	0.190	10	62	55	0.460	5	13	5	0.35	48	39	30
	ORE MIX	0.077	0.190	10	62	55	0.280	20	28	4	0.53	26	40	18
	ORE SULPH	0.253	0.190	10	62	55	0.314	65	28	3	0.50	190	60	10
ESP BAJO	ORE OXI	0.254	0.180	25	90	125	0.470	10	10	8	0.35	45	40	17
	ORE MIX	0.168	0.150	25	90	127	0.400	20	24	5	0.45	115	55	30
	ORE SULPH	0.524	0.150	38	90	125	0.300	30	15	7	0.55	105	85	18
ESP ELCC	ORE OXI	0.174	0.120	6	117	110	0.420	50	40	4	0.46	150	165	18
	ORE MIX	0.245	0.300	6	117	110	0.310	45	45	9	0.39	145	70	20
	ORE SULPH	0.238	0.300	6	117	110	0.440	45	45	4	0.26	145	70	6
ESP WTH	ORE OXI	5.555	0.180	23	85	75	0.470	8	16	7	0.35	20	20	13
	ORE MIX	0.386	0.180	23	85	75	0.470	30	15	4	0.35	40	40	8
	ORE SULPH	0.015	0.180	23	85	75	0.470	30	15	4	0.35	40	40	8
Buffa Zone	ORE OXI	2.395	0.380	37	127	50	0.400	25	29	5	0.22	55	39	18
	ORE MIX	2.354	0.380	37	127	50	0.440	30	21	8	0.18	80	40	15
	ORE SULPH	0.924	0.380	37	197	0	0.440	30	21	15	0.18	90	50	30



Area	Domain	Variance	Normalized Nugget	Dip	Dip Az.	Pitch	Normal sill	Major	Semi-major	Minor	Normal sill	Major	Semi-major	Minor
Azacualpa	WST OXI	0.060	0.250	25	240	30	0.500	24	12	16	0.25	50	32	30
	WST MIX	0.160	0.250	25	240	120	0.503	24	12	16	0.25	50	32	30
	WST SULPH	0.000	0.250	25	240	120	0.503	24	12	16	0.25	50	32	30
Banana Ridge	WST OXI	0.022	0.150	36	250	170	0.500	18	35	35	0.35	50	40	40
	WST MIX	0.006	0.150	36	250	170	0.503	18	35	35	0.35	50	40	40
	WST SULPH	0.003	0.150	36	250	170	0.503	18	35	35	0.35	50	40	40
ESP ALTO	WST OXI	0.019	0.250	10	62	55	0.150	35	30	7	0.60	105	90	50
	WST MIX	0.025	0.250	10	62	55	0.150	35	30	7	0.60	105	90	50
	WST SULPH	0.014	0.250	10	62	55	0.150	35	30	7	0.60	105	90	50
ESP BAJO	WST OXI	0.023	0.120	25	90	125	0.720	105	12	10	0.16	200	45	35
	WST MIX	0.024	0.124	38	90	125	0.576	105	12	30	0.30	200	45	35
	WST SULPH	0.014	0.124	38	90	125	0.576	105	12	30	0.30	200	45	35
ESP ELCC	WST OXI	0.014	0.120	6	117	20	0.637	70	12	4.5	0.24	100	55	10
	WST MIX	0.015	0.120	6	117	20	0.637	70	12	4.5	0.24	100	55	10
	WST SULPH	0.032	0.120	6	117	20	0.637	70	12	4.5	0.24	100	55	10
ESP WTH	WST OXI	0.019	0.120	23	85	160	0.530	16	9	9	0.35	40	35	18
	WST MIX	0.013	0.120	23	85	160	0.530	16	9	9	0.35	40	35	18
	WST SULPH	0.032	0.120	23	85	160	0.530	16	9	9	0.35	40	35	18
Buffa Zone	WST OXI	0.017	0.380	37	127	50	0.440	34	25	8	0.18	80	40	15
	WST MIX	0.009	0.380	37	127	50	0.183	60	40	8	0.44	90	50	30
	WST SULPH	0.029	0.380	37	197	0	0.440	60	40	8	0.18	90	50	30



14.8 Block Models

Block model uses a 10 m x 10 m x 6 m parent block size and does not use sub-blocking. The block model is unrotated and has model extents and location as tabulated in Table 14-10.

Table 14-10: Block Model Definition

Minimum			Maximum			Block Size			# of Blocks		
X (m)	Y (m)	Z (m)	X (m)	Y (m)	Z (m)	X (m)	Y (m)	Z (m)	X	Y	Y
289450	1631470	348	292680	1634100	1350	10	10	6	323	263	167

14.9 Search Strategy and Grade Interpolation Parameters

Resource estimation was completed using ordinary kriging (OK), applying dynamic anisotropy (DA) by geological domain and using ellipsoid ranges selected by variography.

The estimation strategy applied a multi-pass strategy by the different estimation domain:

- 1st pass: Uses the full range variography and a sample restriction of a minimum of 8 composites, a maximum of 32 composites, and a maximum of 4 composites per hole. This resulted in a minimum of two drill holes and a maximum of eight drill holes used per block.
- 2nd pass: Uses the double range variography. Sample restrictions were set at a minimum of 8, a maximum of 32, and a maximum of 4 per hole, resulting in a minimum of two drill holes and a maximum of eight drill holes.
- 3rd pass: Uses the triple range variography and a sample restriction of a minimum of 3, a maximum of 32, and a maximum of 4 per hole, resulting in a minimum of one drill hole and a maximum of eight drill holes.
- 4th pass: Uses the quadruple range variography and a sample restriction of a minimum of 3, a maximum of 32, and a maximum of 4 per hole, resulting in a minimum of one drill hole and a maximum of eight drill holes.

In the estimation passes 2, 3, and 4, a HYR restriction is applied that a composite is capped at 1 g/t Au at distances greater than 50% of the estimation range to control the impact of high grade values.

All passes use 5x5x3 kriging discretization.

The selection of a maximum of four composites per drill hole was chosen in consideration of the 1.5-m composite length and six metre block height.

Nearest neighbor (NN) estimates and the blast hole block model with production data were used for validation purposes.



Table 14-11: Sample Selection Strategy

	Run	Ellipsoid Ranges	Samples			Outlier Restrictions			Sector Search		
		Major Semi-Minor	Min	Max	Max per Hole	Method ¹	Distance %	Threshold Au g/t	Search Division	Max Samples per Sector	Max Empty Sectors
Ore	RUN1	Full Range	8	32	4				Quadrant	8	1
	RUN2	Full Range x 2	8	32	4	Clamp	50	1	Quadrant	8	2
	RUN3	Full Range x 3	3	32	4	Clamp	50	1	Quadrant	8	3
	RUN4	Full Range x 5	3	32	4	Clamp	50	1	Quadrant	8	3
WST	RUN1	Full Range	8	32	4	None			Quadrant	8	0
	RUN2	Full Range x 2	3	32	4	None			Quadrant	8	3
	RUN3	Full Range x 3	3	32	4	None			Quadrant	8	3
	RUN4	Full Range x 5	3	32	4	None			Quadrant	8	3

Notes:

1. The clamp method reduces the high values (over 1 g/t Au) to the Value Threshold (1 g/t Au).



Table 14-12: Search Strategy and Grade Interpolation Parameters

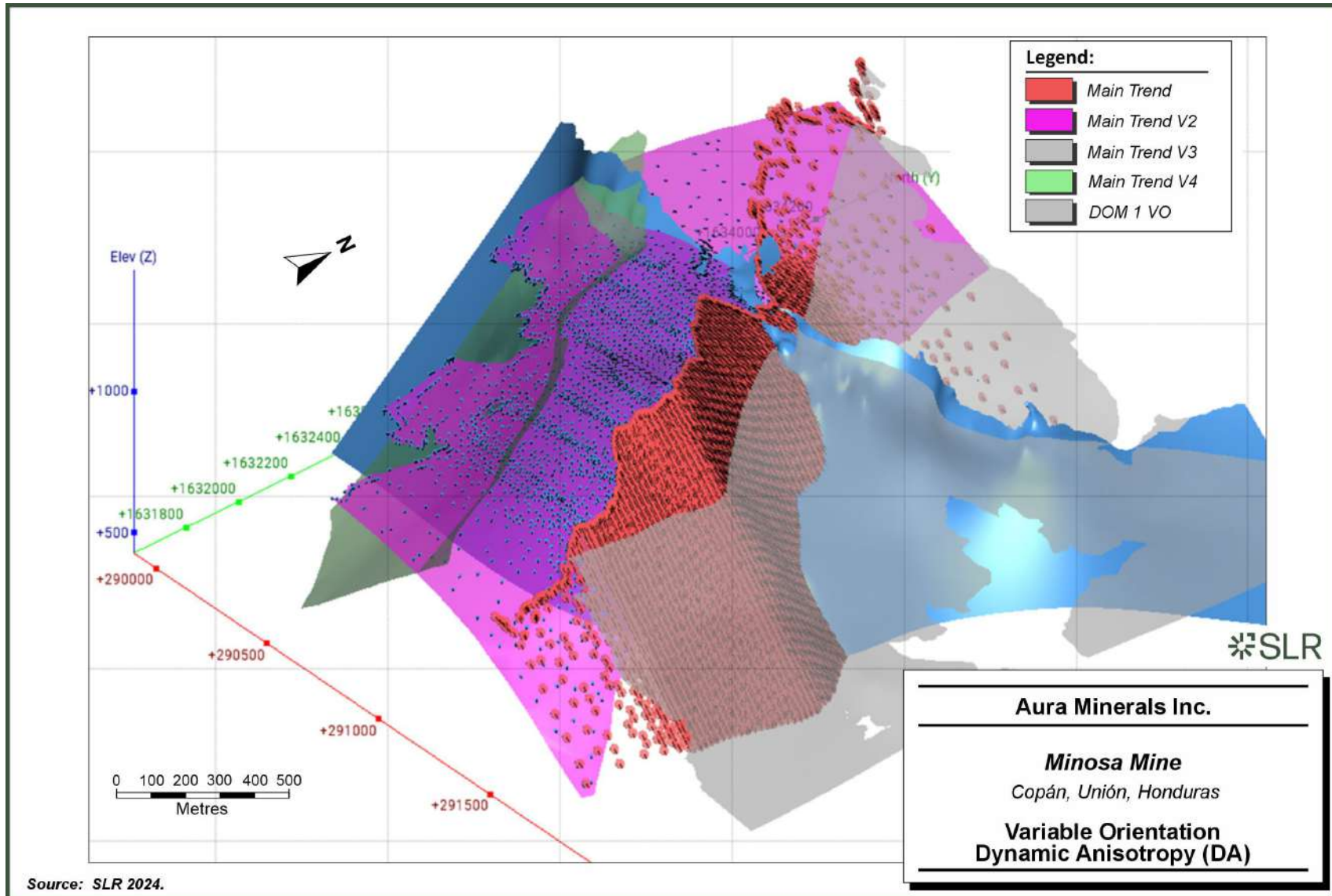
Area	Domain (Oxidation and Au envelope)	Ellipsoid Directions			Ellipsoid Ranges RUN1			Ellipsoid Ranges RUN2			Ellipsoid Ranges RUN3			Ellipsoid Ranges RUN4		
		Dip	Dip Az.	Pitch	Max	Inter	Min	Max	Inter	Min	Maxi	Inter	Min	Max	Inter	Min
Azacualpa	ORE OXI	25	240	30	80	25	6	160	50	12	240	75	18	600	110	60
	ORE MIX	Variable Orientation (DA)			80	25	6	160	50	12	240	15	18	1200	450	75
	ORE SULPH				80	30	5	160	60	10	240	90	15			
Banana Ridge	ORE OXI				40	18	12	80	36	24	120	54	36	975	375	75
	ORE MIX	80	30	25	160	60	50	240	90	75	480	180	150			
	ORE SULPH	80	30	25	160	60	50	240	90	75						
ESP ALTO	ORE OXI	Variable Orientation (DA)			48	39	30	96	78	60	144	117	90	270	120	96
	ORE MIX				26	40	18	52	80	36	78	120	54	420	360	90
	ORE SULPH				190	60	10	380	120	20	570	180	30			
ESP BAJO	ORE OXI	45	40	17	90	80	34	135	120	51	390	240	132			
	ORE MIX	115	55	30	230	110	60	345	165	90	630	510	108			
	ORE SULPH	105	85	18	210	170	36	315	255	54						
ESP ELCC	ORE OXI	150	165	18	300	330	36	450	495	54	780	480	120			
	ORE MIX	145	70	20	290	140	40	425	210	60	850	420	120			
	ORE SULPH	145	70	6	290	140	12	425	210	18						
ESP WTH	ORE OXI	20	20	13	40	40	26	60	60	39	144	108	60			
	ORE MIX	40	40	8	80	80	16	120	120	24	240	240	48			
	ORE SULPH	40	40	8	80	80	16	120	120	24						
Buffa Zone	ORE OXI	Variable Orientation			55	39	18	110	78	36	165	117	54	1350	750	450
	ORE MIX				80	40	15	160	80	30	240	120	45			
	ORE SULPH				90	50	30	180	100	60	270	150	90			



Area	Domain (Oxidation and Au envelope)	Ellipsoid Directions			Ellipsoid Ranges RUN1			Ellipsoid Ranges RUN2			Ellipsoid Ranges RUN3			Ellipsoid Ranges RUN4		
		Dip	Dip Az.	Pitch	Max	Inter	Min	Max	Inter	Min	Maxi	Inter	Min	Max	Inter	Min
Azacualpa	WST OXI	25	240	30	80	25	6	100	64	60	200	128	120			
	WST MIX	25	240	120	50	32	30	100	64	60	200	128	120			
	WST SULPH	25	240	120	50	32	30	100	64	60	200	128	120			
Banana Ridge	WST OXI	36	250	170	50	40	40	100	80	80	200	160	160			
	WST MIX	36	250	170	50	40	40	100	80	80	200	160	160	1000	800	800
	WST SULPH	36	250	170	50	40	40	100	80	80	200	160	160			
ESP ALTO	WST OXI	10	62	55	105	90	50	210	180	100	420	360	200			
	WST MIX	10	62	55	105	90	50	210	180	100	420	360	200			
	WST SULPH	10	62	55	105	90	50	210	180	100	420	360	200			
ESP BAJO	WST OXI	38	90	125	200	45	35	400	90	75	800	180	150			
	WST MIX	38	90	125	200	45	35	400	90	75	800	180	150			
	WST SULPH	38	90	125	200	45	35	400	90	75	800	180	150			
ESP ELCC	WST OXI	6	117	20	100	55	10	200	110	20	400	220	40	800	440	80
	WST MIX	6	117	20	100	55	10	200	110	20	400	220	40			
	WST SULPH	6	117	20	100	55	10	200	110	20	400	220	40			
ESP WTH	WST OXI	23	85	160	40	35	18	80	70	36	160	140	72			
	WST MIX	23	85	160	40	35	18	80	70	36	160	140	72			
	WST SULPH	23	85	160	40	35	18	80	70	36	160	140	72			
Buffa Zone	WST OXI	37	127	50	80	40	15	160	80	30	240	120	45	720	400	240
	WST MIX	37	197	0	90	50	30	180	100	60	360	200	120			
	WST SULPH	37	197	0	90	50	30	180	100	60	360	200	120			



Figure 14-19: Variable Orientation. Dynamic Anisotropy (DA)



14.10 Estimation Validation

SLR's validation followed industry standard techniques and included:

- Visual inspection of cross sections and plan views, viewing drill hole samples versus block estimates (Figure 14-20 through Figure 14-23)
- Comparison of the OK and NN estimation statistics (Table 14-13)
- Comparison of average assay grades with average block estimates along northing, easting, and elevation directions (swath plots presented in Figure 14-24 to Figure 14-26)
- Comparison between the 2024 block model and blast hole model
- Comparison between the 2023 block model and 2024 block model

14.10.1 Visual Inspection

Visual validation included comparing the drill hole samples and the estimated model grades in both plan and section. Plans and sections were also checked for smearing of grades across stacked ore/mineralized zones, and no smearing was identified. This validates the kriging parameters used to estimate the cells.

Typical cross sections comparing exploration drill hole data and block model estimates are shown in Figure 14-20, Figure 14-21, and Figure 14-22. Figure 14-23 presents the comparison in plan view.



Figure 14-20: Section North 1632550 Block Model and Drill holes

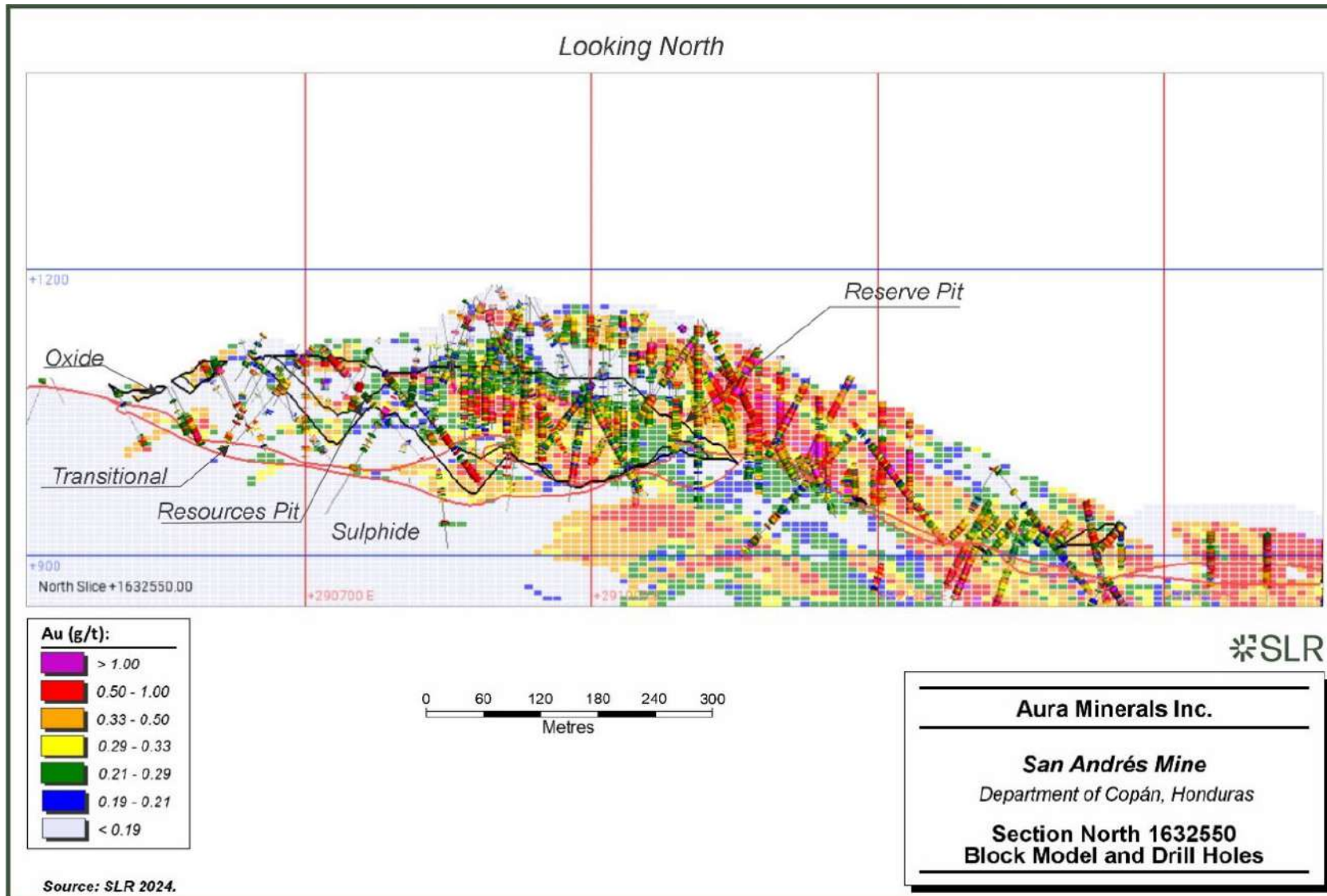


Figure 14-21: Section North 1632550 Production Data and Drill holes

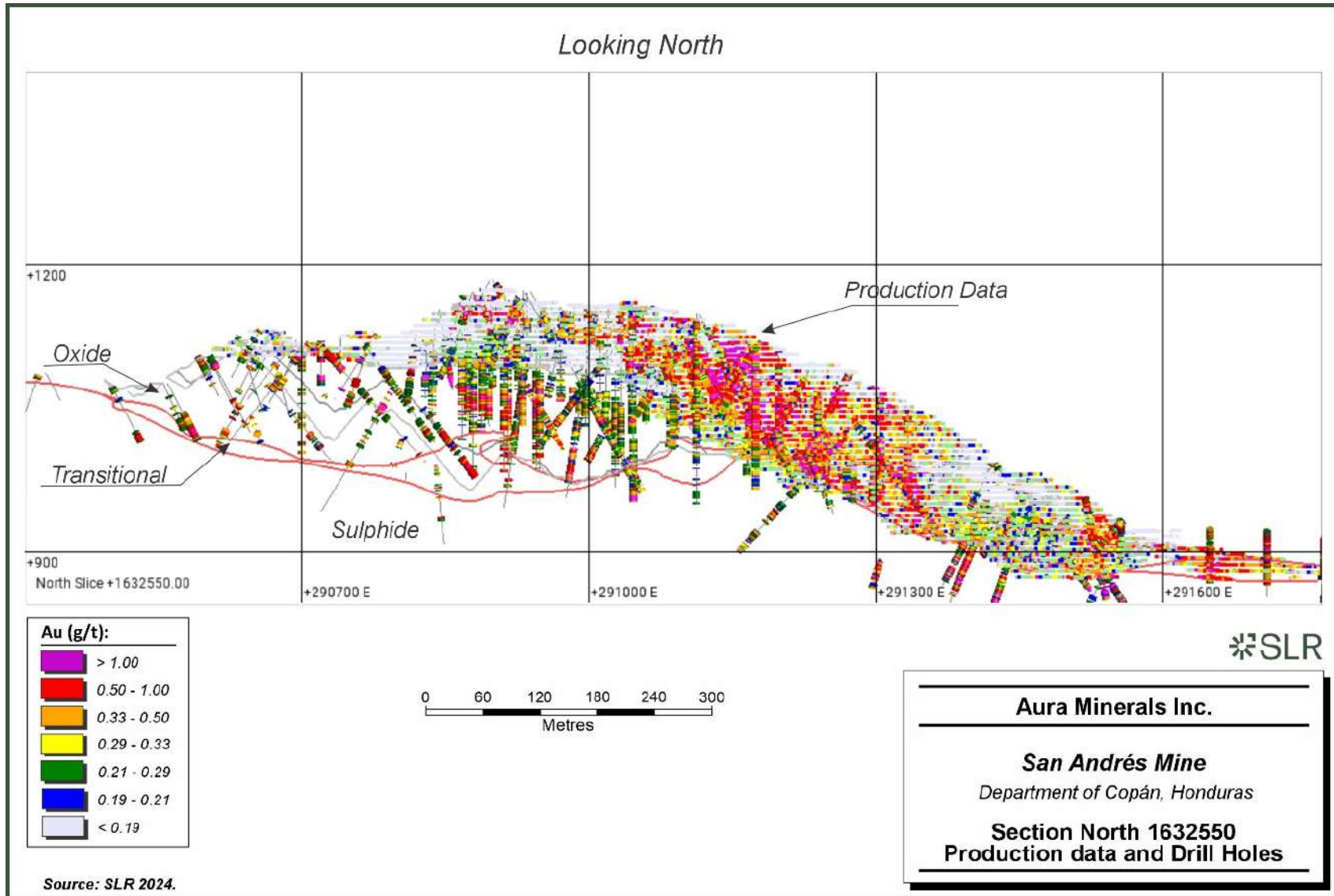


Figure 14-22: Section East 291000 Block Model and Drill Holes

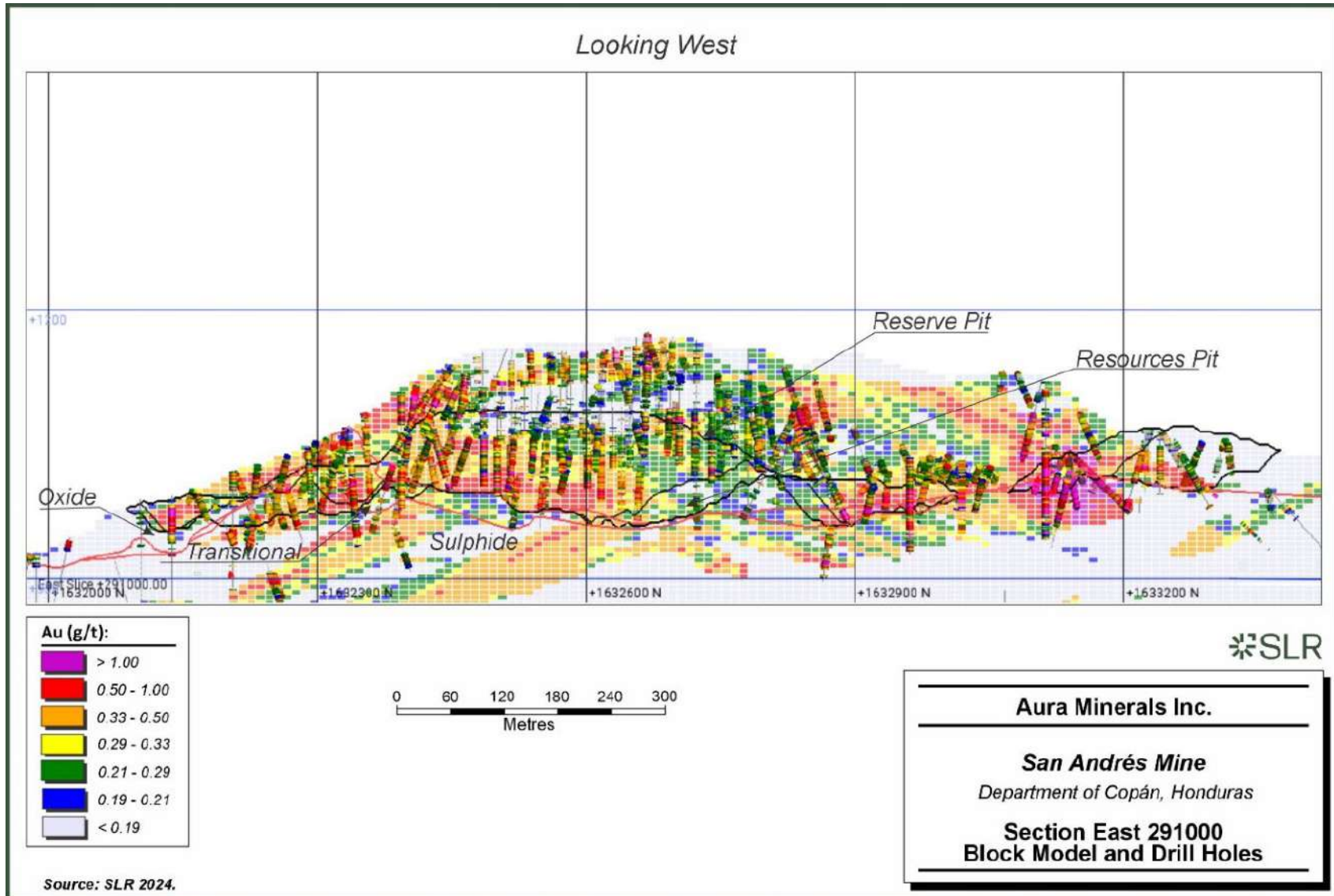
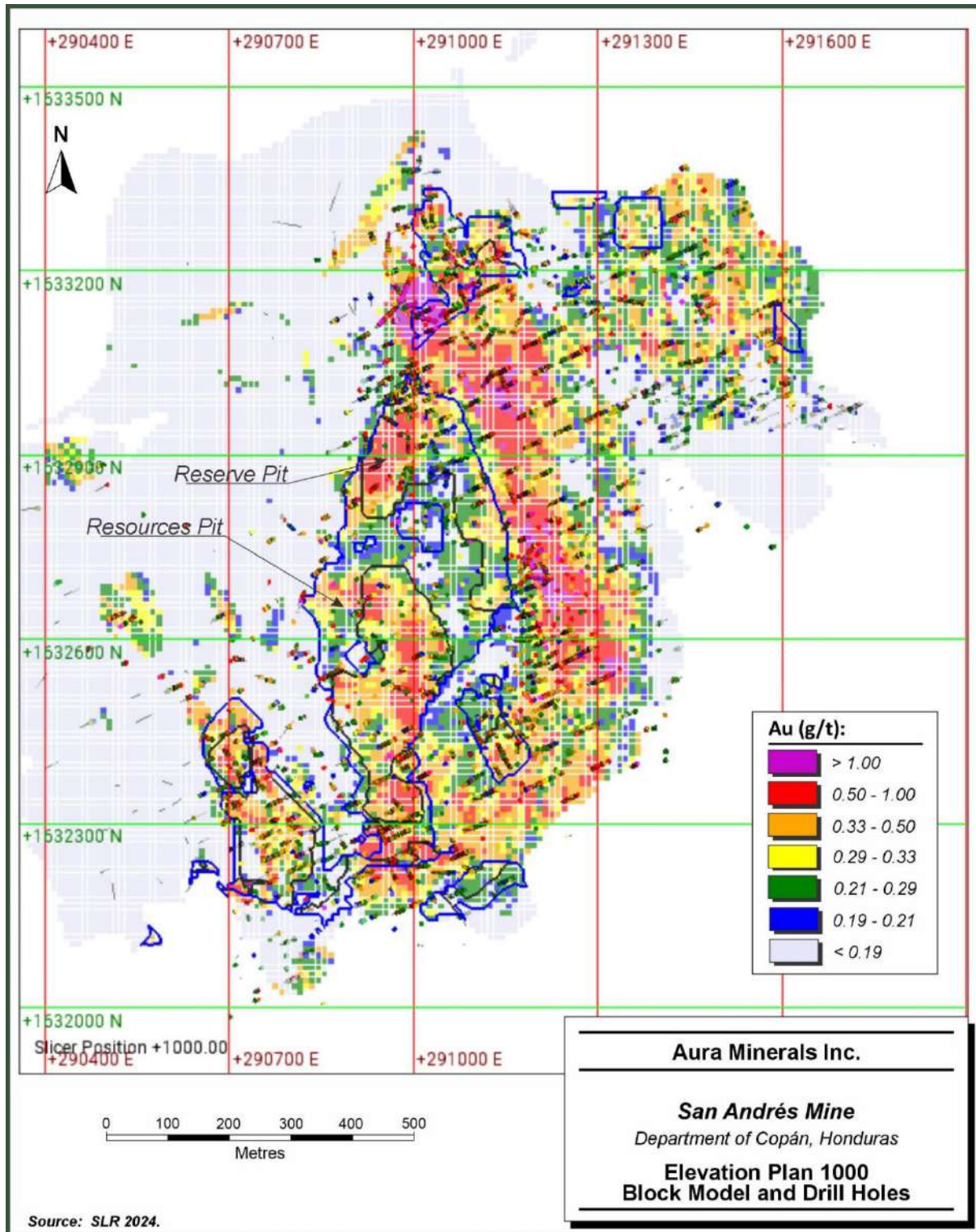


Figure 14-23: Elevation Plan 1000 Block Model and Drill Holes



14.10.2 Comparison of the OK and NN estimation statistics

Checks for global bias were conducted on a domain basis, and the relative percent differences of the kriged mean gold grades were checked against the Nearest Neighbor estimates. The undiluted model shows a 5% positive difference, as shown in Table 14-13, which is acceptable in the SLR QP's opinion.

Table 14-13: Reserve Estimation (OK) versus NN Gold Grade Estimation

Area	Miner	Tonnage (000 t)	OK (g/t Au)	NN (g/t Au)	Au Difference
Esperanza Alto	ORE OXI	50,358	0.361	0.360	0%
	ORE MIX	2,201	0.410	0.425	-4%
	WST OXI	7,376	0.114	0.113	1%
	WST MIX	116	0.093	0.098	-5%
Esperanza Bajo	ORE OXI	88,747	0.453	0.469	-4%
	ORE MIX	8,895	0.508	0.509	0%
	WST OXI	15,393	0.113	0.110	3%
	WST MIX	1,097	0.103	0.101	2%
Esperanza East Ledge & Cerro Cortez	ORE OXI	32,260	0.404	0.422	-4%
	ORE MIX	11,416	0.573	0.582	-2%
	WST OXI	3,343	0.086	0.081	6%
	WST MIX	775	0.099	0.075	31%
Esperanza Water Tank Hill	ORE OXI	15,532	0.687	0.864	-20%
	ORE MIX	166	0.450	0.396	14%
	WST OXI	1,729	0.100	0.096	4%
	WST MIX	12	0.169	0.140	21%
Banana Ridge	ORE OXI	15,339	0.362	0.381	-5%
	ORE MIX	547	0.458	0.490	-7%
	WST OXI	4,012	0.123	0.119	4%
	WST MIX	142	0.064	0.055	17%
Azacualpa	ORE OXI	4,771	0.436	0.488	-11%
	ORE MIX	1,428	0.563	0.675	-17%
	WST OXI	3,453	0.117	0.119	-1%
	WST MIX	1,382	0.112	0.082	37%
Buffa	ORE OXI	2,525	1.116	1.376	-19%
	ORE MIX	825	0.863	1.080	-20%
	WST OXI	62	0.061	0.059	3%



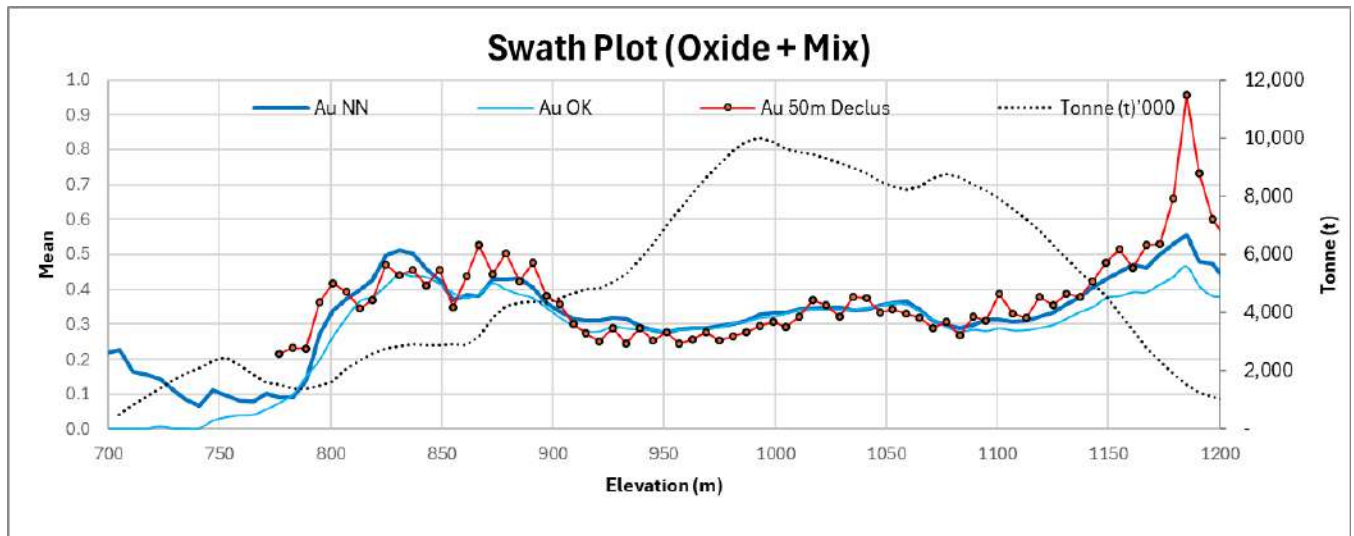
Area	Miner	Tonnage (000 t)	OK (g/t Au)	NN (g/t Au)	Au Difference
	WST MIX	70	0.085	0.100	-15%
	Oxide	244,899	0.394	0.418	-6%
	Mixed	29,071	0.497	0.502	-3%
	Total	273,838	0.404	0.427	-5%

The difference between OK estimation and NN in the Esperanza Water Tank Hill oxide are associated with high grade drill holes SA-005, SA-031, SA-035, SA-081, SA-199, SA-239, SA-245, SA-276, SC-04 and appropriately controlled in the OK estimation.

14.10.3 Swath Plots

Swath plots were generated to compare the NN gold grades, the OK gold grades, and the drill holes samples in elevation, east, and north directions. No local bias and minor smoothing were observed in the estimates (Figure 14-24 to Figure 14-26).

Figure 14-24: Swath Plot Elevation: Drill Hole Grades, OK and NN Grade Estimation



SLR observes positive differences of the drill samples in gold at level 1185, which are generated by high-grade intercepts of drill holes SA-174, SA-035 and SA-038.



Figure 14-25: Swath Plot Easting: Drill Hole Grades, OK and NN Grade Estimation

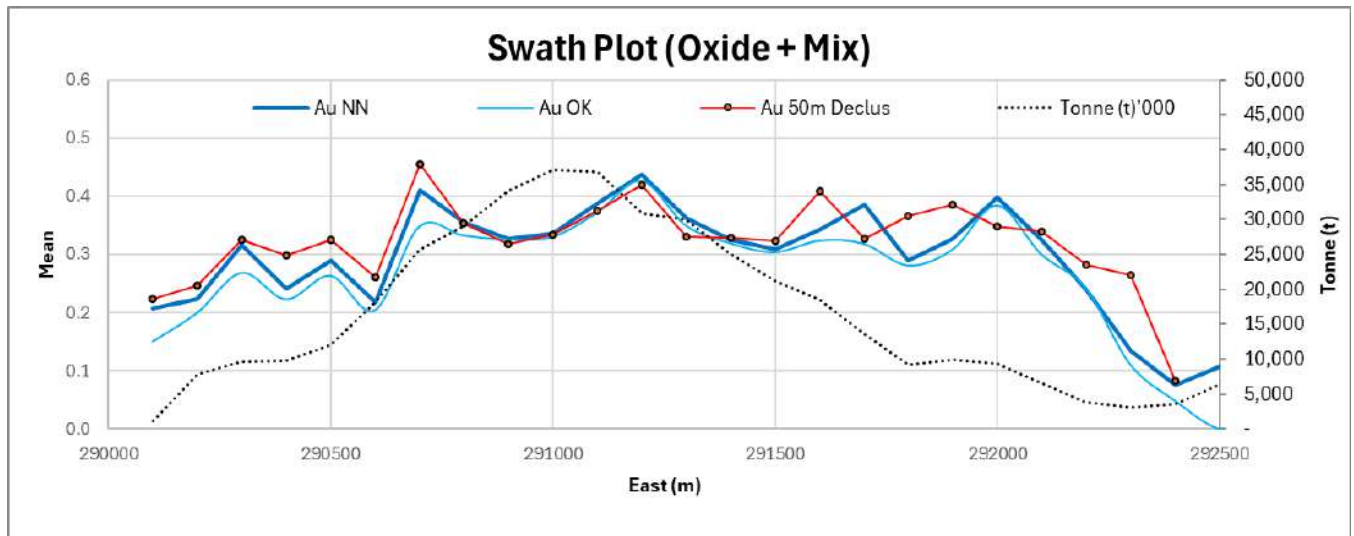
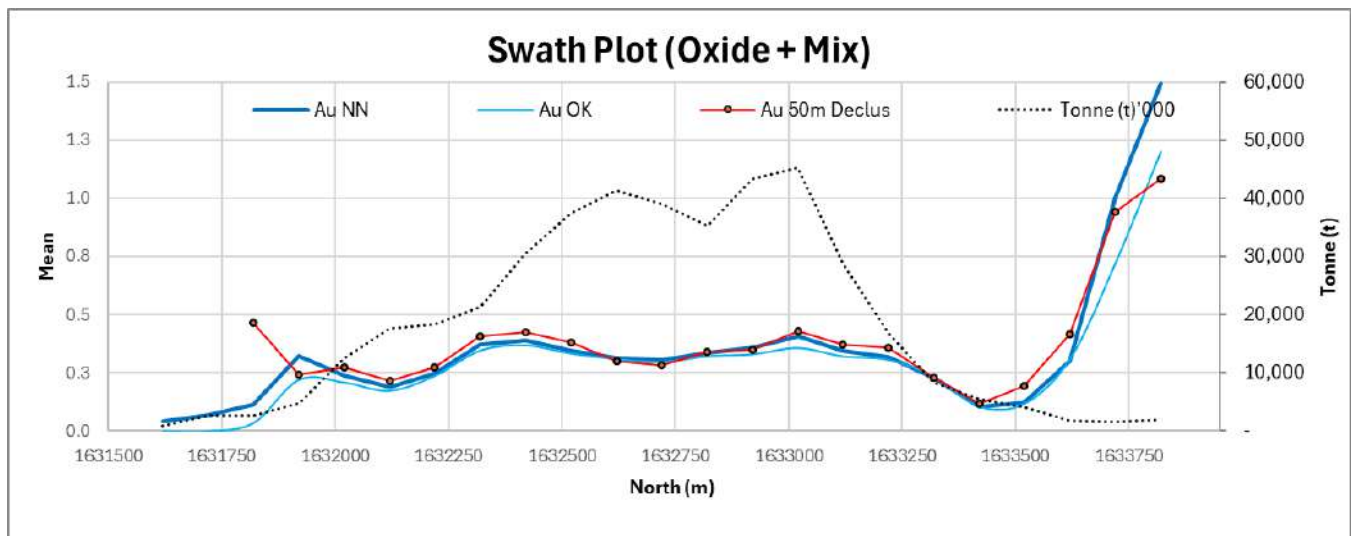


Figure 14-26: Swath Plot Northing: Drill Hole Grades, OK and NN Grade Estimation



SLR observed a high grade area at the north in Buffa generated by high-grade intercepts of drill holes MO-15-47, MC-20-94, MC-20-93 and MC-20-95.

It is the SLR QP's opinion that the block grade distributions were found to be a reasonable correlation for the composite grade distributions, kriged, and NN estimates in all three swath plots. Typical variability of gold grade distribution was observed in lower-density portions of the Mineral Resource and in the edges of the Resource model due to lower data density.

14.10.4 Comparison between the 2024 Resource Model and Blast Hole Block Model

The undiluted grade control model (the Blast Hole Block Model or BH Model) was generated using all the available production data. The comparison of the BH Model to the 2024 Resource



Model, using a 0.214 Au g/t cut-off grade, is provided in Table 14-14. The BH Model estimation applies 5 g/t Au capping.

The grade and tonnes comparison and contained ounces comparisons are provided by elevation in Figure 14-27 and Figure 14-28, respectively. The comparison between production data (blast hole model) and the resource block model at 0.214 Au g/t cut-off shows a 15% positive difference in gold grade and a 9% positive difference in contained ounces.

Table 14-14: Mineral Resource Model Comparison with Production Data

Au > 0.214	Tonne (000 t)	Grade (g/t Au)	Ounces (000)
2024 Resource Model	113,163	0.45	1,624
BH Model	107,651	0.51	1,773
Ratio BH Model / Resource Model	95%	115%	109%

Figure 14-27: Grade and Tonnes Comparison between 2024 Resource Model vs. Blast Hole Block Model

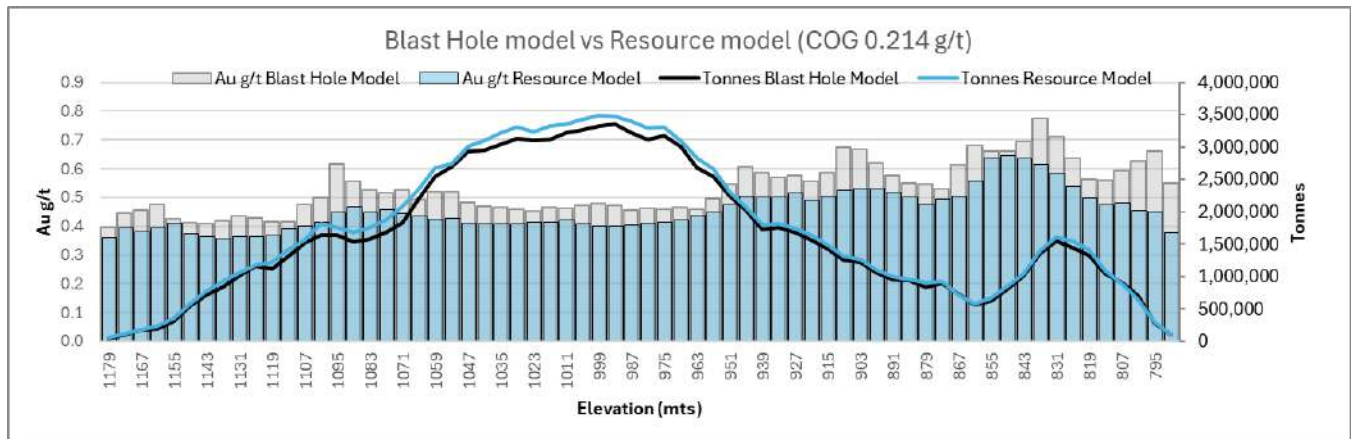


Figure 14-28: Contained Metal Comparison between 2024 Resource Model vs. Blast Hole Block Model

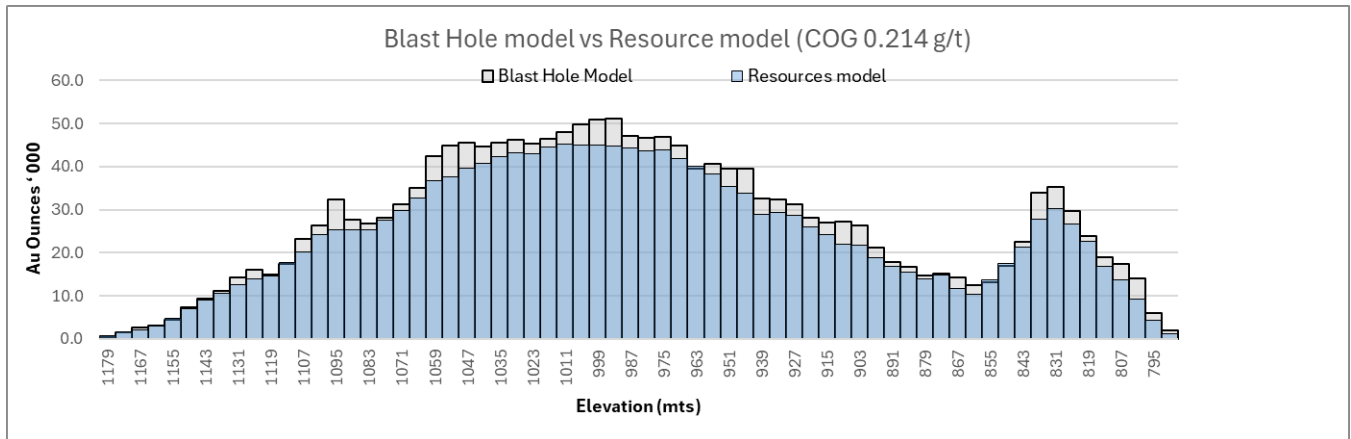
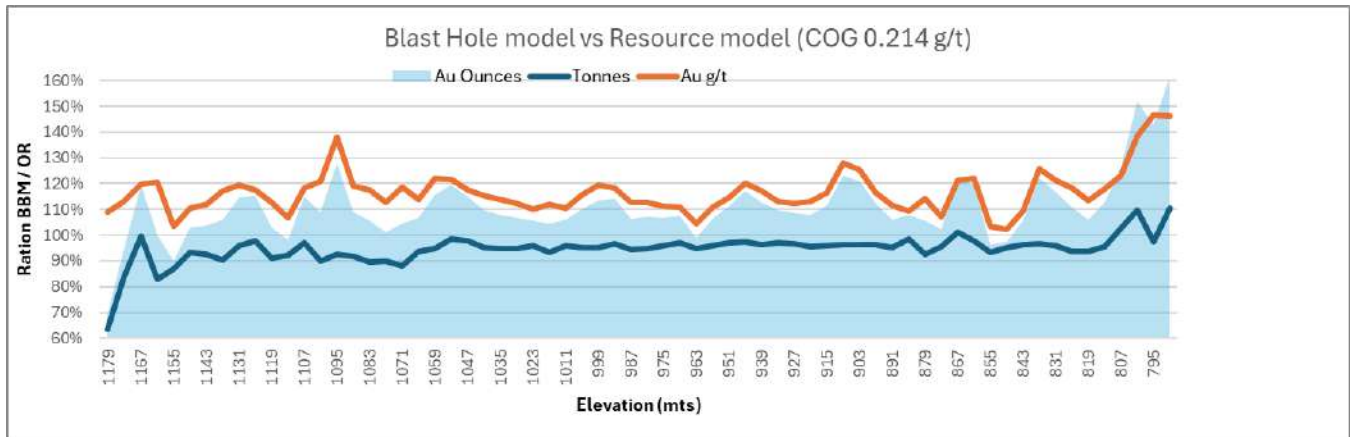


Figure 14-29: Tonnes, Grade, and Contained Metal Comparison between 2024 Resource Model vs. Blast Hole Block Model



14.10.5 Comparison between Exploration and Production Data

SLR compared the exploration drill hole data and blast hole (BH) production data and found that the production data showed higher values. The comparison used samples that were within 5 m of each other. RC and DD samples were composited at 6 m, similar in length to the blast holes.

The comparison between production BH data with RC data shows that the production data gold grade is approximately 15% higher than that seen in the RC data. In the grade range of 0.5 g/t Au to 1.5 g/t Au the positive bias is approximately 10%; over 1.5 g/t Au the positive bias is approximately 20%.



Figure 14-30: Production BH vs. RC Hole Comparison - Histogram at 5 m Distances and Mean Comparison at Various Sample Separation Distances

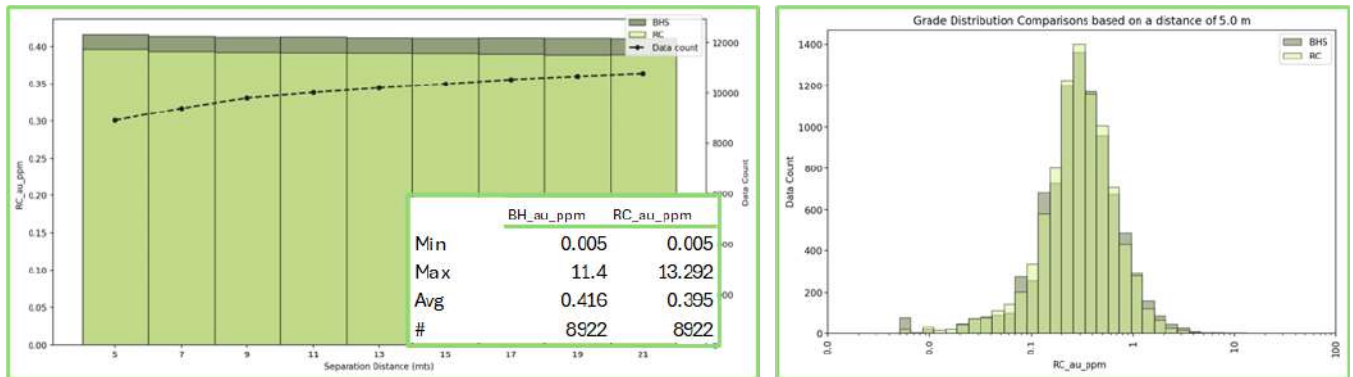
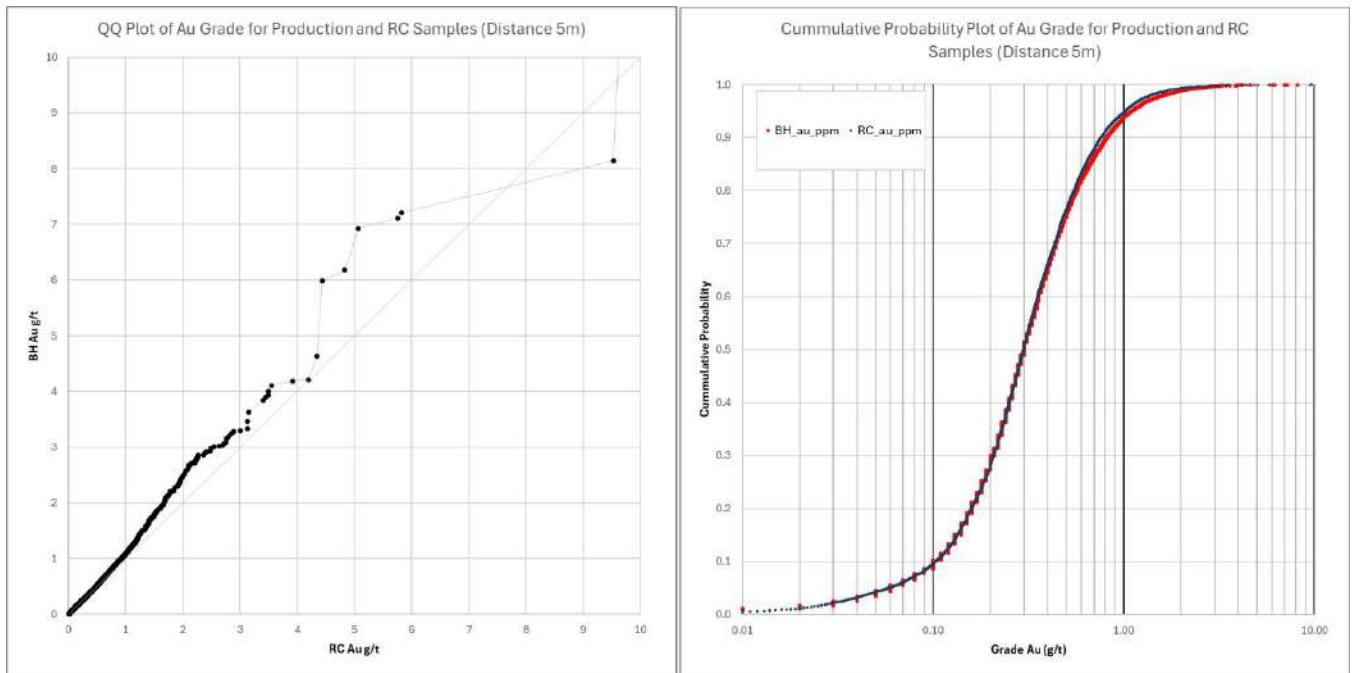


Figure 14-31: Production BH vs. RC Hole Comparison - QQ Plot and Cumulative Probability Plot



The comparison between the production BH data and DD data shows that the production data gold grade is 7% higher. In the grade range of 0.5 g/t Au to 1.5 g/t Au, the positive bias was approximately 10%; over 1.5 g/t Au the difference was larger.



Figure 14-32: Production BH vs. DD Hole Comparison - Histogram at 5 m Distances and Mean Comparison at Various Sample Separation Distances

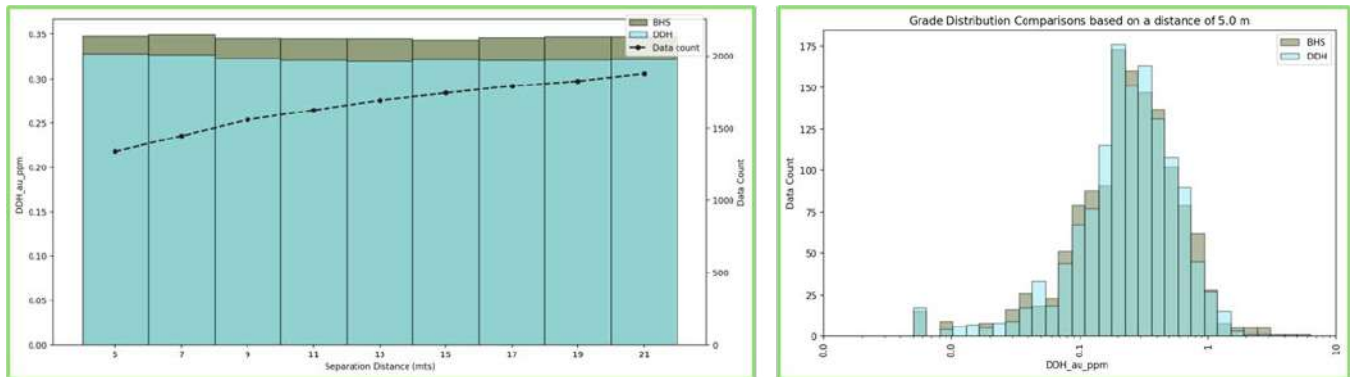
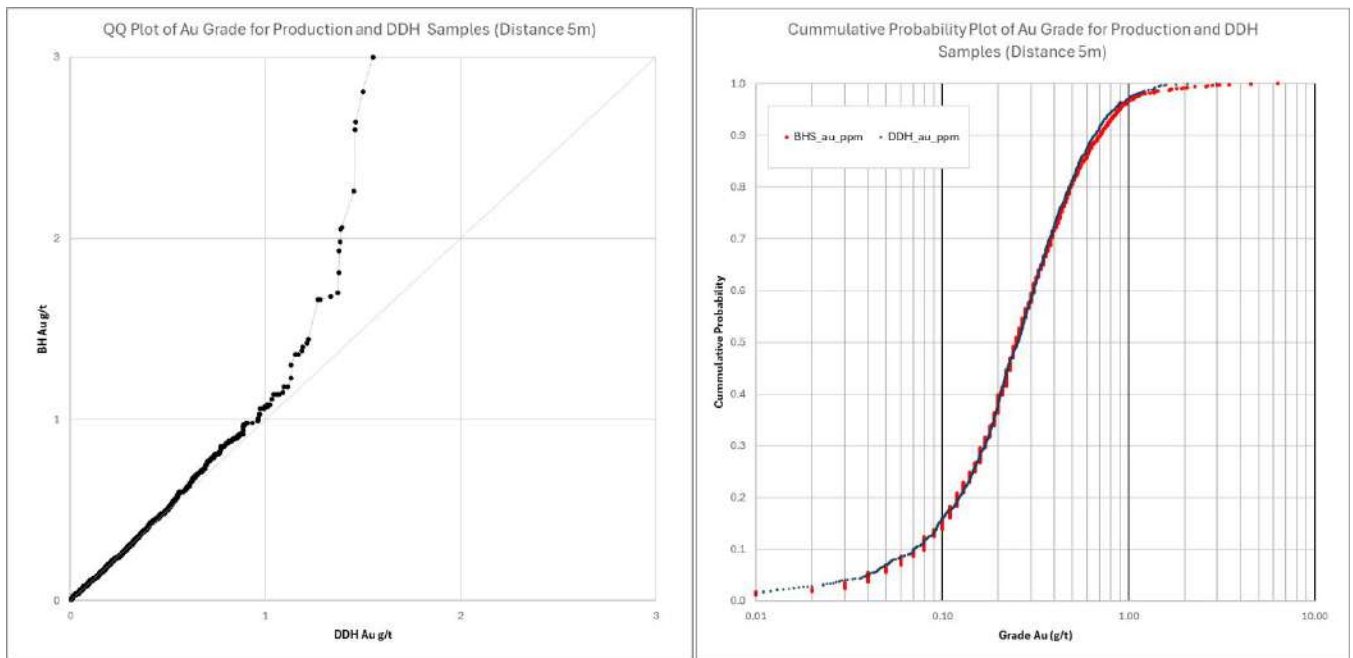


Figure 14-33: Production BH vs. DD Hole Comparison - QQ Plot and Cumulative Probability Plot



SLR also compared the RC and DD drill hole data. This comparison showed that the gold grade in the RC drilling was higher than the DD data in all grade ranges; however, based on the low number of paired data (238) between data sets, the comparison is not statistically valid. However, the analysis of the differences between RC and DD should continue.



Figure 14-34: RC vs. DD Hole Comparison - Histogram at 5 m Distances and Mean Comparison at Various Sample Separation Distances

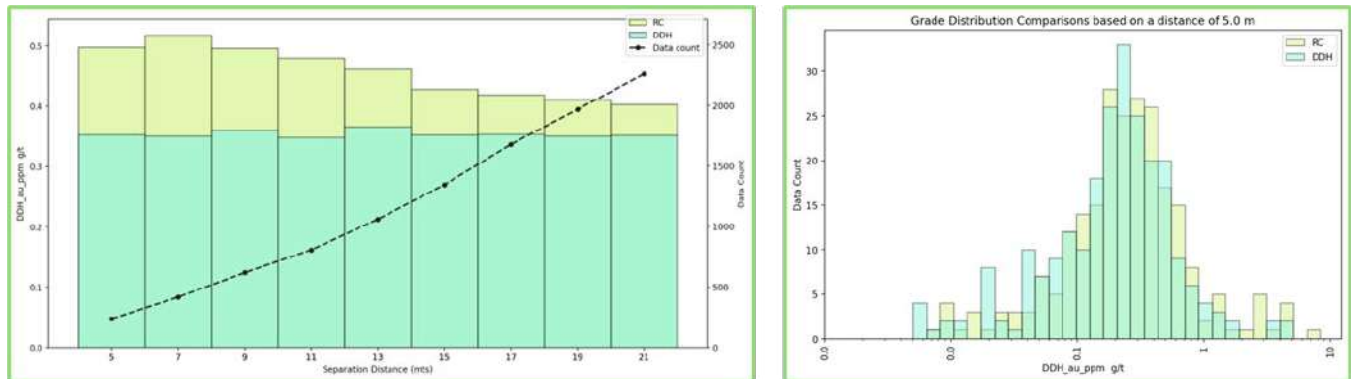
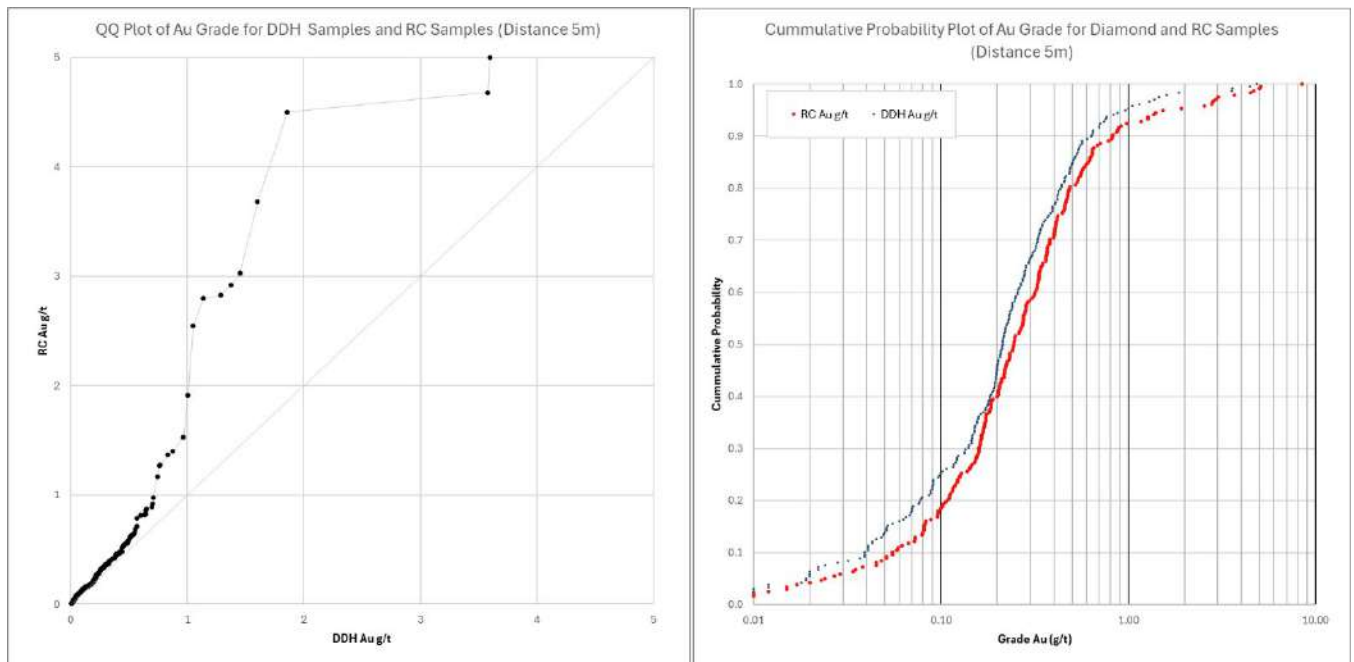


Figure 14-35: RC vs. DD Hole Comparison - QQ Plot and Cumulative Probability Plot



In summary, SLR observed that the BH grade is higher than that of the RC drill holes, which is higher than the DD hole grade, i.e., BH Au g/t > RC Au g/t > DD Au g/t.

The SLR QP recommends investigating the sampling bias among hole types used in the resource model, with particular emphasis on evaluating the potential positive bias of blast holes relative to RC and DD holes as well as the positive bias of RC relative to DD samples.

14.10.6 Production Reconciliation – 2010 to 2024

From 2010 to 2024, the comparison between actual gold ounces production and the estimated gold ounces from the process plant shows a 99.5% correlation (actual ounces / estimated ounces). In the last five years, from 2020 to 2024, this comparison was 102.5%. These comparisons show a good correlation between actual gold production and the process plant.



The grade control model and the process plant were also compared as part of the reconciliation process. From 2010 to 2024, the comparison shows a 96.3% correlation (Ore to Pad/ Ore Mined). In the last five years, from 2020 to 2024, this comparison is 99.8%.

The production data was delivered by Minosa process team.

Figure 14-36: Estimated Recovered Gold Ounces vs Production Ounces 2010 to 2024

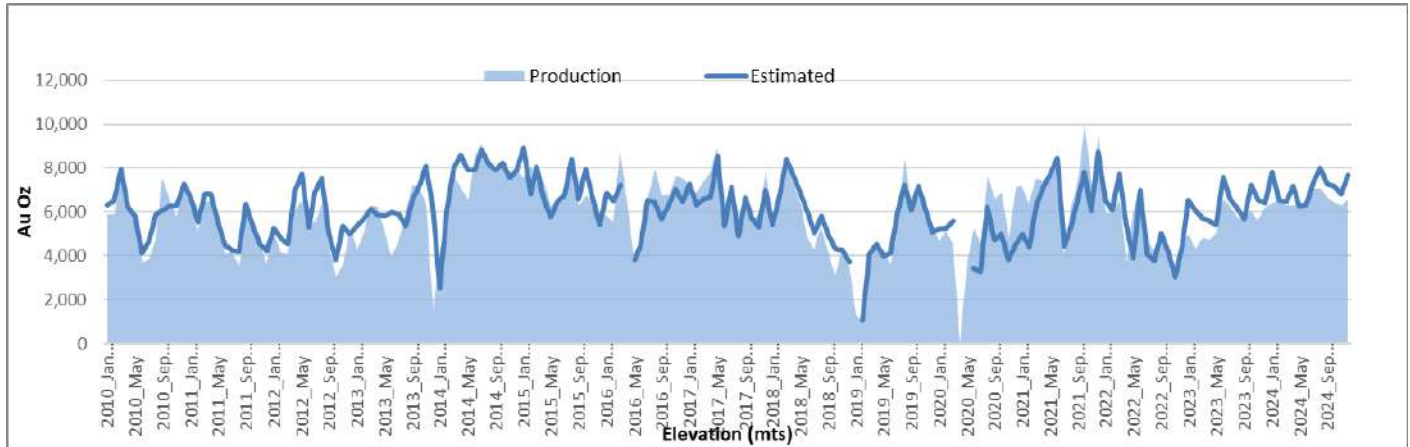


Figure 14-37: Reconciliation Trend from 2010 to 2024 of Process Plant vs. Ore Mined (Tonnes, Gold Grade, and Ounces)

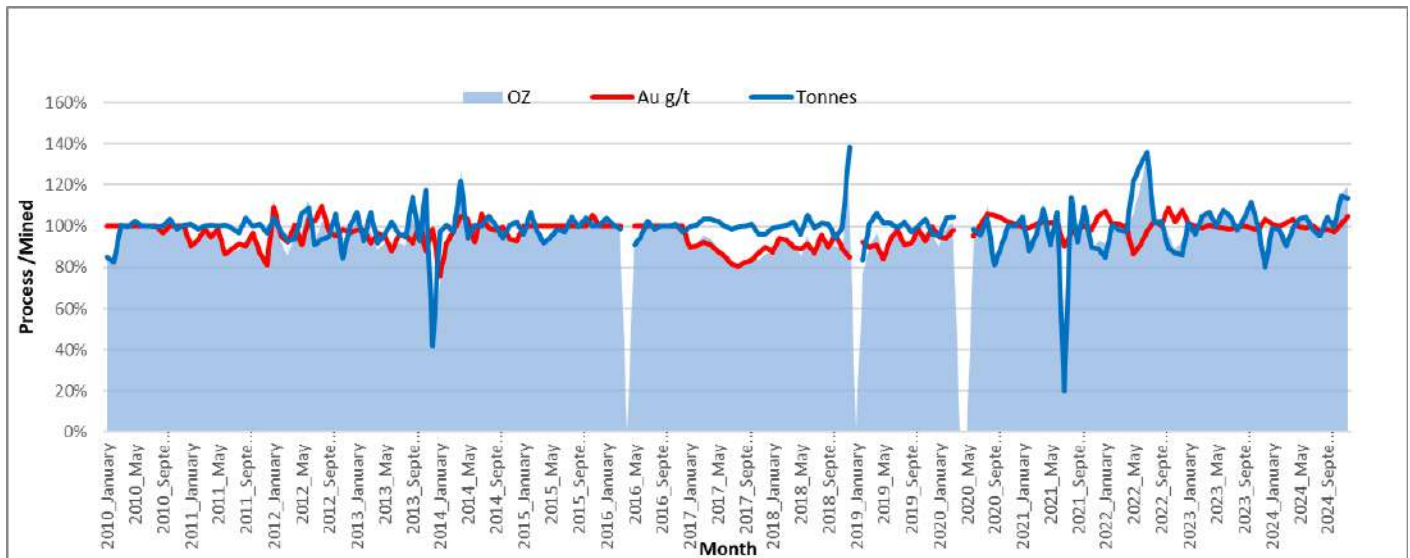


Table 14-15: Reconciliation of Grade Control, Process Plant and Gold Production

Year	Ore Mined (Grade Control)			Ore to Pad (Process Plant)			Estimated Gold Recovery		Gold Sales (000 oz)	Gold Prod. (000 oz)
	Tonnage (000 t)	Grade (g/t Au)	Contained Metal (000 oz Au)	Tonnage (000 t)	Grade (g/t Au)	Contained Metal (000 oz Au)	Recovery (%)	Contained Metal (000 oz Au)		
2010	4,914	0.72	114	4,781	0.72	111	66	73	70	71
2011	4,313	0.74	102	4,302	0.68	94	69	65	66	61
2012	4,373	0.64	89	4,264	0.63	86	79	68	53	60
2013	5,465	0.59	103	5,370	0.56	96	77	74	65	64
2014	6,151	0.48	94	6,167	0.46	92	98	90	85	89
2015	6,202	0.49	99	6,149	0.49	98	86	84	85	84
2016	6,531	0.47	100	6,459	0.47	98	68	67	75	78
2017	6,693	0.45	98	6,699	0.39	85	91	77	80	82
2018	6,042	0.47	91	6,065	0.42	83	83	69	67	64
2019	5,178	0.51	86	5,173	0.48	79	70	55	59	58
2020	4,114	0.54	71	4,005	0.54	70	68	47	57	61
2021	5,744	0.56	103	5,611	0.56	101	77	78	90	88
2022	5,442	0.49	85	5,485	0.49	86	71	61	63	61
2023	7,096	0.45	102	7,096	0.45	102	74	76	66	66
2024	8,454	0.44	118	8,545	0.44	120	71	85	79	78
2010 to 2024	86,714	0.52	1,455	86,174	0.51	1,401	76	1,070	1,061	1,065

It is the SLR QP’s opinion that the review between actual gold ounces produced, the expected gold ounces from the process plant, and the ore dispatched from the mine from 2010 to 2024 shows good performance. Also, the review indicates that the blast hole samples are reliable.

14.10.7 Comparison between the 2024 Block Model and 2023 Block Model

SLR compared the grade and tonnages from the 2024 and 2023 block models within the resource pit (Figure 14-38). The 2023 block model shows a significant break in grade and tonnage at 0.15 g/t Au cut-off grade associated with the grade shell used in the estimation; the 2024 estimation management better the grade shell in the estimation and show smooth variation and 0.15 Au g/t between the model of 2023 and 2024. The comparison between the 2024 and 2023 block models shows a significant difference in metal in the low grade range (0 to 0.5 g/t Au). Table 14-16 shows the 2023 and 2024 block model comparison at different gold cut-off grades within the 2024 resource shell with the original topography.



Figure 14-38: Grade and Tonnage Comparison of the 2024 vs 2023 Block models (within Resource shell using the Original Topography)

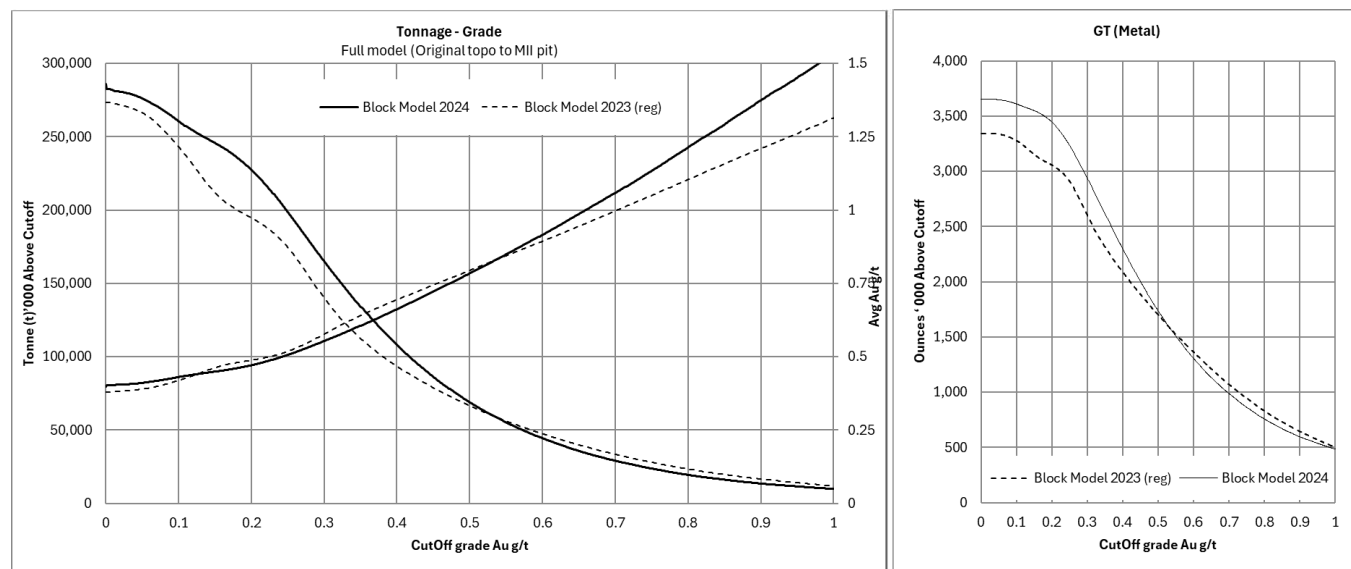


Table 14-16: Comparison between the 2024 and 2023 Block Models (within Resource shell using original topography)

Cut-off (g/t Au)	2024 Block Model (BM)			2023 Block Model (BM)			Difference [(2024 BM – 2023 BM)/2023 BM]		
	Tonnage (000 t)	Grade (g/t Au)	Contained Gold (000 oz)	Tonnage (000 t)	Grade (g/t Au)	Contained Gold (000 oz)	Tonnage (000 t)	Grade (g/t Au)	Contained Gold (000 oz)
0.00	285,924	0.40	3,654	273,465	0.38	3,344	5%	5%	9%
0.10	260,901	0.43	3,610	243,320	0.42	3,279	7%	3%	10%
0.15	245,802	0.45	3,550	212,300	0.46	3,154	16%	-3%	13%
0.20	227,767	0.47	3,447	194,678	0.49	3,057	17%	-4%	13%
0.215	220,137	0.48	3,397	190,242	0.49	3,027	16%	-3%	12%
0.30	165,296	0.55	2,940	140,187	0.58	2,604	18%	-4%	13%
0.335	143,386	0.59	2,717	119,579	0.62	2,394	20%	-5%	13%
0.40	108,267	0.66	2,303	93,708	0.69	2,091	16%	-5%	10%
0.50	68,960	0.78	1,739	66,739	0.79	1,703	3%	-1%	2%
0.60	44,453	0.92	1,309	47,511	0.89	1,365	-6%	2%	-4%
0.70	29,106	1.06	990	33,406	1.00	1,072	-13%	6%	-8%
0.80	19,443	1.21	759	23,425	1.10	832	-17%	10%	-9%
0.90	13,516	1.37	597	16,608	1.21	646	-19%	14%	-8%
1.00	9,871	1.53	486	11,918	1.31	503	-17%	17%	-3%



In the SLR QP’s opinion, the 2024 block model grade and tonnage curve shows a more realistic distribution when comparing the 2024 vs 2023 full block models within the resource pit without depletion, as illustrated in Figure 14-39.

Figure 14-39: Grade and Tonnage Comparison for the 2024 vs 2023 Block model (within Resource shell using YE 2014 topography)

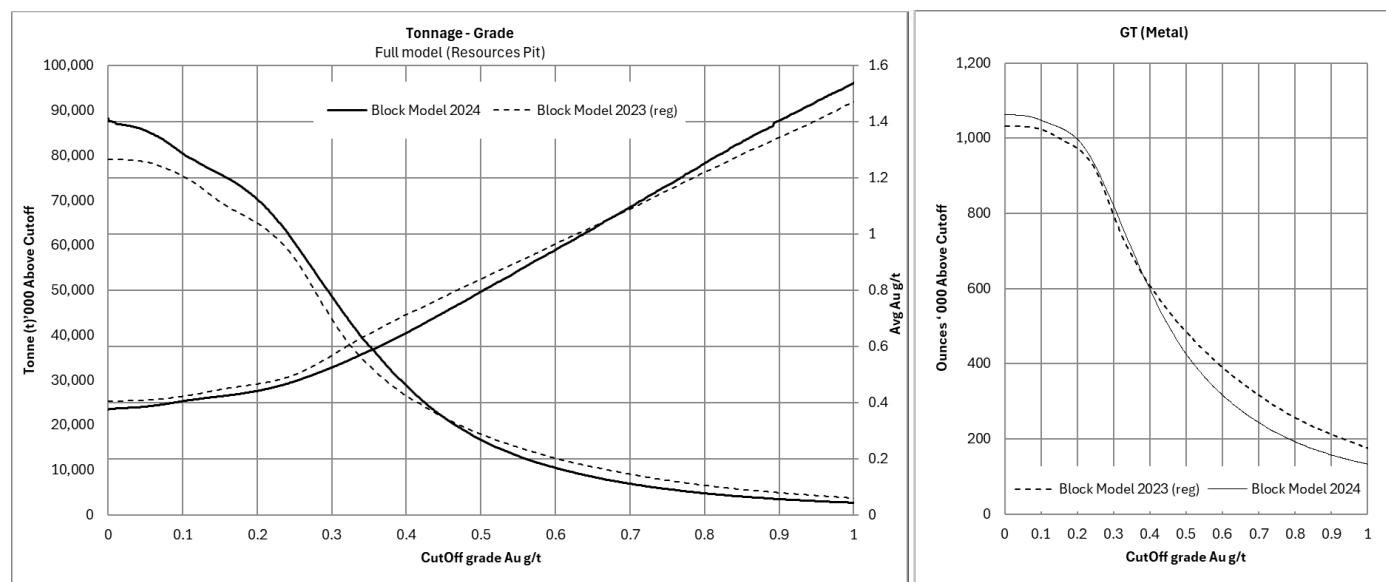


Table 14-17: Grade and Tonnage Comparison for the 2024 vs 2023 Block Models (within Resource shell using December 2024 Topography)

Cut-Off Grade (g/t Au)	2024 Block Model			2023 Block Model			Difference		
	Tonnage (000 t)	Grade (g/t Au)	Contained Gold (000 oz)	Tonnage (000 t)	Grade (g/t Au)	Contained Gold (000 oz)	Tonnes (%)	Grade (%)	Ounces (%)
0	88,342	0.37	1,062	79,156	0.41	1,032			
0.1	80,506	0.40	1,048	75,430	0.42	1,023	7%	-4%	2%
0.15	75,852	0.42	1,029	69,754	0.45	1,000	9%	-5%	3%
0.2	70,376	0.44	998	64,943	0.47	973	8%	-5%	3%
0.215	67,953	0.45	982	63,175	0.47	961	8%	-5%	2%
0.3	48,714	0.52	822	43,562	0.57	796	12%	-8%	3%
0.335	40,803	0.56	741	35,770	0.62	716	14%	-9%	3%
0.4	28,839	0.65	600	26,514	0.71	608	9%	-9%	-1%
0.5	16,674	0.80	426	17,988	0.84	486	-7%	-5%	-12%
0.6	10,439	0.94	317	12,594	0.96	391	-17%	-2%	-19%
0.7	6,931	1.10	244	9,053	1.09	317	-23%	1%	-23%
0.8	4,795	1.25	193	6,544	1.22	257	-27%	3%	-25%



Cut-Off Grade (g/t Au)	2024 Block Model			2023 Block Model			Difference		
	Tonnage (000 t)	Grade (g/t Au)	Contained Gold (000 oz)	Tonnage (000 t)	Grade (g/t Au)	Contained Gold (000 oz)	Tonnes (%)	Grade (%)	Ounces (%)
0.9	3,479	1.40	157	4,909	1.34	212	-29%	4%	-26%
1	2,692	1.54	133	3,729	1.47	176	-28%	5%	-24%

14.11 Bulk Density

The density database contains 15,374 measurements, which were collected by Greenstone from 1997 to 1998 and by Aura from 2015 to 2023, with an average of 2.38 g/cm³. Simple kriging was used to estimate the density by lithology.

Waste stock material is assigned an average density of 1.8 g/cm³ regardless of lithology.

The SLR QP recommends continuing to use simple kriging to estimate density but incorporating a global mean to reduce the local variations.

14.12 Cut-off Grade

Metal prices used for Mineral Reserves are based on consensus, long term forecasts from banks, financial institutions, and other sources. For Mineral Resources, metal prices used are slightly higher than those for Reserves. The parameters for calculating the cut-off grade for estimating Mineral Resources are presented in Table 14-18.

All other assumptions including slope angles, and other costs that are used in the pit shell optimization are considered the same for both resources and reserves and are summarized in Section 15.4 of this Technical Report.

Table 14-18: Resources Cut-off Parameters

Parameter	Resources December 2023 in AIF 2024	Resource December 2024
US\$/oz	1,900	2,200
Mining Cost Ore (\$/t moved)		2.44
Processing Cost (&/t processed)		6.27
G&A cost (\$/t processed)		1.88
Royalty (%/Selling Price)		5
Dilution (%)		0
Mining Recovery (%)		100
Cut-off Grade – Oxide		
Gold Metallurgical Recovery (%)	72	70
Cut-off Grade (g/t Au)	0.21	0.19
Cut-off Grade – Mixed		
Gold Metallurgical Recovery (%)	54	45



Parameter	Resources December 2023 in AIF 2024	Resource December 2024
Cut-off Grade (g/t Au)	0.27	0.29
Notes: AIF Annual Information Form (Aura 2024c)		

14.13 Classification

Definitions for resource categories used in this Technical Report are consistent with those defined by CIM (2014) and adopted by NI 43-101. In the CIM classification, a Mineral Resource is defined as “a concentration or occurrence of solid material of economic interest in or on the Earth’s crust in such form, grade or quality and quantity that there are reasonable prospects for eventual economic extraction”. Mineral Resources are classified into Measured, Indicated, and Inferred categories. A Mineral Reserve is defined as the “economically mineable part of a Measured and/or Indicated Mineral Resource” demonstrated by studies at Pre-Feasibility or Feasibility level as appropriate. Mineral Reserves are classified into Proven and Probable categories.

The Esperanza Alto and Esperanza Bajo variogram range and the distance to mine production were used in the classification criteria.

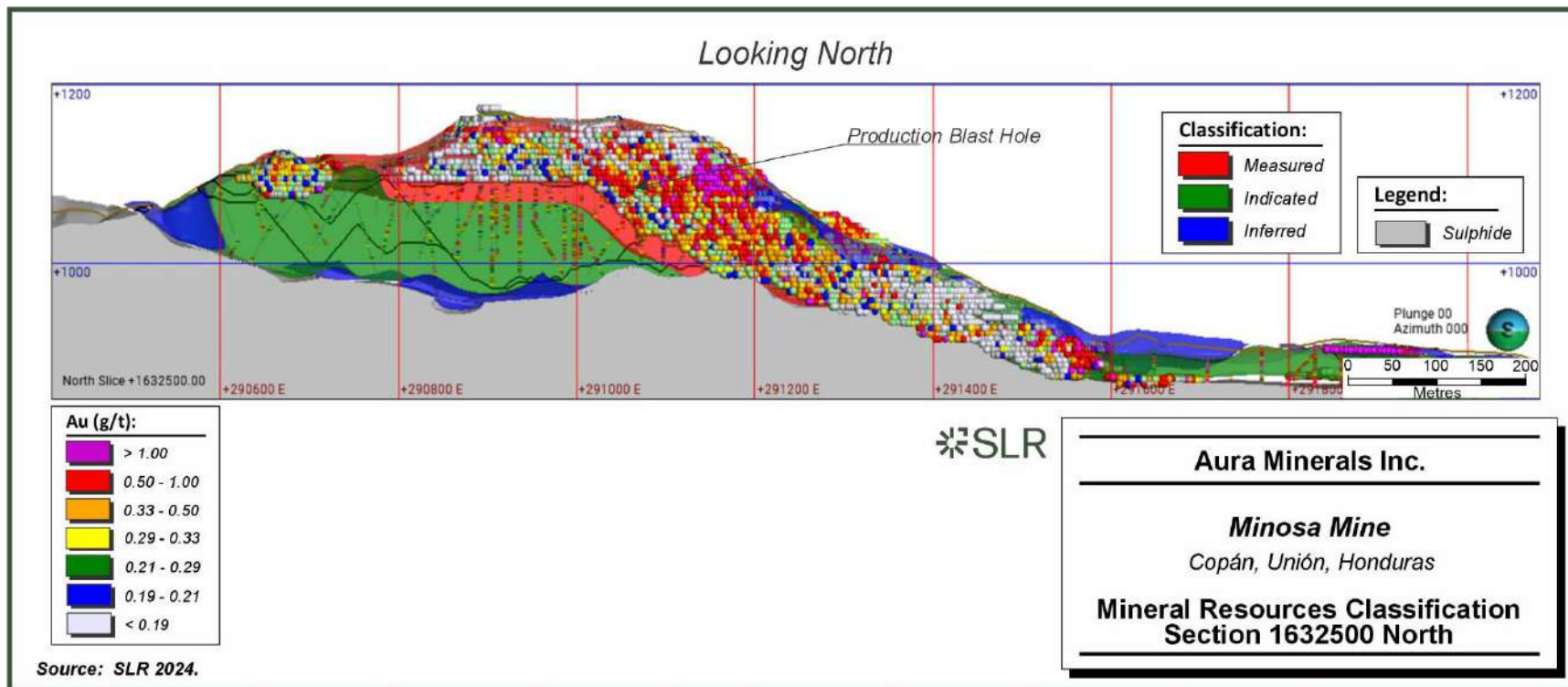
For oxide and mixed mineralization, the following classification criteria were based on the Esperanza Alto and Esperanza Bajo variogram ranges as well as the distance to recent mine production (i.e., 2023 or 2024 mining areas). These classification criteria are listed:

- Measured classification: Blocks with a drill hole spacing (DHS) of up to 50 m (the full variogram range) and located within 25 m of recent mine production from 2023 and 2024. Most of the measured blocks (90%) fall within a 35-m DHS.
- Indicated classification: Blocks with a DHS of 50 m (full variogram range) and located outside of the 25 m of recent mine production from 2023 and 2024.
- Inferred classification: Blocks with a DHS between 50 m to 100 m (double full variogram range).

The Mineral Resource and Mineral Reserve estimates exclude all sulphide material, as gold recovery from this material is currently not economically viable. Figure 14-40 shows a section view of the Mineral Resources classification.



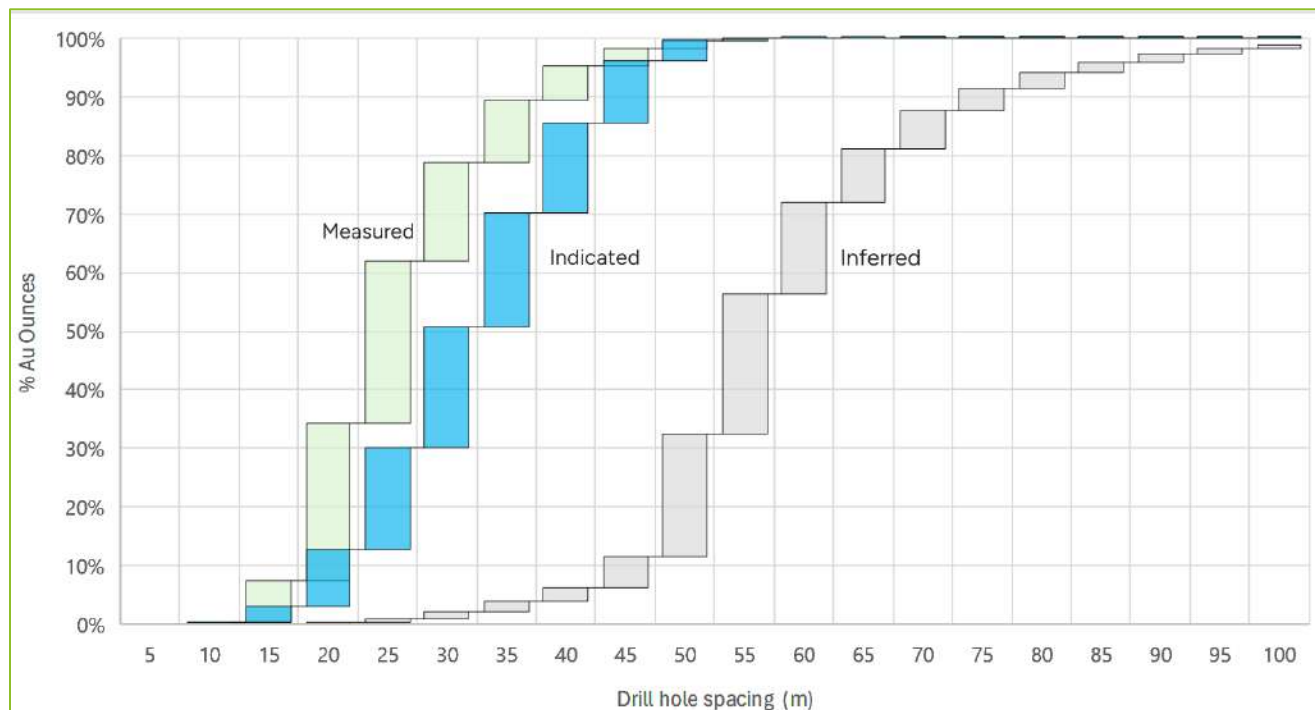
Figure 14-40: Mineral Resources Classification. Section 1632500 North



The classification validation (Figure 14-41) shows that 90% of the Measured ounces are within 35 m DHS, 90% of the Indicated ounces are within 45 m DHS, and 90% of the Inferred blocks are within 80 m DHS.

In the SLR QP’s opinion, the DHS, based on the variogram ranges applied in the classification, is appropriate for this deposit type and its associated variography. A post processing classification solid was generated to remove isolated small patches and irregular shapes, yielding more realistic shapes from a mining perspective.

Figure 14-41: Percentage of Contained Gold vs Drill Hole Spacing by Classification



14.14 Mineral Resource Reporting

Mineral Resources have been classified in accordance with CIM (2014) definitions.

Table 14-19 summarizes the San Andrés Mine Mineral Resource estimate, inclusive of Mineral Reserves, as of December 31, 2024.

Table 14-19: Summary of Mineral Resource Estimate, Inclusive of Mineral Reserves – December 31, 2024

Category	Oxide			Mixed			Total		
	Tonnage (000 t)	Au (g/t)	Contained Gold (000 oz)	Tonnage (000 t)	Au (g/t)	Contained Gold (000 oz)	Tonnage (000 t)	Au (g/t)	Contained Gold (000 oz)
Measured	10,402	0.36	119	1,115	0.60	22	11,516	0.38	140
Indicated	42,459	0.43	580	5,074	0.62	100	47,533	0.45	681



Category	Oxide			Mixed			Total		
	Tonnage (000 t)	Au (g/t)	Contained Gold (000 oz)	Tonnage (000 t)	Au (g/t)	Contained Gold (000 oz)	Tonnage (000 t)	Au (g/t)	Contained Gold (000 oz)
Measured + Indicated	52,861	0.41	699	6,189	0.61	122	59,049	0.43	821
Inferred	6,921	0.42	94	1,629	0.56	29	8,550	0.45	123

Notes:

1. Mineral Resources are reported inclusive of Mineral Reserves.
2. CIM (2014) definitions were followed for Mineral Resources.
3. The Mineral Resource estimate is reported on a 100% ownership basis.
4. Mineral Resources are contained within a pit shell and are estimated in situ.
5. Mining dilution, mining losses, or process losses were not applied in estimating Mineral Resources.
6. Mineral Resources are estimated at a cut-off grade of 0.187 g/t Au Oxide and 0.291 g/t Au Mixed.
7. Metallurgical recovery is 70% for oxide material and 45% for mixed material.
8. Mineral Resources are estimated using a long-term gold price of US\$2,200 per ounce.
9. A minimum mining width of 6 m was used.
10. Bulk density is estimated by lithology and averages 2.38 g/cm³.
11. Mineral Resources that are not Mineral Reserves do not have demonstrated economic viability.
12. Numbers may not add due to rounding.

Table 14-20 summarizes the San Andrés Mine Mineral Resource estimate, exclusive of Mineral Reserves, as of December 31, 2024.

Table 14-20: Summary of Mineral Resource Estimate, Exclusive of Mineral Resources – December 31, 2024

Category	Oxide			Mixed			Total		
	Tonnage (000 t)	Au (g/t)	Contained Gold (000 oz)	Tonnage (000 t)	Au (g/t)	Contained Gold (000 oz)	Tonnage (000 t)	Au (g/t)	Contained Gold (000 oz)
Measured	1,070	0.27	9	387	0.54	7	1,457	0.34	16
Indicated	21,136	0.38	256	3,082	0.55	54	24,218	0.40	310
Measured + indicated	22,206	0.37	265	3,469	0.54	61	25,675	0.40	326
Inferred	6,921	0.42	94	1,629	0.56	29	8,550	0.45	123

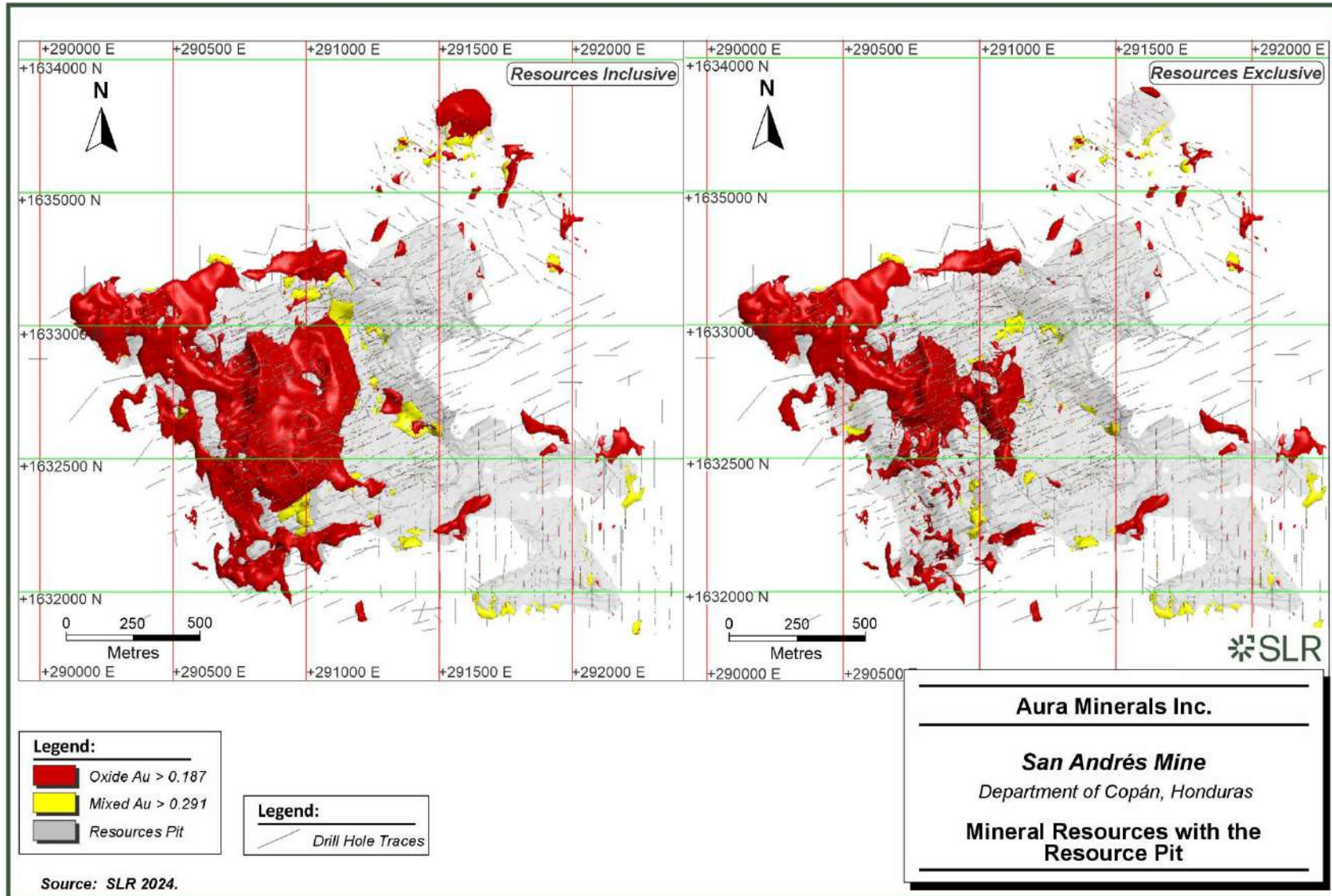
Notes:

1. Mineral Resources are reported exclusive of Mineral Reserves.
2. See Notes 2 through 12 of Table 1-1.

The QP is not aware of any environmental, permitting, legal, title, taxation, socio-economic, marketing, political, or other relevant factors that could materially affect the Mineral Resource estimate.



Figure 14-42: Mineral Resources with the Resource Pit



14.14.1 Sources of Uncertainty

Mineral Resources are not Mineral Reserves and do not have demonstrated economic or process viability, nor is there any certainty that all or any part of the Mineral Resource estimate will be converted to Mineral Reserves through further study.

The SLR QP has identified four technical and/or economic factors that require further attention.

- While the boundaries between oxide/mixed and sulphide materials are considered acceptable, they lack robustness due to the exclusion of the AuCN/Au ratio. The current boundary definitions may impact the accuracy of metallurgical and operational predictions.
- Given the increasing incorporation of mixed material into the mine plan in recent years, a more precise definition of this material type is warranted. Currently, there is considerable uncertainty, as this zone exhibits variability and is defined solely through geological logging.
- With mining operations approaching areas containing sulphide material, accurately defining this boundary is critical to ensuring effective planning and processing strategies.
- A comparison of production blast hole (BH) data with RC data indicates a positive bias of 15% in gold (Au) grades. This presents an opportunity to enhance the grade estimation in the Mineral Resource model. To better understand the observed discrepancies, further in-depth sampling and reconciliation studies are recommended.

14.14.2 Comparison to Previous Mineral Resource Estimate

The current inclusive Mineral Resource estimate for the Minosa deposit has been compared to Aura's 2023 update presented in their AIF, as summarized in Table 14-21

The 2024 revision includes metal prices of US\$2,200/oz Au, an increase from the US\$1,900/oz Au, and reduction in gold recovery to 70% Oxide and 45% Mixed from 72% Oxide and 54% Mixed. The contained gold decreased by 21% in the Measured category, 15% in the Indicated category, and by 9% in the Inferred category. The reduction in Mineral Resources is principally related to the depletion in 2024, modification in the estimation strategy, reduction in recovery, and adjustment in the sulphur limit.

Overall Measured and Indicated tonnage decreased by 1% and Inferred tonnage expanded by 50%, The average gold grade decreased by 26% for Measured Mineral Resources, by 13% for Indicated Mineral Resources, and by 39% for Inferred Mineral Resources.

Table 14-21: 2023 and 2024 Mineral Resource Comparison at Minosa

Category	2023			2024			Δ		
	Tonnage (000 t)	Grade (g/t Au)	Contained Gold (000 oz)	Tonnage (000 t)	Grade (g/t Au)	Contained Gold (000 oz)	Tonnage %	Grade %	Contained Gold %
Measured	10,924	0.51	178	11,516	0.38	140	5%	-26%	-21%
Indicated	48,485	0.51	800	47,533	0.45	681	-2%	-13%	-15%
M + I	59,408	0.51	978	59,049	0.43	821	-1%	-15%	-16%
Inferred	5,693	0.74	136	8,550	0.45	123	50%	-39%	-9%

Notes:

1. Mineral Resources are reported inclusive of Mineral Reserves.



2. CIM (2014) definitions were followed for Mineral Resources.
3. The Mineral Resource estimate is reported on a 100% ownership basis.
4. Mineral Resources are contained within a pit shell and are estimated in situ.
5. Mining dilution, mining losses, or process losses were not applied in estimating Mineral Resources.
6. A minimum mining width of 6 m was used
7. The Mineral Resource estimate does not include any sulphide material
8. For YE2024, Mineral Resources are estimated using a long-term gold price of US\$2,200 per ounce, a cut-off grade of 0.187 g/t Au for Oxide material and 0.291 g/t Au for Mixed material, a metallurgical recovery of 70% for oxide material and 45% for mixed material, and using surface topography as of December 31, 2024, with a 50 m river offset restriction imposed. The bulk density is estimated by lithology and averages 2.38 g/cm³.
9. For YE2023, Mineral Resources are estimated based on an optimized pit shell using US\$1,900 per ounce, a cut-off grade of 0.21 g/t Au for Oxide material and 0.27 g/t Au for Mixed material, a metallurgical recovery of 72% for oxide material and 54% for mixed material, and using surface topography as of December 31, 2023, with a 200 m river offset restriction imposed. The bulk density is estimated by lithology and averages 2.38 g/cm³. A density model based on rock type was used for volume to tonnes conversion; the average bulk density was 2.34 g/cm³.



15.0 Mineral Reserve Estimates

15.1 Summary

The Mineral Reserve estimation for the San Andrés Mine was conducted using the Pseudoflow optimization methodology, incorporating detailed block models and applying appropriate modifying factors such as mining dilution, recovery, and pit design parameters. The final pit limits are constrained by multiple factors including geotechnical considerations, property boundaries, and environmental buffers. Notably, the eastern extent of the pit is limited by the proximity of the Río Lara, which serves as a natural constraint and was incorporated into the pit design to ensure compliance with environmental regulations and minimize hydrological impact.

The Mineral Reserve estimation is based on a block model exported from Leapfrog Geo (LongTerm_Nov2024.bmf). The model uses a 10 m x 10 m x 6 m parent block size without sub-blocking. It is unrotated, with an azimuth of 0°, dip of 0°, and pitch of 0°. The model extents are outlined in Table 11-9. The block model includes attributes for classification, lithology, mineralogy, density, and other relevant parameters, which were incorporated into the Pseudoflow optimization process to define the Mineral Reserves.

To ensure a robust reserve estimation, the optimization was conducted using multiple revenue factors, allowing for the assessment of economic sensitivity across different price scenarios. Additionally, the Pseudoflow optimization results were cross-checked against pit shells generated using Whittle’s Lerch-Grossmann algorithm. The comparison confirmed that both methodologies produced consistent and comparable results, supporting the reliability of the reserve estimation.

The Mineral Reserve estimate is based on key operational and economic parameters that define the viability of the open pit design. These include:

- Cut-off grades: Defined separately for oxide and mixed material, as outlined in Table 15-2.
- Metallurgical recoveries: Set at 70% for oxides and 45% for mixed materials, based on historical processing performance.
- Commodity pricing assumptions: Reserves were estimated using a gold price of US\$2,000/oz, consistent with industry forecasts and economic analysis.

Classification of Mineral Reserves was completed following CIM (2014) definitions, ensuring that all relevant modifying factors—including geotechnical, environmental, metallurgical, and economic considerations—were applied to classify Proven and Probable Reserves.

The open pit design criteria used for reserve estimation are summarized in Table 15-1. These parameters were determined based on geotechnical assessments and operational constraints.

Table 15-1: Open Pit Main Design Parameters

Parameters	Value
Bench height	6 m
Road width	14 m
Overall Pit Slope	31 - 45
Bench face angle	55 – 60



Parameters	Value
Minimum pit bottom	20 m
Berm width	4.0 m
Ramp Slope	12%

The cost parameters used for Mineral Reserve estimation and mine planning are outlined in Table 15-2. These estimates reflect current operational costs, adjusted for sustaining capital and economic assumptions.

Table 15-2: Cut-Off Grade Parameters

Parameter	Value
Gold Price (US\$/oz)	2,000
Oxide Recovery	70%
Mixed Recovery	45%
Costs - US\$/t	
Mine	
Mining Cost Ore (\$/t ore moved)	2.44
Mining Cost Waste (\$/t waste moved)	2.55
Mining Cost Waste Fill (\$/t waste fill moved)	1.84
Processing (\$/t ore processed)	6.27
G&A (\$/t ore processed)	1.88
Sustaining cost/ton ore (Mine)	0.06
Sustaining cost/ton ore (process)	0.25
Royalty (%)	5%

The Mineral Reserve estimate, effective as at December 31, 2024, is summarized in Table 15-3, and the ultimate pit is illustrated in Figure 15-1 below. All Measured and Indicated Mineral Resources within the optimized pit shell, and meeting the applicable cutoff grades and modifying factors, were converted to Mineral Reserves. Specifically, 100% of the Measured Resources were converted to Proven Reserves and 100% of the Indicated Resources were converted to Probable Reserves. No Measured Resources were downgraded to Probable, and no Inferred Resources were included in the reserve estimate.

Table 15-3: Summary of Mineral Reserve Estimate – December 31, 2024

Category	Tonnage (000 t)	Tonnage (000 t)	Grade (g/t Au)	Contained Metal (oz Au)
Proven	Oxide	8,206	0.36	93,977
	Mixed	468	0.50	7,519
Total Proven	-	8,674	0.36	101,495
Probable	Oxide	20,696	0.46	305,410



	Mixed	1,286	0.54	22,282
Total Probable	-	21,981	0.46	327,692
Total Proven + Probable	-	30,655	0.44	429,187

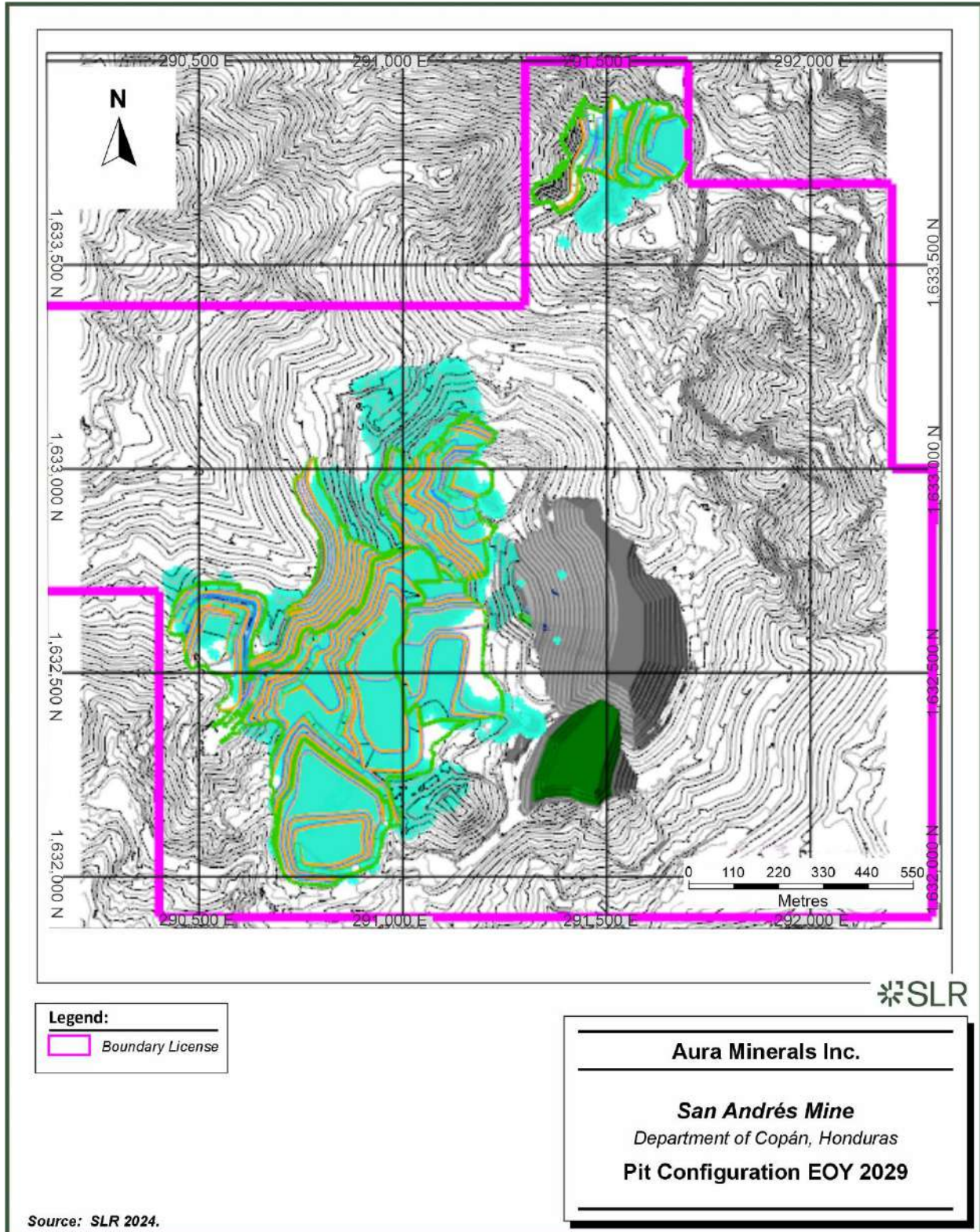
Notes:

1. CIM (2014) definitions were followed for Mineral Reserves.
2. The effective date of the estimate is December 31, 2024.
3. The Mineral Reserve estimate is reported on a 100% ownership basis.
4. Mineral Reserves are estimated using an average long-term gold price of US\$2,000 per ounce
5. Mineral Reserves are reported as Run-of-Mine (ROM) material, after applying dilution (5%), mining recovery (95%), and operational adjustments incorporated into the final pit design. These adjustments include considerations for minimum mining widths, ramp placements, and geotechnical constraints to ensure practical mineability. The applied cut-off grades are 0.215 g/t Au for oxide material and 0.334 g/t Au for mixed material.
6. The bulk density of ore is variable and applied in the geological block model; it averages 2.7 t/m³.
7. The metallurgical recovery is 70% and 45% for Oxides and Mixed materials, respectively.
8. The Mineral Reserve did not consider any sulphide material.
9. The average strip ratio is 0.45:1.
10. Numbers may not add due to rounding.

The QP is not aware of any mining, metallurgical, infrastructure, permitting, or other relevant factors that could materially affect the Mineral Reserve estimate.



Figure 15-1: Final Pit Design



15.2 Dilution

The optimized pit shell for the San Andrés Mine considered a dilution factor of 5%. This parameter is derived from historical reconciliation data, reflecting the Mine's long-standing operational experience and consistent production performance.

Dilution represents the inclusion of waste material into the ore stream during mining, which reduces the average grade of the mined material. At the San Andrés Mine, the 5% dilution is based on the reconciliation of operational data, accounting for typical inaccuracies in blasting, loading, and ore-waste boundary definition. Reconciliation of past production has validated this assumption, indicating reliable control over dilution management.

Effective dilution control at San Andrés is achieved through:

- Optimized drilling and blasting patterns to minimize over-break.
- Advanced grade control programs, such as the use of real-time assays and precise delineation of ore boundaries.
- Continuous operator training to enhance selectivity during excavation.

15.3 Extraction

The mining recovery rate of 95% reflects the portion of in situ ore that can be effectively extracted and delivered to the processing plant. This rate is derived from historical reconciliation data at the Mine, underscoring the Mine's operational efficiency and recovery practices.

This recovery rate accounts for ore losses due to:

- Geotechnical instability in pit walls, which may render some material inaccessible.
- Equipment limitations in certain parts of the orebody with challenging geometry.
- Operational inefficiencies during excavation and haulage.

Based on operational experience, the Mine has developed robust reconciliation methods to track planned versus actual recovery rates. These practices have enabled consistent optimization of recovery factors. In the broader context, mining recovery rates for similar projects typically range from 90% to 98%, with higher rates achieved in stable orebodies with effective operational controls.

At the Mine, recovery is supported by:

- Continuous pit wall monitoring and proactive stabilization measures.
- Deployment of advanced equipment fleets for precise ore extraction.
- Regular reconciliation efforts to ensure alignment between modeled and actual recoveries, further optimizing future recovery estimates.

15.4 Cut-off Grade

The cut-off grade is a key parameter in the estimation of Mineral Reserves, defining the minimum grade at which material is considered economically viable for processing. For the San Andrés Mine, the cut-off grade was calculated using established industry practices, considering operational costs, metallurgical recoveries, and a gold price of US\$2,000/oz.



The optimization and generation of optimized pit shells were conducted directly using the economic parameters within the optimizer. The cut-off grades were subsequently applied only for the interrogation of the solids generated in the optimization process, ensuring accurate classification of economic material.

The cut-off grade (COG) is determined using the formula:

$$CoG = (1 + ovb) * \frac{(Cmf + Cp + Ca + Sust.Capex)}{m * r * (P - Cs) / 31.10348}$$

Where:

- ovb is the dilution in %
- Cmf is the Mining Fixed Cost (Geology, Planning, etc.) in \$/ore t mined
- Cp is the total Processing Costs (Fixed & Variable) in \$/t treated
- Ca is Administration & General (including attributable off-site costs) cost in \$/t treated
- Sust.Capex is the stay in business capital & items of a capital nature in \$/t treated over life of mine (LOM)
- m is the mining recovery factor
- r is the metallurgical recovery (%)
- P is the gold price in \$/oz
- Cs is the cost of selling gold (refining, royalties, Management Fees) in \$/oz

The resulting cut-off grades are:

- Oxide material: 0.214 g/t Au
- Mixed material: 0.334 g/t Au

The calculated cut-off grades ensure that only material capable of generating a net positive cash flow is included in the Mineral Reserve estimates. This approach effectively balances operational costs with expected revenue, ensuring that the final reserve align with realistic economic conditions.

For San Andrés, the differentiation between oxide and mixed ore reflects the varying recoveries and associated costs of processing these materials. The cut-off grades were applied post-optimization during the interrogation of the block model, confirming that the final Mineral Reserve estimates remain economically viable.

15.5 Comparison with Previous Estimate

The current Mineral Reserve estimate for the San Andrés Mine reflects key updates from the previous Mineral Reserve estimate effective as of December 31, 2023, reported in the 2023 AIF (Aura 2024c). The current estimate, with an effective date of December 31, 2024, incorporates updated economic assumptions, refined modifying factors, and operational design adjustments, resulting in a revised reserve base.

Key updates in the current Mineral Reserve estimate are listed:



- Depletion Adjustments: 2024 production accounted for approximately 80 koz of recovered gold, with an in situ depletion of approximately 120 koz, reducing the resource base from 1,109 koz in the 2023 AIF (Aura 2024c) to approximately 999 koz as of December 31, 2024.
- Operational Design Adjustments:
 - A ramp area redesign was implemented to enhance operational efficiency, which resulted in approximately 24 koz of material being left in place and excluded from reserves.
 - Additional adjustments in the haulage network and pit configuration influenced the final mineable tonnage.
- Gold Price Assumption: The December 31, 2023, Reserves were based on a long-term gold price of \$1,700/oz, whereas the updated 2024 reserve estimate uses \$2,000/oz, aligning with current market expectations.
- Reserve Constraints and Conversion: The application of modifying factors, including 95% mining recovery and 5% dilution, was refined based on updated reconciliation data, contributing to an additional reduction in the reserve base.
- Cut-Off Grade Methodology: Unlike the December 31, 2023, reserve estimate fixed cut-off grade approach, the 2024 estimate employs a Pseudoflow optimization process, dynamically integrating economic thresholds.
- Updated Geotechnical and Metallurgical Parameters:
 - Geotechnical refinements were applied to slope designs, impacting the pit shell.
 - Metallurgical recoveries were revised from 72% to 70% for oxide material and 54% to 45% for mixed material, aligning with updated test work and operational reconciliation data. These adjustments reflect refinements in process performance expectations based on recent production data.

Based on these updates, the following changes between the 2023 and 2024 Mineral Reserve estimates are noted:

- Depletion (-120 koz in situ, -80 koz recovered): Reduction due to 2024 production.
- Gold Price Adjustment (+23 koz): A minor increase in Mineral Reserves due to the price adjustment to \$2,000/oz.
- Reserve Constraints and Economic Screening (-35 koz): Stricter modifying factors led to a reduction in reserves.
- Operational Adjustments (-24 koz): Exclusion of material left in the ramp redesign.

Table 15-4: Comparison of 2024 to 2023 Mineral Reserve Estimate

Category	2023 Mineral Reserves	2024 Mineral Reserves	Change
Total Tonnage (kt)	34,512	30,655	-11.1%
Average Gold Grade (g/t Au)	0.50	0.44	-12.0%
Contained Gold (koz)	551	429	-22.1%
Gold Price (US\$/oz)	1,700	2,000	+17.6%



In addition to the changes in the contained gold, the following changes are noted:

- Total tonnage decreased by 11.1%, reflecting refinements in pit design and material classification.
- Average gold grade decreased by 12.0%, reflecting operational constraints, selective ore handling, and the impact of the higher gold price (\$2,000/oz vs. \$1,700/oz used in the 2023 Mineral Reserves), which allowed for the inclusion of lower-grade material while maintaining economic viability.
- Total contained metal decreased by 22.1%, primarily due to the exclusion of non-operational material and depletion from mining.



16.0 Mining Methods

The San Andrés Mine, operated by Minosa, utilizes a conventional open-pit mining method to extract gold-bearing oxide and mixed ore zones. The operation employs standard truck-and-shovel mining techniques, optimized for efficiency and cost-effectiveness. Ore is selectively mined and hauled to the heap leach facility for gold recovery, while waste material is deposited in designated storage areas.

Mining operations are supported by a fleet of excavators, haul trucks, and auxiliary equipment, with bench configurations designed to ensure safe, continuous, and productive operations. The current method focuses on maintaining low operational costs while maximizing ore recovery, in line with the Mine’s economic parameters and life of mine (LOM) plan.

16.1 Geotechnical Studies and Investigations

16.1.1 Geotechnical Investigations

Geotechnical investigations for the San Andrés Mine have been conducted through dedicated borehole drilling, laboratory testing, structural mapping, and numerical modeling to assess rock mass quality, slope stability, and ground control parameters.

16.1.1.1 Geotechnical Drill Holes

A total of six geotechnical boreholes were drilled to characterize rock mass strength, discontinuity conditions, and in situ stress regimes. The boreholes targeted key geotechnical domains, fault zones, and lithological contacts. These boreholes are summarized above in Table 16-6.

16.1.1.2 Rock Mass Classification

The geotechnical characterization classified the rock mass into five geotechnical units (GU) based on lithology, alteration, and rock quality. These GUs are summarized in Table 16-1.

Table 16-1: Summary of Geotechnical Units.

Geotechnical Unit	Lithology	Cohesion (kPa)	Friction Angle (°)	RMR76
GU1	Argillic Rhyolite	50	25	55
GU2	Breccias	80	28	50
GU3	Andesite	120	32	65
GU4	Phyllite	70	26	45
GU5	Silicified Rhyolite	150	34	75

Source: SRK 2021.

Key observations on the GU are listed:

- Rock Quality Designation (RQD): Ranges from 40% (breccias) to 85% (silicified rhyolite).
- Geomechanical conditions: Andesite and silicified rhyolite offer the best stability, while argillic rhyolite and breccias present localized weakness zones.



- Structural controls: Major faults (e.g., Falla A) significantly influence rock mass stability, requiring specific slope design adjustments.

16.1.1.3 Laboratory Testing and Strength Parameters

Comprehensive uniaxial compressive strength (UCS), multiaxial compression (TXT), and direct shear tests were performed to assess intact rock strength, as summarized in Table 16-2.

Table 16-2: Summary of Geotechnical Laboratory Testing and Strength Parameters

Lithology	Number of UCS Tests	Average UCS (MPa)	Standard Deviation (MPa)
Breccia Rhyolite (Silicified)	4	41	24
Breccia Rhyolite (Argillic)	5	3.4	1.1
Rhyolitic Tuff	35	10	5
Red Bed	50	10	6
Andesite	35	25	10

Source: SRK 2021.

16.1.2 Geotechnical Studies

The geotechnical characteristics of the San Andrés open-pit operation have been evaluated through a combination of site investigations, laboratory testing, and numerical modeling studies. Recent geotechnical analyses include stability assessments for existing and proposed pit designs, heap leach facilities, and ongoing monitoring programs. The most recent evaluations, conducted by SRK Consulting (U.S.), Inc. (SRK), provide updated insights into rock mass behavior, structural controls, and slope stability under both static and seismic conditions.

16.1.2.1 Geotechnical Setting

The geotechnical setting of the San Andrés Mine is characterized by complex geological, structural, and hydrogeological conditions that directly influence pit wall stability and mining operations. This section summarizes the lithological framework, structural controls, and geomechanical properties relevant to open-pit design.

Geology and Lithology

The San Andrés deposit is located within a region of Tertiary volcanic and sedimentary formations, primarily consisting of:

- Rhyolite: The dominant lithology, characterized by significant silicification and brecciation, resulting in variable strength properties.
- Breccias: These are prevalent along fault zones and lithological contacts, exhibiting reduced cohesion and strength due to fracturing and weathering.
- Andesite: This competent volcanic rock underlies much of the pit area, providing better geotechnical performance compared to brecciated or altered zones.
- Conglomerates and Phyllites: Weak sedimentary units with significant weathering and alteration effects, predominantly exposed in footwall areas.



The geological framework is further complicated by pervasive hydrothermal alteration, particularly argillic alteration, which reduces the rock mass strength and increases susceptibility to slope instability. Additionally, a geotechnical model developed by SRK in 2024 defines five geotechnical units (GUs) with distinct rock mass properties, as summarized in Table 16-3.

Table 16-3: Description of Geotechnical Units

Geotechnical Unit	Lithology	Cohesion (kPa)	Friction Angle (°)	Comments
GU1	Argillic Rhyolite	50	25	Highly weathered, weak zones.
GU2	Breccias	80	28	Fault zones, reduced strength.
GU3	Andesite	120	32	Competent, stable lithology.
GU4	Phyllite	70	26	Altered and weathered units.
GU5	Silicified Rhyolite	150	34	Strong, stable lithology.

Structural Controls

The deposit is crosscut by a series of NW-SE trending normal faults and an associated fracture network, which serve as primary structural controls for pit slope stability. These features significantly influence rock mass behavior and slope design, particularly in zones with reduced cohesion and higher discontinuity persistence.

Key Structural Features

- Falla A:
 - A prominent fault zone exhibiting evidence of continuous movement, which contributes to localized instability mechanisms such as translational and rotational slides.
 - This fault poses significant challenges for slope stability, particularly along the Northeast wall of the pit, where targeted mitigative measures have been implemented. These include adjustments to bench heights and batter angles to reduce the risk of instability near fault intersections.
 - Numerical modeling highlights localized areas of displacement near Falla A, emphasizing the need for ongoing monitoring and adaptation of slope configurations.
- Secondary Faults and Joints:
 - Subparallel and cross-cutting fracture networks result in blocky rock mass conditions, which increase susceptibility to planar and wedge failures, especially in zones of weaker lithologies like argillic-altered rhyolite and breccias.
 - These discontinuities vary in orientation, persistence, and spacing, forming the basis for defining distinct structural domains. Mapping and stereographic projections have been extensively used to characterize these discontinuities and refine slope design.

Structural Domains and Stability Thresholds

Field investigations and numerical modeling have delineated three primary structural domains, each influencing slope design parameters:

- Domain 1:



- Dominated by Falla A and associated fractures.
- Slope configurations require reduced batter angles (55°–60°) and modified berm widths to ensure stability.
- Domain 2:
 - Characterized by intersecting subparallel faults with moderate discontinuity persistence.
 - Inter-ramp slope angles are set between 45° and 50° to accommodate fault-controlled instabilities.
- Domain 3:
 - Defined by lower fracture density and more competent lithologies, such as andesite.
 - Standard slope designs with batter angles of 60° and inter-ramp angles of 50° are applied.

These structural domains are integrated into the geotechnical model to establish slope stability thresholds and to inform bench configurations across the pit.

Rock Mass Quality and Geomechanical Properties

Geotechnical studies at the San Andrés Mine, including field mapping, laboratory testing, and drill core logging, have defined the geomechanical properties of the lithological units influencing pit slope stability. These studies incorporate Rock Mass Rating (RMR), Q-values, and laboratory-derived strength parameters to evaluate the behavior of the rock mass under operational and environmental conditions.

Rock Mass Classification

- Rock Mass Rating (RMR89):
 Values range from low to moderate in weathered and altered breccias and conglomerates.
 Higher RMR values are observed in competent lithologies such as silicified rhyolite and andesite, which contribute to greater stability in slope design.
- Q-Values:
 Classification using the Barton Q-System identifies poor to good quality rock mass conditions, with weaker units (e.g., breccias and argillic rhyolite) displaying lower Q-values, particularly near fault zones.

Table 16-4 presents RMR and Q-values by Geotechnical Unit.

Table 16-4: RMR and Q-Value Ranges by Geotechnical Unit

Geotechnical Unit	RMR Range	Q-Value Range
Argillic Rhyolite	20–40	0.5–3.0
Breccias	25–50	1.0–5.0
Silicified Rhyolite	50–75	10.0–20.0
Andesite	60–80	15.0–25.0



Strength Parameters

Strength characteristics of the rock mass are derived from laboratory testing, including uniaxial compressive strength (UCS), triaxial shear testing, and direct shear tests on joints and discontinuities.

- **Uniaxial Compressive Strength (UCS):**
15–100 MPa across the lithological units.
Lower UCS values are observed in brecciated rhyolite and argillic-altered materials, while competent lithologies such as andesite and silicified rhyolite exhibit significantly higher UCS values.
- **Friction Angles and Cohesion:**
Peak Friction Angles: Range from 28° to 45°, depending on the degree of weathering and alteration.
Cohesion: Varies between 50 and 150 kPa, with the lowest values in breccias and argillic rhyolite.
- **Shear Resistance:**
Laboratory shear box tests confirm reduced shear resistance along faulted and altered interfaces, especially within the brecciated units. These interfaces exhibit reduced cohesion and friction due to clay infill or alteration products.

Key Observations

- **Rock Mass Behaviour:**
The rhyolite units exhibit a wide range of geomechanical properties due to varying degrees of silicification and brecciation. Silicified rhyolite demonstrates excellent strength and stability, while argillic-altered rhyolite presents challenges due to low cohesion and strength.
Andesite is the most competent lithology in the deposit, supporting steeper slope configurations in structural domains where it dominates.
- **Impact of Discontinuities:**
Joint persistence and orientation significantly influence rock mass behavior. Discontinuities filled with clay or altered materials reduce shear resistance, particularly in zones intersecting fault structures such as Falla A.
- **Design Adjustments:**
Geotechnical data suggests reducing batter angles and lift heights in zones dominated by low-RMR units, such as breccias and altered rhyolite, to maintain stability.

16.1.2.2 Slope Stability and Design

Slope stability at the Mine has been evaluated through a series of geotechnical studies during different years conducted by external consultants, including SRK, Wood Environment & Infrastructure Solutions (Wood), and AMEC Environment & Infrastructure (AMEC). The assessments utilized both limit equilibrium methods and numerical modeling techniques under static and pseudo-static loading conditions, in alignment with international best practices and



project-specific acceptance criteria. These analyses are important to ensuring the stability of open-pit slopes and the safety of operations throughout the Life of Mine.

Key studies include:

- SRK's Slope Stability Assessment (2021), which evaluated pit slopes and heap leach pad (HLP) stability using 3D finite difference modeling (FLAC3D).
- Wood's Stability and Deformation Evaluation (2019) for the Phase IV and V heap leach facility expansions, focusing on limit equilibrium and pseudo-static analyses.
- AMEC's Detailed Design Report (2014), which provided baseline geotechnical parameters and stability assessments for earlier phases of the heap leach facility.

These studies collectively form the basis for slope stability design and ongoing monitoring programs at San Andrés.

Methodology

The stability evaluations incorporate key inputs, including:

- Geotechnical studies including mapping, drilling, laboratory testing (UCS, direct shear, and triaxial tests), and radar monitoring have been conducted.
- Three-dimensional finite difference models (FLAC3D) were used to predict displacements and identify failure mechanisms across the pit slopes and associated infrastructure.
- Regional seismic hazard model was developed to determine site-specific parameters, including a 500-year recurrence earthquake with a Peak Ground Acceleration (PGA) of 0.41 g.
- Stability assessments adhere to international standards and project-specific thresholds:
 - Static Factor of Safety (FoS): 1.3 or higher for operational slopes.
 - Pseudo-Static FoS: 1.0 or higher under seismic conditions.

Key Findings

Based on the results of the stability assessments, the following conclusions have been reached:

- Overall
 - The Factor of Safety (FoS) for current and planned pit slopes meets or exceeds international design acceptance criteria, with values typically above 1.3 under static conditions and 1.0 under pseudo-static conditions.
 - No significant deep-seated failure mechanisms have been identified. Stability is primarily controlled by the strength of the rhyolite and andesite rock masses and influenced by structural domains.
- Localized Instabilities
 - Localized instabilities, such as planar sliding and wedge failures, have been observed along fault zones, particularly on the Northeast wall and sections of the haulage ramps. These instabilities are attributed to:
 - Reactivation of NW-SE trending faults (e.g., Falla A).



- Poor rock mass conditions, particularly in argillic-altered rhyolite.
 - These failures are anticipated to be manageable through targeted slope mitigation measures, such as reducing batter angles and implementing drainage controls.
- Seismic Stability
 - Pseudo-static analyses, incorporating a horizontal seismic coefficient of 0.20 g (50% of PGA), confirm that the pit slopes remain stable during a 500-year seismic event.
 - Minimal deformation and strain are predicted, with no fully developed failure surfaces identified under earthquake loading.
- Bench and Slope Design
 - Bench stability analyses demonstrate that the current bench configuration (bench height of 6–12 m and batter angles of 55°–60°) is appropriate for the geotechnical conditions.
 - For structurally complex or weaker zones, SRK recommends reducing batter angles to 55° and maintaining minimum berm widths of 5–8 m to mitigate local failures.
- Water Management
 - Effective surface water management is critical to maintaining slope stability, especially during the rainy season. Implemented measures include:
 - Diversion channels to reduce surface water infiltration.
 - Monitoring of pore pressures using piezometers in critical zones.

Monitoring and Recommendations

A geotechnical monitoring program is in place to ensure ongoing stability and to detect early signs of deformation:

- Real-time monitoring using FastGBSar and TerraSar-X radar systems to track displacement trends.
- Piezometers, inclinometers, and survey prisms are strategically installed to monitor ground movements and pore water pressures.
- Thresholds for displacement rates and water levels have been defined to trigger mitigation actions this is part of a Trigger Action Response Plan (TARP).

16.1.2.3 Slope Geometry and Bench Configuration

The pit slope design is based on geotechnical recommendations to ensure operational safety, maximize ore recovery, and minimize geotechnical risks. The design incorporates rock mass ratings, structural conditions, and lithology-specific parameters, which are applied using the Deswik mine planning software.

Slope Design Parameters

- Inter-Ramp Angles (IRA):
 - Inter-ramp angles are optimized according to the geomechanical properties of the lithologies, with values ranging from 31° to 45°.



- Structural domains, fault orientations, and material strength influence the local adjustments to IRA values, ensuring stability under operational conditions.
- Bench Heights and Batter Angles:
 - Bench heights of 6 m to 12 m are applied based on operational efficiency and geotechnical conditions.
 - Batter angles of 60° are adopted for competent lithologies such as silicified rhyolite and andesite, while reduced batter angles of 55° are used in weaker units, particularly in areas with critical haulage routes or intersecting fault zones.

Lithology-Specific Design

The Deswik optimization and design process accounts for lithology-specific overall slope angles. In the block model, each block is assigned a lithology parameter (1–6), corresponding to the primary rock types outlined in Section 13.1.1.1 Geology and Lithology. The following lithological units and their respective maximum overall slope angles are considered.

Table 16-5: Maximum Overall Slope Angles by Lithology

Lithology (BM code)	Description	Overall Slope Angle (°)
1	Breccia / Conglomerate	31°
2	Rhyolite	37°
3	Andesite	45°
4	Red Bed	42°
5	Phyllite	35°
6	Default / Unassigned	31°

These slope angles reflect the geotechnical properties of each lithological unit, ensuring that the design remains stable while accommodating geological variability.

Design Integration

The use of Deswik enables seamless integration of geotechnical parameters into pit optimization and design. The block model incorporates lithology-specific parameters, including cohesion, friction angle, and rock mass quality, to guide slope configurations. This process ensures that:

- Lithology-based slope angles are automatically applied during optimization, achieving a balance between slope steepness and operational safety.
- Fault zones and other geotechnical constraints are incorporated into the design, further refining the slope geometry.
- Areas with weak or highly weathered materials, such as breccias and phyllites, are assigned conservative slope angles (31°–35°) to mitigate stability risks.

16.1.2.4 Monitoring and Risk Mitigation

A reasonable geotechnical monitoring program is in place to identify and manage potential instabilities:



- Radar Monitoring: Real-time slope radar systems (e.g., FastGBSar) monitor displacement rates along critical walls.
- Instrumentation: Piezometers, inclinometers, and survey prisms are installed to track pore pressures, deformation, and surface movements.
- Rainfall Management: Surface water diversion systems and impermeable berms minimize water infiltration, which can negatively impact slope stability.

16.2 Hydrogeological Studies

Hydrogeological data for the San Andrés Mine has been collected through dedicated hydrogeological drilling, piezometer installations, and pump tests conducted across the property. These data sources have been used to assess groundwater conditions, permeability, and dewatering requirements, supporting mine planning and geotechnical stability evaluations.

16.2.1 Data Collection Program

Hydrogeological Drill Holes

A series of hydrogeological boreholes have been drilled historically to evaluate groundwater levels, permeability, and water-bearing structures within the mine area.

The latest boreholes targeted key fault zones and fractured rock units to improve understanding of groundwater flow dynamics. There was a total of six hydrogeological drill holes completed in the most recent study, with a range of depths from 11.35 m to 32.40 m. The bedrock depth ranged from 7 m to 20 m depending on lithology. The depths are listed by borehole in Table 16-6.

Table 16-6: Recent Hydrogeological Boreholes

Borehole ID	Total Depth (m)	Bedrock Depth (m)	Breccia Rhyolite
BH-P6-01	11.35	7	Andesite
BH-P6-02	32.40	20	Phyllite
BH-P6-03	17.00	11	Rhyolitic Tuff
BH-P6-04	25.90	19	Red Bed
BH-P6-05	24.50	17.5	Brecciated Rhyolite
BH-P6-06	16.85	12	
Source: SRK 2021.			

Piezometer Installations

To monitor real-time groundwater levels, six piezometers were installed at various elevations within the mine area. These installations provide monitoring of the water table and hydrostatic pressures, supporting dewatering efforts and geotechnical stability assessments. The installation elevations range from 890 masl to 1,020 masl, as listed in Table 16-7.



Table 16-7: Installation Depth of Piezometers

Piezometer ID	Installation Elevation (masl)
PZ-001	975
PZ-002	1020
PZ-003	924
PZ-004	998
PZ-005	890
PZ-006	893
Source: SRK 2021.	

Pumping and Permeability Tests

Step-drawdown and constant-rate pump tests were conducted on selected boreholes to assess hydraulic conductivity and recharge potential.

Results suggest that water inflow is predominantly fracture-controlled, with measured permeability values ranging from 1.0×10^{-6} to 1.0×10^{-5} m/s.

Seasonal fluctuations affect groundwater recharge, with higher water levels observed during the rainy season.

Table 16-8 provides a summary of recent hydrogeological data sources.

Table 16-8: Summary of Recent Hydrogeological Data

Data Type	Number of Tests	Depth Range (m)	Purpose
Hydrogeological Drill Holes	6	11.35 – 32.40	Determine groundwater flow and permeability
Piezometers Installed	6	890 – 1,020 (masl)	Monitor real-time water table fluctuations
Pumping Tests			Assess aquifer transmissivity and recharge
Permeability Tests			Evaluate hydraulic conductivity

16.2.2 Relevance to Exploration and Mine Planning

Further hydrogeological investigations are planned to refine the long-term dewatering strategy. These include the installation of additional monitoring wells and test holes in 2025 to improve the understanding of groundwater flow conditions and support pit slope stability assessments.

16.2.3 Hydrogeology

Hydrogeological conditions within the San Andrés Mine area are primarily influenced by seasonal rainfall and localized groundwater infiltration, which can impact pit wall stability if not properly managed. These conditions are evaluated through a combination of field observations, hydrological modeling, and geotechnical analyses.

- Surface Water Management



Seasonal precipitation is a significant factor, particularly during heavy rainfall events. Improper drainage can lead to localized pooling, increased pore water pressures, and slope instability.

Surface water is managed through diversion ditches and channels upstream of pit walls to minimize infiltration and prevent erosion. Regular maintenance ensures these systems function effectively during the rainy season.

Perimeter drainage ditches redirect rainwater away from pit slopes, reducing infiltration.

Toe drains are installed along critical slope areas to collect and remove runoff water efficiently.

- **Groundwater Infiltration:**

While the majority of pit walls are classified as dry, localized perched aquifers and water pockets have been observed near faulted zones such as Falla A. These areas require targeted drainage and monitoring to mitigate potential slope weakening.

Piezometric measurements indicate that groundwater infiltration is highly localized, with minimal overall impact on large-scale slope stability.

- **Numerical Modelling:**

Stability assessments incorporate scenarios under both dry and wet conditions. The inclusion of elevated pore pressure regimes in numerical models accounts for the potential effects of localized water infiltration on slope strength.

Under wet conditions, slope stability remains within acceptable thresholds provided drainage and water diversion measures are maintained.

- **Monitoring and Mitigation:**

Regular inspections and monitoring using piezometers allow for real-time assessment of groundwater conditions.

Contingency plans include additional pumping capacity and surface water redirection in the event of unexpected rainfall or groundwater ingress.

The San Andrés Mine employs a reasonable open-pit design, balancing the priorities of economic returns, operational safety, and environmental compliance. The mine design reflects the operational experience and incorporates the latest geological, geotechnical, and economic data.

16.2.4 Key Design Elements

The key design elements used in mine planning are listed:

- The Deswik Pseudoflow algorithm is used for pit optimization, integrating geological, geotechnical, and economic parameters.
- The mine design is based on the Mineral Reserves in the pit optimization.
- Economic parameters include a gold price of US\$2,000/oz, processing costs, and lithology-specific slope angles.

Slope Design and Stability:

- Slope configurations are guided by geotechnical domains, with inter-ramp angles ranging from 31° to 45°, depending on lithology and structural conditions.



- Weak units, such as breccias and argillic rhyolite, are assigned conservative slope angles to ensure stability.
- Slope monitoring systems include radar displacement tracking and piezometers, supported by proactive water management systems to mitigate infiltration effects.

Bench Configuration:

- Benches are designed with standardized heights of 6 m to 12 m, facilitating efficient drilling, blasting, and excavation.
- Batter angles (bench face angles) are set between 55° to 60°, depending on rock strength and stability.
- Berm widths are calculated to catch falling material and provide safe access for maintenance and geotechnical monitoring.

Pushback Sequencing:

- Mining phases are strategically sequenced to prioritize high-grade ore zones, ensuring early revenue generation while maintaining geotechnical stability.
- Pushbacks are planned to minimize haulage distances and optimize material movement, reducing operational costs.

Waste and Material Handling

- Waste rock is placed in designated dumps or backfilled into mined-out areas to reduce the environmental footprint.
- Drainage systems and erosion control measures are incorporated into waste rock storage facility (WRSF) design, in compliance with environmental regulations.

The eastern extent of the final pit is limited by the proximity of the Río Lara. A setback was applied during pit optimization and detailed design to maintain a buffer between active mining and the river, ensuring compliance with Honduran environmental regulations and minimizing the risk of hydrological impacts.

16.3 Mining Method

The San Andrés Mine employs conventional open-pit mining methods to extract gold-bearing ore. Operations are designed to ensure efficient material movement, with a focus on maintaining productivity, minimizing costs, and adhering to safety and environmental standards.

The mining operations run 24 hours per day, 7 days per week, utilizing conventional drill-and-blast techniques, followed by excavation, hauling, and crushing. Mining phases (pushbacks) have been designed based on the December 31, 2024, Mineral Reserve estimate, incorporating considerations for:

- Planned WRSFs.
- Previously mined areas.
- Sensitive zones such as the local cemetery.

The bench height is standardized at 6 m, which allows for optimized drilling, blasting, and excavation efficiency.



16.3.1 Drilling

Blast hole drilling is performed by Minosa employees using a fleet of drills operated and maintained in-house. The current fleet includes:

- Epiroc PowerROC D60 (Primary production drill).
 - Epiroc PowerROC T45.
 - Furukawa DCR20
- A MAXCAT RC drill, primarily used for exploration but capable of converting to Down-The-Hole (DTH) operations for backup drilling.

Drilling Specifications:

- Pattern: 3.5 m (spacing) x 4.0 m (burden).
- Hole Depth: 6.5 m (6.0 m bench height + 0.5 m subdrilling to improve floor control).

The drilling operations are designed to achieve optimal fragmentation and minimize oversize material for efficient loading and crushing.

16.3.2 Blasting

Blasting operations are carried out during the day shift by Minosa personnel, using industry-standard blasting techniques and materials.

Blasting Details:

- Explosives: ANFO (Ammonium Nitrate Fuel Oil).
- Initiation System: Dual delay detonators and MS (millisecond) surface delays.
- Initiation Method: Shot tubes.
- Powder Factor: Approximately 0.16 kg/t.

To minimize impacts on pit walls, the following techniques are applied:

- Pre-splitting: Reduces stress on final pit walls and controls fracturing.
- Cushion Blasting: Protects wall stability and minimizes overbreak in the final bench design.

All explosives and initiation materials are stored in a dedicated explosives magazine, which is constructed and maintained according to North American standards to ensure safety and regulatory compliance.

16.3.3 Excavation and Hauling

All material movement at the San Andrés Mine is carried out by a Honduran contractor, which is responsible for both ore and waste hauling within the pit and surrounding operational areas. The mining Contractor provides a comprehensive service that includes logistics, maintenance, and personnel management under a bank-cubic-meter (BCM) rate contract. Additional activities outside the scope of routine operations are managed on a cost-plus basis, subject to approval by Minosa's supervising engineer.



16.3.3.1 Hauling Operations

The hauling operations involve transporting ore and waste material using a fleet of contracted haul trucks. Ore is moved from the active mining phases to one of two jaw crushers, offering operational flexibility and ensuring continuity in ore processing. The current average haul distance to the primary crushers is approximately two kilometers, though this distance is expected to evolve as mining progresses.

The mining contractor operates and maintains its own equipment fleet, which includes a combination of haul trucks, excavators, and support vehicles to meet production requirements.

16.3.3.2 Equipment Fleet

As of September 2024, the contractor’s fleet includes the following major equipment types:

- Haul Trucks: A mix of Volvo, Howo, UD, Mack, Sany, and Shacman trucks with capacities ranging from 14 m³ to 27 m³.
- Excavators: Caterpillar, Hyundai, and Shantui excavators, with bucket capacities between 1.5 m³ and 2.8 m³.
- Support Equipment: Tractors, water trucks, motor graders, compactors, and lighting towers.

A detailed list of the contractor’s equipment is provided in Table 16-9.

Table 16-9: Contractor Equipment Fleet

Equipment Number	Equipment Type	Category	Brand	Model	Year	Capacity (m ³)
V-100	Dump Truck	Hauling	VOLVO FMX	V480	2019	22
V-101	Dump Truck	Hauling	VOLVO FMX	V480	2019	22
V-103	Dump Truck	Hauling	VOLVO FMX	V480	2019	22
V-155	Dump Truck	Hauling	HOWO		2022	27
V-156	Dump Truck	Hauling	HOWO		2022	27
V-157	Dump Truck	Hauling	HOWO		2022	27
V-158	Dump Truck	Hauling	HOWO		2022	27
V-159	Dump Truck	Hauling	HOWO		2022	19
V-160	Dump Truck	Hauling	HOWO		2022	19
V-163	Dump Truck	Hauling	HOWO		2022	19
V-164	Dump Truck	Hauling	HOWO		2022	19
V-176	Dump Truck	Hauling	HOWO		2022	19
V-177	Dump Truck	Hauling	HOWO		2022	19
V-178	Dump Truck	Hauling	UD		2022	14
V-179	Dump Truck	Hauling	UD		2022	14
V-180	Dump Truck	Hauling	UD		2022	14
V-181	Dump Truck	Hauling	UD		2022	14
V-202	Dump Truck	Hauling	UD	HAX 7121	2022	14



Equipment Number	Equipment Type	Category	Brand	Model	Year	Capacity (m³)
V-203	Dump Truck	Hauling	UD	HAX 6575	2022	14
V-204	Dump Truck	Hauling	UD	HCZ 2029	2022	14
V-205	Dump Truck	Hauling	UD	HAX 7119	2022	14
V-206	Dump Truck	Hauling	MACK	HBL 8507	2022	14
V-207	Dump Truck	Hauling	MACK	HBL 8505	2022	14
V-208	Dump Truck	Hauling	MACK	HBL 8506	2022	14
V-209	Dump Truck	Hauling	MACK	HBL 8503	2022	14
V-210	Dump Truck	Hauling	MACK	HBM 0739	2022	14
V-211	Dump Truck	Hauling	MACK	HBM 0736	2022	14
V-212	Dump Truck	Hauling	MACK	HAV 7103	2022	14
V-213	Dump Truck	Hauling	MACK	HDG 9725	2022	14
V-214	Dump Truck	Hauling	MACK	HDG 9727	2022	14
V-221	Dump Truck	Hauling	MACK		2022	14
V-231	Dump Truck	Hauling	MACK		2022	14
V-232	Dump Truck	Hauling	MACK		2022	14
V-233	Dump Truck	Hauling	MACK	HCC5770	2022	16.5
V-234	Dump Truck	Hauling	SANY		2022	16.5
V-235	Dump Truck	Hauling	SANY		2022	16.5
V-236	Dump Truck	Hauling	SANY		2022	16.5
V-237	Dump Truck	Hauling	SANY		2023	16.5
V-238	Dump Truck	Hauling	SANY		2023	16.5
V-239	Dump Truck	Hauling	SHACMAN		2023	16.5
V-240	Dump Truck	Hauling	SHACMAN		2023	16.5
V-241	Dump Truck	Hauling	SANY		2023	16.5
V-242	Dump Truck	Hauling	MACK		2013	14
V-243	Dump Truck	Hauling	SANY		2024	16.5
V-244	Dump Truck	Hauling	SANY		2024	16.5
V-245	Dump Truck	Hauling	SANY		2024	16.5
V-246	Dump Truck	Hauling	SANY		2024	16.5
V-247	Dump Truck	Hauling	SANY		2024	16.5
V-248	Dump Truck	Hauling	SANY		2024	16.5
EX-101	Excavator	Loading	CATERPILLAR	349 DL	2012	2.8
EX-111	Excavator	Loading	HYUNDAI	H340	2022	2
EX-113	Excavator	Loading	SHANTUI	SE220	2023	1.05
EX-114	Excavator	Loading	SHANTUI	SE305LCW	2023	1.5
EX-115	Excavator	Loading	SHANTUI			2



Equipment Number	Equipment Type	Category	Brand	Model	Year	Capacity (m³)
EX-116	Excavator	Loading	CATERPILLAR	330		2
EX-120	Hydraulic Hammer	Support	SHANTUI	220	2022	1.5
EX-122	Excavator	Loading	CATERPILLAR	336	2022	2
EX-125	Excavator	Loading	CATERPILLAR	330	2023	2
EX-126	Excavator	Loading	HYUNDAI	340	2023	2
EX-127	Excavator	Loading	HYUNDAI	340	2023	2
EX-128	Excavator	Loading	SANY			2
EX-201	Excavator	Loading	HYUNDAI	225SL	2019	2
EX-202	Excavator	Loading	HYUNDAI	225SL	2019	2
EX-203	Excavator	Loading	CATERPILLAR	330DL	2022	2
EX-204	Excavator	Loading	CATERPILLAR	329D	2009	2
EX-206	Excavator	Loading	CATERPILLAR	323D	2022	2
EX-209	Excavator	Loading	CATERPILLAR	330DL	2022	2
EX-211	Excavator	Loading	HYUNDAI	225SL		1.5
TA-200	Water Tank	Support	HINO		2021	N/A
TA-201	Water Tank	Support	HINO		2022	N/A
TA-202	Water Tank	Support	HINO		2023	N/A
TA-100	Water Tank	Support	HINO		2023	N/A
CM-102	Fuel Truck	Support			2023	N/A
MOT-100	Moto Grader	Support	JOHN DEER	670G	2010	N/A
MOT-103	Moto Grader	Support	CATERPILLAR	140H		N/A
MOT-201	Moto Grader	Support	CATERPILLAR	140H	2020	N/A
MOT-202	Moto Grader	Support	CATERPILLAR	120H		N/A
VIC-201	Vibratory Compactor	Support	CATERPILLAR	CAT533	2019	N/A
TR-105	Dozer	Support	SHANTUI	SD16	2022	N/A
TR-200	Dozer	Support	CATERPILLAR	D6T		
TR-201	Dozer	Support	CATERPILLAR	D6R	1996	N/A
TR-203	Dozer	Support	CATERPILLAR	D6R	1986	N/A
TR-204	Dozer	Support	CATERPILLAR	D6R		N/A
TR-205	Dozer	Support	JOHN DEER	850J		N/A
TR-208	Dozer	Support	CATERPILLAR	D6		N/A
RET-201	Backhoe Loader	Support	HYUNDAI		2022	N/A
TL-01	Light Tower	Support	ATLAS		2022	N/A
TL-04	Light Tower	Support	WACKER NEUSON			N/A



Equipment Number	Equipment Type	Category	Brand	Model	Year	Capacity (m³)
TL-05	Light Tower	Support	WACKER NEUSON			N/A
TL-06	Light Tower	Support	WACKER NEUSON			N/A
TL-08	Light Tower	Support	WACKER NEUSON			N/A
TL-09	Light Tower	Support	WACKER NEUSON			N/A
TL-10	Light Tower	Support	WACKER NEUSON			N/A

16.3.3.3 Performance and Flexibility

The current fleet has been deemed sufficient to meet production targets over the LOM. Should production requirements increase, the mining contractor has demonstrated the capability to scale operations by mobilizing additional equipment from other sources. This ensures that hauling capacity remains aligned with the Mine’s operational needs.

16.3.3.4 Material Movement

Material movement at the San Andrés Mine is managed to maintain steady operations and efficient resource allocation. Ore is transported to the primary crushers, while waste material is hauled to designated storage areas.

There is no formal dispatch system; however, hauling operations are coordinated through radio and mobile communication. The contractor’s coordinator maintains direct communication with Minosa’s mining team for operational oversight and with the jaw crusher operators to regulate ore feed and minimize delays.

In the event of any operational interruption (e.g., crusher downtime or equipment issues), the haul fleet is reassigned as needed to minimize production delays. Additionally, designated ore stockpiles near the crushers provide up to four days of crusher feed, serving as a buffer to maintain processing continuity.

16.3.3.5 Waste Handling

Waste material is managed through controlled disposal methods designed to ensure stability and optimize operational productivity. Waste is hauled to the designated WRSFs, which are planned and constructed in alignment with the Mine’s design parameters.

Waste Disposal Methods

- WRSFs are developed in an ascending sequence (i.e., bottom-up), with small lifts of six metres constructed consecutively. Equipment movement, including trucks and dozers, compacts the surface of each lift. This compaction improves the dumps’ overall stability and reduces the infiltration of rainwater, mitigating erosion risks.
- Drainage ditches are constructed both upstream and downstream of the dumps to divert rainwater and prevent erosion. Berms on the dump faces are designed with a slight inclination toward the toe, directing runoff into these drainage ditches and minimizing sedimentation downstream.



- Wherever possible, waste is placed within mined-out areas of the open pit to minimize transportation distances and associated costs. This approach reduces the Mine’s overall environmental footprint and optimizes resource utilization.

Design Parameters for Waste Rock Storage Facilities

WRSF designs are guided by the geotechnical and operational parameters listed in Table 16-10:

Table 16-10: WRSF Design Parameters

Parameter	Value
Dynamic Dumping Angle	37°
Lift Height	6.0 m
Berm Width	4.0 m
Average Overall Dump Angle	26°

These parameters are designed to ensure long-term stability and safe disposal of waste material, considering site-specific geotechnical conditions and environmental considerations.

Environmental considerations include:

- Measures such as surface compaction, berm design, and well-placed drainage ditches help to control erosion and prevent sediment runoff during heavy rainfall.
- Drainage ditches upstream of the dumps divert rainwater away from the waste face, while downstream ditches collect and safely remove runoff from the dump toe.
- Regular inspections and geotechnical monitoring are conducted to ensure dump performance and to address any signs of instability or excessive erosion.

The waste management strategy at the San Andrés Mine reflects good practices in open-pit mining waste disposal, with an emphasis on operational efficiency, environmental protection, and compliance with Honduran regulatory standards.

16.3.4 Crushing and Conveyance

All ore extracted is processed through a two-stage crushing circuit before being transported on conveyors to the leach pad. The process flow includes:

- Primary Crushing: Reduction of ore size using two jaw crushers.
- Conveyance: Crushed ore is transported via conveyor systems for final stacking at the heap leach facility.

16.3.5 Mine Production Schedule

The mine production schedule is based on the December 31, 2024, Mineral Reserve estimate and designed pit phases. The schedule considers:

- Material movement requirements.
- Placement of waste material in designated dumps.
- Mitigation of interference with previously mined areas and protected zones.



Production rates are designed to meet the operational capacity of the crushing and leaching facilities.

16.3.6 Required Personnel

Mining operations at the San Andrés Mine are conducted by a combination of Minosa's own workforce and contractors. As of the date of this report, the total workforce consists of 809 permanent personnel, including 349 direct employees and 460 contractors.

Workforce Composition:

- Minosa employees: 349 (43%)
- Contractors (permanent operations): 460 (57%)
 - Mining contractor employee: 277
 - Other areas contractor employee: 183

Distribution of Minosa Employees by Area:

- Mining Operations: 47
- Processing: 138
- Maintenance: 65
- Administration (HR, Accounting, PCP, General Services): 64
- Community Relations: 12
- Health, Safety, and Environment: 23

The Mine operates on a rotating shift schedule, ensuring continuous coverage for mining, processing, and maintenance activities. Staffing levels are structured to support ongoing operations and the Life of Mine (LOM) plan, with adjustments made as needed to align with production requirements.

16.4 Mine Optimization

The mine optimization process for the San Andrés open-pit operation is conducted using the Deswik Pseudoflow module. This software integrates geological, geotechnical, and economic parameters to identify optimal pit designs and guide the development of LOM plans. Optimization at San Andrés ensures economic viability while maintaining compliance with geotechnical and environmental constraints.

16.4.1 Open Pit Mine Planning Block Model

The pit optimization at San Andrés is based on the 2024 updated Mineral Resource Block Model, described in Section 14.0. This block model incorporates the following attributes essential for mine planning and economic evaluation:

- In Situ Data: Gold grade (g/t), density, and lithology.
- Geotechnical Parameters: Rock mass rating (RMR), cohesion, friction angle, and slope geometry values.
- Mining-Specific Codes: Concession boundaries, depletion zones, and material classification (ore vs. waste).



- **Resource Classification:** Only Measured and Indicated Resources are considered as potential revenue-generating material, while Inferred Resources are treated as waste during optimization.

The block model uses dimensions of 10 m x 10 m x 6 m (X, Y, Z), representing a selective mining unit (SMU) compatible with the operational loading and hauling fleet. It is important to note that dilution and mining recovery factors are not included in the block model but are applied during Reserve estimation and mine scheduling.

16.4.2 Optimization Methodology

The Deswik Pseudoflow algorithm was used to generate pit shells, evaluating the net value of each block based on revenue, mining, processing, and selling costs. The following steps were undertaken:

- **Revenue Factor (RF) Analysis:** A range of RFs (e.g., 0.75, 0.85, 1.00) was applied to assess economic sensitivity.
- **Geotechnical Constraints:** Slope geometry was integrated into the optimization process using lithology-based overall slope angles.
- **Exclusion Criteria:** Blocks within restricted areas, such as communities or cemeteries, and previously mined-out zones were excluded.

The results were used to identify the optimal pit shell for detailed design, ensuring a balance between economic returns and operational constraints.

16.4.3 Optimization Results

The results of the pit optimization process are summarized in Table 16-11. These include ore and waste volumes, average grades, and economic metrics for the selected pit shell at a Revenue Factor of 1.0.

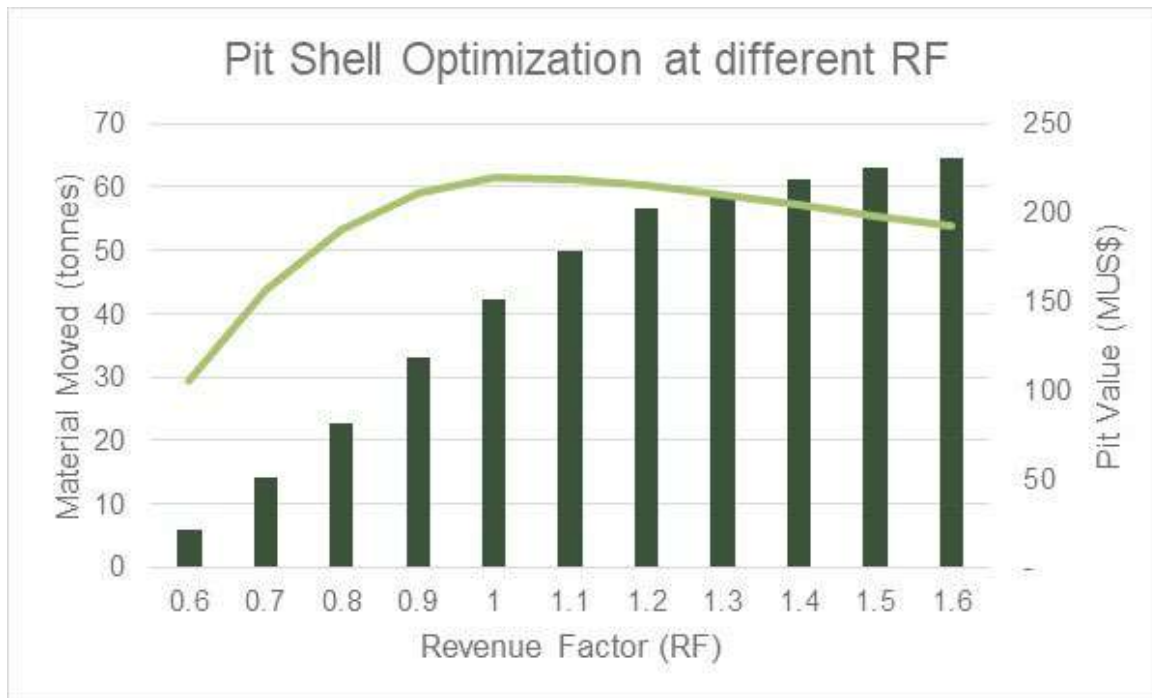
Table 16-11: Pit Optimization Results (RF = 1.0)

Parameter	Value
Total Material Moved (Mt)	46.0 Mt
Waste Material (Mt)	13.8 Mt
Ore Material (Mt)	32.2 Mt
Average Grade (g/t Au)	0.48
Stripping Ratio	0.42
Undiscounted pit value (US\$ million)	220

The selected shell reflects an economically viable scenario, while maintaining compliance with geotechnical and environmental constraints. The following chart presents the resulting undiscounted pit shells at different Revenue Factors (RF).



Figure 16-1: Pit Shell Optimization at Different Revenue Factors



The selected pit shell was further refined to ensure a practical and operationally efficient design, incorporating the following criteria:

- **Pushback Size:** Pushbacks smaller than 46 Mt were excluded to maintain efficiency.
- **Dilution and Recovery:** Factors for dilution and mining recovery were applied to estimate recoverable ounces and mineable reserves.
- **Operational Adjustments:** The final pit design was operationalized, incorporating a minimum mining unit (box size) and ensuring practical access ramp placement. As a result, certain mineable ore areas had to be left in place to accommodate the access ramp design.

The impact of these refinements is summarized in Table 16-12.

Table 16-12: Comparison of Pit Optimization vs. Operational Pit

Parameter	Pit Optimization	Operational Pit
Tonnes Ore (Mt)	32.2	31.6
Gold Grade (g/t Au)	0.478	0.44
Waste (Mt)	13.8	14.4
Total Material Moved (Mt)	46.0	46.0
Gold Ounces In Situ (oz)	495,359	448,966

These adjustments ensure a practical, safe, and efficient mining sequence, aligning with operational constraints while maximizing ore extraction within the geotechnical and environmental parameters of the San Andrés Mine.



16.5 Life of Mine Plan

The LOM Plan for the San Andrés Mine outlines the anticipated operational and production strategy over the remaining mine life. The plan integrates the results of pit optimization, mine scheduling, and economic analysis to provide a comprehensive framework for mining, processing, and reclamation activities.

16.5.1 Production Schedule

The LOM plan projects material movement and ore processing volumes on an annual basis, accounting for:

- Ore: Total tonnage delivered to the crushers, processed through the heap leach facility, and recovered as gold.
- Waste: Material stripped and hauled to designated WRSF or in-pit disposal areas.
- Stripping Ratio: The ratio of waste material to ore is optimized to balance economic returns and operational efficiency.

The production schedule by mining phase is summarized in Table 16-13, showing annual tonnages of ore, waste, and contained metal. Figure 16-2 presents the annual production schedule.

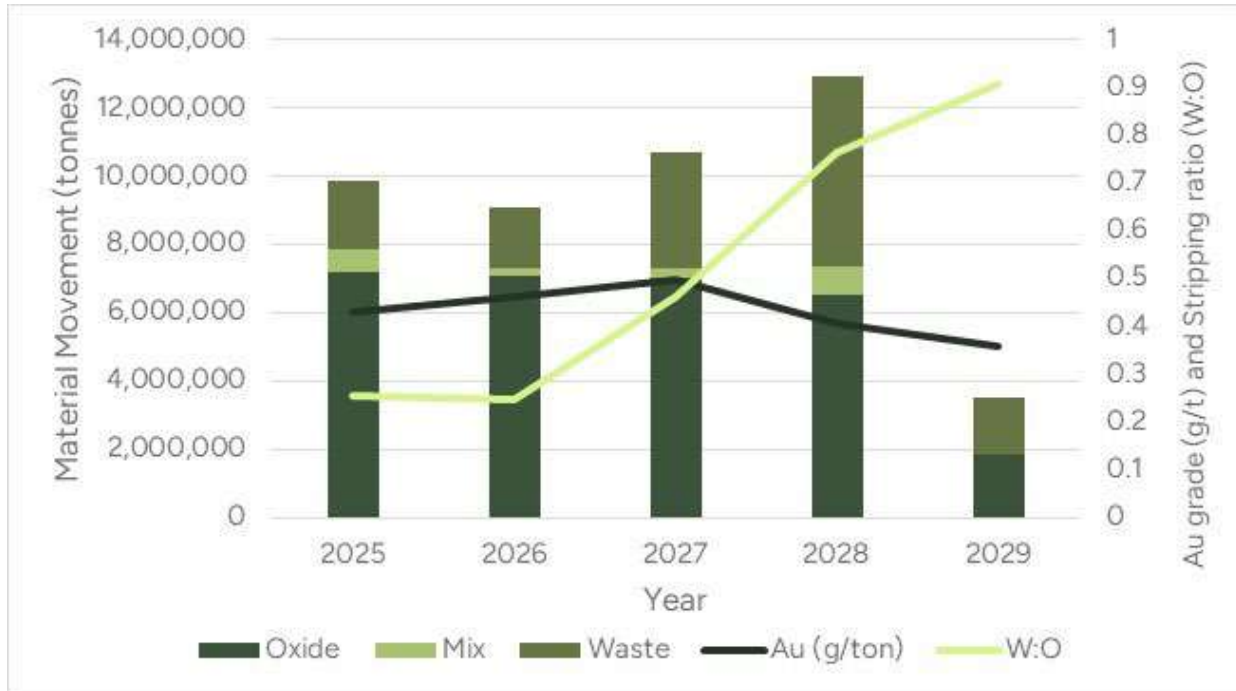


Table 16-13: LOM Mining Schedule

Phase	Field	Total	2025	2026	2027	2028	2029
1	Ore (t)	281,952	281,952				
	Au (g/t)	0.59	0.59				
	Waste (t)	36,253	36,253				
2	Ore (t)	3,871,021	3,871,021				
	Au (g/t)	0.43	0.43				
	Waste (t)	913,097	913,097				
3	Ore (t)	12,945,474	3,592,859	6,286,260	3,066,354		
	Au (g/t)	0.38	0.41	0.36	0.38		
	Waste (t)	3,367,888	834,845	711,056	1,821,988		
4	Ore (t)	8,079,153	91,499		3,282,492	4,705,162	
	Au (g/ton)	0.39	0.42		0.41	0.37	
	Waste (t)	4,799,042	200,767		1,314,658	3,283,617	
5	Ore (t)	3,274,784				1,439,811	1,834,973
	Au (g/t)	0.37				0.38	0.36
	Waste (t)	3,207,308				1,542,686	1,664,622
6	Ore (t)	980,535				980,535	
	Au (g/t)	0.44				0.44	
	Waste (t)	701,415				701,415	
ZB	Ore (t)	2,156,517		993,932	966,759	195,827	
	Au (g/t)	1.16		1.12	1.17	1.28	
	Waste (t)	1,378,451		1,074,212	238,871	65,368	
Total	Ore (t)	31,589,436	7,837,331	7,280,192	7,315,606	7,321,333	1,834,973
	Au (g/t)	0.44	0.43	0.46	0.50	0.40	0.36
	Waste (t)	14,403,456	1,984,962	1,785,268	3,375,516	5,593,087	1,664,622
	Total Tonnes Moved	45,992,891	9,822,293	9,065,460	10,691,122	12,914,421	3,499,595
	Contained Gold, in situ (oz)	448,966	107,825	107,888	117,230	95,034	20,990
	Produced Gold (68% recovery)	305,297	73,321	73,364	79,716	64,623	14,273



Figure 16-2: Annual Production



16.5.2 Mining Phases and Pushbacks

Mining activities are executed in a series of phases (pushbacks) designed to:

- Optimize access to higher-grade ore in the early years of the mine life.
- Maintain geotechnical stability by adhering to slope design criteria described in Section 16-1.
- Minimize haulage distances by sequencing mining areas in alignment with crusher locations and waste disposal sites.

Figure 16-3 illustrates the proposed mining phases and pit configuration over the LOM. The end of period pit configuration from 2025 to 2029 are illustrated in Figure 16-4 to Figure 16-8.



Figure 16-3: Mining Phases and LOM Pit Configuration

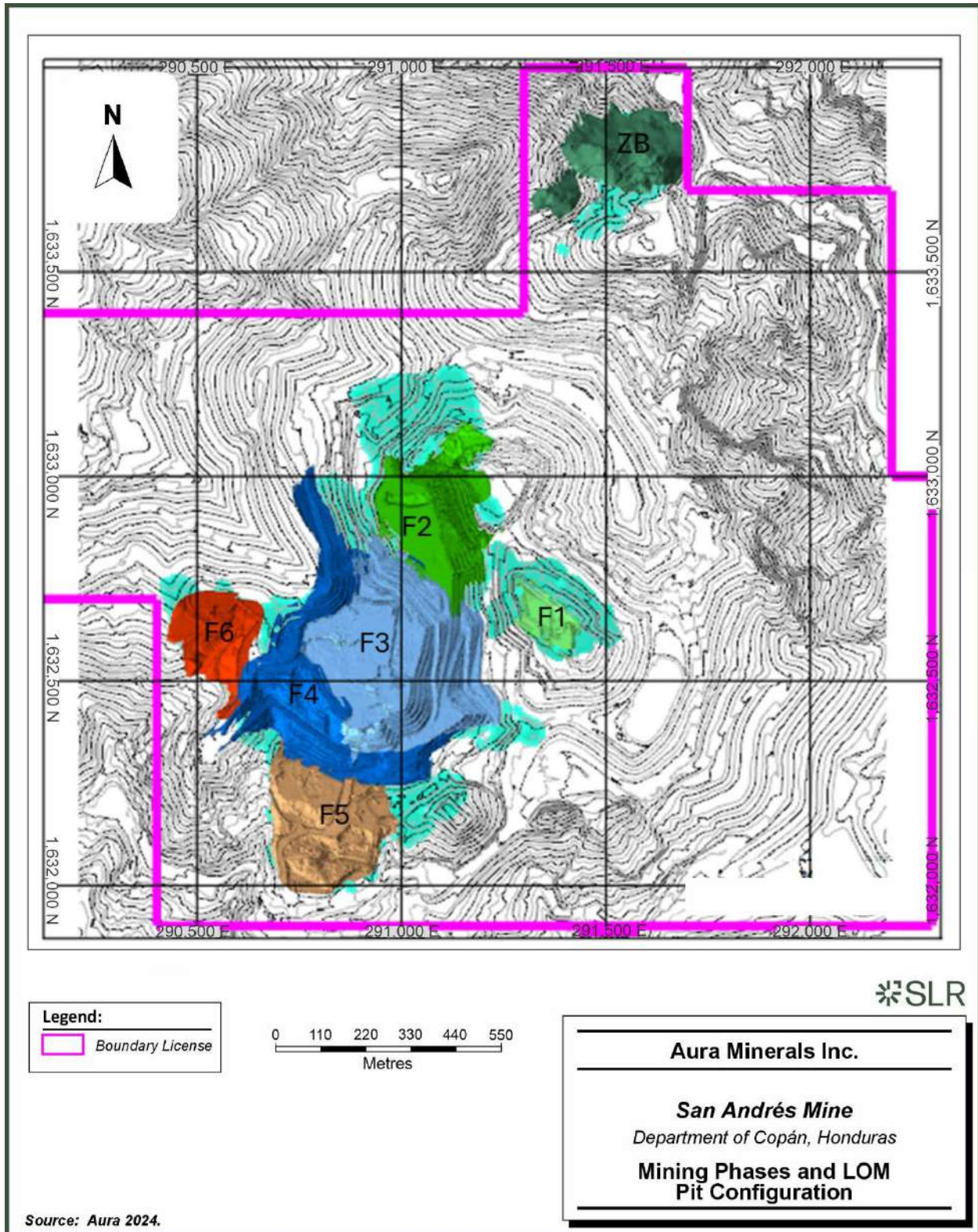


Figure 16-4: Pit Configuration EOY 2025

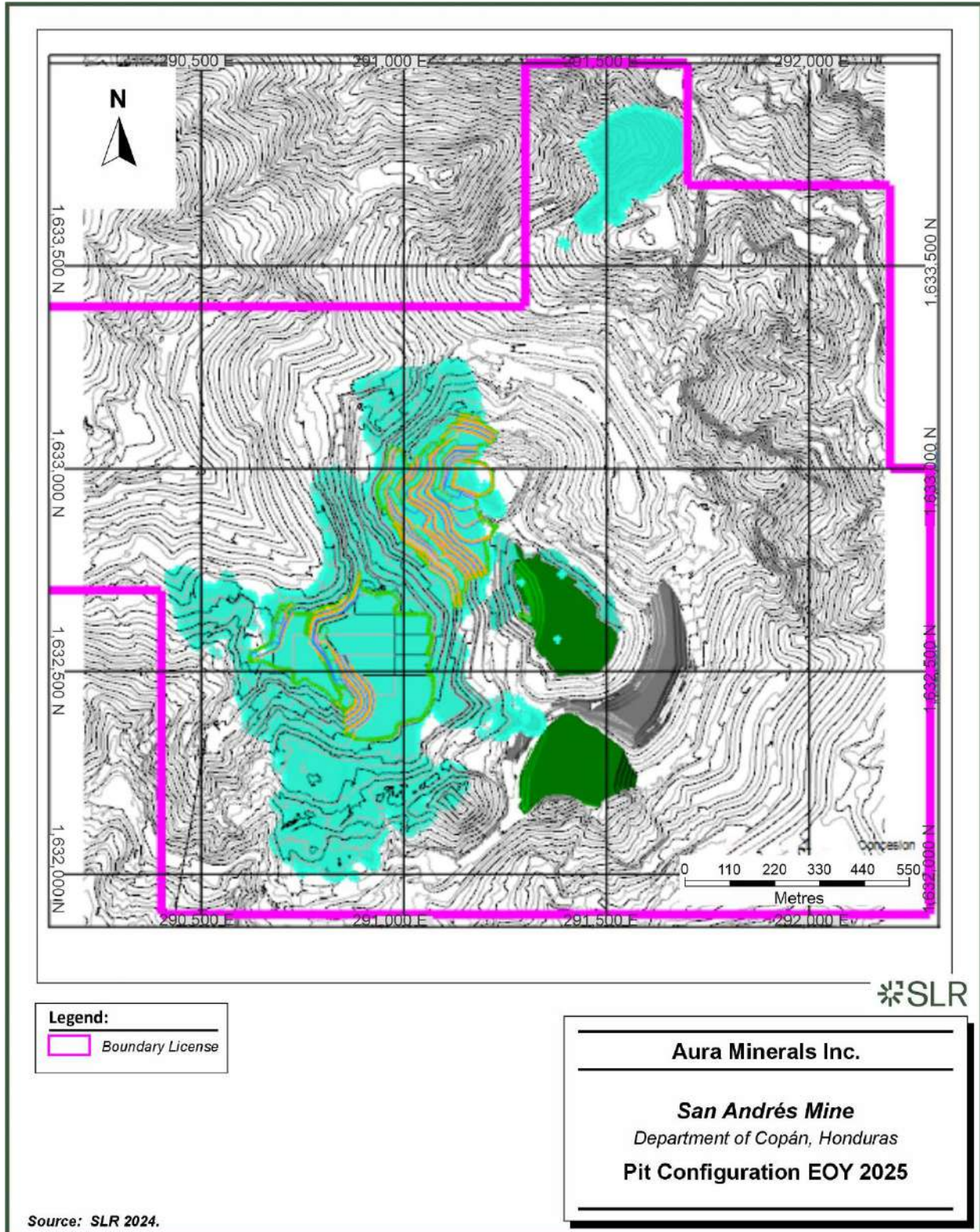


Figure 16-5: Pit Configuration EOY 2026

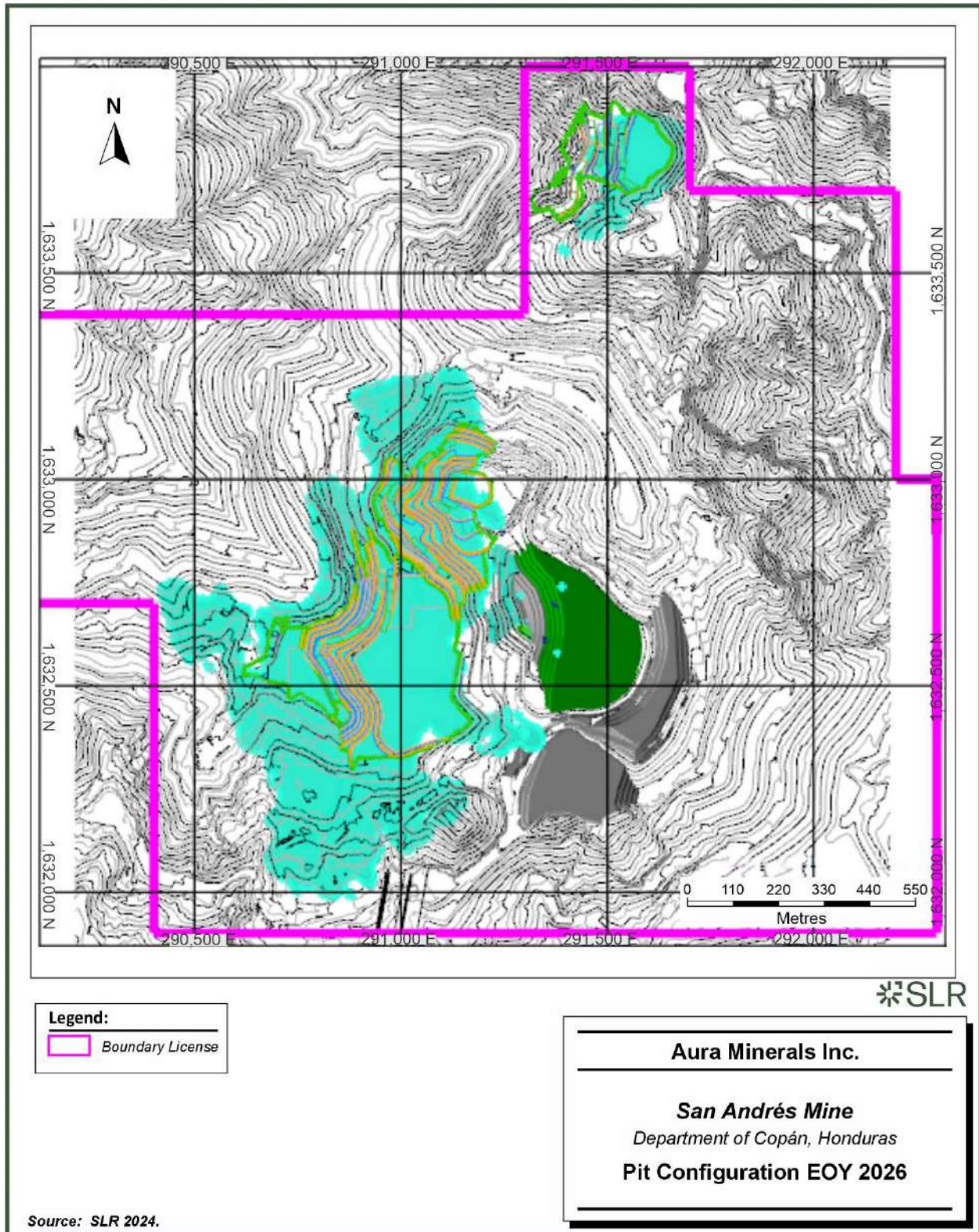


Figure 16-6: Pit Configuration EOY 2027

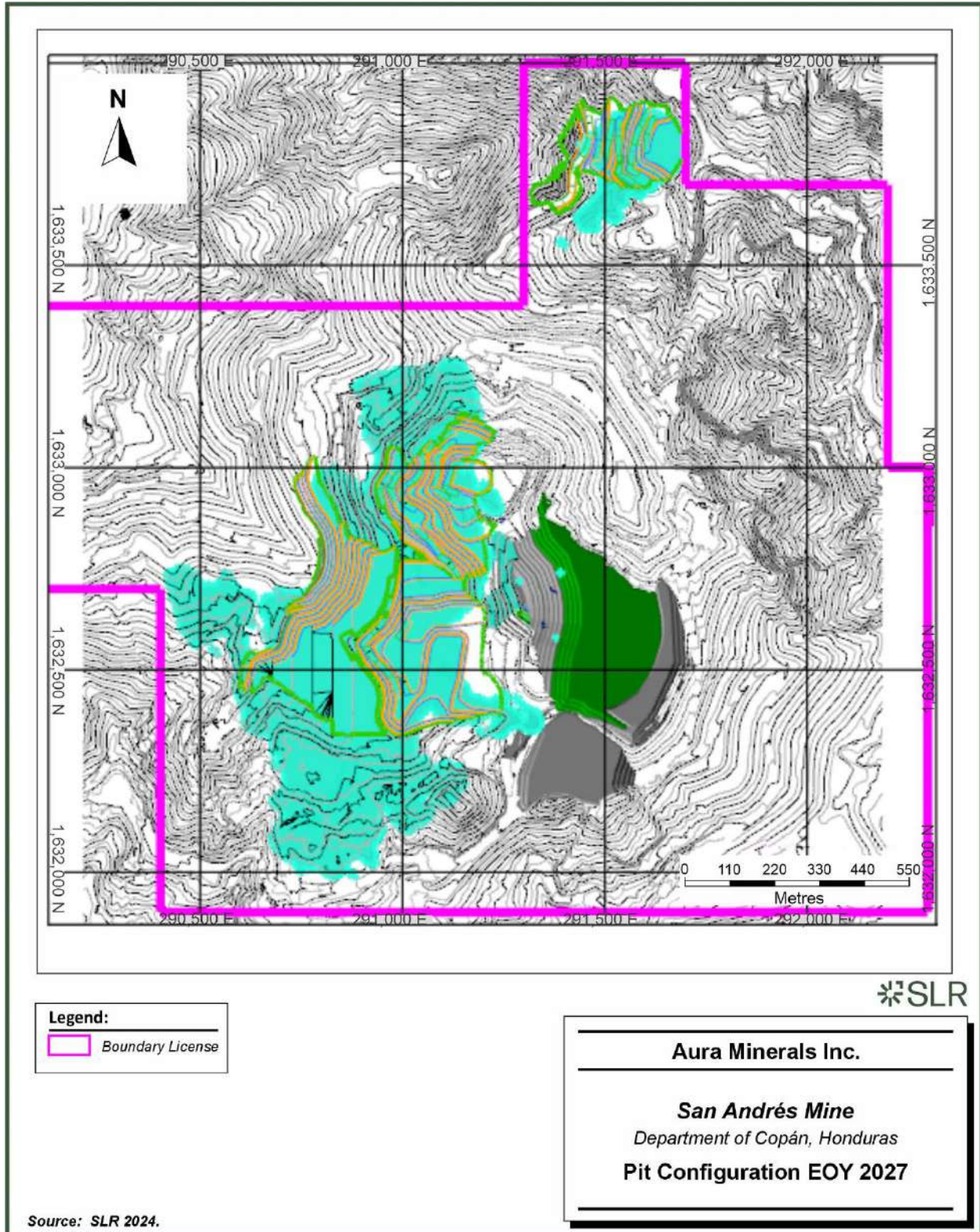


Figure 16-7: Pit Configuration EOY 2028

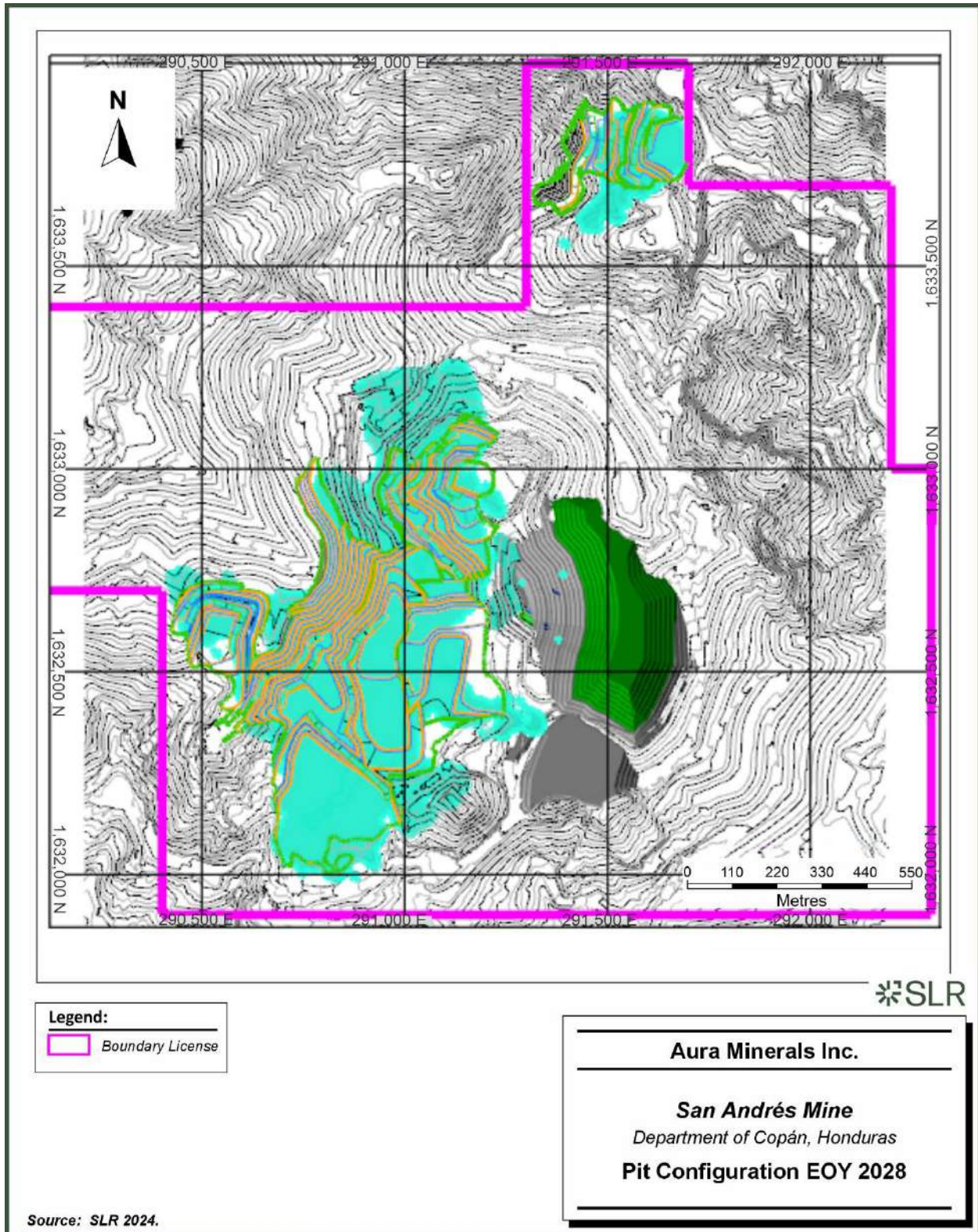
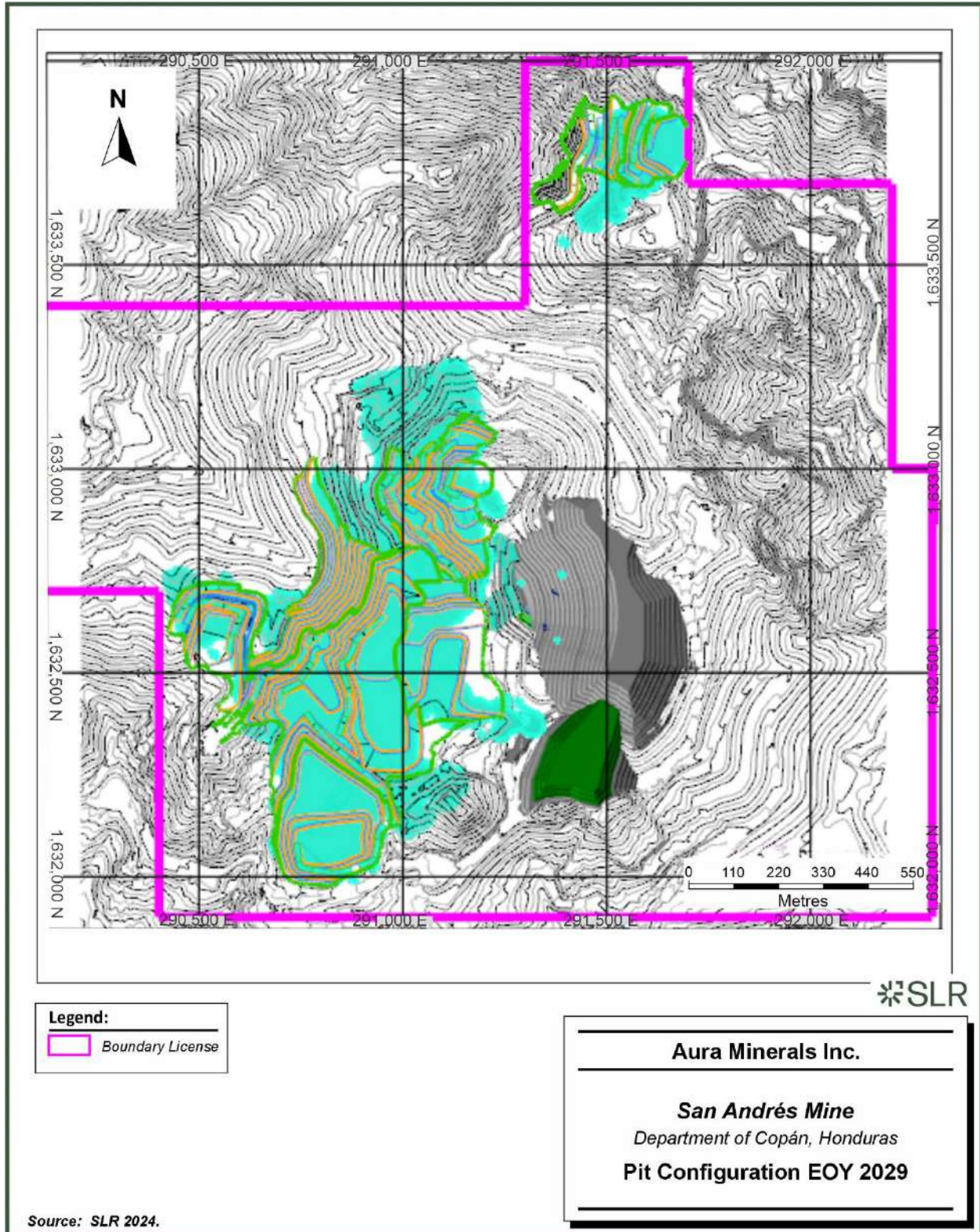


Figure 16-8: Pit Configuration EOY 2029



17.0 Recovery Methods

The San Andrés Mine employs a heap leach processing method for the recovery of gold from mined ore. This method has been selected due to its proven effectiveness in treating the oxide and transition ores characteristic of the deposit. The processing infrastructure is well-developed and includes crushing circuits, agglomeration systems, HLPs, and an ADR plant for gold extraction and refining.

17.1 Plant Throughput and Design

The processing plant is designed for a throughput of approximately 7 Mtpa. Key equipment and their capacities are detailed in Table 17-1.

Table 17-1: Plant Throughput

Stage	Equipment	Capacity
Primary Crushing	Jaw Crushers	1,200 tph
Secondary Crushing	Cone Crushers	1,500 tph
Agglomeration Drums	Rotary Drums	800 tph each
Stacker	Mobile Conveyor	1,200 tph
ADR Plant (CIC Circuit)	Carbon Columns	10,000 m ³ /day

17.2 Summary Process Description

The overall process is divided into the following unit operations:

- 1 Ore Hauling and Crushing:
 - Mined ore is hauled by a fleet of trucks to two primary crushing circuits equipped with jaw crushers.
 - The crushed ore, with a target particle size of approximately 7 inches, is conveyed to a secondary crushing system.
 - The secondary crusher further reduces the particle size to 2 inches, preparing the ore for agglomeration.
- 2 Agglomeration:
 - The crushed ore is mixed with lime and cement in agglomeration drums to form uniformly sized agglomerates.
 - Sodium cyanide solution is added during this stage to begin the leaching process and prepare the ore for heap stacking.
- 3 Heap Leaching:
 - Agglomerated ore is stacked on HLPs using mobile conveyors and a stacker.
 - Cyanide solution is irrigated over the ore, percolating through the material and dissolving gold into solution.
 - The leach cycle is approximately 60 days, allowing for complete extraction of gold from the ore.



- 4 Gold Recovery (ADR plant):
 - PLS is collected and processed in the ADR plant.
 - Gold is adsorbed onto activated carbon in a Carbon-in-Column (CIC) circuit.
 - The gold-loaded carbon undergoes desorption, and the resulting solution is processed using electrowinning and smelting to produce doré bars.

17.3 Process Description

17.3.1 Summary

The Mine produces approximately 7 Mtpa of ROM material using conventional drilling, blasting, loading and haul truck transportation. The LOM production plan includes 7.7 Mt of material placed during 2025, 7.3 Mt in 2026, 2027 and 2028 and 1.8 Mt in 2029 for a total of 31.5 Mt. The material is mined and transported by haul truck to either the WRSFs or to the primary crushers for processing. The ore is direct dumped into the feed hoppers of two primary crushers operating in parallel. The primary crushed ore is conveyed to an intermediate stockpile. The ore is drawn from the stockpile from three draw points beneath the pile with feeders which discharge onto a conveyor that delivers the ore to secondary crushing. Lime and cement are added to the secondary crushed product on the conveyor and the material is conveyed to two drum agglomerators operating in parallel. Pre-cyanidation is practiced, dosing sodium cyanide on conveyor 8 after the agglomeration drums. The agglomerated material is conveyed to the HLP where it is placed using conveyor stackers. The placed material is leached with cyanide solution for a period of 60 days, during which time, cyanide-soluble gold is dissolved into solution. After the first leach cycle the leached panel of material is allowed to rest and the entrained solution drains out of the material. After draining, a new lift of material will be stacked over the leached material and the process will be repeated.

The activated carbon in columns method (CIC) is used to recover the gold and silver from solution. Gold and silver are adsorbed onto the carbon until the carbon is loaded to capacity. The loaded carbon is transferred to the ADR plant where the gold and silver are eluted from the carbon with a solution of caustic soda and sodium cyanide under conditions of high temperature and pressure. The eluate is then passed through electrowinning circuits, and the gold and silver are recovered in the stainless-steel mesh cathodes and precipitated sludge in the cells. The precious metal sludge is recovered from the cells, dried and retorted for mercury recovery and smelted in a furnace to produce doré metal ingots for sale.

The eluted carbon is reactivated by an acid wash with hydrochloric acid and then taken to a high temperature rotary kiln prior to recycling the carbon to the carbon columns for continued adsorption of gold.

17.3.2 Crushing

17.3.2.1 Primary Crushing

ROM material is delivered to the feed hopper of one of two primary crushing lines.

Line One

ROM ore is direct dumped in the primary crushing feed bin. The material is withdrawn from the bin using a TeleSmith 22 ft x 10 ft vibrating grizzly feeder with 6 in. bar spacing. The grizzly feeder undersize material passes through to the primary crusher discharge conveyer bypassing



the primary crusher. Grizzly feeder oversize material flows to a TeleSmith 5556 jaw crusher with a 300 hp drive. The crusher is operated at a 7 in. closed side set and operated at rate of between 1,000 and 1,200 t/h. The primary crusher discharge material and grizzly undersize material are combined on the primary crusher discharge conveyor which transports the material to the stockpile feed conveyor which conveys the material to the intermediate crushed ore stockpile. The primary crusher discharge conveyor is equipped with a weightometer to determine the material feed rate and totalized tonnage, a belt magnet to remove tramp steel from the belt and a metal detector to identify metal that was not picked up by the magnet.

Line Two

ROM ore is direct dumped in the primary crushing feed bin. The material too large for the crusher will be broken with a hydraulic rock breaker and fed to the crusher. The material is withdrawn from the bin using a Nelson Machinery Model EO-FE-001 plate feeder which feeds a Nelson Machinery VG860 vibrating screen with 6 in. openings. The screen undersize material passes through to the primary crusher discharge conveyor bypassing the primary crusher. Screen oversize material flows to a Svedala 1211HD jaw crusher with a 300 hp drive. The crusher is operated at a 7 in. closed side set and operated at rate of between 1,000 tph and 1,200 tph. The primary crusher discharge material and screen undersize material are combined on the primary crusher discharge conveyor which transports the material to a series of 42 in. conveyors that ultimately feed the intermediate crushed ore stockpile. The primary crusher discharge conveyor is equipped with a weightometer to determine the material feed rate and totalized tonnage, a belt magnet to remove tramp steel from the belt and a metal detector to identify metal that was not picked up by the magnet.

17.3.2.2 Intermediate Crushed Ore Stockpile

The crushed ore stockpile has a 75,000 short ton capacity. The ore is drawn from the stockpile from three draw points beneath the pile with belt feeders which discharge onto a conveyor that delivers the ore to a Simplicity Terex VG860 6 ft. x 12 ft. secondary vibrating grizzly feeder with 2 in. bar spacing, a 120 hp drive and a 1,200 tph capacity. Lime is added to the grizzly feed conveyor to adjust the pH and moisture content of the material prior to agglomeration.

17.3.2.3 Secondary Crushing

Secondary grizzly undersize (-2") falls to the secondary crusher discharge conveyor. Secondary grizzly oversize material (+2") is crushed in an open circuit 7 ft. Simons Standard cone crusher with a 500 hp drive. The secondary crusher discharge material and screen undersize material are combined on the secondary crusher discharge conveyor which transports the material to the agglomerator feed conveyor.

17.3.3 Agglomeration

Cement is added at 2.0 kg/t to the agglomerator feed conveyor from three cement silos installed adjacent to the belt. The belt then delivers the crushed material to a distributor which divides the flow between two 12 ft diameter by 60 ft. long drum agglomerators operating in parallel. The agglomerators have 800 tph per drum capacity and rotate at seven revolutions per minutes (RPM)

17.3.3.1 Auto Sampler

The autosampler, installed in the agglomerator feed conveyor (conveyor 4) continuously monitors ore conditions. Its main function is to obtain representative samples of the stacked ore,



thus allowing a control of the ore. The sampling system operates in designated shifts, following a schedule for complete coverage.

Samples are collected during shifts A-1, which runs from 6:00 am to 12:00 pm, A-2 (12:00 pm to 6:00 pm), B-1 (6:00 pm to 12:00 am) and B-2 (12:00 am to 6:00 am). allowing evaluation of leaching conditions throughout the operation cycle.

The collected samples are subjected to detailed analysis in the metallurgical laboratory, where the granulometry of the ore, gold content and its recovery are examined. These analyses provide the information required to make operational adjustments.

17.3.4 Heap Leach Pad

17.3.4.1 Heap Leach Feed Conveyors and Stackers

The agglomerated material is conveyed to the HLP and stacked in 26 ft (8 m) lifts using a series of conveyors, including a combination of overland, grasshoppers, high lift, horizontal and stacker conveyors.

The conveyor system that is deployed from the agglomerators begins with conveyor 7, which receives the ore already agglomerated and discharges it into conveyor 8. In conveyor 8, a pre-cyanidation system is implemented, dosing sodium cyanide, ensuring an even distribution of this key reagent. The material is then transferred to conveyor 8, which also has a sodium cyanide dosing system.

Pre-cyanidation is important since in this way the reaction of the cyanide with the gold begins, forming complex ions that later in the yards will only need to be dragged by the irrigation solution.

Recently, conveyor 9 was divided to incorporate conveyor 9x, which discharges the ore in a specific area to be later stacked by dump trucks, this conveyor only comes into use when there are movements or maintenance on components following the normal conveyor 9. Normal conveyor 9 continues its journey and discharges into conveyor 10, which, in turn, discharges into conveyor 11. This pattern is repeated in successive conveyors until it reaches conveyor 13.

Conveyor 13 discharges into a series system of 13 grasshoppers with the same characteristics, which constitute a set of conveyors that facilitate the continuous movement of the ore. This system is discharged into a high lift, which, in turn, discharges onto a horizontal conveyor that carries the ore to the stacker. The stacker has the main function of stacking the ore in an orderly manner.

It should be noted that, in order to maintain the integrity of the agglomerate, the stacker must manage a controlled fall of the ore, limited within a range of 8-10 m. This is implemented to prevent compaction of the ore, as excessive height could compromise the integrity of the agglomerate (breakage), thus decreasing the efficiency of the overall process.

It is important to note that the grasshopper, high lift, horizontal and stacker systems are mobile, which allows greater versatility when changing the stacking areas.

Table 17-2 summarizes the specifications for each of the conveyors mentioned above.



Table 17-2: Summary of Agglomerator Conveyors

Conveyor	7	8	9	10	11	12	13
Width (in.)	48	48	36	36	42	48	36
Length (ft)	-	380.5	735	455	370	885	688
Capacity (stpd)	1,200	1,200	1,200	1,200	1,200	1,200	1,200
Speed (ft/min)	351	403	509	511	575	370	575
Power (hp)	300	100	250	250	200	250	300

Conveyor	GrassHoppers	Highlight	Horizontal	Stacker
Width (in.)	36	36	36	36
Length (ft)	132	100	140	46.7
Capacity (stpd)	1,200	1,200	1,200	1,200
Speed (ft/min)	521	521	570	534
Power (hp)	60	60	60	125

17.3.4.2 Bypass Stockpile for Maintenance and Conveyor Moves

The bypass stockpile at the end of conveyor 9x, is used to stockpile heap leach pad feed material that is being conveyed to the leach pads for short periods of time, allowing time for specific situations, such as maintenance of conveyor components after conveyor 9 or movements of conveyors in the stacker system, and is characterized by its ability to receive large volumes of agglomerated ore temporarily. Its main function is to provide operational flexibility to the system, allowing the controlled accumulation of material in situations where the normal flow to the stacker is interrupted.

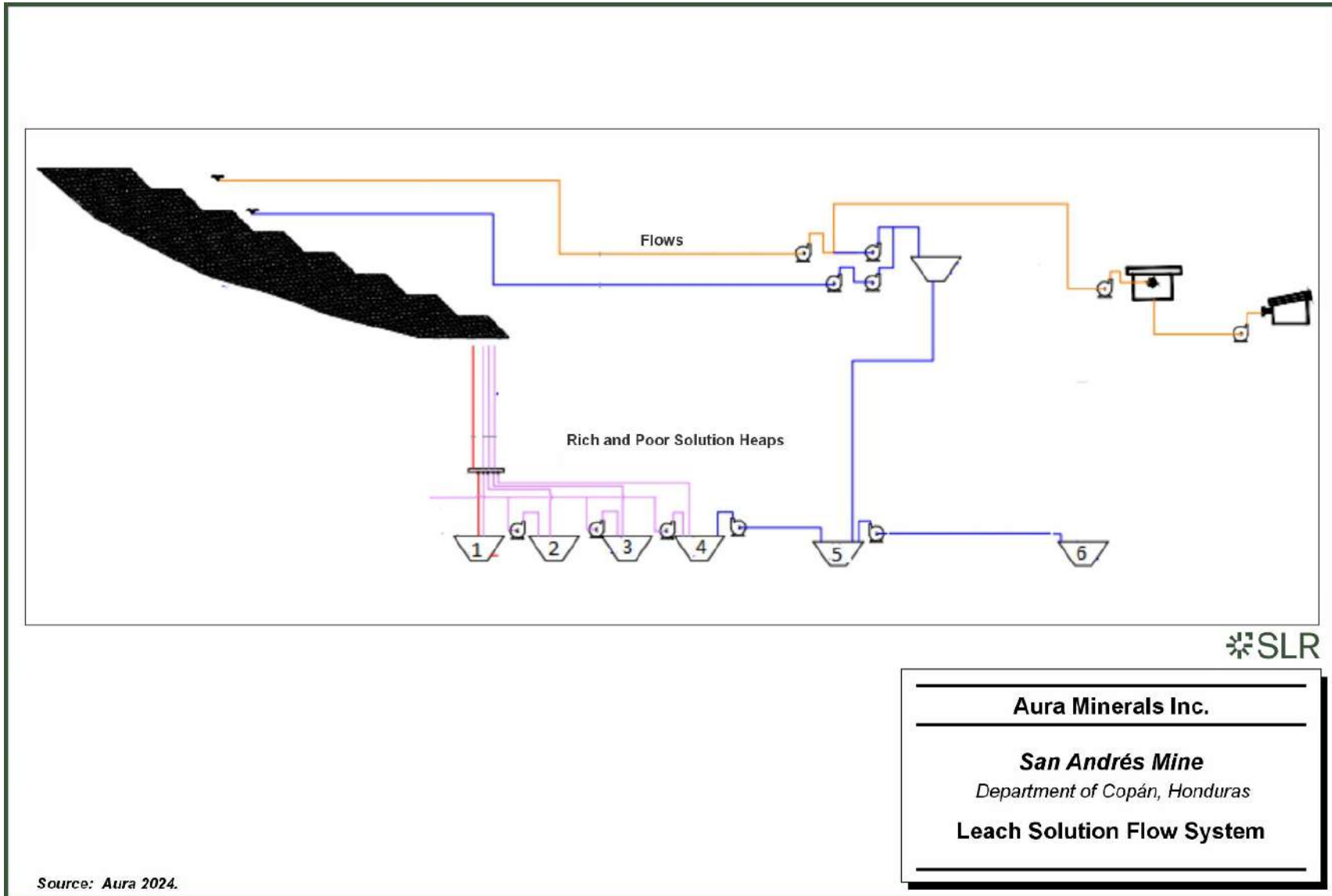
The stockpiled material will be reclaimed using dump trucks. This approach helps to minimize interruptions in production and maintain the efficiency of the overall process, ensuring effective management of the material flow in contingent situations.

17.3.4.3 Leach Solution Flow System

Figure 17-1 illustrates the leach solution flow system.



Figure 17-1: Leach Solution Flow System



Leach Panels

Panels are defined areas where a specified volume of ore is placed for controlled leaching. Solution is delivered to the panels using a piping grid and calibrated drip emitters to deliver the specified amount of cyanide leach solution per unit area to the pad. A perforated piping system beneath the panels just above the liner captures the leach solution, taking it to a central sump from where it is directed to the heaps or to the ADR plant.

Heap Leach Solution Ponds

In the operation's flow system, heap leach ponds play an essential role in solution management. There are a total of six high-capacity ponds, numbered from 1 to 6, and an additional pond called the "relay pond". Each of these stacks serves specific functions in the process.

The first three ponds, numbered from 1 to 3, are mainly intended to contain solutions with gold values from the leach pads, presenting decreasing concentrations in sequential order. Pond 1, used to hold PLS (gold-bearing leach solution), stores the gold-rich solution. Pond 2 contains solution with intermediate values (ILS [intermediate leach solution]), and Pond 3 stores the gold-poor solution from the panels or ADR plant.

Pond 4 is usually maintained with a limited amount of solution, reserving it for contingency situations. This stack acts as an additional, strategic resource in case of unexpected variations in the process.

Ponds 5 and 6 serve a dual purpose. In addition to storing water, they are used for water treatment when it is necessary to discharge into a natural tributary. This approach reflects a commitment to sustainable and responsible practices in water resource management.

The "relay pond" is used to make up leach solution from the barren ADR to be pumped to the leach pads for gold recovery. The low-concentration (barren) solution stored in the relay pond is mixed with a high-concentration cyanide solution to achieve an NaCN concentration of around 400 ppm (parts per million), an optimal level to start the leaching process efficiently.

Table 17-3 lists the capabilities of the heap leach ponds.

Table 17-3: Heap Leach Pond Capacities

Pond	Capacity (m ³)
1	39,351.7
2	54,687.5
3	51,929.1
4	166,277.7
5	164,467.9
6	83,278.8

Leachate Solution Distribution Box

The leach solution distribution box is connected to different leach pads, specifically to ponds 1 to 4, each intended to receive the solution based on the concentration of gold. This modular design allows for considerable operational flexibility. The piping and valve system provides operators with the control needed to adjust the distribution based on gold concentration analysis.

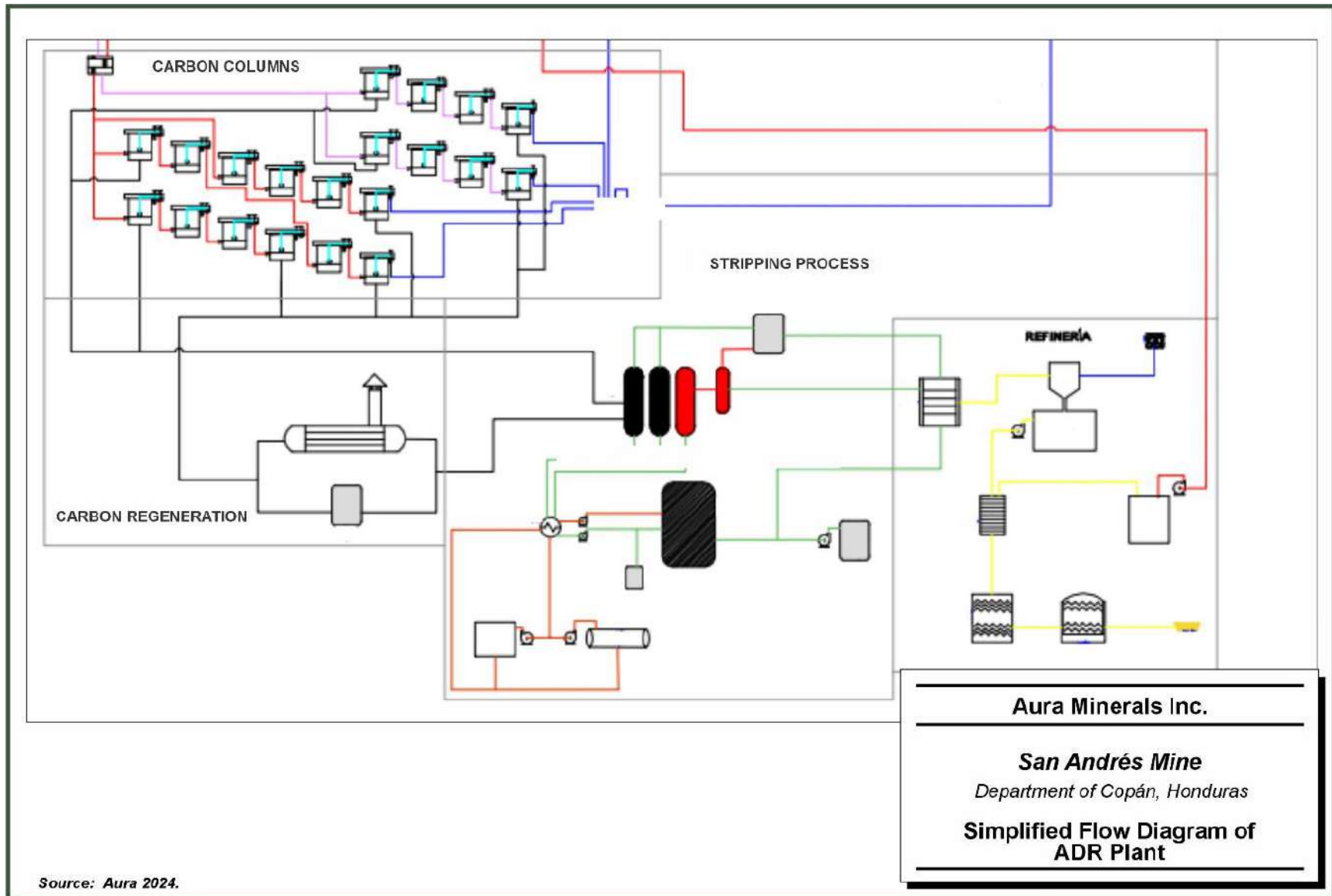


17.3.5 ADR Plant

Figure 17-2 presents the simplified flow diagram of the ADR plant.



Figure 17-2: Simplified Flow Diagram of ADR Plant



17.3.5.1 Carbon Column System (CIC)

The Carbon-in-Column (CIC) system is organized in trains and is composed of activated carbon columns designed for the selective adsorption of gold from the leachate solution.

The columns operate sequentially, receiving the leachate solution from the solution storage ponds, passing through a box that serves to filter and regulate the flow to the columns. In these columns, activated carbon selectively adsorbs the gold present in the solution.

The carbon columns are designed to process 10,000 m³/day in each train and the plant has a capacity to work with up to 6 trains, which can be exchanged between PLS and ILS trains, depending on the need of the operation.

17.3.5.2 Acid Washing of the Loaded Carbon

Acid washing of the loaded carbon is performed in a separate acid wash column after to elution. The loaded carbon is subjected hydrochloric acid washing to dissolve carbonate scale and some impurities in preparation of elution.

17.3.5.3 Elution Columns

Once a column reaches its maximum adsorption capacity, the carbon is removed and transferred to elution columns where they undergo the elution process, generating a gold-rich solution. The loaded carbon is contacted with a solution of caustic soda and ethanol, the ethanol interacts with the surface of the activated carbon, breaking the adsorption forces between the gold and the adsorbent. This process is carried out under controlled temperature and pressure conditions to optimize the efficiency of desorption. Once eluted, the gold is recovered from the eluate, while the activated carbon can undergo a regeneration cycle for reuse in future adsorption processes.

17.3.5.4 Rich Solution Tank

The rich solution tank is designed to store the gold-rich solution from the desorption process providing a surge tank for feeding the electrowinning circuit. It allows controlled and continuous flow of the rich solution into the electrowinning cells, where the electrodeposition of the gold will be carried out for recovery.

17.3.5.5 Lean Solution Tank

Analogous to the tank mentioned above, this tank is a temporary reservoir that retains the lean solution from the electrowinning system in the electrowinning cells. This residual solution with low gold values is then used again in the desorption process.

17.3.5.6 Thermal Carbon Regeneration

Eluted carbon is reactivated in a high temperature rotary kiln prior to recycling the carbon to the carbon columns for continued adsorption of gold. During the thermal regeneration process, the heat generated breaks down and removes impurities, thus revitalizing the carbon's adsorption capacity.

17.3.5.7 Electrowinning

Gold is recovered from the rich gold eluate by electrowinning resulting in the deposition of metals, including gold, in stainless steel cathodes. The gold-rich solution flows through the



electrowinning cells at a controlled voltage and the ions of gold and other metals in the solution are reduced at the cathodes, forming solid deposits on the surface.

17.3.5.8 Cathode Washing

The SS cathode mesh used in the electrowinning cells is washed to extract the metal sludge deposited in them. Once the cathode mesh material is loaded with metal precipitate, they are removed from the cell and pressure washed, this procedure is performed using sweep solution, a solution that contains low cyanide, gold and other components. The resulting solution, which carries the solid concentrate, is directed to a filter press in which the sludge is recovered, and the resulting clarified solution is recycled for another process.

17.3.5.9 Retort Oven

The retort furnace operates at a temperature of 880°F (470°C) and is used for drying the gold sludge filter cake from the filter press, and volatilizing the mercury contained in the gold sludge and subsequently condensing and recovering the mercury prior to the smelting furnace.

17.3.6 Melting Furnace

Following retorting the dried gold sludge is mixed with fluxes including borax, silica and potassium nitrate to form a slag to remove impurities and smelted in a furnace at a temperature of 1,200°C to produce doré ingots for sale.

17.4 Energy, Water, and Material Requirements

The processing plant's operational needs are as follows:

- Energy:
 - The facility requires approximately 15 MW of electrical power, sourced from the regional grid.
- Water:
 - The process water demand is met through recirculated solution from the leach pads, supplemented by freshwater from permitted sources.
 - Total water usage is estimated at 60,000 m³/day of recirculating water. No external water is used.
- Consumption of Process Materials during 2023:
 - Sodium cyanide: 3,360 tonnes/year
 - Cement: 12,741 tonnes/year
 - Activated carbon: 74 tonnes/year
 - Caustic soda: 386,795 tonnes/year
 - Alcohol: 1,010,000 tonnes/year
- Personnel Requirements
 - The processing plant operates with a team of 200 personnel, including operators, maintenance staff, and metallurgists, working in rotating shifts to maintain continuous operation.

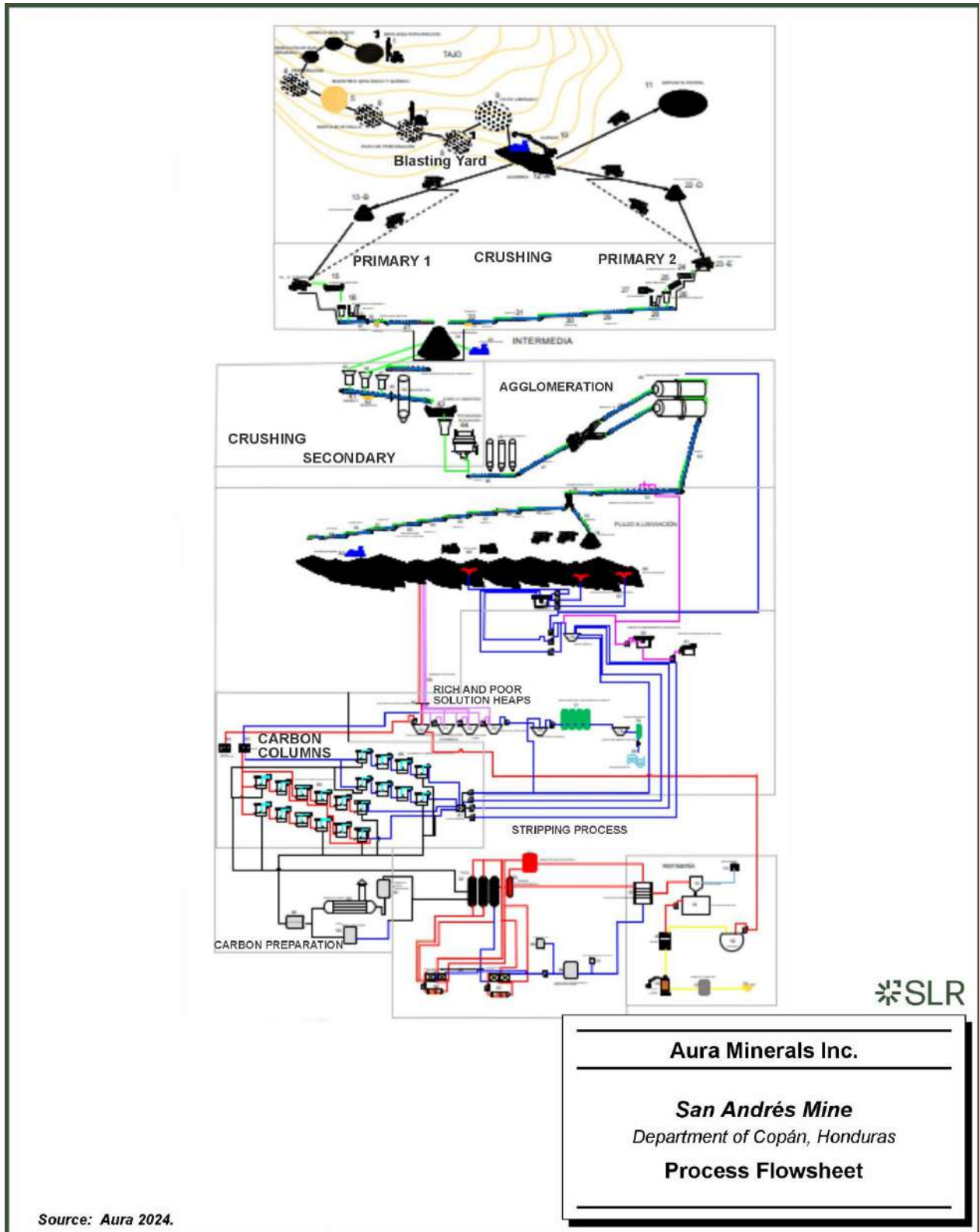


17.5 Process Flow Sheet

A simplified flow sheet of the San Andrés processing plant is presented in Figure 17-3, illustrating the key stages from ore hauling to doré production.



Figure 17-3: Process Flowsheet



Source: Aura 2024.



18.0 Project Infrastructure

The San Andrés Mine infrastructure supports its mining, processing, and administrative operations efficiently and reliably. The facilities and systems have been developed over decades, ensuring alignment with operational needs and compliance with environmental standards.

18.1 Heap Leach Pad

SLR has reviewed the information, analysis, and conclusions from the following documents for the review of the HLP:

- San Andrés Open Pit and Heap Leach Pad Slope Stability Assessment, SRK Consulting (U.S.), Inc., 136400.050, June 17, 2021 (SRK 2021).
- Reporte Mensual Monitoreo Geomecanico para el Mes de Septiembre, Gerencia de Mina / Departamento de Geomecanica (Minosa), / Realizado por: Carlos Desayes, 7/10/2024 (Minosa 2024a).
- PowerPoint Presentation “Pad de lixiviación – LOM”, January 2025

The ore is stacked on the leach pad in eight metre lifts on top of the previously leached ore that has been mined and prepared. The ore is leached for an average of 60 days before allowing the area to dry and prepare for the next uplift. The solution used for leaching comes from the ADR plant after the cyanide concentration has been replenished.

The HLP has been built in multiple phases.

- The first four phases of the HLP were designed by SRK, based out of Denver, USA.
- AMEC, based out of Denver, USA, designed Phase V, which was built in stages with the first stage completed in 2013.
- AMEC also designed Phase VI of the HLP. Phase VI was built in stages.
 - The first stage, Stage 1A, was completed during the period 2016–2017.
 - Stage 1B was completed during 2018–2019.
 - Stage 2 was built during 2020–2021.

Originally, the Phase VI HLP provided approximately 9.5 million m³ of ore storage. The current Phase VI HLP expansion (without considering the capacity update being completed by Minosa – see below) consists of a 27.5 ha pad, with stages 1A and 1B partially overlapping the existing Phases IV and V.

Stability of the HLP was evaluated most recently for the then-current HLP configuration, and for three options for final loading of the leach pads (SRK 2021). For each of the cases, a numerical stress-deformation model was developed along critical cross-sections. The deformations of the stacked ore and also the impacts of deformations on the base liner geomembrane system were evaluated. For all scenarios, it was concluded that the deformations were acceptable, and did not represent failure of the slope or of the liner (SRK 2021).

In order to validate the deformation analyses, SRK recommended the application/installation of monitoring instrumentation, including satellite InSar monitoring System, topographic monitoring stations, automatic total station, piezometers, inclinometers, and a seismograph. SLR reviewed



the monthly monitoring report prepared by Minosa in October 2024 (Minosa 2024a) and offers the following conclusions:

- Monthly monitoring is being completed by Minosa personnel.
- The recommended monitoring system was applied, with the exception of the seismograph, which was not mentioned in the report.
- The HLP is performing within design parameters, based on instrumentation readings.
- The monitoring report also includes monitoring of the operational and stormwater management ponds associated with the HLP.

Minosa has updated the capacity of the HLP based on internal evaluations and engineering studies conducted by Kappes, Cassiday & Associates (KCA), refining the original SRK design. As of January 1, 2025, the estimated remaining capacity of the existing heap leach facility is 21.6 Mt, which is below the projected Life of Mine (LOM) ore tonnage of approximately 30.5 Mt.

To address this shortfall, Minosa is advancing multiple expansion projects to ensure sufficient leaching capacity:

- Phase VI Expansion (green area in Figure 15-1) – Planned to add 3,418,555 tonnes.
- Expansion Phase VI (purple area in Figure 15-1) – A larger expansion expected to provide an additional 10,227,416 tonnes.
- High-Rise Expansion (blue area in Figure 15-1) – Evaluated for an estimated 5,338,526 tonnes of added capacity.

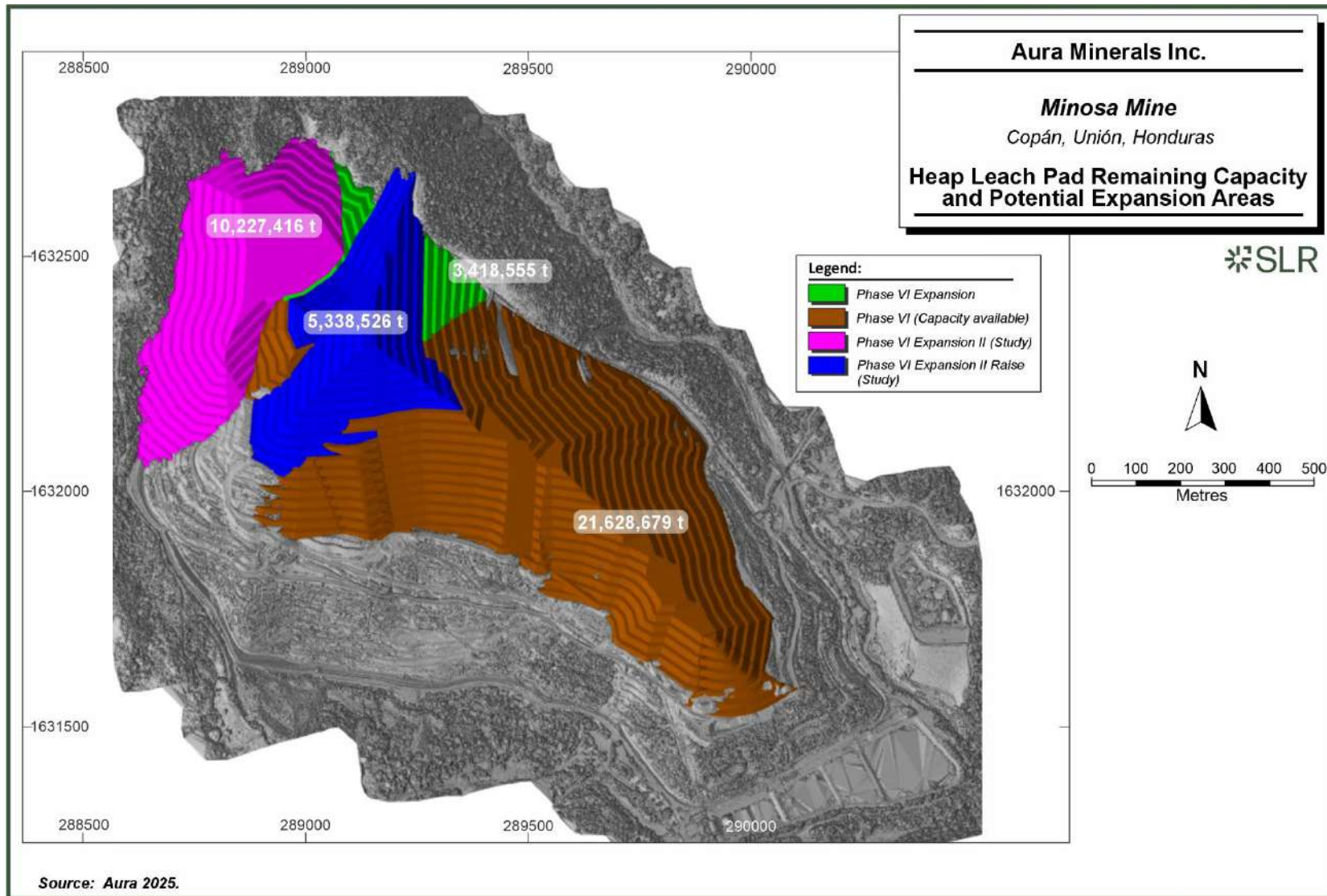
If all planned expansions are completed, the total HLP capacity would increase to 40,613,176 tonnes, exceeding the LOM requirement.

Geotechnical assessments for these expansions are being conducted by SRK, and engineering studies are ongoing with KCA. Minosa has indicated that these projects are expected to provide the required capacity for processing the declared Mineral Reserves. However, SLR has not had access to the capacity studies or stability evaluations of these expansions and therefore cannot provide an independent opinion on their feasibility at this time. A third-party validation of the estimated HLP capacity and associated stability is recommended to support the planned expansions.

The water management system of the HLP is comprised of six ponds, Pond 1 (pregnant leach solution), Pond 2 (intermediate leach solution), Pond 3 (barren solution), Pond 4 (water from rainfall), Pond 5 (water from rainfall), and Pond 6 (contact water). Ponds 1 to 4 were developed for phases 1 and 2 of the HLP operations and remain active. Ponds 5 and 6 were added later in 2006 and 2011, respectively. Minosa is planning to decommission Pond 5 to expand the footprint of the HLP. As part of the expansion project, Minosa is planning to expand Pond 4 and build a new pond south of the HLP, referred to as New Pond 5 (SRK 2024). All ponds are lined with geomembrane. Water is discharged from Pond 6 to the environment. Excess water collected in the HLP water management system is conveyed to a water treatment plant before being released to the environment downstream of the confluence between the Lara River and the Casas Viejas Creek. The water treatment plant is designed to neutralize cyanide, mercury, arsenic, selenium, sulphates, and cobalt.



Figure 18-1: Heap Leach Pad Remaining Capacity and Potential Expansion Areas



18.2 Water Supply

Water for operational use is sourced entirely from rainwater runoff, collected and stored in surge ponds. No external water sources are required for processing, reducing the Mine's environmental footprint.

Potable water for employees is purchased from a qualified provider and delivered to office and camp facilities.

Water for office areas is supplied by water trucks, ensuring consistent availability for non-operational use.

18.3 Purchasing and Warehousing

The purchasing and warehousing team is an in-house operation, equipped to handle all logistical needs.

Warehouse facilities are adequately designed to store chemical products, diesel, and spare parts, ensuring safe and organized inventory management.

The warehouse infrastructure supports continuous operations with sufficient stockpiling and streamlined procurement processes.

18.4 Offices and Shops

The Mine has a main office building located on-site, housing administrative and technical staff in a centralized, open-plan workspace.

Additional office spaces are located near the processing plant and mine areas, supporting operational management and coordination.

There are two dedicated shops:

- One for maintaining stationary equipment and the company's mobile equipment.
- One utilized by the contractor, supporting maintenance for loading and hauling equipment.

18.5 Communications

The mine site is equipped with optical fiber infrastructure, providing high-speed internet access across major facilities.

Radio communication services ensure seamless communication between operational teams.

Cellular service is available throughout the site, facilitating efficient coordination and safety protocols.

18.6 Accommodations

The on-site camp facility includes 45 accommodations, primarily used for visiting personnel or contractors.

Most employees reside in nearby communities, reducing reliance on on-site housing while supporting local development.



18.7 Energy Supply

The Mine is connected to the Honduran national power grid managed by Empresa Nacional de Energía Eléctrica (ENEE), ensuring reliable and cost-effective energy for its operations.

A diesel power generation system is maintained as a backup to ensure uninterrupted operations during grid outages.

Table 18-1: Capacity of Diesel Powered Generators

	Installed Capacity, MW	Available Capacity, MW
Generator 1	2	1.4
Generator 2	1.75	1.225
Generator 4	2	1.4
Generator 5	2	1.4
Total	7.75	5.43

18.8 Transportation and Access

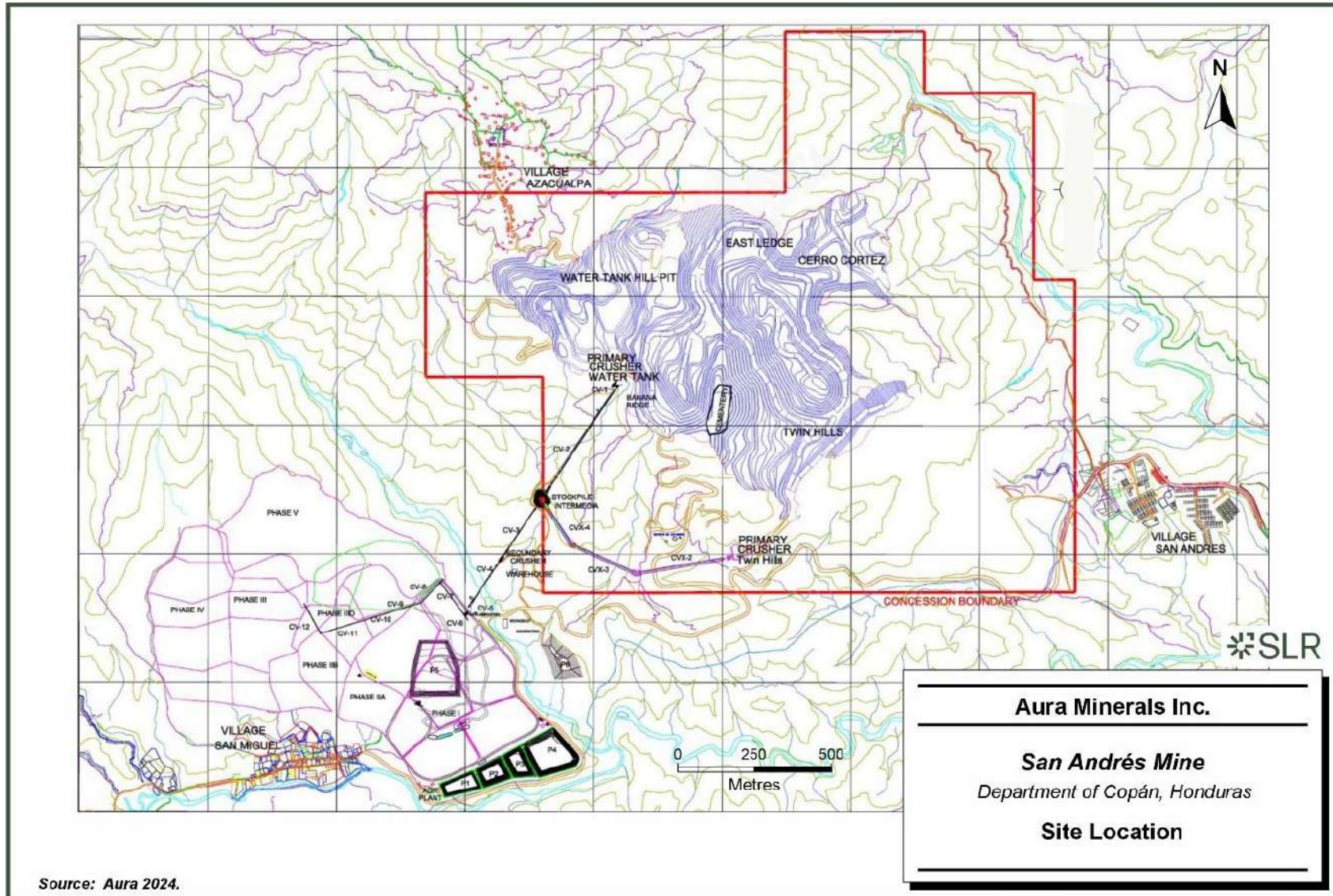
The Mine is accessible via a network of paved highways and gravel roads, facilitating efficient transport of materials, equipment, and personnel.

Internal roadways connect the various operational areas, designed for safe and efficient movement of heavy equipment.

The site includes a helipad, primarily used for the transportation of Dore production and, when required, for personnel transfers and emergency medical evacuations. Figure 18-2 provides the general site layout for the Mine.



Figure 18-2: Infrastructure Layout



19.0 Market Studies and Contracts

19.1 Markets

The principal commodity produced at the San Andrés Mine is gold, which is freely traded on global markets. Gold pricing is transparent, and there is a well-established market for the sale of gold doré. Aura does not rely on specific off-take agreements or long-term contracts for gold sales, and no material issues are anticipated regarding the marketability of future production.

The Mineral Reserve estimates for the San Andrés Mine are based on a gold price of US\$2,000 per ounce, which is within market consensus for long-term pricing. This assumption is consistent with those used across other Aura operations and reflects a price level that is broadly accepted within the mining sector for reserve estimation purposes.

No external market studies or consultants were relied upon for metal price forecasts. The Qualified Person (QP) considers the selected price assumptions to be reasonable and appropriate for the San Andrés Mine, given prevailing market conditions and comparable projects in the industry.

19.2 Contracts

The San Andrés Mine operates under several key contracts that align with industry standards.

These include:

- **Mining Haulage Contract:** The primary mining contractor was recently awarded, via a competitive tender process, to a new Honduras-based company. This demonstrates the availability of local expertise and resources to support mining operations.
- **Explosives Supply Contract:** Explosives are procured under a long-term agreement with a qualified supplier, ensuring consistency in availability and pricing.
- **Cyanide, Lime, and Cement Supply Contracts:** These essential commodities are supplied through industry-standard contracts that ensure reliable supply chains.
- **Diesel and Power Supply:** The mine sources fuel and power under standard commercial agreements. As noted in Section 4.4, power supply has been diversified through connection to the national grid, reducing costs significantly.

The terms of these contracts are consistent with those negotiated in similar operations across the mining industry and are periodically reviewed to ensure competitiveness and compliance with operational requirements.

The current framework of agreements and contracts supports the stable operation of the San Andrés Mine. Contracts are negotiated at arm's length and are aligned with prevailing market conditions, ensuring cost-effectiveness and operational reliability. Aura actively manages these contracts to mitigate risks and maintain operational continuity.



20.0 Environmental Studies, Permitting, and Social or Community Impact

SLR based its review on a desktop review and a site visit, including interviews with key environmental, social, and mining staff from Minosa.

20.1 Environmental Studies

20.1.1 Environmental Setting

The EIA (SRK 1998) provides a detailed description of the baseline environment, as summarized below. Existing infrastructure on site included open pits and cyanide heap leach facilities when the baseline studies were conducted and at the time of writing the EIA.

20.1.1.1 Air Quality

The mine site is remote with no existing pollution sources in the vicinity.

20.1.1.2 Geochemistry

Acid base accounting (ABA) and metal leaching tests were conducted on ore, including spent ore, and waste rock samples. Results showed that there is limited potential for acid generation from ore samples, and that drainage from spent ore could contain low concentrations of aluminum, arsenic, and calcium (SRK 1998).

20.1.1.3 Flora and Fauna

Baseline studies were conducted from 1995 to 1997. Three primary and two secondary vegetation communities were identified. The dominant vegetation community is mixed predominantly pine forest which comprises 75% pine mixed with broadleaf species. Ecological importance was calculated for each tree species by plant community and found that *Pinus oocarpa* had the highest importance at 83%. One possible threatened plant species was found but only identified to the genus level, namely *Machaerium* spp. Areas with this species are considered “fragile areas” according to the EIA. There were medicinal plants, weeds, and cultivated plants found such as mango, orange banana, guayabas, plums, papayas, and guava (fruit not native to the area).

Birds were abundant with 76 species observed during fieldwork; however, none were rare, threatened, or endangered birds. Mammals were extremely scarce, likely due to hunting. Bats were abundant and the diversity was noted to be high possibly due to abundant roosting areas in abandoned mines, the absence of most diurnal animals which reduced competition, and cessation of mining activities at night. No endangered, vulnerable, or threatened mammals were observed.

Reptiles were scarce and had little diversity. No dominant, endemic, or threatened species were observed. Fish were also scarce, and no threatened species were found (SRK 1998).

20.1.1.4 Protected Areas

There are no protected areas in the vicinity of the site. The closest protected areas are Protected Area Erapuca (wildlife refuge) located 8.5 km to the southwest and National Park Montana de Celaque located 27 km southeast of Minosa.



20.1.1.5 Land Use

Exploration and mining in the area and at site occurred from the 1930s through 1976. Current surrounding land use includes coffee farming.

20.1.2 Environmental Impacts and Risks

Mitigation measures were specified by the Ministry of Natural Resources and Environment to manage environmental impacts. These mitigation measures, incorporated as requirements of the various secondary environmental licences (Section 20.2), included measures on soil management, ecosystem restoration, fauna and flora management, air quality, water and effluent management, as well as contingency planning with regard to mine worker health and nearby community health. SLR therefore understands that the key environmental risks and impacts lie in these environmental components.

Aura compiled a Mitigation Measures Report in 2023 which states that the Mine must reforest an area equivalent to the expansion areas, and also develop a reforestation program aimed at improving the Lara River Basin, and through a cooperation agreement carry out protection activities in the Erapuca Wildlife Refuge (Aura 2023b). The report summarizes resourcing and implementation of measures around environmental restoration and compensation, wildlife protection, forest species harvesting and protection, and seed bank management. The report is brief and does not provide significant detail, but it does indicate continued implementation of Environmental Management Plans around water and air quality, soil remediation, forest fire fighting, plant production, fauna and flora management activities, and ecosystem compensation.

Aura has several operating procedures in place:

- Effluent control (last revised 23/03/2014)
- Protection and monitoring of flora (last revised 27/05/2022)
- Protection and monitoring of fauna (last revised 27/05/2022)
- Management of contaminated soils (last revised 27/05/2022)
- Reclamation, Restoration, Abandonment and Surrender of Area of Mining Operations (last reviewed 14/05/2024).

These procedures include an objective, responsibilities, and procedures and should be reviewed and updated regularly.

20.2 Project Permitting

The Mine obtained the mining concession in 1983 issued by *Instituto Hondureño de Geología y Minas* (INHGEOMIN) for San Andrés I (355 ha). Aura understands this permit is valid.

The General Law of the Environment (Decree 104-93) established the requirement that any project, industrial facility, or activity that has the potential to impact/pollute or degrade the environment must complete an EIA. The General Law requested the Secretariat of Natural Resources and the Environment (SERNA, now MIAmbiente) to create and manage a National Environmental Impact Assessment Evaluation System (SINEIA) which will oversee the implementation of prescribed measures for protecting the environment. In 2015, the SINEIA was updated to, in theory, streamline the environmental licensing process, facilitate the tracking of compliance, achieve transparency, and strengthen coordination between all relevant stakeholders. The updated system is called System for Simplified Environmental Licensing (*Sistema de Licenciamiento Ambiental Simplificado* [SLAS in Spanish]), which includes among



others, the need for an Operational Environmental Licence, a signed mitigation measures contract, and a Functional Environmental Licence.

The Operational Environmental Licence (*Licencia Ambiental de Operación*) is to be granted by MIAmbiente and is intended to certify that the proponent has complied satisfactorily with all the technical and legal requirements of the environmental licence application process. An Operational Environmental Licence is void once the proponent has obtained the Functional Environmental Licence (*Licencia Ambiental de Funcionamiento*), which is to be used for the actual implementation of the project. MIAmbiente grants the Functional Environmental Licence and certifies that the proponent has complied with all the steps and obligations required by Law to commence operating the project, work, or activity. A Functional Environmental Licence is valid for five years.

The Mine's first EIA was completed in 1998. An initial environmental permit was issued in 2001 for the total project area (355 ha polygon), which covers the same area considered under San Andres I mining concession issued by INHGEOMIN. In addition, Aura obtained through time, secondary environmental licences (most of them, Operational Environmental Licences) for various/small polygons within the original permitted polygon (see Table 20-1, Figure 20-1).

At the beginning of the current Honduran government (2022-2026), an official statement indicated that the approval of mining exploitation permits has been cancelled¹. However, the situation seems to be evolving as the government (working in conjunction with INHGEOMIN) has developed the first National Policy for a Fair and Responsible Mining Business². This Policy is currently being socialized in various locations within the country where mining claims are located.

Aura understands that this initial environmental permit (issued for the 355 ha polygon) is considered to be the overall lifetime environmental licence for the site (Aguilar Castillo Love 2024), and covers the entire polygon area, including both the secondary environmental licences and the Buffa Zone. Aura submitted a request to the environmental authority to confirm if that is the case. SLR understands that Aura is still waiting for the outcome of this administrative process. In the meantime, Aura obtained in January 2025 authorization to cut the trees in Buffa Zone through Resolution DE-PS-002-2025 issued by Instituto Nacional de Conservacion Forestal, ICF, which supports Aura's understanding related to the environmental lifetime licence. Furthermore, Aura's legal counsel indicates that in Honduras there is a positive administrative silence for environmental matters (as per the Administrative Procedure Law – Decree 152-87, Article 50). This means that if the environmental authority does not approve/deny the request for the renewal of an environmental permit within the legal timeframe established as per the regulation, the principle of positive administrative silence applies, and the public administration is obliged to recognize the favourable legal effects of the submitted application. Based on that, Aura understands that the existing secondary environmental licences are still valid. This is also the case for the water-taking permit from Río Lara (218 M 98), which renewal was requested in 2019.

For exploration, Aura has mining and environmental permits for the areas identified as San Andrés III and San Andrés IV. Furthermore, Aura understands that exploration for San Andres I (covering the 355 ha polygon) is also allowed.

¹ <https://www.dw.com/es/honduras-se-declara-pa%C3%ADs-libre-de-miner%C3%ADa-a-cielo-abierto/a-60954221#:~:text=Honduras%20se%20declara%20%22pa%C3%ADs%20libre,DW%20%E2%80%93%2001/03/2022>

² <https://inhgeomoin.gob.hn/politica-minera/>



It appears that Minosa does not have enough capacity in the HLP area to manage the LOM projected material (Section 18.1). Therefore, additional permitting planning should be required.



Table 20-1: Minosa - Environmental Permits

No	Responsible Agency	Number	Description	Permit Type	Approval Date	Expiration Date	Renewal Request Date	Comments
1	INHGEOMIN	San Andrés I-45	Mining Permit	Exploration and Exploitation for a 355 ha polygon	1/27/1983	1/27/2023	9/29/2022	Renewal was requested by Aura. Aura assumes positive administrative silence.
2	INHGEOMIN	San Andrés III - 143	Mining Permit	Exploration and Exploitation	12/21/2021	12/21/2031		
3	INHGEOMIN	San Andrés IV - 142	Mining Permit	Exploration and Exploitation	12/21/2021	12/21/2031		
4	SERNA	187-2001	Environmental Permit	Main Environmental licence for a 355 ha polygon (including Water Tank Hill)	11/19/2001	N.A.		Aura is assuming this is a lifetime environmental license covering all the areas
5	SERNA	071-2012	Twin Hills	Environmental licence for 48.02 ha	3/16/2012	3/16/2014	4/5/2014	Aura assumes positive administrative silence, and these permits covered under the lifetime environmental licence.
6	SERNA	146-2010	Twin Hills Expansion	Environmental Licence for 42.65 ha	11/26/2010	11/26/2012	10/27/2012	
7	SERNA	064-2015	Botadero Twin Hills Norte	Polígono de botadero de 11.93 ha	8/6/2015	8/6/2020	4/8/2020	
8	SERNA	106-2003	East Expansion - Water Tank Hill Open Pit	Environmental Licence for 8.6 ha	5/19/2003			
9	SERNA	– 001-2018	East Ledge Expansion	Environmental Licence for 19.32 ha	1/8/2018	1/8/2023	9/10/2022	Aura assumes positive administrative silence and permit covered under the lifetime environmental licence.
10	SERNA	076-2021	Botadero Sur	Environmental Licence for 21.34 ha	7/2/2021	7/2/2026	N.A.	



No	Responsible Agency	Number	Description	Permit Type	Approval Date	Expiration Date	Renewal Request Date	Comments
11	SERNA	SLAS - 0112 - 2020	Stock Intermedia	Environmental Licence for 4.37 ha	9/2/2020			
12	SERNA	SLAS - 0295 - 2018	A Fault (Operation licence)	Licence for 19.32 ha	10/22/2018	N.A.		
13	SERNA	SLAS - 0119 - 2021	Banana Ridge (Operation licence)	Licence for 3.07 ha	1/18/2022	N.A.		
14	SERNA		La Buffa					Aura is confirming if this area is covered under the lifetime environmental license. Outcome of the process is still to be determined.
15	SERNA	052-2014	Expansion Heap Leach Pad. Phases III y IV	Environmental Licence for 37.24 ha	04/20/2014	04/20/2019	12/21/2018	Aura assumes positive administrative silence and permits covered under the lifetime environmental licence.
16	SERNA	-003-2012	Expansion Heap Leach Pad. Phase V	Environmental Licence for 19.10 ha	10/15/2012	10/15/2017	6/7/2017	
17	SERNA	-101-2016	Expansion Heap Leach Pad. Phase VI	Environmental License for 26.54 ha	10/20/2016	10/20/2021	6/22/2021	
18	SERNA	SLAS - 0467 - 202	Exploration - Concesión San Andrés III	Environmental Permit	10/14/2021			
19	SERNA	SLAS - 0469 - 2021	Exploration - Concesión San Andrés IV	Environmental Permit	10/14/2021			

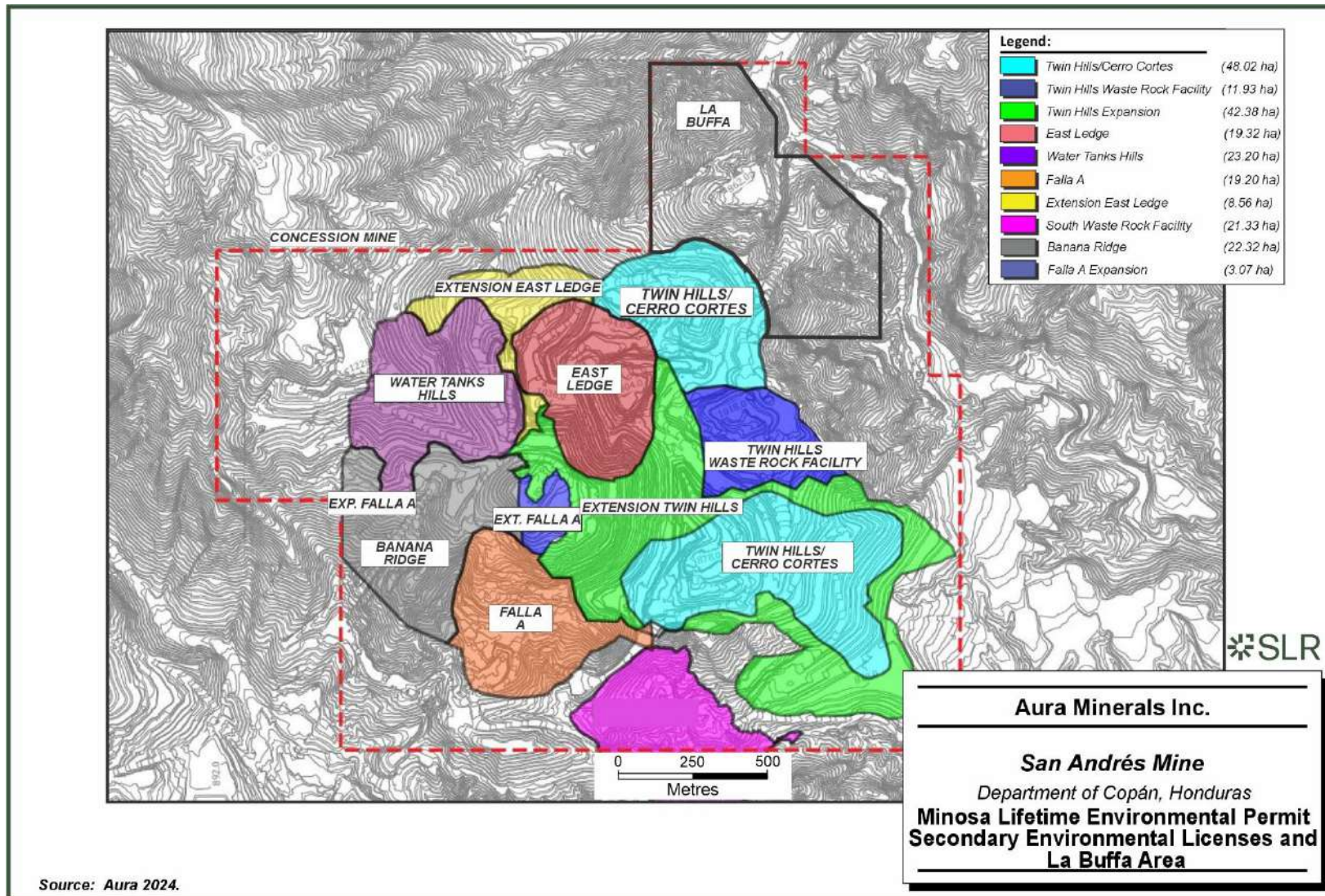


No	Responsible Agency	Number	Description	Permit Type	Approval Date	Expiration Date	Renewal Request Date	Comments
20	SERNA	SLAS - 0061 - 2023	Transmisión Eléctrica MINOSA - Geoplatanares	Environmental Permit for electrical connection to Geoplatanales	3/23/2023	N.A.		

Note: INHGEOMIN: Instituto Hondureño de Geología y Mina, SERNA: Secretaria de Recursos Naturales y Ambiente



Figure 20-1: Minosa Lifetime Environmental Permit, Secondary Environmental Licenses and la Buffa Area



Source: Aura 2024.



Minosa has five wastewater discharges to the environment. They are identified as Represa Sedimentación (RSSW), Quebrada Murcielago abajo Twin Hills (QMATH), Quebrada Calzontillos abajo Twin Hills (QCATH), and Salida Filtro Frances Botadero Sur (SFFBS), and Tuberia Descarga Poza 6 (TDP6). For effluent discharge, The Executive Agreement 003-2020 establishes conditions for the wastewater discharges into waterbodies. The Agreement requires the wastewater discharge registration, and associated discharge authorization

The Mine requested the wastewater discharge registration for effluent discharge TDP6 (effluent from the HLP area) in March 2022. On September 15, 2022, Minosa, and SINEIA signed the updated Provisional Protocol for Wastewater Discharge for this effluent discharge. According to this updated Protocol, Minosa should take some composite water quality samples from Pond 6, pipeline after Pond 6, samples upstream (Lara River and Quebrada Casas Viejas) of the effluent discharge and downstream of this effluent discharge (Lara River, 1000 downstream). The samples are to be sent to an external laboratory. In addition, there is a need to measure flows to ensure the effluent discharge is up to 10% of the waterbody flow at the time of the discharge. Once the samples show that there are no exceedances, the wastewater can be released, and composite samples should be taken daily during the discharge to ensure water quality meets the criteria. If an issue is detected, the discharge should be stopped, and water treatment adjusted accordingly. Minosa understands based on the discussion with the regulators that this Protocol is the discharge authorization for this effluent discharge.

20.2.1 Project Compliance Reports

The Environmental Control Measures Compliance Reports (*Informe de Cumplimiento de Medidas Ambientales*, or ICMA) are required for projects with environmental licences. The reports are required throughout the life of the project, including its construction, operation, and closure stages. The ICMA is the report where the proponent can document compliance, and the associated potential mitigation measures established in the EIA. Reports are provided for each of the secondary environmental licences.

Aura provided examples of ICMA's submitted to the environmental authorities. These reports describe how the Mine is meeting the requirements of the Environmental Management Program, and summarize the environmental mitigation measures implemented, providing the key environmental activities completed during the reported period. The report indicates which government organizations conducted site visits and inspections, and the number of non-conformances identified.

20.3 Social or Community Requirements

20.3.1 Social Setting

The San Andrés Mine is located in the highlands of western Honduras 18 km west of the town of Santa Rosa de Copán, the capital of the Department of Copán.

The area of influence (AOI) or surrounding communities that may interact with the Mine and its facilities include Azacualpa, San Andrés, San Miguel, Platanares, Ceibita, and El Equin located within or near the mining concession. These communities constitute individual “aldeas” and form part of a larger tract of land called “ejido”, or public land, and are part of La Union Municipality.

The direct AOI is composed of approximately 949 families residing in Azacualpa (542 families), San Andrés (342 families), and San Miguel (65 families). These communities are the closest to the mine and its components and are the key focus for Minosa's engagement efforts (Aura 2024b).



Minosa engagement activities focus on providing these communities benefits through employment, local procurement, and social investment programs. These communities are mainly agricultural communities dedicated to coffee planting. Income is mainly from farming and mine-related activities (i.e., temporary and permanent employment and local procurement).

The main stakeholders are composed of communities or ejidos within the AOI, the Municipality of La Union (Copan), local and state authorities, contractors, suppliers, chambers of commerce, industry organizations, foundations (i.e., Fundacion San Andrés), media and non-governmental organizations, unions and employees.

A municipal cemetery used by the communities was located adjacent to the existing pit. Due to geotechnical stability concerns and the strategic position of the cemetery for the Mine, an agreement with the communities in 2012 allowed for the relocation of this cemetery. Minosa signed agreements with communities to relocate the cemetery in 2015. Few families opposed the relocation of their ancestors' remains, which concluded with a Judicial Resolution ordering Minosa to complete the relocation. Minosa compensated all the affected families and fulfilled all the obligations per the agreements signed, and the relocation of the cemetery was completed in 2021.

20.3.2 Communities and Infrastructure

Access to the Mine is via paved and gravel roads approximately 210 km from San Pedro Sula or 360 km from Tegucigalpa. International airports with daily flights from North America, Europe, and Latin American countries service both cities.

The Mine is located approximately 18 km west of Santa Rosa de Copán, the capital of the Department of Copán. The town site and property of San Andrés is accessible via a 28 km paved highway from Santa Rosa de Copán, and then by a 22 km gravel road from the town of Cucuyagua. The gravel road is public, but Minosa has helped local authorities maintain this road.

Labour is sourced locally from the surrounding communities. Educational, medical, recreational, and shopping facilities are available in the Mine area. Management and specialized staff are sourced locally or internationally as required and available.

The Mine has a well-developed infrastructure, which includes power and water supply, warehouses, maintenance facilities, testing laboratory, and on-site camp facilities for management, staff, and contractors. On-site communication includes radio, telephone, internet, and satellite television services (Aura 2014).

20.3.3 Social Impacts and Risks

According to Aura Minerals Sustainability Report from 2023, community relations are key in the company's strategy and vital for the success of its operations.

The Mine has signed collaboration agreements with the direct AOI's communities. It executed agreements with Azacualpa (2012), San Andrés (2012), and San Miguel (2021). These collaboration agreements seek to provide financial support to direct AOI communities through social investments in areas related to education, health, housing, and employment.

Minosa engages communities through their elected representatives, the Patronatos. Minosa has engaged the Patronatos since 2012 to identify communities' needs and priorities (Aura 2024b), and currently, they meet monthly.



As indicated above, community investment initiatives started with the signing of the collaboration agreements with the direct AOI's communities and included the construction of new houses and road maintenance and improvements, among others. In 2023, Minosa invested approximately \$1.3 million in local community investment initiatives related to local services and infrastructure.

In 2024, Minosa expanded its community development initiatives by implementing health and social projects to benefit the AOI's communities. These initiatives are carried out by the San Andrés Foundation, a social arm created by Minosa in 2022 to fund community investment initiatives and promote local development in the Mine's AOI (Aura 2022). In addition to the community investment initiatives, Minosa strives to maximize local benefits through local employment and procurement with the AOI's communities. The company hires a local workforce to fill vacancies and retains services from contractors that employ the local workforce. In 2023, 90% of the employees were from the local communities, and approximately 466 temporary positions have been created annually.

Managing high expectations from surrounding communities is one of the key social risks for Minosa. Communities have expressed concerns about pollution, noise, changes in land use, biodiversity loss and social conflicts, including blockades (Aura 2023a). SLR understands that to manage these risks in Honduras, Aura has established dialogue tables with representatives from the central government, municipalities, local government, local companies, and Minosa to discuss topics related to the management of environmental impacts. Minosa also meets biweekly with the representatives of the AOI's communities to monitor Mine-related effects and commitment implementation (Aura 2022).

Minosa has a grievance procedure for the communities to provide feedback or file concerns regarding the mine operations. In effect since 2023, it establishes that grievances must be resolved within 60 days of filing.

To minimize the risk related to some houses located in close proximity to the HLP, Minosa proceeded to obtain this land. In return, Minosa donated land for the exclusive use of San Miguel community.

Aura achieved the Socially Responsible Company Seal from the Honduran Foundation for Corporate Social Responsibility (FUNDAHRSE), awarded to companies that achieve a minimum score of 80% in the analysis of seven ESG topics (i.e., governance, human rights, labour practices, fair operational practices, environment, consumer-related issues, and active community participation). Aura reached 94% in its first year of evaluation.

SLR understands that no Indigenous Peoples are identified within the AOI of Minosa (Aura 2023). An external study undertaken by the *Instituto Hondureño de Antropología e Historia* (IHAH) found that the population of the three communities of the direct AOI does not self-identify or affiliate or is related with any Indigenous Peoples (Aura 2024b).

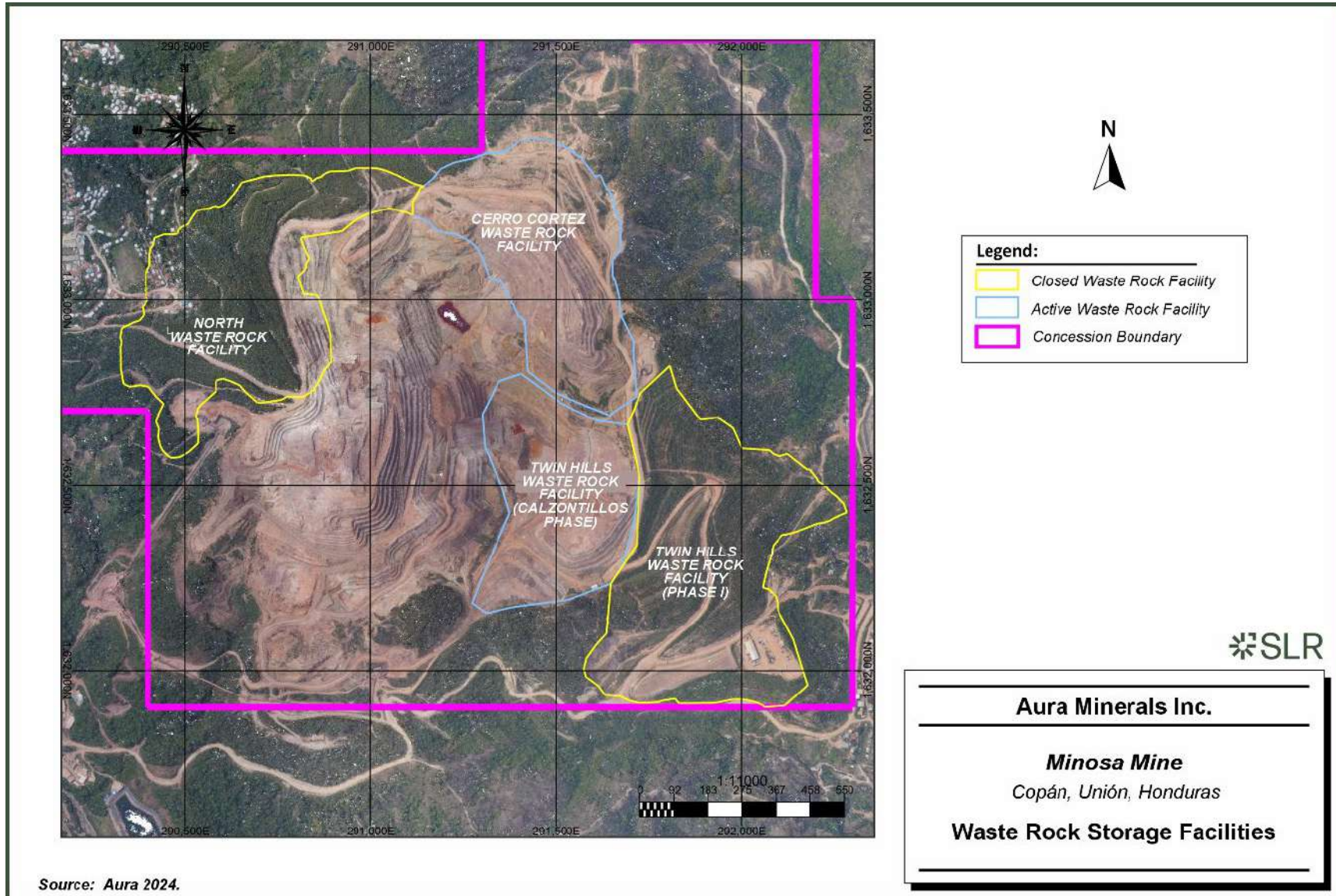
20.4 Waste Disposal, Site Monitoring and Water Management

20.4.1 Waste Rock Storage Facilities

The Project has several Waste Rock Storage Facilities. Some of them have been rehabilitated or already partially rehabilitated (North, and Twin Hills Phase I). Currently, waste rock material is used for backfilling at Twin Hills pit or it is deposited in the Twin Hills (Calzontillos Phase) WRSF/Cerro Cortes WRSF (Figure 20-2). The WRSFs do not show significant movements (TerrasarX radar), there are no relevant observations related to topographic monitoring (prisms), and the inclinometers were reported as damaged (Aura 2024a).



Figure 20-2: Waste Rock Storage Facilities



20.4.2 Site Monitoring

The Mine completes site monitoring regularly. As part of the monitoring, water quality (Section 20.4.3), air quality monitoring, noise monitoring, and terrestrial ecology monitoring are completed. The results are reported as part of the ICMAAs.

20.4.3 Water Management

Water management at the Mine includes the water management system of the HLP for industrial water (Section 18.1) and treatment of domestic wastewater.

Water management for the HLP is carried out following operational procedures POP-01-01-3.5-026 for reutilization and discharge of treated industrial wastewater, and PO-MI-G&A-MA-029-ES for effluent control, both developed by Minosa. Water quality evaluation is conducted based on the Technical Norms for Water Discharge to Receiving Waterbodies from the government of Honduras (Agreement No. 058 from April 9, 1996). Excess water collected in the HLP water management system is conveyed to a water treatment plant before being released to the environment downstream of the confluence between the Lara River and the Casas Viejas Creek. The water treatment plant is designed to neutralize cyanide, mercury, arsenic, selenium, sulphates, and cobalt.

Minosa has undertaken a review of the water management system for the HLP, mostly focused on the capacity of the six ponds. An external consultant was retained to carry out a desktop review of pond design and capacity, which is in the process of being completed. The first draft version of this report was issued recently, in November 2024 (SRK 2024). Opportunities for improvement of the water management systems were identified by the consultant. The main findings and recommendations are as follows:

- The current strategy of pond operation allows for water levels that reduce the freeboard established in the pond design criteria. It is recommended that operational practices be amended to always maintain the design freeboard.
- The current system has insufficient capacity to store the runoff resulting from the 1 in 100 years, 24-hour duration rainfall storm event. Providing storage capacity for this rainfall event is recommended to reduce the risk of discharge of untreated excess water to the environment. The minimum pond volume recommended to replace Pond 5 is 400,000 m³.
- Given that approximately 20% to 30% of the HLP surface area cannot be expanded, it is recommended that progressive closure of that area be initiated to reduce the volume of excess water to be treated and discharged.
- Implementation of other measures to reduce the volume of water to be managed is recommended, such as installation of raincoats in certain areas of the HLP and mechanical water evaporation.

SLR understands that this report is ongoing, and the final conclusions, and associated action plan are still to be determined. A hydrologic assessment conducted by an external consultant in 2020 (Aquagea Consultores 2020) proposed the development and implementation of a water management plan for integrated management of surface runoff. Recommendations of the assessment included implementation of water management infrastructure (channels and culverts), measures to improve erosion control, and actions to improve monitoring of weather parameters and streamflow. Based on the review completed, Aura has established an ongoing



action plan, and constructed to date 10,500 m of channels, 30 culverts, and a lining of 3,300 m of channels.

Surface water quality and groundwater quality monitoring is undertaken following operating procedure PO-MI-G&A-MA-001-ES developed by Minosa. According to this procedure, there are 18 surface water quality monitoring locations at sedimentation ponds, natural watercourses (Calzontillos Creek, Murciélagos Creek, San Andrés Creek, Casas Viejas Creek, and Lara River) and points established for monitoring of acid rock drainage. The procedure lists a total of 33 groundwater quality monitoring locations encompassing piezometers and French drains outlets from WRSFs. Groundwater monitoring is also conducted at wells of the leakage detection system of the HLPs. Monthly monitoring is conducted at all locations. Weekly monitoring is conducted at selected locations identified in the water quality monitoring procedure.

In addition, monitoring is conducted at eight surface water quality locations associated with the discharge of treated industrial wastewater. There is no specific frequency defined for these locations. It occurs occasionally, dictated by discharge events of excess water to the environment.

Water quality analysis results for 2023 and 2024 prepared by ALS Canada laboratory were included in the information provided by Aura for this review. However, SLR did not find evidence of records kept by Minosa comparing measured concentrations against applicable maximum permissible limits nor historical records to evaluate potential changes and trends. According to ICMA reports prepared by Aura, exceedances have been identified from time to time through the water quality monitoring program. SLR is not aware of any non-compliance expressed by the environmental authorities regarding water quality.

The SLR QP recommends developing electronic spreadsheets to tabulate, compile, process, and document water quality data results, and track compliance with the applicable regulations. The analysis will allow Minosa to make use of the existing water quality database to identify and manage any issues as they arise implementing timely corrective actions.

20.5 Mine Closure Requirements

In Honduras, there is an Executive Agreement 011 of 2017, which approves the regulation related to mine closure. This Agreement establishes the need for proponents to complete a Closure Plan. The Agreement also establishes the need to submit the Exploitation Closure Plan for INHGEOMIN approval.

20.5.1 Mine Closure Plan (MCP)

Aura has a 2024 Closure Plan (the MCP), compiled by *Consultoría e Ingeniería Félix* (CIFE), that was submitted to the regulator but has not yet been approved. Progressive closure is incorporated into the mine plan, with two years of active closure after mining and processing cessation and three years of post-closure monitoring planned. Closure objectives include (CIFE 2024):

- Long-term physical stability.
- Long-term chemical stability.
- Rehabilitation of areas affected by mining activities.
- Allowing an alternative use of areas or facilities.



- Determination of the conditions of the possible future use of these areas or facilities.

The MCP does not provide a detailed description of closure activities and post-closure monitoring.

As previously mentioned, Aura has an operational procedure regarding closure planning which was last reviewed in May 2024. It includes requirements to conduct a risk assessment in the areas of progressive closure, temporary closure, final closure, post-closure, and control measures and to ensure that current mining operations and planned operations integrate closure in the short-, medium-, and long-term planning. The procedure requires that the Closure Plan be updated three years after initial approval and every five years thereafter.

20.5.2 Closure Cost Estimate

CIFE compiled a closure cost estimate in 2024. The Executive Summary states that it includes direct and indirect costs for physical closure and the treatment, monitoring and maintenance of water, as established by the regulatory authorities and by the Mine Closure Regulations. The amount was calculated to be \$31,371,695. The SLR QP makes no conclusions as to the adequacy of the closure cost estimate.

There are currently requirements under Honduras legislation for closure financial provisions (General Mining Law, Section 30, and Closure Planning Regulation, section 44-45). However, it is SLR's understanding that the closure financial provision has to be established once the closure plan is approved, which has not happened.

20.6 Qualified Person's Opinion

In the SLR QP's opinion, the environmental and social risks at Minosa are manageable, and Aura has in place plans and systems to manage these risks.

The SLR QP notes that management systems for the environmental and social aspects of the Project are evolving and recommends that these systems be further formalized and implemented to incorporate a full "Plan-Do-Check-Act" cycle common to international management system standards.

The SLR QP notes that Aura understands that the environmental permit (issued for the 355 ha polygon) is considered to be the overall lifetime environmental licence for the site, which is aligned with the original mining concession for San Andres I area issued by INHGEOMIN. The 355 ha covers both the secondary environmental licence polygons and the Buffa Zone. Furthermore, Aura's legal counsel indicates that there is a positive administrative silence for environmental matters in Honduras. This means that even if the environmental authority does not approve/deny the request for the renewal of an environmental permit, the permit(s) have been granted.

The SLR QP recommends that the Company continue active community engagement to address any concerns that arise due to the close proximity of the Mine to the adjacent communities.



21.0 Capital and Operating Costs

This section provides an overview of the capital and operating cost estimates associated with the ongoing operations of the San Andrés Mine. Unlike a Preliminary Feasibility Study (PFS) or Feasibility Study (FS), this report reflects an established and active mining operation. As such, the cost estimates are based on actual operational data and recent budgetary forecasts rather than conceptual or pre-construction projections.

The estimates presented in this section include:

- **Capital Costs (Section 18.1):** The costs associated with sustaining capital, equipment replacements, and any planned expansions required to maintain or improve current operations.
- **Operating Costs (Section 18.2):** The costs incurred during regular mining and processing activities, including labor, equipment, power, and consumables.

The information provided is derived from the latest operating budgets, historical cost records, and current market conditions. The QP responsible for this section has assessed the accuracy of the estimates and considered relevant risks and contingencies.

Accuracy levels and contingency budgets are specified for each category in accordance with established industry standards and are consistent with actual cost performance in prior operating periods. This approach ensures that the estimates reflect realistic financial and operational expectations for the San Andrés Mine.

21.1 Capital Costs

The capital cost estimates for the San Andrés Mine encompass expenditures necessary to sustain ongoing operations and development expenditures aimed at expanding operational capacity or improving efficiencies. However, for the purposes of the cash flow analysis presented in this report, only sustaining capital investments required to maintain production of the reported Mineral Reserves were considered. Development capital, which is part of Minosa's efforts to unlock additional reserves and increase processing capacity, was excluded from the financial evaluation.

The following table summarizes the capital costs forecasted for the Life of Mine (LOM) period from 2025 to 2029, expressed in US dollars:

Table 21-1: Capital Costs 2025 to 2029

Year	Sustaining Capital (US\$)	Development Capital (US\$)	Total Capital (US\$)
2025	2,719,060	8,689,001	11,408,061
2026	2,569,060	4,446,127	7,015,187
2027	1,409,060	1,900,740	3,309,800
2028	466,667	289,064	705,731
2029	100,000	-	-
Total	7,263,847	15,324,932	22,588,779



Sustaining capital accounts for approximately 31.7% of the total capital costs, while development capital represents 68.3%.

Key Capital Projects are listed:

- Mine Development:
 - Ongoing mine development initiatives to ensure continued access to ore zones, with a total development capital allocation of \$15,324,932 over the LOM.
- Process Plant Improvements:
 - Completion of Phase VI, Stage II expansion (\$1,500,000 over 2025 and 2026).
 - Construction of new containment systems and infrastructure improvements, including sedimentation and acid wash systems (\$800,000 in 2025).
 - Upgrades to heat exchangers and ADR facilities (\$666,667 over 2025–2028).
- Maintenance Investments:
 - Alternate energy line installations and compressor repairs, totalling \$1,000,000 over the LOM.
 - Equipment replacement and refurbishment projects, including sustaining maintenance investments of \$3,209,060.
- Community and Safety, Social, and Environmental Management (*Seguridad, Social y Medio Ambiente*; SSMA) Commitments:
 - Significant investments in community projects, totalling \$5,174,932 over the LOM. This includes infrastructure and social initiatives such as the Nueva Azacualpa program and local school improvements.
 - Environmental management projects, including laboratory upgrades and meteorological monitoring station, totalling \$150,000 over the first three years.

The capital cost estimates have been classified according to the American Association of Cost Engineers (AACE) standards and represent Class 2 estimates with an expected accuracy of $\pm 25\%$. These estimates are derived from a combination of historical cost data, current market conditions, and budget forecasts provided by Minosa.

Contingencies have been included in alignment with industry standards to account for unforeseen cost variations. Sustaining capital expenditures include contingencies of up to 15%, while development capital expenditures incorporate a maximum of 10%, reflecting the advanced nature of these projects within an active operation.

21.2 Operating Costs

The operating costs for the San Andrés Mine are derived from historical operational data and budgetary forecasts prepared during 2024. These costs encompass mining, processing, and general and administrative (G&A) expenses, which are expressed in both unitary terms (cost per tonne) and total cost per annum. The following subsections detail the breakdown of these costs.



Table 21-2: Unit Operating Costs

Cost Component	Unit Cost (US\$/t moved)	Unit Cost (US\$/t processed)
Mining (Open Pit)	2.44	3.67
Processing		6.27
G&A		1.88
Total		11.82

Table 21-3: Annual Operating Costs

Year	Mining (US\$ 000)	Processing (US\$ 000)	G&A (US\$ 000)	Total Operating Cost (US\$ 000)
2025	23,966	47,886	14,358	86,211
2026	22,120	45,647	13,687	81,453
2027	26,086	45,869	13,753	85,709
2028	31,511	42,475	12,736	86,722
2029	8,539	10,331	3,098	21,968
Total	112,223	192,208	57,632	362,063

Note: numbers may not add up due to rounding

Mining costs represent a significant portion of the overall operating expenses, with a unit cost of US\$2.44 per tonne moved. Key activities include drilling, blasting, loading, and hauling, which are reflected an average cost breakdown:

- Drilling: \$1.25 million.
- Blasting: \$6.36 million.
- Loading and hauling: \$20.41 million.
- Geology, technical services, and geotechnical support contribute an additional \$2.0 million.

Processing operations are the largest cost component, averaging US\$6.27 per tonne processed. The breakdown average processing costs includes:

- Crushing (primary and secondary): \$2.69 million.
- Agglomeration and stacking: \$8.7 million.
- Leaching and ADR operations: \$20.18 million.
- Refining, metallurgical testing, and laboratory services: \$6.52 million.

Maintenance costs account for approximately \$10.02 million in average, covering:

- Regular equipment maintenance: \$3.57 million.
- Process plant-specific maintenance: \$6.13 million.

G&A costs include administrative salaries, logistics, community relations, and environmental and safety management. The average breakdown includes:



- Administration and IT: \$4.68 million.
- Human resources and legal services: \$3.22 million.
- Safety, health, and environmental management: \$2.15 million.
- Corporate and community relations: \$1.96 million.

The operating cost estimates are derived from historical 2023 and 2024 performance data, adjusted for inflation and operational scaling for 2025 and beyond.

The All-In Sustaining Cost (AISC) is estimated at US\$1,493 per ounce payable.



22.0 Economic Analysis

This section is not required as Aura is a producing issuer, and the property is currently in production and there is no material expansion of current production.



23.0 Adjacent Properties

The La Fuente concession is located adjacent to the San Andrés concessions, to the south and east of the San Andrés Mine. The concession is held by Minera Energética Centro Americana (MECA) and has been under its control since 1995. Minosa entered into an exploration agreement with MECA in 2002, granting exclusive exploration rights over the area.

Regulatory challenges have affected the status of the La Fuente concession. Under Honduran mining law, concessions are required to meet a minimum production level of US\$500/ha after eight years of ownership. MECA attempted to comply with this requirement by seeking to subdivide the concession into three smaller areas; however, due to a freeze on new concession applications, the subdivision remains unresolved. As a result, exploration activities in the La Fuente concession have been halted. Should the subdivision be granted, Minosa would need to renegotiate agreements with MECA to continue exploration.

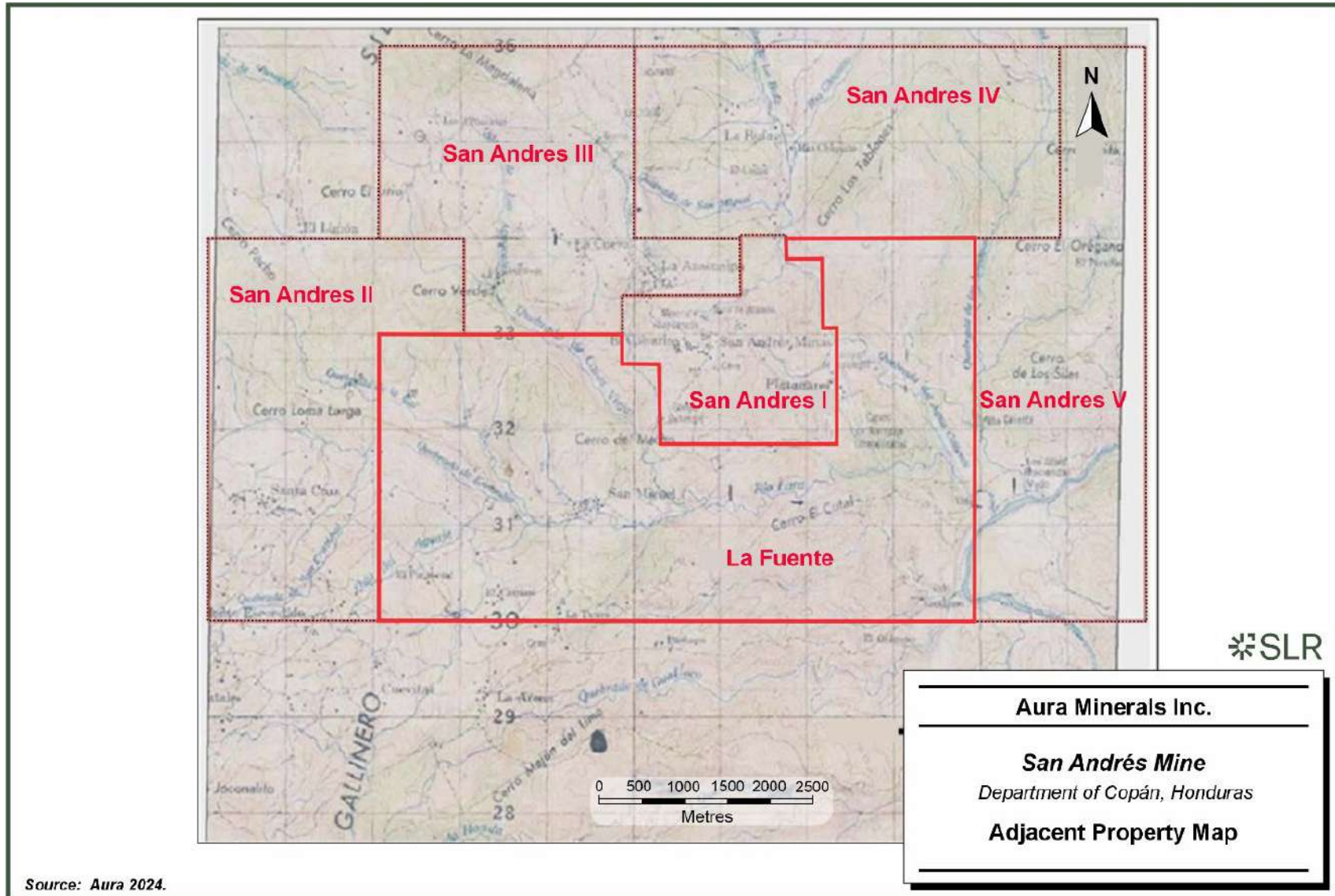
Additionally, Minosa holds exploration concessions for San Andrés III, San Andrés IV, and San Andrés X, which are contiguous to the San Andrés Mine. San Andrés III and IV were granted as exploration concessions in 2021 for a term of 10 years, while exploration activities in San Andrés X were discontinued following an internal re-evaluation.

Figure 20-1 illustrates the location of the mineral concessions, including the adjacent La Fuente concession.

The SLR QP has not independently verified this information, and its inclusion in this report is not necessarily indicative of the mineralization potential at the La Fuente property.



Figure 23-1: Adjacent Properties



Source: Aura 2024.



24.0 Other Relevant Data and Information

No additional information or explanation is necessary to make this Technical Report understandable and not misleading.



25.0 Interpretation and Conclusions

25.1 Geology and Mineral Resources

- The SLR QP has reviewed data collection, sampling, sampling preparation, quality assurance/quality control (QA/QC), data verification, modeling, grade estimation methods, and classification definitions for the San Andrés Mine has found no material issues.
- During the 2024 site visit, the SLR QP inspected the core storage facilities and confirmed they were well-maintained, appropriately managed, and in good condition.
- The geological models and gold resource estimations were completed using Leapfrog Edge.
- The Minosa Geological team updated the Mineral Resource estimate following standard industry practices. The updated estimate includes new 2023 and 2024 drilling with assays (309 drill holes with 23,721 m). The drill hole database contains 2,494 drill holes with 245,035 m.
- The Mineral Resource estimation was developed in seven areas, or domains, using ordinary kriging (OK). The SLR QP validated the block grade estimates with visual inspection of cross sections and plan views, general statistics, swath plots, and reconciliation with production data to verify that the estimation results are unbiased and found no material issues.
- Resource classification of San Andrés was defined based on drill hole spacing (DHS) criteria and proximity with recent production areas. Classification criteria are supported by variography. The SLR QP considers the classification criteria appropriate.
- Inclusive of Mineral Reserves, the San Andrés Mineral Resources are estimated to be 11.5 million tonnes (Mt) of Measured Mineral Resources at 0.38 g/t Au containing 140 thousand ounces (koz), 47.5 Mt of Indicated Mineral Resources at 0.45 g/t Au containing 681 koz, and 8.55 Mt of Inferred Mineral Resources at 0.45 g/t Au containing 123 koz, using a long term US\$2,200 gold price reported at a cut-off grade of 0.187 g/t Au for oxide material and 0.291 g/t Au for mixed material. The effective date of the Mineral Resource estimate is December 31, 2024.
- Exclusive of Mineral Reserves, the San Andrés Mineral Resources are estimated to be 1.46 million tonnes (Mt) of Measured Mineral Resources at 0.34 g/t Au containing 16 koz, 24.22 Mt of Indicated Mineral Resources at 0.40 g/t Au containing 310 koz, and 8.55 Mt of Inferred Mineral Resources at 0.45 g/t Au containing 123 koz.
- The Mineral Resource estimate does not include any sulphide material.
- The Mineral Resources have been classified in accordance with CIM (2014) definitions.
- A comparison of production blast hole (BH) data and reverse circulation (RC) data suggests a potential 15% positive bias in gold grades. However, the review confirms the reliability of blast hole samples.



25.2 Mining and Mineral Reserves

- The San Andrés Mine employs conventional open-pit mining methods with a focus on selective ore extraction and waste management.
- The remaining mine life is approximately four years, reflecting constraints due to deposit geometry and the transition to low-grade sulphides at depth.
- As of December 31, 2024, the estimated Mineral Reserves total 30.66 Mt at an average grade of 0.44 g/t Au, containing 429,187 ounces (oz) of gold.
- Reserves were estimated using the Pseudoflow optimization methodology, incorporating detailed block models.
- The CIM (2014) definitions for Mineral Reserves were followed for Mineral Reserves.
- A gold price of US\$2,000/oz was used in estimating Mineral Reserves. The calculated cut-off grades were 0.214 g/t Au for oxide material and 0.334 g/t Au for mixed material. Appropriate modifying factors were applied, including 5% dilution based on historical reconciliation data and 95% mining recovery based on operational efficiency and geotechnical considerations.
- Historical data shows consistent performance in grade control and recovery, supported by reconciliation practices.
- The Mineral Reserves are constrained by pit geometry, taking into account geotechnical parameters, property boundaries, and the proximity of the river. At depth, Mineral Reserves are limited by the transition to sulphide mineralization, which is uneconomic under current processing methods due to 0% recovery.
- The SLR QP is of the opinion that the Mineral Reserves have been estimated in accordance with CIM (2014) definitions and adhere to industry standards.

25.3 Mineral Processing

- The mined material in the ore deposit is subjected to metallurgical testing to determine what material is suitable for heap leach gold extraction, including ore characterization tests, mineralogy, fire and chemical assaying, bottle roll leach testing and column leach testing. The leach tests determine the optimum operating parameters to be used for metal extraction and recovery.
- Column leach testing was performed on samples taken from the pit during operation. Dispatch software was used to track the location from which the sample was taken during mining. The data could then be used to build a geometallurgical model.
- Two tests were performed for each sample, one at 80% passing (P_{80}) 2" and the other at the specified P_{80} to determine the effect of particle size on extraction. The results indicate that gold extraction is affected by degree of oxidation, degree of silicification and particle size. The material requires crushing. Heap leaching is applicable for the oxide and some of the mixed oxide/sulphide material. The silicified and unoxidized sulphide materials will require alternate extraction methods including fine grinding and sulphide oxidation.
- The tested samples represent various levels of oxidation and silicification. The samples with high recoveries are oxidized, and the samples with low recoveries are unoxidized, (fresh), silicified, or both. Examples include:



- Sample MT-24-0010 is a sample of Esperanza Bajo described as a quartz matrix with sulphide minerals. The material was crushed to P₈₀ 1.67 in., and the resulting heap leach gold recovery was 14.6%.
- Sample MT-24-0011 is a sample of Esperanza Bajo described as mixed ore with oxidation in the veins and containing both oxidized and unoxidized sulphide minerals, primarily pyrite. The material was crushed to P₈₀ 1.67 in., and the resulting heap leach gold recovery was 86.9%.
- Sample MT-24-0012 is a sample of Esperanza Bajo described as silicified material with sulphides. The material is crushed to P₈₀ 1.76 in., and the resulting heap leach gold recovery is 49.6%.
- Sample MT-24-0013 is a sample of Esperanza Bajo described as fragmented quartz with strong silicification plus sulphide minerals. The material was crushed to P₈₀ 1.8 in., and the resulting heap leach gold recovery was 24.1%.
- The San Andrés Mine employs heap leaching for the recovery of gold from mined material. The processing facilities include two stages of crushing and screening, drum agglomeration, heap leach pads (HLPs), an adsorption, desorption, and refining (ADR) plant for recovering the gold from solution, and gold-silver doré casting.
- The Mine produces approximately seven million tonnes per annum (Mtpa) of run-of-mine (ROM) material using conventional drilling, blasting, loading and haul truck transportation. The material is mined and transported by haul truck to either the waste rock storage facilities (WRSFs) or to the primary crushers for processing. The LOM production plan includes 7.8 Mt of material placed during 2025, 7.3 Mt in each of 2026, 2027 and 2028, and 1.6 Mt in 2029, for a total of 30.6 Mt.
- The mineralized material is directly dumped into the feed hoppers of two primary crushers operating in parallel. The primary crushed ore is conveyed to an intermediate stockpile. The ore is drawn from the stockpile with feeders and conveyed to secondary crushing. Lime and cement are added to the secondary crusher product on the conveyor feeding two drum agglomerators operating in parallel.
- Sodium cyanide solution is added to the agglomerated material on conveyor 8 following agglomeration. The agglomerated material is conveyed to the HLP where it is placed using conveyor stackers. The placed material is leached with cyanide solution for a period of 60 days. The cyanide leach solution is maintained at 400 ppm sodium cyanide (NaCN). Leach solution flows by gravity through the heaps and discharges into the Pregnant Leaching Solution (PLS) pond. PLS solution is pumped from the PLS pond to the ADR plant for gold and silver recovery.
- PLS flows through the Carbon-in-Column (CIC) adsorption system comprising activated carbon columns operating in series, organized in trains, and designed for the selective adsorption of gold and silver from the gold-bearing leach solution.
- The carbon columns are designed to process 10,000 m³/day in each train and the plant has a capacity to work with up to 6 trains, which can be exchanged between PLS and intermediate leach solution (ILS) trains, depending on the need of the operation.
- The loaded carbon is eluted with a solution of caustic soda and ethanol under controlled temperature and pressure. Gold is recovered from the rich gold eluate by electrowinning resulting in the deposition of metals, including gold, in stainless steel cathodes. The



resulting gold mud is dried in a mercury retort and then melted into gold-silver doré for sale.

- Eluted carbon is reactivated by an acid wash with hydrochloric acid and then taken to a high temperature rotary kiln prior to recycling the carbon to the carbon columns for continued adsorption of gold.

25.4 Infrastructure

- The San Andrés Mine has been in operation since 1983 and has developed the necessary infrastructure to support current and planned mining activities. Key components include power supply, water management systems, waste handling facilities, operational support buildings, and access roads.
- The Mine is connected to the Honduran national power grid, which supplies most of the site's energy needs. A diesel-powered backup generator system is maintained to ensure operational continuity during grid outages. The Platanares Geothermal Power Plant, located in La Unión, Copán, presents potential opportunities for future renewable energy integration.
- Process water is sourced from rainwater runoff collected in a surge pond and direct pumping from the Río Lara, which provides a reliable flow even during the driest months.
- Potable water is available at the site via a 72,000-gallon storage tank that is fed by a 17 km pipeline from the Río Lara. Additional purified water is sourced locally.
- WRSFs are designed with runoff control and erosion prevention measures.
- The HLP system has been expanded over time to accommodate increased processing demands. The most recent stability assessment by an independent third party was conducted in 2021. Additionally, an ongoing geotechnical study is being carried out by SRK Consulting (U.S.), Inc. (SRK) to evaluate long-term stability and potential future expansion.
- Monthly monitoring of parameters related to HLP is being done, and data reported in the September 2024 report indicate that the HLP structure is performing within design parameters (Minosa 2024a). Minosa has updated the HLP capacity estimate and determined that the currently available storage is lower than the total required for the Life of Mine (LOM). To address this, Minosa is advancing multiple expansion projects in collaboration with Kappes, Cassidy & Associates (KCA) for design and SRK for geotechnical evaluation. While the ongoing expansions are expected to provide sufficient capacity for the LOM plan, SLR has not reviewed the details of these projects and therefore does not provide an opinion on the final HLP capacity.
- Support facilities include warehouses, maintenance workshops, an assay laboratory, and administrative offices.
- On-site housing for essential personnel and contractors is available.
- The site is accessible via a combination of paved highways and gravel roads, ensuring year-round access for materials, equipment, and personnel.
- The Mine includes a helipad, primarily used for gold doré transport and available for personnel transfers or emergency medical evacuations when required.



- The Mine maintains radio, telephone, internet, and satellite television services, ensuring effective coordination across operational areas.
- The Mine's infrastructure has been progressively maintained and adapted to meet operational requirements while ensuring compliance with environmental and regulatory standards.

25.5 Environment

- Minosa has signed collaboration agreements with the communities within the direct area of interest (AOI). These collaboration agreements seek to provide financial support to direct AOI communities through social investments in areas related to education, health, housing, and employment.
- Minosa has started completing social transitioning/economic diversification, including the implementation of the Seeds of Hope Project and the partnership approach used by the San Andrés Foundation to fund initiatives as a mechanism to ensure the sustainability of these initiatives beyond the Mine's life.
- The Mine obtained the mining concession in 1983 issued by Instituto Hondureño de Geología y Minas (INHGEOMIN) for San Andrés I (355 ha). Minosa understands that a lifetime environmental permit has been granted for the site covering the same area than the mining concession (55 ha), and that permit can be used to develop the Buffa Zone. SLR understands that Minosa requested that the environmental authority confirm this approach. The outcome/response from the environmental authority is unknown. In the meantime, Aura obtained in January 2025 authorization to cut the trees in the Buffa area through Resolution DE-PS-002-2025 issued by Instituto Nacional de Conservación Forestal, ICF, which supports Aura's understanding related to the area covered by the initial environmental permit.
- Minosa submits periodic Environmental Control Measures Compliance Reports (*Informe de Cumplimiento de Medidas Ambientales*, or ICMA) to the environmental authority. The environmental authority rarely provides any comments/questions to Aura.
- Aura completed a Mine Closure Plan (MCP) and submitted it to the regulator for review and approval. The MCP has not yet been approved.

25.6 Capital and Operating Costs

- Capital Costs:
 - Capital expenditure for the San Andrés Mine primarily focuses on sustaining capital investments, including HLP expansions, equipment maintenance, and tailings management.
 - Planned expenditures for 2025 through 2028 include upgrades to processing facilities and ongoing infrastructure improvements to support operational efficiency.
 - No major greenfield or expansionary capital expenditures are expected, aligning with the remaining LOM.
- Operating Costs:
 - The Mine operates at an average total operating cost US\$11.82/t processed.
 - Key components of operating costs include:



- Mining: Diesel fuel, haulage, and explosives costs dominate mining expenses, with optimized fleet operations to reduce unit costs. The average LOM mining cost is US\$2.44/t moved.
- Processing: Costs related to heap leach operations include reagents (e.g., cyanide, lime), power consumption, and water management. The average LOM processing costs is US\$6.27/t processed.
- General and Administrative (G&A): Expenses include labor, security, and community engagement programs. The average LOM G&A cost is US\$1.88/t processed.
- Cost Control Initiatives:
 - The transition to national grid power in year 2015 has reduced energy costs by approximately 31%, providing significant savings in operational expenses.
 - Optimization of consumables (e.g., explosives and reagents) through long-term supplier contracts ensures cost stability.
 - Continuous monitoring of mine-to-mill performance helps identify inefficiencies and implement corrective measures.
- Total site costs average US\$1,360 per ounce gold produced, covering mining, processing, general and administrative (G&A) expenses, and sales costs.
 - Sustaining capital expenditures add US\$134 per ounce, which is consistent with industry benchmarks for mature operations.
- The All-In Sustaining Cost (AISC) is estimated at US\$1,493 per ounce payable.



26.0 Recommendations

The SLR QPs offer the following recommendations by area:

26.1 Geology and Mineral Resources

- 1 Complete further exploration testing of oxide and mixed (i.e., mixed oxide/sulphide material) mineralization.
- 2 Continue the geological characterization for the different material types (i.e., oxide, mixed, and sulphide) and incorporate those characterizations in the geological interpretation.
- 3 Maintain cyanide-soluble gold assays for blast hole sampling and plant metallurgical control, incorporating results into the resource model.
- 4 Investigate process options for sulphide material to assess its potential inclusion in Mineral Resources.
- 5 Advance drilling in the Buffa Zone to delimit the lateral and vertical extension.
- 6 Continue the RC infill drilling to better evaluate gold grade representativity.
- 7 Conduct detailed sampling and reconciliation studies to assess the potential 15% positive bias in BH data relative to RC data.
- 8 Prioritize exploration in the San Andrés III and IV concessions, leveraging newly granted exploration rights to identify economically viable material.

26.2 Mining and Mineral Reserves

- 1 Conduct periodic updates to the Pseudoflow optimization models to account for changing economic parameters, including gold price fluctuations and operating costs.
- 2 Refine cut-off grade calculations to ensure Mineral Reserve estimates remain aligned with the most current cost and recovery data.
- 3 Implement advanced grade control measures, such as additional real-time sampling or enhanced ore-waste boundary delineation, to minimize dilution beyond the current 5%.
- 4 Maintain or improve mining recovery rates by continuing to focus on operational efficiencies, such as precise excavation techniques and equipment optimization.
- 5 Conduct ongoing geotechnical monitoring to evaluate pit wall stability, particularly as mining progresses into deeper areas with steeper slopes.
- 6 Conduct additional geotechnical studies to evaluate opportunities to steepen pit slope angles to potentially include additional Mineral Reserves.
- 7 Evaluate the potential for near-pit exploration drilling to convert Resources into Reserves and extend the mine life.
- 8 Continue enhancing reconciliation processes to validate Mineral Reserve and Mineral Resource estimates against actual production data.
- 9 Develop predictive models to identify deviations between planned and actual performance, ensuring future Mineral Reserve estimates are accurate and reliable.



- 10 Integrate environmental and community considerations into Mineral Reserve planning to align with Aura's broader sustainability goals.

26.3 Mineral Processing

- 1 Continue column leach testing of ore samples during mining to build the geometallurgy database. The samples should be selected to represent the various zones and lithologies, degrees of oxidation, and degrees of silicification within the zones, as gold recovery is highly dependent on material characteristics.

26.4 Infrastructure

The infrastructure at the Mine is adequate for current and planned mining activities, however, the following recommendations are made regarding the HLP:

- 1 Review and validate the expansion of the HLP capacity in comparison to the options considered in the SRK 2021 analyses. A third-party validation of the remaining HLP capacity is recommended, considering the ongoing technical review by Kappes, Cassidy & Associates (KCA) and geotechnical assessment by SRK. Depending on the outcomes of these studies, assess whether additional permitting requirements may be necessary for further expansion. Based on Aura's internal review, no permitting constraints are anticipated at this time.
- 2 Update the 2021 HLP stability analysis to correspond to current and planned configurations, incorporating calibration based on monitoring data. The ongoing geotechnical assessment by SRK should be integrated into this update to ensure alignment with current operational and design parameters.

26.5 Environment

- 1 Review and update Minosa's existing environmental operational procedures.
- 2 Continue engaging with the environmental authority in regard to the discharge authorization for effluent discharge identified as Tuberia Descarga Poza 6 (TDP6). In addition, it is recommended that Minosa confirm the need for other discharge authorizations (to initiate the permitting process as required).
- 3 Continue engaging with Secretariat of Energy, Natural Resources, Environment and Mines (MIAmbiente) and other environmental agencies to obtain clarification related to the Buffa Zone, to renew the applicable permits/licences, and to obtain approval of the Closure Plan.
- 4 Review and standardize the ICMA's, highlighting the activities completed during the reported period. This will allow consistency for both Aura and the regulators and will prevent unnecessary risks to the operation.
- 5 Tabulate and process water quality information to understand water quality trends and compliance with applicable regulations. The analysis will allow Minosa to use the existing water quality database and identify and manage any issues as they arise.
- 6 As the Mine approaches its mine closure stage, continue developing and implementing the closure social transitioning activities, including communication and economic diversification. Communities in the AOI are currently highly dependent on the Mine's social investment, employment, and local contracting opportunities. The social transitioning activities require several years to plan, implement, and materialize.



- 7 Consider expanding Minosa’s engagement activities to include communities directly and through the Patronatos, Minosa’s elected representatives. More frequent exposure to communities could help avoid miscommunication and understand first-hand community issues and concerns.
- 8 Review the Mine Closure Plan to ensure that a comprehensive review and supporting information (i.e. geochemistry and hydrogeology) are carried out by a third party with relevant experience in mine closure. This will allow Aura to determine the best cost-effective alternatives for closure.

26.6 Capital and Operating Costs

1. Align sustaining capital investments with operational priorities, focusing on HLP expansion, equipment replacements, and essential infrastructure maintenance to support efficient mine closure and maximize remaining asset value.
2. Optimize operating costs through efficiency improvements in energy consumption, procurement, and contractor services, leveraging reduced power costs from the national grid and renegotiating key supply contracts.
3. Enhance cost tracking and financial planning by implementing real-time expenditure monitoring, conducting periodic cost benchmarking against peer operations, and updating sensitivity analyses for gold price scenarios to ensure economic resilience.
4. Ensure capital and operating expenditures remain proportional to the mine’s remaining life, avoiding overcapitalization while maintaining operational reliability and long-term value.



27.0 References

- Aguaquea Consultores, 2020. Integral Management of Surface and Sub-surface Runoff in San Andres Mine, Copan, Honduras. November 27, 2020.
- Aguilar Castillo Love. 2024. Dictamen Legal. Legal Opinion related to Environmental licensing. January 19, 2024
- Aura (Aura Minerals Inc.), 2012. NI 43-101 Technical Report on the San Andrés Mine, Copán, Honduras. Effective Date: December 31, 2011. Dated March 28, 2012.
- Aura. 2014. NI-43-101 Technical Report, Mineral Resource and Mineral Reserve Estimates on the San Andrés Mine in the Municipality of La Unión, in the Department of Copán, Honduras. Effective Date December 31, 2013. Dated July 2, 2014
- Aura. 2022. Planificación Estratégica de la Fundación San Andrés
- Aura. 2023a. Sustainability Report 2023. Available at <https://www.auraminerals.com/relatorio-sustentabilidade-2023/>. Accessed January 16, 2025.
- Aura. 2023b. Mitigation Measures Report 2023, San Andrés, La Union Copan 2023.
- Aura. 2023c. Executive Report Environmental Management Program 2023.
- Aura. 2024a. Management's Discussion and Analysis. PowerPoint Presentation, Q1 2024
- Aura. 2024b. Social Management. PowerPoint Presentation. 2024
- Aura. 2024c. Annual Information Form (Revised), For the year ended December 31, 2023. Dated as of April 1, 2024. Refiled on SEDAR May 2, 2024.
- CAM (Chlumsky, Armbrust and Meyer, LLC). 2005. Technical Report, San Andrés Project, Honduras. NI43-101 Technical Report prepared by Armbrust, G.A., Sandefur, R.L. and Meyer, K.L. for RNC Gold, Inc., dated October 21, 2005.
- CIFE (Consultoria e Ingeniera Felix). 2024. Closure Plan - San Andrés Mine Project. September 2024.
- CIM. 2014. Canadian Institute of Mining, Metallurgy and Petroleum (CIM) Definition Standards for Mineral Resources and Mineral Reserves, adopted by the CIM Council on May 10, 2014.
- CIM. 2019. CIM Estimation of Mineral Resources & Mineral Reserves Best Practice Guidelines, adopted by the CIM Council on November 29, 2019.
- Corbett, G. 2002. Epithermal Gold for Explorationists, AIG Journal, Paper 2002-01. April 2002.
- Gordon, M. B. 1997, Strike-slip faulting and basin formation at the Guayape fault – Valle de Catacamas intersection, Honduras, Central America. Honduras Geology, November 1997.
- Malouf, S.E., 1985: Summary Report on Compañía Minosa de Copán SA de CV, Honduras, S.E. Malouf Consulting Geologists Ltd., In-House Private Report.
- Minosa 2023. San Andrés Water Management Plan, 2023. Internal report on hydrogeological and dewatering strategies.
- Minosa, 2024a. Monthly Report. Geomechanical Monitoring. September 2024. October 7, 2024.
- Minosa. 2024b. Excel Spreadsheet 'Plan_apilamiento_Pad_LOM.xlsx



- NFC. 2020. Proyecto Mina de San Andrés. Informe Plan de Cierre, October 2020.
- Pflaker, G., 1976, Tectonic aspects of the Guatemalan earthquakes of 4 February 1976: Science, v. 193, pp. 1201-1208.
- Rojas-Agramonte, Y., Neubauer, F., Handler, R., Garcia-Delgado, D. E., Friedl, G. and Delgado-Damas, R., 2003. Neogene-Quaternary tectonics along the North Caribbean transform faults, Cuba. EGS – EUG joint Assemble, Abstracts from the meeting held in Nice, France, April 2003.
- GEOLOGICAL JOURNAL Geol. J. 44: 167–190, 2009, Deformation history of the eclogite- and jadeitite-bearing mélanges from North Motagua Fault Zone, Guatemala: insights in the processes of a fossil subduction channel,
- Scott Wilson RPA. 2007. Technical Report on the San Andrés Gold Project, Honduras – Prepared for Yamana Gold Inc. by Scott Wilson Roscoe Postle Associates. January 2007.
- SRK (SRK Consulting (U.S), Inc.). 2008. Greenstone Minera de Honduras S.A. Environmental Impact Assessment. Volume I and II. April 1998.
- SRK (SRK Consulting (U.S), Inc.). 2021. San Andrés Open Pit and Heap Leach Pad Slope Stability Assessment. 136400.050, June 17, 2021.
- SRK (SRK Consulting Colombia S.A.S). 2024. Ponds Design's Review – HLP San Andres. Project G2401 and G2402. Draft Technical Memorandum. Rev. A. November 19, 2024.
- Ten Brink, U. S., Coleman, D. F. and Dillon, W. P. 2002, the nature of the crust under the Cayman Trough from gravity. Marine and Petroleum Geology 19, pp 971-987.
- US Securities and Exchange Commission. 2018. Regulation S-K, Subpart 229.1300, Item 1300 Disclosure by Registrants Engaged in Mining Operations and Item 601 (b)(96) Technical Report Summary.



28.0 Date and Signature Date

This report titled “NI 43-101 Technical Report, San Andrés Mine, Department of Copán, Honduras” with an effective date of December 31, 2024 was prepared and signed by the following authors:

(Signed & Sealed) Benjamin Sanfurgo

Dated at Santiago, Chile
March 28, 2025

Benjamin Sanfurgo, ChMC (RM)

(Signed & Sealed) Eduardo Zamanillo

Dated at Toronto, ON
March 28, 2025

Eduardo Zamanillo, M.Sc., MBA, ChMC(RM)

(Signed & Sealed) Andrew P. Hampton

Dated at Lakewood, CO
March 28, 2025

Andrew P. Hampton, P.Eng.

(Signed & Sealed) Derek J. Riehm

Dated at Barcelona, Spain
March 28, 2025

Derek J. Riehm, P.Eng.



29.0 Certificate of Qualified Person

29.1 Benjamin Sanfurgo

I, Benjamin Sanfurgo, ChMC(RM), as an author of this report entitled “NI 43-101 Technical Report, San Andrés Mine, Department of Copán, Honduras” with an effective date of December 31, 2024 prepared for Aura Minerals Inc., do hereby certify that:

1. I am Managing Principal Geologist with SLR International Corporation, of Los Militares 5953 Oficina 402, Las Condes, Santiago, Chile.
2. I am a graduate of Universidad de Chile, Santiago, Chile in 1996 with a Bachelor of Science degree in Geology.
3. I am registered as a Competent Person (Persona Competente) in Geology for the Chilean Qualifier Commission for Competences in Mineral Resource and Reserve (Reg.# 068). I have worked as a geologist for over 30 years since my graduation. My relevant experience for the purpose of the Technical Report is:
 - Extensive technical experience as a multi-commodity Mineral Resource and Mineral Reserve specialist.
 - Experience resource reconciliation practices standardization. Grade control practices standardization, implementation and dig limit optimization. Overview and implementation of sampling technique and QAQC programs. Assist and support management of all required activities to efficiently replace reserves, extend and improve life of mine (LOM). Identify and prioritize resources to be converted in reserve in South America, North America and Africa.
 - Extensive due diligence, geological modelling and resource estimation, in different countries, at different scales and at remote exploration sites.
4. I have read the definition of "qualified person" set out in National Instrument 43-101 (NI 43-101) and certify that by reason of my education, affiliation with a professional association (as defined in NI 43-101) and past relevant work experience, I fulfill the requirements to be a "qualified person" for the purposes of NI 43-101.
5. I visited the San Andrés Mine from October 21 to 24, 2024.
6. I am responsible for sections 1.1.1.1, 1.1.2.1, 1.3.1 to 1.3.6, 4 to 12, 14, 23, 25.1, and 26.1, and related disclosure in section 27 of the Technical Report.
7. I am independent of the Issuer applying the test set out in Section 1.5 of NI 43-101.
8. I have had no prior involvement with the property that is the subject of the Technical Report.
9. I have read NI 43-101, and the Technical Report has been prepared in compliance with NI 43-101 and Form 43-101F1.



10. At the effective date of the Technical Report, to the best of my knowledge, information, and belief, the sections in the Technical Report for which I am responsible contain all scientific and technical information that is required to be disclosed to make the Technical Report not misleading.

Dated 28th day of March, 2025,

(Signed) *Benjamin Sanfurgo*

Benjamin Sanfurgo, ChMC(RM)



29.2 Eduardo Zamanillo

I, Eduardo Zamanillo, M.Sc., MBA, ChMC(RM), as an author of this report entitled "NI 43-101 Technical Report, San Andrés Mine, Department of Copán, Honduras" with an effective date of December 31, 2024 prepared for Aura Minerals Inc., do hereby certify that:

1. I am Principal Mining Engineer with SLR Consulting (Canada) Ltd, of Suite 501, 55 University Ave., Toronto, ON M5J 2H7.
2. I am a graduate of the Pontificia Universidad Católica de Chile with a Bachelor of Science degree in Industrial Civil Engineer/Mining Engineer in 2000, Universidad de Chile with a M.Sc. degree in Global Business in 2009, and Cranfield University, UK, with an MBA degree in 2012.
3. I am registered as a Competent Person with Comisión Minera de Chile (Reg. #0508). I have worked as a mining engineer for a total of 24 years since my graduation. My relevant experience for the purpose of the Technical Report is:
 - Over 24 years of operational and consulting experience in the mining industry, working with top-tier base metal, precious metal, iron ore, and lithium assets across North and South America, Europe, Asia, and Africa.
 - Extensive expertise in open-pit, underground, and alluvial mining operations, covering a wide range of mining methods and deposit types.
 - Proven experience in strategic mine planning, business development, project management, and operational optimization, with a strong focus on cost reduction strategies and efficiency improvements. Specialized background in assessing, valuing, and conducting due diligence on mining projects, supporting investment decisions and resource development strategies.
4. I have read the definition of "qualified person" set out in National Instrument 43-101 (NI 43-101) and certify that by reason of my education, affiliation with a professional association (as defined in NI 43-101) and past relevant work experience, I fulfill the requirements to be a "qualified person" for the purposes of NI 43-101.
5. I visited the San Andrés Mine site from October 21 to 24, 2024..
6. I am responsible for Sections 1.1, 1.1.1.2, 1.1.1.4, 1.1.1.6, 1.1.2.2, 1.1.2.4, 1.1.2.6, 1.2, 1.3.7, 1.3.8, 1.3.10, 1.3.11, 1.3.13, 2, 3, 15, 16, 18, 19, 21, 22, 24, 25.2, 25.4, 25.6, 26.2, 26.4, 26.6, and related disclosure in Section 27 of the Technical Report.
7. I am independent of the Issuer applying the test set out in Section 1.5 of NI 43-101.
8. I have had no prior involvement with the property that is the subject of the Technical Report.
9. I have read NI 43-101, and the Technical Report has been prepared in compliance with NI 43-101 and Form 43-101F1.
10. At the effective date of the Technical Report, to the best of my knowledge, information, and belief, the sections of the Technical Report for which I am responsible contain all scientific and technical information that is required to be disclosed to make the Technical Report not misleading.

Dated this 28th day of March, 2025.

(Signed & Sealed) Eduardo Zamanillo

Eduardo Zamanillo, M.Sc., MBA, ChMC(RM)



29.3 Andrew Paul Hampton

I, Andrew P. Hampton, P.Eng., as an author of this report entitled “NI 43-101 Technical Report, San Andrés Mine, Department of Copán, Honduras” with an effective date of December 31, 2024 prepared for Aura Minerals Inc., do hereby certify that:

1. I am Senior Principal Metallurgist with SLR International Corporation, of Suite 100, 1658 Cole Boulevard, Lakewood, CO, USA 80401.
2. I am a graduate of Southern Illinois University in 1979 with a Bachelor of Science degree in Geology, and a graduate of the University of Idaho in 1985, with a Master of Science degree in Metallurgical Engineering.
3. I am registered as a Professional Engineer in the Province of British Columbia, Licence No. 22046. I have worked as an extractive metallurgical engineer for a total of 40 years since my graduation. My relevant experience for the purpose of the Technical Report is:
 - Process plant engineering, operating and maintenance experience at mining and chemical operations, including the Sunshine Mine, Kellogg, Idaho, Beker Industries Corp, phosphate and DAP plants in Florida and Louisiana respectively, and the Delamar Mine in Jordan Valley Oregon.
 - Engineering and construction company experience on a wide range of related, precious metal projects and studies, requiring metallurgical testing, preliminary and detailed design, project management, and commissioning and start-up of process facilities and infrastructure. EPCM companies included Kilborn Engineering Pacific Ltd., SNC Lavalin Engineers and Constructors, Washington Group International Inc. and Outotec USA, Inc.
4. I have read the definition of "qualified person" set out in National Instrument 43-101 (NI 43-101) and certify that by reason of my education, affiliation with a professional association (as defined in NI 43-101) and past relevant work experience, I fulfill the requirements to be a "qualified person" for the purposes of NI 43-101.
5. I have not visited the San Andrés Mine.
6. I am responsible for Sections 1.1.1.3, 1.1.2.3, 1.3.9, 13, 17, 25.3, 26.3, and related disclosure in Section 27 of the Technical Report.
7. I am independent of the Issuer, applying the test set out in Section 1.5 of NI 43-101.
8. I have had no prior involvement with the property that is the subject of the Technical Report.
9. I have read NI 43-101, and the Technical Report has been prepared in compliance with NI 43-101 and Form 43-101F1.
10. At the effective date of the Technical Report, to the best of my knowledge, information, and belief, the sections in the Technical Report for which I am responsible contain all scientific and technical information that is required to be disclosed to make the Technical Report not misleading.

Dated this 28th day of March, 2025,

(Signed) Andrew P. Hampton

Andrew P. Hampton, P.Eng.



29.4 Derek J. Riehm

I, Derek J. Riehm, M.A.Sc., P.Eng., as an author of this report entitled “NI 43-101 Technical Report, San Andrés Mine, Department of Copán, Honduras” with an effective date of December 31, 2024 prepared for Aura Minerals Inc., do hereby certify that:

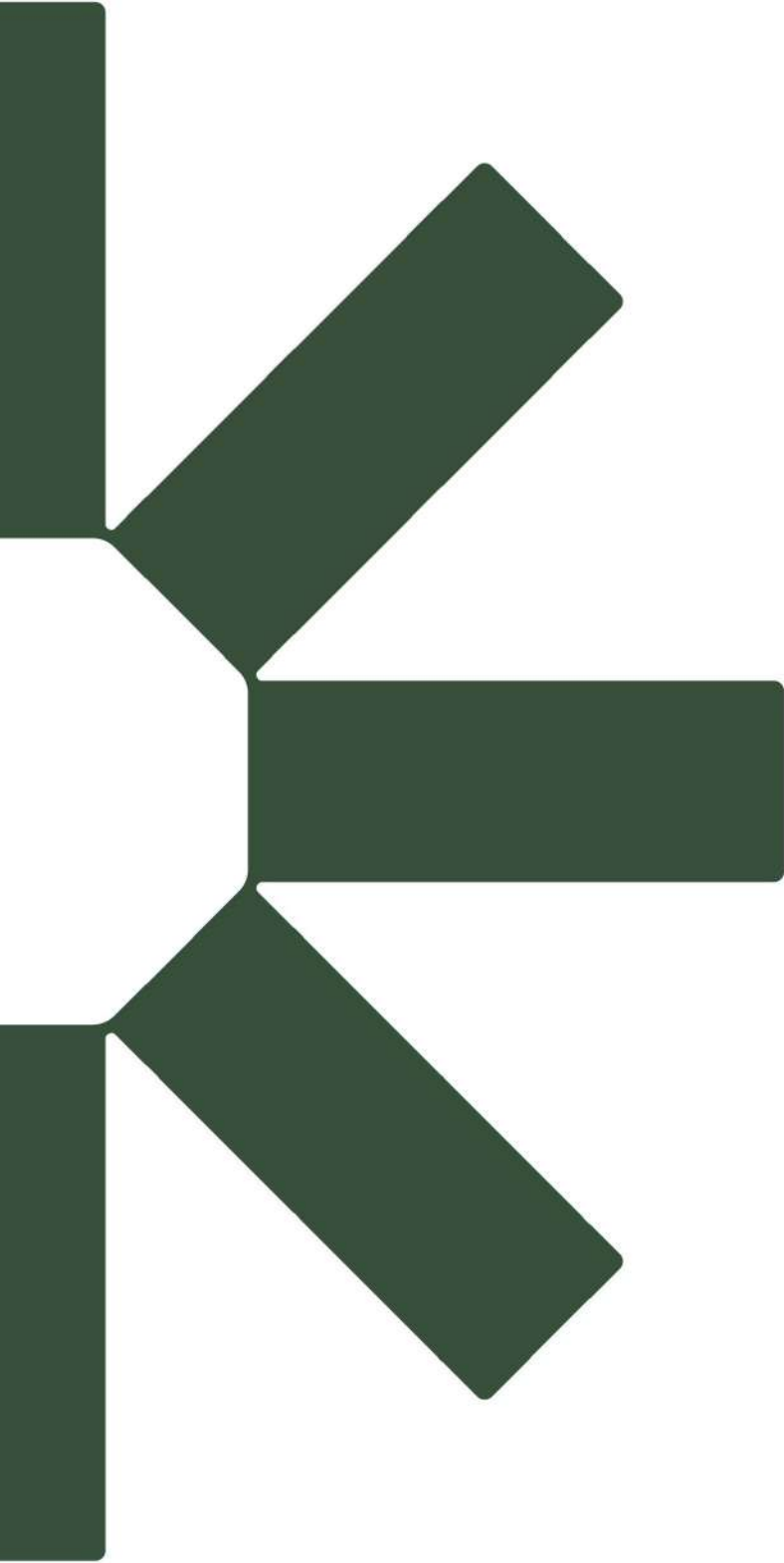
1. I am a Technical Director with Finch & Beak Spain S.L., part of SLR Consulting, of Calle del Doctor Rizal 9-11, 3-4, 08006 Barcelona, Spain.
2. I am a graduate of Queen’s University in Kingston, Ontario in 1983 with a Bachelor of Science (Honour’s, First Class) degree in Metallurgical Engineering and of the University of British Columbia in Vancouver, British Columbia, in 1990 with a Master of Science (Applied) degree in Metals and Materials Engineering.
3. I am registered as a Professional Engineer in the Province of British Columbia (Reg.# 21391). I have worked as an engineer and mining executive for 32 years since my graduation. My relevant experience for the purposes of the Technical Report is:
 - Environmental and social impact assessments, due diligence evaluations, audits, and reviews of numerous mineral exploration and mining projects around the world including preparation of relevant sections of NI 43-101 Technical Reports.
 - A senior position with an international consulting firm.
 - Performing as an environmental and social manager and executive for several Canadian mining companies.
4. I have read the definition of “qualified person” set out in National Instrument 43-101 (NI 43-101) and certify that by reason of my education, affiliation with a professional association (as defined in NI 43-101) and past relevant work experience, I fulfill the requirements to be a “qualified person” for the purposes of NI 43-101.
5. I have not visited the San Andrés Mine.
6. I am responsible for Sections 1.1.1.5, 1.1.2.5, 1.3.12, 20, 25.5, 26.5, and related disclosure in Section 27 of the Technical Report.
7. I am independent of the Issuer, applying the test set out in Section 1.5 of NI 43-101.
8. I have had no prior involvement with the property that is the subject of the Technical Report.
9. I have read NI 43-101, and the Technical Report has been prepared in compliance with NI 43-101 and Form 43-101F1.
10. At the effective date of the Technical Report, to the best of my knowledge, information, and belief, the sections of the Technical Report for which I am responsible contain all scientific and technical information that is required to be disclosed to make the Technical Report not misleading.

Dated this 28th day of March, 2025,

(Signed) Derek J. Riehm

Derek J. Riehm, M.A.Sc., P.Eng.





Making Sustainability Happen